



TEST REPORT

Test Report No. : UL-RPT-RP10655468JD02A V4.0

Manufacturer : Cambium Networks Ltd
Model No. : PMP 450i / PTP 450i
FCC ID : QWP-50450I
Test Standard(s) : FCC Part 90 Subpart Y

1. This test report shall not be reproduced in full or partial, without the written approval of UL VS LTD.
2. The results in this report apply only to the sample(s) tested.
3. The sample tested is in compliance with the above standard(s).
4. The test results in this report are traceable to the national or international standards.
5. Version 4.0 supersedes all previous versions.

Date of Issue: 18 May 2015

Checked by:

Sarah Williams
Engineer, Radio Laboratory

Issued by :

pp

John Newell
Quality Manager
UL VS LTD



This laboratory is accredited by UKAS.
The tests reported herein have been
performed in accordance with its terms
of accreditation.

UL VS LTD

Pavilion A, Ashwood Park, Ashwood Way, Basingstoke, Hampshire, RG23 8BG, UK
Telephone: +44 (0)1256 312000
Facsimile: +44 (0)1256 312001

This page has been left intentionally blank.

Table of Contents

1. Customer Information.....	4
2. Summary of Testing.....	5
2.1. General Information	5
2.2. Summary of Test Results	5
2.3. Methods and Procedures	6
2.4. Deviations from the Test Specification	6
3. Equipment Under Test (EUT)	7
3.1. Identification of Equipment Under Test (EUT)	7
3.2. Description of EUT	7
3.3. Modifications Incorporated in the EUT	7
3.4. Additional Information Related to Testing	8
3.5. Support Equipment	8
3.6. Antenna	9
4. Operation and Monitoring of the EUT during Testing	10
4.1. Operating Modes	10
4.2. Configuration and Peripherals	10
5. Measurements, Examinations and Derived Results.....	14
5.1. General Comments	14
5.2. Test Results	15
5.2.1. Conducted Output Power	15
5.2.2. Peak Power Spectral Density	20
5.2.3. Peak Excursion	47
5.2.4. Occupied Bandwidth	52
5.2.5. Conducted Emission Mask	67
5.2.6. Conducted Spurious Emissions	78
5.2.7. Radiated Spurious Emissions	82
5.2.8. Frequency Stability (Temperature Variation)	87
5.2.9. Frequency Stability (Voltage Variation)	90
6. Measurement Uncertainty	91
7. Report Revision History	92
Appendix 1. Conducted Test Setup Photograph	93

1. Customer Information











Company Name:	Cambium Networks Ltd
Address:	Unit B2/3, Linhay Business Park Eastern Road Ashburton Devon TQ13 7UP United Kingdom

2. Summary of Testing

2.1. General Information

Specification Reference:	47CFR90
Specification Title:	Code of Federal Regulations Volume 47 (Telecommunications): Part 90 Subpart Y - Regulations Governing Licensing and Use of Frequencies in the 4940-4990 MHz Band
Site Registration:	209735
Location of Testing:	UL VS LTD, Unit 3 Horizon, Wade Road, Kingsland Business Park, Basingstoke, Hampshire, RG24 8AH, United Kingdom
Test Dates:	25 February 2015 to 13 March 2015

2.2. Summary of Test Results

FCC Reference (47CFR)	Measurement	Result
2.1046, 90.205(p) & 90.1215(a)(1)	Transmitter Conducted Output Power	
90.1215(a)(2)	Conducted Peak Power Spectral Density	
90.1215(e)	Transmitter Peak Excursion	
2.1049	Transmitter Occupied Bandwidth	
90.210(m) / 2.1051	Transmitter Conducted Emissions Mask	
90.210(m) / 2.1051	Transmitter Conducted Spurious Emissions	
90.210(m)	Radiated Spurious Emissions	
90.213 / 2.1055	Transmitter Frequency Stability	
Key to Results		
 = Complied  = Did not comply		

2.3. Methods and Procedures

Reference:	ANSI/TIA-603-C-2004
Title:	Land Mobile FM or PM – Communications Equipment – Measurement and Performance Standards.
Reference:	ANSI C63.4-2009
Title:	American National Standard for Methods of Measurement of Radio-Noise Emissions from Low-Voltage Electrical and Electronic Equipment in the Range of 9 kHz to 40 GHz
Reference:	FCC KDB 971168 D01 Licensed DTS Guidance v02r02, October 17, 2014
Title:	Measurement Guidance for Certification of Licensed Digital Transmitters
Reference:	FCC KDB 662911 D02 v01, October 25 2011
Title:	MIMO with Cross-Polarized Antenna

2.4. Deviations from the Test Specification

For the measurements contained within this test report, there were no deviations from, additions to, or exclusions from the test specification identified above.

3. Equipment Under Test (EUT)

3.1. Identification of Equipment Under Test (EUT)

Brand Name:	Cambium Networks Ltd
Model Name or Number:	PMP 450i / PTP 450i
Hardware Version:	ODU: P2 (Mod) Power Injector : Rev 02 Power Over Ethernet: Rev B
Software Version:	B135-PXP455-PRODTEST-2015FEB27
Serial Number:	F50980BB0070
FCC ID:	QWP-50450I

Brand Name:	Cambium Networks Ltd
Model Name or Number:	PMP 450i / PTP 450i
Hardware Version:	ODU: P2 (Mod) Power Injector : Rev 02 Power Over Ethernet: Rev B
Software Version:	B144-PXP455-PRODTEST-2015MAR13
Serial Number:	F50980BB0070
FCC ID:	QWP-50450I

3.2. Description of EUT

The Equipment Under Test was a fixed radio transceiver operating in the 4940 MHz to 4990 MHz band. The EUT is available in two configurations:

1. Connectorised with two external antenna ports.
2. Integrated with directional and sectorised flat plate antenna options.

Power is provided by a PoE supply.

3.3. Modifications Incorporated in the EUT

The manufacturer changed the software from B135-PXP455-PRODTEST-2015FEB27 to B144-PXP455-PRODTEST-2015MAR13 on 13 March 2015.

3.4. Additional Information Related to Testing

Technology Tested:	Digital Transmission System			
Type of Unit:	Microwave fixed radio link transceiver			
Modes/Modulation:	QPSK, 16QAM, 64QAM, 256QAM			
Intended Operating Environment:	Residential, Commercial and Light Industry			
Data rates:	32.4, 64.6, 97.1 & 129.5 Mbp/s			
Power Supply Requirement(s):	Nominal	PoE supply input 120 VAC 60 Hz. PoE output 48 VDC.		
Channel Bandwidth:	5, 10 & 20 MHz			
Frequency Range:	4940 MHz to 4990 MHz			
Channels Tested:	Channel Bandwidth (MHz)	Bottom Channel Frequency (MHz)	Middle Channel Frequency (MHz)	Top Channel Frequency (MHz)
	5	4942.5	4965	4987.5
	10	4945	4965	4985
	20	4950	4965	4980

3.5. Support Equipment

The following support equipment was used to exercise the EUT during testing:

Description:	Laptop PC
Brand Name:	Lenovo
Model Name or Number:	L440
Serial Number:	Not marked or stated

Description:	Ethernet Hub
Brand Name:	Netgear
Model Name or Number:	GS605
Serial Number:	2N21223M02078

Description:	PoE Power supply
Brand Name:	LEADER ELECTRONICS INC.
Model Name or Number:	NU60-R550111-I3
Serial Number:	13000019581409000667

Description:	PoE Power supply
Brand Name:	Cambium Networks
Model Name or Number:	E100109BG
Part Number:	C000065L002B
Serial Number:	1451008904

3.6. Antenna

The table below lists the antennas that the manufacturer intends to use with this product when operating in the 4940-4990 MHz band:

Type	Stated Gain (dBi)	Manufacturer	Antenna Name	Used for Testing	Note
Dual polarised plate (Integrated)	23.0	MARS	MA-WA56-DP23	-	1, 3
Dual polarised plate (Integrated)	17.0	Cambium	5093HH	-	1, 3
Dual polarised plate (External)	28.0	MARS	MA-WA56-DP-28N	X	2
4 ft Parabolic Dual Polarised	33.7	Gabriel	Dual QuickFire QFD4-49-N	-	1
6 ft Parabolic Dual Polarised	37.2	Gabriel	QuickFire QF6-49-N	X	2
90° Sectorised (Integrated)	16.0	MARS	MA-WD56-DP16PCMW	-	1, 3
90° Sectorised (External)	17.0	Laird	ANT, AP Sector	X	2
90° Sectorised (External)	17.0	Proprietary	Part No. A005189	-	1
Omnidirectional	13.0	KP	KPPA-5.7-DPOMA	X	2

X = This antenna was used for testing purposes

Note(s):

1. This antenna has the same gain or less gain and is of the same type as the antenna that was tested. Therefore it was not tested.
2. Used in conjunction with two, 0.5 metre length RF cables having an individual insertion loss of 0.9 dB across the EUT operating band.
3. Integrated antenna. No external RF cables. The manufacturer stated where an integrated antenna is used, RF power is calibrated to the RF connector on the PCB.

4. Operation and Monitoring of the EUT during Testing

4.1. Operating Modes

The EUT was tested in the following operating mode(s):

- The unit operates in transceiver mode only as a TDD device in its normal mode of operation. There is no dedicated receive only mode.
- For test purposes only, the EUT was continuously transmitting at maximum power with 100% duty cycle in test mode on the required channels using the supported modulation types.
- A test mode CW signal was used for frequency stability tests.

4.2. Configuration and Peripherals

The EUT was tested in the following configuration(s):

- A laptop PC with Cambium Networks test application 'Regulatory RF Control V1.0' was used to configure the EUT via the PoE power supply and Ethernet cables.
- The EUT was powered throughout testing via the PoE power supply.
- The EUT was operating at maximum allowable output power for the configuration being tested unless otherwise stated.
- Radiated spurious emissions tests (case radiation) were performed with both RF ports terminated into 50 Ohm loads. The EUT was transmitting at maximum power on the middle channel. The unused Ethernet port was terminated into an Ethernet hub. The hub was not powered.

Power settings used during testing

The tables below show the EUT power settings that were used during testing when the EUT was operated with the omnidirectional antenna.

Omnidirectional Antenna

Ch. BW	QPSK			16QAM		
	Bottom Channel	Middle Channel	Top Channel	Bottom Channel	Middle Channel	Top Channel
5	24.75	24.75	24.75	24.75	24.75	24.75
10	24	24	24	24	24	24
20	23.75	23.75	23.75	23.75	23.75	23.75

Ch. BW	64QAM			256QAM		
	Bottom Channel	Middle Channel	Top Channel	Bottom Channel	Middle Channel	Top Channel
5	24.75	24.75	24.75	24.75	24.75	24.75
10	24	24	24	24	24	24
20	23.75	23.75	23.75	23.75	23.75	23.75

Power settings used during testing (continued)

The tables below show the EUT power settings that were used during testing when the EUT was operated with the sectorised and plate antennas.

Sectorised Antenna

Ch. BW	QPSK			16QAM		
	Bottom Channel	Middle Channel	Top Channel	Bottom Channel	Middle Channel	Top Channel
5	24.75	24.75	24.75	24.75	24.75	24.75
10	24	24	24	24	24	24
20	23.75	23.75	23.75	23.75	23.75	23.75

Ch. BW	64QAM			256QAM		
	Bottom Channel	Middle Channel	Top Channel	Bottom Channel	Middle Channel	Top Channel
5	24.75	24.75	24.75	24.75	24.75	24.75
10	24	24	24	24	24	24
20	23.75	23.75	23.75	23.75	23.75	23.75

Plate Antenna

Ch. BW	QPSK			16QAM		
	Bottom Channel	Middle Channel	Top Channel	Bottom Channel	Middle Channel	Top Channel
5	24.75	24.75	24.75	24.75	24.75	24.75
10	24	24	24	24	24	24
20	23.75	23.75	23.75	23.75	23.75	23.75

Ch. BW	64QAM			256QAM		
	Bottom Channel	Middle Channel	Top Channel	Bottom Channel	Middle Channel	Top Channel
5	24.75	24.75	24.75	24.75	24.75	24.75
10	24	24	24	24	24	24
20	23.75	23.75	23.75	23.75	23.75	23.75

Point-to-Point Parabolic Antenna

The tables below show the EUT power settings that were used during testing for each channel bandwidth and modulation type, when the EUT was operated as a point-to-point device with a 6' parabolic antenna.

6' Parabolic Antenna

Ch. BW	QPSK			16QAM		
	Bottom Channel	Middle Channel	Top Channel	Bottom Channel	Middle Channel	Top Channel
5	16	16	16	16	16	16
10	19.5	19.5	19.5	19.5	19.5	19.5
20	22.25	22.25	22.25	22.25	22.25	22.25

Ch. BW	64QAM			256QAM		
	Bottom Channel	Middle Channel	Top Channel	Bottom Channel	Middle Channel	Top Channel
5	16	16	16	16	16	16
10	19.5	19.5	19.5	19.5	19.5	19.5
20	22.25	22.25	22.25	22.25	22.25	22.25

5. Measurements, Examinations and Derived Results

5.1. General Comments

Measurement uncertainties are evaluated in accordance with current best practice. Our reported expanded uncertainties are based on standard uncertainties, which are multiplied by an appropriate coverage factor to provide a statistical confidence level of approximately 95%. Please refer to *Section 6. Measurement Uncertainty* for details.

In accordance with UKAS requirements all the measurement equipment is on a calibration schedule. All equipment was within the calibration period on the date of testing.

5.2. Test Results

5.2.1. Conducted Output Power

Test Summary:

Test Engineer:	Ian Watch	Test Dates:	06 March 2015 & 09 March 2015
Test Sample Serial Number:	F50980BB0070		

FCC Reference:	Parts 2.1046, 90.205(p) and 90.1215(a)(1)
Test Method Used:	FCC KDB 971168 D01 Section 5.2.1

Environmental Conditions:

Temperature (°C):	23 to 24
Relative Humidity (%):	32 to 34

Note(s):

1. The output port of the EUT was connected directly to a spectrum analyser via a 20 dB attenuator and RF cable. The attenuator and cable were calibrated prior to use and the loss incorporated into the measurement as an RF level offset.
2. Conducted power tests were performed in accordance with FCC KDB 971168 D01 Section 5.2.1. Tests were performed simultaneously with PSD measurements. Result plots for conducted power measurements can be found in the Peak Power Spectral Density section of this test report.
3. The EUT was transmitting at 100% duty cycle.
4. Pretesting confirmed that all modulation types have the same power/PSD level for each channel bandwidth. Final measurements were performed on the EUT transmitting with QPSK modulation only. Full test results are archived on the UL VS LTD IT server and are available for inspection if required.
5. An omnidirectional antenna with gain of 13 dBi is intended to be used for point-to-point and point-to-multipoint operation. No reduction in the maximum conducted power limit was required.
6. Sectorised antennas intended to be used for point-to-multipoint operation have directional gains less than 26 dBi quoted in Part 90.1215(a)(2). No reduction in the maximum conducted power limit was required.
7. Three plate antennas intended to be used for point-to-point operation have individual directional gains of 17 dBi, 23 dBi and 28 dBi. No reduction in the maximum conducted power limit was required for the antennas with gains of 17 and 23 dBi. Power reduction is required for the antenna with 28 dBi gain. Two 0.5 metre length RF cables with individual insertion loss of 0.9 dB were supplied to connect the antenna to the EUT RF ports. The plate antenna gain is 28 dBi and cable loss 0.9 dB giving a total gain of 27.1 dBi. This is 1.1 dB greater than 26 dBi allowed for point-point operation in Part 90.1215(a)(2). Therefore, the high power maximum conducted output power limits for all supported channel bandwidths were reduced accordingly. The Part 90.1215(a)(1) maximum conducted power limits for the omnidirectional antenna were recalculated as:

5 MHz channel bandwidth: $27 - 1.1 = 25.9$ dBm
10 MHz channel bandwidth: $30 - 1.1 = 28.9$ dBm
20 MHz channel bandwidth: $33 - 1.1 = 31.9$ dBm

Conducted Output Power (continued)**Note(s):**

8. Parabolic antennas with a maximum gain of 37.2 dBi are intended to be used for point-to-point operation. Two 0.5 metre length RF cables with individual insertion loss of 0.9 dB were supplied to connect the antenna to the EUT RF ports. The 6 foot antenna gain is 37.2 dBi and cable loss of 0.9 dB giving a total gain of 36.3 dBi. This is 10.3 dB greater than 26 dBi allowed for point-to-point operation in Part 90.1215(a)(2). Therefore, the high power maximum conducted output power limits for all supported channel bandwidths were reduced accordingly.

The Part 90.1215(a)(1) point-to-point maximum conducted power limits for the 6 foot parabolic antenna were recalculated as:

5 MHz channel bandwidth: $27 - 10.3 = 16.7$ dBm

10 MHz channel bandwidth: $30 - 10.3 = 19.7$ dBm

20 MHz channel bandwidth: $33 - 10.3 = 22.7$ dBm

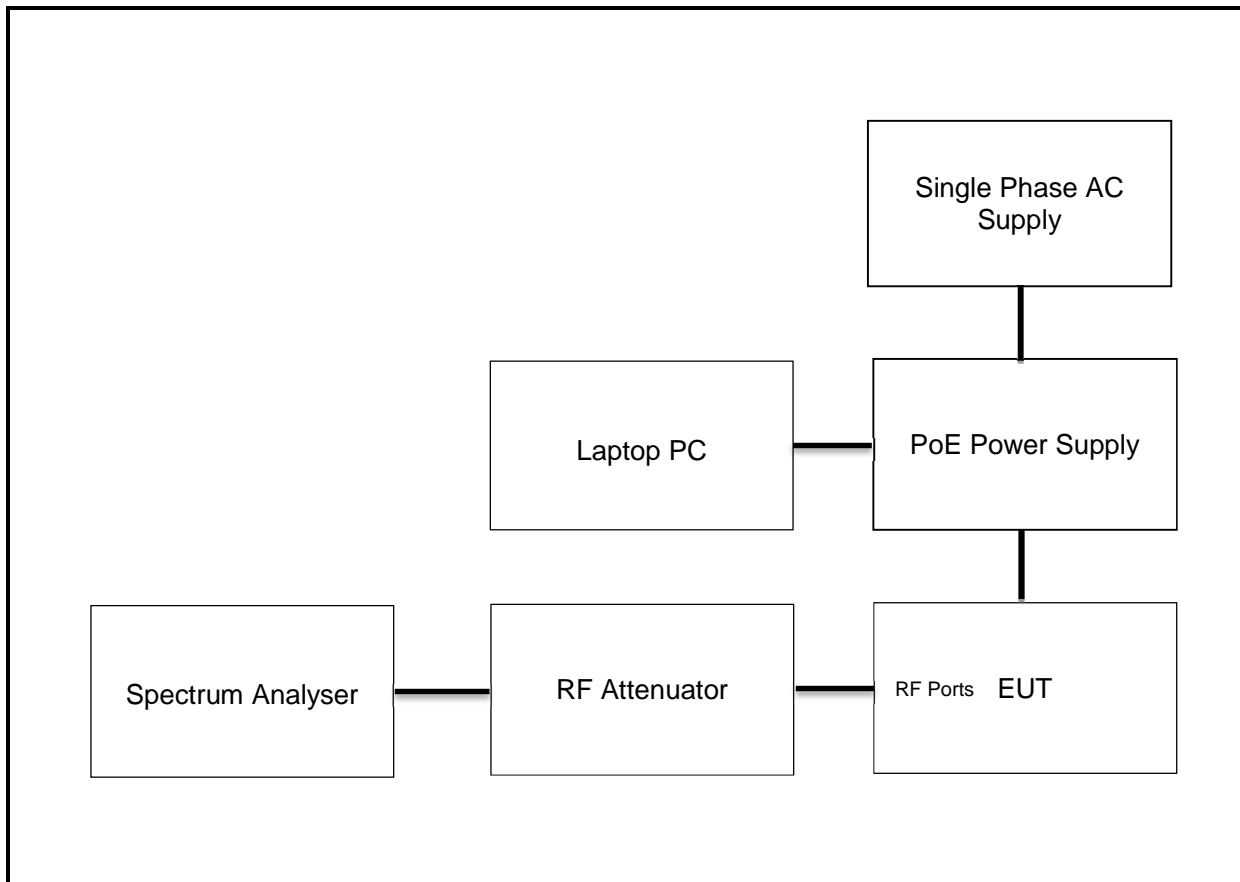
Test setup for conducted power measurements:

Conducted Output Power (continued)**Results: 5 MHz Channel / QPSK / Omnidirectional Antenna**

Channel	Conducted Power A Port (dBm)	Conducted Power B Port (dBm)	Combined Conducted Power (dBm)	Conducted Power Limit (dBm)	Margin (dB)	Result
Bottom	21.0	20.9	24.0	27.0	3.0	Complied
Middle	21.1	20.9	24.0	27.0	3.0	Complied
Top	21.1	20.9	24.0	27.0	3.0	Complied

Results: 5 MHz Channel / QPSK / Sectorised Antenna

Channel	Conducted Power A Port (dBm)	Conducted Power B Port (dBm)	Combined Conducted Power (dBm)	Conducted Power Limit (dBm)	Margin (dB)	Result
Bottom	21.0	20.9	24.0	27.0	3.0	Complied
Middle	21.1	20.9	24.0	27.0	3.0	Complied
Top	21.1	20.9	24.0	27.0	3.0	Complied

Results: 5 MHz Channel / QPSK / Plate Antenna

Channel	Conducted Power A Port (dBm)	Conducted Power B Port (dBm)	Combined Conducted Power (dBm)	Conducted Power Limit (dBm)	Margin (dB)	Result
Bottom	21.0	20.9	24.0	25.9	1.9	Complied
Middle	21.1	20.9	24.0	25.9	1.9	Complied
Top	21.1	20.9	24.0	25.9	1.9	Complied

Results: 5 MHz Channel / QPSK / 6' Parabolic Antenna

Channel	Conducted Power A Port (dBm)	Conducted Power B Port (dBm)	Combined Conducted Power (dBm)	Conducted Power Limit (dBm)	Margin (dB)	Result
Bottom	12.8	12.8	15.8	16.7	0.9	Complied
Middle	12.8	12.7	15.8	16.7	0.9	Complied
Top	13.0	12.8	15.9	16.7	0.8	Complied

Conducted Output Power (continued)**Results: 10 MHz Channel / QPSK / Omnidirectional Antenna**

Channel	Conducted Power A Port (dBm)	Conducted Power B Port (dBm)	Combined Conducted Power (dBm)	Conducted Power Limit (dBm)	Margin (dB)	Result
Bottom	20.6	20.9	23.8	30.0	6.2	Complied
Middle	20.9	21.0	24.0	30.0	6.0	Complied
Top	20.9	21.0	24.0	30.0	6.0	Complied

Results: 10 MHz Channel / QPSK / Sectorised Antenna

Channel	Conducted Power A Port (dBm)	Conducted Power B Port (dBm)	Combined Conducted Power (dBm)	Conducted Power Limit (dBm)	Margin (dB)	Result
Bottom	20.6	20.9	23.8	30.0	6.2	Complied
Middle	20.9	21.0	24.0	30.0	6.0	Complied
Top	20.9	21.0	24.0	30.0	6.0	Complied

Results: 10 MHz Channel / QPSK / Plate Antenna

Channel	Conducted Power A Port (dBm)	Conducted Power B Port (dBm)	Combined Conducted Power (dBm)	Conducted Power Limit (dBm)	Margin (dB)	Result
Bottom	20.6	20.9	23.8	28.9	5.1	Complied
Middle	20.9	21.0	24.0	28.9	4.9	Complied
Top	20.9	21.0	24.0	28.9	4.9	Complied

Results: 10 MHz Channel / QPSK / 6' Parabolic Antenna

Channel	Conducted Power A Port (dBm)	Conducted Power B Port (dBm)	Combined Conducted Power (dBm)	Conducted Power Limit (dBm)	Margin (dB)	Result
Bottom	16.3	16.0	19.2	19.7	0.5	Complied
Middle	16.2	15.9	19.1	19.7	0.6	Complied
Top	16.3	16.1	19.2	19.7	0.5	Complied

Conducted Output Power (continued)**Results: 20 MHz Channel / QPSK / Omnidirectional Antenna**

Channel	Conducted Power A Port (dBm)	Conducted Power B Port (dBm)	Combined Conducted Power (dBm)	Conducted Power Limit (dBm)	Margin (dB)	Result
Bottom	20.5	20.4	23.5	33.0	9.5	Complied
Middle	20.7	20.6	23.7	33.0	9.3	Complied
Top	20.5	20.6	23.6	33.0	9.4	Complied

Results: 20 MHz Channel / QPSK / Sectorised Antenna

Channel	Conducted Power A Port (dBm)	Conducted Power B Port (dBm)	Combined Conducted Power (dBm)	Conducted Power Limit (dBm)	Margin (dB)	Result
Bottom	20.5	20.4	23.5	33.0	9.5	Complied
Middle	20.7	20.6	23.7	33.0	9.3	Complied
Top	20.5	20.6	23.6	33.0	9.4	Complied

Results: 20 MHz Channel / QPSK / Plate Antenna

Channel	Conducted Power A Port (dBm)	Conducted Power B Port (dBm)	Combined Conducted Power (dBm)	Conducted Power Limit (dBm)	Margin (dB)	Result
Bottom	20.5	20.4	23.5	31.9	8.4	Complied
Middle	20.7	20.6	23.7	31.9	8.2	Complied
Top	20.5	20.6	23.6	31.9	8.3	Complied

Results: 20 MHz Channel / QPSK / 6' Parabolic Antenna

Channel	Conducted Power A Port (dBm)	Conducted Power B Port (dBm)	Combined Conducted Power (dBm)	Conducted Power Limit (dBm)	Margin (dB)	Result
Bottom	19.0	19.1	22.1	22.7	0.6	Complied
Middle	19.0	19.1	22.1	22.7	0.6	Complied
Top	19.1	19.3	22.2	22.7	0.5	Complied

Test Equipment Used:

Asset No.	Instrument	Manufacturer	Type No.	Serial No.	Date Calibration Due	Cal. Interval (Months)
A2526	Attenuator	AtlanTecRF	AN18W5-20	832828#2	Calibrated before use	N/A
M260	Signal Generator	Rohde & Schwarz	SMP02	829076/008	24 Apr 2015	12
M1886	Test Receiver	Rohde & Schwarz	ESU26	100554	09 May 2015	12
M1657	Thermohygrometer	JM Handelspunkt	30.5015.13	N/A	14 Mar 2015	12

5.2.2. Peak Power Spectral Density**Test Summary:**

Test Engineer:	Ian Watch	Test Dates:	06 March 2015 & 09 March 2015
Test Sample Serial Number:	F50980BB0070		

FCC Reference:	Part 90.1215(a)(2)
Test Method Used:	Part 90.1215(d) & KDB 971168 D01 Section 5.4.1 and Notes below

Environmental Conditions:

Temperature (°C):	23 to 24
Relative Humidity (%):	32 to 34

Note(s):

1. The output port of the EUT was connected directly to a spectrum analyser via a 20 dB attenuator and RF cable. The attenuator and cable were calibrated prior to use and the loss incorporated into the measurement as an RF level offset.
2. Peak power spectral density tests were performed in accordance with FCC KDB 971168 D01 Section 5.4.1.
3. The EUT was transmitting at 100% duty cycle.
4. Pretesting confirmed that all modulation types have the same power/PSD level for each channel bandwidth. Final measurements were performed on the EUT transmitting with QPSK modulation only. Full test results are archived on the UL VS LTD IT server and are available for inspection if required.
5. The test was performed as a conducted measurement on a spectrum analyser using the following settings: RBW of 1 MHz and 3 MHz VBW. The sweep time was coupled, with a span set to >1.5 the occupied bandwidth. An RMS detector and trace averaging over 100 traces were used. A marker was placed on the maximum amplitude of the plot and the marker level recorded.
6. Power from both ports was measured and combined using the measure-and-sum method stated in FCC KDB 662911 D02.
7. An omnidirectional antenna with gain of 13 dBi is intended to be used. No reduction in the peak power spectral density limit was required.
8. Sectorised antennas intended to be used for point-to-point and point-to-multipoint operation have directional gains less than 26 dBi quoted in Part 90.1215(a)(2). No reduction in the peak power spectral density limit was required.

Peak Power Spectral Density (continued)**Note(s):**

9. Three plate antennas intended to be used for point-to-point operation have individual directional gains of 17 dBi, 23 dBi and 28 dBi. No reduction in the peak power spectral density limit was required for the antennas with gains of 17 and 23 dBi. Power reduction is required for the antenna with 28 dBi gain. Two 0.5 metre length RF cables with individual insertion loss of 0.9 dB were supplied to connect the antenna to the EUT RF ports. The plate antenna gain is 28 dBi and cable loss 0.9 dB giving a total gain of 27.1 dBi. This is 1.1 dB greater than 26 dBi allowed for point-to-point operation in Part 90.1215(a)(2). Therefore, the peak power spectral density limit for all supported channel bandwidths was reduced accordingly.

The Part 90.1215(a)(1) maximum conducted power limit for the 28 dBi plate antenna was recalculated as:

$$\text{All channel bandwidths: } 21 \text{ dBm/MHz} - 1.1 = 19.9 \text{ dBm/MHz}$$

10. Parabolic antennas with a maximum gain of 37.2 dBi are intended to be used for point-to-point operation. Two 0.5 metre length RF cables with individual insertion loss of 0.9 dB were supplied to connect the antenna to the EUT RF ports. The 6 foot antenna gain is 37.2 dBi and cable loss of 0.9 dB giving a total gain of 36.3 dBi. This is 10.3 dB greater than 26 dBi allowed for point-to-point operation in Part 90.1215(a)(2). Therefore, the peak power spectral density limits for all supported channel bandwidths were reduced accordingly.

The Part 90.1215(a)(1) point-to-point peak power spectral density limit for the 6 foot parabolic antenna was recalculated as:

$$\text{All channel bandwidths: } 21 \text{ dBm/MHz} - 10.3 = 10.7 \text{ dBm/MHz}$$

Peak Power Spectral Density (continued)

Test setup for peak power spectral density measurements:

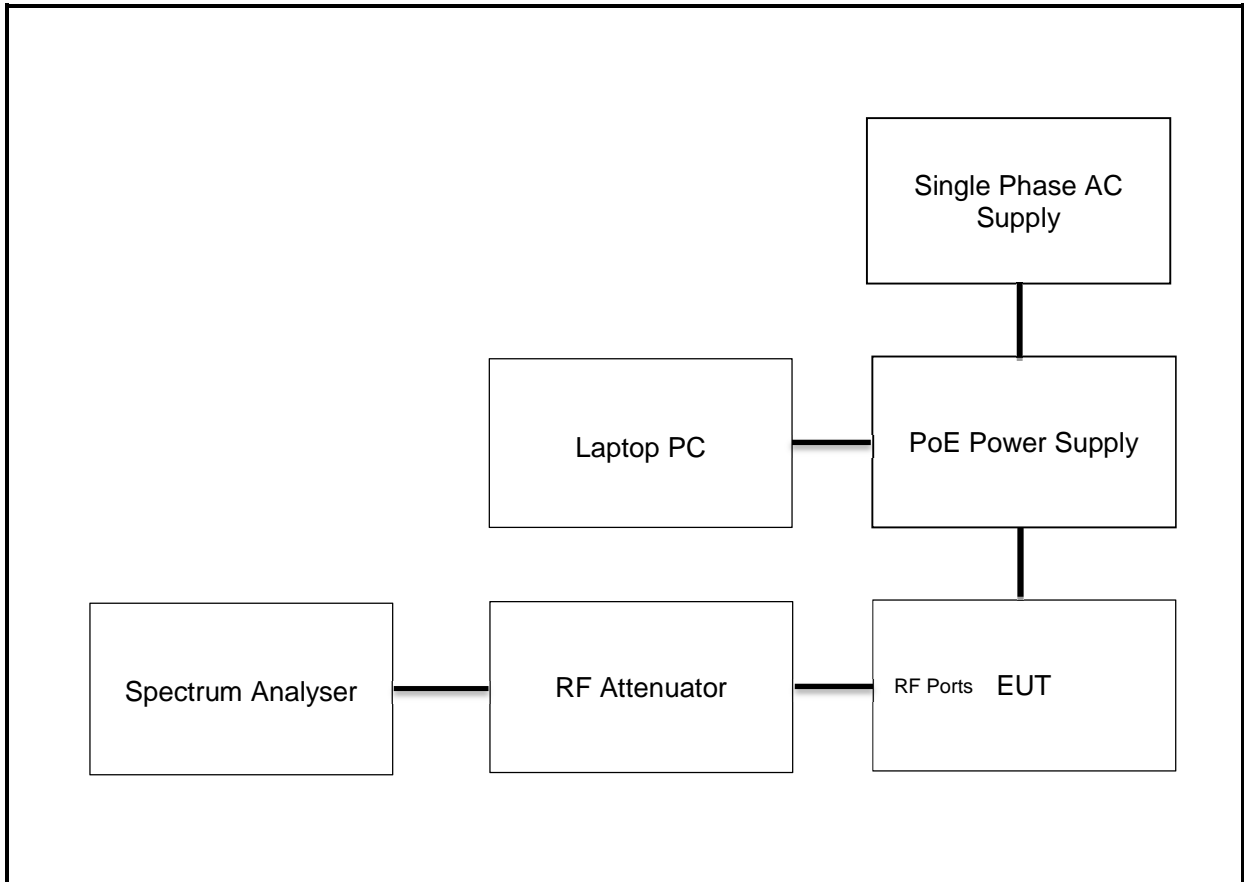

Peak Power Spectral Density (continued)

Results: 5 MHz Channel / QPSK / Omnidirectional Antenna

Channel	PPSD A Port (dBm/MHz)	PPSD B Port (dBm/MHz)	PPSD Power (dBm/MHz)	PPSD Power Limit (dBm/MHz)	Margin (dB)	Result
Bottom	15.4	15.3	18.4	21.0	2.6	Complied
Middle	15.5	15.3	18.4	21.0	2.6	Complied
Top	15.5	15.3	18.4	21.0	2.6	Complied

A Port

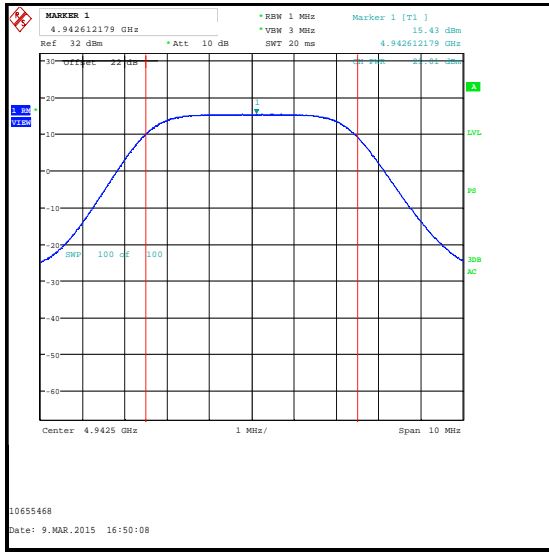

Bottom Channel

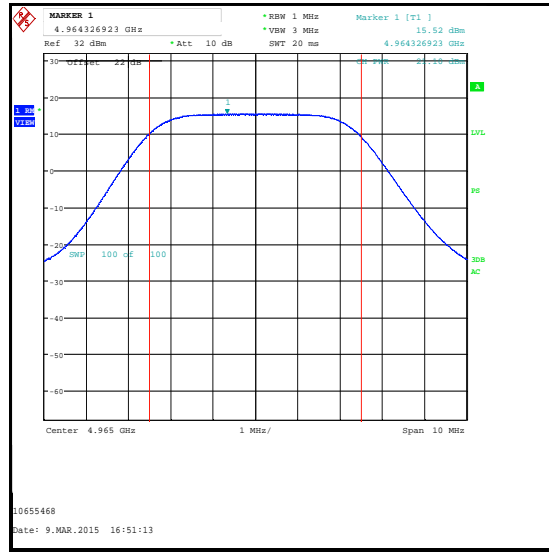

Middle Channel

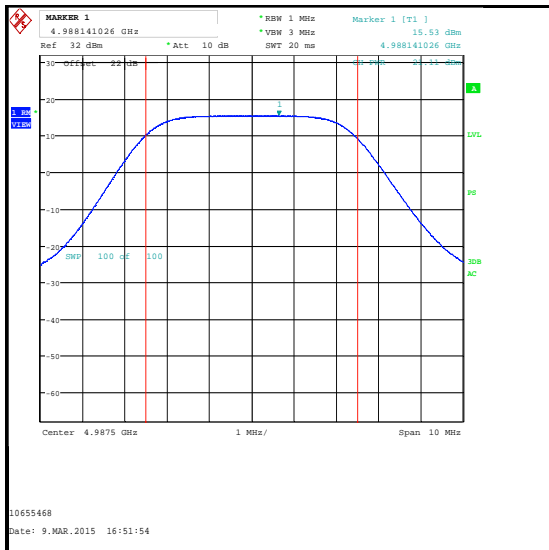

Top Channel

Peak Power Spectral Density (continued)

Results: 5 MHz Channel / QPSK / Omnidirectional Antenna

B Port

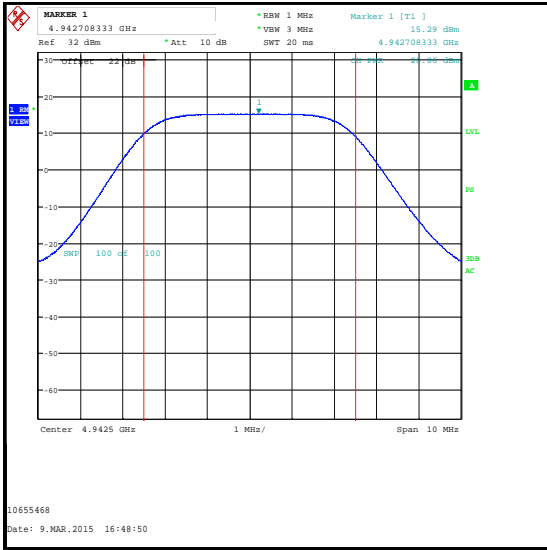

Bottom Channel

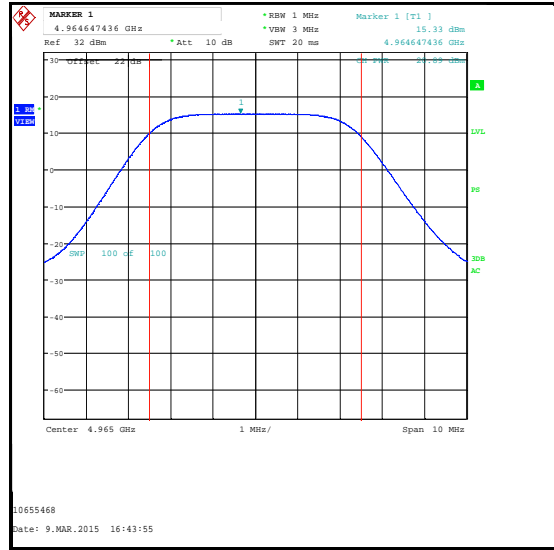

Middle Channel

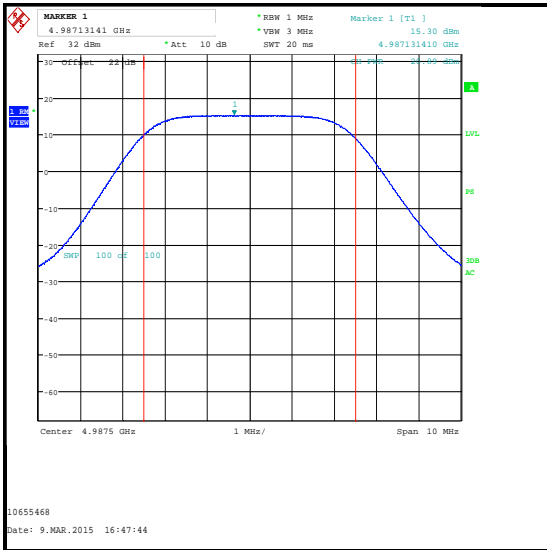

Top Channel

Peak Power Spectral Density (continued)

Results: 5 MHz Channel / QPSK / Sectorised Antenna

Channel	PPSD A Port (dBm/MHz)	PPSD B Port (dBm/MHz)	PPSD Power (dBm/MHz)	PPSD Power Limit (dBm/MHz)	Margin (dB)	Result
Bottom	15.4	15.3	18.4	21.0	2.6	Complied
Middle	15.5	15.3	18.4	21.0	2.6	Complied
Top	15.5	15.3	18.4	21.0	2.6	Complied

A Port

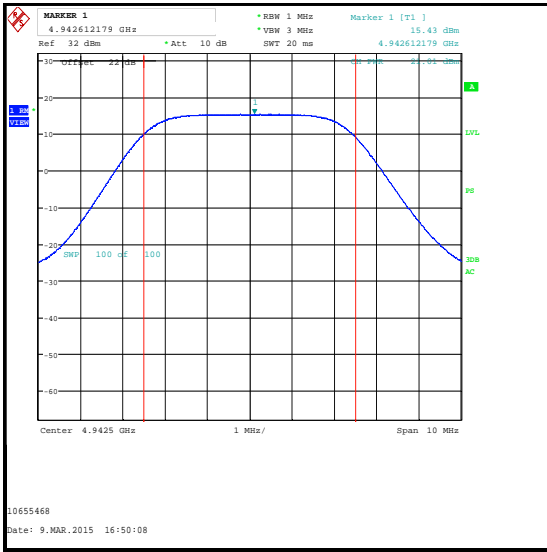

Bottom Channel

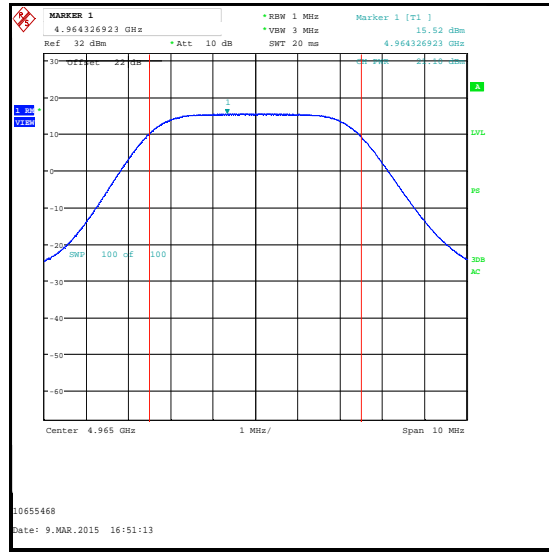

Middle Channel

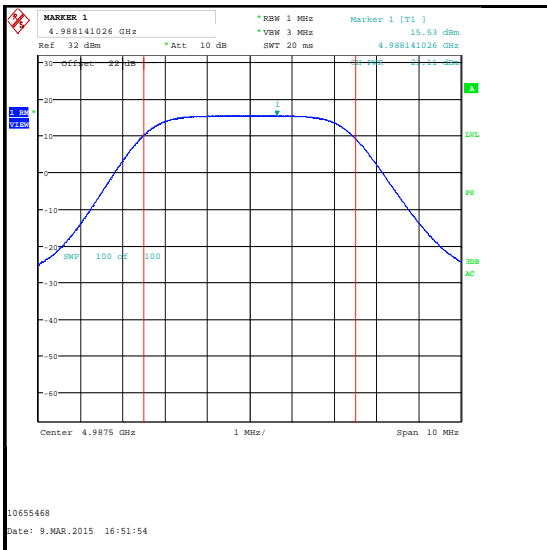

Top Channel

Peak Power Spectral Density (continued)

Results: 5 MHz Channel / QPSK / Sectorised Antenna

B Port

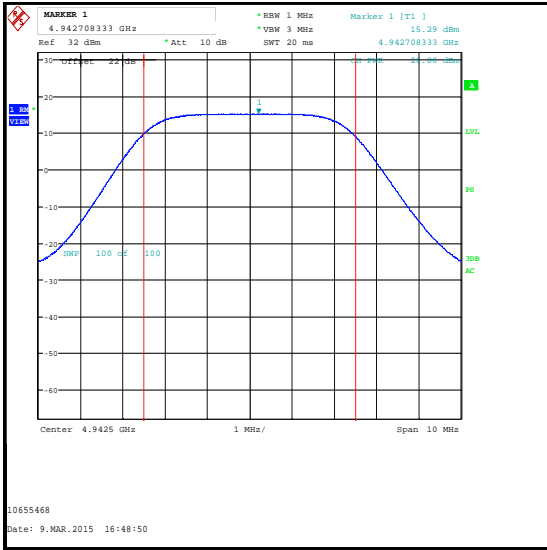

Bottom Channel

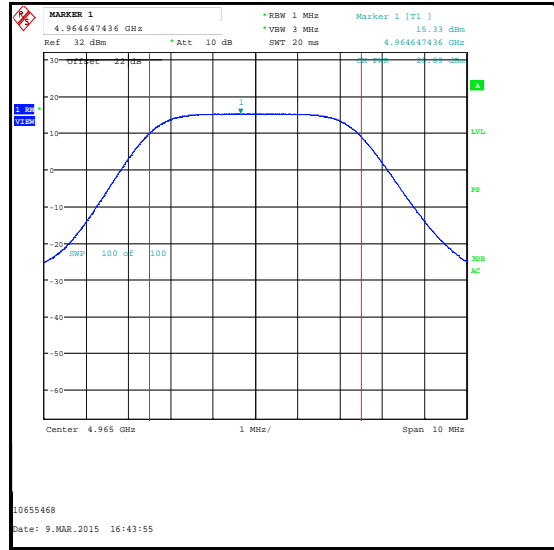

Middle Channel

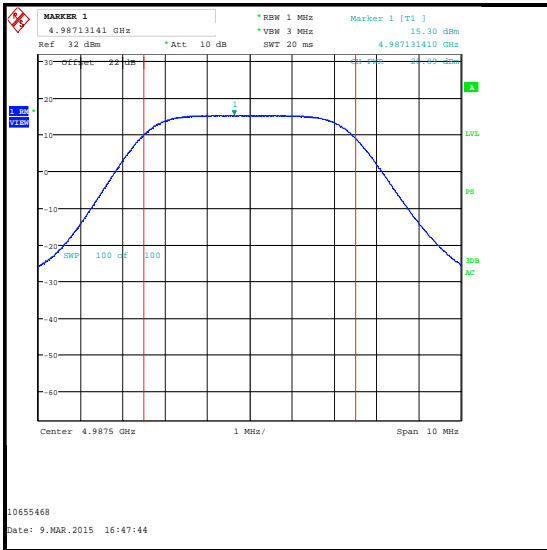

Top Channel

Peak Power Spectral Density (continued)

Results: 5 MHz Channel / QPSK / Plate Antenna

Channel	PPSD A Port (dBm/MHz)	PPSD B Port (dBm/MHz)	PPSD Power (dBm/MHz)	PPSD Power Limit (dBm/MHz)	Margin (dB)	Result
Bottom	15.4	15.3	18.4	19.9	1.5	Complied
Middle	15.5	15.3	18.4	19.9	1.5	Complied
Top	15.5	15.3	18.4	19.9	1.5	Complied

A Port

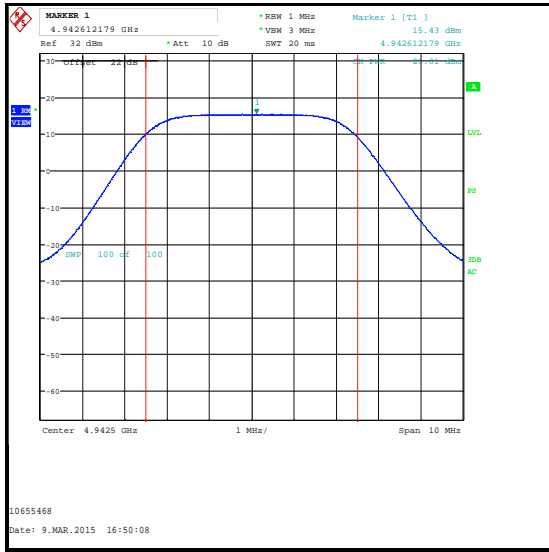

Bottom Channel

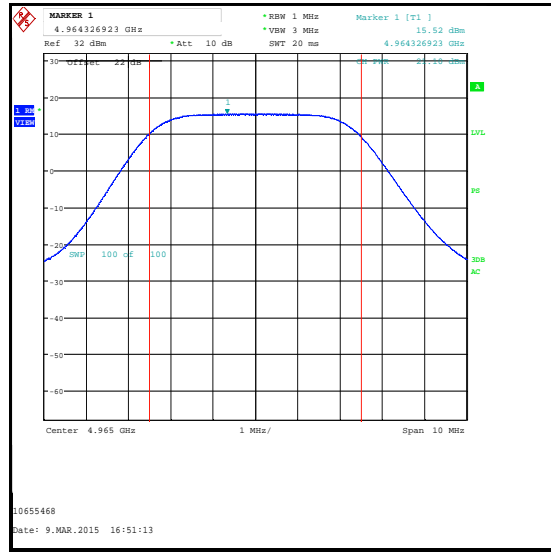

Middle Channel

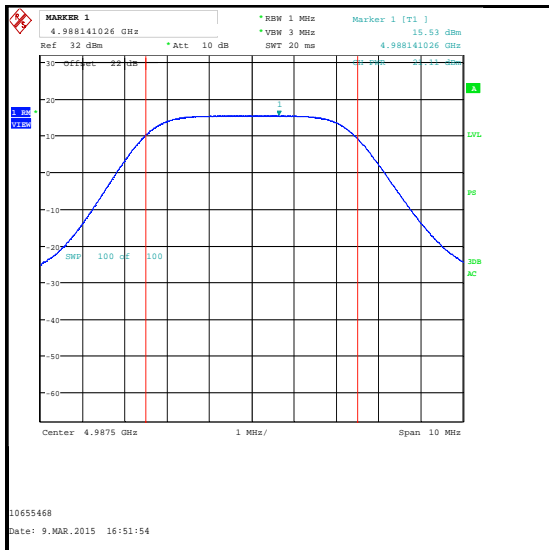

Top Channel

Peak Power Spectral Density (continued)

Results: 5 MHz Channel / QPSK / Plate Antenna

B Port



Bottom Channel

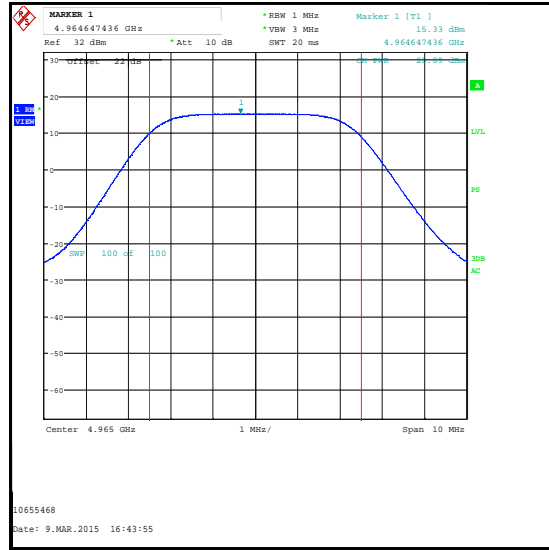

Middle Channel

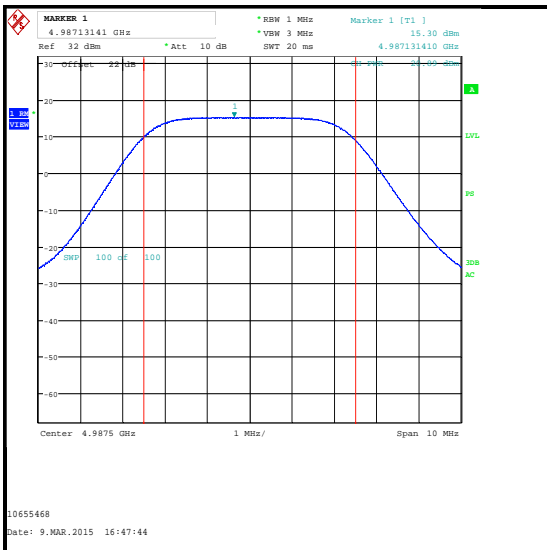

Top Channel

Peak Power Spectral Density (continued)

Results: 5 MHz Channel / QPSK / 6' Parabolic Antenna

Channel	PPSD A Port (dBm/MHz)	PPSD B Port (dBm/MHz)	PPSD Power (dBm/MHz)	PPSD Power Limit (dBm/MHz)	Margin (dB)	Result
Bottom	7.2	7.3	10.3	10.7	0.4	Complied
Middle	7.2	7.0	10.1	10.7	0.6	Complied
Top	7.4	7.2	10.3	10.7	0.4	Complied

A Port

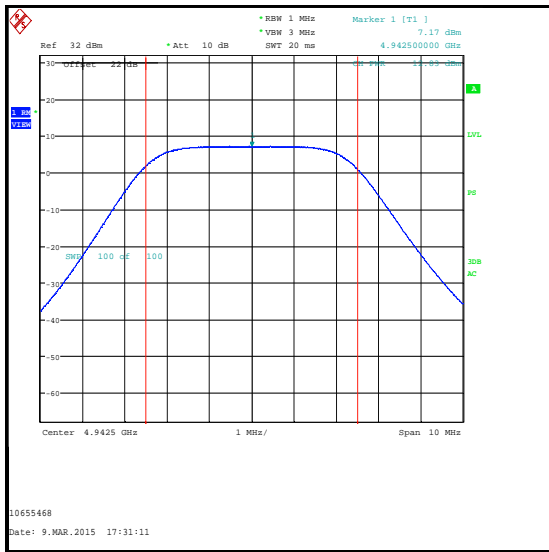

Bottom Channel

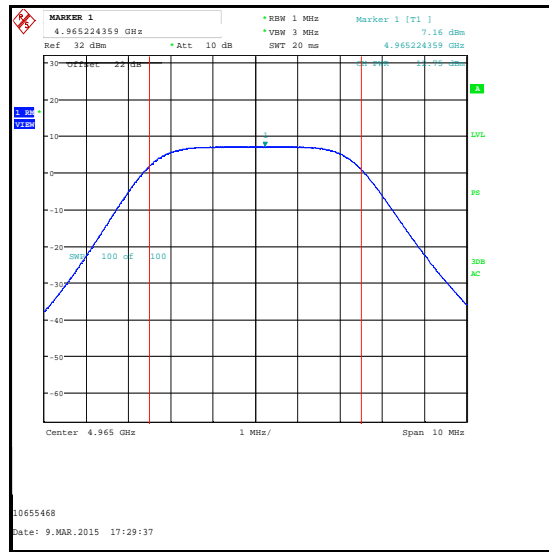

Middle Channel

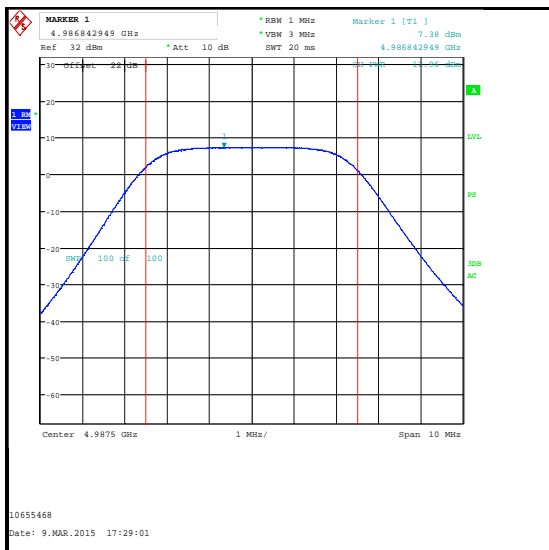

Top Channel

Peak Power Spectral Density (continued)

Results: 5 MHz Channel / QPSK / 6' Parabolic Antenna

B Port

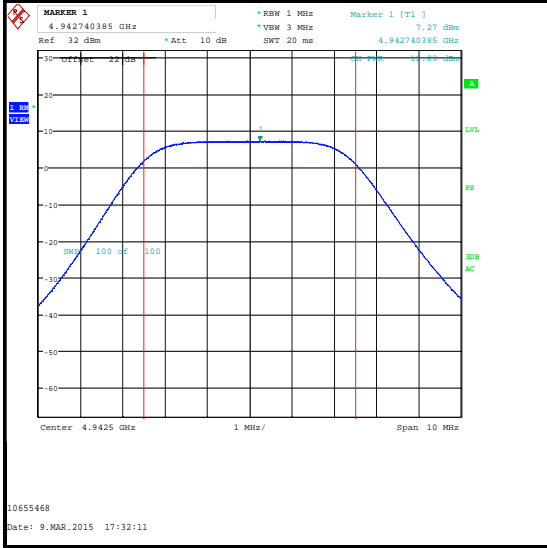

Bottom Channel

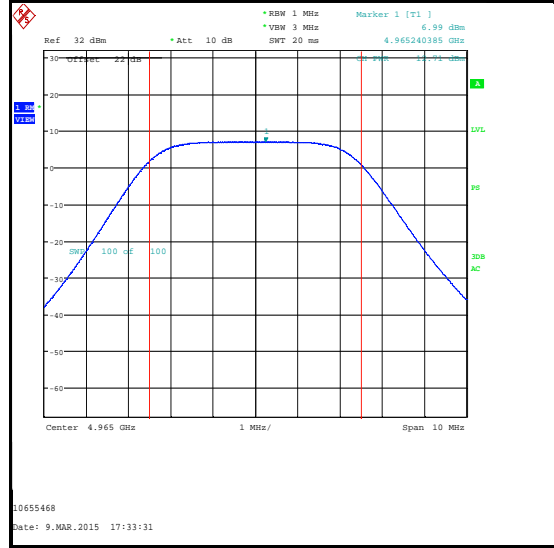

Middle Channel

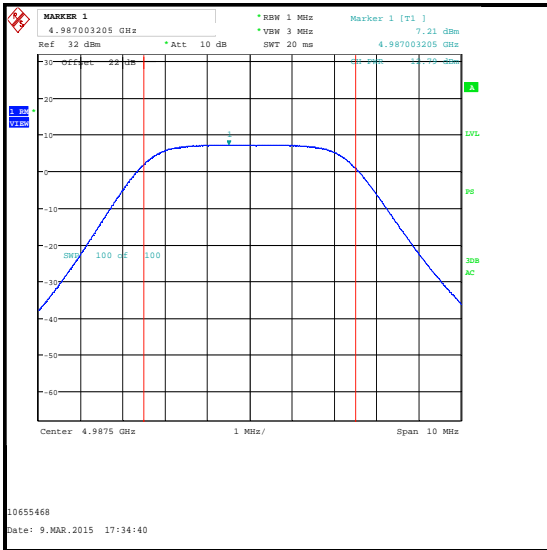

Top Channel

Peak Power Spectral Density (continued)

Results: 10 MHz Channel / QPSK / Omnidirectional Antenna

Channel	PPSD A Port (dBm/MHz)	PPSD B Port (dBm/MHz)	PPSD Power (dBm/MHz)	PPSD Power Limit (dBm/MHz)	Margin (dB)	Result
Bottom	11.9	12.2	15.1	21.0	5.9	Complied
Middle	12.1	12.3	15.2	21.0	5.8	Complied
Top	12.2	12.3	15.3	21.0	5.7	Complied

A Port

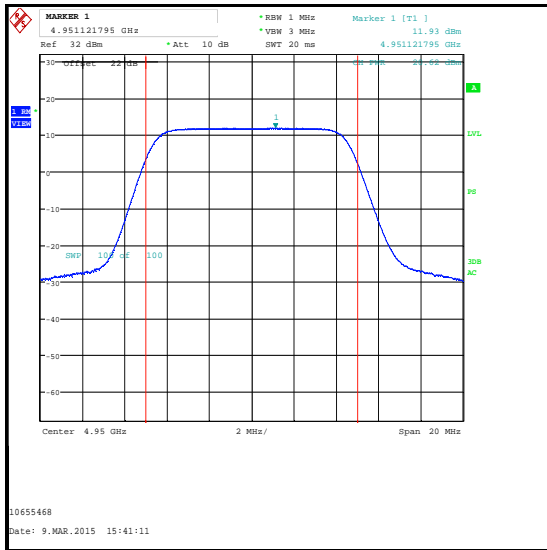

Bottom Channel

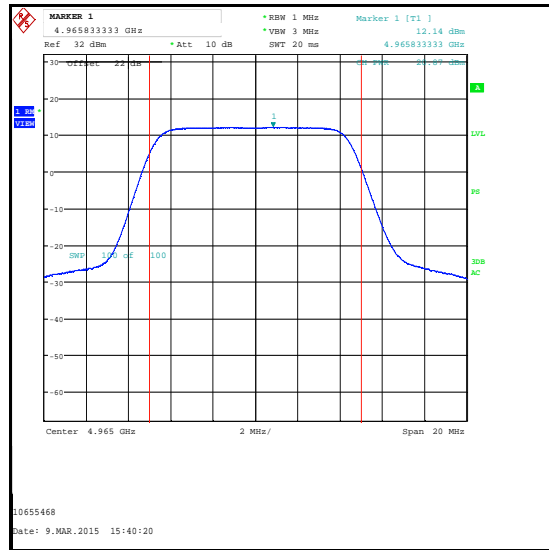

Middle Channel

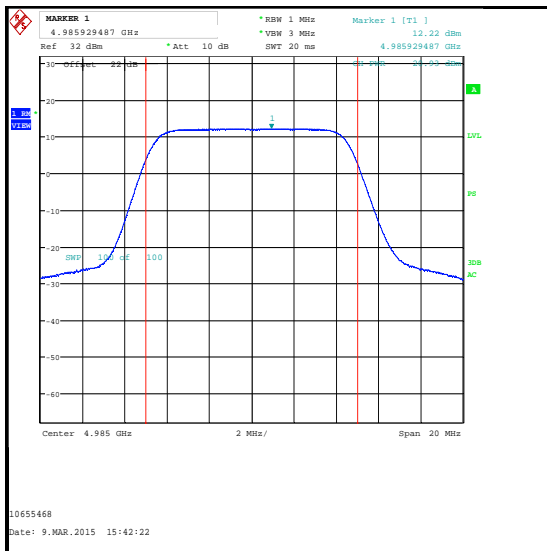

Top Channel

Peak Power Spectral Density (continued)

Results: 10 MHz Channel / QPSK / Omnidirectional Antenna

B Port

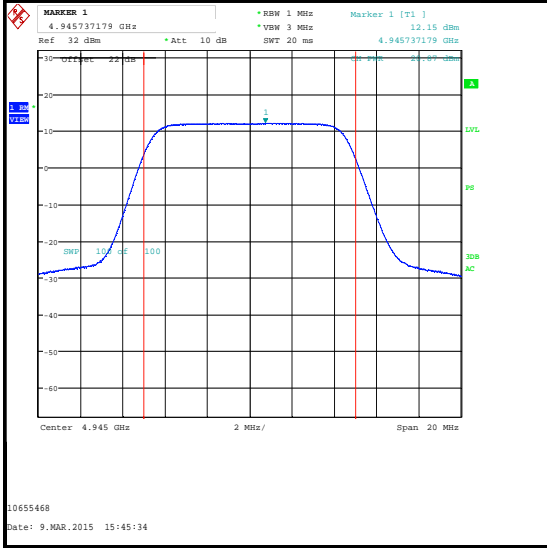

Bottom Channel

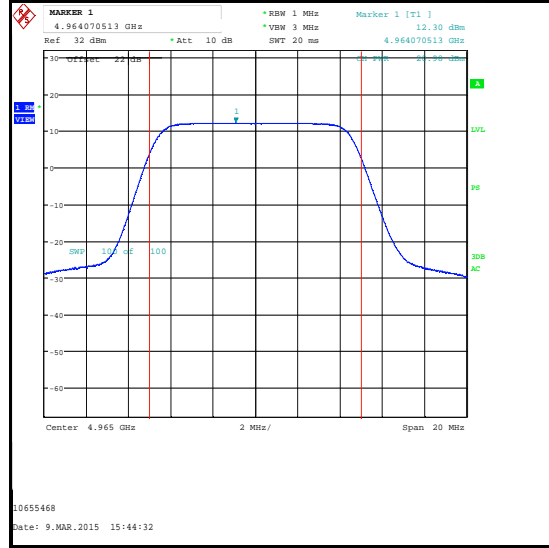

Middle Channel

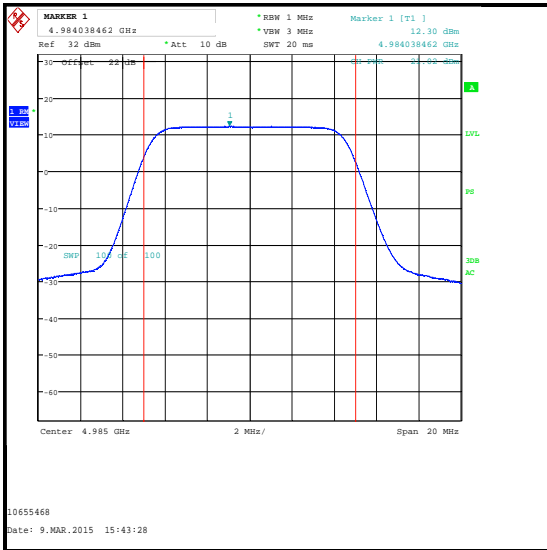

Top Channel

Peak Power Spectral Density (continued)

Results: 10 MHz Channel / QPSK / Sectorised Antenna

Channel	PPSD A Port (dBm/MHz)	PPSD B Port (dBm/MHz)	PPSD Power (dBm/MHz)	PPSD Power Limit (dBm/MHz)	Margin (dB)	Result
Bottom	11.9	12.2	15.1	21.0	5.9	Complied
Middle	12.2	12.3	15.3	21.0	5.7	Complied
Top	12.2	12.3	15.3	21.0	5.7	Complied

A Port

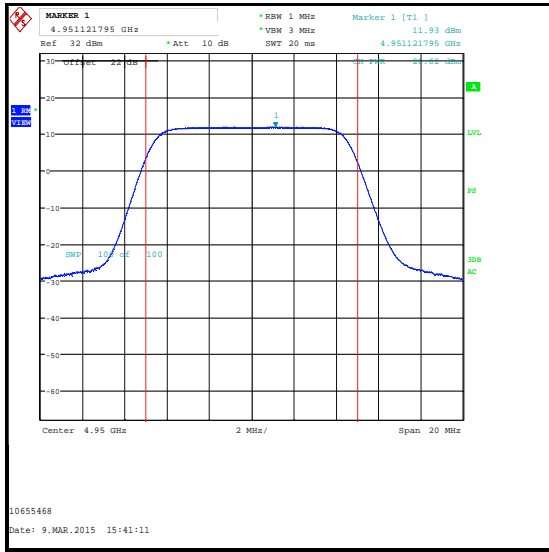

Bottom Channel

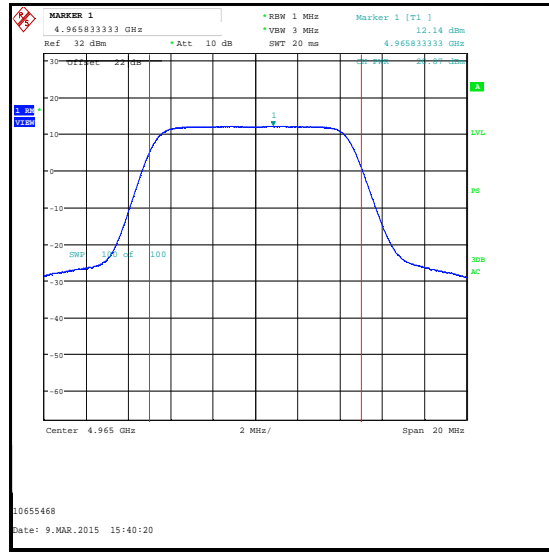

Middle Channel

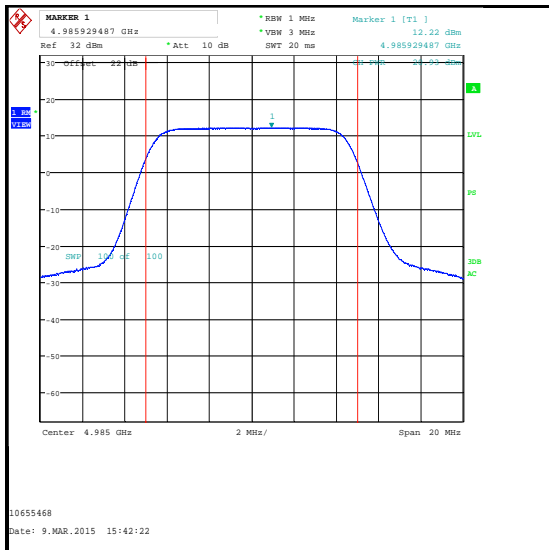

Top Channel

Peak Power Spectral Density (continued)

Results: 10 MHz Channel / QPSK / Sectorised Antenna

B Port

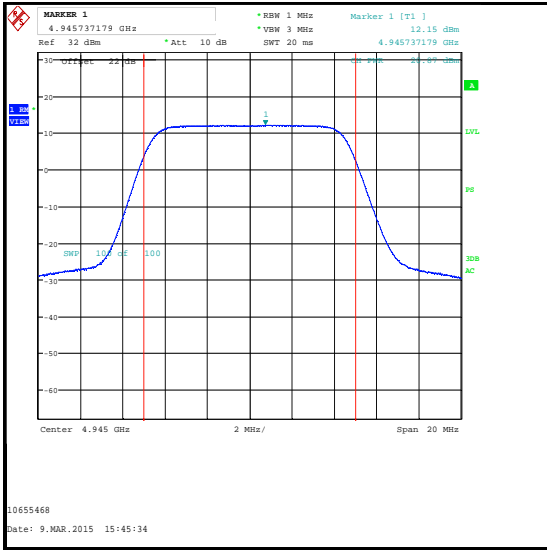

Bottom Channel

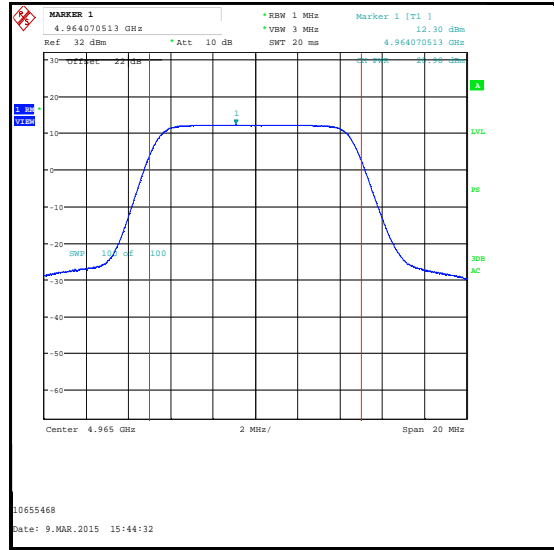

Middle Channel

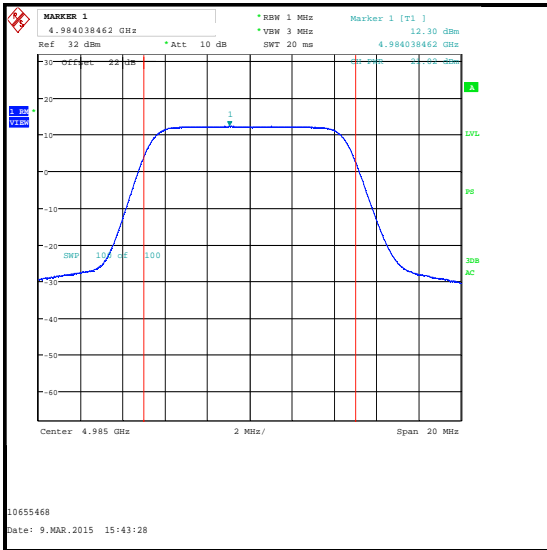

Top Channel

Peak Power Spectral Density (continued)

Results: 10 MHz Channel / QPSK / Plate Antenna

Channel	PPSD A Port (dBm/MHz)	PPSD B Port (dBm/MHz)	PPSD Power (dBm/MHz)	PPSD Power Limit (dBm/MHz)	Margin (dB)	Result
Bottom	11.9	12.2	15.1	19.9	4.8	Complied
Middle	12.1	12.3	15.2	19.9	4.7	Complied
Top	12.2	12.3	15.3	19.9	4.6	Complied

A Port

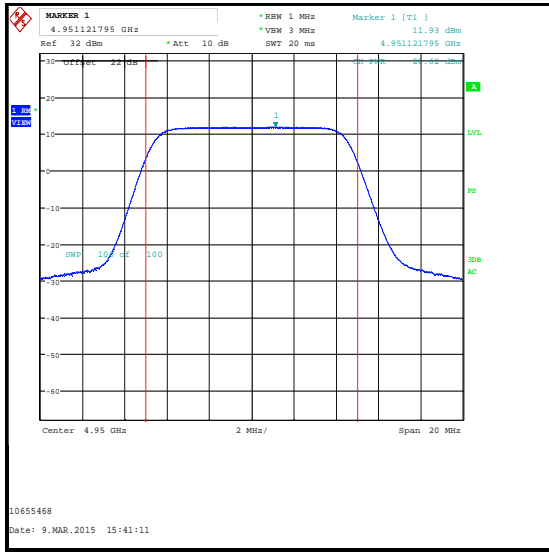

Bottom Channel

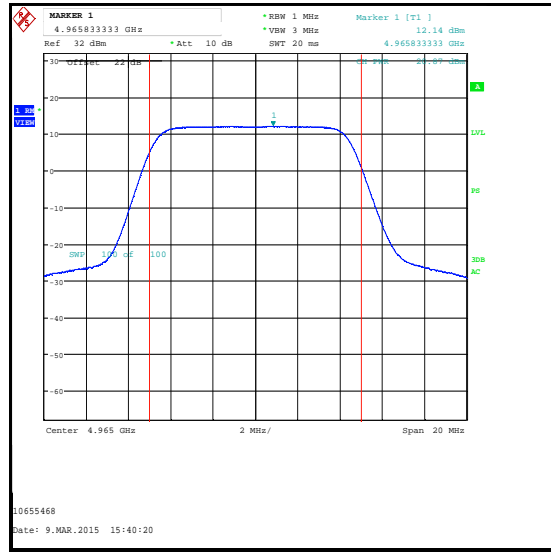

Middle Channel

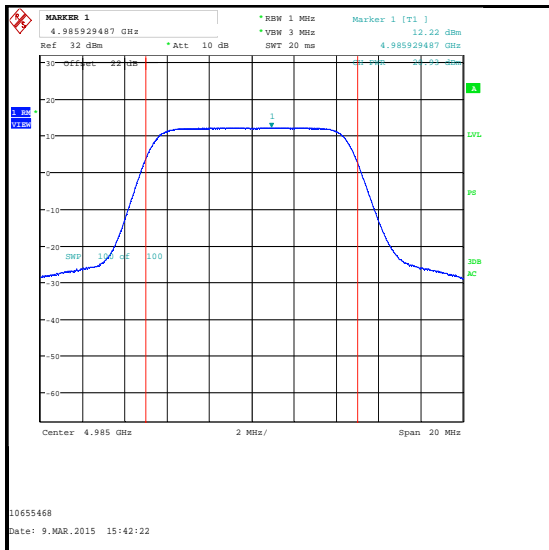

Top Channel

Peak Power Spectral Density (continued)

Results: 10 MHz Channel / QPSK / Plate Antenna

B Port

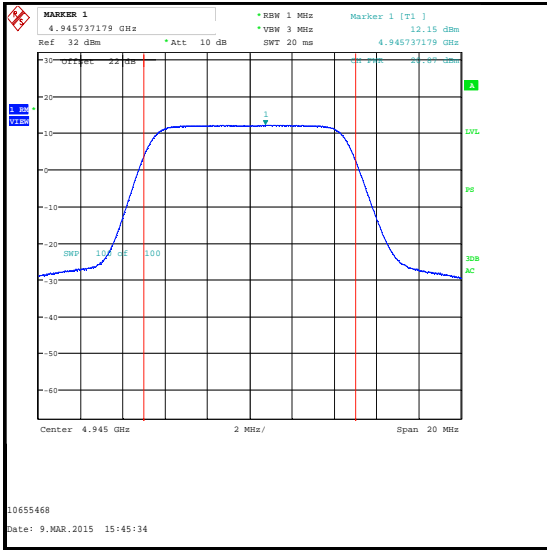

Bottom Channel

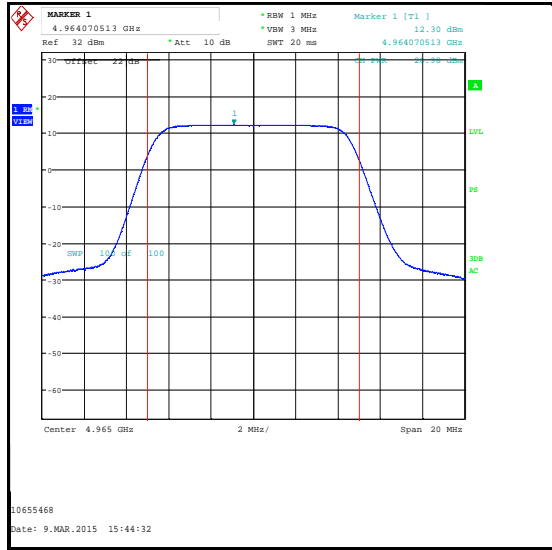

Middle Channel

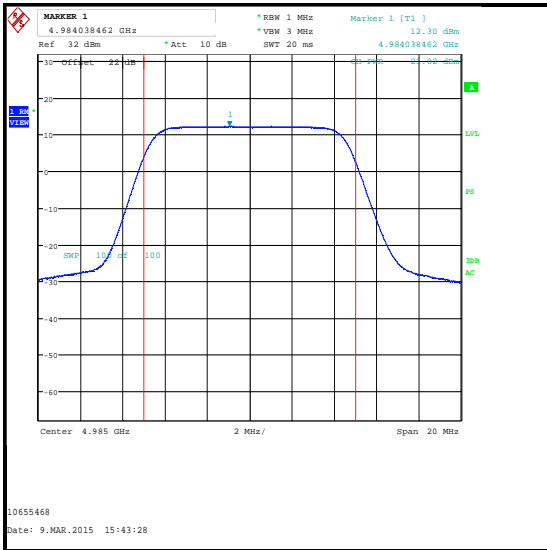

Top Channel

Peak Power Spectral Density (continued)

Results: 10 MHz Channel / QPSK / 6' Parabolic Antenna

Channel	PPSD A Port (dBm/MHz)	PPSD B Port (dBm/MHz)	PPSD Power (dBm/MHz)	PPSD Power Limit (dBm/MHz)	Margin (dB)	Result
Bottom	7.5	7.2	10.4	10.7	0.3	Complied
Middle	7.5	7.1	10.3	10.7	0.4	Complied
Top	7.6	7.4	10.5	10.7	0.2	Complied

A Port

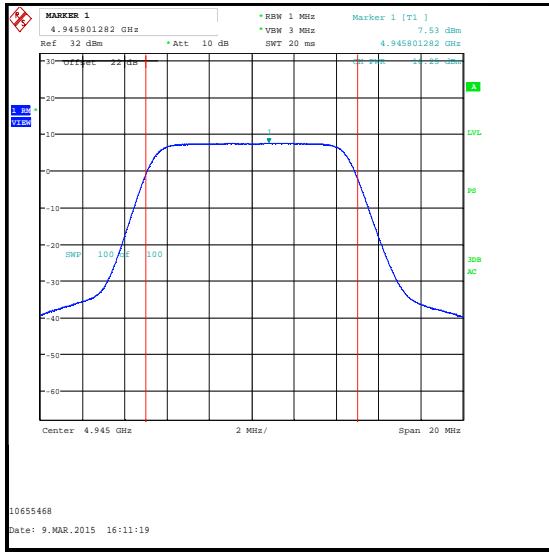

Bottom Channel

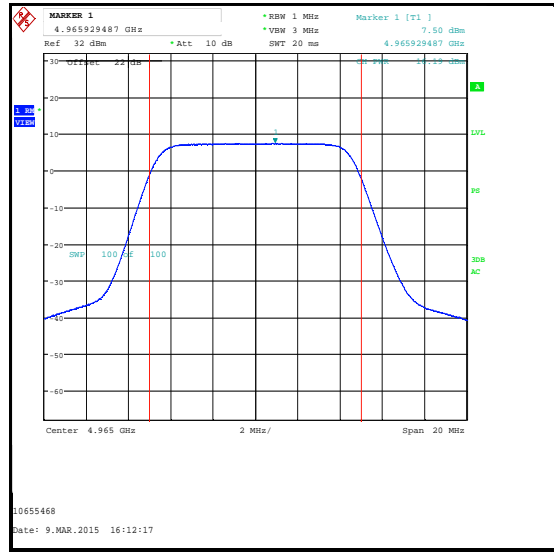

Middle Channel

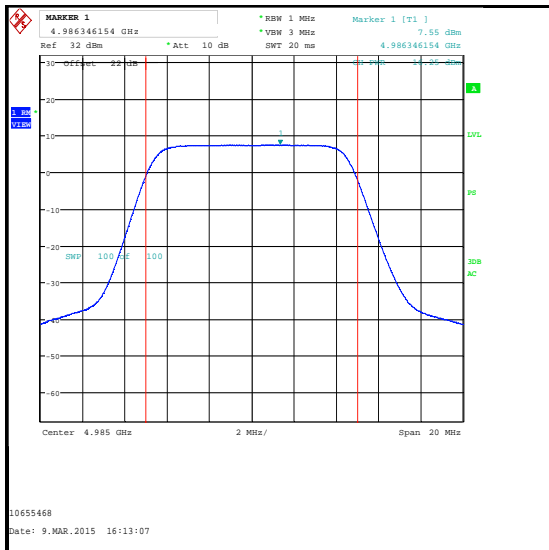

Top Channel

Peak Power Spectral Density (continued)

Results: 10 MHz Channel / QPSK / 6' Parabolic Antenna

B Port

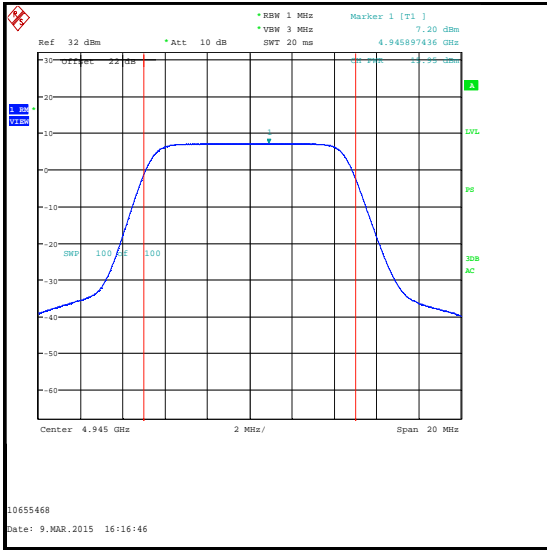

Bottom Channel

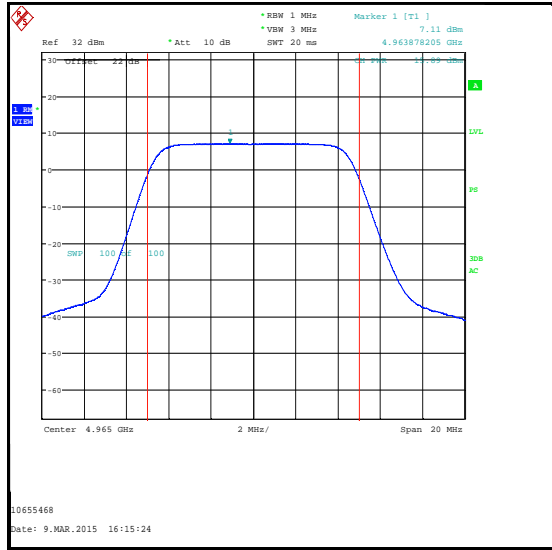

Middle Channel

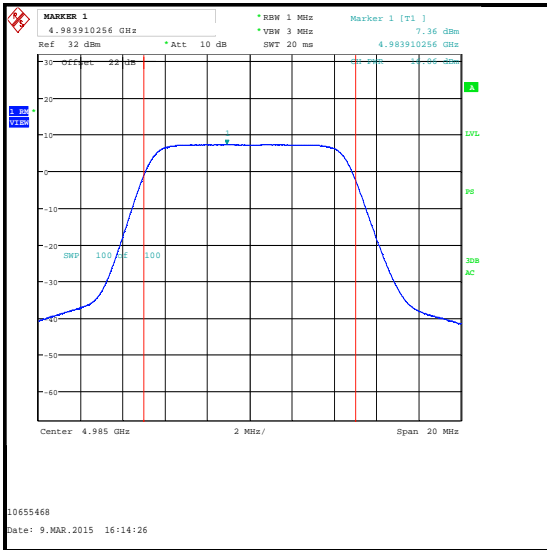

Top Channel

Peak Power Spectral Density (continued)

Results: 20 MHz Channel / QPSK / Omnidirectional Antenna

Channel	PPSD A Port (dBm/MHz)	PPSD B Port (dBm/MHz)	PPSD Power (dBm/MHz)	PPSD Power Limit (dBm/MHz)	Margin (dB)	Result
Bottom	8.8	8.6	11.7	21.0	9.3	Complied
Middle	8.9	8.8	11.9	21.0	9.1	Complied
Top	8.8	8.8	11.8	21.0	9.2	Complied

A Port

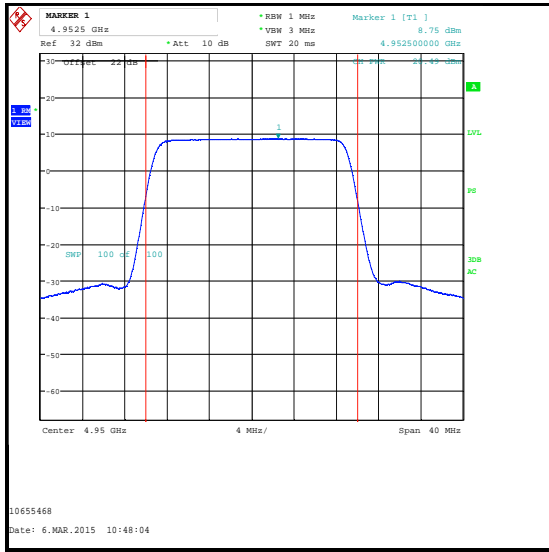

Bottom Channel

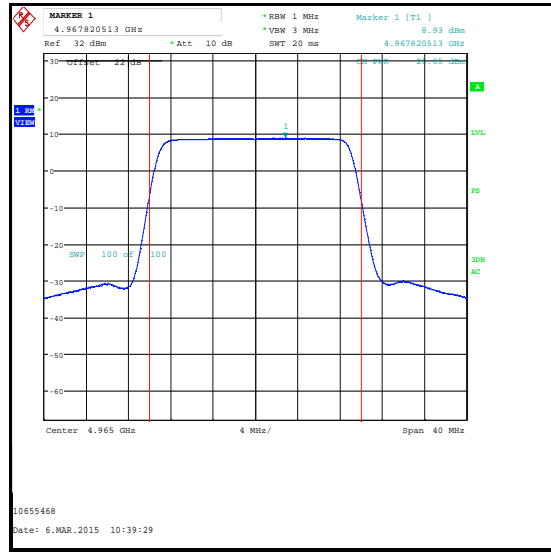

Middle Channel

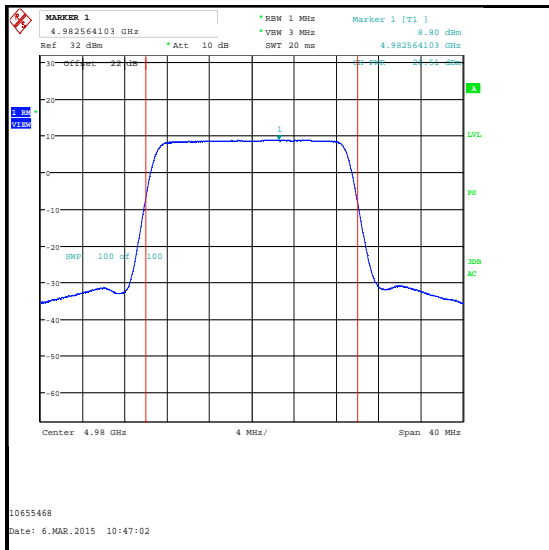

Top Channel

Peak Power Spectral Density (continued)

Results: 20 MHz Channel / QPSK / Omnidirectional Antenna

B Port

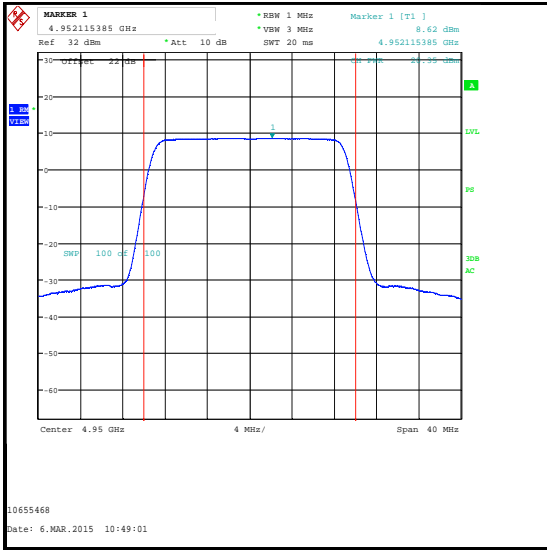

Bottom Channel

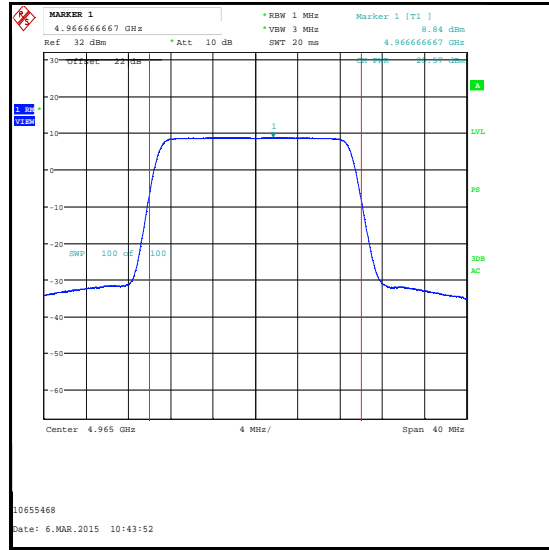

Middle Channel

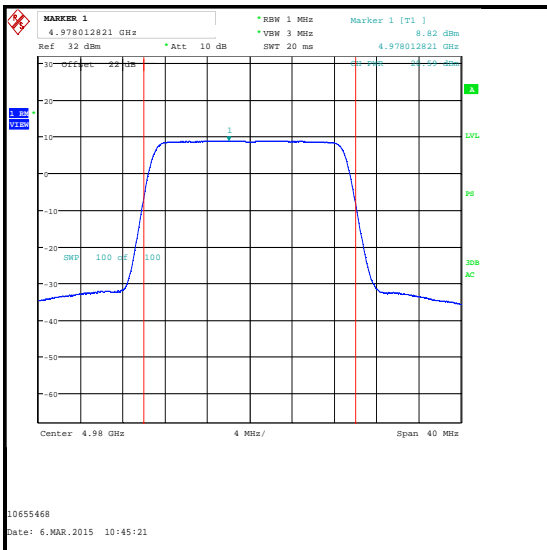

Top Channel

Peak Power Spectral Density (continued)

Results: 20 MHz Channel / QPSK / Sectorised Antenna

Channel	PPSD A Port (dBm/MHz)	PPSD B Port (dBm/MHz)	PPSD Power (dBm/MHz)	PPSD Power Limit (dBm/MHz)	Margin (dB)	Result
Bottom	8.8	8.6	11.7	21.0	9.3	Complied
Middle	8.9	8.8	11.9	21.0	9.1	Complied
Top	8.8	8.8	11.8	21.0	9.2	Complied

A Port

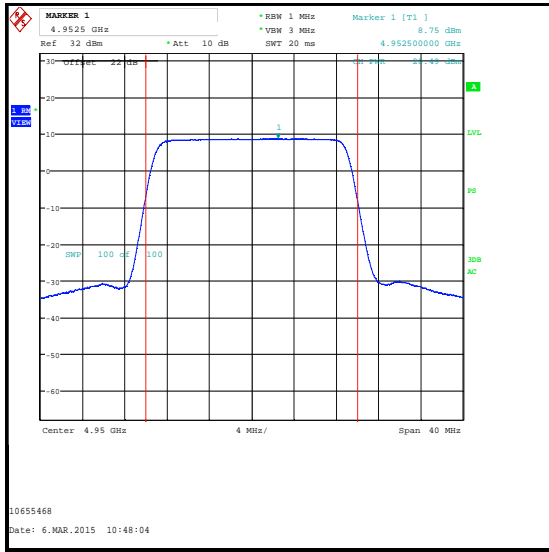

Bottom Channel

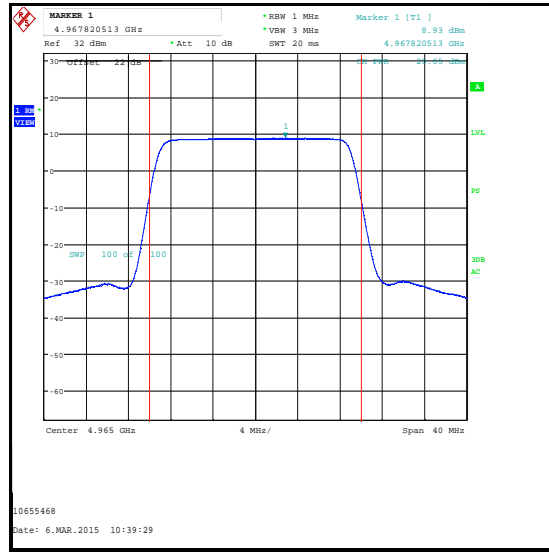

Middle Channel



Top Channel

Peak Power Spectral Density (continued)

Results: 20 MHz Channel / QPSK / Sectorised Antenna

B Port

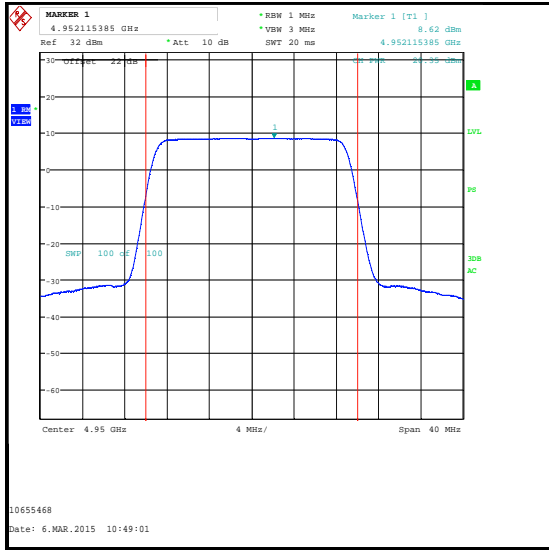

Bottom Channel

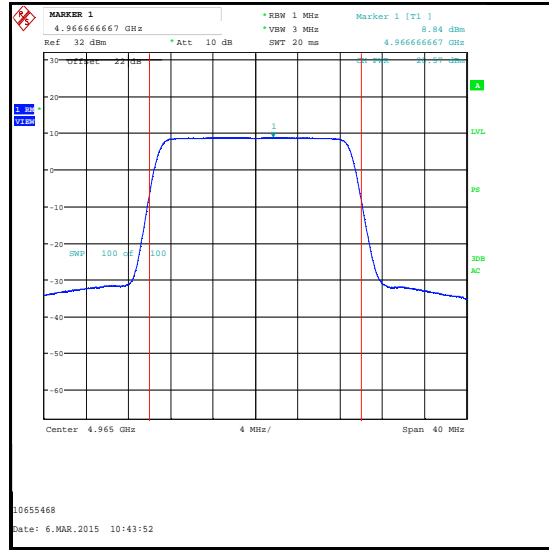

Middle Channel



Top Channel

Peak Power Spectral Density (continued)

Results: 20 MHz Channel / QPSK / Plate Antenna

Channel	PPSD A Port (dBm/MHz)	PPSD B Port (dBm/MHz)	PPSD Power (dBm/MHz)	PPSD Power Limit (dBm/MHz)	Margin (dB)	Result
Bottom	8.8	8.6	11.7	19.9	8.2	Complied
Middle	8.9	8.8	11.9	19.9	8.0	Complied
Top	8.8	8.8	11.8	19.9	8.1	Complied

A Port

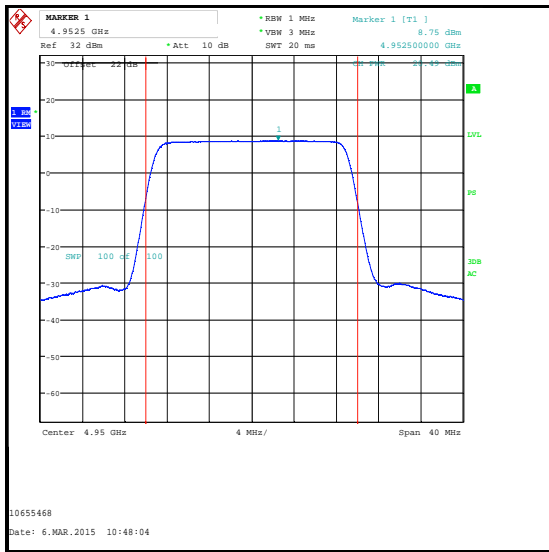

Bottom Channel

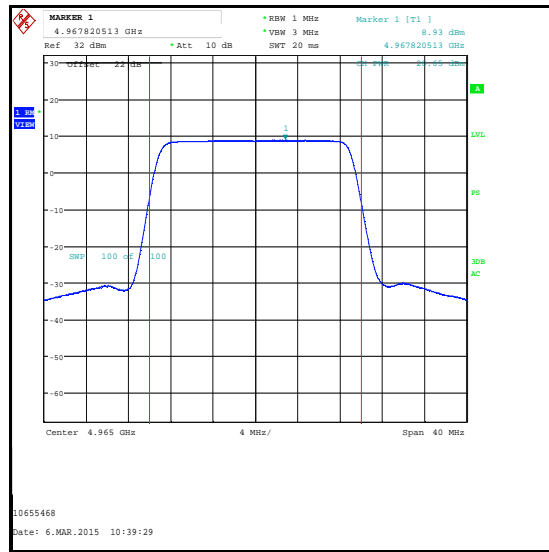

Middle Channel

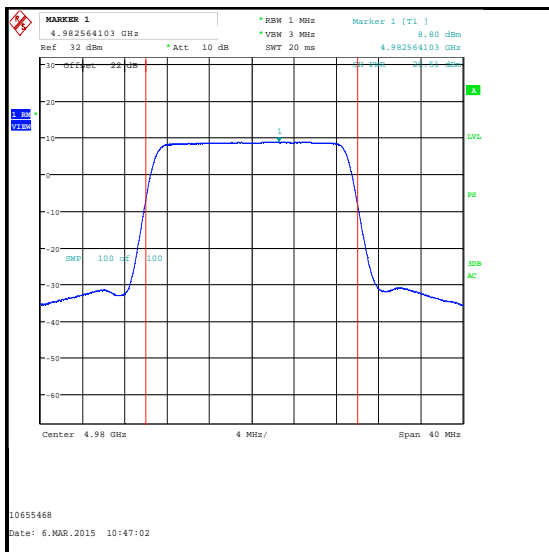

Top Channel

Peak Power Spectral Density (continued)

Results: 20 MHz Channel / QPSK / Plate Antenna

B Port

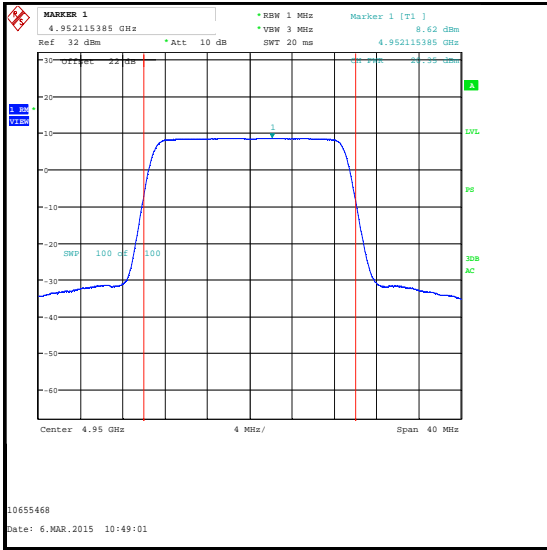

Bottom Channel

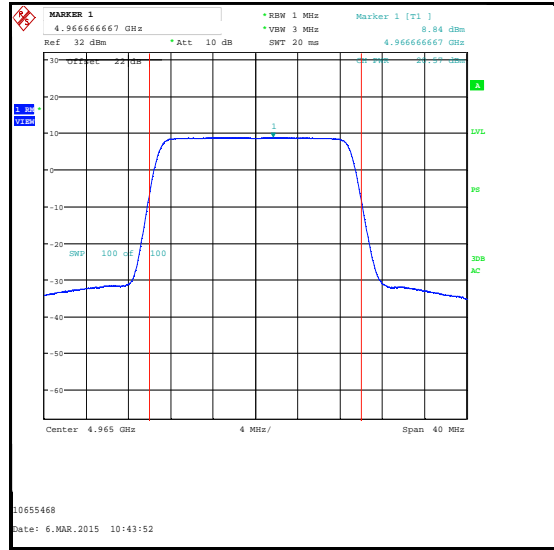

Middle Channel

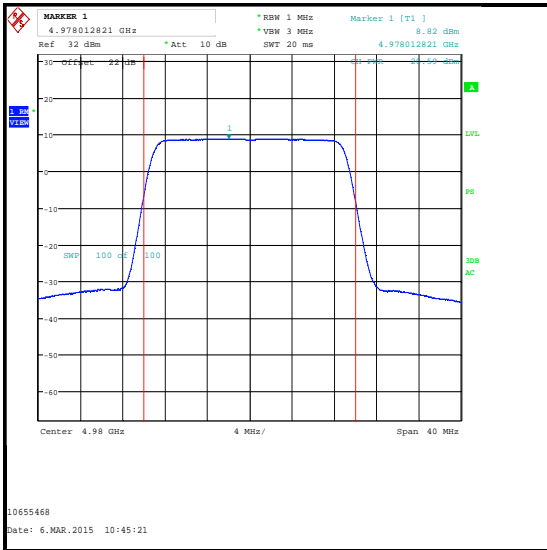

Top Channel

Peak Power Spectral Density (continued)

Results: 20 MHz Channel / QPSK / 6' Parabolic Antenna

Channel	PPSD A Port (dBm/MHz)	PPSD B Port (dBm/MHz)	PPSD Power (dBm/MHz)	PPSD Power Limit (dBm/MHz)	Margin (dB)	Result
Bottom	7.3	7.4	10.4	10.7	0.3	Complied
Middle	7.2	7.3	10.3	10.7	0.4	Complied
Top	7.4	7.5	10.5	10.7	0.2	Complied

A Port

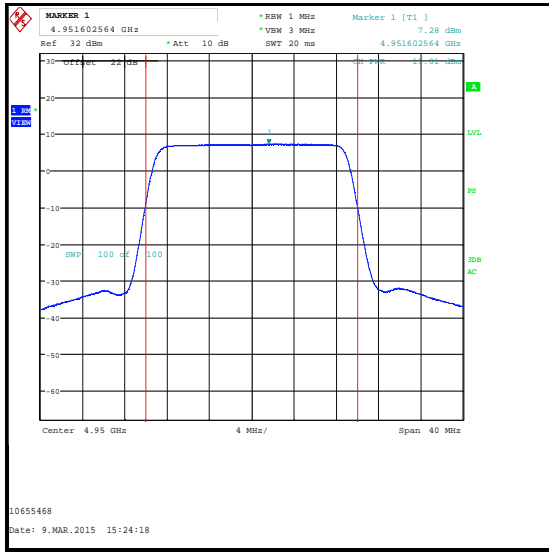

Bottom Channel

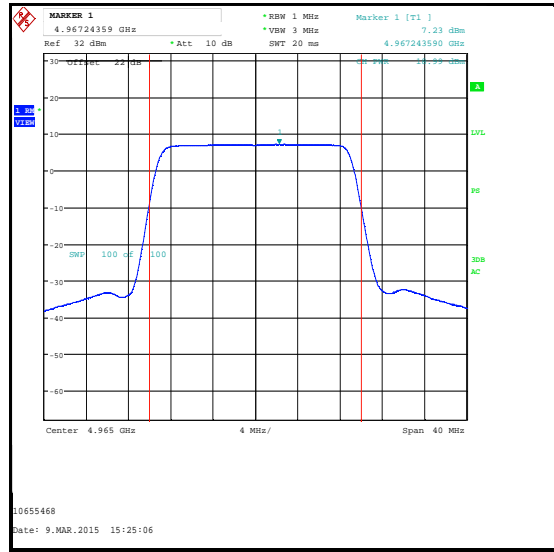

Middle Channel



Top Channel

Peak Power Spectral Density (continued)

Results: 20 MHz Channel / QPSK / 6' Parabolic Antenna

B Port

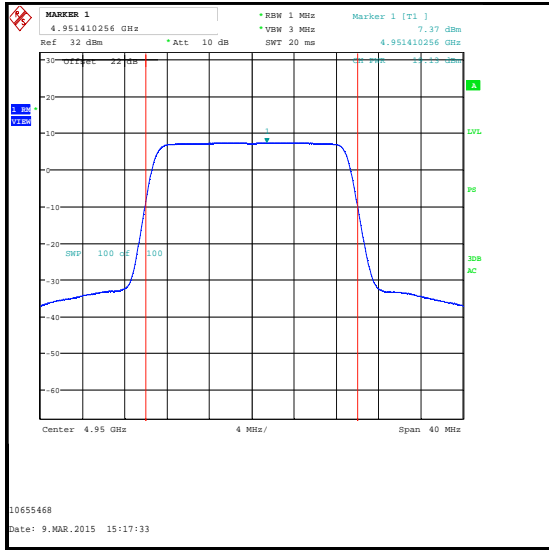

Bottom Channel

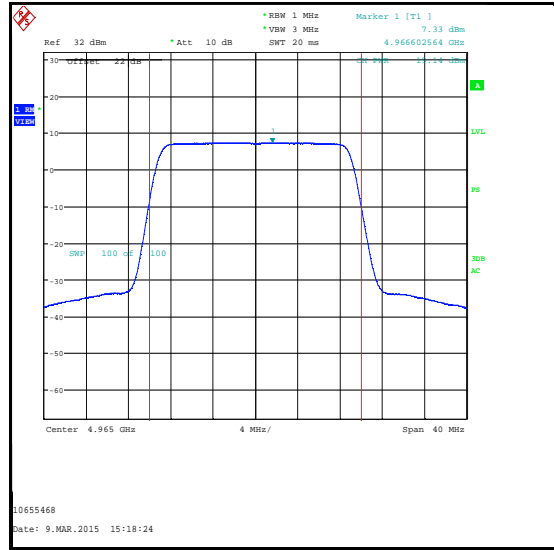

Middle Channel

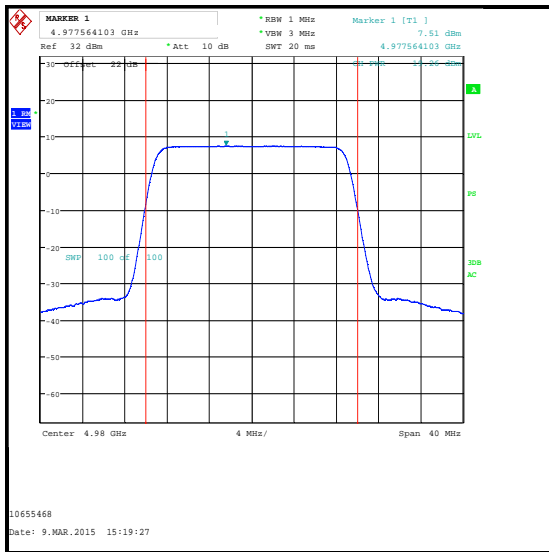

Top Channel

Test Equipment Used:

Asset No.	Instrument	Manufacturer	Type No.	Serial No.	Date Calibration Due	Cal. Interval (Months)
A2527	Attenuator	AtlanTecRF	AN18W5-20	832828#2	Calibrated before use	N/A
M260	Signal Generator	Rohde & Schwarz	SMP02	829076/008	24 Apr 2015	12
M1886	Test Receiver	Rohde & Schwarz	ESU26	100554	09 May 2015	12
M1657	Thermohygrometer	JM Handelspunkt	30.5015.13	N/A	14 Mar 2015	12

5.2.3. Peak Excursion**Test Summary:**

Test Engineer:	Ian Watch	Test Date:	11 March 2015
Test Sample Serial Number:	F50980BB0070		

FCC Reference:	Part 90.1215(e)
Test Method Used:	Part 90.1215(e), KDB 971168 D01 Section 5.7.1 and Notes below

Environmental Conditions:

Temperature (°C):	25
Relative Humidity (%):	31

Note(s):

1. A 20 dB attenuator and RF cable were used to connect the measurement equipment to the EUT RF ports. The combined cable and attenuator loss was measured prior to performing the measurements and the loss compensation incorporated into the measurement results. The loss of 22 dB appears on the result plots as an RF level offset.
2. The EUT was transmitting at 100% duty cycle during the test.
3. Measurements were performed with the EUT transmitting on the middle channel of each supported channel bandwidth. All modes were tested and found to have similar PAPR levels. Only QPSK results are shown in this report. All other modes are archived on the UL VS LTD IT server and available for inspection.
4. Peak excursion was measured on the A Port using the CCDF function of a Rohde & Schwarz ESU spectrum analyser. The spectrum analyser was configured following the Rohde & Schwarz instruction manual. Measurement interval was set to 1 ms. In accordance with Part 90.1215(e), the measurement bandwidth was set to 1 MHz. The maximum PAPR level associated with a probability of 0.1% was recorded in the following tables.

Peak Excursion (continued)

Test setup for peak excursion measurements:

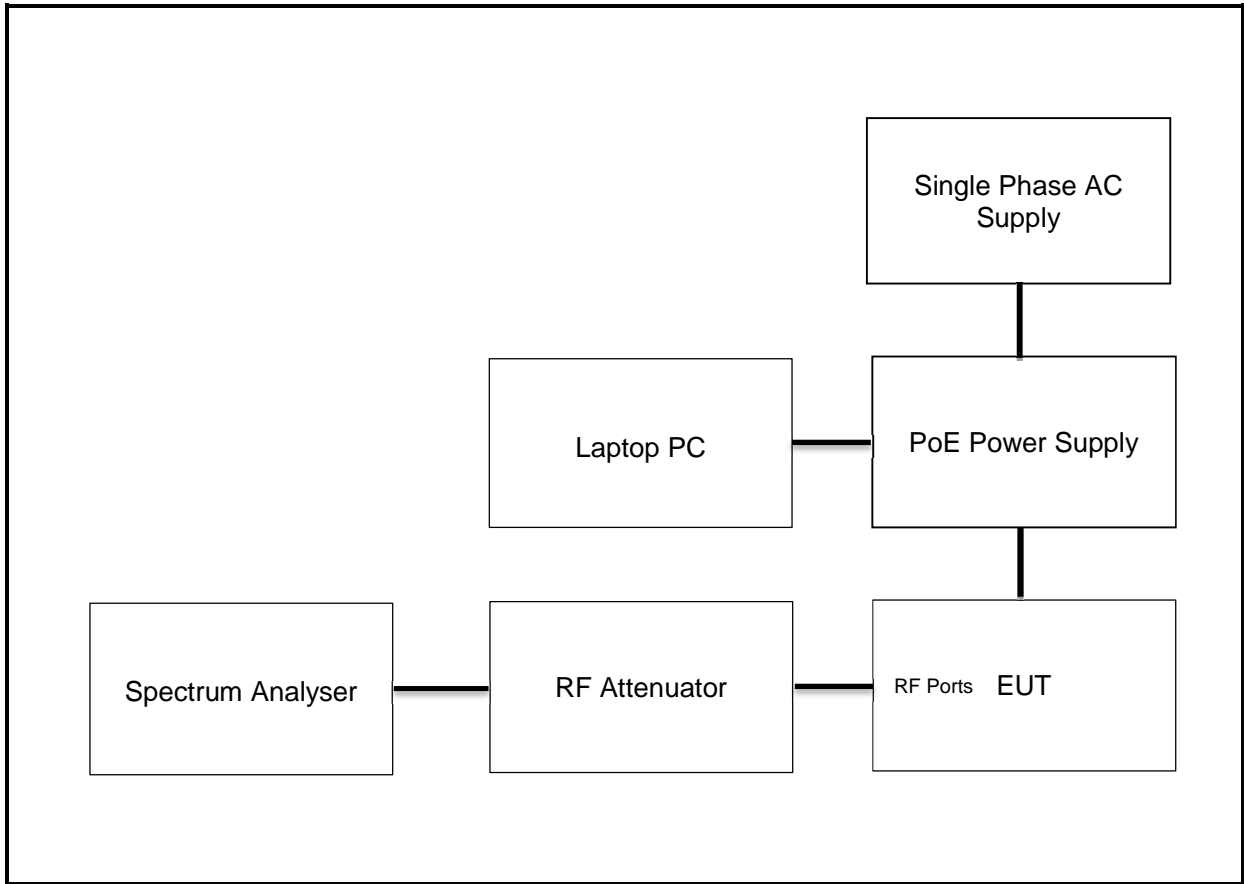

Peak Excursion (continued)

Results: 5 MHz Channel / QPSK

Channel Frequency (MHz)	Peak Excursion (dB)	Limit (dB)	Margin (dB)	Result
4965	8.7	13.0	4.3	Complied

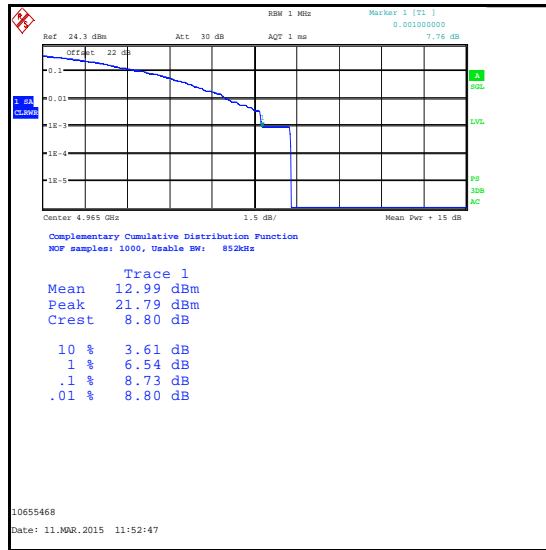

Peak Excursion (continued)

Results: 10 MHz Channel / QPSK

Channel Frequency (MHz)	Peak Excursion (dB)	Limit (dB)	Margin (dB)	Result
4965	9.3	13.0	3.7	Complied

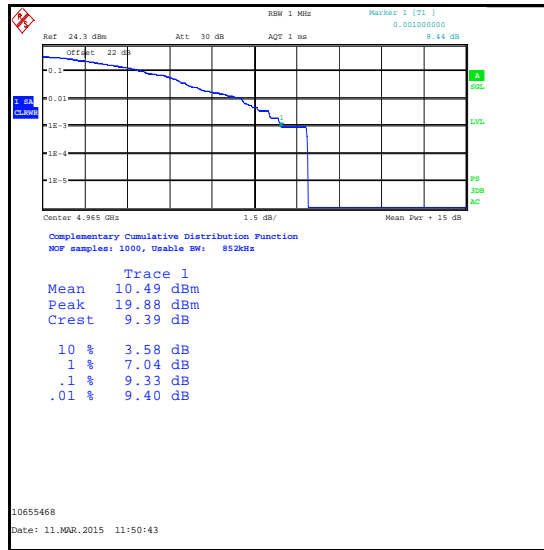

Peak Excursion (continued)

Results: 20 MHz Channel / QPSK

Channel Frequency (MHz)	Peak Excursion (dB)	Limit (dB)	Margin (dB)	Result
4965	8.5	13.0	4.5	Complied

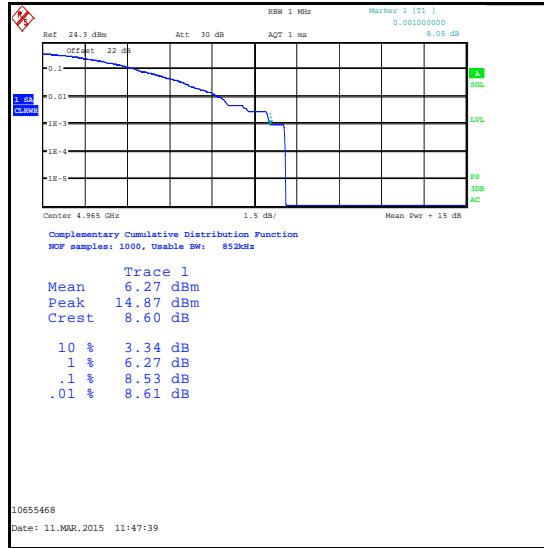

Test Equipment Used:

Asset No.	Instrument	Manufacturer	Type No.	Serial No.	Date Calibration Due	Cal. Interval (Months)
A2526	Attenuator	AtlanTecRF	AN18W5-20	832828#2	Calibrated before use	N/A
M260	Signal Generator	Rohde & Schwarz	SMP02	829076/008	24 Apr 2015	12
M1886	Test Receiver	Rohde & Schwarz	ESU26	100554	09 May 2015	12
M1657	Thermohygrometer	JM Handelspunkt	30.5015.13	N/A	14 Mar 2015	12

5.2.4. Occupied Bandwidth**Test Summary:**

Test Engineer:	Ian Watch	Test Dates:	25 February 2015 & 26 February 2015
Test Sample Serial Number:	F50980BB0070		

FCC Reference:	Part 2.1049
Test Method Used:	KDB 971168 D01 Section 4.2 and Notes below

Environmental Conditions:

Temperature (°C):	23 to 24
Relative Humidity (%):	38 to 49

Note(s):

1. A 20 dB attenuator and RF cable were used to connect the measurement equipment to the EUT RF ports. The combined cable and attenuator loss was measured prior to performing the measurements and the loss compensation incorporated into the measurement results. The loss appears on the result plots as an RF level offset.
2. The EUT was transmitting at maximum power with 100% duty cycle during the test.
3. The 99% occupied bandwidth function of a spectrum analyser was used to perform the measurement.
4. The spectrum analyser was connected to the RF port on the EUT using suitable attenuation and RF cable.
5. Measurement bandwidths used for testing were in the range of 1% to 5% of the occupied bandwidth. Video bandwidths used were as close to three times the measurement bandwidth as the spectrum analyser allowed.
6. All configurations supported by the device were investigated on one channel. Minimal differences in the occupied bandwidth for all supported modes in each channel bandwidth were observed. Full testing was performed on QPSK and 256QAM. Plots for other modes are not included in this test report but are archived on the UL VS LTD IT server and available for inspection if required.
7. Final measurements were performed using the above configurations on the bottom, middle and top channels. Both RF ports were tested.

Occupied Bandwidth (continued)

Test setup for occupied bandwidth measurements:

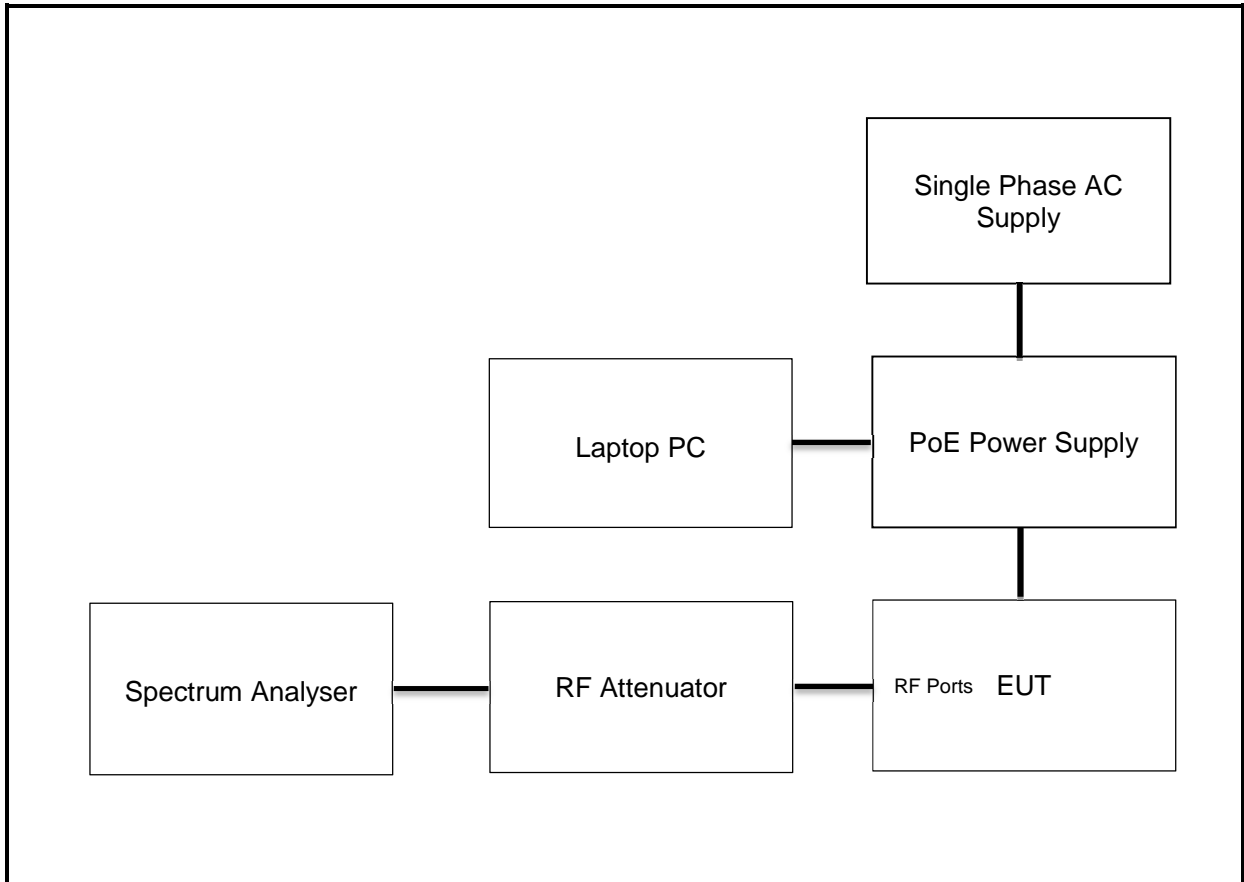

Occupied Bandwidth (continued)

Results: 5 MHz Channel / QPSK / A Port

Channel	Frequency	Modulation	Resolution Bandwidth (kHz)	Video Bandwidth (kHz)	Occupied Bandwidth (MHz)
Bottom	4942.5	QPSK	100	300	4.519
Middle	4965	QPSK	100	300	4.519
Top	4987.5	QPSK	100	300	4.503

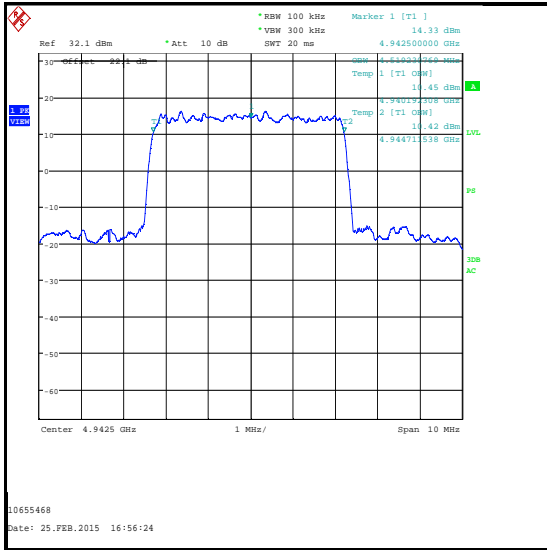

Bottom Channel

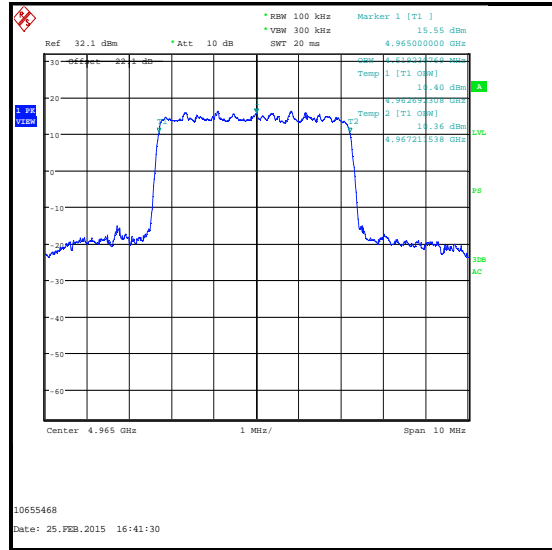

Middle Channel

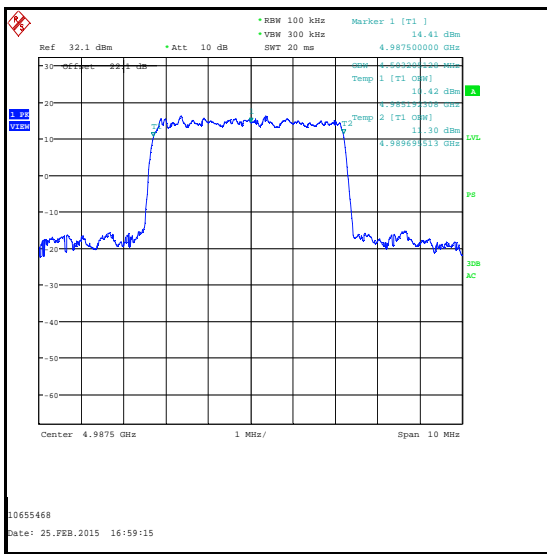

Top Channel

Occupied Bandwidth (continued)

Results: 5 MHz Channel / QPSK / B Port

Channel	Frequency	Modulation	Resolution Bandwidth (kHz)	Video Bandwidth (kHz)	Occupied Bandwidth (MHz)
Bottom	4942.5	QPSK	100	300	4.519
Middle	4965	QPSK	100	300	4.503
Top	4987.5	QPSK	100	300	4.503

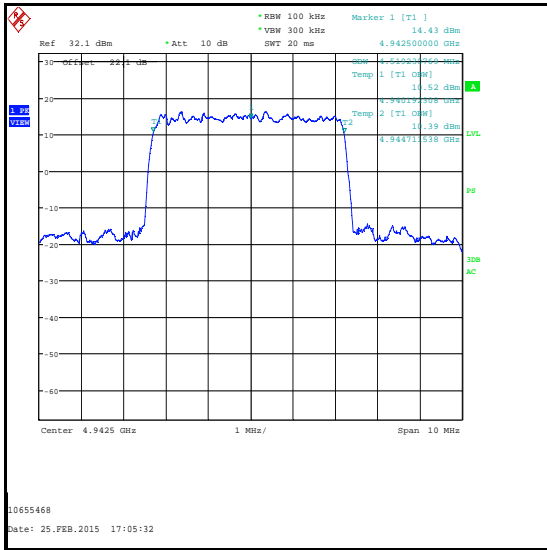

Bottom Channel

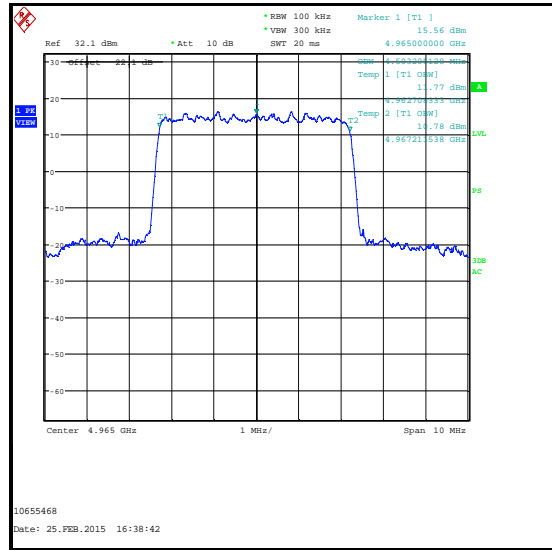

Middle Channel

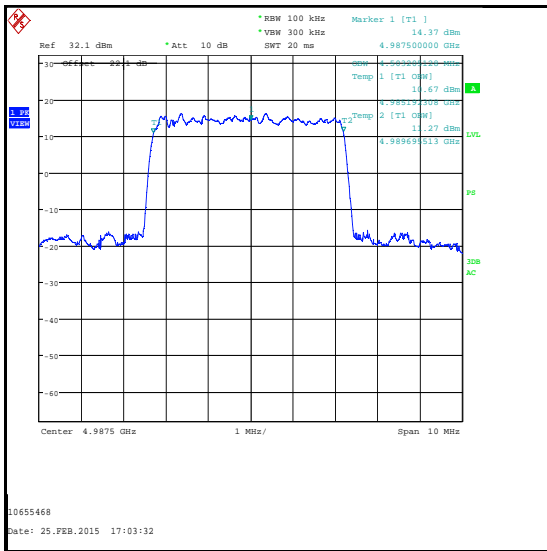

Top Channel

Occupied Bandwidth (continued)

Results: 10 MHz Channel Bandwidth / QPSK / A Port

Channel	Frequency	Modulation	Resolution Bandwidth (kHz)	Video Bandwidth (kHz)	Occupied Bandwidth (MHz)
Bottom	4945	QPSK	200	1000	9.038
Middle	4965	QPSK	200	1000	9.071
Top	4985	QPSK	200	1000	9.038

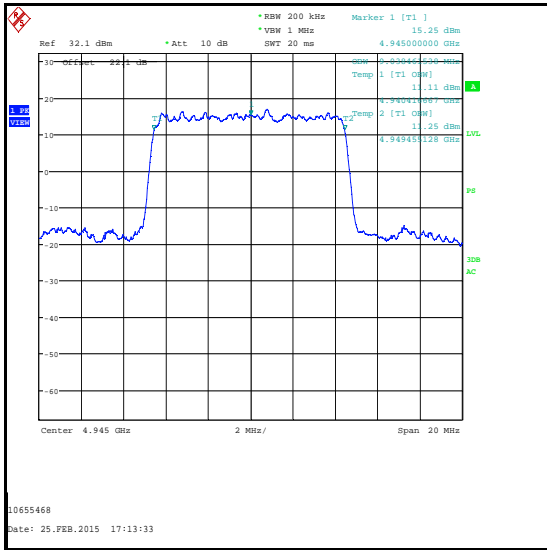

Bottom Channel

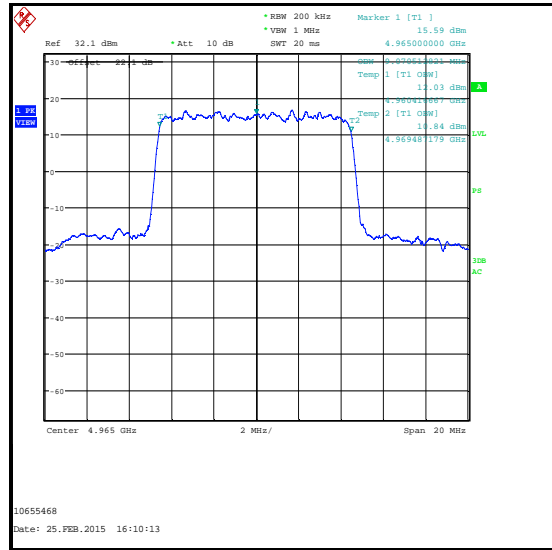

Middle Channel



Top Channel

Occupied Bandwidth (continued)

Results: 10 MHz Channel Bandwidth / QPSK / B Port

Channel	Frequency	Modulation	Resolution Bandwidth (kHz)	Video Bandwidth (kHz)	Occupied Bandwidth (MHz)
Bottom	4945	QPSK	200	1000	9.038
Middle	4965	QPSK	200	1000	9.038
Top	4985	QPSK	200	1000	9.038

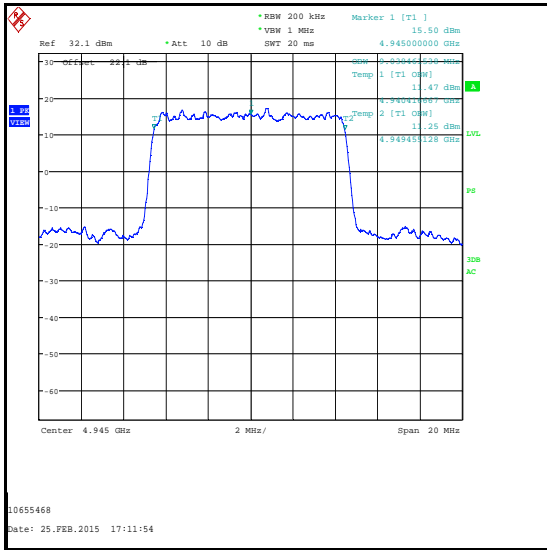

Bottom Channel

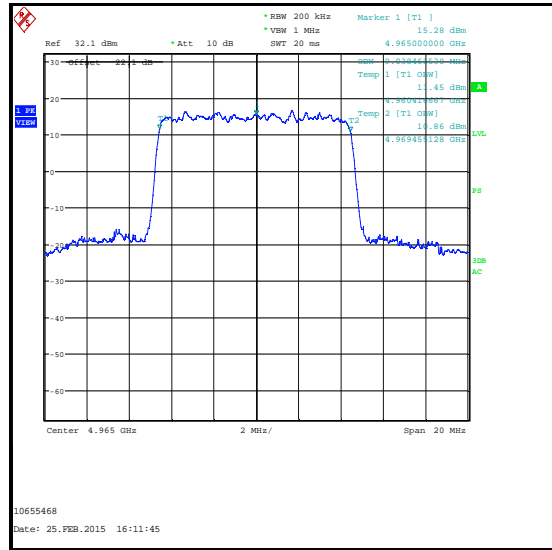

Middle Channel

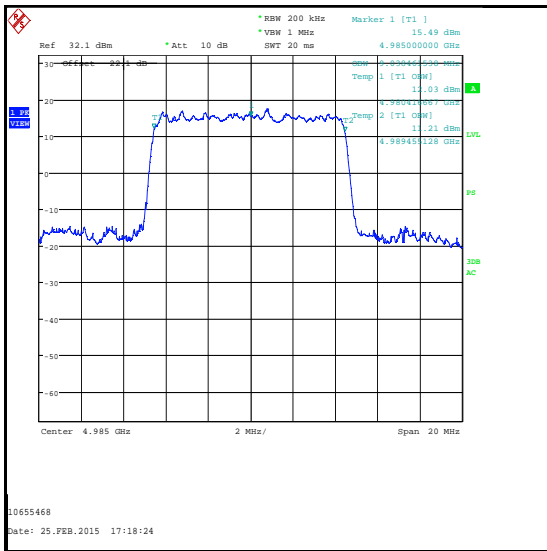

Top Channel

Occupied Bandwidth (continued)

Results: 20 MHz Channel Bandwidth / QPSK / A Port

Channel	Frequency	Modulation	Resolution Bandwidth (kHz)	Video Bandwidth (kHz)	Occupied Bandwidth (MHz)
Bottom	4950	QPSK	500	2000	18.205
Middle	4965	QPSK	500	2000	18.205
Top	4980	QPSK	500	2000	18.205

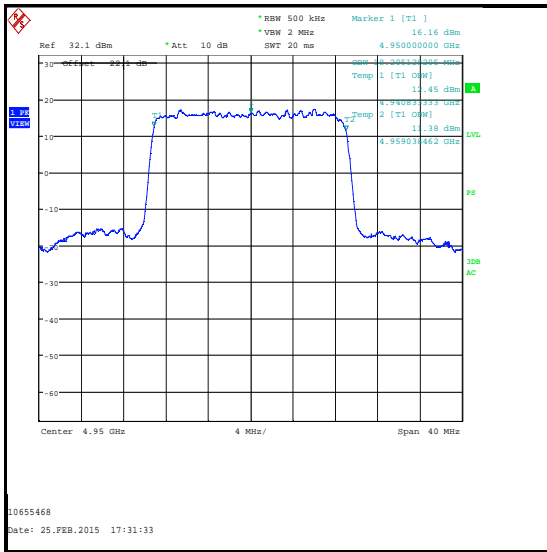

Bottom Channel

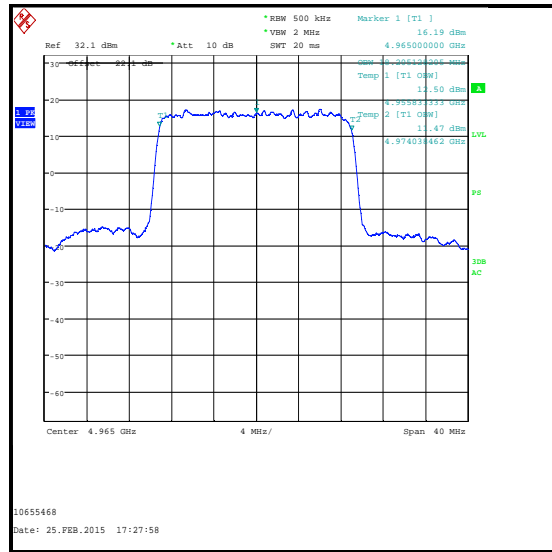

Middle Channel

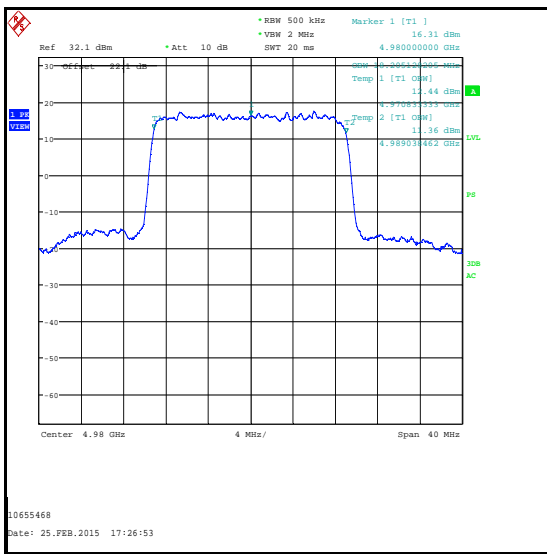

Top Channel

Occupied Bandwidth (continued)

Results: 20 MHz Channel Bandwidth / QPSK / B Port

Channel	Frequency	Modulation	Resolution Bandwidth (kHz)	Video Bandwidth (kHz)	Occupied Bandwidth (MHz)
Bottom	4950	QPSK	500	2000	18.205
Middle	4965	QPSK	500	2000	18.205
Top	4980	QPSK	500	2000	18.205

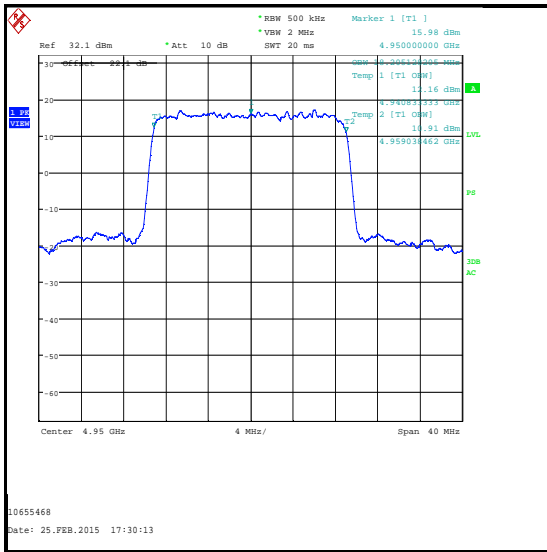

Bottom Channel

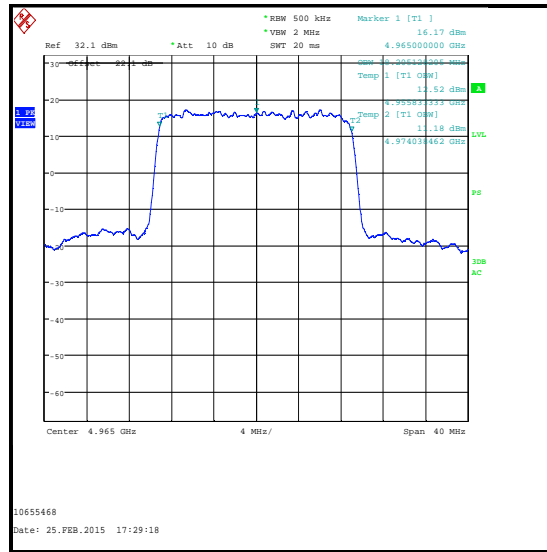

Middle Channel

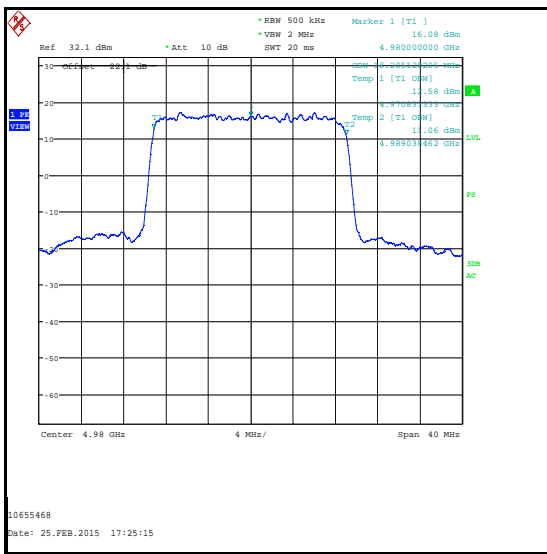

Top Channel

Occupied Bandwidth (continued)

Results: 5 MHz Channel / 256QAM / A Port

Channel	Frequency	Modulation	Resolution Bandwidth (kHz)	Video Bandwidth (kHz)	Occupied Bandwidth (MHz)
Bottom	4942.5	256QAM	100	300	4.519
Middle	4965	256QAM	100	300	4.519
Top	4987.5	256QAM	100	300	4.519

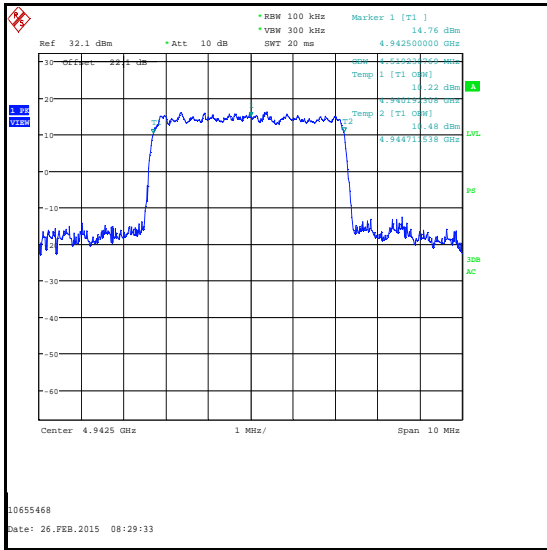

Bottom Channel

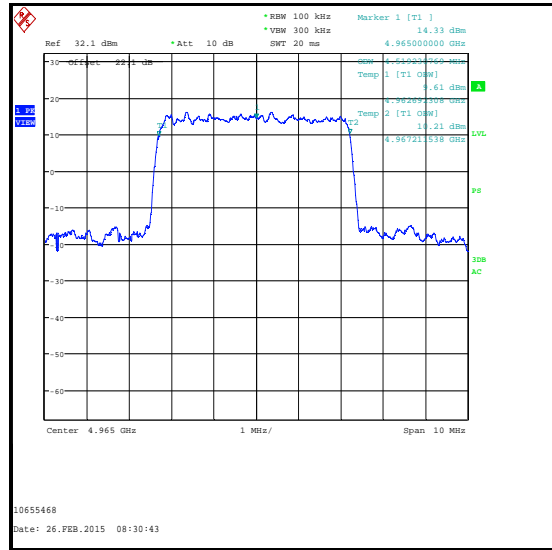

Middle Channel

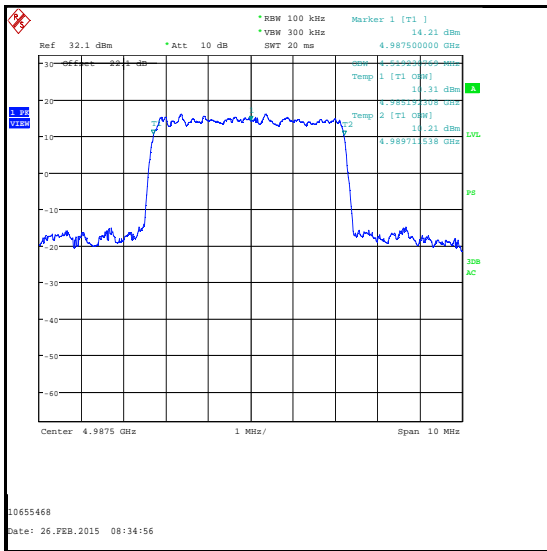

Top Channel

Occupied Bandwidth (continued)

Results: 5 MHz Channel / 256QAM / B Port

Channel	Frequency	Modulation	Resolution Bandwidth (kHz)	Video Bandwidth (kHz)	Occupied Bandwidth (MHz)
Bottom	4942.5	256QAM	100	300	4.519
Middle	4965	256QAM	100	300	4.519
Top	4987.5	256QAM	100	300	4.519

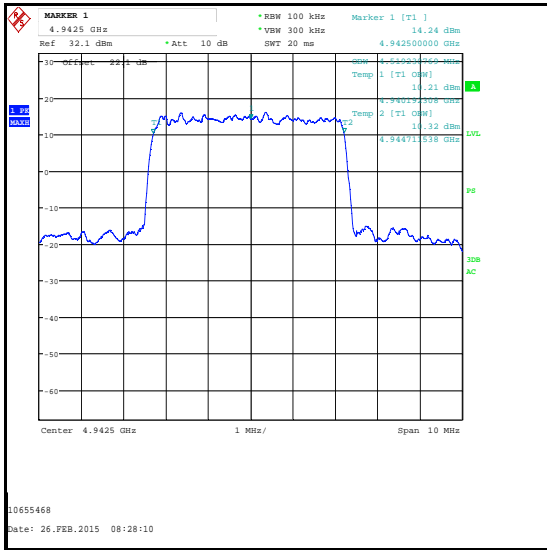

Bottom Channel

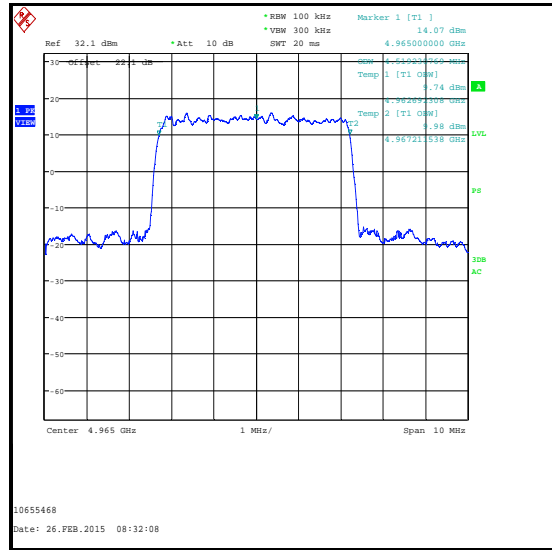

Middle Channel

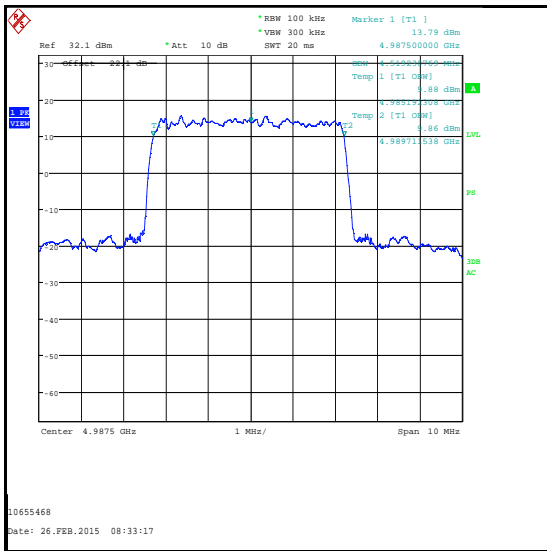

Top Channel

Occupied Bandwidth (continued)

Results: 10 MHz Channel Bandwidth / 256QAM / A Port

Channel	Frequency	Modulation	Resolution Bandwidth (kHz)	Video Bandwidth (kHz)	Occupied Bandwidth (MHz)
Bottom	4945	256QAM	200	1000	9.103
Middle	4965	256QAM	200	1000	9.071
Top	4985	256QAM	200	1000	9.071

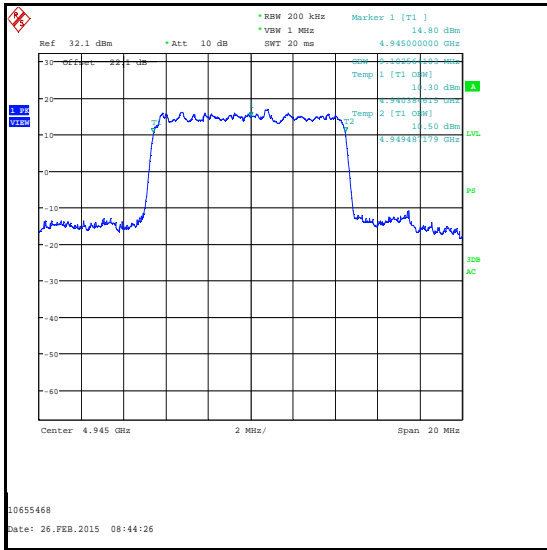

Bottom Channel

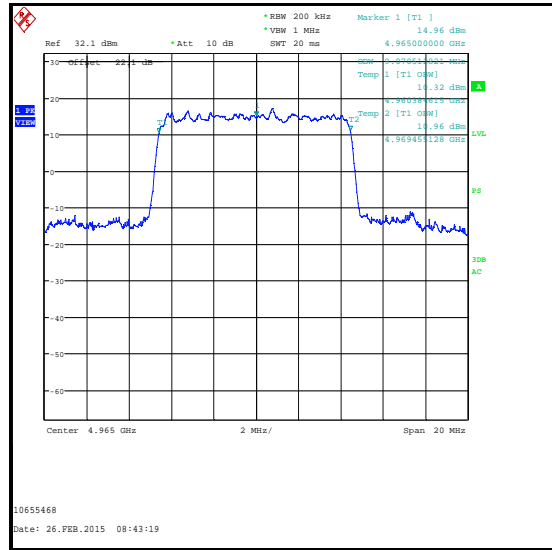

Middle Channel

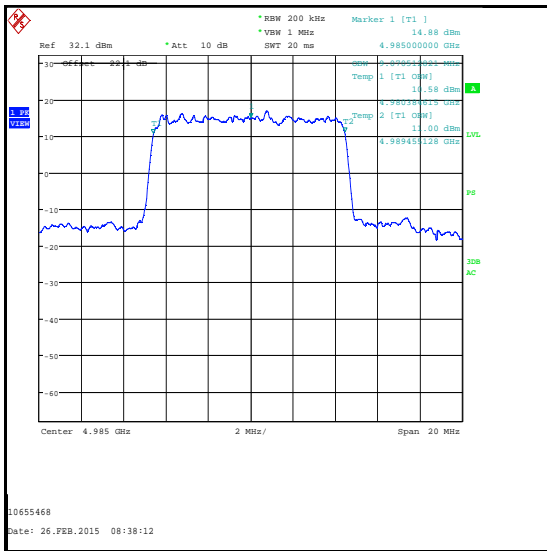

Top Channel

Occupied Bandwidth (continued)

Results: 10 MHz Channel Bandwidth / 256QAM / B Port

Channel	Frequency	Modulation	Resolution Bandwidth (kHz)	Video Bandwidth (kHz)	Occupied Bandwidth (MHz)
Bottom	4945	256QAM	200	1000	9.038
Middle	4965	256QAM	200	1000	9.071
Top	4985	256QAM	200	1000	9.071

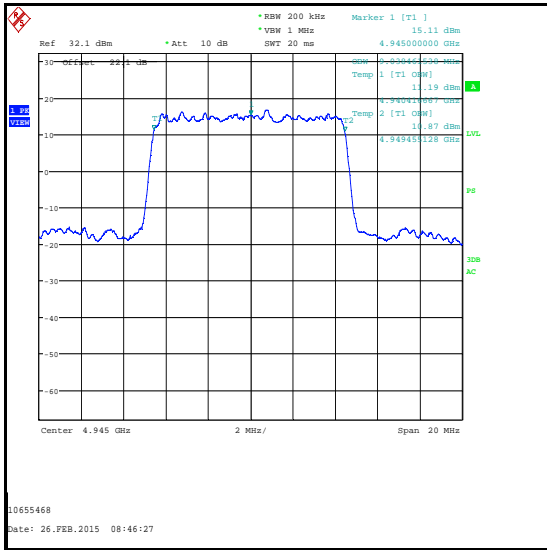

Bottom Channel

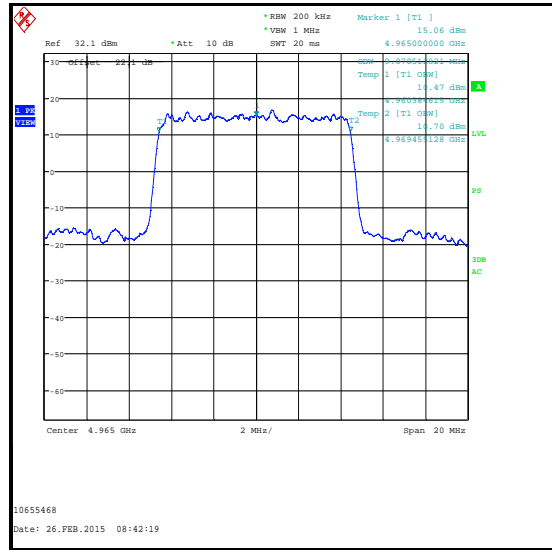

Middle Channel



Top Channel

Occupied Bandwidth (continued)

Results: 20 MHz Channel Bandwidth / 256QAM / A Port

Channel	Frequency	Modulation	Resolution Bandwidth (kHz)	Video Bandwidth (kHz)	Occupied Bandwidth (MHz)
Bottom	4950	256QAM	500	2000	18.205
Middle	4965	256QAM	500	2000	18.205
Top	4980	256QAM	500	2000	18.205

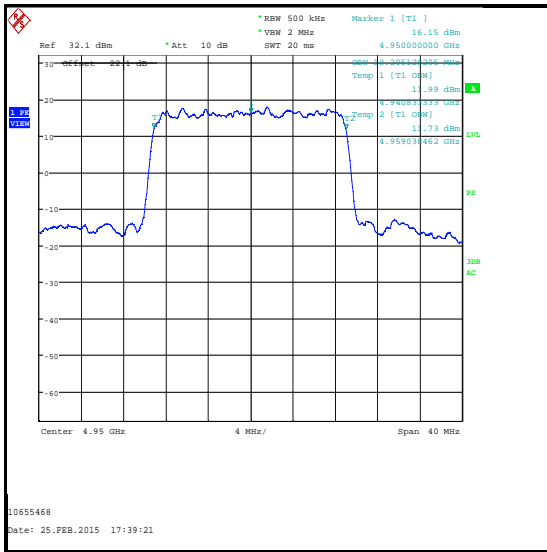

Bottom Channel



Middle Channel

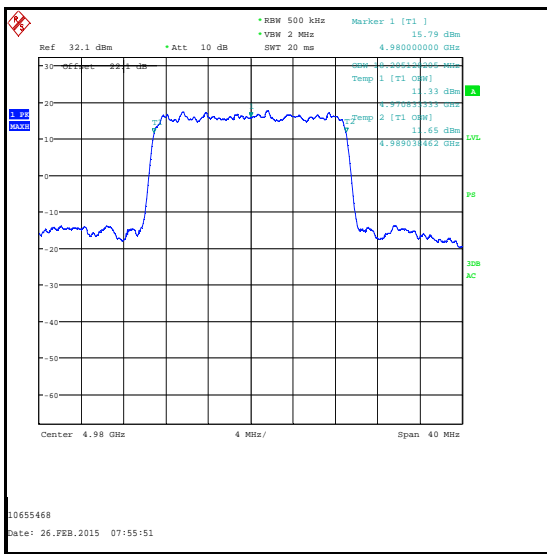

Top Channel

Occupied Bandwidth (continued)

Results: 20 MHz Channel Bandwidth / 256QAM / B Port

Channel	Frequency	Modulation	Resolution Bandwidth (kHz)	Video Bandwidth (kHz)	Occupied Bandwidth (MHz)
Bottom	4950	256QAM	500	2000	18.205
Middle	4965	256QAM	500	2000	18.205
Top	4980	256QAM	500	2000	18.205



Bottom Channel



Middle Channel



Top Channel

Occupied Bandwidth (continued)**Test Equipment Used:**

Asset No.	Instrument	Manufacturer	Type No.	Serial No.	Date Calibration Due	Cal. Interval (Months)
A2526	Attenuator	AtlanTecRF	AN18W5-20	832828#2	Calibrated before use	N/A
M260	Signal Generator	Rohde & Schwarz	SMP02	829076/008	24 Apr 2015	12
M1886	Test Receiver	Rohde & Schwarz	ESU26	100554	09 May 2015	12
M1657	Thermohygrometer	JM Handelspunkt	30.5015.13	N/A	14 Mar 2015	12

5.2.5. Conducted Emission Mask**Test Summary:**

Test Engineer:	Ian Watch	Test Dates:	27 February 2015 & 05 March 2015
Test Sample Serial Number:	F50980BB0070		

FCC Reference:	Part 90.210(m) / 2.1051
Test Method Used:	Part 90.210(m)(7) and Notes below

Environmental Conditions:

Temperature (°C):	22 to 23
Relative Humidity (%):	31 to 42

Note(s):

1. A 20 dB attenuator and RF cable were used to connect the measurement equipment to the EUT RF ports. The combined cable and attenuator loss was measured prior to performing the measurements and the loss compensation incorporated into the measurement results. The loss appears on the result plots as an RF level offset.
2. Part 90.210 emissions mask M was applied to all measurements.
3. The measurement was performed with the EUT antenna port connected to a spectrum analyser via suitable attenuation and RF cable. The power of the modulated signal was measured on a spectrum analyser using an RMS detector. The spectrum analyser sweep count was set to 100. The mask was referenced to the peak of the carrier.
4. Full testing was performed on the A port and the results are shown in this section of the test report. Sample tests on the B port confirmed that the performance of both ports were identical. Results for the B port are not included but plots are archived on the test laboratory IT server and available for inspection if required.
5. No mask incursions were observed. According to Part 90.210(m)(6), "On any frequency removed from the assigned frequency above 150% of the authorized bandwidth: 50 dB or 55 + 10 log (P) dB, whichever is the lesser attenuation."

Conducted Emission Mask (continued)

Test setup for conducted emission measurements:

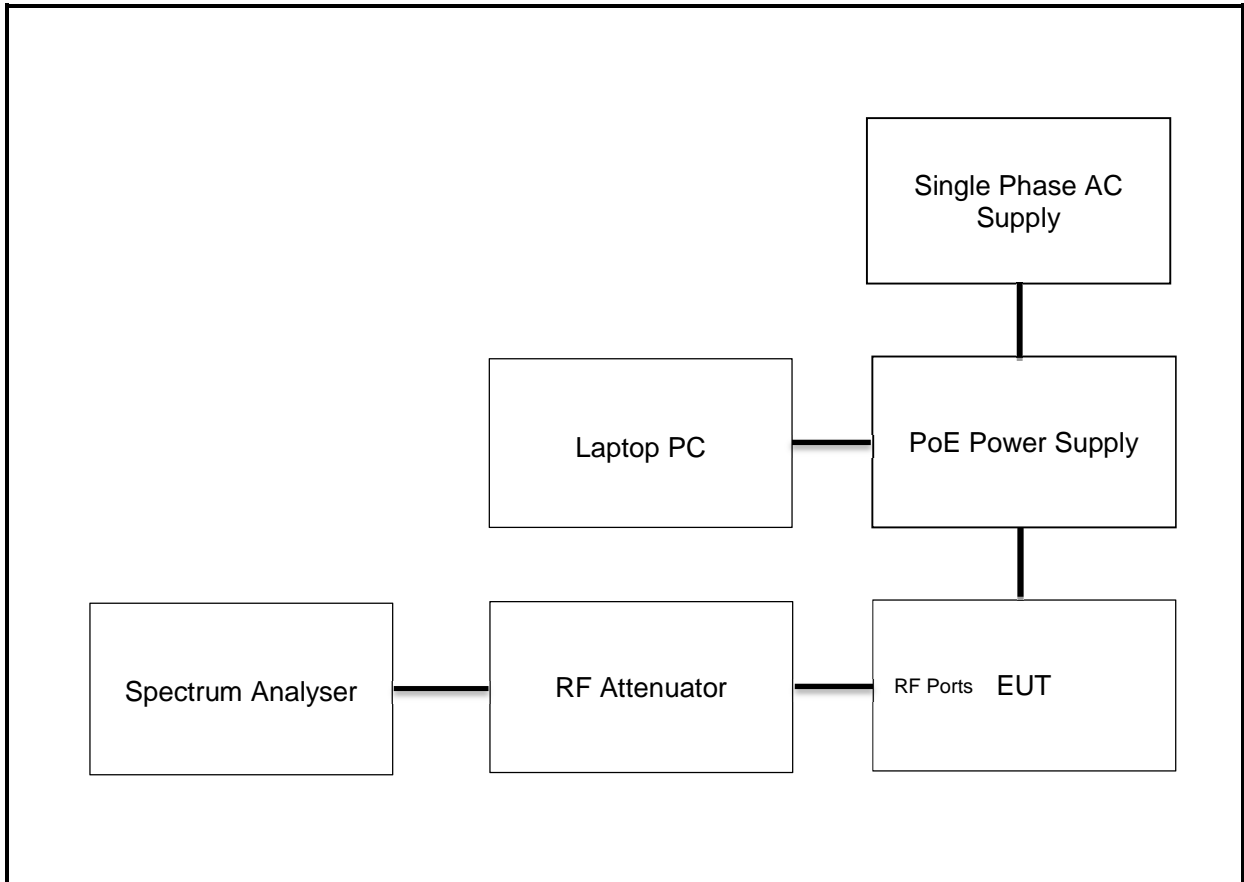

Conducted Emission Mask (continued)

Results: 5 MHz Channel Bandwidth / Bottom Channel

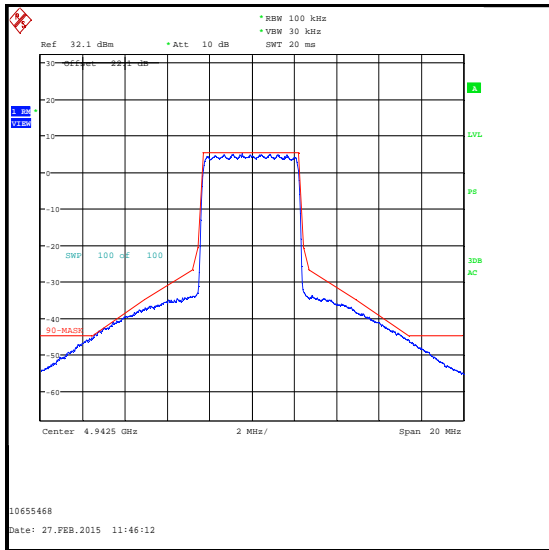

QPSK

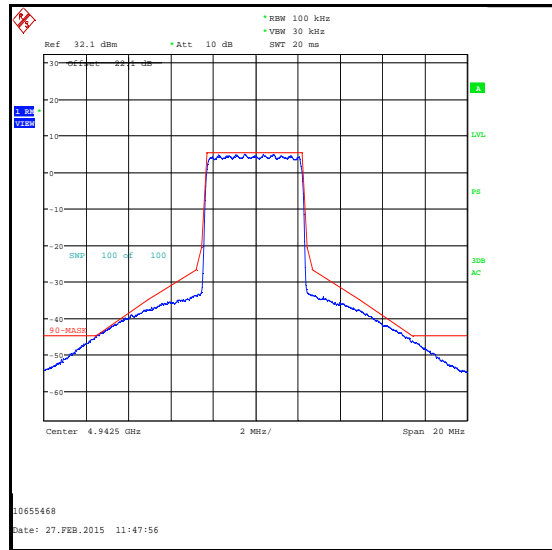

16QAM

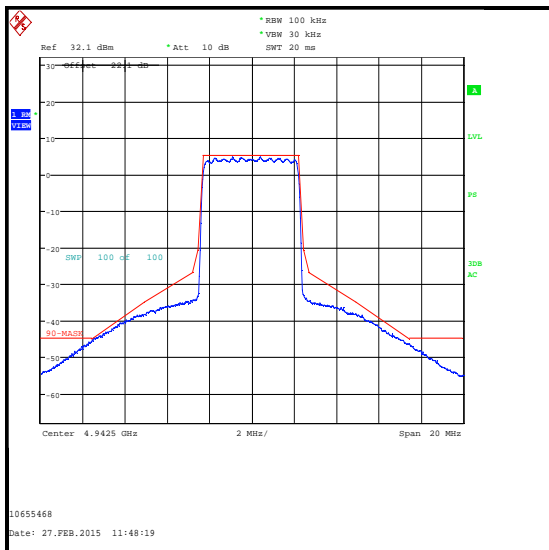

64QAM

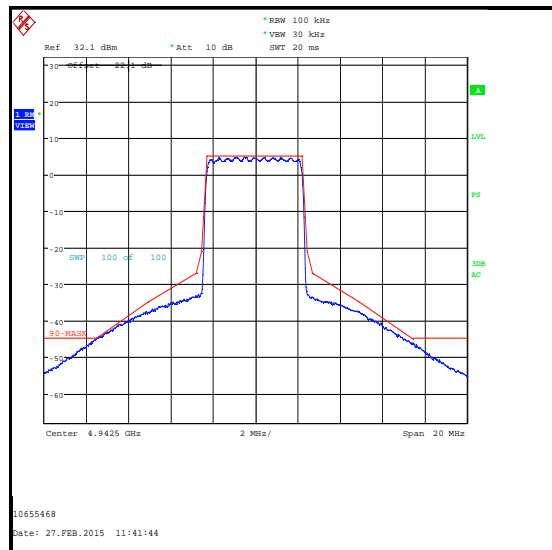

256QAM

Conducted Emission Mask (continued)

Results: 5 MHz Channel Bandwidth / Middle Channel

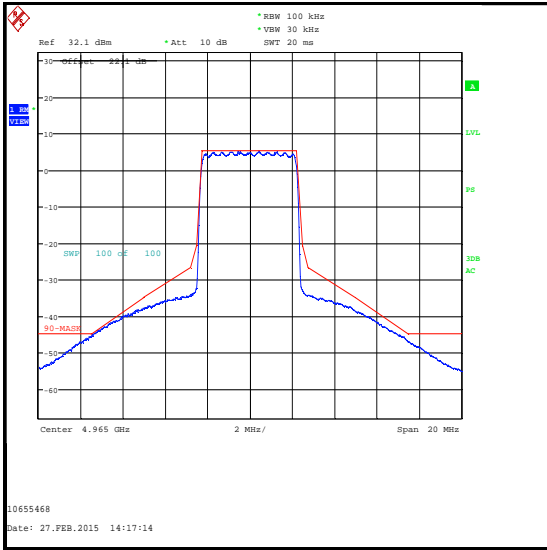

QPSK

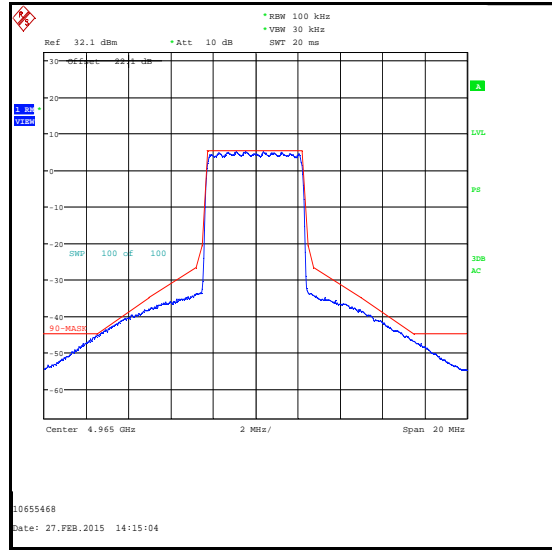

16QAM

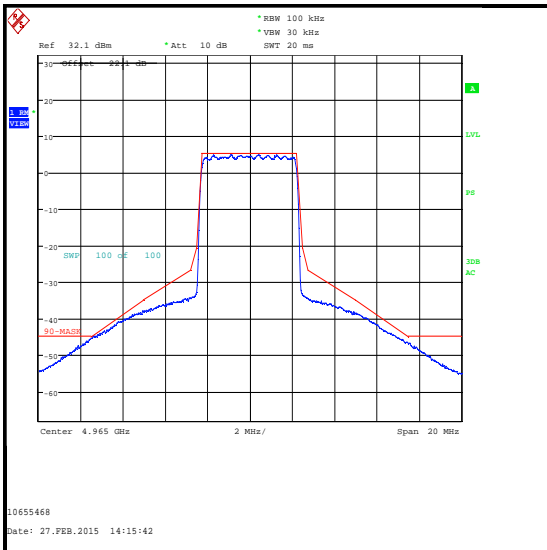

64QAM

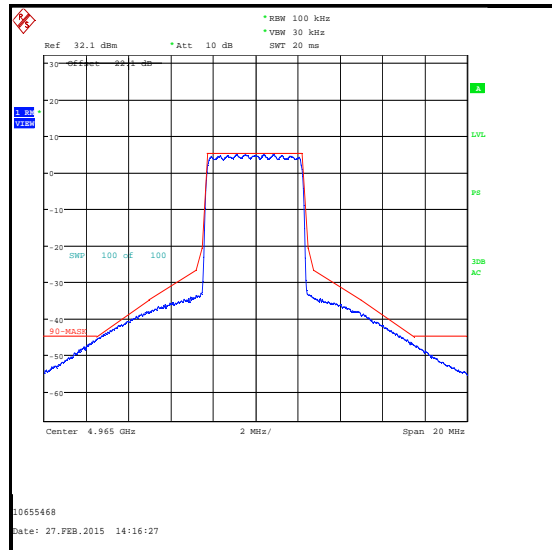

256QAM

Conducted Emission Mask (continued)

Results: 5 MHz Channel Bandwidth / Top Channel

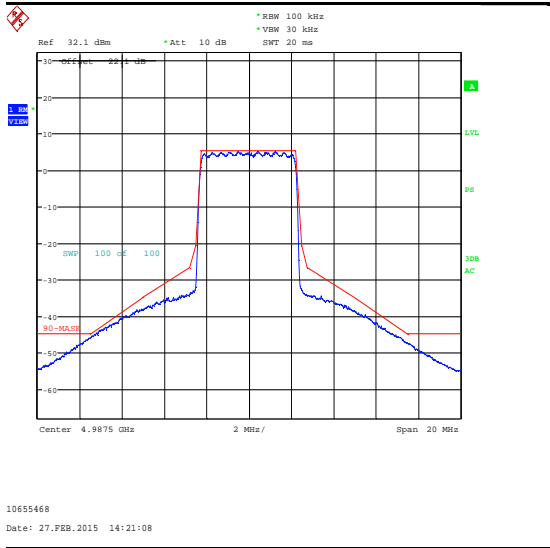

QPSK



16QAM



64QAM



256QAM

Conducted Emission Mask (continued)

Results: 10 MHz Channel Bandwidth / Bottom Channel

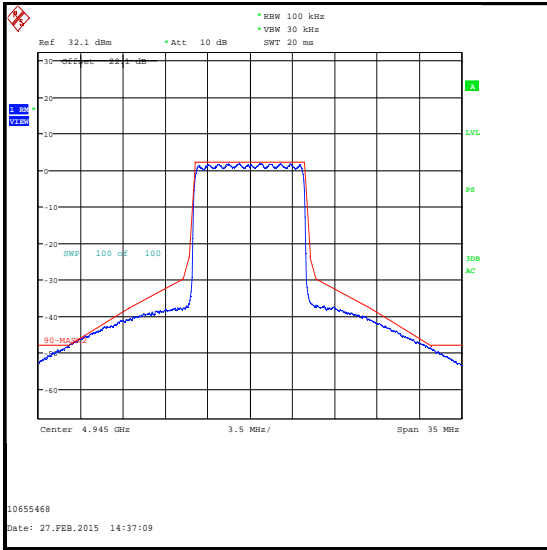

QPSK

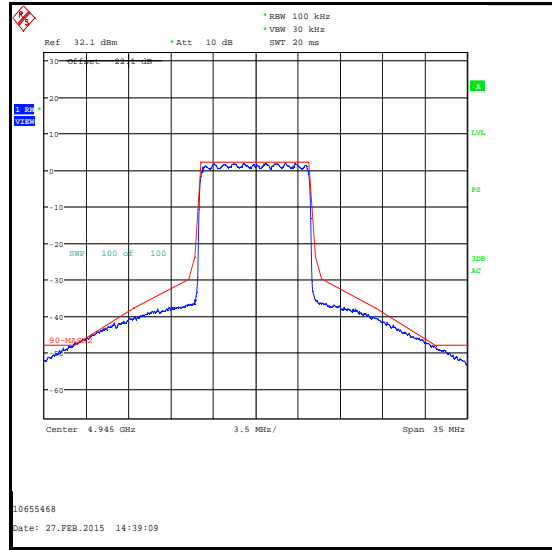

16QAM



64QAM

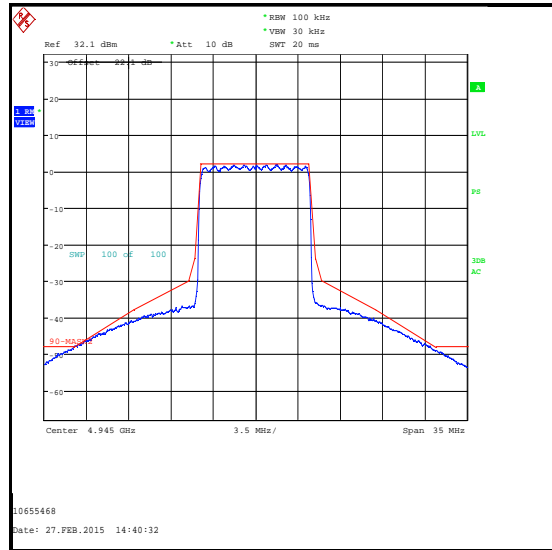

256QAM

Conducted Emission Mask (continued)

Results: 10 MHz Channel Bandwidth / Middle Channel

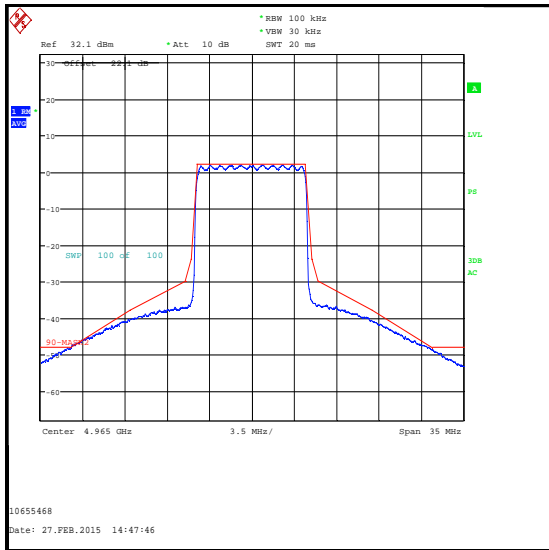

QPSK



16QAM

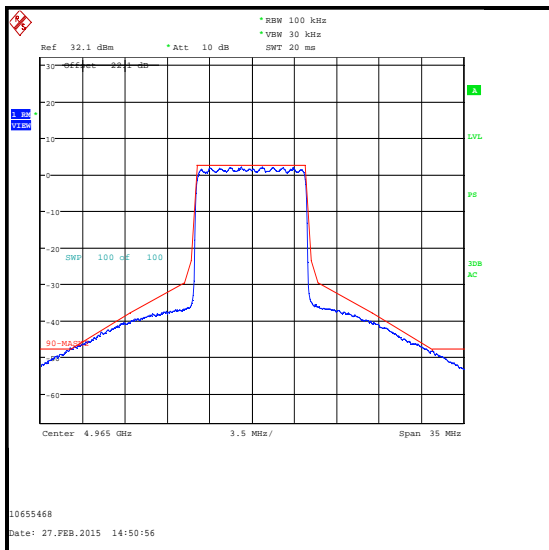

64QAM



256QAM

Conducted Emission Mask (continued)

Results: 10 MHz Channel Bandwidth / Top Channel

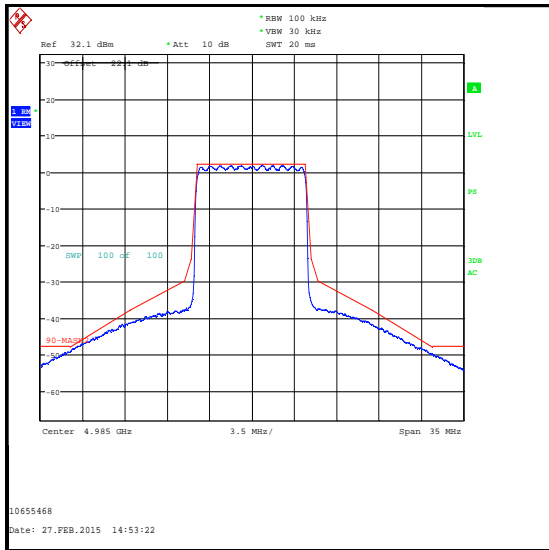

QPSK

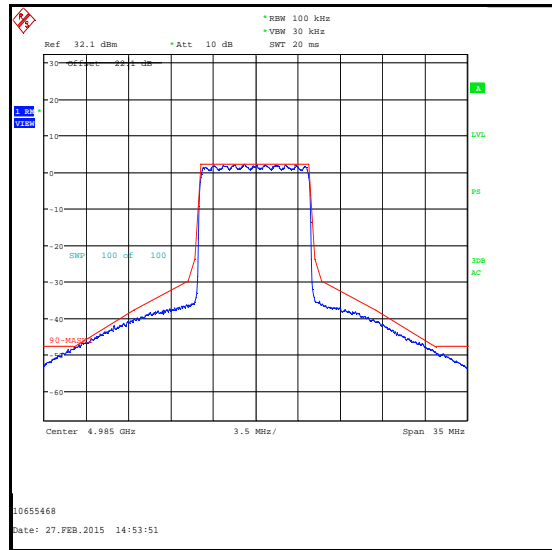

16QAM



64QAM

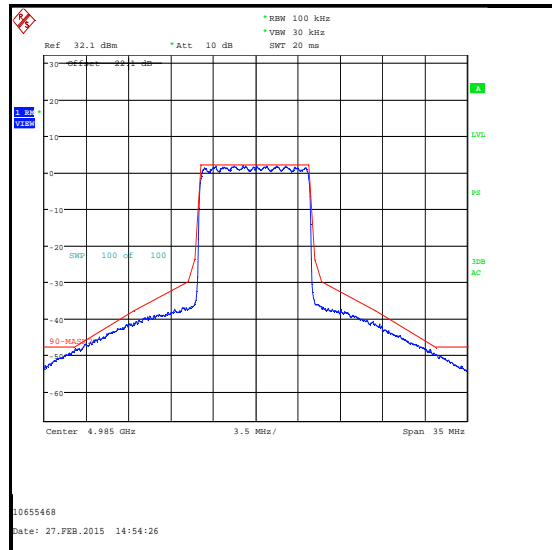

256QAM

Conducted Emission Mask (continued)

Results: 20 MHz Channel Bandwidth / Bottom Channel

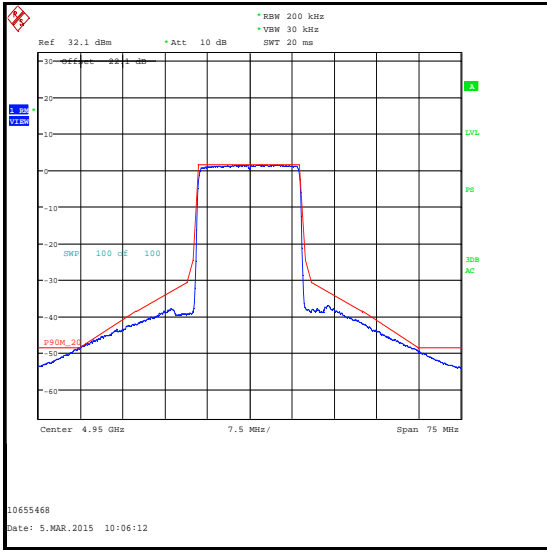

QPSK

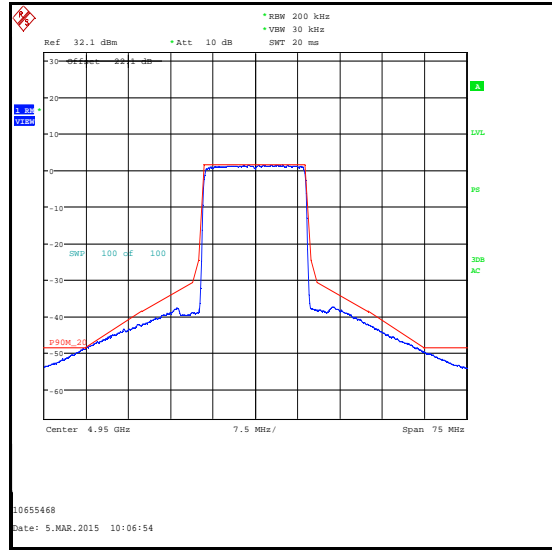

16QAM

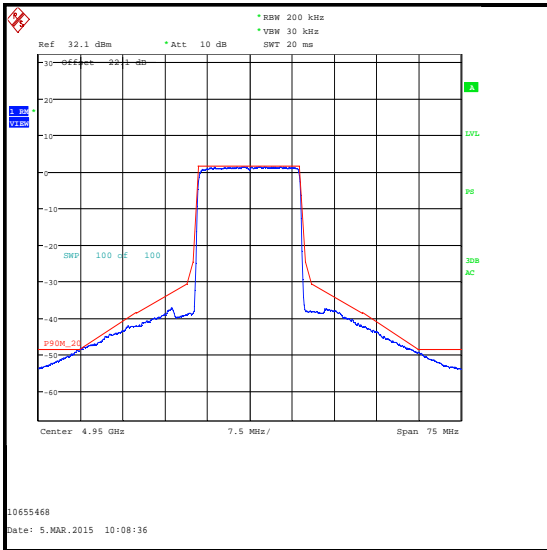

64QAM

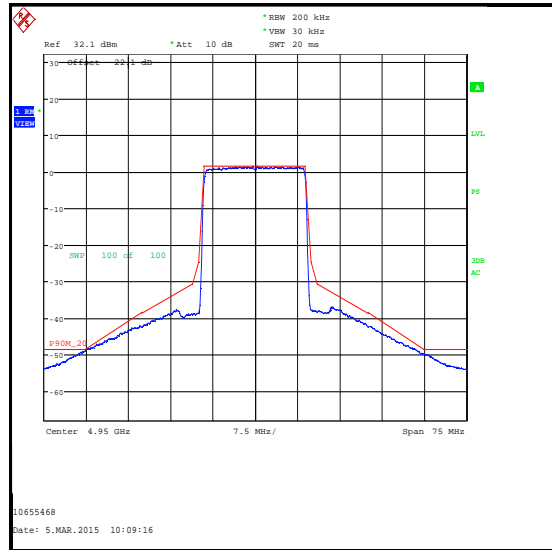

256QAM

Conducted Emission Mask (continued)

Results: 20 MHz Channel Bandwidth / Middle Channel

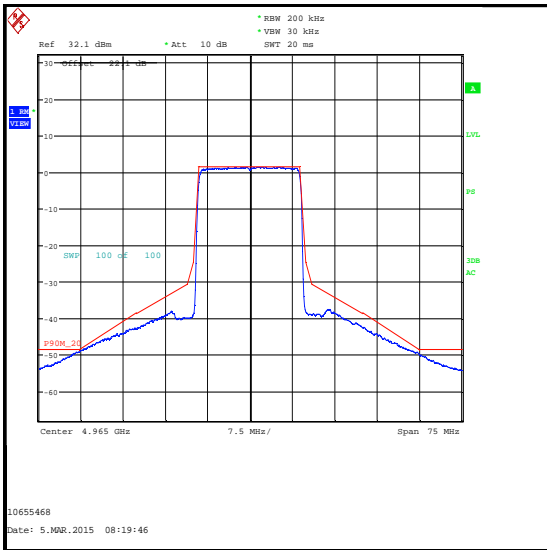

QPSK



16QAM

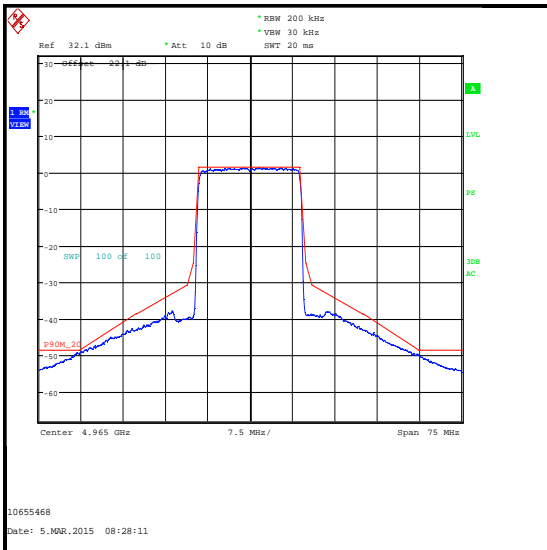

64QAM

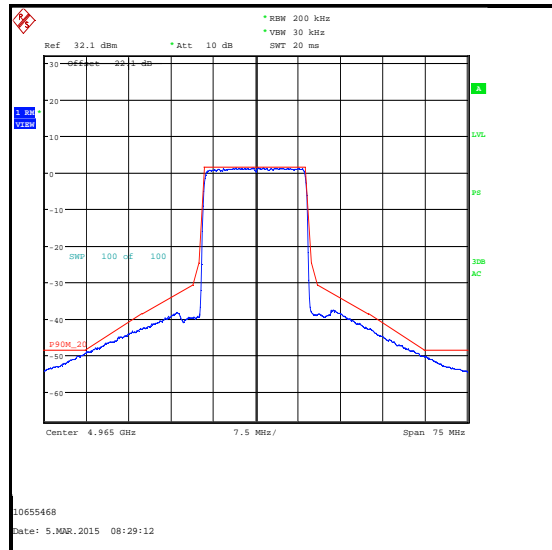

256QAM

Conducted Emission Mask (continued)

Results: 20 MHz Channel Bandwidth / Top Channel

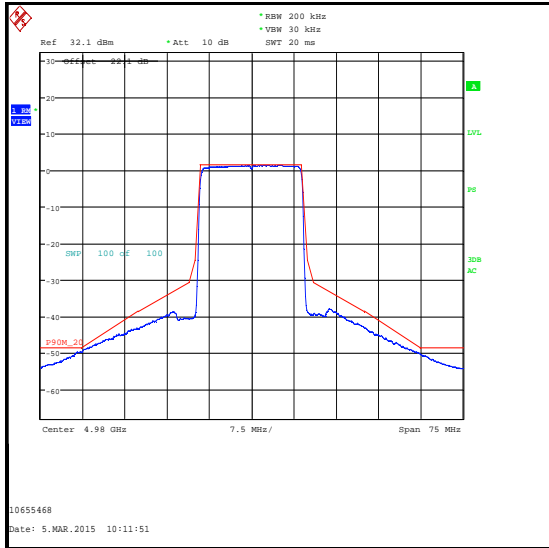

QPSK

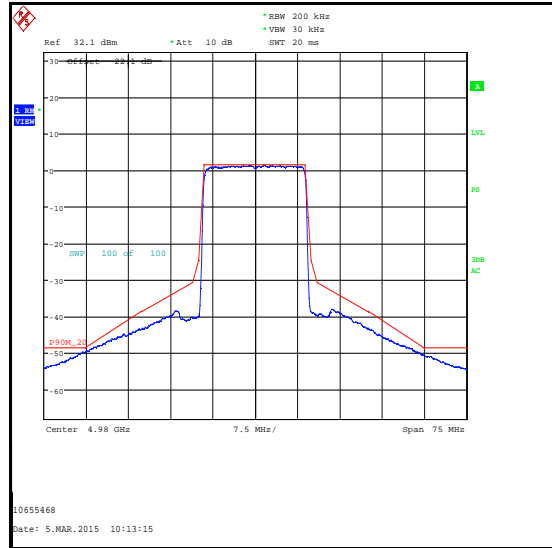

16QAM



64QAM



256QAM

Test Equipment Used:

Asset No.	Instrument	Manufacturer	Type No.	Serial No.	Date Calibration Due	Cal. Interval (Months)
A2526	Attenuator	AtlanTecRF	AN18W5-20	832828#2	Calibrated before use	N/A
M260	Signal Generator	Rohde & Schwarz	SMP02	829076/008	24 Apr 2015	12
M1886	Test Receiver	Rohde & Schwarz	ESU26	100554	09 May 2015	12
M1657	Thermohygrometer	JM Handelspunkt	30.5015.13	N/A	14 Mar 2015	12

5.2.6. Conducted Spurious Emissions**Test Summary:**

Test Engineer:	Ian Watch	Test Date:	10 March 2015
Test Sample Serial Number:	F50980BB0070		

FCC Reference:	Part 90.210(m)(6)
Test Method Used:	KDB 971168 D01 Section 6.0
Frequency Range:	9 kHz to 40 GHz

Environmental Conditions:

Temperature (°C):	26
Relative Humidity (%):	30

Note(s):

1. Pre-scans were performed with the EUT transmitting at maximum power on the middle channel.
2. The EUT was transmitting with a 5 MHz channel width and QPSK modulation as this produced the highest power level and therefore was deemed worst case.
3. All emissions were >20 dB below the applicable limit or below the level of the noise floor of the spectrum analyser. The highest level of the noise floor across the measured frequency range was recorded in the table below.

Results: 5 MHz Channel Bandwidth / Middle Channel / QPSK

Frequency (MHz)	Peak Emission Level (dBm)	Limit (dBm)	Margin (dB)	Result
27495.192	-44.0	-25.0	19.0	Complied

Conducted Spurious Emissions (continued)

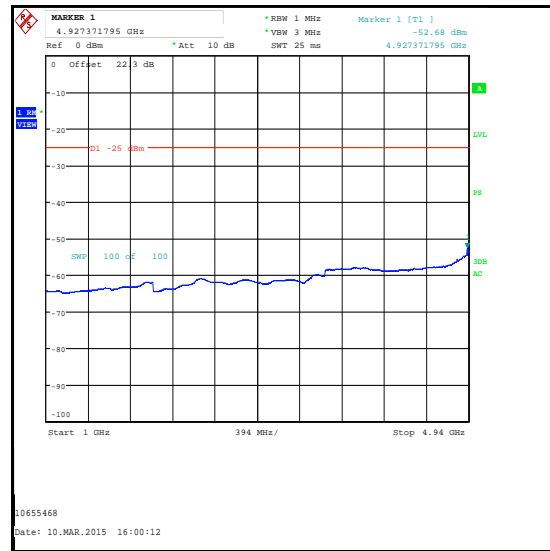
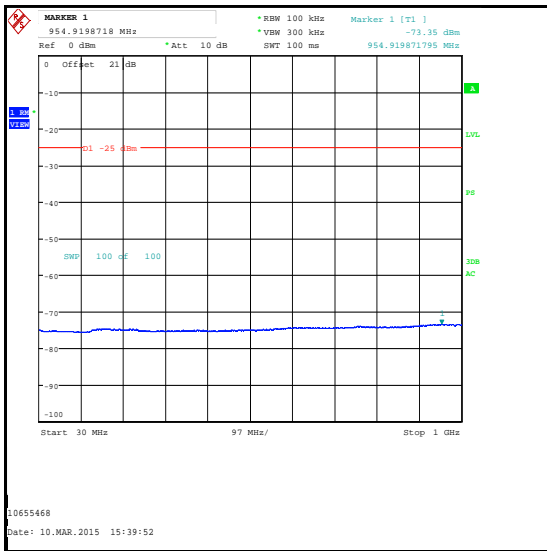
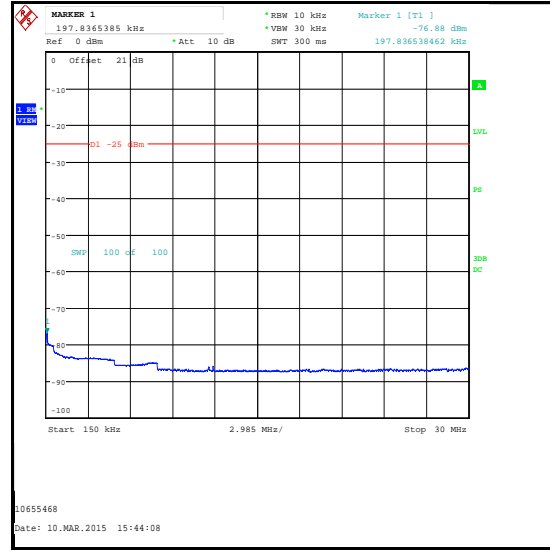
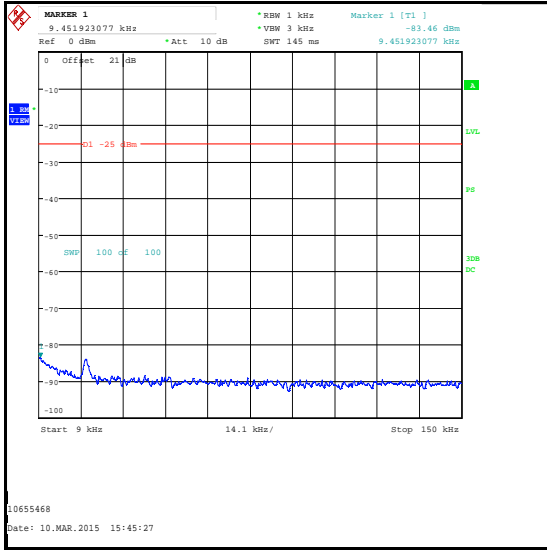

Conducted Spurious Emissions (continued)

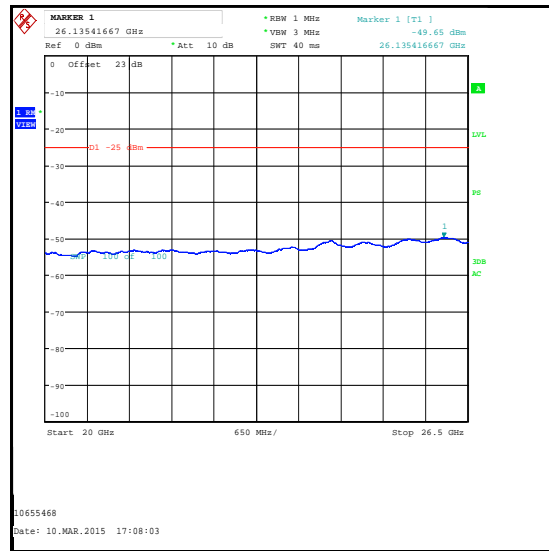
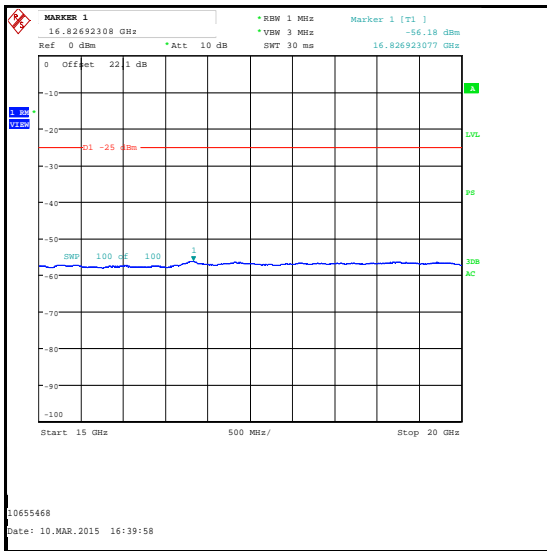
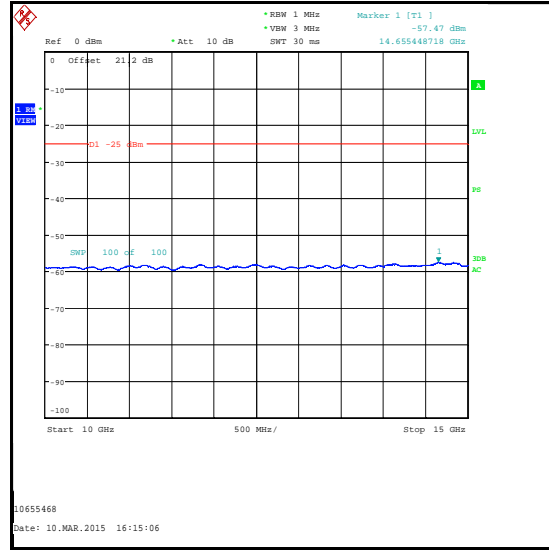
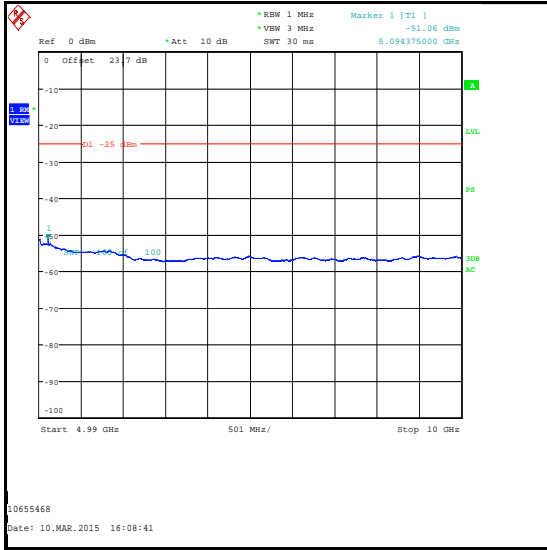

Conducted Spurious Emissions (continued)

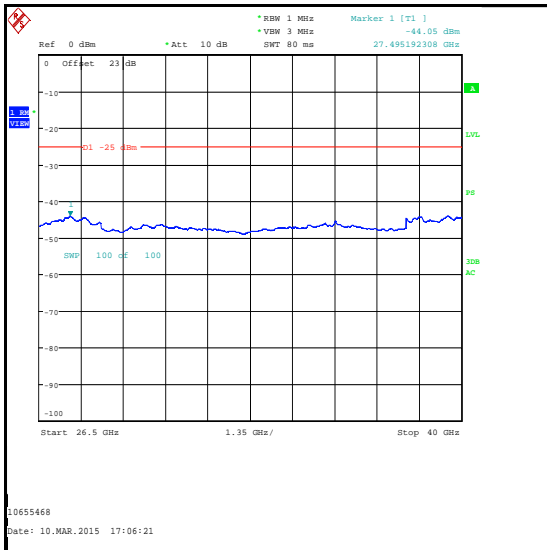

Test Equipment Used:

Asset No.	Instrument	Manufacturer	Type No.	Serial No.	Date Calibration Due	Cal. Interval (Months)
A2527	Attenuator	AtlanTecRF	AN18W5-20	832828#2	Calibrated before use	N/A
M1630	Test Receiver	Rohde & Schwarz	ESU40	100233	20 Feb 2016	12
A2632	Attenuator	Weinschel	WA75-10-12	A301	Calibrated before use	N/A
A2633	Attenuator	Weinschel	WA75-10-12	A302	Calibrated before use	N/A
M1252	Signal Generator	HP	83640A	3119A00489	15 Oct 2015	12
M260	Signal Generator	Rohde & Schwarz	SMP02	829076/008	24 Apr 2015	12
G047	Signal Generator	Rohde & Schwarz	SMY01	843215/015	14 Jul 2015	12
M1886	Test Receiver	Rohde & Schwarz	ESU26	100554	09 May 2015	12
M1657	Thermohygrometer	JM Handelspunkt	30.5015.13	N/A	14 Mar 2015	12

5.2.7. Radiated Spurious Emissions**Test Summary:**

Test Engineer:	David Doyle	Test Dates:	10 March 2015 & 11 March 2015
Test Sample Serial Number:	F50980BB0070		

FCC Reference:	Part 90.210(m)
Test Method Used:	KDB 971168 D01 Section 7.0 / ANSI C63.4-2009 Section 6.3 and Notes below

Environmental Conditions:

Temperature (°C):	22 to 23
Relative Humidity (%):	34 to 37

Note(s):

- All emissions shown on the pre-scan plots were investigated and found to be ambient or >20 dB below the applicable limit or below the measurement system noise floor. Therefore the highest level of noise floor has been recorded in the table below.**
- Antenna port conducted measurements were performed to demonstrate compliance. In addition, radiated spurious emission measurements (case radiation) were also performed in an anechoic chamber with both RF ports terminated.
- The PoE supply and controlling laptop PC were located in the ante-chamber and connected by Ethernet cable. All unused ports were terminated into an Ethernet hub.
- The EUT was transmitting using a 5 MHz channel and QPSK modulation as this produced the highest power level and therefore was deemed worst case.
- The carrier is shown on the 4 GHz to 6 GHz plot.
- Measurements below 1 GHz were performed in a semi-anechoic chamber (UL Asset Number K0001) at a distance of 3 metres. The EUT was placed at a height of 1.5 metres above the reference ground plane in the centre of the chamber turntable. Maximum emission levels were determined by height searching the measurement antenna over the range 1 metre to 4 metres.
- Pre-scans above 1 GHz were performed in a fully anechoic chamber (UL Asset Number K0002) at a distance of 3 metres. The EUT was placed at a height of 1.5 metres above the test chamber floor in the centre of the chamber turntable. All measurement antennas were placed at a fixed height of 1.5 metres above the test chamber floor, in line with the EUT. Final measurements above 1 GHz were performed in a semi-anechoic chamber (UL Asset Number K0001) at a distance of 3 metres. The EUT was placed at a height of 1.5 m above the reference ground plane in the centre of the chamber turntable. Maximum emission levels were determined by height searching the measurement antenna over the range 1 metre to 4 metres.

5 MHz Channel Bandwidth / Middle Channel / QPSK

Frequency (MHz)	Peak Level (dBm)	Limit (dBm)	Margin (dB)	Result
5939.102	-33.0	-25.0	8.0	Complied

Radiated Spurious Emissions (continued)

Test setup for radiated measurements:

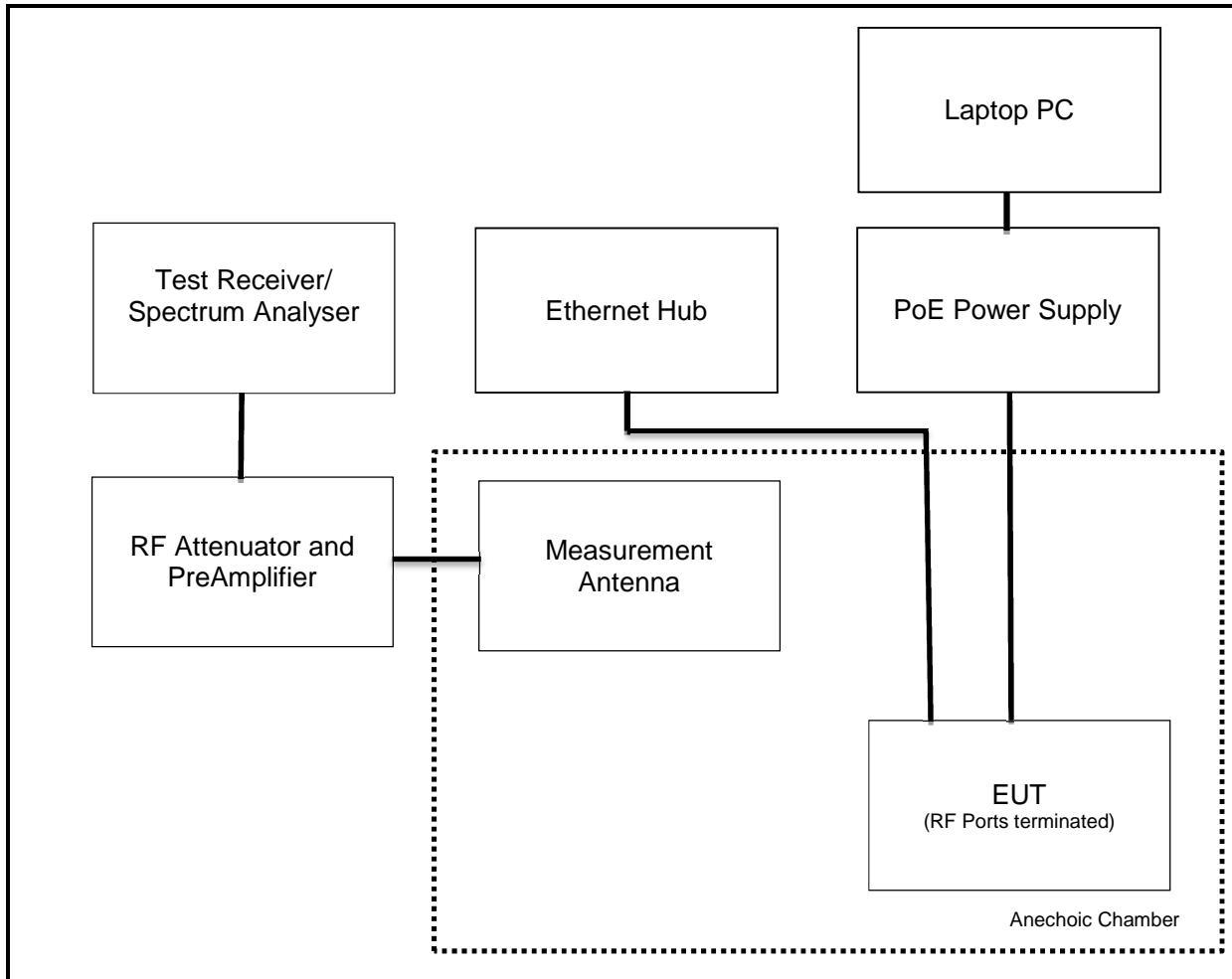

Radiated Spurious Emissions (continued)

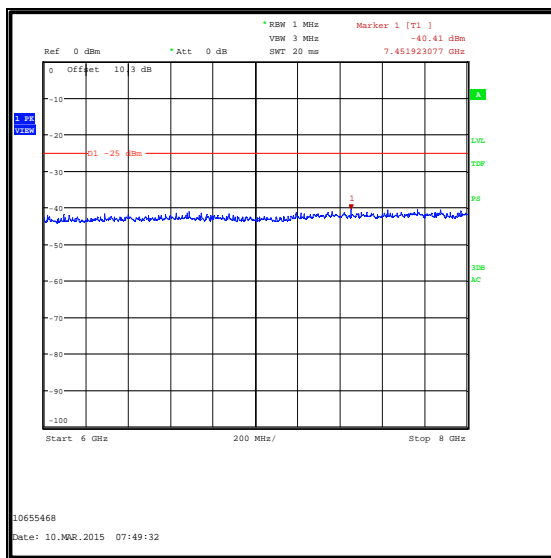
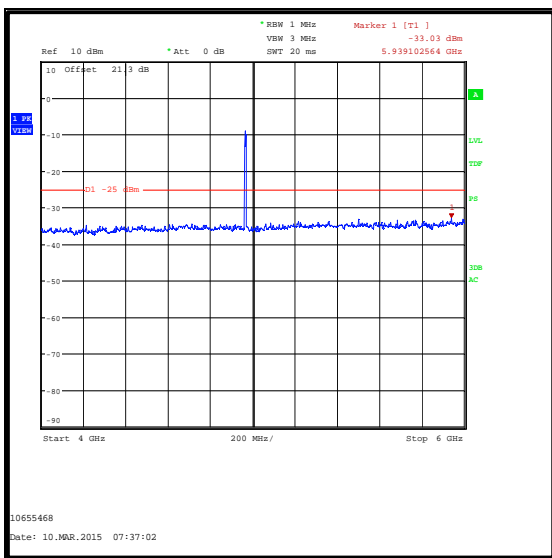
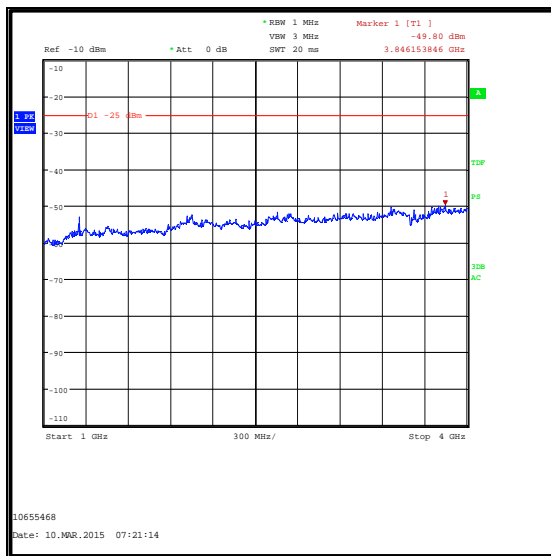
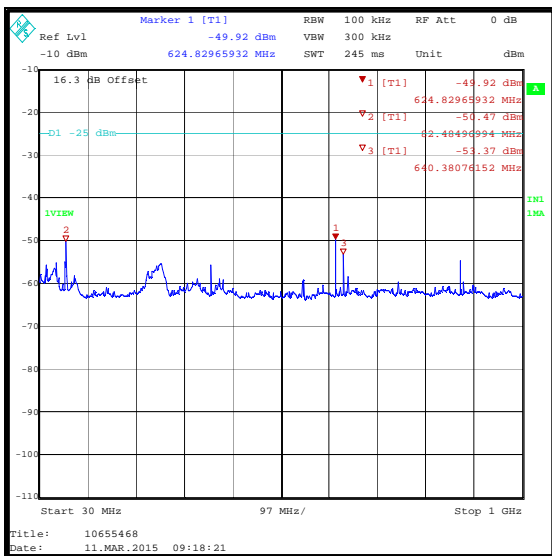

Radiated Spurious Emissions (continued)

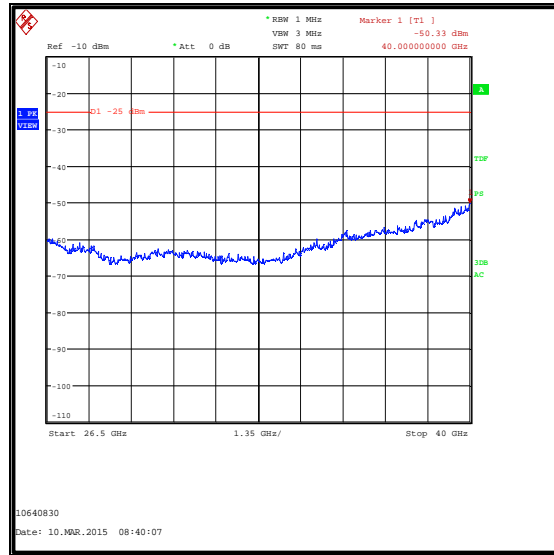
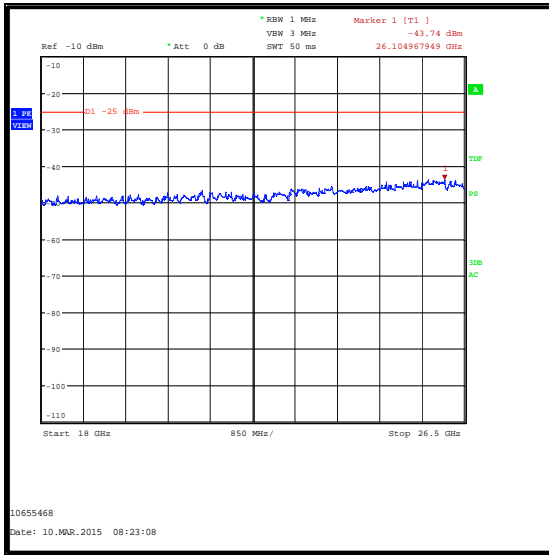
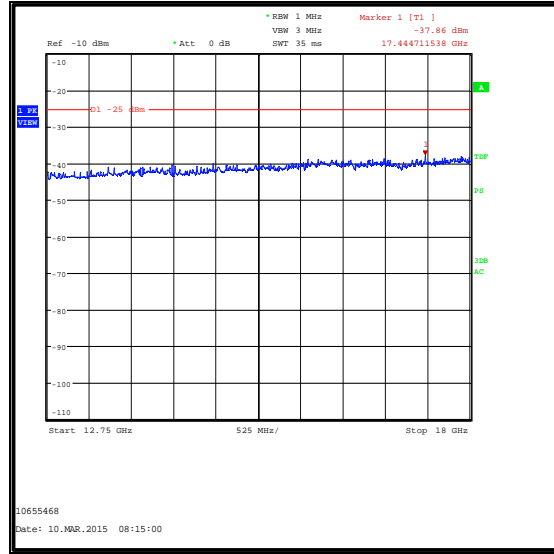
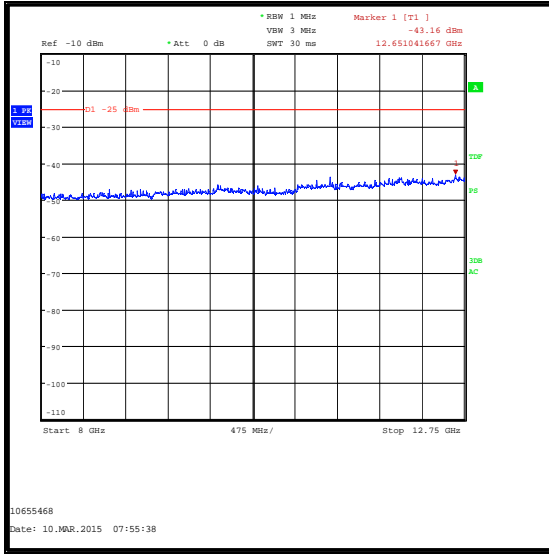

Radiated Spurious Emissions (continued)**Test Equipment Used:**

Asset No.	Instrument	Manufacturer	Type No.	Serial No.	Date Calibration Due	Cal. Interval (Months)
K0001	5m RSE Chamber	Rainford EMC	N/A	N/A	26 Mar 2015	12
M1624	Thermohygrometer	JM Handelspunkt	30.5015.10	Not stated	07 Jan 2016	12
M1379	Test Receiver	Rohde & Schwarz	ESIB7	100330	08 Dec 2015	12
G0543	Pre Amplifier	Sonoma	310N	230801	05 Jun 2015	3
A2132	Low Pass Filter	AtlanTecRF	AFL-03000	300192	25 Apr 2015	12
K0002	3m RSE Chamber	Rainford EMC	N/A	N/A	31 Mar 2015	12
M1656	Thermohygrometer	JM Handelspunkt	30.5015.13	Not stated	14 Mar 2015	12
A1534	Pre Amplifier	Hewlett Packard	8449B	3008A00405	21 Dec 2015	12
M1874	Test Receiver	Rohde & Schwarz	ESU26	100553	13 May 2015	12
M1630	Test Receiver	Rohde & Schwarz	ESU40	100233	20 Feb 2016	12
A1396	Attenuator	Huber & Suhner	6810.17.B	757987	02 May 2015	12
A2140	Attenuator	AtlanTecRF	AN18-10	090918-04	25 Apr 2015	12
A288	Antenna	Chase	CBL6111A	1589	21 Aug 2015	12
A1818	Antenna	EMCO	3115	00075692	20 Dec 2015	12
A253	Antenna	Flann Microwave	12240-20	128	20 Dec 2015	12
A254	Antenna	Flann Microwave	14240-20	139	20 Dec 2015	12
A255	Antenna	Flann Microwave	16240-20	519	20 Dec 2015	12
A256	Antenna	Flann Microwave	18240-20	400	20 Dec 2015	12
A436	Antenna	Flann Microwave	20240-20	330	21 Dec 2015	12
A203	WG 22 Microwave Horn	Flann Microwave	22240-20	343	19 May 2016	36
A1785	26.5 GHz to 40 GHz Pre-amplifier	Farran Technology	FLNA-28-30	FTL 6483	Calibrated before use	N/A

5.2.8. Frequency Stability (Temperature Variation)**Test Summary:**

Test Engineer:	Ian Watch	Test Date:	13 March 2015
Test Sample Serial Number:	F50980BB0070		

FCC Reference:	Parts 90.213 & 2.1055
Test Method Used:	ANSI TIA-603-C-2004 Section 2.2.2. FCC Part 2.1055 / KDB 971168 D01 Section 9.0. and Notes below

Environmental Conditions:

Ambient Temperature (°C):	23 to 23
Ambient Relative Humidity (%):	20 to 25

Note(s):

1. Frequency stability was measured using the frequency count function of a spectrum analyser.
2. The EUT was configured to continuously transmit a CW signal at maximum power during the test.
3. Temperature was monitored throughout the test with a calibrated digital thermometer.
4. The manufacturer declared the frequency stability as ≤ 10 ppm.

Frequency Stability (Temperature Variation)(continued)

Test setup for frequency stability measurements:

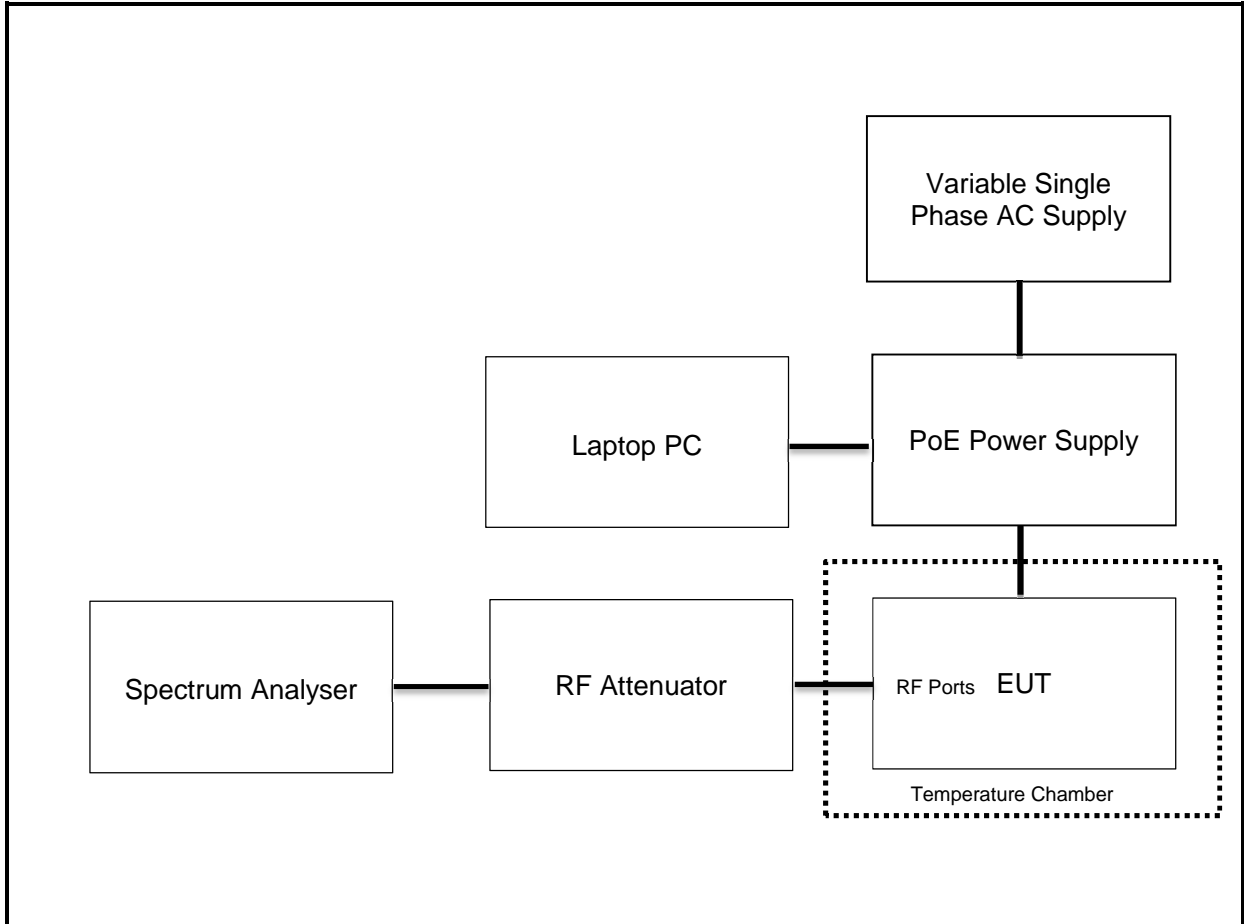

Frequency Stability (Temperature Variation)(continued)**Results:**

Temperature (°C)	Measured Frequency (MHz)	Frequency Error (Hz)	Frequency Error (ppm)	Limit (ppm)	Margin (ppm)	Result
-30	4987.501032	1032	0.2069	10	9.7931	Complied
-20	4987.499285	715	0.1434	10	9.8566	Complied
-10	4987.503424	3424	0.6865	10	9.3135	Complied
0	4987.499570	430	0.0862	10	9.9138	Complied
10	4987.498462	1538	0.3084	10	9.6916	Complied
20	4987.498555	1445	0.2897	10	9.7103	Complied
30	4987.488905	11095	2.2246	10	7.7754	Complied
40	4987.496977	3023	0.6061	10	9.3939	Complied
50	4987.507048	7048	1.4131	10	8.5869	Complied

Test Equipment Used:

Asset No.	Instrument	Manufacturer	Type No.	Serial No.	Date Calibration Due	Cal. Interval (Months)
M1784	Thermohygrometer	JM Handelspunkt	30.5015.13	Not stated	21 Mar 2015	12
M1886	Test Receiver	Rohde & Schwarz	ESU26	100554	09 May 2015	12
M1642	Thermometer	Fluke	52II	18890119	07 Apr 2015	12
M122	DMM	Fluke	77	64910017	24 Apr 2015	12
S0539	Power Supply	Kikusui	PCR 1000L	13010170	Calibrated before use	N/A
L1158	Temperature Chamber	Votsch	VTS 4033	537/83536	Calibrated before use	N/A

5.2.9. Frequency Stability (Voltage Variation)**Test Summary:**

Test Engineer:	Ian Watch	Test Date:	13 March 2015
Test Sample Serial Number:	F50980BB0070		

FCC Reference:	Parts 90.213 & 2.1055
Test Method Used:	ANSI TIA-603-C-2004 Section 2.2.2. FCC Part 2.1055 / KDB 971168 D01 Section 9.0. and Notes below

Environmental Conditions:

Temperature (°C):	20
Relative Humidity (%):	23

Note(s):

1. Frequency stability was measured using the frequency count function of a spectrum analyser.
2. The EUT was configured to continuously transmit a CW signal at maximum power during the test.
3. Voltage was monitored throughout the test with a calibrated digital voltmeter.
4. The manufacturer declared the frequency stability limit as ≤ 10 ppm.

Results:

PoE Supply Voltage (VAC)	Measured Frequency (MHz)	Frequency Error (Hz)	Frequency Error (ppm)	Limit (ppm)	Margin (ppm)	Result
102	4987.498555	1445	0.2897	10	9.7103	Complied
138	4987.498555	1445	0.2897	10	9.7103	Complied

Test Equipment Used:

Asset No.	Instrument	Manufacturer	Type No.	Serial No.	Date Calibration Due	Cal. Interval (Months)
M1784	Thermohygrometer	JM Handelspunkt	30.5015.13	Not stated	21 Mar 2015	12
M1886	Test Receiver	Rohde & Schwarz	ESU26	100554	09 May 2015	12
M1642	Thermometer	Fluke	52II	18890119	07 Apr 2015	12
M122	DMM	Fluke	77	64910017	24 Apr 2015	12
S0539	Power Supply	Kikusui	PCR 1000L	13010170	Calibrated before use	N/A
L1158	Temperature Chamber	Votsch	VTS 4033	537/83536	Calibrated before use	N/A

6. Measurement Uncertainty

No measurement or test can ever be perfect and the imperfections give rise to error of measurement in the results. Consequently the result of a measurement is only an approximation to the value of the measurand (the specific quantity subject to measurement) and is only complete when accompanied by a statement of the uncertainty of the approximation.

The expression of uncertainty of a measurement result allows realistic comparison of results with reference values and limits given in specifications and standards.

The uncertainty of the result may need to be taken into account when interpreting the measurement results.

The reported expanded uncertainties below are based on a standard uncertainty multiplied by an appropriate coverage factor such that a confidence level of approximately 95% is maintained. For the purposes of this document "approximately" is interpreted as meaning "effectively" or "for most practical purposes".

Measurement Type	Range	Confidence Level (%)	Calculated Uncertainty
Conducted Output Power	4940 MHz to 4990 MHz	95%	±0.76 dB
Power Spectral Density	4940 MHz to 4990 MHz	95%	±1.13 dB
Occupied Bandwidth	4940 MHz to 4990 MHz	95%	±3.92 %
Conducted Spurious Emissions	9 kHz to 40 GHz	95%	±2.62 dB
Frequency Stability	4940 MHz to 4990 MHz	95%	±0.92 ppm
Radiated Spurious Emissions	30 MHz to 1 GHz	95%	±5.65 dB
Radiated Spurious Emissions	1 GHz to 40 GHz	95%	±2.94 dB

The methods used to calculate the above uncertainties are in line with those recommended within the various measurement specifications. Where measurement specifications do not include guidelines for the evaluation of measurement uncertainty the published guidance of the appropriate accreditation body is followed.

7. Report Revision History

Version Number	Revision Details		
	Page No(s)	Clause	Details
1.0	-	-	Initial Version
2.0	11, 23, 26, 27, 28, 30, 33, 34, 43 & 53	-	Power settings and power/PSD test results for omnidirectional antenna changed to match sectorised antennas. No power reduction is required when the omnidirectional antenna is used for P-T-P or P-M-P operation
3.0	7 & 9 All 17 & 23 90 6 & 86 86	-	At the request of the TCB: Removed AC conducted emissions test results and associated references. Removed details of both power supplies from Identification of Equipment Under Test section and inserted into Support Equipment section Removed references to, and test results for the 4' parabolic antenna (apart from Section 3.6, Page 10) Updated Note 4 wording Updated Test Equipment Used list Inserted ANSI C63.4 references Changed order of Radiated Spurious Emission Notes
4.0	7	-	Corrected latest software version and issue date

Appendix 1. Conducted Test Setup Photograph

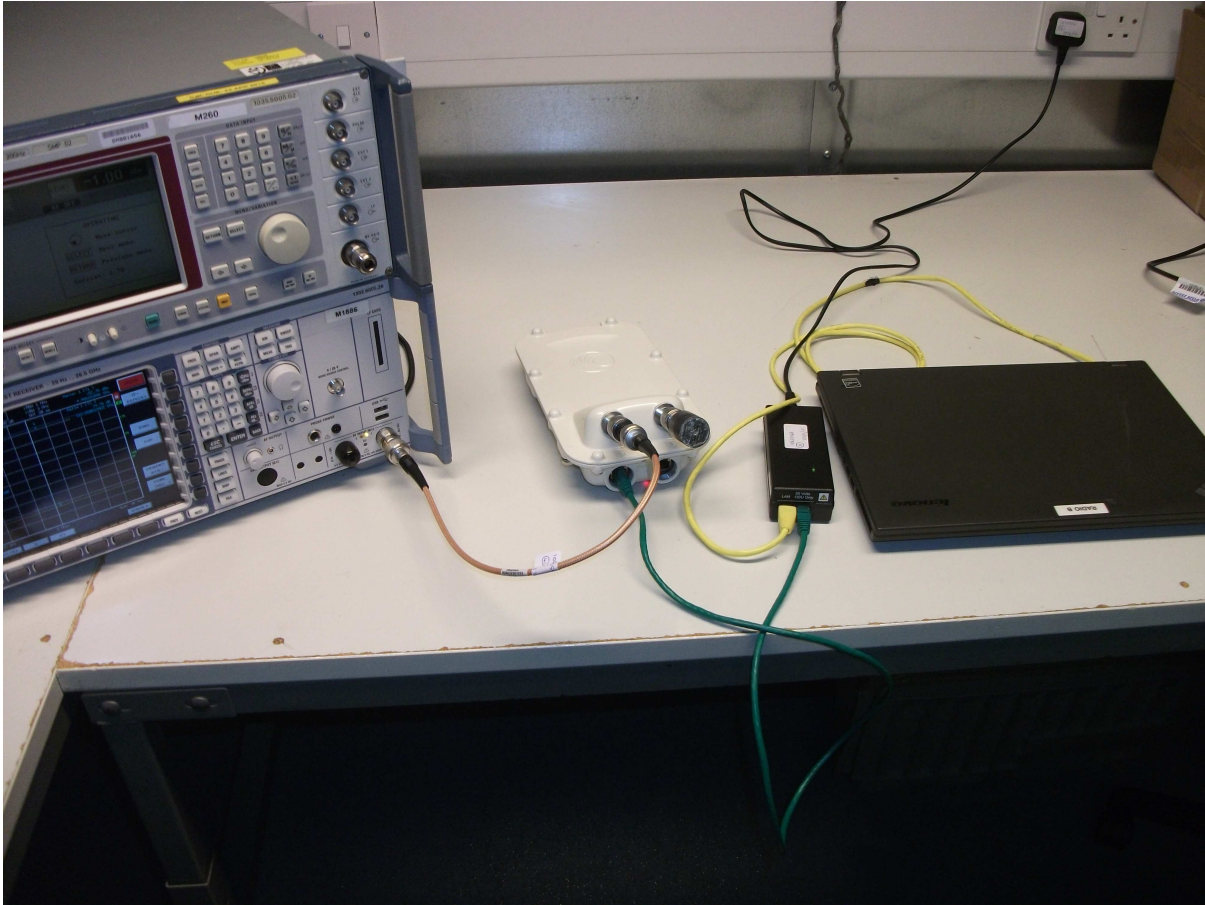

EUT configuration for conducted measurements

--- END OF REPORT ---