

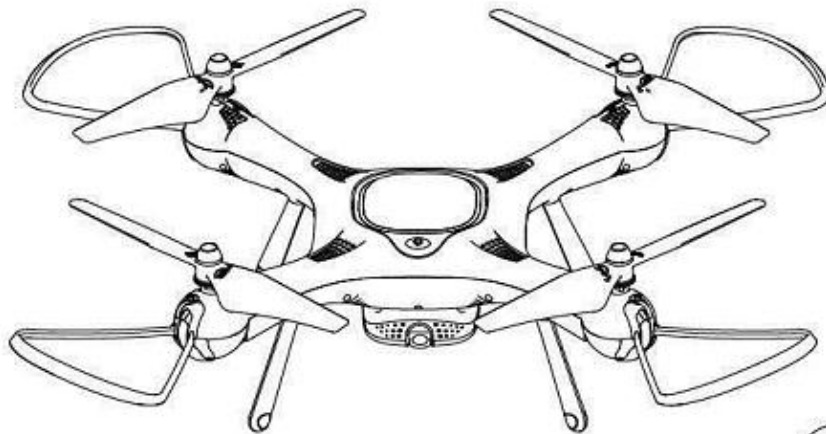

12+

X *GYRO REMOTE CONTROL SERIES* **25PRO 2.4G** **720P POSITIONING AERIAL DRONE WITH ADJUSTABLE CAMERA**



1 **USER MANUAL**

MAIN FEATURES

- Utilizes the 4-axis structure, enabling the drone to be even more flexible ,speedy, and possessing a relatively stronger wind-withstanding capability. It suitable for both spacious indoor and outdoor areas.
- Built-in 6-axis gyro stabilizer to ensure the accuracy of in-flight position.
- The structure uses a modular design which makes it easier to install and repair.
- With the functions of outdoor GPS fixed-point, one key return, auto return when the drone is out of control or in low-voltage, one key ascent/descent, geomagnetic headless, position hovering mode and 4 channels function which are up/down , rise/decline,turn left/right, forward/backward, left/right side flight, follow me, circle flight .
- HD wifi real-time transmission for getting the fun of different photography.

The material, specifications, or parts within the package are for reference only. All instructions and other collateral documents are subject to change at the sole discretion of SYMA Co.,Ltd. For up-to-date product literature, visit www.symatoys.net.

Safety Guide

1. Please store the smaller-sized drone accessories in places that are out of reach of children.
2. This drone is very powerful. For all first-time flights, the left joystick must be slowly pushed up in order to prevent the drone from ascending too fast to avoid unnecessary collision and possible damage and injury.
3. When the flight is ended, first turn off the power of the remote control. Then turn off the power of the drone.
4. Avoid placing the batteries in places with high temperatures and exposure to heat.
5. Take extra precaution to ensure that the drone is at a minimum distance of 15 feet from the pilot, other people, and animals in order to prevent bodily injury during flight operation. A minimum separation distance of 20 cm must be maintained between the user's body and the device under normal use condition.
6. This drone is for people ages 8+. It must be flown always within the line of sight of the pilot (or instructor) and flown safely.
7. Non-rechargeable batteries are not to be recharged; Batteries are to be inserted with the correct polarity; Different types of batteries or new and used batteries are not to be mixed.
8. When the drone is not in use, please remove the batteries in the remote control.
9. The supply terminals are not to be short-circuited.
10. Discharge the battery to 40%-50% (On a full charge, fly for half of the total flight time) if it will not be used for 10 days or more, this can greatly extend the battery life.
11. Please keep a safe distance from the spinning propellers to avoid injury.
12. To ensure the electromagnetic environment requirement of the aviation radio (station), using remote controls in the zone, which is in a radius of about 5000m zone from the circle center of the airport runway, is forbidden. All users also should abide by the regulation of the radio set forth by government and regulatory agencies including the duration and area.
13. Only use the recommended transformer for the model, and the transformer is not a model. Disconnect the transformer from the model which is available cleaning with liquids before cleaning. Check the cord, plug, enclosure and other parts of the transformer regularly. If any damages have been discovered, please immediately stop using it, until it was completely repaired.
14. Never look steadily at the laser beam since the laser radiation.
15. Attention: Drone assembly under adult supervision.
16. The pilot is responsible for the safe operation and safe distance from uninvolved persons and property on the ground and from other airspace users and shall never fly the drone above crowds (> 12 persons).
17. The packing has to be kept since it contains important information.

Package description

The following items can be found in this product package:

- Drone
- Remote Control
- User Manual
- Screwdriver
- 4 Blades
- USB Charger
- 4 Protective Gears
- Mobile Phone Retaining Clip

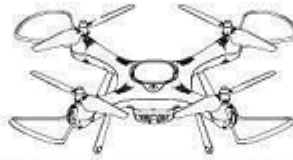

Blade and Protective Gear's Installation Methods

Blade's installation



Press the blade lock down, and then the blade "A" is rotated in A clockwise direction to remove, and it is locked in A counterclockwise rotation; The blade B is rotated in A counterclockwise to remove, and it is locked in A clockwise rotation.

Protective Gear's Installation

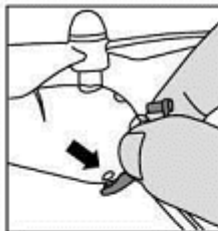

1. Insert the protective gear into the two jack connectors underneath the main body as shown in Figure 1.
2. Insert the stem on the protective gear into the jack connector on the main body as shown in Figure 2 and press it.

Camera's Installation and Dismantling Methods

Installation steps for camera

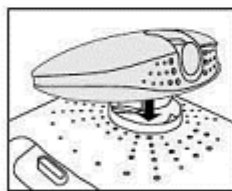

1. Connect the camera's wire connector to the drone.

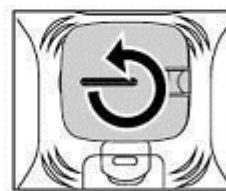

2. Place the camera into the drone and rotate the camera counterclockwise to lock.

Dismantling steps for camera



1. Rotate the camera in the clockwise direction.

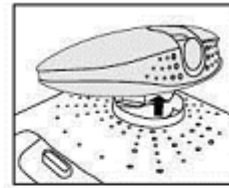

2. Take out the camera upward and disconnect the wire connector from the drone.

Installation of Mobile Phone Retaining Clip

Mobile phone retaining clip's attachment method:

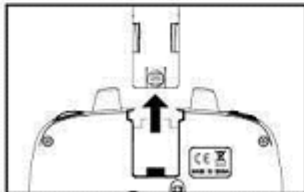

1. Pull up the phone clip cover from behind the remote control.

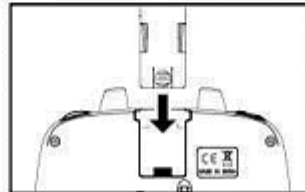

2. Insert the phone clip holder into the connector at the top of the remote control.



3. Press the handles to adjust the jaws.

Battery Changing and Charging Methods for Drone

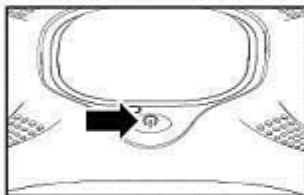

1. Press the power button on the top of the drone to make sure the drone is turned "OFF".

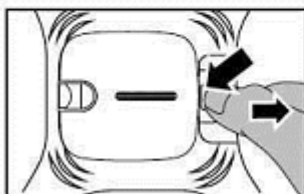

2. Press the fixed components at the bottom of the battery and pull out the battery.

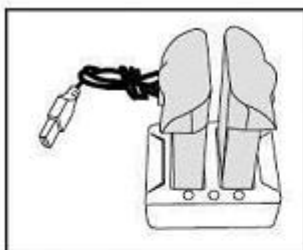

3. Insert the USB port of USB charging cable to power supply and the red indicator light will turn on, while the battery is inserted for charging the green indicator light will turn on, and it will turn off when charging completed. It takes about 150 minutes to completely charge the battery.

Note: charging input voltage must be 5V (input current 2A shall be accurate, input current size will directly affect charging time), The change of charging indicator light shall prevail.

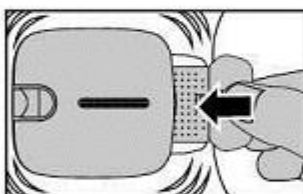

4. After charging completed, replace the battery into the drone.

The charging time is less than 150 minutes; In hover flight conditions longer than 12 minutes!

Precautions as follows during charging of battery:

- Avoid placing the active batteries in places with direct exposure, sunlight and high temperatures. For example, naked light or electrical equipment installations; otherwise it may cause damages or explosions.
- Avoid immersing the batteries in the water. The batteries shall be stored in a cool and dry place.
- Avoid dismantling the batteries.
- During the charging of battery, avoid leaving the charging place.
- Rechargeable batteries are to be removed from the toy before being charged.
- Rechargeable batteries are only to be charged under adult supervision.
- Exhausted batteries are to be removed from the toy.
- Caution: Risk of explosion if battery replaced by an incorrect type, dispose of used batteries according to the instructions.

Understanding your remote control

Remote control's button function description:

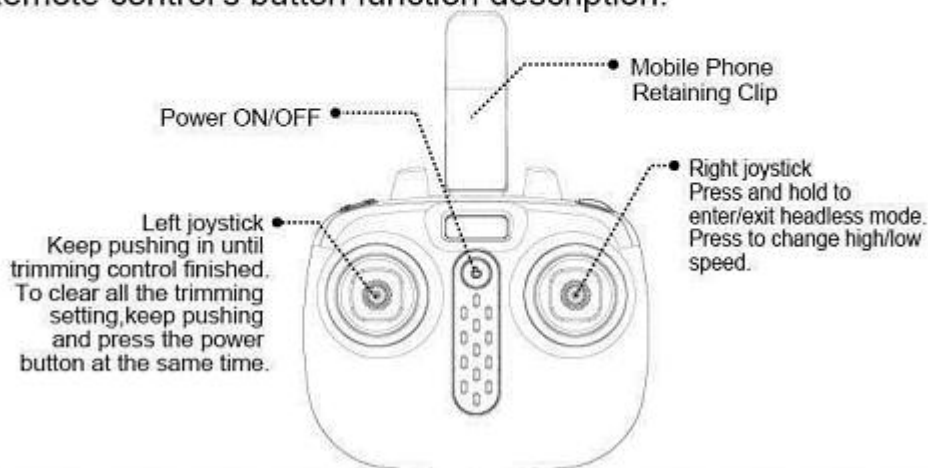

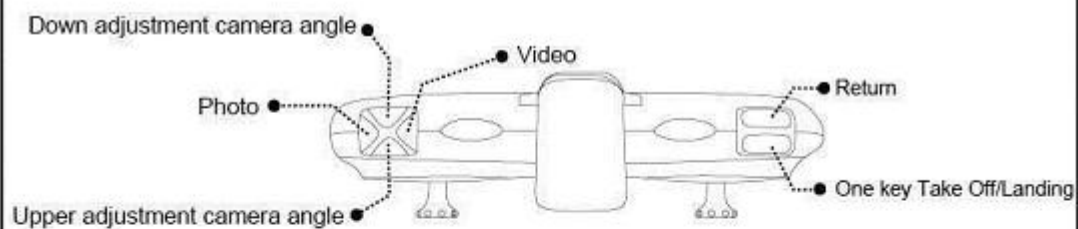

Battery installation for remote control:

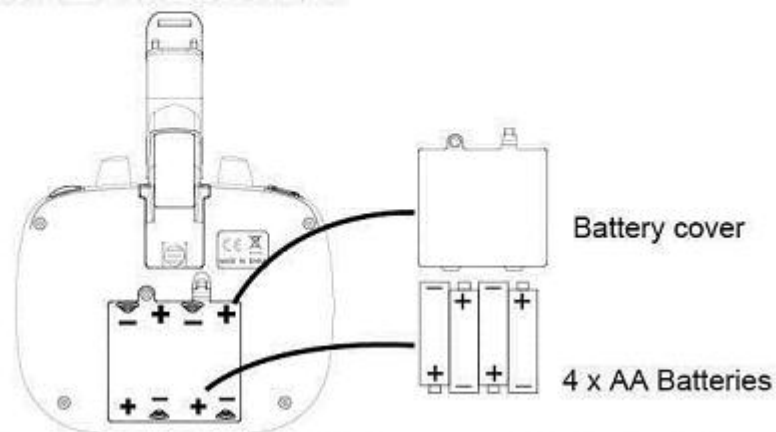

Battery Installation Method: Open up the battery cover at the back of the remote control. Correctly place 4 x AA alkaline batteries in the battery box in strict adherence to the polarity instructions (batteries are not included).



1. During the battery installation, it must be ensured that the polarities of the batteries are matched with that of the battery box. No battery shall be installed with the opposite polarity.
2. Please do not use new and old batteries together.
3. Please do not use different types of batteries together.
4. Do not use rechargeable batteries.

Flight Preparation and Turning the Drone ON and Off

1. Flight preparation

- ① Find a wide place for flying.
- ② Install the battery in the drone, and place it on a level surface with the nose of the drone face forward (Figure 1), press the power button for 2 seconds and then release (Figure 2). Power on the remote control, push the throttle joystick of the remote control up to the top and then down to the bottom (Figure 3). When the remote control beeps twice and the indicator light of the drone turns to solid from blink signal connection completed.

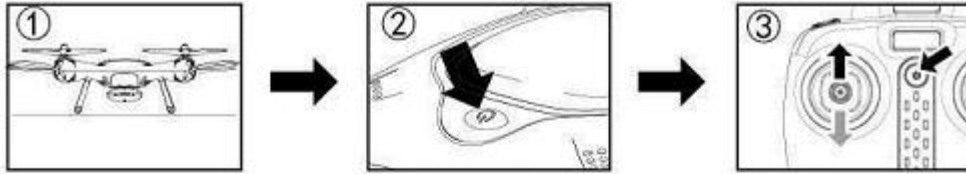

2. Compass Calibration :

Before the first flight, the compass calibration is required. When the remote control has connected to the drone, push the left joystick to the right bottom corner and hold it, then press the One key return button located at the upper right corner of the remote control (Figure 1). When the indicator lights flash slowly, release the left joystick and hold the drone horizontally and rotate 360 degrees till the indicators of the drone turn to fast flashing (approx 4 circles) (Figure 2), and rotate it 360 degrees till the indicators turn to long bright (approx 4 circles) (Figure 3), the calibration finished.

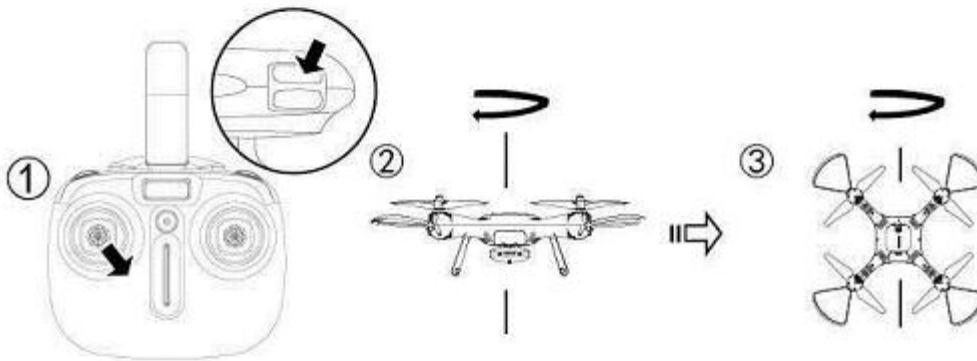

Note: 1. Never calibrate the compass in a strong magnetic field or near the bulk metal, such as magnetite, parking lot and buildings with underground reinforced.
 2. Never carry the ferromagnetic material, such as mobile phone, with you when calibrating.
 3. Take a compass calibration when the drone drifting or swinging around during the flight.

3. Search satellite (indoor flight can't search satellite)

The rear lights of the drone begin as solid orange, and turn to blink green about 1 minute later when finish the satellite signal searching. After 5 seconds, the blink green lights change to solid green, that indicates there are enough GPS points recorded successfully, and the drone is able to fly off the ground with GPS fix-point function.

4. Turning on the drone



Method 1: Push the left joystick (throttle) to the highest point and then back to the center, of the drone the blades start rotating slowly.



Method 2: Push the left and right joysticks to the bottom inner corners for 1 second, the blades of the drone start rotating slowly.

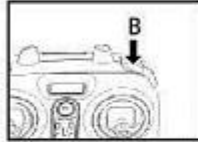

Method 3: When the drone is stationary, press the button B, the drone automatically takes off and hovers at a certain height.

1. If the drone is out of the range of the flight, the indicator light will flash slowly, and then slow down.
2. When the remote control is switched off or the power is cut off, the drone will automatically slow down to stop. In the process, open the remote control to control again.

5. Turning off the drone



Method 1: Push the left joystick (throttle) to the lowest level and hold for 2 to 3 seconds, the drone can then be turned off.



Method 2: Push the left and right joysticks to the bottom inner corners for 1 second, and the drone can be turned off.

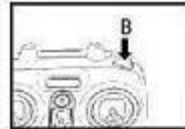

Method 3: When the drone is in flight, press the button B, the drone will descend to the ground and land.

Drone Controlling Diagram

Direction control

Ascending and descending control

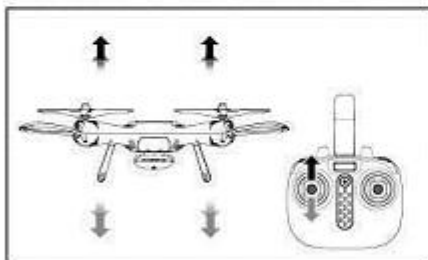

When the left joystick (throttle) is pushed upwards or downwards, the drone will ascend or descend correspondingly.

Forward and backward control

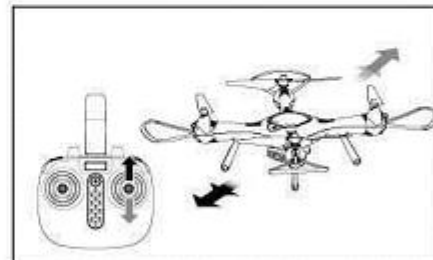

When the right joystick (rudder) is pushed upwards or downwards, the drone will fly forward or backward correspondingly.

Left turning and right turning control

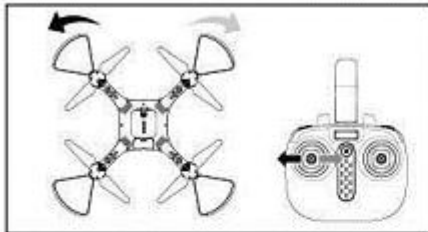

When the left joystick (throttle) is pushed towards the left or right, the drone will turn left or right correspondingly.

Left side flying and right side flying control

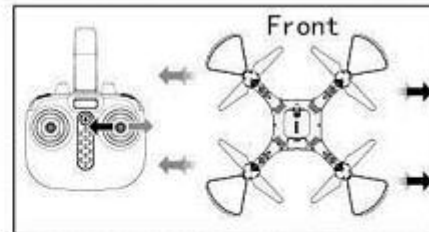

When the right joystick (rudder) is pushed towards the left or right, the drone will fly sideways on the left or right correspondingly.

Trimming operation

Forward and backward trim control

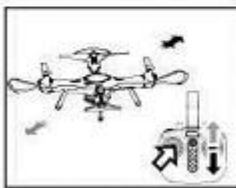

If the drone automatically flies forward/backward while hovering, press in the left joystick and at the same time push the right joystick backward/forward slightly to fine tune the direction. Don't release the left joystick until the drone is flying in a stable state.

Left/right side flight trim control

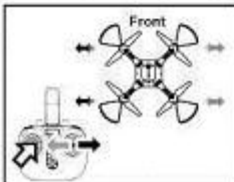

If the drone automatically flies towards the left/right side while hovering, press in the left joystick and at the same time push the right joystick right/left slightly to fine tune the direction. Don't release the left joystick until the drone is flying in a stable state.

Product Features

1. One Key Return :

When use the one key return function (Figure 1) or the drone auto return when it is out of control or in low-voltage, the front and rear lights turn red, and the drone will return home immediately if it at the range of 20 meters, if the drone is beyond the the range of 20 meters, it will ascend at about 25 meters altitude first, then return home, and the drone will back to the record point at last. Long press the one key return button again, the drone will exit return mode except it is auto return with low-voltage, but when the drone fly to the second range it can be canceled return (Figure 2) When the drone returns home, manual operation to avoid obstacle is allowed, and it will continue to return if stopped manual operation. The return point will be a little errors cause by the environment, it's a normal phenomenon.

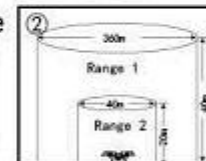
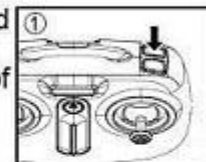

Note:

1. When the GPS signal is weak or not work, the green light of the drone will turn orange, and it will fail to return home and get the GPS coordinates, and it need to be controlled to return home manually.
2. When the drone is low-voltage, stop other operation and control it to return, otherwise, it will fall down or crash when over low-voltage.

2. Low-voltage protection:

When the four indicator lights at the bottom of drone start flashing, it means that the drone's battery power is low. At this time, please control the drone return.

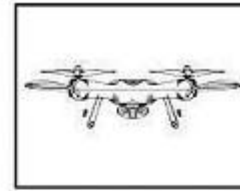

3. Over-Current Protection:

When the drone encounters direct impact from a foreign object, or is obstructed, or the blades are not rotating, the drone will go into the over-current protection mode.

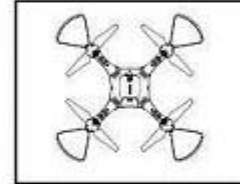

4. Level Calibration Function:

Place the drone on a level surface and at the same time, push both left and right joysticks to the lower right corners for 2 to 3 seconds; the indicator lights on the drone will blink rapidly, and they will return to solid status after about 2 to 3 seconds. The level calibration is successful.

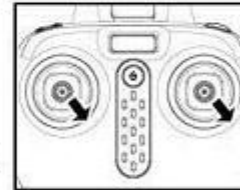

5. High/Low Speed Function:

Low speed by default when first powered-on. Possible to switch the function mode of high/low speed by pressing the right joystick for a short time. It is switched into high speed mode when two "beep" sounds come from the remote control, pressing the right joystick for a short time under fast speed mode and then one "beep" sound would come from the remote control, then it is switched back into low speed mode.



6. Photo/ Video Shooting Function:

① Photo shooting function: Press the Photo button, the drone indicator and the red indicator light on the camera will flash once when the photo has been taken.

② Video shooting function: Press the Video button, the drone indicator and the red indicator light on the camera will flash twice, and then turn long bright, it indicates the video is recording, press the Video button again, the indicator light on the drone is long bright, indicating the recording is complete.

7. Adjustable function of camera

As shown on the right, press the button A or B to adjust the camera angle in corresponding upward or downward.

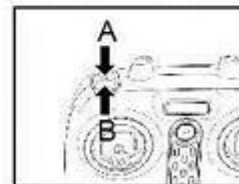

8. GPS Coordinates & Aerial Photography :

After the drone complete recording the return point, it can take an aerial photography at the fixed point accurately, the camera will able to take the photo or record the video with adjusting the camera angle up and down at the range of 0-90 degree.

In the wide place, the flying range is more than 180 meters, and the Limit height of the GPS coordinates is about 35 meters.

9. Auto Hover Function:

After using the left joystick (throttle) to control the ascending/descending flight of the drone, release the left joystick (throttle) and the drone will hover at that height when the joystick is released.



10. Headless Function:

① Defining forward direction:

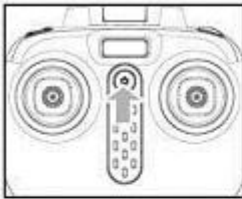

- Press on the power button of the remote control.

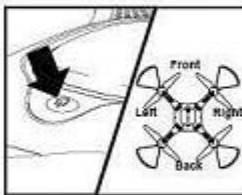

- Connect the battery to the drone, press the power button of the drone, and adjust the specified direction of the drone's head under the headless mode as the new forward direction.

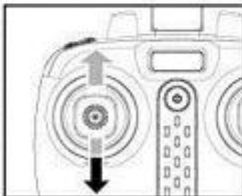

- Push the left joystick (throttle) on the remote control up to the farthest position and then pull down to the farthest position. When the remote control issues a long "beep" sound, it means the frequency and defining forward direction functions are completed.

② Toggling between headless function and normal function:

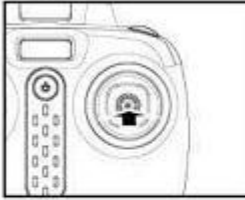

- After the drone is matched with the corresponding frequency, the drone would be in normal pattern by default. At this time the indicator light on the drone would be in a state of on for a long time. After pressing in on the right joystick of the remote control for 2 seconds, the remote control would make a sound of "beep, beep, beep" to show that it has entered into a state of headless mode. Press in the right joystick for 2 seconds then a long sound of "beep" would be heard to show an exit status. (When under the state of headless mode, four indicator lights on the drone flash slowly once every four seconds).

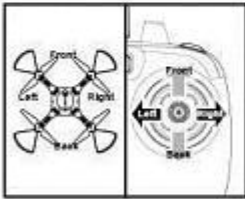

- Under the headless mode, the operator does not need to differentiate the head position of the drone, and only needs to control the drone's direction front/back/left/right by using the right joystick direction on the remote control.

③. Calibration for the definition of the front:

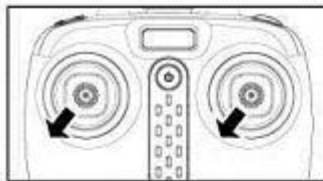

When the drone encounters a direct impact with foreign objects in the headless mode, if there is an occurrence of deviation of the defined direction, it is only required to push both the left and right joysticks to the bottom left corners simultaneously after placing the flying direction of the drone in the correction position. When the led light indicator of the drone is in a long "ON" mode after slowly flashing for 3 seconds, it indicates the calibration

11. Wireless Real-Time Transmission Function

① Downloading the installation software

For Android phones, download and install the SYMA FLY APP by visiting the www.symatoys.com or by scanning the QR code.

For IOS Apple phones, download and install the SYMA FLY APP by visiting the App Store or by scanning the QR code.

Tips: QR codes are provided on the packaging box and at the bottom of the user manual. Please visit website www.symatoys.com or the App Store/Google Play to obtain the newest SYAM FLY App.

② For more information on the connection, see the APP operating instructions.

Warning: Changes or modifications to this unit not expressly approved by the party responsible for compliance could void the user's authority to operate the equipment.

NOTE: This equipment has been tested and found to comply with the limits for a Class B digital device, pursuant to Part 15 of the FCC Rules. These limits are designed to provide reasonable protection against harmful interference in a residential installation. This equipment generates, uses and can radiate radio frequency energy and, if not installed and used in accordance with the instructions, may cause harmful interference to radio communications

However, there is no guarantee that interference will not occur in a particular installation. If this equipment does cause harmful interference to radio or television reception, which can be determined by turning the equipment off and on, the user is encouraged to try to correct the interference by one or more of the following measures:

- Reorient or relocate the receiving antenna.
- Increase the separation between the equipment and receiver.
- Connect the equipment into an outlet on a circuit different from that to which the receiver is connected.
- Consult the dealer or an experienced radio/TV technician for help.

"This device complies with FCC radiation exposure limits set forth for general population (uncontrolled exposure).

This device must not be collocated or operating in conjunction with any other antenna or transmitter."

Declaration of Conformity Inserts:

"Hereby, GuangDong Syma model aircraft Industrial co.,ltd, declares that this drone is in compliance with the essential requirements and other relevant provisions of Directive 2014/53/EU."

A copy of the full DoC is attached.

Accessories /Parts List (Optional)

You can choose your favourite optional accessories as below. In order to make it easier for the customers to choose and purchase, we have specially offered each and every accessory. The accessories can be purchased through the local distributors. Please kindly specify the colours during your purchase.



Body

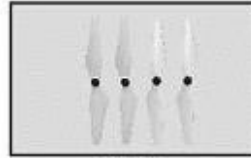

Blade



Protective Gear



Landing Gear

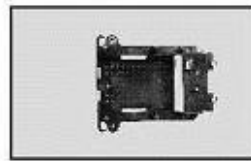

Battery box



Battery

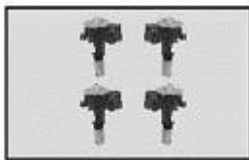

Motor seat

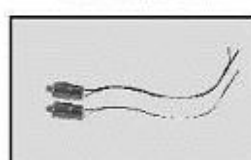

Motor

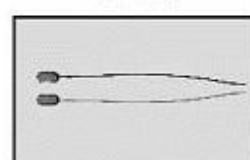

Light Bar



Upper Light Bar



USB Charger



Camera



Ornament

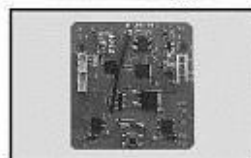

Receiver Board



Mobile Phone Retaining Clip



Remote Control

Product Descriptions

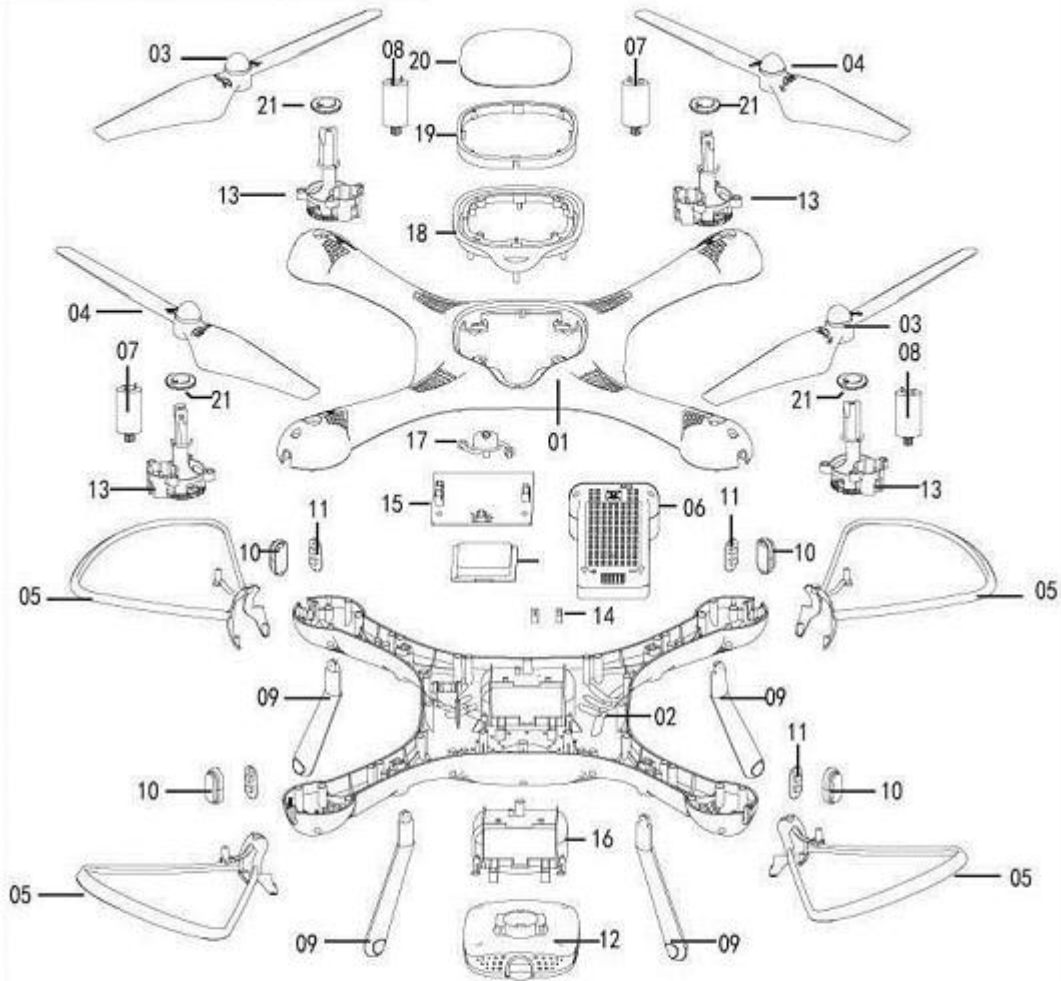

NO.	Product Name	Qty.	NO.	Product Name	Qty.	NO.	Product Name	Qty.
01	Top main Body	1	09	Landing Gear	4	17	switch	1
02	Bottom main Body	1	10	Lamp Cover	4	18	Ornament	1
03	Blade(Clockwise Direction)	2	11	Light Bar	4	19	Light guide part	1
04	Blade(Counter-clockwise Direction)	2	12	Camera	1	20	Top cover	1
05	Protective Gear	4	13	Motor seat	4	21	Blade lock	1
06	Battery	1	14	Upper Light Bar	4			
07	Motor(Counter-clockwise Direction)	2	15	Receiver Board	1			
08	Motor(Clockwise Direction)	2	16	Battery box	1			

Main Specifications

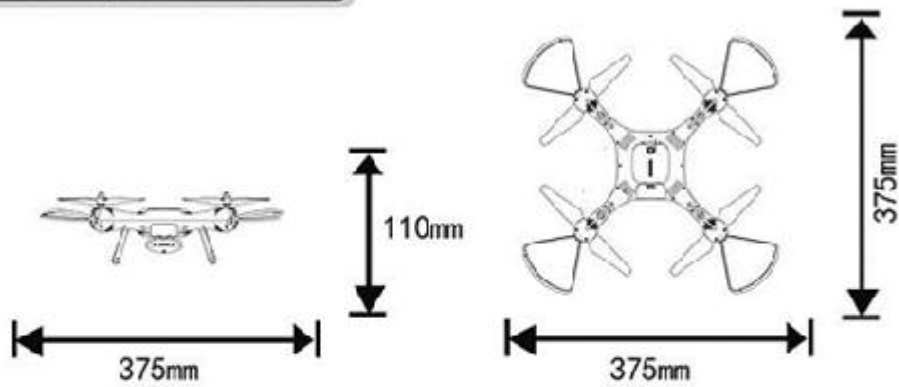

Drone's Length: 375mm Drone's Width : 375mm
 Drone's Height: 110mm Motor's Model : ø10x20
 Battery : 7.4V 1000mAh lithium battery

Rectification Procedures

Problem	Reason	Solution
The drone has no response	<ol style="list-style-type: none"> 1. The drone has entered into low-voltage protection. 2. When the power of the remote control is weak, the power light indicator will blink. 	<ol style="list-style-type: none"> 1. Charge up the drone. 2. Change the batteries of the remote control.
The flight response of the drone is not sensitive	<ol style="list-style-type: none"> 1. The power of the remote control is weak. 2. There is an interference with the same frequency as that of the remote control. 	<ol style="list-style-type: none"> 1. Change the batteries. 2. Change to a place where there is no interference with the same frequency.
The drone is flying towards its side in one direction during hovering	<ol style="list-style-type: none"> 1. The drone is not calibrated level to the ground. 	<ol style="list-style-type: none"> 1. Re-adjust the calibration until the drone is level to the ground. For further details, see No.4 on Page 9 for details(Level calibration function).

Problem	Reason	Solution
In the headless state, it is biased towards the front direction	1. Many collisions may cause head drift.	1. Re-define the front direction. For further details, see No. 10 Page 10 for details(Headless function).
Fixed high instability / up and down movement	1.The drone is not calibrated level to the ground. 2.Unstable air pressure under the severe weather condition. 3. Violent collision resulting in data disorder of gyroscope.	1.Re-adjust the calibration until the drone is level to the ground. For further details, see No.4 on Page 9 for details(Level calibration function). 2. Avoid to fly under the severe weather condition. 3. Make level adjustment again, see No.4 on Page 9 for details (Level calibration function).

This device complies with Industry Canada licence-exempt RSS standard(s). Operation is subject to the following two conditions: (1) this device may not cause interference, and (2) this device must accept any interference, including interference that may cause undesired operation of the device.

Under Industry Canada regulations, this radio transmitter may only operate using an antenna of a type and maximum (or lesser) gain approved for the transmitter by Industry Canada. To reduce potential radio interference to other users, the antenna type and its gain should be so chosen that the equivalent isotropically radiated power (e.i.r.p.) is not more than that necessary for successful communication.

Conformément à la réglementation d'Industrie Canada, le présent émetteur radio peut fonctionner avec une antenne d'un type et d'un gain maximal (ou inférieur) approuvé pour l'émetteur par Industrie Canada. Dans le but de réduire les risques de brouillage radioélectrique à l'intention des autres utilisateurs, il faut choisir le type d'antenne et son gain de sorte que la puissance isotrope rayonnée équivalente (p.i.r.e.) ne dépasse pas l'intensité nécessaire à l'établissement d'une communication satisfaisante.

Le présent appareil est conforme aux CNR d'Industrie Canada applicables aux appareils radio exempts de licence. L'exploitation est autorisée aux deux conditions suivantes : (1) l'appareil ne doit pas produire de brouillage, et (2) l'utilisateur de l'appareil doit accepter tout brouillage radioélectrique subi, même si le brouillage est susceptible d'en compromettre le fonctionnement.

Adapt Models: **JHRZPH074xxxx-U** (The "xxxx" can be 0300-1200)

Rating: Input: **100-240Vac 50/60Hz, 0.3A max** Output: **7.4V, 300-1200 mA**

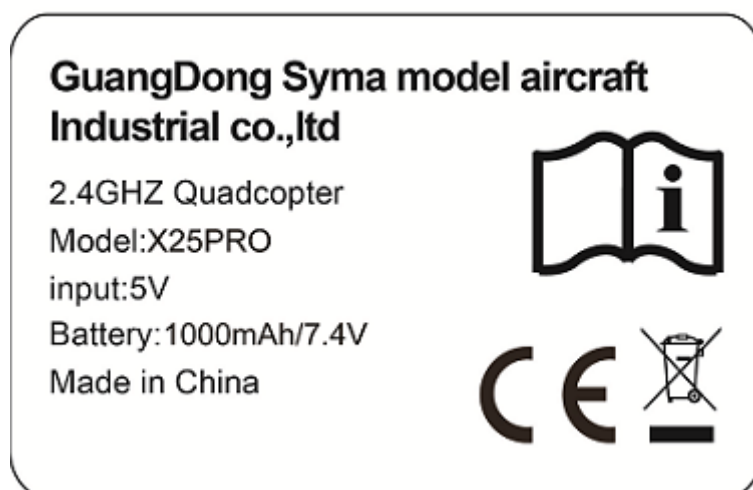

CAUTION
RISK OF EXPLOSION IF BATTERY IS REPLACED
BY AN INCORRECT TYPE.
DISPOSE OF USED BATTERIES ACCORDING
TO THE INSTRUCTIONS

 AC voltage



Use only power supplies listed in the user instructions



 RECYCLING

This product bears the selective sorting symbol for Waste electrical and electronic equipment (WEEE). This means that this product must be handled pursuant to European directive 2012/19/EU in order to be recycled or dismantled to minimize its impact on the environment. User has the choice to give his product to a competent recycling organization or to the retailer when he buys a new electrical or electronic equipment.

RF frequency band :**2410-2478MHZ**

Transmitter power :**-6.22dBm**

Sold to EU country

product name: [Drone]

model number: [**X25PRO**]

Brand name :SYMA

Contact person: Ivan

[Tel:+86-0754-86381701](tel:+86-0754-86381701)

Manufacturer name and address:

GUANGDONG SYMA MODEL AIRCRAFT INDUSTRIAL CO., LTD

NO.2 West Xingye Road Laimei Industrial Area Chenghai Shantou

Guangdong China