

Nokia 1100

User Guide

Note: Spanish translation follows page 50 of the English guide.
Portuguese translation follows page 36 of the Spanish guide.

LEGAL INFORMATION

PART NO. 9310129, ISSUE NO. 2

Copyright © 2004 Nokia. All rights reserved.

Nokia, Nokia Connecting People, Xpress-on, Navi-key, and the Nokia Original Enhancements logos are trademarks or registered trademarks of Nokia Corporation. Other company and product names mentioned herein may be trademarks or trade names of their respective owners.

Printed in Mexico, 02/2004



Includes RSA BSAFE cryptographic or security protocol software from RSA Security.

The information contained in this user guide was written for the Nokia 1100 product. Nokia operates a policy of ongoing development. Nokia reserves the right to make changes to any of the products described in this document without prior notice.

UNDER NO CIRCUMSTANCES SHALL NOKIA BE RESPONSIBLE FOR ANY LOSS OF DATA OR INCOME OR ANY SPECIAL, INCIDENTAL, AND CONSEQUENTIAL OR INDIRECT DAMAGES HOWSOEVER CAUSED. THE CONTENTS OF THIS DOCUMENT ARE PROVIDED "AS IS." EXCEPT AS REQUIRED BY APPLICABLE LAW, NO WARRANTIES OF ANY KIND, EITHER EXPRESS OR IMPLIED, INCLUDING, BUT NOT LIMITED TO, THE IMPLIED WARRANTIES OF MERCHANTABILITY AND FITNESS FOR A PARTICULAR PURPOSE, ARE MADE IN RELATION TO THE ACCURACY AND RELIABILITY OR CONTENTS OF THIS DOCUMENT. NOKIA RESERVES THE RIGHT TO REVISE THIS DOCUMENT OR WITHDRAW IT AT ANY TIME WITHOUT PRIOR NOTICE.

EXPORT CONTROLS

This device contains commodities, technology, or software exported from the United States in accordance with the Export Administration regulations. Diversion contrary to U.S. or Canadian law is prohibited.

FCC/INDUSTRY CANADA NOTICE

Your device may cause TV or radio interference (for example, when using a telephone in close proximity to receiving equipment). The FCC or Industry Canada can require you to stop using your telephone if such interference cannot be eliminated. If you require assistance, contact your local service facility. This device complies with part 15 of the FCC rules. Operation is subject to the condition that this device does not cause harmful interference.

PATENT NUMBERS

U.S. Patent Nos. 5818437, 5953541, 6011554 and other pending patents associated with this product's hardware and software

Manufactured or sold under one or more of the following U.S. Patents:

5818437	5953541	6011554	6594472	5845219	5892475
6151507	5692032	5479476	6094587	6115617	6487397
6347218	5241583	5794142	5870683	6026161	6185295
6188909	6043760	6292668	6049796	5920826	5956633
544816	5669482	5701392	5754976	4969192	RE32580

Contents

1	For your safety.	1
	About your device	2
	Network Services	2
	Accessibility solutions	3
	Charger and enhancements.	3
2	Get started.	4
	Find the label	4
	Insert the SIM card	4
	Charge the battery.	5
	Keys and connectors	6
	Display and standby mode.	7
	Change covers	8
	Attach the wrist strap	8
3	Call functions.	9
	Make a call	9
	Answer a call	10
	In-call operations.	10
	Listen to voice mail	10
	Lock the keypad	10
4	Writing text.	11
	Predictive text	11
	traditional text input	12
5	Menu functions	13
	List of menu functions.	13
	Messages (Menu 0-1)	14
	Contacts (Menu 2)	17
	Call log (Menu 4)	18
	Tones (Menu 5).	19
	Profiles (Menu 6)	20

	Settings (Menu 7).....	20
	Alarm clock (Menu 8).....	23
	Reminders (Menu 9).....	23
	Games (Menu 10).....	24
	Extras (Menu 11)	24
	SIM services (Menu 12).....	26
	Enhancements	26
6	Reference Information	27
	Battery information	27
	Enhancements	28
	Enhancements, Batteries, and Chargers.....	28
	Care and maintenance.....	28
	Additional safety information.....	29
7	Nokia One-Year Limited Warranty	34
	Appendix A Message from the CTIA	39
	Appendix B Message from the FDA	43
	Index	49

1 For your safety

Read these simple guidelines. Not following them may be dangerous or illegal. Read the complete user guide for further information.



SWITCH ON SAFELY

Do not switch on the phone when wireless phone use is prohibited or when it may cause interference or danger.



ROAD SAFETY COMES FIRST

Obey all local laws. Always keep your hands free to operate the vehicle while driving. Your first consideration while driving should be road safety.



INTERFERENCE

All wireless phones may be susceptible to interference, which could affect performance.



SWITCH OFF IN HOSPITALS

Follow any restrictions. Switch the phone off near medical equipment.



SWITCH OFF IN AIRCRAFT

Follow any restrictions. Wireless devices can cause interference in aircraft.



SWITCH OFF WHEN REFUELING

Don't use the phone at a refueling point. Don't use near fuel or chemicals.



SWITCH OFF NEAR BLASTING

Follow any restrictions. Don't use the phone where blasting is in progress.



USE SENSIBLY

Use only in the normal position as explained in the product documentation. Do not touch the antenna unnecessarily.



QUALIFIED SERVICE

Only qualified personnel may install or repair this product.



ENHANCEMENTS

Use only approved enhancements and batteries. Do not connect incompatible products.



WATER-RESISTANCE

Your phone is not water-resistant. Keep it dry.



BACKUP COPIES

Remember to make back-up copies or keep a written record of all important information stored in your phone.



EMERGENCY CALLS

Ensure the phone is switched on and in service. Press **C** as many times as needed to clear the display and return to the main screen. Enter the emergency number, then press **Call**. Give your location. Do not end the call until told to do so.

● ABOUT YOUR DEVICE

The wireless device described in this guide is approved for use on the GSM network. Contact your service provider for more information about networks.

When using the features in this device, obey all laws and respect privacy and legitimate rights of others.



Warning: To use any features in this device, other than the alarm clock, the phone must be switched on. Do not switch the device on when wireless phone use may cause interference or danger.

● NETWORK SERVICES

To use the phone you must have service from a wireless service provider. Many of the features in this device depend on features in the wireless network to function. These network services may not be available on all networks or you may have to make specific arrangements with your service provider before you can utilize network services. Your service provider may need to give you additional instructions for their use and explain what charges will apply. Some networks may have limitations that affect how you can use network services. For instance, some networks may not support all language-dependent characters and services.

Your service provider may have requested that certain features be disabled or not activated in your device. If so, they will not appear on your device menu. Contact your service provider for more information.

● ACCESSIBILITY SOLUTIONS

Nokia is committed to making mobile phones easy to use for all individuals, including those with disabilities. Nokia maintains an internet site that is dedicated to accessibility solutions. For more information about phone features, enhancements, alternate format user guides, and other Nokia products designed with your needs in mind, visit the web site at: www.nokiaaccessibility.com.

The Nokia 1100 phone is equipped with a universal 2.5-mm accessory jack that can be used to connect any "cellular ready" or "cellular compatible" TTY/TDD device cable.



Important: Once your TTY/TDD device is connected, you must use the phone menu **Menu > Settings > Enhancement settings > TTY/TDD** to enable the TTY/TDD mode.

● CHARGER AND ENHANCEMENTS

Check the model number of any charger before use with this device. This device is intended for use when supplied with power from ACP-7, ACP-8, ACP-12 and, LCH-9 and LCH-12.



Warning: Use only batteries, chargers and enhancements approved by the phone manufacturer for use with this particular phone model. The use of any other types may invalidate any approval or warranty applying to the phone, and may be dangerous.

For availability of approved enhancements, please check with your dealer.

When you disconnect the power cord of any enhancement, grasp and pull the plug, not the cord.

2 Get started

• FIND THE LABEL

If you ever need to call Nokia Customer Care or your service provider, you will need to provide specific information about your phone. This information appears on the phone label.

The label is on the back of the phone (under the battery). It shows the following:

- Model number
1100a (approved for the GSM 900/1800 network) or 1100b (approved for the GSM 850/1900 network).
- Phone type (a technical designation)
- International Mobile Equipment Identification (IMEI)

Do not remove or deface the label.

Information label

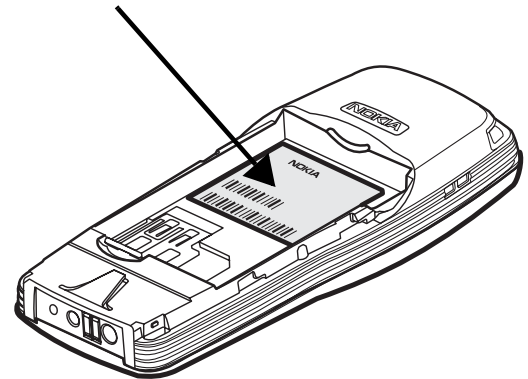

• INSERT THE SIM CARD



Note: Before installing the SIM card, make sure that the phone is switched off, disconnected from the charger or any other device and then remove the battery. Keep all miniature SIM cards out of the reach of small children. The SIM card and contacts are easily damaged by scratches or bending, so be careful when handling, inserting or removing the card. For availability and information on using SIM card services, contact your SIM card vendor. This may be the service provider, network operator, or other vendor.

- 1 Remove the back cover (1 and 2).

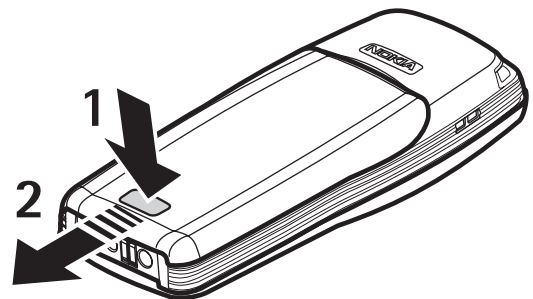

- 2 Remove the battery (3).

- 3 Insert the SIM card with the gold area down and the bevelled corner on the right (4 and 5).

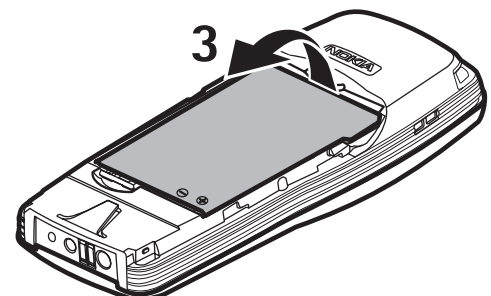

- 4 Close the SIM card holder and press to lock it (6).

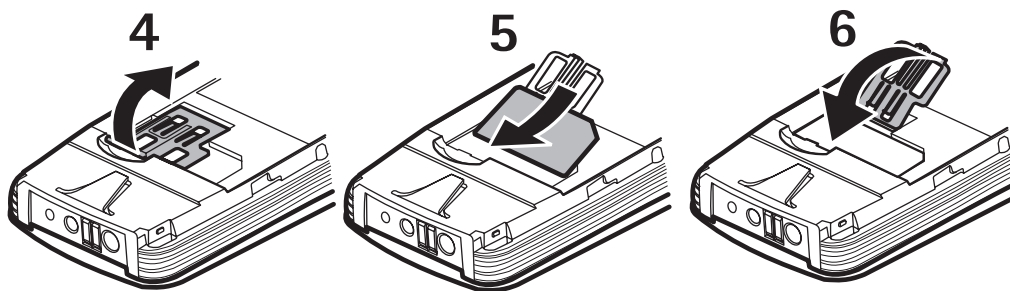

- 5 Align the gold connectors on the battery with the connectors on the phone and insert the battery (7).

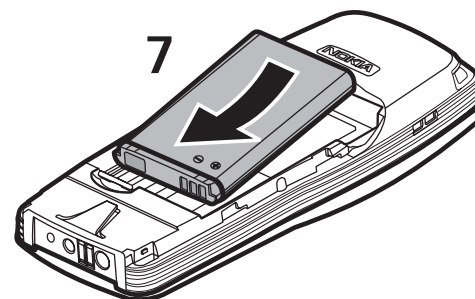

- 6 Replace the back cover (8 and 9).

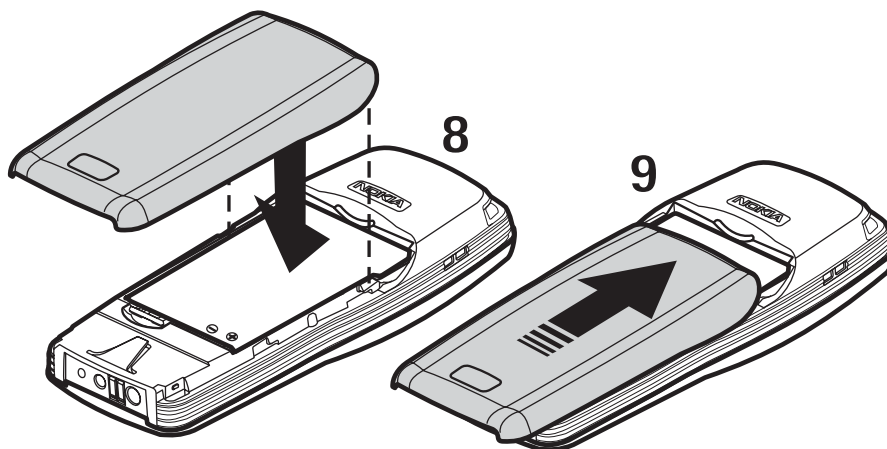

• CHARGE THE BATTERY

Do not charge the battery if the phone covers are removed.

- 1 Connect the charger plug into the connector in the phone.
- 2 Connect the charger to an ac wall outlet.

The battery indicator bar starts scrolling.

- Charging a BL-5C battery with the ACP-7 charger takes up to 3 hours.
- If **Not charging** appears, wait for a while, disconnect the charger, reconnect it, and retry. If charging still fails, contact your dealer.

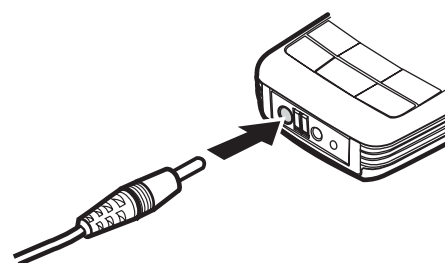

When the battery is fully charged, the bar stops scrolling. Disconnect the charger from the phone and the ac outlet.

• KEYS AND CONNECTORS

1 Flashlight See "Flashlight" on page 26.

2 Nokia Navi™ key

Text above the Navi key shows the current function of the key. In this guide, instructions such as "Press **Menu**" mean to press the key located beneath the word **Menu**.

3 Power key

Press and hold to switch the phone on or off. Press and release for quick access to a list of profiles [see "Profiles (Menu 6)" on page 20]. When the keypad is locked, press to turn on the display lights for about 15 seconds.

4 Scroll keys ^ v

Scroll through names, phone numbers, menus or settings. Adjusts the earpiece volume during a call. In the standby mode, press ^ to show the list of last dialed numbers and press v to show names and phone numbers saved in **Contacts**.

5 Clear/Exit, or C key

Deletes characters from the display and exits from different functions.

6 Use keys 0 through 9 to enter numbers and characters.

Use the * and # keys for various purposes in different functions.

7 Charger connector

8 Headset connector

9 Microphone

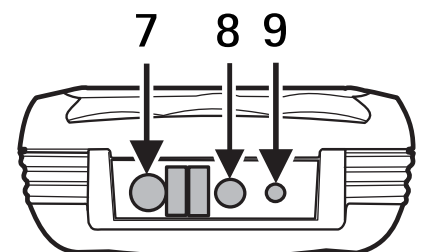
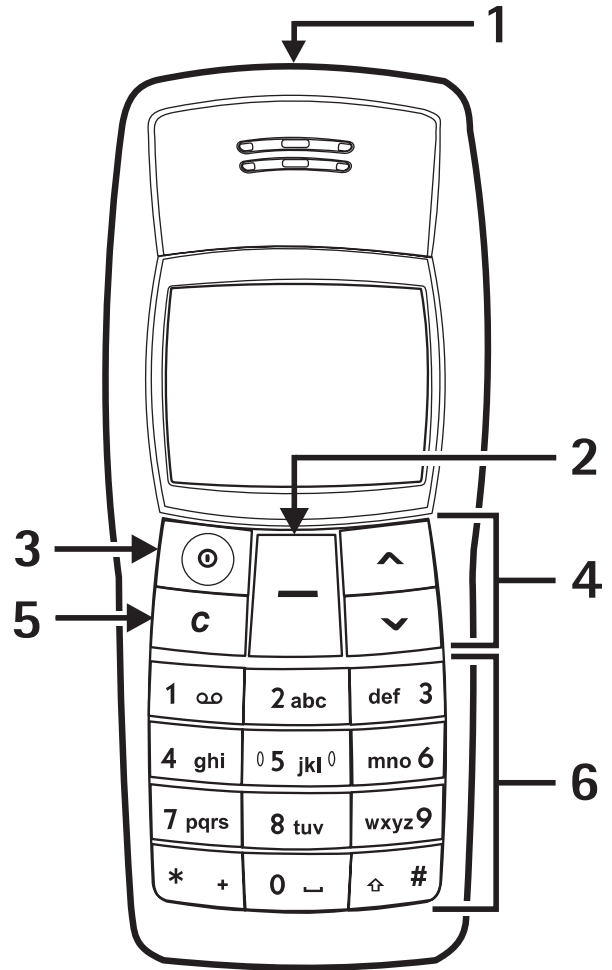

● DISPLAY AND STANDBY MODE

In the standby mode, the indicators described below appear when the phone is ready for use and no characters have been keyed in.

- 1 Cellular network in use, or the operator logo
- 2 Signal intensity of the cellular network at your current location
- 3 Battery charge level
- 4 Current function of the Navi key

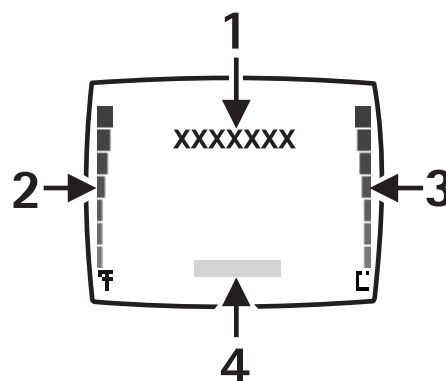

TIPS ON EFFICIENT OPERATION:



Your phone has a built-in antenna. As with any other radio transmitting device, do not touch the antenna unnecessarily when the device is switched on. Contact with the antenna affects call quality and may cause the phone to operate at a higher power level than otherwise needed. Avoid contact with the antenna area when operating the phone to optimize the antenna performance and the battery life.



Hold the phone as you would any other telephone with the antenna pointed up and over your shoulder.

• CHANGE COVERS



Note: Before removing the cover, always switch off the power and disconnect the charger and any other device. Avoid touching electronic components while changing the covers. Always store and use the device with the covers attached.

- 1 Remove the back cover of the phone and battery. See steps 1 and 2 in "Insert the SIM card" on page 4.
- 2 Carefully remove the front cover (3).

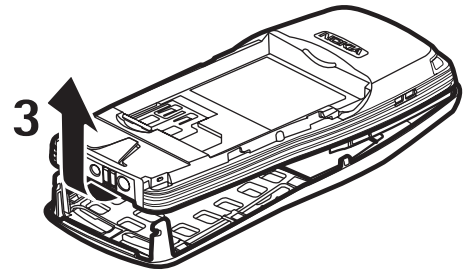

- 3 Remove the keymat carefully (4). Insert the new keymat (5) and make sure it is properly positioned (6).

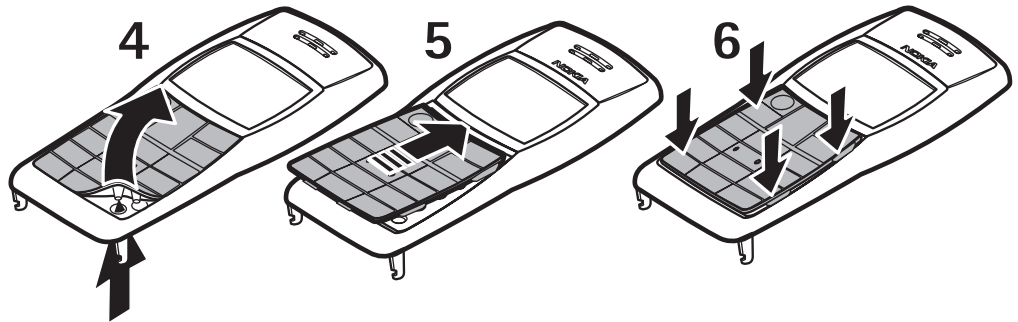

- 4 Align the top of the front cover with the top of the phone and press the front cover to lock it into place (7).

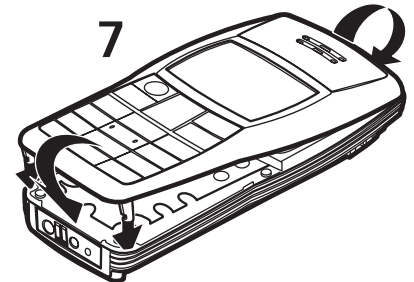

- 5 Insert the battery and replace the back cover. See steps 4 and 5 in "Insert the SIM card" on page 4.

• ATTACH THE WRIST STRAP

Thread the strap through the holes as shown, and tighten it.

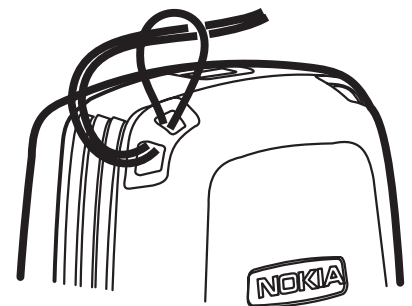

3 Call functions

• MAKE A CALL

- 1 Key in the phone number including the area code.
Press **C** to delete the last entered digit.
- 2 Press **Call**.
Press **^** to increase or **v** to decrease the volume of the earpiece or headset.
- 3 Press **End** to end the call.

Use the phone book

In the standby mode, press **v** to find the name you want, then press **Call**.

Conference calling

Conference calling is a network service that allows up to four people to participate in the same call.

- 1 Call the first participant.
- 2 To call a new participant, press **Options > New call**, and enter the number or select it from the phone book.
- 3 When the call is answered, press **Options > Conference**, to join the conference call.
- 4 To add another participant, repeat steps 1 to 3.
- 5 To end the conference call, press **End**.

Redialing

Press **^**, scroll to the phone number or name you want, and press **Call**.

1-touch dialing

Assign a phone number to a key:

- 1 Press **Menu > Settings > Call settings > 1-touch dialing** and select **On**.
- 2 Press **C** to return to the standby mode.
- 3 Press **Menu > Contacts > 1-touch dialing**.
- 4 Select the key you want, (**2–9**) and press **Assign**.
- 5 Select **Assign to call** or **Assign to SMS**.
- 6 Scroll the name or number you want and press **Select**.

To use 1-touch dialing, press and hold the corresponding number key.

- **ANSWER A CALL**

In the standby mode, press **Answer**. To divert or reject the call without answering, press **C**.

- **IN-CALL OPERATIONS**

During a call, press **C** and **Options** for some of the following functions. Many of these are network services. **Hold** or **Unhold**, **New call**, **Answer**, **Reject**, **End all calls**, **Contacts**, **Send DTMF**, **Swap**, **Menu** and **Mute** or **Unmute**, **Flashlight on** or **Flashlight off**.

- **LISTEN TO VOICE MAIL**

Voice mailbox is a network service. For more information, and to receive your voice mailbox number, contact your service provider.

Press and hold **1**. To change the voice mailbox number, see "Voice mailbox number" on page 17.

To forward calls to your voice mailbox, refer to "Call settings" on page 21.

- **LOCK THE KEYPAD**

The keypad lock prevents accidental key presses.



To lock or unlock the keypad, press **Menu** > ***** quickly. When the keypad is locked,  appears.

You can also Automatic keyguard to lock the keypad after a certain period of time. Refer to "Keyguard settings" on page 22.



Note: When the Keyguard is on, calls still may be possible to the official emergency number programmed into your phone. Key in the emergency number and press **Call**.

4 Writing text

You can enter text two ways: use the traditional text input (indicated with ) or using predictive text input (indicated with ) .

• PREDICTIVE TEXT

Set on or off

When writing text, press **Options** > **Predictive text** > **English** > **OK**.

To revert to traditional text input, select **Prediction off**.



Tip: To quickly set the predictive text input on or off when writing text, press **#** twice.

Use predictive text

Predictive text input is an easy way to write text. It is based on a built-in dictionary to which you can also add new words.

- 1 Key in the word you want by pressing each key once for one letter. The word changes after each keystroke. For example, to write 'Nokia' when the English dictionary is selected, press **6 6 5 4 2**.
 - To delete the character to the left of the cursor, press **C**. To clear the screen, press and hold **C**.
 - To switch between upper and lowercase, or between traditional and predictive text input, press **#** repeatedly and check the indicator at the top of the display.
 - To switch between letters and numbers, press and hold **#**.
 - To get a list of special characters, press and hold *****, select the character you want, and press **Use**.
 - To insert a number, press and hold the number key you want. To insert several numbers, press and hold **#** and key in the numbers.
- 2 If the displayed word is the one you want, press **0** and start writing the next word.
 - To change the word, press ***** repeatedly until the word you want appears.
 - If the "?" is displayed after the word, the word is not in the dictionary. To add the word to the dictionary, press **Spell**, key in the word (using traditional text input), and press **OK**.

Writing compound words

Key in the first half of the word, press **▼** , and key in the second half.

● TRADITIONAL TEXT INPUT

Press the key marked with the letter that you want repeatedly until the letter appears.

Use the following functions to edit the text:

- To add a space, press **0**.
- To add a punctuation mark or special character, press **1** repeatedly, or press *****, select the desired character, and press **Use**.
- To move the cursor left or right, press **^** or **▼**, respectively.
- To delete the character to the left of the cursor, press **C**. To clear the screen, press and hold this key.
- To switch between upper and lower case, press **#**.
- To add a number, press and hold the desired key. To switch between letters and numbers, press and hold **#**.
- To key in a letter which is on the same key as the previous one, press **^** or **▼** (or wait until the cursor appears), and key in the new letter.

5 Menu functions

You can use the key features in the menus in the following ways:

SCROLLING

- 1 Press **Menu** in the standby mode.
- 2 Press **^** or **v** to scroll to the main menu you want, and press **Select** to enter it. Press **C** to exit a main menu.
- 3 If the menu contains submenus, scroll to the one you want and press **Select** to enter it. Press **C** to exit a submenu.

If you do not want to save the changes you made to menu settings, press and hold **C**.

SHORTCUT

The menus, submenus, and setting options are numbered. These numbers are called shortcut numbers.

In the standby mode, press **Menu** and key in quickly, within three seconds, the shortcut number of the menu you want to access. Repeat for submenus.

For example, if you want to activate **Call waiting service**, press **Menu > 7** (for **Settings**), **2** (for **Call settings**), **4** for **Call waiting service**), **1** (for **Activate**).

Note that the shortcut number for **Messages** is **0-1** because there are more than 10 menus.

● LIST OF MENU FUNCTIONS

Messages 0-1



Contacts 2



Call log 4



Tones 5



Profiles 6



Settings 7



Alarm clock 8



Reminders 9



Games 10



Extras 11



SIM services 12
(if available)



• MESSAGES (MENU 0-1)

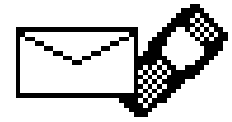

Write messages

Your Nokia 1100 phone lets you send text messages beyond the normal 160-character limit (check with your service provider to make sure their system can handle long messages). If your message exceeds 160 characters, it will be sent as a series of two to four messages. As you write the message, look in the upper right part of the screen. You can see the message length indicator counting backwards from 459. For example, **420/1** means that you have used 39 characters and the message will be sent in one part. But **298/2** means that you have used 161 characters, so the message will be divided and sent in two parts.

Using special (Unicode) characters, such as *ë, â, á, ì*, takes up more space. If there are special characters in your message, the indicator may not show the message length correctly. Before the message is sent, the Nokia 1100 phone tells you if the message exceeds the maximum length allowed for one message. You can cancel sending by pressing **Cancel** or you can save the message in the inbox.

To send a message, the phone number of your message **center** has to be saved in the phone. See "Message settings" on page 16.

- 1 In the standby mode, press **Menu > Messages > Create message**.
- 2 Key in the message. The number of available characters and the current part number are shown on the top right of the display.
- 3 When the message is complete, press **Options > Send**, key in the recipient's phone number, and press **OK**.

If you want to send the message to several people, select **Sending options** and **Send to many**, scroll to the first recipient, and press **Send**. Repeat this for each recipient.

To send a message to a predefined distribution list, select **Sending options** and **Send to list**. To define and edit distribution lists, see "Distribution lists" on page 15.

Other options are **Insert options**, **Use template**, **Small fonts**, **Save message**, **Clear text**, **Predictive text**, **Instructions**, and **Exit editor**.



Note: When sending messages using the SMS network service, your phone may display the words **Message sent**. This is an indication that the message has been sent by your phone to the message center number programmed into your phone. This is not an indication that the message has been received at the intended destination. For more details about SMS services, check with your service provider.

Read a text message (Inbox)

When you have received text messages in the standby mode, the number of new messages as well as a  are shown on the display.

- 1 Press **Show** to view the messages immediately.
To view the messages later, press **C**. When ready to read the message, go to the **Inbox** menu (**Menu 0-1-2**).
- 2 Use the scroll keys to browse through the message.
While reading the message, you can press **Options** for these functions: **Delete**, **Reply**, **Edit**, **Use**, **Forward**, **As reminder**, **Small fonts**, and **Details**.

Sent items

The **Sent items** menu lets you view the copies of the messages that you have sent. Press **Options** for these functions: **Use**, **Forward**, **Delete**, **Edit**, **Details**.

Drafts

In the **Drafts** menu, you can view the messages you have saved in the **Write message** menu.

Picture messages

You can receive and send messages that contain pictures (network service). Picture messages are saved in the phone. Note that each picture message comprises several text messages. Therefore, sending one picture message may cost more than one text message.



Note: This function can be used only if it is supported by your network operator or service provider. Only compatible phones that offer picture message features can receive and display picture messages.

RECEIVING A PICTURE MESSAGE

To view the message immediately, press **Show**. Press **Options** and you have the following options for the picture message: **Delete**, **Reply**, **Chat**, **Edit text**, **Save picture**, **as screensaver**, **Use number**, **Copy to Reminder** and **Details**.

Distribution lists

If you need to send messages frequently to a fixed group of recipients, you can define a distribution list and use it when sending a message. You can define up to 6 distribution lists with up to 10 recipients in each. The phone sends a text message to each recipient separately.

To view and edit distribution lists, press **Menu > Messages > Distribution lists**. Press **Options** to create a distribution list.

If a message fails to be sent to one or more recipients, a report listing the number of failures, successful sendings and not found names will be displayed. You can select each category by pressing **Select**.

- Names in the not found group are names in the distribution list that have been deleted from the phone book. Press **Remove** to remove them.
- **Resend** to resend the message to the failed recipients.
- **View** to view the list of failed recipients.

Templates

You can view or edit the preset messages (templates) that you can use for writing a message.

Smileys

You can edit and store the smileys such as ":-)", and use them in compiling messages.

Delete messages

Press **Menu > Messages > Delete messages**.

To delete all read messages from all folders, select **All read > OK**. When **Delete read messages from all folders?** appears, press **OK**.

To delete all the read messages in a folder, scroll to the folder and press **OK**. Then press **OK** when **Delete all read messages from folder?** appears.

Message settings

The phone offers two kinds of message settings: settings specific to each setting group (profile) and settings common to all text messages.

TEXT MSG (MENU 0-1-1-0-1)

This profile contains settings needed for sending text and picture messages. The settings include **Message center number** (get this number from your service provider), **Messages sent as**, **Message validity**, and **Rename sending profile**. You must have the message center number to send text and picture messages. The total number of profiles depends on how many your SIM card offers.

COMMON (MENU 0-1-1-0-2)

The settings in this submenu apply to all text messages that you send, regardless of the chosen profile. The available settings are: **Delivery reports**, **Reply via same center** and **Character support**.

Select **Character support** to define how the phone handles Unicode characters in text messages. (Check with your service provider for availability.)

The **Full** option sends all Unicode characters in a text message to a compatible phone (if supported by your network).

The **Reduced** option tries to convert Unicode characters into the corresponding non-Unicode characters (for example 'á' to 'a'). If no non-Unicode counterpart exists, the characters are sent unchanged.

Info service

With this network service, you can receive messages on various topics from the network. For details, contact your service provider.

Voice mailbox number

You can save and change the phone number of your voice mailbox (network service).

Service command editor

You can send service requests to your service provider. Key in the characters you want. Press and hold **#** to switch between letters and numbers. Press **Send** to send the request.



• CONTACTS (MENU 2)

You can save names and phone numbers in phone memory (internal phone book) and in SIM card memory (SIM phone book). The internal phone book can store up to 50 names.



Searching for a name and phone number

In the standby mode, press **Menu** > **Contacts** > **Find**. Key in the first characters of the name you are looking for and press **Find**. Scroll to find the name you want.

If the name or phone number is saved in SIM card memory,  is shown at the upper right corner of the display; if it is saved in phone internal memory,  is shown instead.



Tip: For a quick search, press **▼** in the standby mode, key in the first letter of the name. Scroll to find the name you want.

You can also use the following options:

- **Service Nos.** to call the service numbers of your service provider if the numbers are included on your SIM card (network service).
- **Add contact** to save names and phone numbers in the phone book.
- **Delete** to delete names and phone numbers from the phone book one by one or all at once.
- **Edit** to edit the names and numbers in **Contacts**.
- **Copy** to copy names and phone numbers all at once or one by one from phone memory to SIM card memory, or vice versa.
- **Assign tone** to set the phone to play the ringing tone you want when you receive a call from a particular phone number. Select the phone number or name you want and press **Assign**. Note that this function only works when both the network and the phone are able to identify and send the caller's identity.
- **Send phone no.** to send a person's phone number as an over the air (OTA) message if supported by the network.

Phone book settings

In the standby mode, press **Menu > Contacts > Settings**. Then select from the following:

Memory in use—to select whether the names and phone numbers are saved in **SIM card** or **Phone**. Note that when you change the SIM card, **SIM card** memory is automatically selected.

Contacts view—to select how the names and phone numbers are shown, either **Name + number** (one name and number at a time), or **Contacts list** (three names at a time).

Memory status—to check how many names and phone numbers are already saved and how many can still be saved in each phone book.

• CALL LOG (MENU 4)

The call log records information about calls you make and receive. The phone stores the numbers of the last ten calls that you missed, the last ten calls that you received, and the last ten calls that you dialed. For call log to work properly:

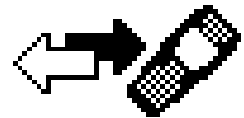

- You must be in a digital network, your service provider must support caller ID, and it must be enabled in the phone.
- Your calls cannot be blocked.
- Your phone must be on and within the service area, or in a compatible network if roaming.

Check missed, received, or dialed calls

- 1 From the menu select **Call log**; then select either **Missed calls**, **Received calls**, or **Dialed numbers**.
- 2 Scroll through the list of numbers and highlight your selection.
- 3 Select **Options**; then select one of the following options:
 - Call**—Dial the number from the call log.
 - Send message**—Send a text message to the person who called you or whom you called.
 - Call time**—Show the time when the call was connected.
 - Edit number**—Edit the number and save it with a name to your phone book.
 - Save**—Enter a name for the number and save both to your phone book.
 - Delete**—Erase the number from the call list.

Delete recent call lists



Note: You cannot undo this operation.

From the menus, select **Call log > Delete recent call lists > All, Missed, Dialed, or Received**.

Call timers

Your phone tracks the amount of time you spend on each call.



Note: The actual time invoiced for calls by your service provider may vary, depending upon network features, rounding off for billing, and so forth.

View call durations

- 1 From the menus, select **Call log > Call timers**.
- 2 Select one of the following options:
- 3 **Duration of last call**—Show the call duration of the last call.
- 4 **Duration of all calls**—Show the call duration of all calls that have been made and received since you reset the timers.
- 5 **Duration of received calls**—Show the duration of all received calls.
- 6 **Duration of dialed calls**—Show the duration of all calls dialed.
- 7 **Clear timers**—Clear all call timers for the currently selected phone number. (Your phone includes separate timers for each number used.) This action cannot be undone.

Clear call timers

- 8 Press **Menu > Call log > Call timers > Clear timers**.
- 9 Enter your security code and select **OK**.

Prepaid credit



Note: This feature is not available in all areas and may not appear in the menu. Check with your service provider for availability.

When using a prepaid SIM card, you can make calls only when there are enough credit units on the SIM card (network service). Options are **Credit info display** (show or hide remaining units in the standby mode), **Credit available** (amount of remaining units), **Last event costs**, and **Recharge status**.



Note: When no charging or currency units remain, calls may only be possible to the emergency number programmed into your phone (for example, 911).

• TONES (MENU 5)

In this menu, you can change the settings of the currently selected profile and create ringing tones of your own. See "Profiles (Menu 6)" on page 20.



Ringing tone—Sets the tone that you hear when you receive a call.

Ringing volume—Sets the volume level for the ringing and message alert tones.

Ringing options—Defines how the phone notifies you of incoming voice calls. For example, when **Silent** is selected, the phone stays silent when you receive a call and  is shown in the standby mode.

Message alert tone—Sets the tone that you hear when you receive a text message.

Keypad tones—Sets the volume for keypad tones.

Warning tones—Sets the phone to sound tones, e.g. when the battery is running out of power.

Vibrating alert—Sets the phone to vibrate when you receive a call or a text message. The vibrator does not operate when the phone is connected to a charger.

Rhythmic backlight alert—Sets the backlights of the phone to flash in the rhythm of the selected ringing tone or message alert tone.

● PROFILES (MENU 6)

You can customize the phone for different events and environments. Initially, personalize the setting groups and profiles to your liking and then you only need to activate a profile to use it.

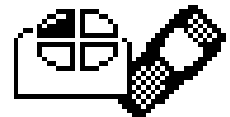

Activate and customize

In the Profiles menu, select a profile and press **OK**.

To change the settings of the profile, select **Customize > OK**. Available options are **Ringing tone, Ringing volume, Ringing options, Message alert tone, Keypad tones, Warning tones, Vibrating alert, Rhythmic backlight alert, Screen saver, or Rename** (not available under **Normal**). Select the option you want and press **OK**.

You can also change the settings of the currently selected profile in **Tone settings**, see "Tones (Menu 5)" on page 19.



Tip: To activate a profile quickly in the standby mode or during a call, press and release the power key, scroll to the desired profile, and press **OK**.

● SETTINGS (MENU 7)

In this menu you can adjust various settings of the phone. You can also reset some menu settings to their default values by choosing **Restore factory settings**.



Time and date settings

CLOCK

Lets you set the phone to show the current time in the standby mode, adjust the time, and select the 12- or 24-hour time format. If the battery was removed from the phone, you may need to set the time again.

DATE SETTING

Lets you set the correct date. If the battery was removed from the phone, you may need to set the date again.

AUTO UPDATE OF DATE & TIME

This network service updates the date and time according to the current time zone. The automatic update of date and time does not change the time you have set for the alarm clock or the reminder notes. They are in local time. Updating may cause some alarms that you have set to expire without sounding.

Call settings

- **Call forwarding** forwards incoming calls to your voice mailbox or to some other phone number (network service).

Select the forwarding option you want, for example, select **Forward if busy** to forward the calls when you are on a call or when you reject a call.

Several forwarding options may be active at the same time. When **Forward all voice calls** is active,  appears.

Set the selected option on (**Activate**) or off (**Cancel**), check whether the option is activated by selecting **Check status**, or specify a delay for certain diverts in **Set delay** (not available for all forwarding options).

- **Automatic redial** sets your phone to redial up to ten times after an unsuccessful call attempt.
- **1-touch dialing** lets you press and hold the 1-touch dial keys (**2–9**) to dial names and phone numbers assigned to the corresponding keys.
- **Call waiting** is a network service that notifies you of a new incoming call while you have a call in progress. Press **Answer** to answer the waiting call and put the first call on hold. Press **End** to end the active call.
- **Send my own caller ID when calling** is a network service that lets your phone number appear to (**Default** or **Yes**) or be hidden from (**No**) the person you are calling. When you select **Preset**, the setting agreed with your service provider is used.

Phone settings

Language—To select the language for the display texts.

Cell info display—To set the phone to indicate when it is used in a cellular network based on Micro Cellular Network (MCN) technology (network service). For more information, contact your service provider.

Welcome note—You can key in a message that will be shown briefly on the display when the phone is switched on.

Network selection—To set the phone to automatically select a cellular network available in your area, or you can select the network manually. The network you select must have a roaming agreement with your home network.

Confirm SIM service actions—To set the phone to show or hide confirmation messages when you use the SIM card services [see "SIM services (Menu 12)" on page 26].

Enhancement settings

You can use your phone with many Nokia enhancements. However, the **Enhancement settings** menu appears only after an accessory has been connected to the phone at least once. You can select a default profile that will be associated with each accessory.

- Headset (such as the HDC-5 or HDE-2)
- Handsfree Car kit (such as the CARK-125 or PPH-1)
- Loopset (LPS-3)
- TTY/TDD Adapter (HDA-9)

Keyguard settings

Use **Automatic keyguard** to automatically lock the phone keypad after a preset time delay. The phone must be idle in the standby mode. You can also lock the keypad of the phone with **Keyguard code**.

- Select **Menu > Settings > Keyguard settings > Automatic keyguard > On**. When **Set delay** appears, key in the time and press **OK**. You can set the time from 10 seconds to 60 minutes. To deactivate the automatic keyguard, select **Off**.
- Select **Menu > Settings > Keyguard settings > Keyguard code request**, key in the security code, and press **OK**. After you have selected **On**, the phone asks for the security code every time you press **Unlock**. To deactivate the security keyguard, select **Off**.

See also "Lock the keypad" on page 10.

Security settings



Note: When calls are restricted, calls still may be possible to the official emergency number programmed into your phone.

Several types of codes are used in the phone:

- The security code, supplied with the phone, protects your phone against unauthorized use. The preset code is 12345.
- The PIN code, supplied with the SIM card, protects the card against unauthorized use. The preset code is 1234. If you enter the PIN code incorrectly three times in succession, the SIM card is blocked. You must enter the PUK code to unblock the SIM card and set a new PIN code.
- The PIN2 code is supplied with some SIM cards and is required to access certain services, such as charging unit counters. If you enter the PIN2 code incorrectly three times in succession, **PIN2 code blocked** appears on the display, and you will be asked for the PUK2 code.
- The PUK and PUK2 codes may be supplied with the SIM card. If this is not the case, contact your local service provider.

PIN code request—You can set your phone to ask for the PIN code of the SIM card when the phone is switched on. Some SIM cards require activating this function at all times.

Call restrictions—This network service lets you restrict incoming and outgoing calls with your phone. Choose an option and select **Activate**, **Cancel**, or check whether a service is activated (**Check status**).

Fixed dialling—This network service lets you restrict outgoing calls to selected phone numbers.

Closed user group—This network service lets you specify a group of people whom you can call and who can call you.

Security level—Sets the phone to ask for the security code when a new SIM card is inserted in the phone or when you select the internal phone book.



Note: When you change the security level, all the recent calls lists are cleared, including missed calls, received calls and dialed numbers.

Change of access codes—Lets you change the security code, PIN code, PIN2 code, or restriction password. These codes can include the numbers 0 to 9 only.

Avoid using access codes similar to the emergency numbers, such as 911, to prevent accidental dialling of the emergency number.

Restore factory settings

To reset some of the menu settings to their original values. Press **Menu** > **Settings** > **Restore factory settings**. Key in the security code and press **OK**. The names and phone numbers saved in the phone book are not deleted.

• ALARM CLOCK (MENU 8)

You can set the alarm to sound at the time you want just once, or repeatedly, for example every working day.



Press **Menu** > **Alarm clock**. Key in the time for the alarm. When the alarm sounds, pressing **C** to stop it. If you press **Snooze**, the alarm stops and rings again in 5 minutes.

If the alarm time is reached while the phone is switched off, the phone switches itself on and starts sounding the alarm tone. If you press **C**, the phone asks whether you want to activate the phone for calls. Press **C** to switch off the phone or **Yes** to make and receive calls.



Note: Do not press **Yes** when wireless phone use is prohibited or when it may cause interference or danger.

• REMINDERS (MENU 9)



Note: Your phone must be switched on to use this function. Do not switch on the phone when wireless phone use is prohibited or when it may cause interference or danger.

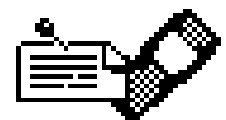

With this memory aid, you can save up to 10 short text notes with an alarm. The alarm is activated when the set date and time is reached.

You can select: **Add new**, **View all**, **Delete**, **Edit** or **To calendar** to add a new reminder, view, edit or send the existing reminders and delete the reminders one by one or all at once.

When the reminder time is reached, you can stop the alarm by pressing **C**. If you press **Snooze**, the phone alarms again in about 10 minutes.

• GAMES (MENU 10)

The phone offers you some games to play. Each game is provided with a brief help text.

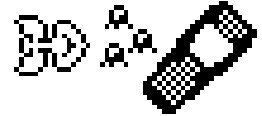

Adjust common game settings

Select **Settings**. You can set the sounds, lights, and vibrations (**Shakes**) for the game. Note that when **Warning tones (Menu 5-1-6)** is off, there may be no sound even if **Game sounds** is on. When **Vibrating alert (Menu 5-1-7)** is off, the phone does not vibrate even if **Shakes** is on.

• EXTRAS (MENU 11)

Calculator

The phone is provided with a calculator that can also be used for rough currency conversions.

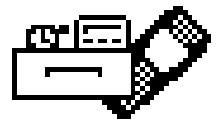

Note: This calculator has limited accuracy and is designed for simple calculations.

Select **Menu > Extras > Calculator**.

MAKE A CALCULATION

- The keys **1-9** insert a digit. The **#** key inserts a decimal point. Press **C** to delete the last digit. To change the sign, press **Options** and select **Change sign**.
- Press ***** once for add (+), twice for subtract (-), three times for multiply (*), and four times for divide (/).
- To get the result, press **Options** and select **Equals**. Press and hold **C** to clear the display for a new calculation.

CURRENCY CONVERSION

To save the exchange rate, press **Options > Exchange rate > Foreign unit expressed in domestic units** or **Domestic unit expressed in foreign units**, key in the value (press **#** for a decimal point), and press **OK**.

To make the conversion, key in the currency amount to be converted, press **Options > In domestic** or **In foreign**.

Stopwatch

The stopwatch can be used for time measurement, for example in different sports. Select **Menu > Extras > Stopwatch**.

Press **Start** to start timing. To take the time, press **Stop**. When the timing is stopped, press **Options** for **Start**, **Reset**, or **Exit**. If you select **Start**, timing continues from the previous stop time. **Reset** stops the current timing and sets the time to zero.

To set the timing to continue in the background, press **C** three times. While the time is running,  is flashing in the standby mode.



Note: Using the stopwatch consumes the battery and phone operating time will be reduced. Be careful not to let it run in the background when performing other operations with your phone.

Countdown timer

You can set the alarm to sound after a period of lapsed time. The countdown timer contains two separate timers. Traditional timer enables you to activate the timer quickly for simple tasks. Interval timers enables you to save cyclic time periods, for example, for different exercises.

Select **Menu > Extras > Countdown timer**. Key in the alarm time and press **OK**. You can also key in a note for the alarm, change the time and stop the timer.

When the timer is running,  is shown in the standby mode.

When the alarm time is reached, the phone sounds a tone and a note for the alarm appears. Press any key to stop the alarm.

Composer

You can create your own ringing tones. Select the tone that you want to edit and key in the notes. For example, press **4** for note F.

The **8** key shortens (-) and the **9** key lengthens (+) the duration of the note or rest. Insert a rest with **0**. The ***** key sets the octave and the **#** key makes the note sharp (not available for notes E and B). Use **^** and **v** to move the cursor left or right. Press **C** to delete a note or rest to the left of the cursor.

C	D	E
F	0	G
B	-	+
123	_	#

When the tone is complete, press **Options** and select **Play**, **Save**, **Tempo**, **Clear screen** or **Exit**

Screen saver

Choose a picture for the phone display. Select **Menu > Extras > Screen saver**, then scroll to select the picture. You can choose the **Time-out** duration so the picture appears after a pause of only five seconds or as long as 10 minutes. The picture stays visible until you press any key. Note that the screen saver overrides all the graphics and texts on the display in the standby mode.

Flashlight

To activate the flashlight, press **Menu > Extras > Flashlight > On** or **Off**. The following options are available:

- In the standby mode, press and release **C**. The flashlight comes on for about 1.5 seconds and  appears.
- Press and hold **C**. The flashlight stays on while you hold the key and goes off when you release the key.
- To turn the flashlight on continuously, press **C** twice. Press **C** again to turn it off.
- During a call, press **Options > Flashlight on** or **Flashlight off**

• SIM SERVICES (MENU 12)

This menu appears only if your SIM card provides additional services. The name and contents of this menu depend on the services available.



Note: For availability, rates and information on using SIM services, contact your SIM card vendor or service provider.

• ENHANCEMENTS

Battery	BL-5C
Chargers	ACP-7, ACP-8, ACP-12
Mobile chargers	LCH-9, LCH-12
Car kit	HFM-8, PPH-1
Headsets	HDC-5, HDE-2, HDD-1, HDC-10
Inductive loopset	LPS-3
Xpress-on covers Carry cases Wrist strap wearables	Several styles to choose from

6 Reference Information

• BATTERY INFORMATION

Charging and discharging

Your device is powered by a rechargeable battery. The full performance of a new battery is achieved only after two or three complete charge and discharge cycles. The battery can be charged and discharged hundreds of times but it will eventually wear out. When the talk and standby times are noticeably shorter than normal, buy a new battery. Use only Nokia approved batteries, and recharge your battery only with Nokia approved chargers designated for this device.

Unplug the charger from the electrical plug and the device when not in use. Do not leave the battery connected to a charger. Overcharging may shorten its lifetime. If left unused, a fully charged battery will lose its charge over time. Temperature extremes can affect the ability of your battery to charge.

Use the battery only for its intended purpose. Never use any charger or battery that is damaged.

Do not short-circuit the battery. Accidental short-circuiting can occur when a metallic object such as a coin, clip, or pen causes direct connection of the positive (+) and negative (-) terminals of the battery. (These look like metal strips on the battery.) This might happen, for example, when you carry a spare battery in your pocket or purse. Short-circuiting the terminals may damage the battery or the connecting object.

Leaving the battery in hot or cold places, such as in a closed car in summer or winter conditions, will reduce the capacity and lifetime of the battery. Always try to keep the battery between 59°F and 77°F (15°C and 25°C). A device with a hot or cold battery may not work temporarily, even when the battery is fully charged. Battery performance is particularly limited in temperatures well below freezing.

Do not dispose of batteries in a fire! Dispose of batteries according to local regulations. Please recycle when possible. Do not dispose as household waste.

BL-5C Talk time, Standby time	Talk-time: up to 4.5 hours Standby time: up to 10 days
BL-5C Charging time (approximate)	ACP-7 Charger—3 hours ACP-8 Charger—2 hours ACP-12 Charger—1 hour, 30 min.

Battery talk and standby times are estimates only and depend on signal strength, network conditions, features used, battery age and condition (including the effect of charging habits), temperatures to which battery is exposed, use in digital mode, and many other factors. Please note that the amount of time a phone is used for calls will affect its standby time. Likewise, the amount of time that the phone is turned on and in standby mode will affect its talk-time.

● ENHANCEMENTS

A few practical rules about accessories and enhancements:

- Keep all accessories and enhancements out of the reach of small children.
- When you disconnect the power cord of any accessory or enhancement, grasp and pull the plug, not the cord.
- Check regularly that enhancements installed in a vehicle are mounted and are operating properly.
- Installation of any complex car enhancements must be made by qualified personnel only.



● ENHANCEMENTS, BATTERIES, AND CHARGERS

Check the model number of any charger before use with this device. This device is intended for use when supplied with power from the ACP-7 charger.



Warning: Use only batteries, chargers, and enhancements approved by Nokia for use with this particular model. The use of any other types may invalidate any approval or warranty, and may be dangerous.

For availability of approved enhancements, please check with your dealer. When you disconnect the power cord of any enhancement, grasp and pull the plug, not the cord.

Your device and its enhancements may contain small parts. Keep them out of reach of small children.

● CARE AND MAINTENANCE

Your device is a product of superior design and craftsmanship and should be treated with care. The suggestions below will help you protect your warranty coverage and enjoy your device for many years.

- Keep the device dry. Precipitation, humidity, and all types of liquids or moisture can contain minerals that will corrode electronic circuits. If your device does get wet, remove the battery and allow the device to dry completely before replacing it.
- Do not use or store the device in dusty, dirty areas. Its moving parts and electronic components can be damaged.
- Do not store the device in hot areas. High temperatures can shorten the life of electronic devices, damage batteries, and warp or melt certain plastics.

- Do not store the device in cold areas. When the device returns to its normal temperature, moisture can form inside the device and damage electronic circuit boards.
- Do not attempt to open the device other than as instructed in this guide.
- Do not drop, knock, or shake the device. Rough handling can break internal circuit boards and fine mechanics.
- Do not use harsh chemicals, cleaning solvents, or strong detergents to clean the device.
- Do not paint the device. Paint can clog the moving parts and prevent proper operation.
- Use only the supplied or an approved replacement antenna. Unauthorized antennas, modifications, or attachments could damage the device and may violate regulations governing radio devices.

All of the above suggestions apply equally to your device, battery, charger, or any enhancement. If any device is not working properly, take it to the nearest authorized service facility for service.

• **ADDITIONAL SAFETY INFORMATION**

Operating environment

Remember to follow any special regulations in force in any area and always switch off your device when its use is prohibited or when it may cause interference or danger. Use the device only in its normal operating positions. To maintain compliance with radio frequency exposure guidelines only use accessories approved by Nokia for use with this device. When the device is on and being worn on the body, always use an approved carrying case.

Medical devices

Operation of any radio transmitting equipment, including wireless phones, may interfere with the functionality of inadequately protected medical devices. Consult a physician or the manufacturer of the medical device to determine if they are adequately shielded from external RF energy or if you have any questions. Switch off your phone in health care facilities when any regulations posted in these areas instruct you to do so. Hospitals or health care facilities may be using equipment that could be sensitive to external RF energy.

PACEMAKERS

Pacemaker manufacturers recommend that a minimum separation of 6 inches (15.3 cm) be maintained between a wireless phone and a pacemaker to avoid potential interference with the pacemaker. These recommendations are consistent with the independent research by and recommendations of Wireless Technology Research. To minimize the potential for interference, persons with pacemakers should

- Always keep the device more than 6 inches (15.3 cm) from their pacemaker when the device is switched on
- Not carry the device in a breast pocket

- Hold the device to the ear opposite the pacemaker

If you have any reason to suspect that interference is taking place, switch off your device immediately.

HEARING AID

Some digital wireless devices may interfere with some hearing aids. If interference occurs, consult your service provider.

Vehicles

RF signals may affect improperly installed or inadequately shielded electronic systems in motor vehicles such as electronic fuel injection systems, electronic antiskid (antilock) braking systems, electronic speed control systems, air bag systems. For more information, check with the manufacturer or its representative of your vehicle or any equipment that has been added.

Only qualified personnel should service the device, or install the device in a vehicle. Faulty installation or service may be dangerous and may invalidate any warranty that may apply to the device. Check regularly that all wireless device equipment in your vehicle is mounted and operating properly. Do not store or carry flammable liquids, gases, or explosive materials in the same compartment as the device, its parts, or enhancements. For vehicles equipped with an air bag, remember that an air bags inflate with great force. Do not place objects, including installed or portable wireless equipment in the area over the air bag or in the air bag deployment area. If in-vehicle wireless equipment is improperly installed and the air bag inflates, serious injury could result.

Potentially explosive environments

Switch off your device when in any area with a potentially explosive atmosphere and obey all signs and instructions. Potentially explosive atmospheres include areas where you would normally be advised to turn off your vehicle engine. Sparks in such areas could cause an explosion or fire resulting in bodily injury or even death. Switch off the device at refuelling points such as near gas pumps at service stations. Observe restrictions on the use of radio equipment in fuel depots, storage, and distribution areas, chemical plants or where blasting operations are in progress. Areas with a potentially explosive atmosphere are often but not always clearly marked. They include below deck on boats, chemical transfer or storage facilities, vehicles using liquefied petroleum gas (such as propane or butane), and areas where the air contains chemicals or particles such as grain, dust or metal powders.

AIRCRAFT

FCC regulations prohibit using your wireless device while in the air. The use of wireless telephones in an aircraft may be dangerous to the operation of the aircraft, disrupt the wireless telephone network, and may be illegal.

Failure to observe these instructions may lead to suspension or denial of telephone services to the offender, legal action, or both.

EMERGENCY CALLS



Important: Wireless phones, including this phone, operate using radio signals, wireless networks, landline networks, and user-programmed functions. Because of this, connections in all conditions cannot be guaranteed. You should never rely solely on any wireless phone for essential communications like medical emergencies.

To make an emergency call:

- 1 If the phone is not on, switch it on. Check for adequate signal strength. Some networks may require that a valid SIM card is properly inserted in the phone.
- 2 Press **C** as many times as needed to clear the display and ready the phone for calls. You may need to disable any security features activated on the phone.
- 3 Key in the official emergency number for your present location. Emergency numbers vary by location.
- 4 Press **Call**.

If certain features are in use, you may first need to turn those features off before you can make an emergency call. Consult this guide or your service provider. When making an emergency call, give all the necessary information as accurately as possible. Your wireless phone may be the only means of communication at the scene of an accident. Do not end the call until given permission to do so.

CERTIFICATION INFORMATION (SAR)

THIS MODEL PHONE MEETS THE GOVERNMENT'S REQUIREMENTS FOR EXPOSURE TO RADIO WAVES.

Your wireless phone is a radio transmitter and receiver. It is designed and manufactured not to exceed the emission limits for exposure to radio frequency (RF) energy set by the Federal Communications Commission of the U.S. Government. These limits are part of comprehensive guidelines and establish permitted levels of RF energy for the general population. The guidelines are based on standards that were developed by independent scientific organizations through periodic and thorough evaluation of scientific studies. The standards include a substantial safety margin designed to assure the safety of all persons, regardless of age and health.

The exposure standard for wireless mobile phones employs a unit of measurement known as the Specific Absorption Rate, or SAR. The SAR limit set by the FCC is 1.6W/kg.* Tests for SAR are conducted using standard operating positions accepted by the FCC with the phone transmitting at its highest certified power level in all tested frequency bands. Although the SAR is determined at the highest certified power level, the actual SAR level of the phone while operating can be well below the maximum value. This is because the phone is designed to operate at multiple power levels so as to use only the power required to reach the network. In general, the closer you are to a wireless base station antenna, the lower the power output.

Before a phone model is available for sale to the public, it must be tested and certified to the FCC that it does not exceed the limit established by the government-adopted requirement for safe exposure. The tests are performed in positions and locations (for example, at the ear and worn on the body) as required by the FCC for each model.

The highest SAR value for this model phone as reported to the FCC when tested for use at the ear is .73 W/kg, and when worn on the body, as described in this user guide, is 1.02 W/kg. (Body-worn measurements differ among phone models, depending upon available enhancements and FCC requirements).

While there may be differences between the SAR levels of various phones and at various positions, they all meet the government requirement. The FCC has granted an Equipment Authorization for this model phone with all reported SAR levels evaluated as in compliance with the FCC RF exposure guidelines. SAR information on this model phone is on file with the FCC and can be found under the Display Grant section of <http://www.fcc.gov/oet/fccid> after searching on FCC ID QTKRH-36.

For body worn operation, this phone has been tested and meets the FCC RF exposure guidelines for use with a carry case, belt clip, or holder that contains no metal and that positions the handset a minimum of 5/8-inch (1.5 cm) from the body. Use of other carry cases, belt clips, or holders may not ensure compliance with FCC RF exposure guidelines. If you do not use a body-worn accessory and are not holding the phone at the ear, position the handset a minimum of 5/8-inch (1.5 cm) from your body when the phone is switched on.

*In the United States and Canada, the SAR limit for mobile phones used by the public is 1.6 watts/kilogram (W/kg) averaged over one gram of tissue. The standard incorporates a substantial margin of safety to give additional protection for the public and to account for any variations in measurements. SAR values may vary depending on national reporting requirements and the network band. For SAR information in other regions please look under product information at **www.nokia.com**.

7 Nokia One-Year Limited Warranty

Nokia Inc. ("Nokia") warrants that this cellular phone ("Product") is free from defects in material and workmanship that result in Product failure during normal usage, according to the following terms and conditions:

- 1 The limited warranty for the Product extends for ONE (1) year beginning on the date of the purchase of the Product. This one year period is extended by each whole day that the Product is out of your possession for repair under this warranty.
- 2 The limited warranty extends only to the original purchaser ("Consumer") of the Product and is not assignable or transferable to any subsequent purchaser/end-user.
- 3 The limited warranty extends only to Consumers who purchase the Product in the United States of America.
- 4 During the limited warranty period, Nokia will repair, or replace, at Nokia's sole option, any defective parts, or any parts that will not properly operate for their intended use with new or refurbished replacement items if such repair or replacement is needed because of product malfunction or failure during normal usage. No charge will be made to the Consumer for any such parts. Nokia will also pay for the labor charges incurred by Nokia in repairing or replacing the defective parts. The limited warranty does not cover defects in appearance, cosmetic, decorative or structural items, including framing, and any non-operative parts. Nokia's limit of liability under the limited warranty shall be the actual cash value of the Product at the time the Consumer returns the Product for repair, determined by the price paid by the Consumer for the Product less a reasonable amount for usage. Nokia shall not be liable for any other losses or damages. These remedies are the Consumer's exclusive remedies for breach of warranty.
- 5 Upon request from Nokia, the Consumer must prove the date of the original purchase of the Product by a dated bill of sale or dated itemized receipt.
- 6 The Consumer shall bear the cost of shipping the Product to Nokia in Melbourne, Florida. Nokia shall bear the cost of shipping the Product back to the Consumer after the completion of service under this limited warranty.
- 7 The Consumer shall have no coverage or benefits under this limited warranty if any of the following conditions are applicable:
 - a) The Product has been subjected to abnormal use, abnormal conditions, improper storage, exposure to moisture or dampness, unauthorized modifications, unauthorized connections, unauthorized repair, misuse, neglect, abuse, accident, alteration, improper installation, or other acts which are not the fault of Nokia, including damage caused by shipping.

- b) The Product has been damaged from external causes such as collision with an object, or from fire, flooding, sand, dirt, windstorm, lightning, earthquake or damage from exposure to weather conditions, an Act of God, or battery leakage, theft, blown fuse, or improper use of any electrical source, damage caused by computer or internet viruses, bugs, worms, Trojan Horses, cancelbots or damage caused by the connection to other products not recommended for interconnection by Nokia.
 - c) Nokia was not advised in writing by the Consumer of the alleged defect or malfunction of the Product within fourteen (14) days after the expiration of the applicable limited warranty period.
 - d) The Product serial number plate or the accessory data code has been removed, defaced or altered.
 - e) The defect or damage was caused by the defective function of the cellular system or by inadequate signal reception by the external antenna, or viruses or other software problems introduced into the Product.
- 8 Nokia does not warrant uninterrupted or error-free operation of the Product. If a problem develops during the limited warranty period, the Consumer shall take the following step-by-step procedure:
- a) The Consumer shall return the Product to the place of purchase for repair or replacement processing.
 - b) If "a" is not convenient because of distance (more than 50 miles) or for other good cause, the Consumer shall ship the Product prepaid and insured to:
Nokia Inc., Attn: Repair Department
795 West Nasa Blvd.
Melbourne, FL 32901
 - c) The Consumer shall include a return address, daytime phone number and/or fax number, complete description of the problem, proof of purchase and service agreement (if applicable). Expenses related to removing the Product from an installation are not covered under this limited warranty.
 - d) The Consumer will be billed for any parts or labor charges not covered by this limited warranty. The Consumer will be responsible for any expenses related to reinstallation of the Product.
 - e) Nokia will repair the Product under the limited warranty within 30 days after receipt of the Product. If Nokia cannot perform repairs covered under this limited warranty within 30 days, or after a reasonable number of attempts to repair the same defect, Nokia at its option, will provide a replacement Product or refund the purchase price of the Product less a reasonable amount for usage. In some states the Consumer may have the right to a loaner if the repair of the Product takes more than ten (10) days. Please contact the Customer Service Center at Nokia at the telephone number listed at the end of this warranty if you need a loaner and the repair of the Product has taken or is estimated to take more than ten (10) days.

- f) If the Product is returned during the limited warranty period, but the problem with the Product is not covered under the terms and conditions of this limited warranty, the Consumer will be notified and given an estimate of the charges the Consumer must pay to have the Product repaired, with all shipping charges billed to the Consumer. If the estimate is refused, the Product will be returned freight collect. If the Product is returned after the expiration of the limited warranty period, Nokia's normal service policies shall apply and the Consumer will be responsible for all shipping charges.
- 9 You (the Consumer) understand that the product may consist of refurbished equipment that contains used components, some of which have been reprocessed. The used components comply with Product performance and reliability specifications.
- 10 ANY IMPLIED WARRANTY OF MERCHANTABILITY, OR FITNESS FOR A PARTICULAR PURPOSE OR USE, SHALL BE LIMITED TO THE DURATION OF THE FOREGOING LIMITED WRITTEN WARRANTY. OTHERWISE, THE FOREGOING LIMITED WARRANTY IS THE CONSUMER'S SOLE AND EXCLUSIVE REMEDY AND IS IN LIEU OF ALL OTHER WARRANTIES, EXPRESS OR IMPLIED. NOKIA SHALL NOT BE LIABLE FOR SPECIAL, INCIDENTAL, PUNITIVE OR CONSEQUENTIAL DAMAGES, INCLUDING BUT NOT LIMITED TO LOSS OF ANTICIPATED BENEFITS OR PROFITS, LOSS OF SAVINGS OR REVENUE, LOSS OF DATA, PUNITIVE DAMAGES, LOSS OF USE OF THE PRODUCT OR ANY ASSOCIATED EQUIPMENT, COST OF CAPITAL, COST OF ANY SUBSTITUTE EQUIPMENT OR FACILITIES, DOWNTIME, THE CLAIMS OF ANY THIRD PARTIES, INCLUDING CUSTOMERS, AND INJURY TO PROPERTY, RESULTING FROM THE PURCHASE OR USE OF THE PRODUCT OR ARISING FROM BREACH OF THE WARRANTY, BREACH OF CONTRACT, NEGLIGENCE, STRICT TORT, OR ANY OTHER LEGAL OR EQUITABLE THEORY, EVEN IF NOKIA KNEW OF THE LIKELIHOOD OF SUCH DAMAGES. NOKIA SHALL NOT BE LIABLE FOR DELAY IN RENDERING SERVICE UNDER THE LIMITED WARRANTY, OR LOSS OF USE DURING THE PERIOD THAT THE PRODUCT IS BEING REPAIRED.
- 11 Some states do not allow limitation of how long an implied warranty lasts, so the one year warranty limitation may not apply to you (the Consumer). Some states do not allow the exclusion or limitation of incidental and consequential damages, so certain of the above limitations or exclusions may not apply to you (the Consumer). This limited warranty gives the Consumer specific legal rights and the Consumer may also have other rights which vary from state to state.
- 12 Nokia neither assumes nor authorizes any authorized service center or any other person or entity to assume for it any other obligation or liability beyond that which is expressly provided for in this limited warranty including the provider or seller of any extended warranty or service agreement.
- 13 This is the entire warranty between Nokia and the Consumer, and supersedes all prior and contemporaneous agreements or understandings, oral or written, relating to the Product, and no representation, promise or condition not contained herein shall modify these terms.

- 14** This limited warranty allocates the risk of failure of the Product between the Consumer and Nokia. The allocation is recognized by the Consumer and is reflected in the purchase price.
- 15** Any action or lawsuit for breach of warranty must be commenced within eighteen (18) months following purchase of the Product.
- 16** Questions concerning this limited warranty may be directed to:
Nokia Inc.
Attn: Customer Service
7725 Woodland Center Blvd., Ste. 150
Tampa, FL 33614
Telephone: 1-888-NOKIA-2U (1-888-665-4228)
Facsimile: (813) 287-6612
TTY/TDD Users Only: 1-800-24-NOKIA (1-800-246-6542)
- 17** The limited warranty period for Nokia supplied attachments and accessories is specifically defined within their own warranty cards and packaging.

NOTES

Appendix A

Message from the CTIA (Cellular Telecommunications & Internet Association) to all users of mobile phones.

© 2001 Cellular Telecommunications & Internet Association. All Rights Reserved. 1250 Connecticut Avenue, NW Suite 800, Washington, DC 20036. Phone: (202) 785-0081

Safety is the most important call you will ever make.

A Guide to Safe and Responsible Wireless Phone Use

Tens of millions of people in the U.S. today take advantage of the unique combination of convenience, safety and value delivered by the wireless telephone. Quite simply, the wireless phone gives people the powerful ability to communicate by voice--almost anywhere, anytime--with the boss, with a client, with the kids, with emergency personnel or even with the police. Each year, Americans make billions of calls from their wireless phones, and the numbers are rapidly growing.

But an important responsibility accompanies those benefits, one that every wireless phone user must uphold. When driving a car, driving is your first responsibility. A wireless phone can be an invaluable tool, but good judgment must be exercised at all times while driving a motor vehicle--whether on the phone or not.

The basic lessons are ones we all learned as teenagers. Driving requires alertness, caution and courtesy. It requires a heavy dose of basic common sense---keep your head up, keep your eyes on the road, check your mirrors frequently and watch out for other drivers. It requires obeying all traffic signs and signals and staying within the speed limit. It means using seatbelts and requiring other passengers to do the same.

But with wireless phone use, driving safely means a little more. This brochure is a call to wireless phone users everywhere to make safety their first priority when behind the wheel of a car. Wireless telecommunications is keeping us in touch, simplifying our lives, protecting us in emergencies and providing opportunities to help others in need.

When it comes to the use of wireless phones, *safety is your most important call.*

Wireless Phone "Safety Tips"

Below are safety tips to follow while driving and using a wireless phone which should be easy to remember.

- 1 Get to know your wireless phone and its features such as speed dial and redial. Carefully read your instruction manual and learn to take advantage of valuable features most phones offer, including automatic redial and memory. Also, work to memorize the phone keypad so you can use the speed dial function without taking your attention off the road.
- 2 When available, use a hands free device. A number of hands free wireless phone accessories are readily available today. Whether you choose an installed mounted device for your wireless phone or a speaker phone accessory, take advantage of these devices if available to you.
- 3 Position your wireless phone within easy reach. Make sure you place your wireless phone within easy reach and where you can grab it without removing your eyes from the road. If you get an incoming call at an inconvenient time, if possible, let your voice mail answer it for you.
- 4 Suspend conversations during hazardous driving conditions or situations. Let the person you are speaking with know you are driving; if necessary, suspend the call in heavy traffic or hazardous weather conditions. Rain, sleet, snow and ice can be hazardous, but so is heavy traffic. As a driver, your first responsibility is to pay attention to the road.

- 5 Do not take notes or look up phone numbers while driving. If you are reading an address book or business card, or writing a "to do" list while driving a car, you are not watching where you are going. It's common sense. Don't get caught in a dangerous situation because you are reading or writing and not paying attention to the road or nearby vehicles.
- 6 Dial sensibly and assess the traffic; if possible, place calls when you are not moving or before pulling into traffic. Try to plan your calls before you begin your trip or attempt to coincide your calls with times you may be stopped at a stop sign, red light or otherwise stationary. But if you need to dial while driving, follow this simple tip--dial only a few numbers, check the road and your mirrors, then continue.
- 7 Do not engage in stressful or emotional conversations that may be distracting. Stressful or emotional conversations and driving do not mix--they are distracting and even dangerous when you are behind the wheel of a car. Make people you are talking with aware you are driving and if necessary, suspend conversations which have the potential to divert your attention from the road.
- 8 Use your wireless phone to call for help. Your wireless phone is one of the greatest tools you can own to protect yourself and your family in dangerous situations--with your phone at your side, help is only three numbers away. Dial 9-1-1 or other local emergency number in the case of fire, traffic accident, road hazard or medical emergency. Remember, it is a free call on your wireless phone!
- 9 Use your wireless phone to help others in emergencies. Your wireless phone provides you a perfect opportunity to be a "Good Samaritan" in your community. If you see an auto accident, crime in progress or other serious emergency where lives are in danger, call 9-1-1 or other local emergency number, as you would want others to do for you.
- 10 Call roadside assistance or a special wireless non-emergency assistance number when necessary. Certain situations you encounter while driving may require attention, but are not urgent enough to merit a call for emergency services. But you still can use your wireless phone to lend a hand. If you see a broken-down vehicle posing no serious hazard, a broken traffic signal, a minor traffic accident where no one appears injured or a vehicle you know to be stolen, call roadside assistance or other special non-emergency wireless number.

Careless, distracted individuals and people driving irresponsibly represent a hazard to everyone on the road. Since 1984, the Cellular Telecommunications Industry Association and the wireless industry have conducted educational outreach to inform wireless phone users of their responsibilities as safe drivers and good citizens. As we approach a new century, more and more of us will take advantage of the benefits of wireless telephones. And, as we take to the roads, we all have a responsibility to drive safely.

The wireless industry reminds you to use your phone safely when driving.

For more information, please call 1-888-901-SAFE.

For updates: <http://www.wow-com.com/consumer/issues/driving/articles.cfm?ID=85>

NOTES

Appendix B

Message from the FDA

(U.S. Food and Drug Administration)

to all users of mobile phones.

July 18, 2001.....For updates: <http://www.fda.gov/cdrh/phones>

Consumer Update on Wireless Phones

U.S. Food and Drug Administration

1. Do wireless phones pose a health hazard?

The available scientific evidence does not show that any health problems are associated with using wireless phones. There is no proof, however, that wireless phones are absolutely safe. Wireless phones emit low levels of radiofrequency energy (RF) in the microwave range while being used. They also emit very low levels of RF when in the stand-by mode. Whereas high levels of RF can produce health effects (by heating tissue), exposure to low level RF that does not produce heating effects causes no known adverse health effects. Many studies of low level RF exposures have not found any biological effects. Some studies have suggested that some biological effects may occur, but such findings have not been confirmed by additional research. In some cases, other researchers have had difficulty in reproducing those studies, or in determining the reasons for inconsistent results.

2. What is FDA's role concerning the safety of wireless phones?

Under the law, FDA does not review the safety of radiation-emitting consumer products such as wireless phones before they can be sold, as it does with new drugs or medical devices. However, the agency has authority to take action if wireless phones are shown to emit radiofrequency energy (RF) at a level that is hazardous to the user. In such a case, FDA could require the manufacturers of wireless phones to notify users of the health hazard and to repair, replace or recall the phones so that the hazard no longer exists.

Although the existing scientific data do not justify FDA regulatory actions, FDA has urged the wireless phone industry to take a number of steps, including the following:

- Support needed research into possible biological effects of RF of the type emitted by wireless phones;
- Design wireless phones in a way that minimizes any RF exposure to the user that is not necessary for device function; and
- Cooperate in providing users of wireless phones with the best possible information on possible effects of wireless phone use on human health.

FDA belongs to an interagency working group of the federal agencies that have responsibility for different aspects of RF safety to ensure coordinated efforts at the federal level. The following agencies belong to this working group:

- National Institute for Occupational Safety and Health
- Environmental Protection Agency
- Federal Communications Commission
- Occupational Safety and Health Administration
- National Telecommunications and Information Administration

The National Institutes of Health participates in some interagency working group activities, as well.

FDA shares regulatory responsibilities for wireless phones with the Federal Communications Commission (FCC). All phones that are sold in the United States must comply with FCC safety guidelines that limit RF exposure. FCC relies on FDA and other health agencies for safety questions about wireless phones. FCC also regulates the base stations that the

wireless phone networks rely upon. While these base stations operate at higher power than do the wireless phones themselves, the RF exposures that people get from these base stations are typically thousands of times lower than those they can get from wireless phones. Base stations are thus not the subject of the safety questions discussed in this document.

3. What kinds of phones are the subject of this update?

The term wireless phone refers here to hand-held wireless phones with built-in antennas, often called cell mobile or PCS phones. These types of wireless phones can expose the user to measurable radiofrequency energy (RF) because of the short distance between the phone and the user's head. These RF exposures are limited by Federal Communications Commission safety guidelines that were developed with the advice of FDA and other federal health and safety agencies. When the phone is located at greater distances from the user, the exposure to RF is drastically lower because a person's RF exposure decreases rapidly with increasing distance from the source. The so-called cordless phones; which have a base unit connected to the telephone wiring in a house, typically operate at far lower power levels, and thus produce RF exposures far below the FCC safety limits.

4. What are the results of the research done already?

The research done thus far has produced conflicting results, and many studies have suffered from flaws in their research methods. Animal experiments investigating the effects of radiofrequency energy (RF) exposures characteristic of wireless phones have yielded conflicting results that often cannot be repeated in other laboratories. A few animal studies, however, have suggested that low levels of RF could accelerate the development of cancer in laboratory animals. However, many of the studies that showed increased tumor development used animals that had been genetically engineered or treated with cancer-causing chemicals so as to be pre-disposed to develop cancer in the absence of RF exposure. Other studies exposed the animals to RF for up to 22 hours per day. These conditions are not similar to the conditions under which people use wireless phones, so we don't know with certainty what the results of such studies mean for human health.

Three large epidemiology studies have been published since December 2000. Between them, the studies investigated any possible association between the use of wireless phones and primary brain cancer, glioma, meningioma, or acoustic neuroma, tumors of the brain or salivary gland, leukemia, or other cancers. None of the studies demonstrated the existence of any harmful health effects from wireless phone RF exposures. However, none of the studies can answer questions about long-term exposures, since the average period of phone use in these studies was around three years.

5. What research is needed to decide whether RF exposure from wireless phones poses a health risk?

A combination of laboratory studies and epidemiological studies of people actually using wireless phones would provide some of the data that are needed. Lifetime animal exposure studies could be completed in a few years. However, very large numbers of animals would be needed to provide reliable proof of a cancer promoting effect if one exists. Epidemiological studies can provide data that is directly applicable to human populations, but 10 or more years follow-up may be needed to provide answers about some health effects, such as cancer. This is because the interval between the time of exposure to a cancer-causing agent and the time tumors develop - if they do - may be many, many years. The interpretation of epidemiological studies is hampered by difficulties in measuring actual RF exposure during day-to-day use of wireless phones. Many factors affect this measurement, such as the angle at which the phone is held, or which model of phone is used.

6. What is FDA doing to find out more about the possible health effects of wireless phone RF?

FDA is working with the U.S. National Toxicology Program and with groups of investigators around the world to ensure that high priority animal studies are conducted to address important questions about the effects of exposure to radiofrequency energy (RF).

FDA has been a leading participant in the World Health Organization International Electromagnetic Fields (EMF) Project since its inception in 1996. An influential result of this work has been the development of a detailed agenda of research needs that has driven the establishment of new research programs around the world. The Project has also helped develop a series of public information documents on EMF issues.

FDA and the Cellular Telecommunications & Internet Association (CTIA) have a formal Cooperative Research and Development Agreement (CRADA) to do research on wireless phone safety. FDA provides the scientific oversight, obtaining input from experts in government, industry, and academic organizations. CTIA-funded research is conducted through contracts to independent investigators. The initial research will include both laboratory studies and studies of wireless phone users. The CRADA will also include a broad assessment of additional research needs in the context of the latest research developments around the world.

7. How can I find out how much radiofrequency energy exposure I can get by using my wireless phone?

All phones sold in the United States must comply with Federal Communications Commission (FCC) guidelines that limit radiofrequency energy (RF) exposures. FCC established these guidelines in consultation with FDA and the other federal health and safety agencies. The FCC limit for RF exposure from wireless telephones is set at a Specific Absorption Rate (SAR) of 1.6 watts per kilogram (1.6 W/kg). The FCC limit is consistent with the safety standards developed by the Institute of Electrical and Electronic Engineering (IEEE) and the National Council on Radiation Protection and Measurement. The exposure limit takes into consideration the body's ability to remove heat from the tissues that absorb energy from the wireless phone and is set well below levels known to have effects.

Manufacturers of wireless phones must report the RF exposure level for each model of phone to the FCC. The FCC website (<http://www.fcc.gov/oet/rfsafety>) gives directions for locating the FCC identification number on your phone so you can find your phone's RF exposure level in the online listing.

8. What has FDA done to measure the radiofrequency energy coming from wireless phones?

The Institute of Electrical and Electronic Engineers (IEEE) is developing a technical standard for measuring the radiofrequency energy (RF) exposure from wireless phones and other wireless handsets with the participation and leadership of FDA scientists and engineers. The standard, Recommended Practice for Determining the Spatial-Peak Specific Absorption Rate (SAR) in the Human Body Due to Wireless Communications Devices: Experimental Techniques, sets forth the first consistent test methodology for measuring the rate at which RF is deposited in the heads of wireless phone users. The test method uses a tissue-simulating model of the human head. Standardized SAR test methodology is expected to greatly improve the consistency of measurements made at different laboratories on the same phone.

SAR is the measurement of the amount of energy absorbed in tissue, either by the whole body or a small part of the body. It is measured in watts/kg (or milliwatts/g) of matter. This measurement is used to determine whether a wireless phone complies with safety guidelines.

9. What steps can I take to reduce my exposure to radiofrequency energy from my wireless phone?

If there is a risk from these products--and at this point we do not know that there is--it is probably very small. But if you are concerned about avoiding even potential risks, you can take a few simple steps to minimize your exposure to radiofrequency energy (RF). Since time is a key factor in how much exposure a person receives, reducing the amount of time spent using a wireless phone will reduce RF exposure.

If you must conduct extended conversations by wireless phone every day, you could place more distance between your body and the source of the RF, since the exposure level drops off dramatically with distance. For example, you could use a headset and carry the wireless phone away from your body or use a wireless phone connected to a remote antenna.

Again, the scientific data do not demonstrate that wireless phones are harmful. But if you are concerned about the RF exposure from these products, you can use measures like those described above to reduce your RF exposure from wireless phone use.

10. What about children using wireless phones?

The scientific evidence does not show a danger to users of wireless phones, including children and teenagers. If you want to take steps to lower exposure to radiofrequency energy (RF), the measures described above would apply to children and teenagers using wireless phones. Reducing the time of wireless phone use and increasing the distance between the user and the RF source will reduce RF exposure. Some groups sponsored by other national governments have advised that children be discouraged from using wireless phones at all. For example, the government in the United Kingdom distributed leaflets containing such a recommendation in December 2000. They noted that no evidence exists that using a wireless phone causes brain tumors or other ill effects. Their recommendation to limit wireless phone use by children was strictly precautionary; it was not based on scientific evidence that any health hazard exists.

11. What about wireless phone interference with medical equipment?

Radiofrequency energy (RF) from wireless phones can interact with some electronic devices. For this reason, FDA helped develop a detailed test method to measure electromagnetic interference (EMI) of implanted cardiac pacemakers and defibrillators from wireless telephones. This test method is now part of a standard sponsored by the Association for the Advancement of Medical Instrumentation (AAMI). The final draft, a joint effort by FDA, medical device manufacturers, and many other groups, was completed in late 2000. This standard will allow manufacturers to ensure that cardiac pacemakers and defibrillators are safe from wireless phone EMI. FDA has tested hearing aids for interference from handheld wireless phones and helped develop a voluntary standard sponsored by the Institute of Electrical and Electronic Engineers (IEEE). This standard specifies test methods and performance requirements for hearing aids and wireless phones so that no interference occurs when a person uses a compatible phone and a accompanied hearing aid at the same time. This standard was approved by the IEEE in 2000.

FDA continues to monitor the use of wireless phones for possible interactions with other medical devices. Should harmful interference be found to occur, FDA will conduct testing to assess the interference and work to resolve the problem.

12. Where can I find additional information?

For additional information, please refer to the following resources:

- FDA web page on wireless phones
<http://www.fda.gov/cdrh/phones/index.html>
- Federal Communications Commission (FCC) RF Safety Program
<http://www.fcc.gov/oet/rfsafety>
- International Commission on Non-Ionizing Radiation Protection
<http://www.icnirp.de>
- World Health Organization (WHO) International EMF Project
<http://www.who.int/emf>
- National Radiological Protection Board (UK)
<http://www.nrpb.org.uk/>

July 18, 2001 For updates: <http://www.fda.gov/cdrh/phones>

Index

Numerics

1-touch dialing 9

A

access codes 22

accessibility

 website 3

accessories 2

answering calls 10

B

battery

 charging,talk,standby times 27

C

calculations 24

calculator 24

call

 call waiting options 21

 dialed calls 18

 duration 19

 forward 21

 making calls 9

 redialing 9

 register 14, 18

 using the phone book 9

charge the battery 5

clear call lists 18

clock settings 20

conference calling 9

countdown timer 25

covers 8

currency conversion 24

D

date setting 20

delete. see erase

E

enhancements 26

erase

 call lists 18

 messages 16

G

games 24

I

imei 4

in-call operations 10

input methods 11

insert a sim card 4

L

label 4

lock the keypad 10

M

memory status 18

menu

 functions 13

 scrolling 13

 shortcut 13

missed calls 18

model number 4

N

network services 2

nokia customer care

 phone information 4

P

phone label 4

phone security 22

picture messages 15

pin and pin 2 codes 22

predictive text input 11
profiles 20
puk and puk2 codes 22

R

read a text message 15
received calls 18
reminders 23

S

safety instructions 1
search
 name and phone number 17
security code 22
settings 24
settings
 call 21
 message 16
 phone 21
 restore factory 23
 security 22
sim services 26
smileys 16
standby mode 7
standby time 27

T

talk time 27
templates 16
timers, call 19
traditional input 12

V

view
 dialed calls 18
 missed calls 18
 received calls 18
voice message
 listening to 10
 voice mailbox number 17



Nokia 1100

User Guide Update

This update describes the instant messaging feature. For complete information about other phone features and important safety and maintenance information, continue using your *Nokia 1100 User Guide*.

- **INSTANT MESSAGING (IM)**

You can now take text messaging to the next level by experiencing instant messaging in a wireless environment. You can engage in instant messaging with friends and family, regardless of the mobile system or platform (like the Internet) they are using, as long as you all use America Online Instant Messaging (AIM). Check with your wireless service provider for availability.

Before you can start using instant messaging on your phone, you must first subscribe to your wireless service provider's text messaging service and register with the instant messaging service you want to use. See "Register with the instant messaging service" on page 1 for more information.



Note: Depending on both your IM service provider and your wireless service provider, you may not have access to all of the features described in this guide.

- **REGISTER WITH THE INSTANT MESSAGING SERVICE**





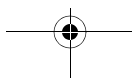
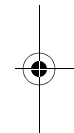
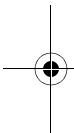

Before you can begin to use instant messaging with AIM, you must obtain an IM user name and password. You can do this by registering over the Internet (via your computer) with the IM service provider you will be using for instant messaging. Information on the AIM web site will guide you through the registration process. (You can also download and install either instant messaging service on your computer.)

Register at <http://www.aim.com/index.adp> to obtain a screen name and password.



• IM SERVICE PROVIDER ICONS

Instant messaging service has its own display text and icons associated with it, the display text and icons on your phone will appear differently. The following table shows instant messaging icons and their descriptions for AIM.

Description	AIM Icon
IM service provider's branding splash	
Available	
Offline/Appear offline	
Blocked contact	
Unread/New message	
Read message	

• USE INSTANT MESSAGING WITH AIM

AIM menu

OFFLINE

Before you connect to AIM, the AIM menu appears like this:

Sign On

Availability

Saved convers.

IM Settings



ONLINE

After connecting to AIM, the AIM menu appears like this:

Buddy List
Create group
Availability
Saved convers.
IM Settings
Sign Off

Log into service

The first time you use instant messaging, select AIM as the IM provider. Enter your screen name and password to log into the service. After the first successful login, you will not have to select the IM provider or enter your password again.

LOG INTO SERVICE FIRST TIME

- 1 Select Menu > IM > Sign on.
- 2 Enter your screen name and select OK.
- 3 Enter your password and select OK.

LOG INTO SERVICE AFTER FIRST TIME

- 1 Select Menu > IM > Sign on.
The Screen Name screen appears, with your screen name displaying.
- 2 Select OK, enter your password and select OK.

Set your availability

You can determine if other users can tell whether you are available or not.

From the AIM online menu, select **Availability**, then select either **Available** or **Appear offline**.

IM conversations

You can send instant messages to anyone registered with AIM if you have the person's screen name. You can also add that person to your **Buddy List** during an IM conversation. You can have more than one IM conversation active at the same time.

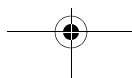
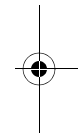
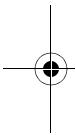



Conversation view

The conversation view of your IM conversation shows your initial message at the top of the screen, followed by the reply. As the conversation progresses, the initial message will no longer display. The most recent message appears at the bottom of the screen, causing the message above it to move up one level. You can have more than one IM conversation active at the same time.

The conversation is still active, even if you leave the conversation view. You can return to it at any time.

- 1 From the AIM online menu, select **Buddy List**.
- 2 Scroll to the buddy you want, and select **Options > Send IM**.
The conversation view appears.
- 3 Select **Options > Create message**.
- 4 Enter your message, then select **Options > Send**.

WRITE AND SEND

- 1 From the AIM online menu, select **Buddy List > Options > Write message**.
- 2 Enter the screen name of the person to whom you want to send an instant message, then select **OK**.
- 3 Write the message.
- 4 Select **Options > Send**.

WRITE AND SEND TO BUDDY

- 1 From the AIM online menu, select **Buddy List** and select the buddy to whom you want to send a message.
- 2 Select **Options > Send IM > Options > Create message**.
- 3 Enter a message, and select **Options > Send**.

RECEIVE AND REPLY IN CONVERSATION VIEW

When you receive an instant message, your phone alerts you, and the sender's reply appears below your most recent message.

- 1 Select **Options > Create message > OK**.
- 2 Enter a message, then select **Options > Send**.

RECEIVE AND REPLY OUTSIDE CONVERSATION VIEW

When you receive an instant message, your phone alerts you and a message appears saying that you have received an instant message.

Select **Read > Options > Create message**.

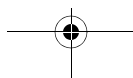
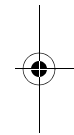
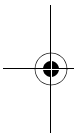



SAVE

- 1 From the conversation view, select **Options > Save convers.**
- 2 Keep the conversation name that appears in the display and select **Ok.**

OR

Press **C** as many times as necessary to delete the conversation name, then enter the name you want and select **OK.**

VIEW

From either the AIM online or offline menu, select **Saved convers.**, then select the conversation you want to view.

RENAME

- 1 From either the AIM online or offline menu, select **Saved convers.**, then select the conversation you want to rename and select **Options > Rename.**
- 2 Press **C** as many times as necessary to delete the conversation name, then enter the new conversation name.
- 3 Select **OK.**

DELETE

From either the AIM online or offline menu, select **Saved convers.**, then select the conversation you want to delete and select **Options > Delete.**

END IN CONVERSATION VIEW

- 1 Select **Options > End convers. > OK.**
- 2 Select the conversation you want to end and select **End conversation.**

Buddy List

You can add the names of your friends and family with whom you will be interacting frequently via instant messaging to your **Buddy List.**

ADD

- 1 From the AIM online menu, select **Buddy List > Options > Add Buddy.**
- 2 Enter the buddy's screen name, select **OK,** enter the buddy's nick name, and select **> OK.**

ADD DURING INSTANT MESSAGING SESSION

- 1 Press **C,** select **Add as buddy > OK.**
- 2 Enter a nickname and press **OK.**

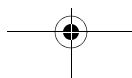
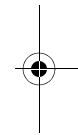
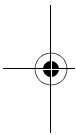

DELETE

From the AIM online menu, select **Buddy List** and select the buddy you want to delete, then select **Delete buddy > OK**.

BLOCK

- 1 From the AIM online menu, select **Buddy List** and select the buddy from whom you want to block messages.
- 2 Select **Block IMs > OK**.

UNBLOCK

- 1 From the AIM online menu, select **Buddy List** and select the buddy from whom you want to unblock messages.
- 2 Select **Unblock > OK**.

SET TRACKING

You can set the tracking feature for a contact to notify you when the contact's availability changes.

- 1 From the AIM online menu, select **Buddy List**, then select the buddy you want to track.
- 2 Select **Start tracking**.

REMOVE AN ALERT

From the AIM online menu, select **Buddy List**, then select the buddy for whom you want to remove an alert and select **Remove alert**.

Instant messaging settings

You can customize your instant messaging settings. Select **Settings** from either the AIM online or offline menu and the following options appear in the display:

Option	What it does
Nickname	Allows you to change your nickname.
Availability notification	Allows you to update your buddies' online availability (presence)
Show availability to	Lets you alert others to your presence online.
Auto-sign on	Allows you to sign-on to the automatically at power-up or start-up.

Option	What it does
Network sett.	Allows you to change your Screen Name or Password.

NICKNAME

You can change a nickname that is 1–20 characters in length.

- 1 From either the AIM online or offline menu, select **Settings > Nickname**. The **Nickname** screen appears, with your screen name displaying.
- 2 Select **Clear** as many times as necessary to delete the screen name.
- 3 Enter the new nickname and select **OK**.

AUTOMATIC SIGN-ON

You can use automatic sign on after you have logged in with your screen name and password.

From either the AIM online or offline menu, select **Settings > Auto Sign-On**. Then choose from **On power-up**, or **At start-up**. To deactivate, select **Auto Sign-on off**.

Sign off service

From the AIM online menu, you can exit the IM application but still stay connected to the IM service. This enables you to receive instant messages from your contacts, when using your phone for other purposes, for example, if you are playing a game. If you are connected to your IM service, but you have not used your IM application for some time, you may be automatically disconnected from the IM service. The next time you open the IM application, you will receive a message, **Not connected** and you will be taken to the offline menu where you have to sign in again.

To disconnect from the IM service, you must log out from the AIM online menu. You will then be taken to the AIM offline menu, where you can sign in again or exit the IM application.

SIGN OFF INSTANT MESSAGING

From the AIM online menu, select **Sign Off > OK**.



Nokia Inc.
7725 Woodland Center Blvd., Ste. 150
Tampa, FL 33614
Telephone: 1-888-NOKIA-2U (1-888-665-4228)
Facsimile: 1-813-249-9619
TTY/TDD Users: 1-800-24-NOKIA (1-800-246-6542)
www.nokia.com/us
www.nokiahowto.com

Copyright © 2004 Nokia. All rights reserved. Printed in Mexico. Version 1 9311029

