



工业和信息化部通信计量中心  
Telecommunication Metrology Center of MIIT



Impedance Measurement Plot for Body TSL

CH1 S11 1 U FS 1=59.518  $\Omega$  8.7637  $\Omega$  67.823  $\mu\text{H}$  1.000.000.000 MHz

\*  
Ca

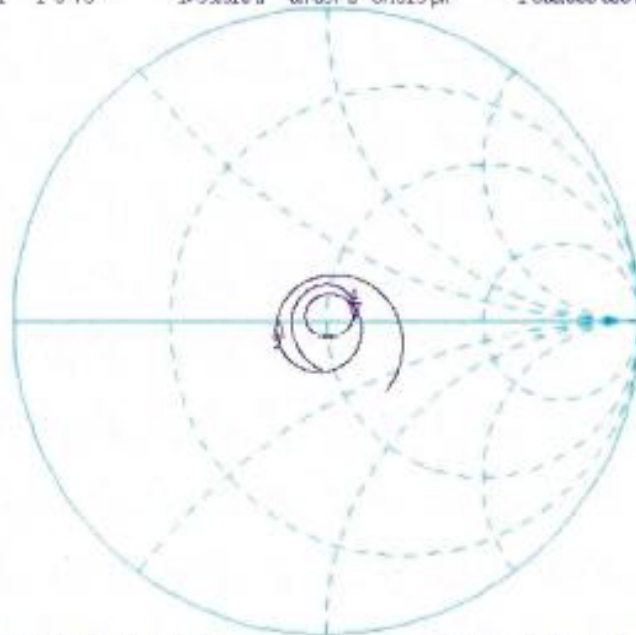

CH1 Markers  
1= 36.350  $\Omega$   
-152.34  $\omega\Omega$   
1.90000 GHz

START 1 750.000 000 MHz STOP 1 950.000 000 MHz

CH1 S11 LOG 5 dB/REF -20 dB 1=-21.228 dB 1.000.000.000 MHz

\*  
Ca

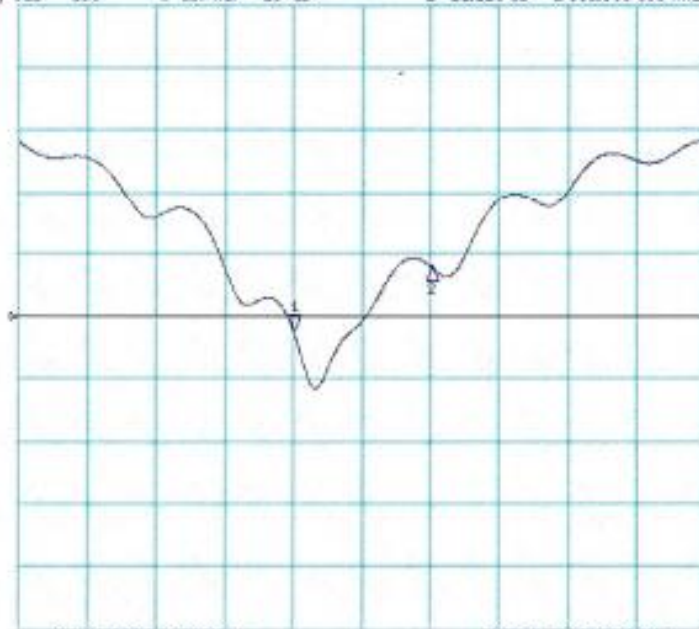

CH1 Markers  
1=-16.835 dB  
1.90000 GHz

START 1 600.000 000 MHz STOP 2 100.000 000 MHz



Annex 4.4 Calibration report “835 MHz System validation dipole”

工业和信息化部通信计量中心  
Telecommunication Metrology Center of MIIT

校准  
CNAS L0442

Client **Huawei** Certificate No: **D835V2-4d095\_Feb11**

**CALIBRATION CERTIFICATE**

Object: D835V2 - SN: 4d095

Calibration Procedure(s): TMC-XZ-01-027  
Calibration procedure for dipole validation kits

Calibration date: February 23, 2011

Condition of the calibrated item: In Tolerance

This calibration Certificate documents the traceability to national standards, which realize the physical units of measurements(SI). The measurements and the uncertainties with confidence probability are given on the following pages and are part of the certificate.

All calibrations have been conducted in the closed laboratory facility: environment temperature(22±3)℃ and humidity<70%.

Calibration Equipment used (M&TE critical for calibration)

Primary Standards	ID #	Cal Date(Calibrated by, Certificate No.)	Scheduled Calibration
Power Meter NRVD	101253	18-Jun-10 (TMC, No.JZ10-248)	Jun-11
Power sensor NRV-Z5	100333	18-Jun-10 (TMC, No. JZ10-248)	Jun-11
Reference Probe ES3DV3	SN 3149	25-Sep-10 (SPEAG, No.ES3-3149_Sep10)	Sep-11
DAB4	SN 771	21-Nov-10 (TMC, No.JZ10-653)	Nov-11
RF generator E4438C	MY45092879	17-Jun-10 (TMC, No.JZ10-302)	Jun-11
Network Analyzer 8753E	US38433212	02-Aug-10 (TMC, No.JZ10-056)	Aug-11

	Name	Function	Signature
Calibrated by:	Lin Hao	SAR Test Engineer	
Reviewed by:	Qi Dianyuan	SAR Project Leader	
Approved by:	Lu Bingsong	Deputy Director of the laboratory	

Issued: February 23, 2011

This calibration certificate shall not be reproduced except in full without written approval of the laboratory.

## Glossary:

TSL	tissue simulating liquid
ConvF	sensitivity in TSL / NORM <sub>x,y,z</sub>
N/A	not applicable or not measured

## Calibration is Performed According to the Following Standards:

- IEEE Std 1528-2003, "IEEE Recommended Practice for Determining the Peak Spatial-Averaged Specific Absorption Rate (SAR) in the Human Head from Wireless Communications Devices: Measurement Techniques", December 2003
- IEC 62209-1, "Procedure to measure the Specific Absorption Rate (SAR) For hand-held devices used in close proximity to the ear (frequency range of 300MHz to 3GHz)", February 2005
- Federal Communications Commission Office of Engineering & Technology (FCC OET), "Evaluating Compliance with FCC Guidelines for Human Exposure to Radiofrequency Electromagnetic Fields; Additional Information for Evaluating Compliance of Mobile and Portable Devices with FCC Limits for Human Exposure to Radiofrequency Emissions", Supplement C (Edition 01-01) to Bulletin 65

## Additional Documentation:

- DASY System Handbook

## Methods Applied and Interpretation of Parameters:

- Measurement Conditions: Further details are available from the Validation Report at the end of the certificate. All figures stated in the certificate are valid at the frequency indicated.
- Antenna Parameters with TSL: The dipole is mounted with the spacer to position its feed point exactly below the center marking of the flat phantom section, with the arms oriented parallel to the body axis.
- Feed Point Impedance and Return Loss: These parameters are measured with the dipole positioned under the liquid filled phantom. The impedance stated is transformed from the measurement at the SMA connector to the feed point. The Return Loss ensures low reflected power. No uncertainty required.
- Electrical Delay: One-way delay between the SMA connector and the antenna feed point. No uncertainty required.
- SAR measured: SAR measured at the stated antenna input power.
- SAR normalized: SAR as measured, normalized to an input power of 1 W at the antenna connector.
- SAR for nominal TSL parameters: The measured TSL parameters are used to calculate the nominal SAR result.

**Measurement Conditions**

DASY system configuration, as far as not given on page 1.

DASY Version	DASYS	V5.2.157
Extrapolation	Advanced Extrapolation	
Phantom	2mm Oval Phantom EL14	
Distance Dipole Center - TSL	15 mm	with Spacer
Zoom Scan Resolution	dx, dy, dz = 5 mm	
Frequency	835 MHz $\pm$ 1 MHz	

**Head TSL parameters**

The following parameters and calculations were applied.

	Temperature	Permittivity	Conductivity
Nominal Head TSL parameters	22.0 °C	41.5	0.90 mho/m
Measured Head TSL parameters	(22.0 $\pm$ 0.2) °C	41.9 $\pm$ 6 %	0.93mho/m $\pm$ 6 %
Head TSL temperature during test	(22.5 $\pm$ 0.2) °C	---	---

**SAR result with Head TSL**

SAR averaged over 1 $cm^3$ (1 g) of Head TSL	Condition	
SAR measured	250 mW input power	2.39 mW / g
SAR normalized	normalized to 1W	9.56 mW / g
SAR for nominal Head TSL parameters <sup>1</sup>	normalized to 1W	<b>9.42 mW / g <math>\pm</math> 17.0 % (k=2)</b>

SAR averaged over 10 $cm^3$ (10 g) of Head TSL	Condition	
SAR measured	250 mW input power	1.54 mW / g
SAR normalized	normalized to 1W	6.16 mW / g
SAR for nominal Head TSL parameters <sup>1</sup>	normalized to 1W	<b>6.13 mW / g <math>\pm</math> 16.5 % (k=2)</b>

<sup>1</sup> Correction to nominal TSL parameters according to d), chapter "SAR Sensitivities"

**Body TSL parameters**

The following parameters and calculations were applied.

	Temperature	Permittivity	Conductivity
Nominal Body TSL parameters	22.0 °C	55.2	0.97 mho/m
Measured Body TSL parameters	(22.0 ± 0.2) °C	53.8 ± 6%	1.00mho/m ± 6 %
Body TSL temperature during test	(22.4 ± 0.2) °C	---	---

**SAR result with Body TSL**

SAR averaged over 1 $cm^3$ (1 g) of Body TSL	Condition	
SAR measured	250 mW input power	2.47 mW / g
SAR normalized	normalized to 1W	9.88 mW / g
SAR for nominal Body TSL parameters <sup>2</sup>	normalized to 1W	9.56 mW /g ± 17.0 % (k=2)

SAR averaged over 10 $cm^3$ (10 g) of Body TSL	Condition	
SAR measured	250 mW input power	1.61 mW / g
SAR normalized	normalized to 1W	6.44 mW / g
SAR for nominal Body TSL parameters <sup>2</sup>	normalized to 1W	6.28 mW /g ± 16.5 % (k=2)

<sup>2</sup> Correction to nominal TSL parameters according to d), chapter "SAR Sensitivities"

工业和信息化部通信计量中心  
Telecommunication Metrology Center of MIIT

## Appendix

### Antenna Parameters with Head TSL

Impedance, transformed to feed point	$47.2\Omega + 7.0\text{ j}\Omega$
Return Loss	- 22.3dB

### Antenna Parameters with Body TSL

Impedance, transformed to feed point	$46.5\Omega + 3.4\text{ j}\Omega$
Return Loss	- 25.9dB

### General Antenna Parameters and Design

Electrical Delay (one direction)	3.184 ns
----------------------------------	----------

After long term use with 100W radiated power, only a slight warming of the dipole near the feedpoint can be measured.

The dipole is made of standard semirigid coaxial cable. The center conductor of the feeding line is directly connected to the second arm of the dipole. The antenna is therefore short-circuited for DC-signals.

No excessive force must be applied to the dipole arms, because they might bend or the soldered connections near the feedpoint may be damaged.

工业和信息化部通信计量中心  
Telecommunication Metrology Center of MIIT



**DASY5 Validation Report for Head TSL**

Date/Time: 2011-2-23 9:15:24

Test Laboratory: TMC, Beijing, China

DUT: Dipole 835 MHz; Type: D835V2; Serial: SN: 4d095

Communication System: CW Frequency: 835 MHz Duty Cycle: 1:1

Medium: Head 835MHz

Medium parameters used:  $f = 835 \text{ MHz}$ ;  $\sigma = 0.93 \text{ mho/m}$ ;  $\epsilon_r = 41.9$ ;  $\rho = 1000 \text{ kg/m}^3$

Phantom section: Flat Section

DASY5 Configuration:

- Probe: ES3DV3 - SN3149; ConvF(6.56, 6.56, 6.56); Calibrated: 25.09.10
- Electronics: DAE4 Sn771; Calibration: 21.11.10
- Phantom: 2mm Oval Phantom ELI4; Type: QDOVA001BB
- Measurement SW: DASY5, V5.2.157; Postprocessing SW: SEMCAD, V14.0 Build 57

Pin=250mW; d=15mm/Zoom Scan (7x7x7)/Cube 0:

Measurement grid: dx=5mm, dy=5mm, dz=5mm

Reference Value = 56.3 V/m; Power Drift = 0.104 dB

Peak SAR (extrapolated) = 3.475 W/kg

SAR(1 g) = 2.39 mW/g; SAR(10 g) = 1.54 mW/g

Maximum value of SAR (measured) = 2.56 mW/g

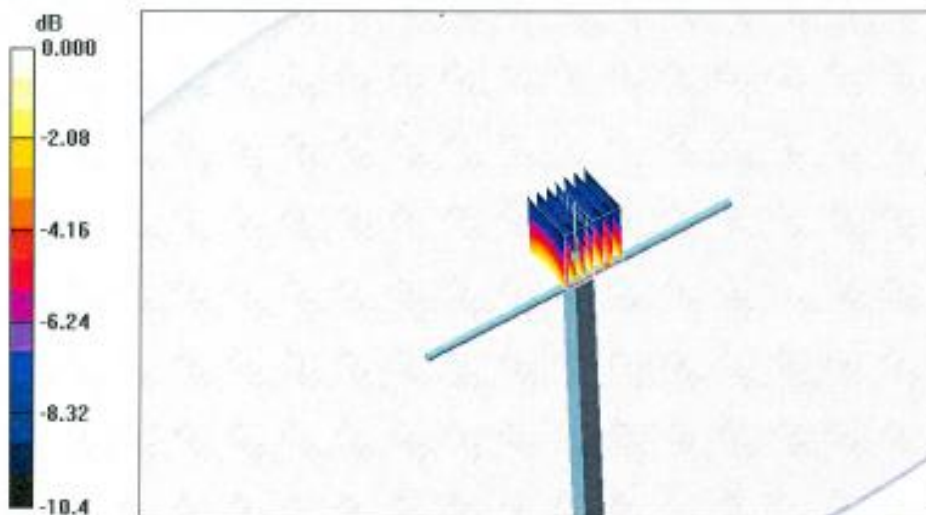

0 dB = 2.56mW/g



工业和信息化部通信计量中心  
Telecommunication Metrology Center of MIIT



Impedance Measurement Plot for Head TSL

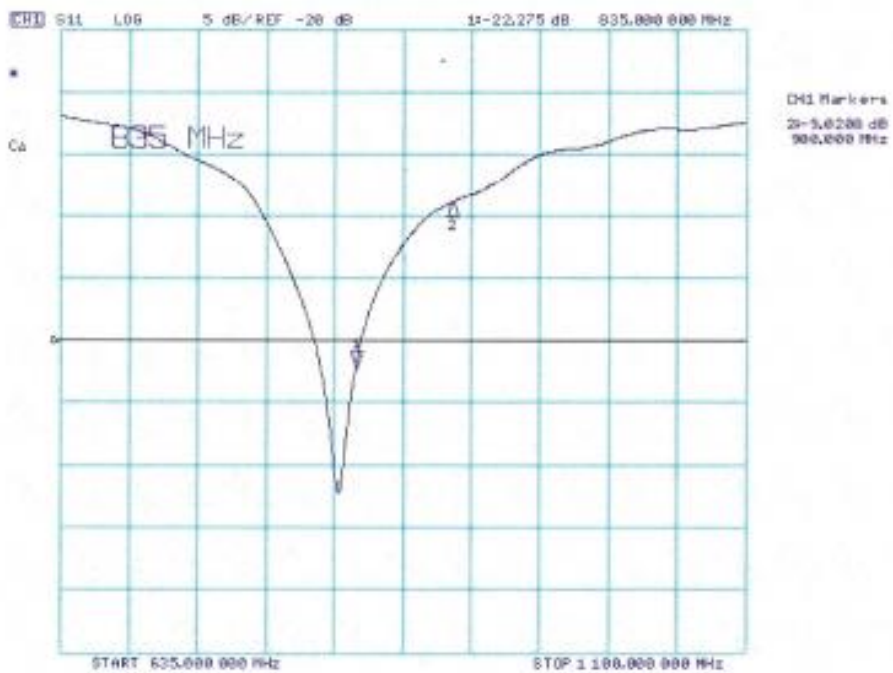
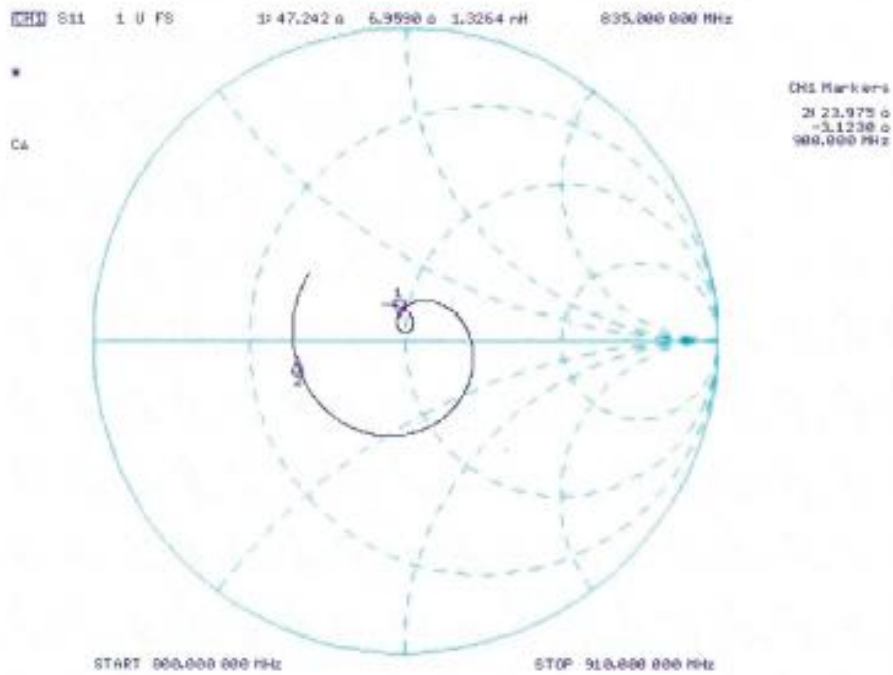



工业和信息化部通信计量中心  
Telecommunication Metrology Center of MIIT



**DASY5 Validation Report for Body TSL**

Date/Time: 2011-2-23 10:36:18

Test Laboratory: TMC, Beijing, China

DUT: Dipole 835 MHz; Type: D835V2; Serial: SN: 4d095

Communication System: CW Frequency: 835 MHz Duty Cycle: 1:1

Medium: Body 835MHz

Medium parameters used:  $f = 835 \text{ MHz}$ ;  $\sigma = 1 \text{ mho/m}$ ;  $\epsilon_r = 53.8$ ;  $\rho = 1000 \text{ kg/m}^3$

Phantom section: Flat Section

DASY5 Configuration:

- Probe: ES3DV3 - SN3149; ConvF(6.22, 6.22, 6.22); Calibrated: 25.09.10
- Electronics: DAE4 Sn771; Calibration: 21.11.10
- Phantom: 2mm Oval Phantom ELI4; Type: QDOVA001BB
- Measurement SW: DASY5, V5.2.157; Postprocessing SW: SEMCAD, V14.0 Build 57

Pin=250mW; d=15mm/Zoom Scan (7x7x7)/Cube 0:

Measurement grid: dx=5mm, dy=5mm, dz=5mm

Reference Value = 41.7 V/m; Power Drift = -0.065 dB

Peak SAR (extrapolated) = 3.475 W/kg

SAR(1 g) = 2.47 mW/g; SAR(10 g) = 1.61 mW/g

Maximum value of SAR (measured) = 2.68 mW/g

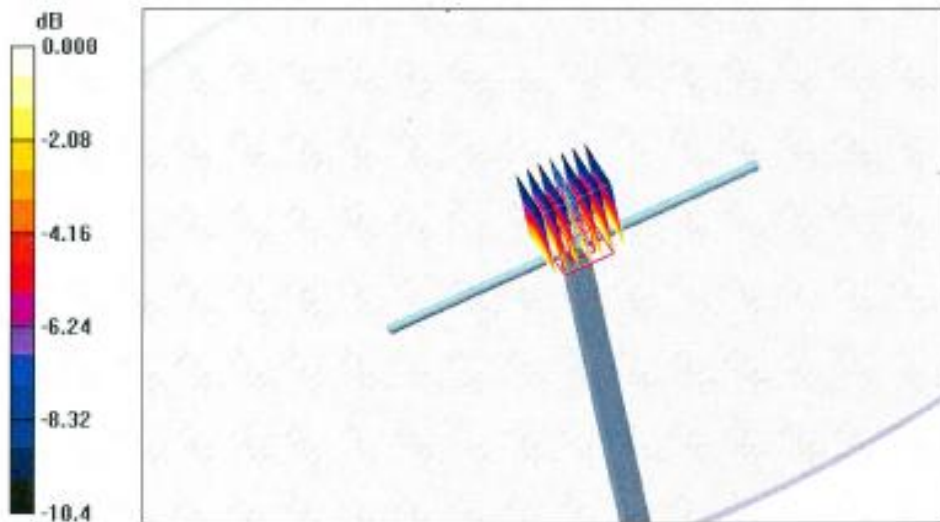

0 dB = 2.68mW/g



工业和信息化部通信计量中心  
Telecommunication Metrology Center of MIIT



Impedance Measurement Plot for Body TSL

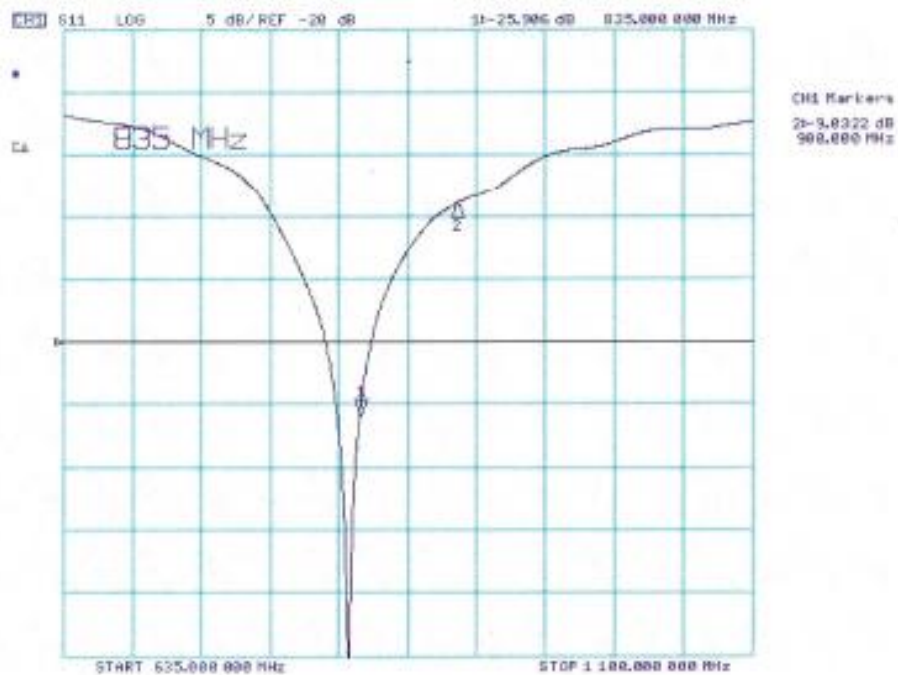
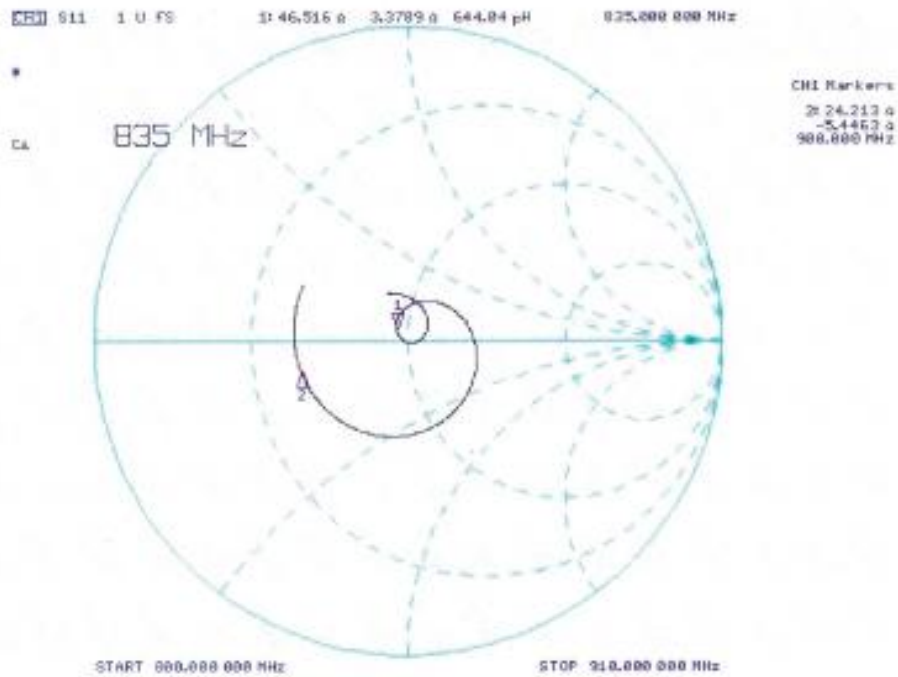



Annex 4.5 Calibration certificate of Data Acquisition Unit (DAE)

工业和信息化部通信计量中心  
Telecommunication Metrology Center of MIIT



Add: No.52 Huayuanbei Road, Haidian District, Beijing, 100191, China  
Tel: +86-10-62304633-2079 Fax: +86-10-62304793  
E-mail: [info@emcite.com](mailto:info@emcite.com) Http://www.emcite.com

Client **Huawei**

Certificate No: DAE4-852\_Dec10

**CALIBRATION CERTIFICATE**

Object	DAE4 - SN: 852
Calibration Procedure(s)	TMC-XZ-01-029 Calibration procedure for the data acquisition electronics (DAE)
Calibration date:	December 24, 2010
Condition of the calibrated item	In Tolerance

This calibration Certificate documents the traceability to national standards, which realize the physical units of measurements(SI). The measurements and the uncertainties with confidence probability are given on the following pages and are part of the certificate.

All calibrations have been conducted in the closed laboratory facility: environment temperature(22±3)℃ and humidity<70%.

Calibration Equipment used (M&TE critical for calibration)

Primary Standards	ID #	Cal Date(Calibrated by, Certificate No.)	Scheduled Calibration
Multimeter 3458A	MY45041463	12-Nov-10 (TMC, No: DLsc2010-1115)	Nov-11
DC POWER SUPPLY 66321D	MY43001657	12-Nov-10 (TMC, No: JZ10-290)	Nov-11
Secondary Standards	ID #	Check Date (in house)	Scheduled Check
Calibrator Box	/	19-Jun-10 (TMC, in house check)	In house check Jun-11

	Name	Function	Signature
Calibrated by:	Lin Hao	SAR Test Engineer	
Reviewed by:	Qi Dianyuan	SAR Project Leader	
Approved by:	Xiao Li	Deputy Director of the laboratory	

Issued: December 24, 2010

This calibration certificate shall not be reproduced except in full without written approval of the laboratory.



Add: No.52 Huayuanbei Road, Haidian District, Beijing, 100191, China  
Tel: +86-10-62304633-2079 Fax: +86-10-62304793  
E-mail: [Info@emcicc.com](mailto:Info@emcicc.com) Http://www.emcicc.com

**Glossary:**

DAE data acquisition electronics  
Connector angle information used in DASY system to align probe sensor X to the robot coordinate system.

**Methods Applied and Interpretation of Parameters:**

- DC Voltage Measurement: Calibration Factor assessed for use in DASY system by comparison with a calibrated instrument traceable to national standards. The figure given corresponds to the full scale range of the voltmeter in the respective range.
- Connector angle: The angle of the connector is assessed measuring the angle mechanically by a tool inserted. Uncertainty is not required.
- The following parameters contain technical information as a result from the performance test and require no uncertainty.
- DC Voltage Measurement Linearity: Verification of the Linearity at +10% and -10% of the nominal calibration voltage. Influence of offset voltage is included in this measurement.
- Common mode sensitivity: Influence of a positive or negative common mode voltage on the differential measurement.
- Channel separation: Influence of a voltage on the neighbor channels not subject to an input voltage.
- AD Converter Values with inputs shorted: Values on the internal AD converter corresponding to zero input voltage.
- Input Offset Measurement: Output voltage and statistical results over a large number of zero voltage measurements.



工业和信息化部通信计量中心  
Telecommunication Metrology Center of MIIT



Add: No.52 Huayuanbei Road, Haidian District, Beijing, 100191, China  
Tel: +86-10-62304633-2079 Fax: +86-10-62304793  
E-mail: [Info@emcite.com](mailto:Info@emcite.com) Http://www.emcite.com

**DC Voltage Measurement**

AD - Converter Resolution nominal

High Range: 1LSB = 6.1  $\mu$ V, full range = -100... +300 mV

Low Range: 1LSB = 61nV, full range = -1.....+3mV

DASY measurement parameters: Auto Zero Time: 3 sec; Measuring time: 3 sec

Calibration Factors	X	Y	Z
High Range	405.142 $\pm$ 0.1% ( $\kappa=2$ )	405.214 $\pm$ 0.1% ( $\kappa=2$ )	404.005 $\pm$ 0.1% ( $\kappa=2$ )
Low Range	3.97599 $\pm$ 0.7% ( $\kappa=2$ )	3.96438 $\pm$ 0.7% ( $\kappa=2$ )	3.95613 $\pm$ 0.7% ( $\kappa=2$ )

**Connector Angle**

Connector Angle to be used in DASY system	159 $^{\circ}$ $\pm$ 1 $^{\circ}$
---	-----------------------------------

**Appendix**

**1. DC Voltage Linearity**

High Range	Input ( μ V)	Reading ( μ V)	Error (%)
Channel X + Input	200000	200000.2	0.00
Channel X + Input	20000	20002.75	0.01
Channel X - Input	20000	-20003.08	0.02
Channel Y + Input	200000	200000	0.00
Channel Y + Input	20000	20003.19	0.02
Channel Y - Input	20000	-20002.40	0.01
Channel Z + Input	200000	200001.2	0.00
Channel Z + Input	20000	20004.27	0.02
Channel Z - Input	20000	-20003.2	0.02

Low Range	Input ( μ V)	Reading ( μ V)	Error (%)
Channel X + Input	2000	1999.7	-0.02
Channel X + Input	200	199.66	-0.06
Channel X - Input	200	-200.49	0.28
Channel Y + Input	2000	1999.8	0.00
Channel Y + Input	200	199.45	-0.26
Channel Y - Input	200	-200.24	0.08
Channel Z + Input	2000	2000	0.00
Channel Z + Input	200	199.57	-0.30
Channel Z - Input	200	-200.83	0.49

**2. Common mode sensitivity**

DASY measurement parameters: Auto Zero Time: 3 sec; Measuring time: 3 sec

	Common mode Input Voltage (mV)	High Range Average Reading ( μ V)	Low Range Average Reading ( μ V)
Channel X	200	3.41	3.47
	- 200	-2.60	-3.15
Channel Y	200	0.18	-0.37
	- 200	-0.66	-1.12
Channel Z	200	-9.70	-10.08
	- 200	7.88	8.23

### 3. Channel separation

DASY measurement parameters: Auto Zero Time: 3 sec; Measuring time: 3 sec

	Input Voltage (mV)	Channel X ( $\mu$ V)	Channel Y ( $\mu$ V)	Channel Z ( $\mu$ V)
Channel X	200	-	2.61	-0.38
Channel Y	200	0.59	-	2.46
Channel Z	200	-1.93	0.24	-

### 4. AD-Converter Values with inputs shorted

DASY measurement parameters: Auto Zero Time: 3 sec; Measuring time: 3 sec

	High Range (LSB)	Low Range (LSB)
Channel X	16130	16437
Channel Y	15975	16211
Channel Z	15978	16034

### 5. Input Offset Measurement

DASY measurement parameters: Auto Zero Time: 3 sec; Measuring time: 3 sec

 Input 10M $\Omega$ 

	Average ( $\mu$ V)	min. Offset ( $\mu$ V)	max. Offset ( $\mu$ V)	Std. Deviation( $\mu$ V)
Channel X	0.57	-1.04	1.91	0.45
Channel Y	-1.03	-1.90	-0.06	0.39
Channel Z	1.12	-0.11	1.94	0.38

### 6. Input Offset Current

Nominal Input Circuitry offset current on all channels: &lt;25fA

### 7. Input Resistance

	Zeroing (MOhm)	Measuring (MOhm)
Channel X	0.2000	201.1
Channel Y	0.2000	198.9
Channel Z	0.2000	200.4

## **Annex 4.6 Application Note System Performance Check**

### **Annex 4.6.1 Purpose of system performance check**

The system performance check verifies that the system operates within its specifications. System and operator errors can be detected and corrected. It is recommended that the system performance check is performed prior to any usage of the system in order to guarantee reproducible results.

The measurement of the Specific Absorption Rate (SAR) is a complicated task and the result depends on the proper functioning of many components and the correct settings of many parameters. Faulty results due to drift, failures or incorrect parameters might not be recognized, since they often look similar in distribution to the correct ones. The Dosimetric Assessment System DASY5 incorporates a system performance check procedure to test the proper functioning of the system. The system performance check uses normal SAR measurements in a simplified setup (the flat section of the SAM Twin Phantom) with a well characterized source (a matched dipole at a specified distance). This setup was selected to give a high sensitivity to all parameters that might fail or vary over time (e.g., probe, liquid parameters, and software settings) and a low sensitivity to external effects inherent in the system (e.g., positioning uncertainty of the device holder). The system performance check does not replace the calibration of the components. The accuracy of the system performance check is not sufficient for calibration purposes. It is possible to calculate the field quite accurately in this simple setup; however, due to the open field situation some factors (e.g., laboratory reflections) cannot be accounted for. Calibrations in the flat phantom are possible with transfer calibration methods, using either temperature probes or calibrated E-field probes. The system performance check also does not test the system performance for arbitrary field situations encountered during real measurements of mobile phones. These checks are performed at SPEAG by testing the components under various conditions (e.g., spherical isotropy measurements in liquid, linearity measurements, temperature variations, etc.), the results of which are used for an error estimation of the system. The system performance check will indicate situations where the system uncertainty is exceeded due to drift or failure.

### **Annex 4.6.2 System Performance check procedure**

#### **Preparation**

The conductivity should be measured before the validation and the measured liquid parameters must be entered in the software. If the measured values differ from targeted values in the dipole document, the liquid composition should be adjusted. If the validation is performed with slightly different (measured) liquid parameters, the expected SAR will also be different. See the application note about SAR sensitivities for an estimate of possible SAR deviations. Note that the liquid parameters are temperature dependent with approximately – 0.5% decrease in permittivity and + 1% increase in conductivity for a temperature decrease of 1° C. The dipole must be placed beneath the flat phantom section of the Generic Twin Phantom with the correct distance holder in place. The distance holder should touch the phantom surface with a light pressure at the reference marking (little hole) and be oriented parallel to the long side of the phantom. Accurate positioning is not necessary, since the system will search for the peak SAR location, except that the dipole arms should be parallel to the surface. The device holder for mobile phones can be left in place but should be rotated away from the dipole. The forward power into the dipole at the dipole SMA connector should be determined as accurately as possible. See section 4 for a description of the recommended setup to measure the dipole input power. The actual dipole input power level can be between 20mW and several watts. The result can later be normalized to any power level. It is strongly recommended to note the actually used power level in the „comment“-window of the measurement file; otherwise you lose this crucial information for later reference.

#### **System Performance Check**

The DASY5 installation includes predefined files with recommended procedures for measurements and validation. They are read-only document files and destined as fully defined but unmeasured masks, so



you must save the finished validation under a different name. The validation document requires the Generic Twin Phantom, so this phantom must be properly installed in your system. (You can create your own measurement procedures by opening a new document or editing an existing document file). Before you start the validation, you just have to tell the system with which components (probe, medium, and device) you are performing the validation; the system will take care of all parameters. After the validation, which will take about 20 minutes, the results of each task are displayed in the document window. Selecting all measured tasks and opening the predefined "validation" graphic format displays all necessary information for validation. A description of the different measurement tasks in the predefined document is given below, together with the information that can be deduced from their results:

- The „reference“ and „drift“ measurements are located at the beginning and end of the batch process. They measure the field drift at one single point in the liquid over the complete procedure. The indicated drift is mainly the variation of the amplifier output power. If it is too high (above  $\pm 0.1$  dB) the validation should be repeated; some amplifiers have very high drift during warm-up. A stable amplifier gives drift results in the DASY5 system below  $\pm 0.02$  dB.
- The „surface check“ measurement tests the optical surface detection system of the DASY5 system by repeatedly detecting the surface with the optical and mechanical surface detector and comparing the results. The output gives the detecting heights of both systems, the difference between the two systems and the standard deviation of the detection repeatability. Air bubbles or refraction in the liquid due to separation of the sugar-water mixture gives poor repeatability (above  $\pm 0.1$  mm). In that case it is better to abort the validation and stir the liquid. The difference between the optical surface detection and the actual surface depends on the probe and is specified with each probe. (It does not depend on the surface reflectivity or the probe angle to the surface within  $\pm 30^\circ$ .) However, varying breaking indices of different liquid compositions might also influence the distance. If the indicated difference varies from the actual setting, the probe parameter „optical surface distance“ should be changed in the probe settings (see manual). For more information see the application note about SAR evaluation.
- The „area scan“ measures the SAR above the dipole on a parallel plane to the surface. It is used to locate the approximate location of the peak SAR with 2D spline interpolation. The proposed scan uses large grid spacing for faster measurement; due to the symmetric field the peak detection is reliable. If a finer graphic is desired, the grid spacing can be reduced. Grid spacing and orientation have no influence on the SAR result.
- The zoom scan job measures the field in a volume around the peak SAR value assessed in the previous „area“ scan (for more information see the application note on SAR evaluation).

If the validation measurements give reasonable results, the peak 1g and 10g spatial SAR values averaged between the two cubes and normalized to 1W dipole input power give the reference data for comparisons. The next section analyzes the expected uncertainties of these values. Section 6 describes some additional checks for further information or troubleshooting.

### **Annex 4.6.3      Uncertainty Budget**

Please note that in the following Tables, the tolerance of the following uncertainty components depends on the actual equipment and setup at the user location and need to be either assessed or verified on-site by the end user of the DASY5 system:

- RF ambient conditions
- Dipole Axis to Liquid Distance
- Input power and SAR drift measurement
- Liquid permittivity - measurement uncertainty
- Liquid conductivity - measurement uncertainty

Note: All errors are given in percent of SAR, so 0.1 dB corresponds to 2.3%. The field error would be half of that.

the liquid parameter assessment give the targeted values from the dipole document. All errors are given in percent of SAR, so 0.1dB corresponds to 2.3%. The field error would be half of that.

## System validation

In the table below, the system validation uncertainty with respect to the analytically assessed SAR value of a dipole source as given in the P1528 standard is given. This uncertainty is smaller than the expected uncertainty for mobile phone measurements due to the simplified setup and the symmetric field distribution.

Error Sources	Uncertainty Value	Probability Distribution	Divisor	$c_i$ 1g	$c_i$ 10g	Standard Uncertainty 1g	Standard Uncertainty 10g	$v_i^2$ or $v_{eff}$
<b>Measurement System</b>								
Probe calibration	± 5.9%	Normal	1	1	1	± 5.9%	± 5.9%	∞
Axial isotropy	± 4.7%	Rectangular	√3	1	1	± 2.7%	± 2.7%	∞
Hemispherical isotropy	± 9.6%	Rectangular	√3	0.7	0.7	± 0.0%	± 0.0%	∞
Boundary effects	± 1.0%	Rectangular	√3	1	1	± 0.6%	± 0.6%	∞
Probe linearity	± 4.7%	Rectangular	√3	1	1	± 2.7%	± 2.7%	∞
System detection limits	± 1.0%	Rectangular	√3	1	1	± 0.6%	± 0.6%	∞
Readout electronics	± 0.3%	Normal	1	1	1	± 0.3%	± 0.3%	∞
Response time	± 0.0%	Rectangular	√3	1	1	± 0.0%	± 0.0%	∞
Integration time	± 0.0%	Rectangular	√3	1	1	± 0.0%	± 0.0%	∞
RF ambient conditions	± 1.0%	Rectangular	√3	1	1	± 0.6%	± 0.6%	∞
Probe positioner	± 0.4%	Rectangular	√3	1	1	± 0.2%	± 0.2%	∞
Probe positioning	± 2.9%	Rectangular	√3	1	1	± 1.7%	± 1.7%	∞
Max. SAR evaluation	± 1.0%	Rectangular	√3	1	1	± 0.6%	± 0.6%	∞
<b>Dipole</b>								
Deviation of experimental dipole	± 5.5%	Rectangular	√3	1	1	± 3.2%	± 3.2%	∞
Dipole axis to liquid distance	± 2.0%	Rectangular	1	1	1	± 1.2%	± 1.2%	∞
Power drift	± 4.7%	Rectangular	√3	1	1	± 2.7%	± 2.7%	∞

<b>Phantom and Set-up</b>								
Phantom uncertainty	± 4.0%	Rectangular	$\sqrt{3}$	1	1	± 2.3%	± 2.3%	$\infty$
Liquid conductivity (target)	± 5.0%	Rectangular	$\sqrt{3}$	0.64	0.43	± 1.8%	± 1.2%	$\infty$
Liquid conductivity (meas.)	± 2.5%	Normal	1	0.64	0.43	± 1.6%	± 1.1%	$\infty$
Liquid permittivity (target)	± 5.0%	Rectangular	$\sqrt{3}$	0.6	0.49	± 1.7%	± 1.4%	$\infty$
Liquid permittivity (meas.)	± 2.5%	Normal	1	0.6	0.49	± 1.5%	± 1.2%	$\infty$
<b>Combined Uncertainty</b>						<b>± 9.5%</b>	<b>± 9.2%</b>	
<b>Expanded Std. Uncertainty</b>						<b>± 18.9%</b>	<b>± 18.4%</b>	

### Performance check repeatability

The repeatability check of the validation is insensitive to external effects and gives an indication of the variations in the DASY5 measurement system, provided that the same power reading setup is used for all validations. The repeatability estimate is given in the following table:

Error Sources	Uncertainty Value	Probability Distribution	Divisor	$c_i$ 1g	$c_i$ 10g	Standard Uncertainty	Standard Uncertainty	$v_i^2$ or $v_{eff}$
<b>Measurement System</b>								
Probe calibration	± 1.8%	Normal	1	1	1	± 1.8%	± 1.8%	$\infty$
Axial isotropy	± 4.7%	Rectangular	$\sqrt{3}$	1	1	0	0	$\infty$
Hemispherical isotropy	± 9.6%	Rectangular	$\sqrt{3}$	1	1	0	0	$\infty$
Boundary effects	± 1.0%	Rectangular	$\sqrt{3}$	1	1	0	0	$\infty$
Probe linearity	± 4.7%	Rectangular	$\sqrt{3}$	1	1	0	0	$\infty$
System detection limits	± 1.0%	Rectangular	$\sqrt{3}$	1	1	0	0	$\infty$
Readout electronics	± 0.3%	Normal	1	1	1	0	0	$\infty$
Response time	± 0.0%	Rectangular	$\sqrt{3}$	1	1	0	0	$\infty$
Integration time	± 0.0%	Rectangular	$\sqrt{3}$	1	1	0	0	$\infty$
RF ambient conditions	± 0.0%	Rectangular	$\sqrt{3}$	1	1	0	0	$\infty$
Probe positioner	± 0.4%	Rectangular	$\sqrt{3}$	1	1	± 0.2%	± 0.2%	$\infty$
Probe positioning	± 2.9%	Rectangular	$\sqrt{3}$	1	1	± 1.7%	± 1.7%	$\infty$
Max. SAR evaluation	± 1.0%	Rectangular	$\sqrt{3}$	1	1	0	0	$\infty$

		ar						
<b>Dipole</b>								
Deviation of experimental dipole	± 5.5%	Rectangular	$\sqrt{3}$	1	1	0	0	$\infty$
Dipole axis to liquid distance	± 2.0%	Rectangular	$\sqrt{3}$	1	1	± 1.2%	± 1.2%	$\infty$
Input power and power drift	± 4.7%	Rectangular	$\sqrt{3}$	1	1	± 2.7%	± 2.7%	$\infty$
<b>Phantom and Set-up</b>								
Phantom uncertainty	± 4.0%	Rectangular	$\sqrt{3}$	1	1	± 2.3%	± 2.3%	$\infty$
Liquid conductivity (target)	± 5.0%	Rectangular	$\sqrt{3}$	0.64	0.43	± 1.8%	± 1.2%	$\infty$
Liquid conductivity (meas.)	± 2.5%	Rectangular	1	0.64	0.43	± 1.6%	± 1.1%	$\infty$
Liquid permittivity (target)	± 5.0%	Rectangular	$\sqrt{3}$	0.6	0.49	± 1.7%	± 1.4%	$\infty$
Liquid permittivity (meas.)	± 2.5%	Rectangular	1	0.6	0.49	± 1.5%	± 1.2%	$\infty$
<b>Combined Uncertainty</b>						<b>± 5.6%</b>	<b>± 5.1%</b>	$\infty$
<b>Expanded Std. Uncertainty</b>						<b>± 11.2%</b>	<b>± 10.3%</b>	

The expected repeatability deviation is low. Excessive drift (e.g., drift in liquid parameters), partial system failures or incorrect parameter settings (e.g., wrong probe or device settings) will lead to unexpectedly high repeatability deviations. The repeatability gives an indication that the system operates within its initial specifications. Excessive drift, system failure and operator errors are easily detected.

#### Annex 4.6.4 Power set-up for validation

The uncertainty of the dipole input power is a significant contribution to the absolute uncertainty and the expected deviation in inter-laboratory comparisons. The values in Section 2 for a typical and a sophisticated setup are just average values. Refer to the manual of the power meter and the detector head for the evaluation of the uncertainty in your system. The uncertainty also depends on the source matching and the general setup. Below follows the description of a recommended setup and procedures to increase the accuracy of the power reading:

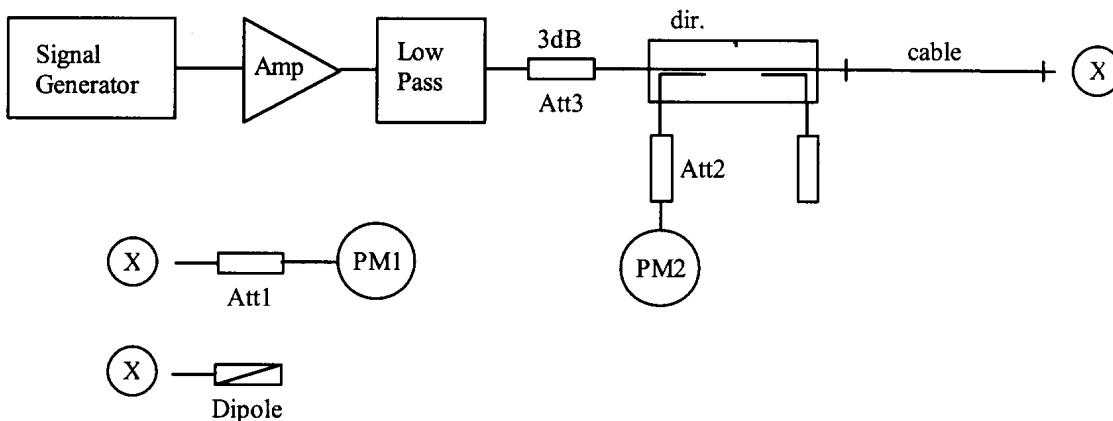

The figure shows the recommended setup. The PM1 (incl. Att1) measures the forward power at the location of the validation dipole connector. The signal generator is adjusted for the desired forward power at the dipole connector and the power meter PM2 is read at that level. After connecting the cable to the dipole, the signal generator is readjusted for the same reading at power meter PM2. If the signal generator does not allow a setting in 0.01dB steps, the remaining difference at PM2 must be noted and considered in the normalization of the validation results. The requirements for the components are:

- The signal generator and amplifier should be stable (after warm-up). The forward power to the dipole should be above 10mW to avoid the influence of measurement noise. If the signal generator can deliver 15dBm or more, an amplifier is not necessary. Some high power amplifiers should not be operated at a level far below their maximum output power level (e.g. a 100W power amplifier operated at 250mW output can be quite noisy). An attenuator between the signal generator and amplifier is recommended to protect the amplifier input.
- The low pass filter after the amplifier reduces the effect of harmonics and noise from the amplifier. For most amplifiers in normal operation the filter is not necessary.
- The attenuator after the amplifier improves the source matching and the accuracy of the power head. (See power meter manual.) It can also be used also to make the amplifier operate at its optimal output level for noise and stability. In a setup without directional coupler, this attenuator should be at least 10dB.
- The directional coupler (recommended <sup>3</sup> 20dB) is used to monitor the forward power and adjust the signal generator output for constant forward power. A medium quality coupler is sufficient because the loads (dipole and power head) are well matched. (If the setup is used for reflective loads, a high quality coupler with respect to directivity and output matching is necessary to avoid additional errors.)
- The power meter PM2 should have a low drift and a resolution of 0.01dBm, but otherwise its accuracy has no impact on the power setting. Calibration is not required.
- The cable between the coupler and dipole must be of high quality, without large attenuation and phase changes when it is moved. Otherwise, the power meter head PM1 should be brought to the location of the dipole for measuring.
- The power meter PM1 and attenuator Att1 must be high quality components. They should be calibrated, preferably together. The attenuator (<sup>3</sup>10dB) improves the accuracy of the power reading.

(Some higher power heads come with a built-in calibrated attenuator.) The exact attenuation of the attenuator at the frequency used must be known; many attenuators are up to 0.2dB off from the specified value.

- Use the same power level for the power setup with power meter PM1 as for the actual measurement to avoid linearity and range switching errors in the power meter PM2. If the validation is performed at various power levels, do the power setting procedure at each level.
- The dipole must be connected directly to the cable at location “X”. If the power meter has a different connector system, use high quality couplers. Preferably, use the couplers at the attenuator Att1 and calibrate the attenuator with the coupler.
- Always remember: We are measuring power, so 1% is equivalent to 0.04dB.

## **Annex 4.6.5 Laboratory reflections**

In near-field situations, the absorption is predominantly caused by induction effects from the magnetic near-field. The absorption from reflected fields in the laboratory is negligible. On the other hand, the magnetic field around the dipole depends on the currents and therefore on the feedpoint impedance. The feedpoint impedance of the dipole is mainly determined from the proximity of the absorbing phantom, but reflections in the laboratory can change the impedance slightly. A 1% increase in the real part of the feedpoint impedance will produce approximately a 1% decrease in the SAR for the same forward power. The possible influence of laboratory reflections should be investigated during installation. The validation setup is suitable for this check, since the validation is sensitive to laboratory reflections. The same tests can be performed with a mobile phone, but most phones are less sensitive to reflections due to the shorter distance to the phantom. The fastest way to check for reflection effects is to position the probe in the phantom above the feedpoint and start a continuous field measurement in the DASY5 multimeter window. Placing absorbers in front of possible reflectors (e.g. on the ground near the dipole or in front of a metallic robot socket) will reveal their influence immediately. A 10dB absorber (e.g. ferrite tiles or flat absorber mats) is probably sufficient, as the influence of the reflections is small anyway. If you place the absorber too near the dipole, the absorber itself will interact with the reactive near-field. Instead of measuring the SAR, it is also possible to monitor the dipole impedance with a network analyzer for reflection effects. The network analyzer must be calibrated at the SMA connector and the electrical delay (two times the forward delay in the dipole document) must be set in the NWA for comparisons with the reflection data in the dipole document. If the absorber has a significant influence on the results, the absorber should be left in place for validation or measurements. The reference data in the dipole document are produced in a low reflection environment.

## **Annex 4.6.6 Additional system checks**

While the validation gives a good check of the DASY5 system components, it does not include all parameters necessary for real phone measurements (e.g. device modulation or device positioning). For system validation (repeatability) or comparisons between laboratories a reference device can be useful. This can be any mobile phone with a stable output power (preferably a device whose output power can be set through the keyboard). For comparisons, the same device should be sent around, since the SAR variations between samples can be large. Several measurement possibilities in the DASY software allow additional tests of the performance of the DASY system and components. These tests can be useful to localize component failures:

- The validation can be performed at different power levels to check the noise level or the correct compensation of the diode compression in the probe.
- If a pulsed signal with high peak power levels is fed to the dipole, the performance of the diode compression compensation can be tested. The correct crest factor parameter in the DASY software must be set (see manual). The system should give the same SAR output for the same averaged input power.