



RF TEST REPORT

Applicant Huawei Technologies Co., Ltd.
FCC ID QISAP4050DN-E
Product Wireless LAN Access Point
Model AP4050DN-E
Report No. R1805A0265-R2V1
Issue Date June 27, 2018

TA Technology (Shanghai) Co., Ltd. tested the above equipment in accordance with the requirements in **FCC CFR47 Part 15C (2017)**. The test results show that the equipment tested is capable of demonstrating compliance with the requirements as documented in this report.

Performed by: Zhengqiang Zhou

Approved by: Kai Xu

TA Technology (Shanghai) Co., Ltd.

No.145, Jintang Rd, Tangzhen Industry Park, Pudong Shanghai, China

TEL: +86-021-50791141/2/3

FAX: +86-021-50791141/2/3-8000



TABLE OF CONTENT

1. Test Laboratory	4
1.1. Notes of the test report.....	4
1.2. Test facility	4
1.3. Testing Location.....	5
2. General Description of Equipment under Test.....	6
3. Applied Standards	8
4. Test Configuration	9
5. Test Case Results	10
5.1. Maximum conducted output power	10
5.2. 6dB Bandwidth	14
5.3. Band Edge	19
5.4. Power Spectral Density	22
5.5. Spurious RF Conducted Emissions.....	32
5.6. Radiated Emissions in the Restricted Band	37
5.7. Radiates Emission	44
5.8. Conducted Emission	78
6. Main Test Instruments.....	81
ANNEX A: EUT Appearance and Test Setup	82
A.1 EUT Appearance	82
A.2 Test Setup	83



Summary of measurement results

Number	Summary of measurements of results	Clause in FCC rules	Verdict
1	Maximum conducted output power	15.247(b)(3)	PASS
2	6 dB bandwidth	15.247(a)(2)	PASS
3	Power spectral density	15.247(e)	PASS
4	Band Edge	15.247(d)	PASS
5	Spurious RF Conducted Emissions	15.247(d)	PASS
6	Radiated Emissions in restricted frequency bands	15.247(d),15.205,15.209	PASS
7	Radiated Emissions	15.247(d),15.205,15.209	PASS
8	Conducted Emissions	15.207	PASS
Date of Testing: June 2, 2018~ June 11, 2018			

1. Test Laboratory

1.1. Notes of the test report

This report shall not be reproduced in full or partial, without the written approval of **TA technology (shanghai) co., Ltd.** The results documented in this report apply only to the tested sample, under the conditions and modes of operation as described herein .Measurement Uncertainties were not taken into account and are published for informational purposes only. This report is written to support regulatory compliance of the applicable standards stated above.

1.2. Test facility

CNAS (accreditation number: L2264)

TA Technology (Shanghai) Co., Ltd. has obtained the accreditation of China National Accreditation Service for Conformity Assessment (CNAS).

FCC (Designation number: CN1179, Test Firm Registration Number: 446626)

TA Technology (Shanghai) Co., Ltd. has been listed on the US Federal Communications Commission list of test facilities recognized to perform electromagnetic emissions measurements.

IC (recognition number is 8510A)

TA Technology (Shanghai) Co., Ltd. has been listed by industry Canada to perform electromagnetic emission measurement.

VCCI (recognition number is C-4595, T-2154, R-4113, G-10766)

TA Technology (Shanghai) Co., Ltd. has been listed by industry Japan to perform electromagnetic emission measurement.

A2LA (Certificate Number: 3857.01)

TA Technology (Shanghai) Co., Ltd. has been listed by American Association for Laboratory Accreditation to perform electromagnetic emission measurement.



1.3. Testing Location

Company: TA Technology (Shanghai) Co., Ltd.
Address: No.145, Jintang Rd, Tangzhen Industry Park, Pudong
City: Shanghai
Post code: 201201
Country: P. R. China
Contact: Xu Kai
Telephone: +86-021-50791141/2/3
Fax: +86-021-50791141/2/3-8000
Website: <http://www.ta-shanghai.com>
E-mail: xukai@ta-shanghai.com

2. General Description of Equipment under Test

Client Information

Applicant	Huawei Technologies Co., Ltd.
Applicant address	Administration Building, Headquarters of Huawei Technologies Co., Ltd., Bantian, Longgang District Shenzhen 518129 P.R. China
Manufacturer	Huawei Technologies Co., Ltd.
Manufacturer address	Administration Building, Headquarters of Huawei Technologies Co., Ltd., Bantian, Longgang District Shenzhen 518129 P.R. China

General information

EUT Description	
Model	AP4050DN-E
IMEI/SN	21500829442SJ5601554
Hardware Version	VER.F
Software Version	V200
Power Supply	DC adapter
Antenna Type	Internal Antenna
Antenna Connector	A permanently attached antenna (meet with the standard FCC Part 15.203 requirement)
Antenna Gain	Antenna 1: 1.50 dBi Antenna 2: 1.50 dBi
additional beamforming gain	3 dB
Test Mode	Bluetooth V4.2 LE 802.11b 802.11g, 802.11n(HT20/HT40);
Modulation Type	BLE :GFSK 802.11b: DSSS; 802.11g/n(HT20/HT40): OFDM
Max. Conducted Power	Wi-Fi 2.4G :23.24dBm BLE : 3.77 dBm
Operating Frequency Range(s)	802.11b/g/n(HT20): 2412 ~ 2462 MHz 802.11n(HT40): 2422 ~ 2452 MHz BLE: 2402 ~2478 MHz
EUT Accessory	
DC Adapter	Manufacturer: Shenzhen Honor Electronics Co.,Ltd. Model: HW-560107D0D
POE	Model: AC6005-8-PWR



Current meter

Model: Tesgine

Note:1. The information of the EUT is declared by the manufacturer.

2. The EUT don't have standard Adapter. The adapter used for testing in this report is the after-market accessory.

3. Applied Standards

According to the specifications of the manufacturer, it must comply with the requirements of the following standards:

Test standards

- **FCC CFR47 Part 15C (2017) Radio Frequency Devices**
- **ANSI C63.10 (2013)**
- **KDB 558074 D01 DTS Meas Guidance v04**
- **KDB 662911 D01 Multiple Transmitter Output v02r01**

4. Test Configuration

Test Mode

The EUT has been associated with peripherals and configuration operated in a manner tended to maximize its emission characteristics in a typical application.

The radiated emission was measured in the following position: EUT stand-up position (Z axis), lie-down position (X, Y axis). The worst emission was found in lie-down position (X axis) and the worst case was recorded.

In order to find the worst case condition, Pre-tests are needed at the presence of different data rate. Preliminary tests have been done on all the configuration for confirming worst case. Data rate below means worst-case rate of each test item.

The test software is used IPOP : IPOP

Worst-case data rates are shown as following table.

Band	Data Rate		
	Antenna 1	Antenna 2	MIMO
802.11b	1 Mbps	1 Mbps	/
802.11g	6 Mbps	6 Mbps	/
802.11n HT20	MCS0	MCS0	MCS0
802.11n HT40	MCS0	MCS0	MCS0

The worst case Antenna mode for each of the following tests for Wi-Fi:

Test Cases	Antenna 1	Antenna 2	MIMO
Maximum conducted output power	O	O	802.11n HT20 802.11n HT40
6dB Bandwidth	802.11b/g	--	802.11n HT20 802.11n HT40
Band Edge	802.11b/g	--	802.11n HT20 802.11n HT40
Power Spectral Density	O	O	802.11n HT20 802.11n HT40
Spurious RF Conducted Emissions	802.11b/g	--	802.11n HT20 802.11n HT40
Radiates Emission in the Restricted Band	802.11b/g	--	802.11n HT20 802.11n HT40
Radiates Emission	802.11b/g	--	802.11n HT20 802.11n HT40
Conducted Emission	802.11b/g	--	802.11n HT20 802.11n HT40
Note: "O": test all bands			

5. Test Case Results

5.1. Maximum conducted output power

Ambient condition

Temperature	Relative humidity	Pressure
23°C ~25°C	45%~50%	101.5kPa

Methods of Measurement

During the process of the testing, The EUT was connected to Average Power meter with a known loss. The EUT is max power transmission with proper modulation. The signal transmission is continuous.

The conducted Power is measured at each antenna port. The measured results at the various antenna ports are then summed mathematically.

Test Setup

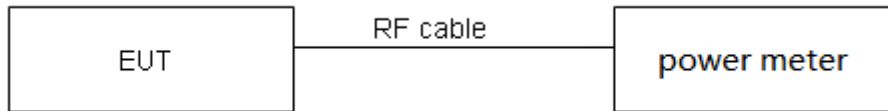

Limits

Rule Part 15.247 (b) (3) specifies that " For systems using digital modulation in the 902–928 MHz, 2400–2483.5 MHz: 1 Watt."

Average Output Power	$\leq 1W$ (30dBm)
----------------------	-------------------

Measurement Uncertainty

The assessed measurement uncertainty to ensure 95% confidence level for the normal distribution is with the coverage factor $k = 2$, $U = 0.44$ dB.

Test Results

MIMO Antenna 1&2 without Beamforming

MIMO Antenna 1&2 without Beamforming Power Index						
Packet Type	Antenna 1			Antenna 2		
	CH1	CH6	CH11	CH1	CH6	CH11
802.11b	20	20	20	20	20	20
802.11g	17	20	18	17	20	18
802.11n HT20	16	20	19	16	20	19
Packet Type	CH3	CH6	CH9	CH3	CH6	CH9
802.11n HT40	17	20	18	17	20	18

MIMO Antenna 1&2 with Beamforming

MIMO Antenna 1&2 with Beamforming Power Index						
Packet Type	Antenna 1			Antenna 2		
	CH1	CH6	CH11	CH1	CH6	CH11
802.11n HT20	17	17	17	17	17	17
Packet Type	CH3	CH6	CH9	CH3	CH6	CH9
802.11n HT40	19	19	19	19	19	19

Band	T _{on} (ms)	T _(on+off) (ms)	Duty cycle	Duty cycle correction Factor(dB)
802.11b	12.21	12.29	0.99	N/A
802.11g	2.02	2.10	0.96	0.17
802.11n HT20	4.96	5.04	0.98	N/A
802.11n HT40	2.41	2.49	0.97	0.14
BLE	0.41	0.62	0.66	1.80

Note: when Duty cycle>0.98, Duty cycle correction Factor not required.

Network	Carrier frequency	Read Value	Output Power	Limit	Conclusion
Standards	(MHz)	(dBm)	(dBm)	(dBm)	
Bluetooth (Low Energy)	2402	1.97	3.77	30	PASS
	2440	1.40	3.20	30	PASS
	2478	1.62	3.42	30	PASS

Note: Output Power=Read Value+Duty cycle correction factor

MIMO without Beamforming

Network Standards	Carrier frequency (MHz)	MIMO Antenna 1		MIMO Antenna 2		Total Power (dBm)	Limit (dBm)	Conclusion
		Average Power Measured (dBm)	Average Power with duty factor (dBm)	Average Power Measured (dBm)	Average Power with duty factor (dBm)			
802.11b HT20	2412	20.34	20.34	20.02	20.02	23.19	30	PASS
	2437	20.36	20.36	20.09	20.09	23.24	30	PASS
	2462	20.14	20.14	20.15	20.15	23.16	30	PASS
802.11g HT20	2412	16.05	16.22	15.89	16.06	19.15	30	PASS
	2437	19.91	20.08	19.88	20.05	23.07	30	PASS
	2462	17.22	17.39	17.04	17.21	20.31	30	PASS
802.11n HT20	2412	15.96	15.96	15.94	15.94	18.96	30	PASS
	2437	19.92	19.92	19.92	19.92	22.93	30	PASS
	2462	18.14	18.14	17.99	17.99	21.08	30	PASS
802.11n HT40	2422	16.22	16.36	16.05	16.19	19.29	30	PASS
	2437	19.24	19.38	19.17	19.31	22.36	30	PASS
	2452	17.14	17.28	17.18	17.32	20.31	30	PASS

Note: 1. For Total Power, according to KDB 662911 D01 Multiple Transmitter Output v02r01 1),
The Total Power =10log (10^(Power antenna1 in dBm/10)+10^(Power antenna2 in dBm/10)).



2. The manufacturer declared the transmitter output signals is CDD mode. And $N_{SS}=2$. According to KDB 662911 D01 Multiple Transmitter Output v02r01 2)f)(i): If all antennas have the same gain, Directional gain = $G_{ANT} + \text{Array Gain}$,
 For power measurements on IEEE 802.11 devices,
 Array Gain = 0 dB (i.e., no array gain) for $N_{ANT} \leq 4$;
 Array Gain = 0 dB (i.e., no array gain) for channel widths ≥ 40 MHz for any N_{ANT} ;
 Array Gain = $5 \log(N_{ANT}/N_{SS})$ dB or 3 dB, whichever is less, for 20-MHz channel widths with $N_{ANT} \geq 5$.
 So directional gain = $G_{ANT} + \text{Array Gain} = 1.5 + 0 = 1.5 \text{ dBi} < 6 \text{ dBi}$. So the power limit is 30dBm.

MIMO with Beamforming

Network Standards	Carrier frequency (MHz)	MIMO Antenna 1		MIMO Antenna 2		Total Power (dBm)	Limit (dBm)	Conclusion
		Average Power Measured (dBm)	Average Power with duty factor (dBm)	Average Power Measured (dBm)	Average Power with duty factor (dBm)			
802.11n HT20	2412	19.82	19.82	19.92	19.92	22.88	30	PASS
	2437	19.88	19.88	19.98	19.98	22.94	30	PASS
	2462	20.04	20.04	19.94	19.94	23.00	30	PASS
802.11n HT40	2422	19.06	19.20	19.01	19.15	22.19	30	PASS
	2437	19.18	19.32	19.07	19.21	22.28	30	PASS
	2452	19.16	19.30	19.19	19.33	22.33	30	PASS

Note: 1. For Total Power, according to KDB 662911 D01 Multiple Transmitter Output v02r01 1),

The Total Power = $10 \log (10^{(\text{Power antenna1 in dBm}/10)} + 10^{(\text{Power antenna2 in dBm}/10)})$.

2. Direction gain calculation according to KDB662911 D01 Multiple Transmitter Output v02r01 F) 2) e) (i), If all antennas have the same gain, directional gain = $G_{ANT} + 10 \log(N_{ANT}/N_{SS}) = 1.5 + 10 \log(2/2) = 1.5 \text{ dBi} < 6 \text{ dBi}$. So the limit is 30dBm.

5.2. 6dB Bandwidth

Ambient condition

Temperature	Relative humidity	Pressure
23°C ~25°C	45%~50%	101.5kPa

Method of Measurement

The EUT was connected to the spectrum analyzer through an external attenuator (20dB) and a known loss cable. RBW is set to 100 kHz; VBW is set to 300 kHz on spectrum analyzer. Dector=Peak, Trace mode=max hold.

Test Setup

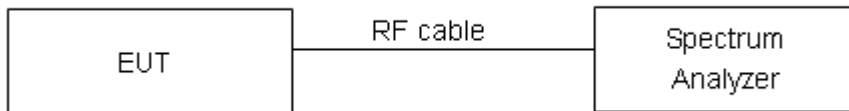

Limits

Rule Part 15.247 (a) (2) specifies that “Systems using digital modulation techniques may operate in the 902–928 MHz, 2400–2483.5 MHz bands. The minimum 6 dB bandwidth shall be at least 500 kHz.”

minimum 6 dB bandwidth	≥ 500 kHz
------------------------	-----------

Measurement Uncertainty

The assessed measurement uncertainty to ensure 95% confidence level for the normal distribution is with the coverage factor $k = 2$, $U = 936$ Hz.

Test Results:

Network Standards	Carrier frequency (MHz)	99% bandwidth (MHz)	Minimum 6 dB bandwidth (MHz)	Limit (kHz)	Conclusion
802.11b	2412	12.926	8.085	500	PASS
	2437	12.957	8.089	500	PASS
	2462	12.933	8.076	500	PASS
802.11g	2412	16.352	16.360	500	PASS
	2437	16.370	16.360	500	PASS
	2462	16.352	16.370	500	PASS
802.11n HT20	2412	17.565	17.600	500	PASS
	2437	17.580	17.600	500	PASS
	2462	17.572	17.590	500	PASS
802.11n HT40	2422	35.859	35.690	500	PASS
	2437	35.819	35.180	500	PASS
	2452	35.845	35.380	500	PASS
Bluetooth (Low Energy)	2402	1.0910	0.7412	500	PASS
	2440	1.1243	0.7475	500	PASS
	2478	1.2088	0.7626	500	PASS

802.11b, Carrier frequency (MHz): 2412



802.11g, Carrier frequency (MHz): 2412



802.11b, Carrier frequency (MHz): 2437



802.11g, Carrier frequency (MHz): 2437



802.11b, Carrier frequency (MHz): 2462



802.11g, Carrier frequency (MHz): 2462



802.11n(HT20), Carrier frequency (MHz): 2412



802.11n(HT40), Carrier frequency (MHz): 2422



802.11n(HT20), Carrier frequency (MHz): 2437

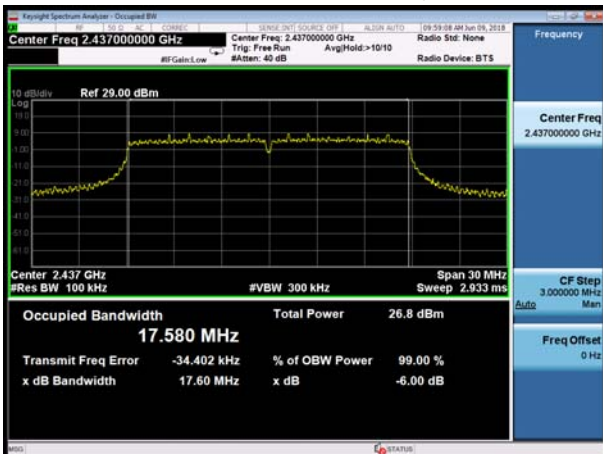

802.11n(HT40), Carrier frequency (MHz): 2437



802.11n(HT20), Carrier frequency (MHz): 2462



802.11n(HT40), Carrier frequency (MHz): 2452



BLE Carrier frequency (MHz): 2402



BLE Carrier frequency (MHz): 2440



BLE Carrier frequency (MHz): 2478

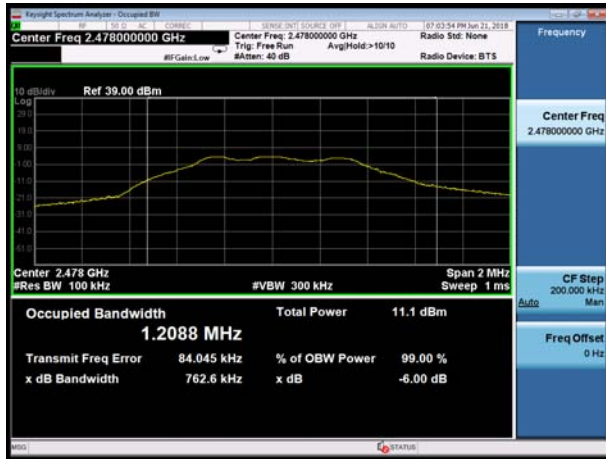

5.3. Band Edge

Ambient condition

Temperature	Relative humidity	Pressure
23°C ~25°C	45%~50%	101.5kPa

Method of Measurement

The EUT was connected to the spectrum analyzer through an external attenuator (20dB) and a known loss cable the band edge of the lowest and highest channels were measured. The peak detector is used and RBW is set to 100 kHz and VBW is set to 300 kHz on spectrum analyzer. Spectrum analyzer plots are included on the following pages.

Test Setup

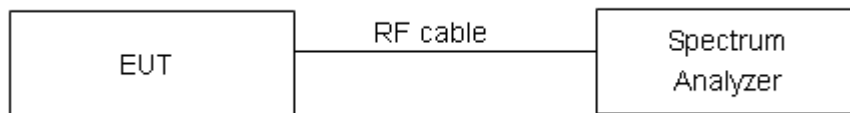

Limits

Rule Part 15.247(d) specifies that “In any 100 kHz bandwidth outside the frequency band in which the spread spectrum or digitally modulated intentional radiator is operating, the radio frequency power that is produced by the intentional radiator shall be at least 20 dB below that in the 100 kHz bandwidth within the band that contains the highest level of the desired power, based on either an RF conducted or a radiated measurement, provided the transmitter demonstrates compliance with the peak conducted power limits.” If the transmitter complies with the conducted power limits based on the use of RMS averaging over a time interval, as permitted under paragraph (b)(3) of this section, the attenuation required under this paragraph shall be 30 dB instead of 20 dB.”

Measurement Uncertainty

The assessed measurement uncertainty to ensure 95% confidence level for the normal distribution is with the coverage factor $k = 1.96$.

Frequency	Uncertainty
2GHz-3GHz	1.407 dB



Test Results: PASS

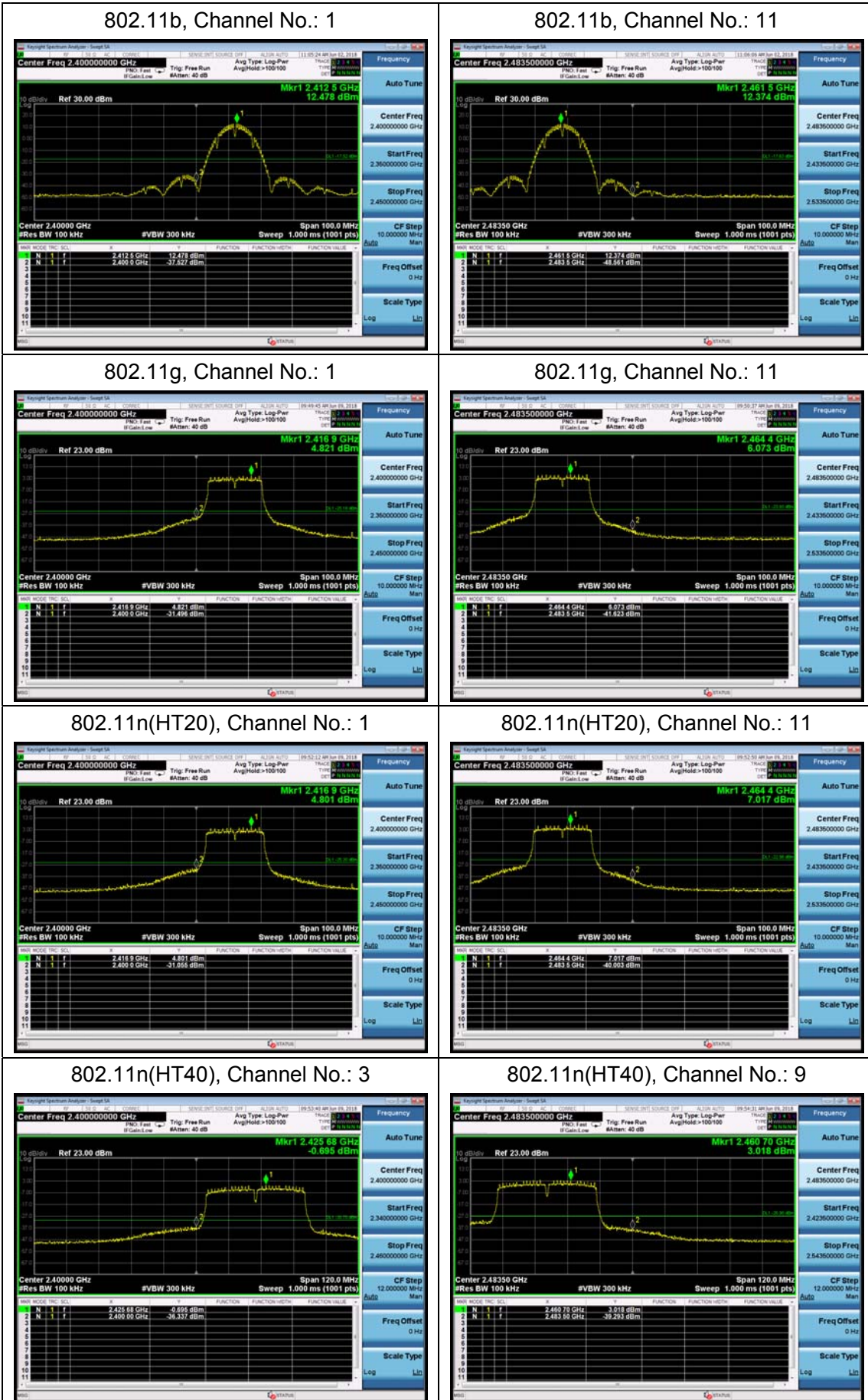

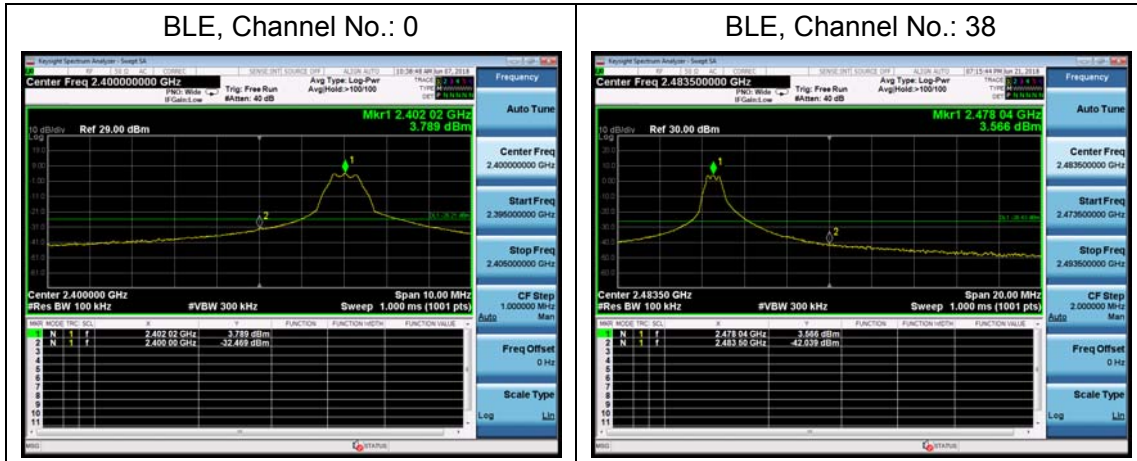

5.4. Power Spectral Density

Ambient condition

Temperature	Relative humidity	Pressure
23°C ~25°C	45%~50%	101.5kPa

Method of Measurement

During the process of the testing, The EUT was connected to Spectrum Analyzer with a known loss. The EUT is max power transmission with proper modulation. Method AVGPSD-2 in KDB558074 D01 was used for this test.

The conducted Power is measured at each antenna port. The measured results at the various antenna ports are then summed mathematically.

Test setup

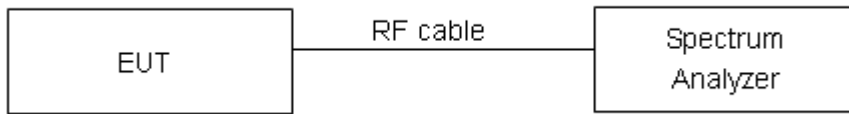

Limits

Rule Part 15.247(e) specifies that” For digitally modulated systems, the power spectral density conducted from the intentional radiator to the antenna shall not be greater than 8 dBm in any 3 kHz band during any time interval of continuous transmission. ”

Limits	≤ 8 dBm / 3kHz
--------	----------------

Measurement Uncertainty

The assessed measurement uncertainty to ensure 95% confidence level for the normal distribution is with the coverage factor $k = 2$, $U = 0.75\text{dB}$.

**Test Results:****MIMO Without Beamforming**

Network Standards	Channel Number	Power Spectral Density				Total PSD (dBm / 3kHz)	Limit (dBm / 3kHz)	Conclusion
		Antenna 1		Antenna 2				
		Read Value (dBm / 3kHz)	Power Spectral Density (dBm / 3kHz)	Read Value (dBm / 3kHz)	Power Spectral Density (dBm / 3kHz)			
802.11b	1	-11.66	-11.66	-11.93	-11.93	-8.78	8.00	PASS
	6	-11.99	-11.99	-11.74	-11.74	-8.85	8.00	PASS
	11	-11.91	-11.91	-11.91	-11.91	-8.90	8.00	PASS
802.11g	1	-18.96	-18.79	-19.13	-18.96	-15.86	8.00	PASS
	6	-15.10	-14.93	-14.93	-14.76	-11.83	8.00	PASS
	11	-17.72	-17.55	-17.94	-17.77	-14.65	8.00	PASS
802.11n HT20	1	-19.42	-19.42	-19.32	-19.32	-16.36	8.00	PASS
	6	-15.29	-15.29	-15.42	-15.42	-12.35	8.00	PASS
	11	-17.74	-17.74	-17.41	-17.41	-14.56	8.00	PASS
802.11n HT40	3	-22.01	-21.86	-21.87	-21.73	-18.78	8.00	PASS
	6	-18.76	-18.61	-18.82	-18.67	-15.63	8.00	PASS
	9	-20.98	-20.84	-20.93	-20.79	-17.80	8.00	PASS

Note: 1.Power Spectral Density =Read Value+Duty cycle correction factor

2. For Total PSD, according to KDB 662911 D01 Multiple Transmitter Output v02r01 2)a),the power spectral density= $10\log(10^{(\text{PSD antenna1 in dBm}/10)}+10^{(\text{PSD antenna2 in dBm}/10)})$

MIMO With Beamforming

Network Standards	Channel Number	Power Spectral Density				Total PSD (dBm / 3kHz)	Limit (dBm / 3kHz)	Conclusion
		Antenna 1		Antenna 2				
		Read Value (dBm / 3kHz)	Power Spectral Density (dBm / 3kHz)	Read Value (dBm / 3kHz)	Power Spectral Density (dBm / 3kHz)			
802.11n HT20	1	-15.59	-15.59	-15.73	-15.73	-12.65	8.00	PASS
	6	-15.29	-15.29	-15.46	-15.46	-12.36	8.00	PASS
	11	-15.65	-15.65	-15.61	-15.61	-12.62	8.00	PASS
802.11n HT40	3	-18.97	-18.83	-18.83	-18.68	-15.75	8.00	PASS
	6	-18.81	-18.66	-18.95	-18.81	-15.72	8.00	PASS
	9	-19.13	-18.99	-18.98	-18.84	-15.90	8.00	PASS

Note: 1.Power Spectral Density =Read Value+Duty cycle correction factor
 2. For Total PSD, according to KDB 662911 D01 Multiple Transmitter Output v02r01 2)a),the power spectral density= $10\log(10^{(PSD\ antenna1\ in\ dBm/10)}+10^{(PSD\ antenna2\ in\ dBm/10)})$
 2. The manufacturer declared the transmitter output signals is CDD mode. And $N_{ss}=1$. According to KDB 662911 D01 Multiple Transmitter Output v02r01 2)f)(i): If all antennas have the same gain, Directional gain = $G_{ANT} + \text{Array Gain}$, For PSD measurements on all devices, $\text{Array Gain}=10\log(N_{ant}/N_{ss})\text{dB}$,so directional gain= $G_{ANT}+\text{Array Gain}=1.5+10\log(2/2)=1.5<6\text{dBi}$. So the power limit is $8+6-\text{MAX}(6,B7)\text{dBm}=8\text{ dBm}$

Network Standards	Channel Number	Read Value (dBm / 3kHz)	Power Spectral Density (dBm / 3kHz)	Limit (dBm / 3kHz)	Conclusion
Bluetooth (Low Energy)	0	-16.06	-14.26	8	PASS
	19	-14.78	-12.98	8	PASS
	38	-15.77	-13.97	8	PASS

Note: Power Spectral Density =Read Value+Duty cycle correction factor



MMO Without Beamforming

ANT 1

802.11b, Channel No.: 1



802.11g, Channel No.: 1

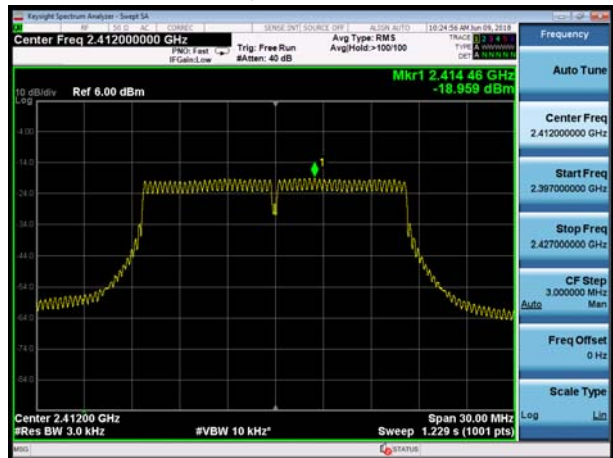

802.11b, Channel No.: 6



802.11g, Channel No.: 6



802.11b, Channel No.: 11



802.11g, Channel No.: 11



802.11n(HT20), Channel No. 1



802.11n(HT40), Channel No. 3



802.11n(HT20), Channel No. 6



802.11n(HT40), Channel No. 6



802.11n(HT20), Channel No. 11



802.11n(HT40), Channel No. 9





ANT 2

802.11b, Channel No.: 1



802.11g, Channel No.: 1

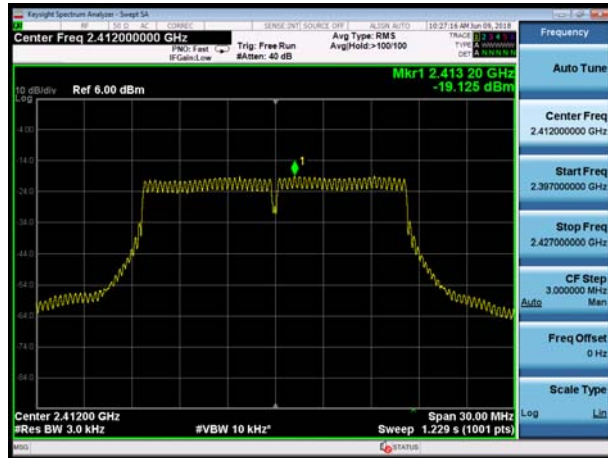

802.11b, Channel No.: 6



802.11g, Channel No.: 6



802.11b, Channel No.: 11



802.11g, Channel No.: 11





802.11n(HT20), Channel No. 1



802.11n(HT40), Channel No. 3



802.11n(HT20), Channel No. 6



802.11n(HT40), Channel No. 6



802.11n(HT20), Channel No. 11



802.11n(HT40), Channel No. 9





MMO Without Beamforming

ANT 1

802.11n(HT20), Channel No. 1

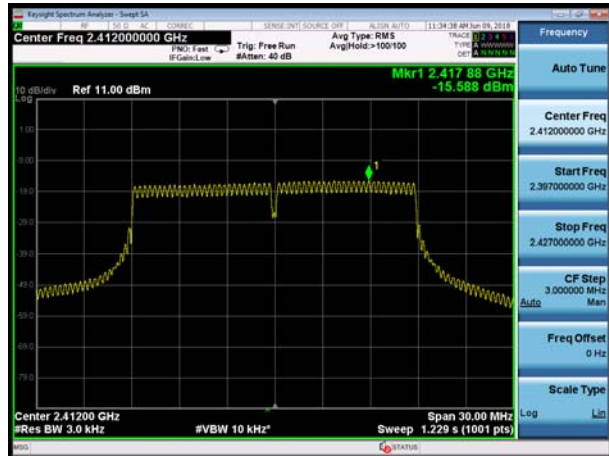

802.11n(HT40), Channel No. 3



802.11n(HT20), Channel No. 6



802.11n(HT40), Channel No. 6



802.11n(HT20), Channel No. 11



802.11n(HT40), Channel No. 9





ANT 2

802.11n(HT20), Channel No. 1



802.11n(HT40), Channel No. 3



802.11n(HT20), Channel No. 6



802.11n(HT40), Channel No. 6



802.11n(HT20), Channel No. 11



802.11n(HT40), Channel No. 9



BLE, Channel No.: 0



BLE, Channel No.: 19

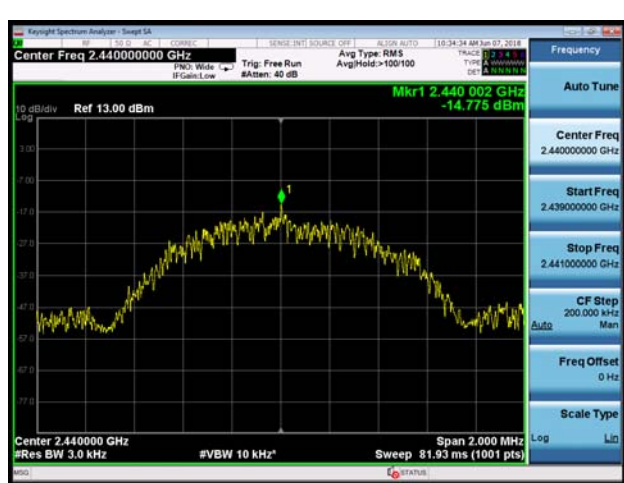

BLE, Channel No.: 38



5.5. Spurious RF Conducted Emissions

Ambient condition

Temperature	Relative humidity	Pressure
23°C ~25°C	45%~50%	101.5kPa

Method of Measurement

The EUT was connected to the spectrum analyzer with a known loss. The spectrum analyzer scans from 30MHz to the 10th harmonic of the carrier. The peak detector is used. Set RBW to100kHz and VBW to 300 kHz, Sweep is set to ATUO.

The test is in transmitting mode.

Test setup



Limits

Rule Part 15.247(d) pacifies that “In any 100 kHz bandwidth outside the frequency band in which the spread spectrum intentional radiator is operating, the radio frequency power that is produced by the intentional radiator shall be at least 30 dB below that in the 100 kHz bandwidth within the band that contains the highest level of the desired power.” If the transmitter complies with the conducted power limits based on the use of RMS averaging over a time interval, as permitted under paragraph (b)(3) of this section, the attenuation required under this paragraph shall be 30 dB instead of 20 dB.”

Network Standards	Carrier frequency (MHz)	Reference value (dBm)	Limit
802.11b	2412	11.74	-18.26
	2437	11.01	-18.99
	2462	12.02	-17.98
802.11g	2412	4.60	-25.40
	2437	8.58	-21.42
	2462	5.51	-24.50
802.11n HT20	2412	3.19	-26.81
	2437	8.21	-21.79
	2462	5.61	-24.39
802.11n HT40	2422	2.13	-27.87
	2437	5.29	-24.71
	2452	3.74	-26.26
Bluetooth (Low Energy)	2402	3.86	-26.14
	2440	3.69	-26.31
	2478	3.60	-26.40

**Measurement Uncertainty**

The assessed measurement uncertainty to ensure 95% confidence level for the normal distribution is with the coverage factor $k = 1.96$.

Frequency	Uncertainty
100kHz-2GHz	0.684 dB
2GHz-26GHz	1.407 dB



Test Results:

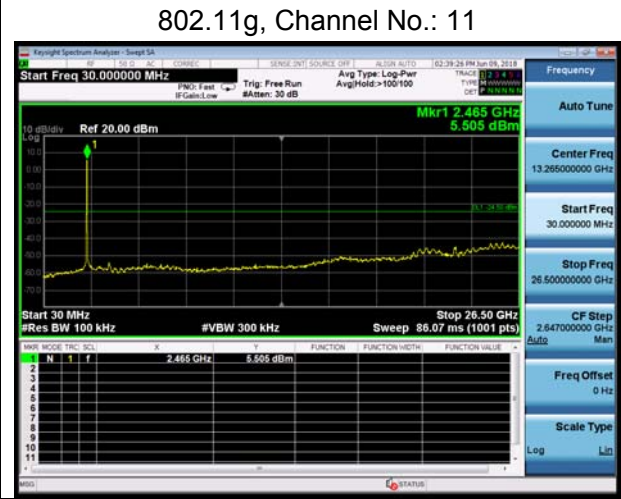
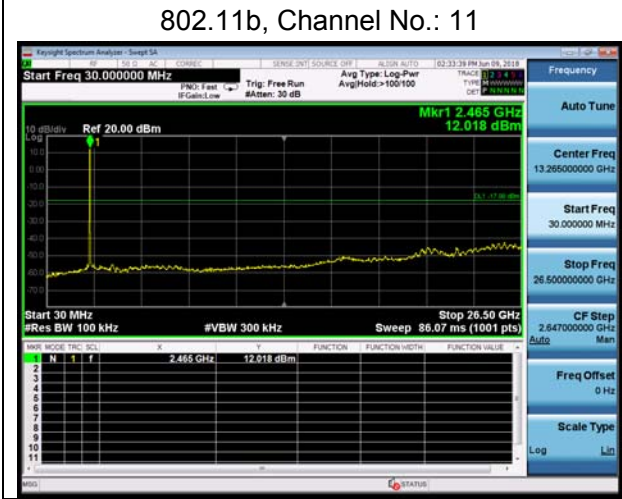
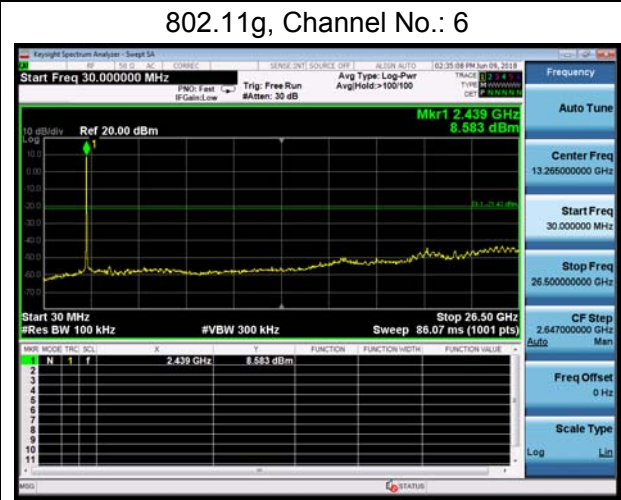
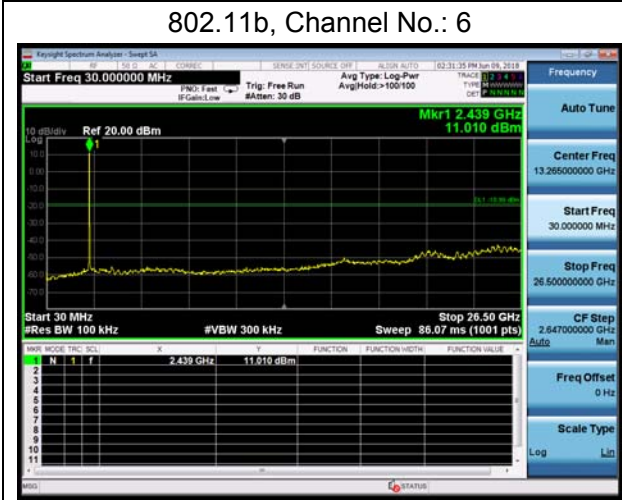
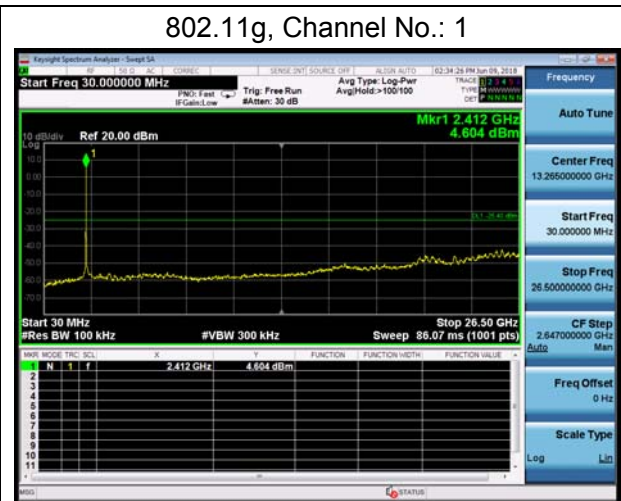
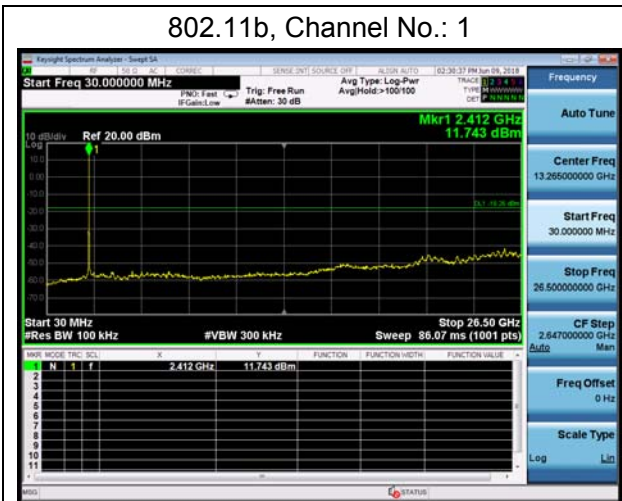



802.11n(HT20), Channel No. 1

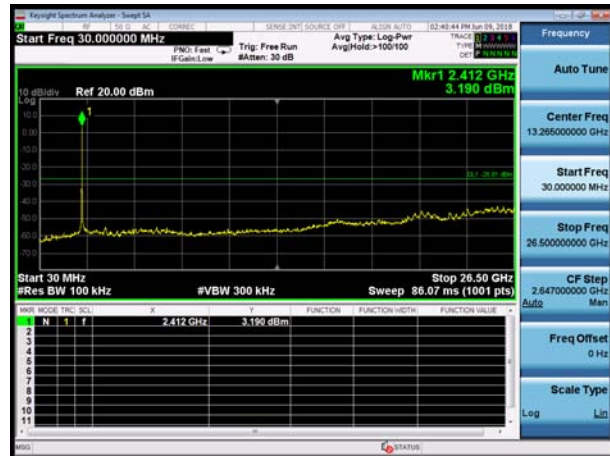

802.11n(HT40), Channel No. 3

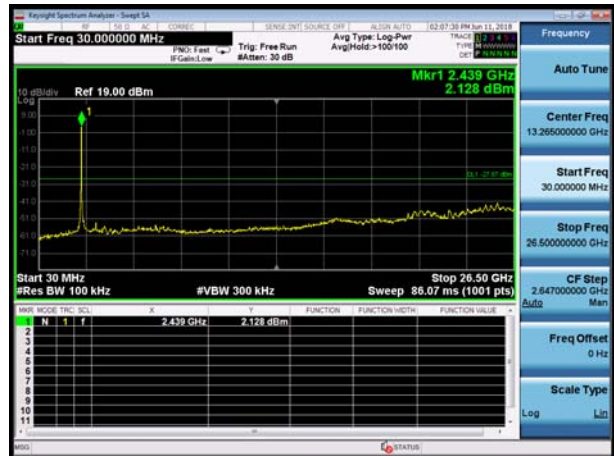

802.11n(HT20), Channel No. 6

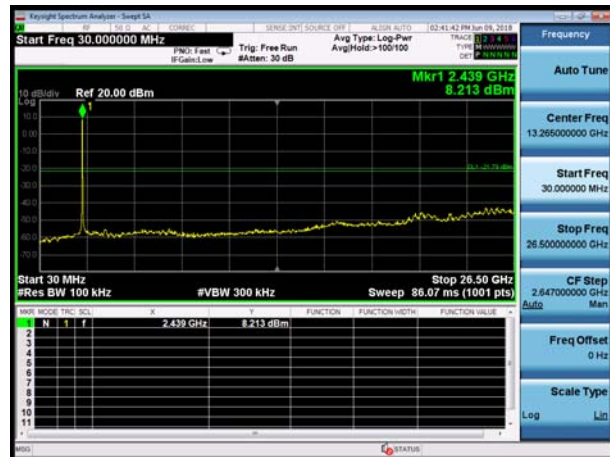

802.11n(HT40), Channel No. 6

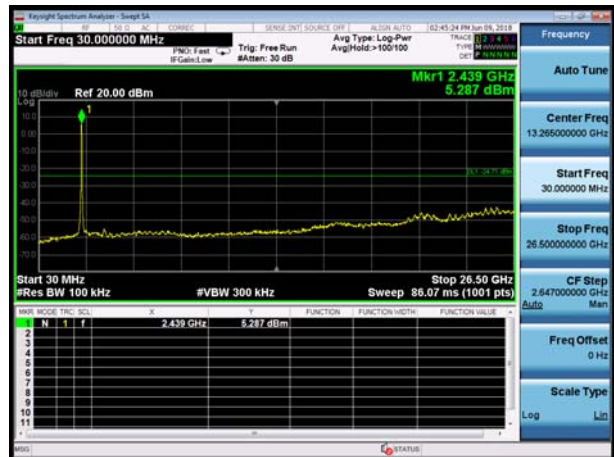

802.11n(HT20), Channel No. 11

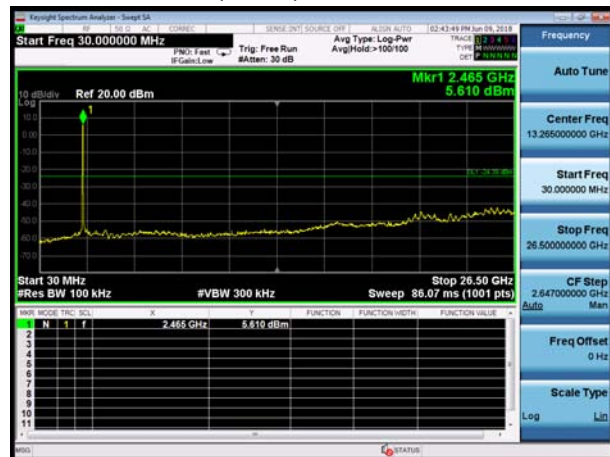

802.11n(HT40), Channel No. 9

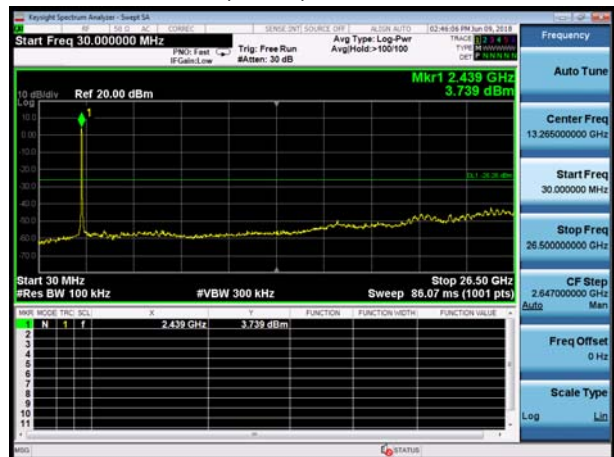



BLE, Channel No.: 0

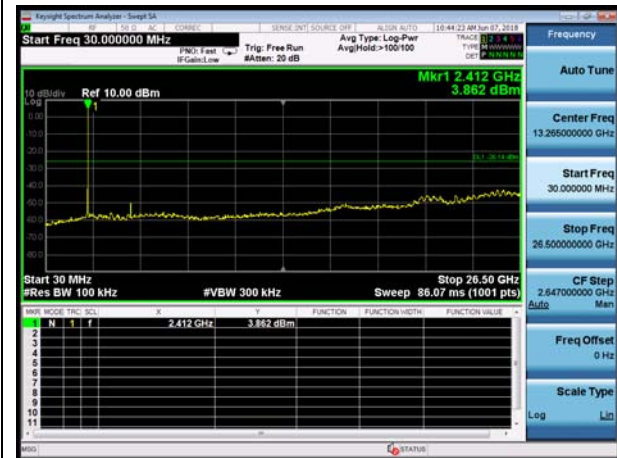

BLE, Channel No.: 19

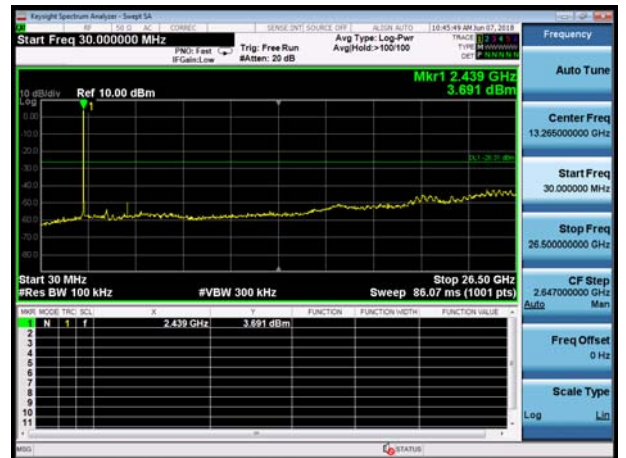

BLE, Channel No.: 38

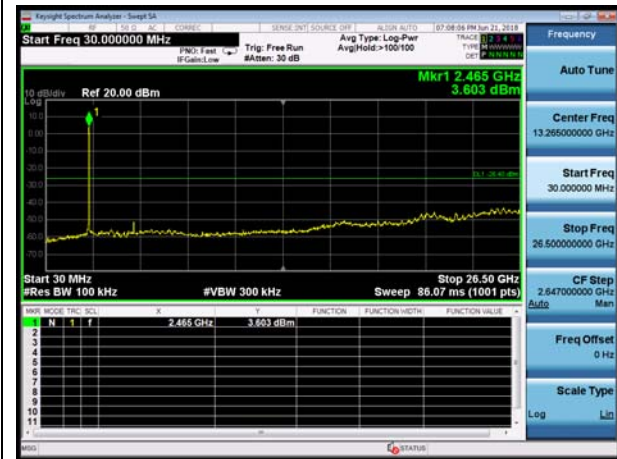

5.6. Radiated Emissions in the Restricted Band

Ambient condition

Temperature	Relative humidity	Pressure
23°C ~25°C	45%~50%	101.5kPa

Method of Measurement

The Equipment Under Test (EUT) was set up on a non-conductive table in the semi-anechoic chamber. The test was performed at the distance of 3 m between the EUT and the receiving antenna. The turntable shall be rotated from 0 to 360 degrees for detecting the maximum of radiated spurious signal level. The measurements shall be repeated with orthogonal polarization of the test antenna. The data of cable loss and antenna factor has been calibrated in full testing frequency range before the testing. Sweep the Restricted Band and the emissions less than 20 dB below the permissible value are reported.

This method refer to KDB 558074.

The procedure for peak unwanted emissions measurements above 1000 MHz is as follows:

I) Peak emission levels are measured by setting the instrument as follows:

- 1) RBW = 1 MHz.
- 2) VBW \geq [3 × RBW]
- 3) Detector = peak.
- 4) Sweep time = auto.
- 5) Trace mode = max hold.
- 6) Allow sweeps to continue until the trace stabilizes. Note that if the transmission is not continuous, then the time required for the trace to stabilize will increase by a factor of approximately 1 / D, where D is the duty cycle.

II) Average emission levels are measured by setting the instrument as follows:

- a) RBW = 1 MHz.
- b) VBW \geq [3 × RBW].
- c) Detector = RMS (power averaging), if [span / (# of points in sweep)] \leq RBW / 2. Satisfying this condition can require increasing the number of points in the sweep or reducing the span. If the condition is not satisfied, then the detector mode shall be set to peak.
- d) Averaging type = power (i.e., rms) (As an alternative, the detector and averaging type may be set for linear voltage averaging. Some instruments require linear display mode to use linear voltage averaging. Log or dB averaging shall not be used.)
- e) Sweep time = auto.
- f) Perform a trace average of at least 100 traces if the transmission is continuous. If the transmission is not continuous, then the number of traces shall be increased by a factor of 1 / D, where D is the duty cycle. For example, with 50% duty cycle, at least 200 traces shall be averaged. (If a specific emission is demonstrated to be continuous—i.e., 100% duty cycle—then rather than turning ON and OFF with the transmit cycle, at least 100 traces shall be averaged.)
- g) If tests are performed with the EUT transmitting at a duty cycle less than 98%, then a correction

factor shall be added to the measurement results prior to comparing with the emission limit, to compute the emission level that would have been measured had the test been performed at 100% duty cycle. The correction factor is computed as follows:

1) If power averaging (rms) mode was used in the preceding step e), then the correction factor is $[10 \log (1 / D)]$, where D is the duty cycle. For example, if the transmit duty cycle was 50%, then 3 dB shall be added to the measured emission levels.

2) If linear voltage averaging mode was used in the preceding step e), then the correction factor is $[20 \log (1 / D)]$, where D is the duty cycle. For example, if the transmit duty cycle was 50%, then 6 dB shall be added to the measured emission levels.

3) If a specific emission is demonstrated to be continuous (100% duty cycle) rather than turning ON and OFF with the transmit cycle, then no duty cycle correction is required for that emission.

The field strength of spurious emission was measured in the following position: EUT stand-up position (Z axis), lie-down position (X, Y axis). The worst emission was found in stand-up position (Z axis) and the antenna is vertical.

The test is in transmitting mode.

Test setup

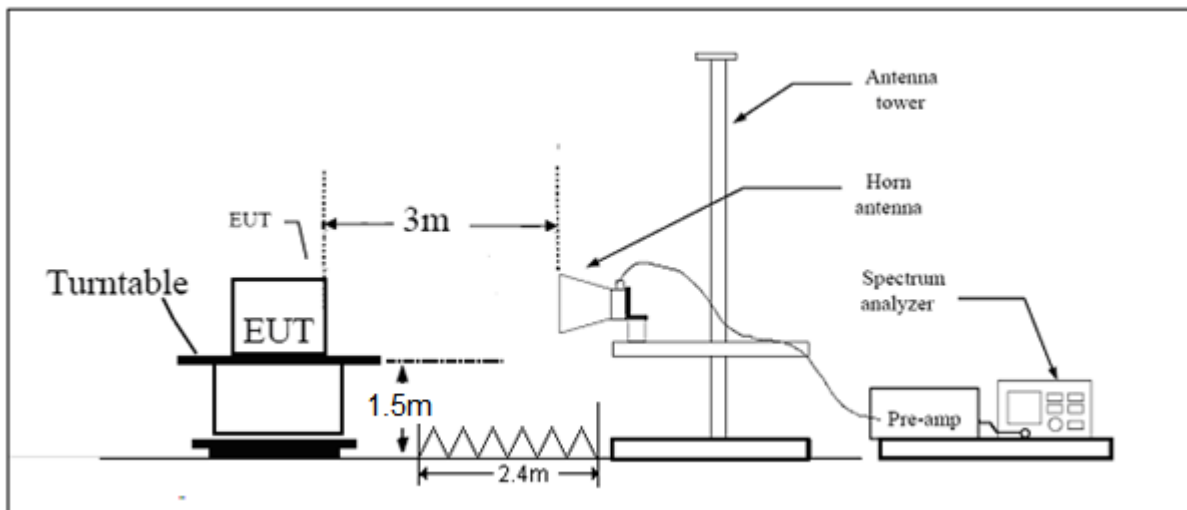

Note: Area side: 2.4mX3.6m

Limits

Spurious Radiated Emissions are permitted in any of the frequency bands listed below:



MHz	MHz	MHz	GHz
0.090 - 0.110	16.42 - 16.423	399.9 - 410	4.5 - 5.15
¹ 0.495 - 0.505	16.69475 - 16.69525	608 - 614	5.35 - 5.46
2.1735 - 2.1905	16.80425 - 16.80475	960 - 1240	7.25 - 7.75
4.125 - 4.128	25.5 - 25.67	1300 - 1427	8.025 - 8.5
4.17725 - 4.17775	37.5 - 38.25	1435 - 1626.5	9.0 - 9.2
4.20725 - 4.20775	73 - 74.6	1645.5 - 1646.5	9.3 - 9.5
6.215 - 6.218	74.8 - 75.2	1660 - 1710	10.6 - 12.7
6.26775 - 6.26825	108 - 121.94	1718.8 - 1722.2	13.25 - 13.4
6.31175 - 6.31225	123 - 138	2200 - 2300	14.47 - 14.5
8.291 - 8.294	149.9 - 150.05	2310 - 2390	15.35 - 16.2
8.362 - 8.366	156.52475 - 156.52525	2483.5 - 2500	17.7 - 21.4
8.37625 - 8.38675	156.7 - 156.9	2690 - 2900	22.01 - 23.12
8.41425 - 8.41475	162.0125 - 167.17	3260 - 3267	23.6 - 24.0
12.29 - 12.293	167.72 - 173.2	3332 - 3339	31.2 - 31.8
12.51975 - 12.52025	240 - 285	3345.8 - 3358	36.43 - 36.5
12.57675 - 12.57725	322 - 335.4	3600 - 4400	(²)
13.36 - 13.41			

Limit in restricted band

Frequency of emission (MHz)	Field strength(uV/m)	Field strength(dBuV/m)
30-88	100	40
88-216	150	43.5
216-960	200	46
Above960	500	54

§15.35(b)

There is also a limit on the radio frequency emissions, as measured using instrumentation with a peak detector function, corresponding to 20 dB above the maximum permitted average limit.

Peak Limit=74 dBuV/m

Average Limit=54 dBuV/m

Measurement Uncertainty

The assessed measurement uncertainty to ensure 95% confidence level for the normal distribution is with the coverage factor $k = 1.96$, $U = 3.55$ dB.

Test Results

Band	T _{on} (ms)	T _(on+off) (ms)	Duty cycle	Duty cycle correction Factor(dB)
802.11b	12.21	12.29	0.99	N/A
802.11g	2.02	2.10	0.96	0.17
802.11n HT20	4.96	5.04	0.98	N/A
802.11n HT40	2.41	2.49	0.97	0.14
BLE	0.41	0.62	0.660	1.803

Note: when Duty cycle>0.98, Duty cycle correction Factor not required.

802.11b-Channel 1: Peak

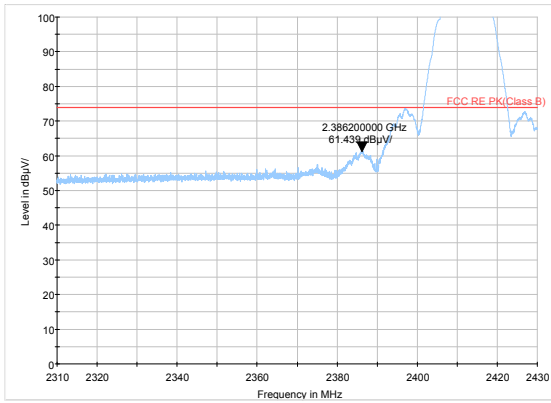

802.11b-Channel 11: Peak

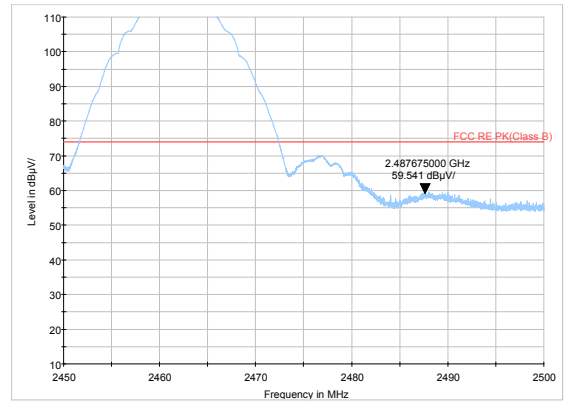

802.11b-Channel 1: Average

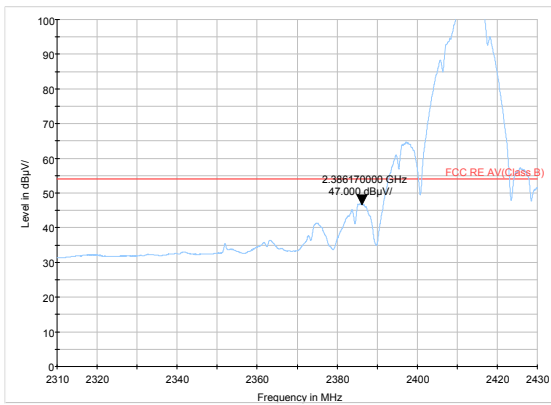

802.11b-Channel 11: Average

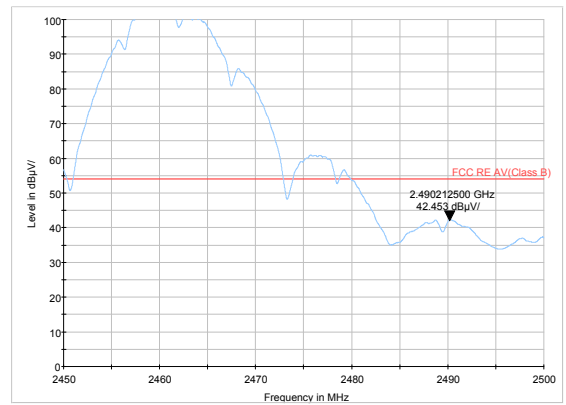

802.11g-Channel 1: Peak

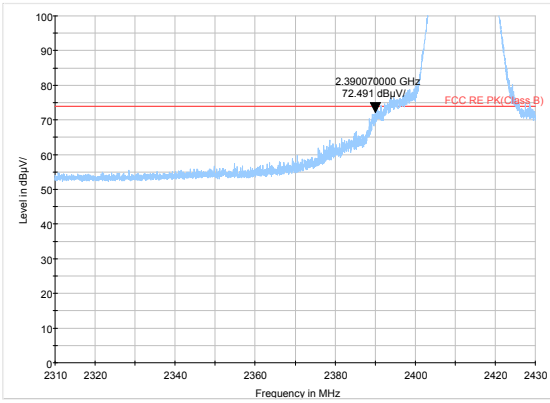

802.11g-Channel 11: Peak

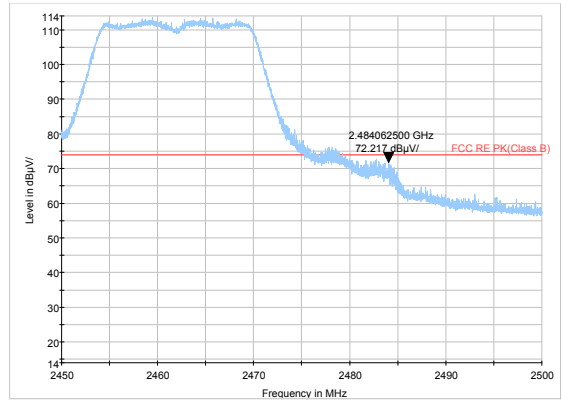

802.11g-Channel 1: Average

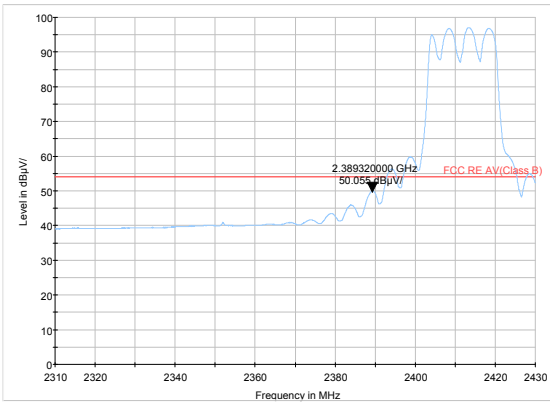

802.11g-Channel 11: Average

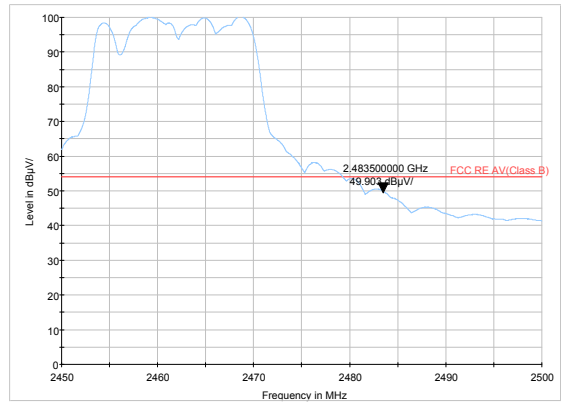

802.11n HT20 -Channel 1: Peak

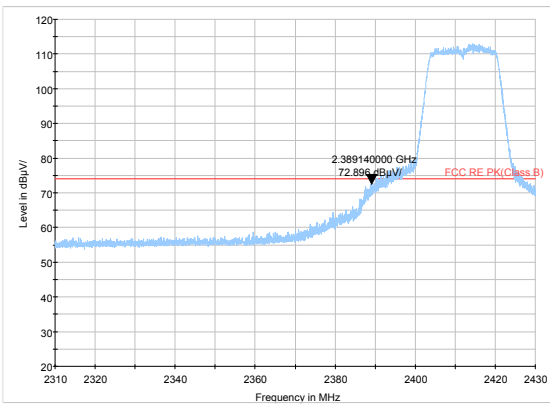

802.11n HT20-Channel 11: Peak

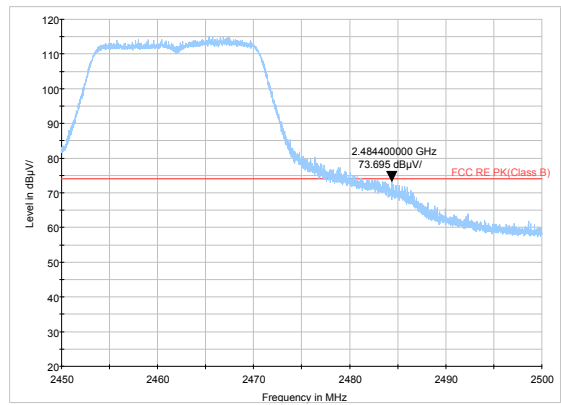

802.11n HT20-Channel 1: Average

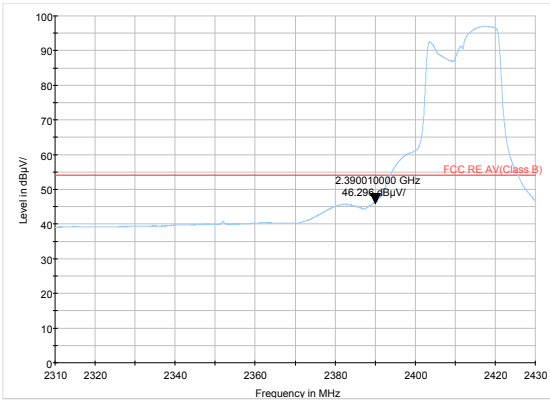

802.11n HT20-Channel 11: Average

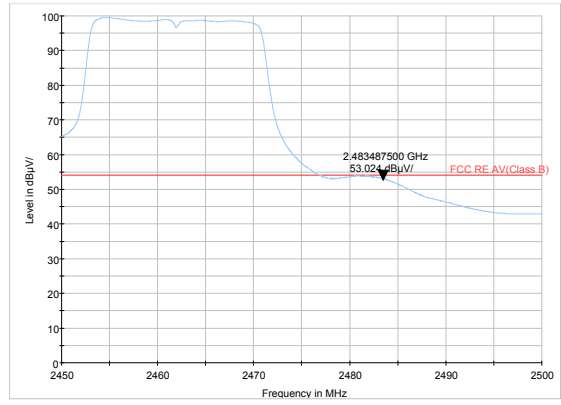

802.11n HT40 -Channel 3: Peak

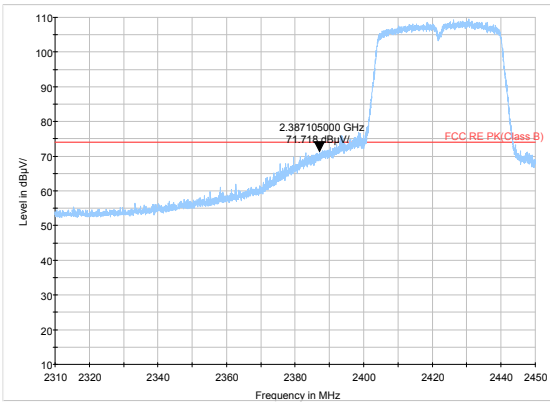

802.11n HT40 -Channel 9: Peak

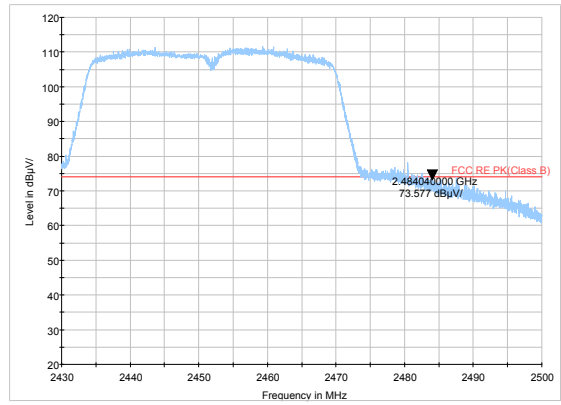

802.11n HT40-Channel 3: Average

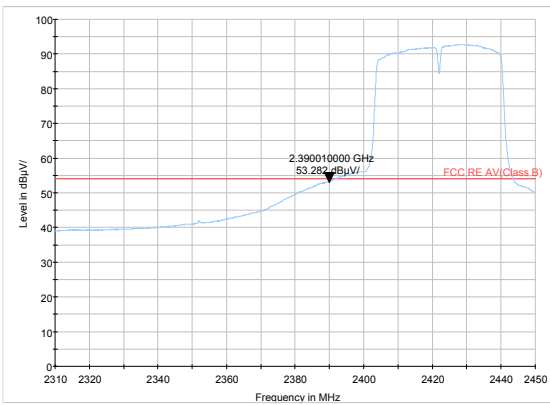

802.11n HT40-Channel 9: Average

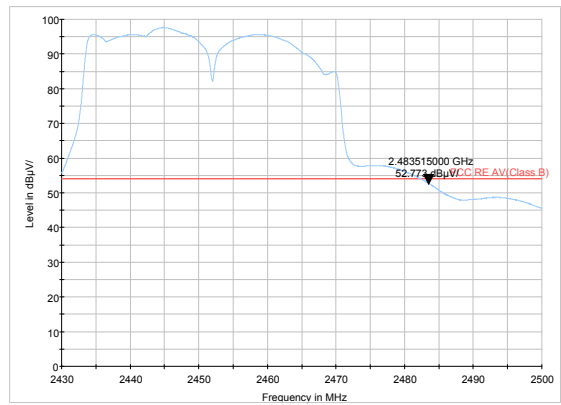

BLE -Channel 0: Peak

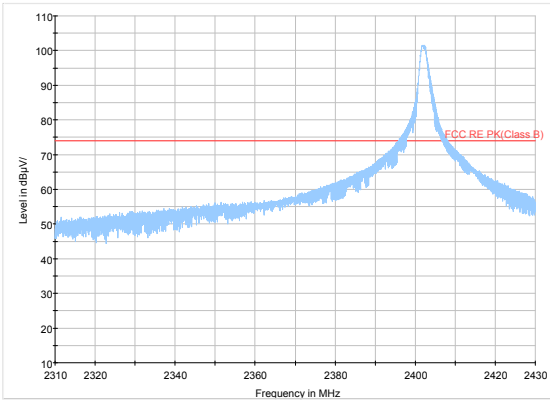

BLE -Channel 38: Peak

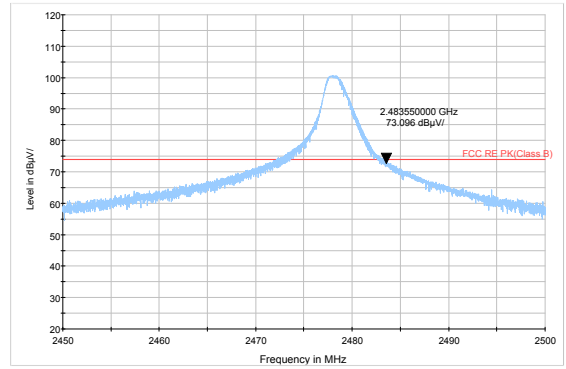

BLE -Channel 0: Average

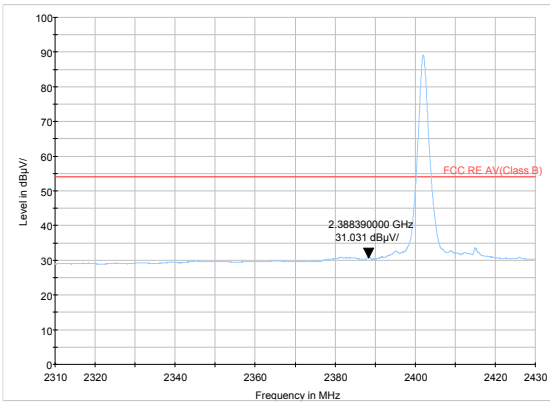

BLE -Channel 38: Average

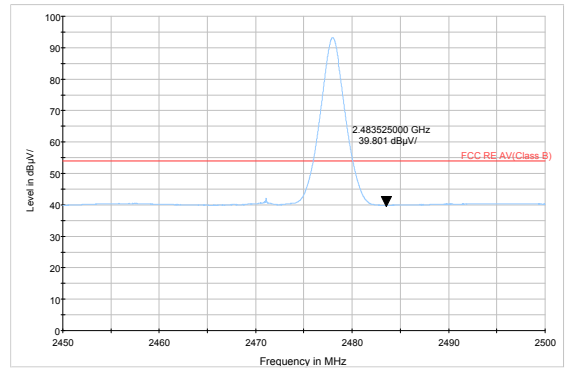

5.7. Radiates Emission

Ambient condition

Temperature	Relative humidity	Pressure
23°C ~25°C	45%~50%	102.5kPa

Method of Measurement

The test set-up was made in accordance to the general provisions of ANSI C63.10-2013. The Equipment Under Test (EUT) was set up on a non-conductive table in the semi-anechoic chamber. The test was performed at the distance of 3 m between the EUT and the receiving antenna. The radiated emissions measurements were made in a typical installation configuration.

Sweep the whole frequency band through the range from 9 kHz to the 10th harmonic of the carrier, and the emissions less than 20 dB below the permissible value are reported.

During the test, below 30MHz, the center of the loop shall be 1 meters; above 30MHz, the height of receive antenna shall be moved from 1 to 4 meters, and the antenna shall be performed under horizontal and vertical polarization. The turntable shall be rotated from 0 to 360 degrees for detecting the maximum of radiated spurious signal level. The measurements shall be repeated with orthogonal polarization of the test antenna. The data of cable loss and antenna factor has been calibrated in full testing frequency range before the testing.

Set the spectrum analyzer in the following:

Below 1GHz (detector: Peak and Quasi-Peak)

RBW=100 kHz / VBW=300 kHz / Sweep=AUTO

Above 1GHz (detector: Peak):

(a) PEAK: RBW=1MHz / VBW=3MHz/ Sweep=AUTO

(b) AVERAGE: RBW=1MHz / VBW=10Hz, when duty cycle is not less than 98%

VBW \geq 1/T when duty cycle is less than 98%, where T is transmit on time

Sweep=AUTO

The radiated emission was measured in the following position: EUT stand-up position (Z axis), lie-down position (X, Y axis). The worst emission was found in lie-down position (X axis) and the worst case was recorded.

The test is in transmitting mode.

Test setup

9KHz ~ 30MHz

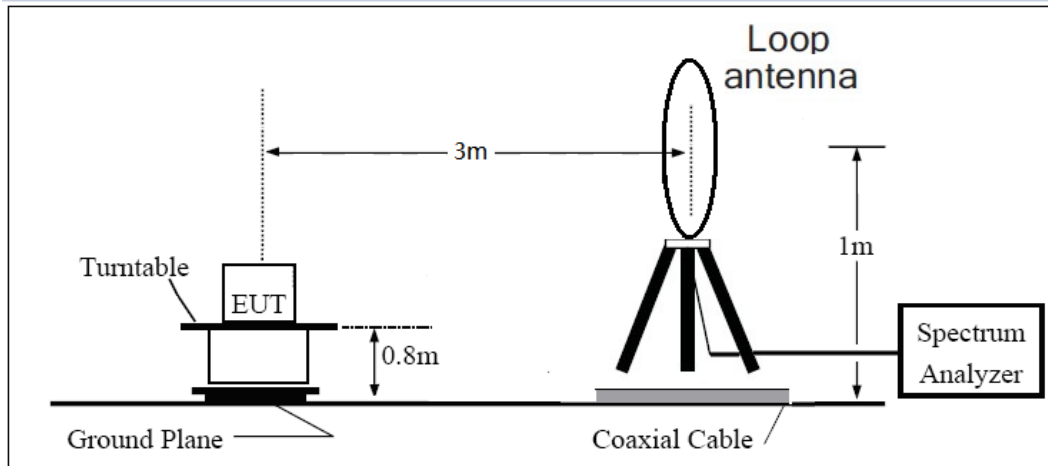

30MHz ~ 1GHz

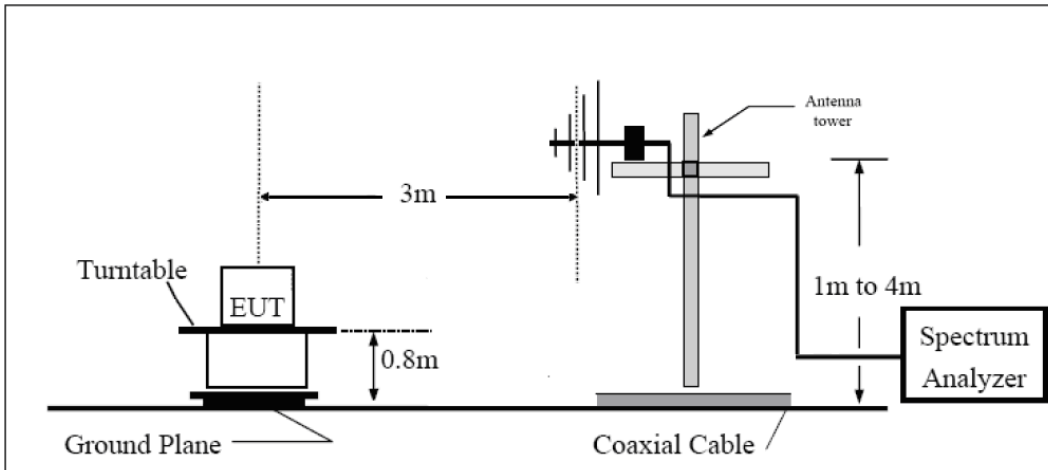

Above 1GHz

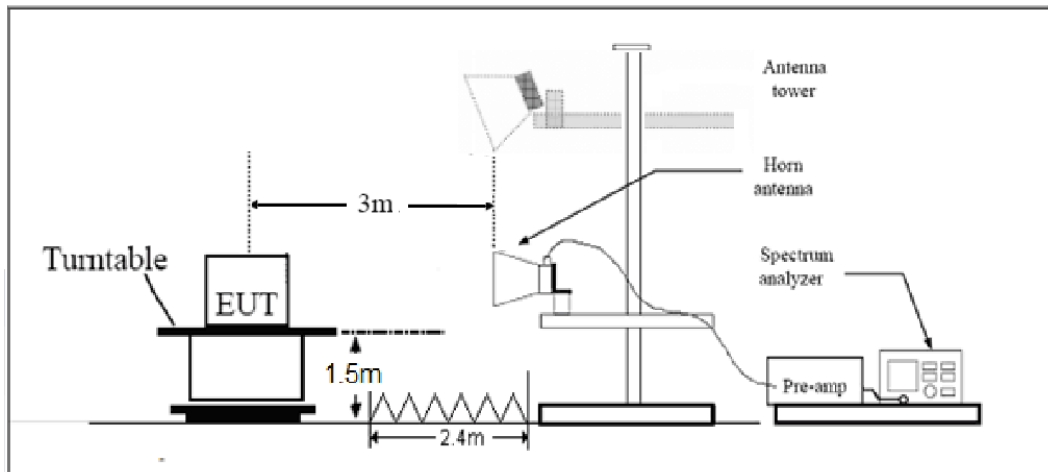

Note: Area side:2.4mX3.6m

Limits

Rule Part 15.247(d) specifies that “In addition, radiated emissions which fall in the restricted bands, as defined in § 15.205(a), must also comply with the radiated emission limits specified in § 15.209(a) (see § 15.205(c)).”

Limit in restricted band

Frequency of emission (MHz)	Field strength(uV/m)	Field strength(dBuV/m)
0.009–0.490	2400/F(kHz)	/
0.490–1.705	24000/F(kHz)	/
1.705–30.0	30	/
30-88	100	40
88-216	150	43.5
216-960	200	46
Above960	500	54

§15.35(b)

There is also a limit on the radio frequency emissions, as measured using instrumentation with a peak detector function, corresponding to 20 dB above the maximum permitted average limit.

Measurement Uncertainty

The assessed measurement uncertainty to ensure 95% confidence level for the normal distribution is with the coverage factor $k = 1.96$.

Frequency	Uncertainty
9KHz-30MHz	3.55 dB
30MHz-200MHz	4.19 dB
200MHz-1GHz	3.63 dB
Above 1GHz	3.68 dB

Test result

Sweep the whole frequency band through the range from 9kHz to the 10th harmonic of the carrier, 9KHz-30MHz, 18GHz-26.5 GHz and the emissions more than 20 dB below the permissible value are not reported.

The following graphs display the maximum values of horizontal and vertical by software. For above 1GHz, Blue trace uses the peak detection, Green trace uses the average detection.

After the pre test, Antenna 1 was selected as the worst antenna.

During the test, the Radiates Emission from 30MHz to 1GHz was performed in all modes with all channels, 802.11b, Channel 6 are selected as the worst condition. The test data of the worst-case condition was recorded in this report.

Continuous TX mode:

FCC RE 0.03-1GHz QP Class B

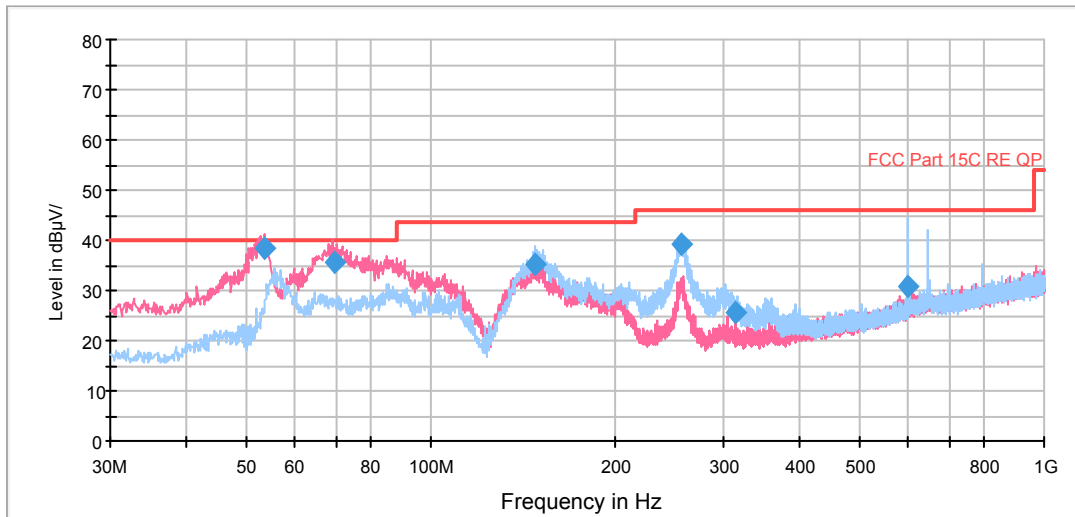

Radiates Emission from 30MHz to 1GHz

Frequency (MHz)	Quasi-Peak (dBuV/m)	Reading value (dBuV/m)	Height (cm)	Polarization	Azimuth (deg)	Correct Factor (dB)	Margin (dB)	Limit (dBuV/m)
53.722500	38.6	25.8	100.0	V	254.0	12.8	1.4	40.0
69.685000	35.4	26.7	100.0	V	253.0	8.7	4.6	40.0
148.172500	35.1	26.0	216.0	H	26.0	9.1	8.4	43.5
256.207500	39.2	24.6	100.0	H	0.0	14.6	6.8	46.0
314.982500	25.8	9.7	100.0	H	10.0	16.1	20.2	46.0
599.996250	30.9	8.0	125.0	H	306.0	22.9	15.1	46.0

- Remark: 1. Quasi-Peak = Reading value + Correction factor
- 2. Correction Factor = Antenna factor+ Insertion loss(cable loss+amplifier gain)
- 3. Margin = Limit – Quasi-Peak

802.11b CH1

RE 1G-3GHz PK+AV

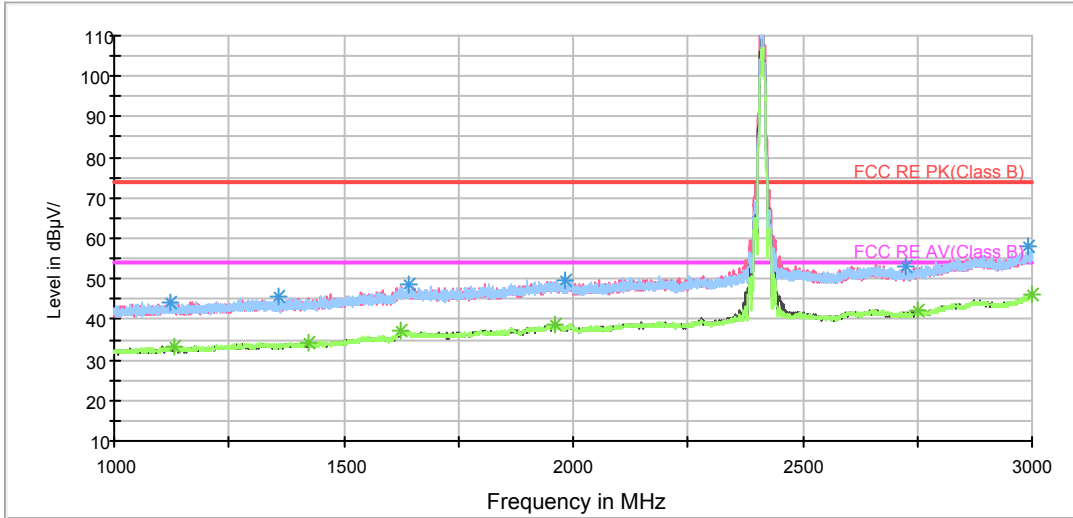

Note: The signal beyond the limit is carrier.
Radiates Emission from 1GHz to 3GHz

RE 3-18GHz PK+AV

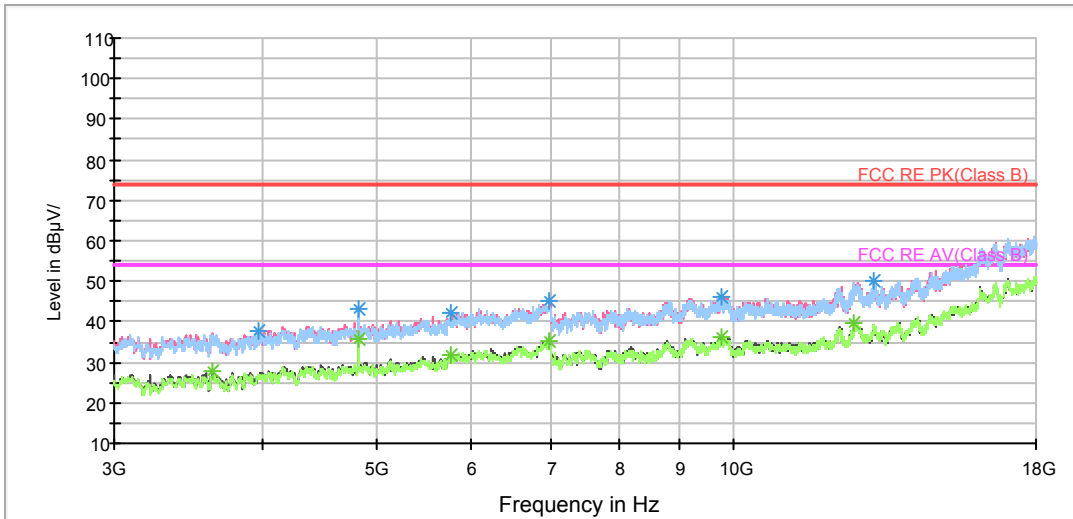

Radiates Emission from 3GHz to 18GHz



Frequency (MHz)	Peak (dBuV/m)	Height (cm)	Polarization	Azimuth (deg)	Reading value (dBuV/m)	Correct Factor (dB)	Margin (dB)	Limit (dBuV/m)
1123.000000	44.2	200.0	H	0.0	52.7	-8.5	29.8	74
1356.000000	45.8	200.0	V	347.0	53.3	-7.5	28.2	74
1641.250000	48.4	200.0	V	354.0	53.1	-4.7	25.6	74
1983.000000	49.7	200.0	H	104.0	53.5	-3.8	24.3	74
2724.750000	53.3	200.0	V	347.0	52.9	0.4	20.7	74
2991.000000	58.1	200.0	H	27.0	55.9	2.2	15.9	74

Remark: 1. Correction Factor = Antenna factor+ Insertion loss (cable loss + amplifier gain)

Frequency (MHz)	Average (dBuV/m)	Height (cm)	Polarization	Azimuth (deg)	Reading value (dBuV/m)	Correct Factor (dB)	Margin (dB)	Limit (dBuV/m)
1129.750000	33.4	200.0	V	126.0	41.7	-8.3	20.6	54
1422.500000	34.2	200.0	V	354.0	41.1	-6.9	19.8	54
1623.750000	37.1	200.0	H	33.0	41.9	-4.8	16.9	54
1961.000000	38.8	200.0	H	127.0	42.0	-3.2	15.2	54
2752.250000	42.2	200.0	H	98.0	41.3	0.9	11.8	54
2999.250000	46.0	200.0	H	127.0	43.7	2.3	8.0	54

Remark: 1. Correction Factor = Antenna factor+ Insertion loss (cable loss + amplifier gain)

802.11b CH6

RE 1G-3GHz PK+AV

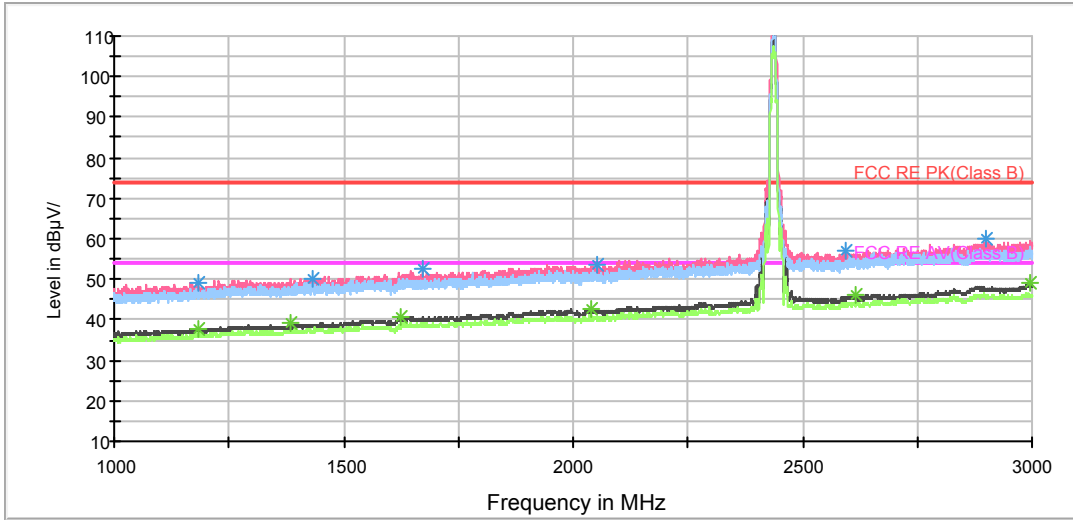

Note: The signal beyond the limit is carrier.
Radiates Emission from 1GHz to 3GHz

RE 3-18GHz PK+AV

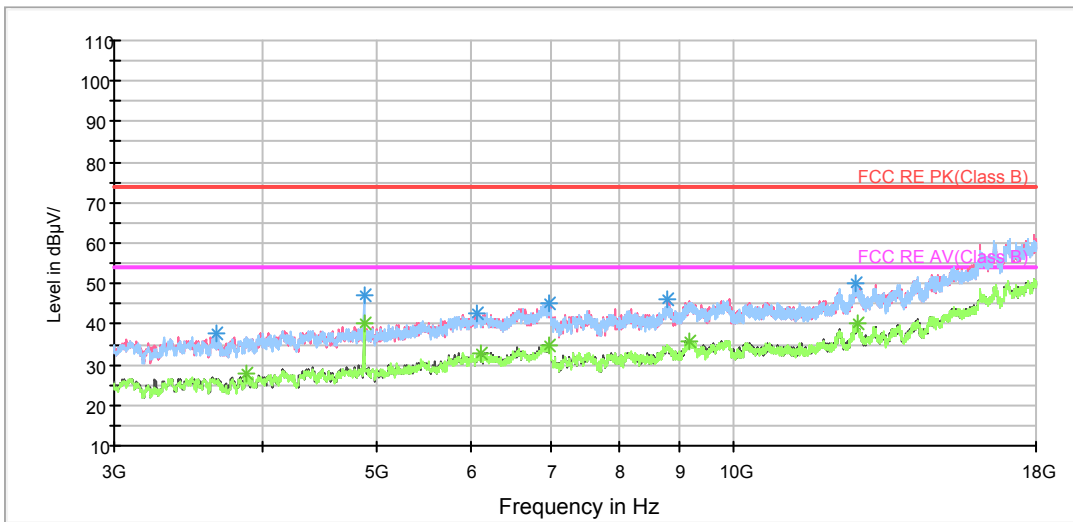

Radiates Emission from 3GHz to 18GHz



Frequency (MHz)	Peak (dBuV/m)	Height (cm)	Polarization	Azimuth (deg)	Reading value (dBuV/m)	Correct Factor (dB)	Margin (dB)	Limit (dBuV/m)
1181.250000	49.0	200.0	V	126.0	47.0	2.0	25.0	74
1434.250000	50.3	200.0	V	278.0	47.2	3.1	23.7	74
1671.000000	52.4	200.0	V	346.0	47.5	4.9	21.6	74
2054.500000	53.7	200.0	V	289.0	46.9	6.8	20.3	74
2594.250000	56.9	200.0	V	306.0	46.7	10.2	17.1	74
2899.750000	60.1	200.0	V	184.0	48.0	12.1	13.9	74

Remark: 1. Correction Factor = Antenna factor+ Insertion loss (cable loss + amplifier gain)

Frequency (MHz)	Average (dBuV/m)	Height (cm)	Polarization	Azimuth (deg)	Reading value (dBuV/m)	Correct Factor (dB)	Margin (dB)	Limit (dBuV/m)
1181.500000	37.7	200.0	V	225.0	35.7	2.0	16.3	54
1385.000000	39.1	200.0	V	289.0	36.1	3.0	14.9	54
1626.500000	40.9	200.0	V	149.0	35.7	5.2	13.1	54
2041.000000	42.8	200.0	V	231.0	36.0	6.8	11.2	54
2616.500000	46.0	200.0	V	62.0	36.0	10.0	8.0	54
2993.750000	49.0	200.0	V	0.0	36.8	12.2	5.0	54

Remark: 1. Correction Factor = Antenna factor+ Insertion loss (cable loss + amplifier gain)

802.11b CH11

RE 1G-3GHz PK+AV

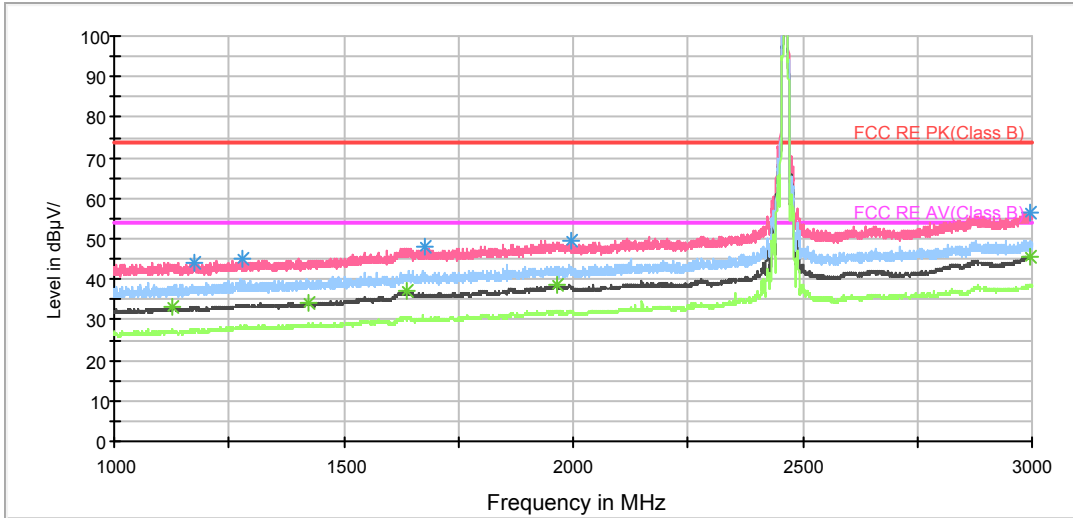

Note: The signal beyond the limit is carrier.
Radiates Emission from 1GHz to 3GHz

RE 3-18GHz PK+AV

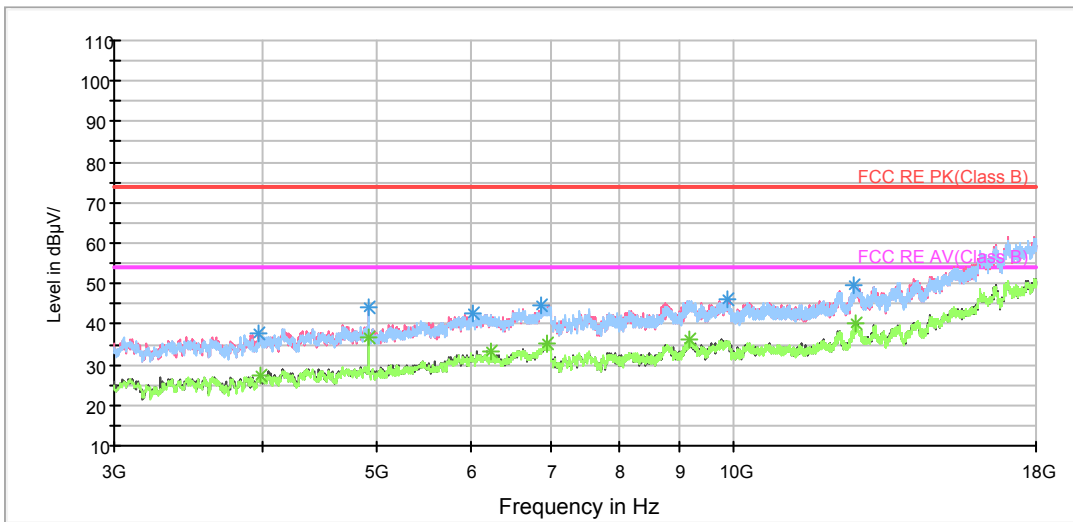

Radiates Emission from 3GHz to 18GHz



Frequency (MHz)	Peak (dBuV/m)	Height (cm)	Polarization	Azimuth (deg)	Reading value (dBuV/m)	Correct Factor (dB)	Margin (dB)	Limit (dBuV/m)
1174.750000	44.2	200.0	V	196.0	52.2	-8.0	29.8	74
1278.000000	45.2	200.0	V	249.0	52.8	-7.6	28.8	74
1677.500000	47.9	200.0	V	0.0	53.0	-5.1	26.1	74
1997.000000	49.4	200.0	V	104.0	52.7	-3.3	24.6	74
2997.750000	56.4	200.0	V	261.0	54.1	2.3	17.6	74

Remark: 1. Correction Factor = Antenna factor+ Insertion loss (cable loss + amplifier gain)

Frequency (MHz)	Average (dBuV/m)	Height (cm)	Polarization	Azimuth (deg)	Reading value (dBuV/m)	Correct Factor (dB)	Margin (dB)	Limit (dBuV/m)
1124.500000	33.3	200.0	V	278.0	41.8	-8.5	20.7	54
1425.750000	34.2	200.0	V	0.0	41.1	-6.9	19.8	54
1639.250000	37.0	200.0	V	347.0	41.7	-4.7	17.0	54
1965.500000	38.5	200.0	V	196.0	41.9	-3.4	15.5	54
2995.750000	45.7	200.0	V	249.0	43.4	2.3	8.3	54

Remark: 1. Correction Factor = Antenna factor+ Insertion loss (cable loss + amplifier gain)

802.11g CH1

RE 1G-3GHz PK+AV

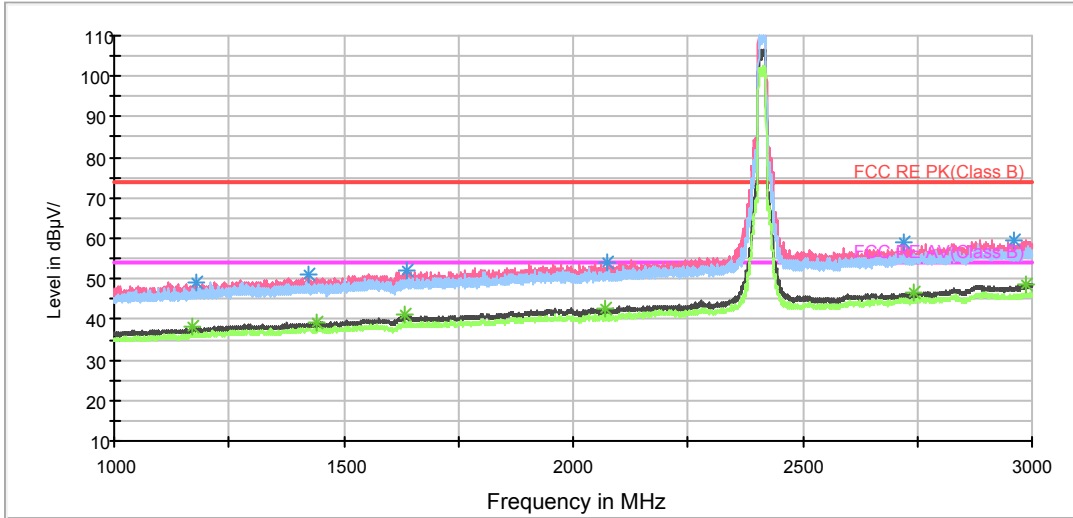

Note: The signal beyond the limit is carrier.
Radiates Emission from 1GHz to 3GHz

RE 3-18GHz PK+AV

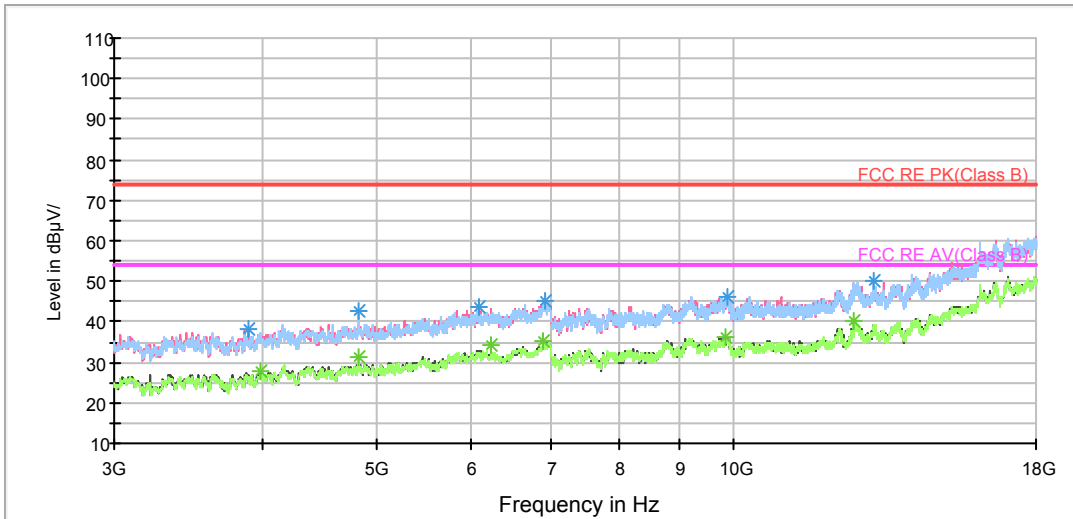

Radiates Emission from 3GHz to 18GHz



Frequency (MHz)	Peak (dBuV/m)	Height (cm)	Polarization	Azimuth (deg)	Reading value (dBuV/m)	Correct Factor (dB)	Margin (dB)	Limit (dBuV/m)
1177.500000	48.9	200.0	V	279.0	46.9	2.0	25.1	74
1423.250000	51.2	200.0	V	0.0	48.1	3.1	22.8	74
1635.500000	52.2	200.0	V	359.0	46.9	5.3	21.8	74
2075.500000	53.8	200.0	V	302.0	46.9	6.9	20.2	74
2721.500000	58.8	200.0	V	291.0	48.5	10.3	15.2	74
2962.250000	59.4	200.0	V	359.0	47.3	12.1	14.6	74

Remark: 1. Correction Factor = Antenna factor+ Insertion loss (cable loss + amplifier gain)

Frequency (MHz)	Average (dBuV/m)	Height (cm)	Polarization	Azimuth (deg)	Reading value (dBuV/m)	Correct Factor (dB)	Margin (dB)	Limit (dBuV/m)
1168.250000	38.1	200.0	V	348.0	36.2	1.9	15.9	54
1441.500000	39.0	200.0	V	336.0	35.9	3.1	15.0	54
1634.250000	41.1	200.0	V	291.0	35.8	5.3	12.9	54
2068.250000	42.6	200.0	V	324.0	35.7	6.9	11.4	54
2743.250000	46.4	200.0	V	250.0	35.6	10.8	7.6	54
2987.500000	48.8	200.0	V	186.0	36.6	12.2	5.2	54

Remark: 1. Correction Factor = Antenna factor+ Insertion loss (cable loss + amplifier gain)

802.11g CH6

RE 1G-3GHz PK+AV

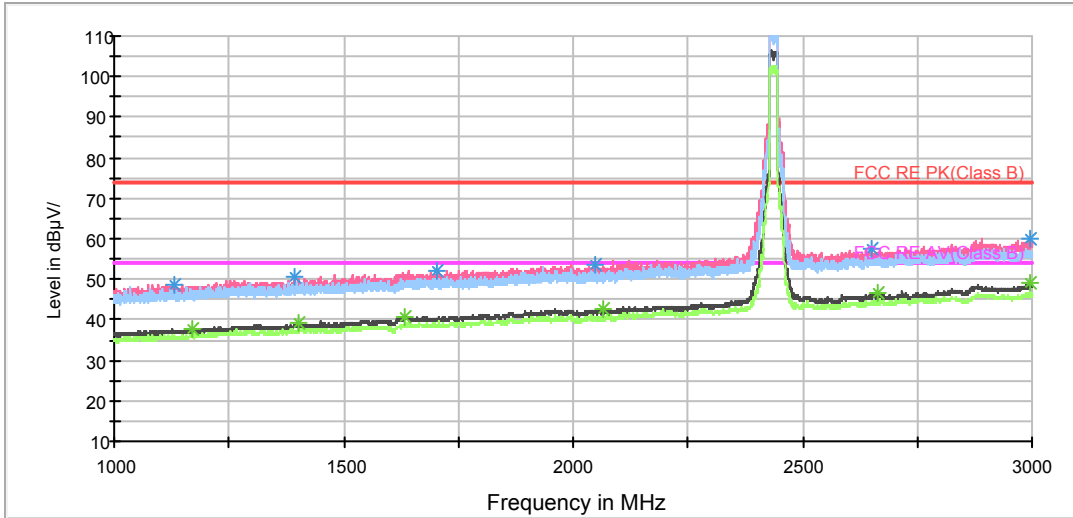

Note: The signal beyond the limit is carrier.
Radiates Emission from 1GHz to 3GHz

RE 3-18GHz PK+AV

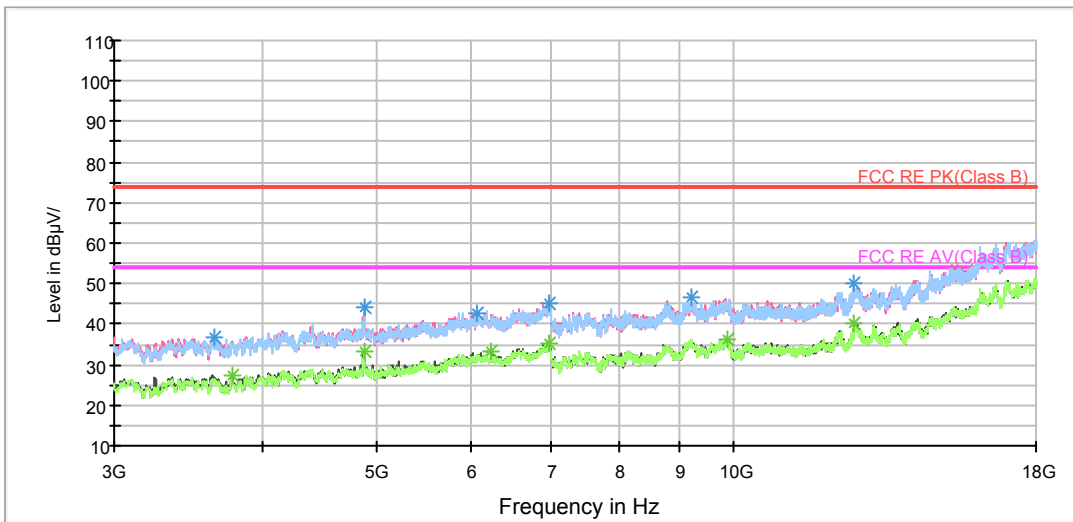

Radiates Emission from 3GHz to 18GHz



Frequency (MHz)	Peak (dBuV/m)	Height (cm)	Polarization	Azimuth (deg)	Reading value (dBuV/m)	Correct Factor (dB)	Margin (dB)	Limit (dBuV/m)
1129.500000	48.7	200.0	V	320.0	47.1	1.6	25.3	74
1395.000000	50.6	200.0	V	273.0	47.7	2.9	23.4	74
1702.750000	52.2	200.0	V	0.0	47.1	5.1	21.8	74
2049.000000	53.3	200.0	V	285.0	46.5	6.8	20.7	74
2652.250000	57.7	200.0	V	238.0	47.3	10.4	16.3	74
2995.000000	60.2	200.0	V	291.0	47.9	12.3	13.8	74

Remark: 1. Correction Factor = Antenna factor+ Insertion loss (cable loss + amplifier gain)

Frequency (MHz)	Average (dBuV/m)	Height (cm)	Polarization	Azimuth (deg)	Reading value (dBuV/m)	Correct Factor (dB)	Margin (dB)	Limit (dBuV/m)
1169.250000	37.7	200.0	V	180.0	35.8	1.9	16.3	54
1400.250000	39.1	200.0	V	226.0	36.2	2.9	14.9	54
1634.500000	40.7	200.0	V	291.0	35.4	5.3	13.3	54
2067.000000	42.6	200.0	V	291.0	35.7	6.9	11.4	54
2662.250000	46.7	200.0	V	0.0	36.4	10.3	7.3	54
2995.750000	48.9	200.0	V	221.0	36.6	12.3	5.1	54

Remark: 1. Correction Factor = Antenna factor+ Insertion loss (cable loss + amplifier gain)

802.11g CH11

RE 1G-3GHz PK+AV

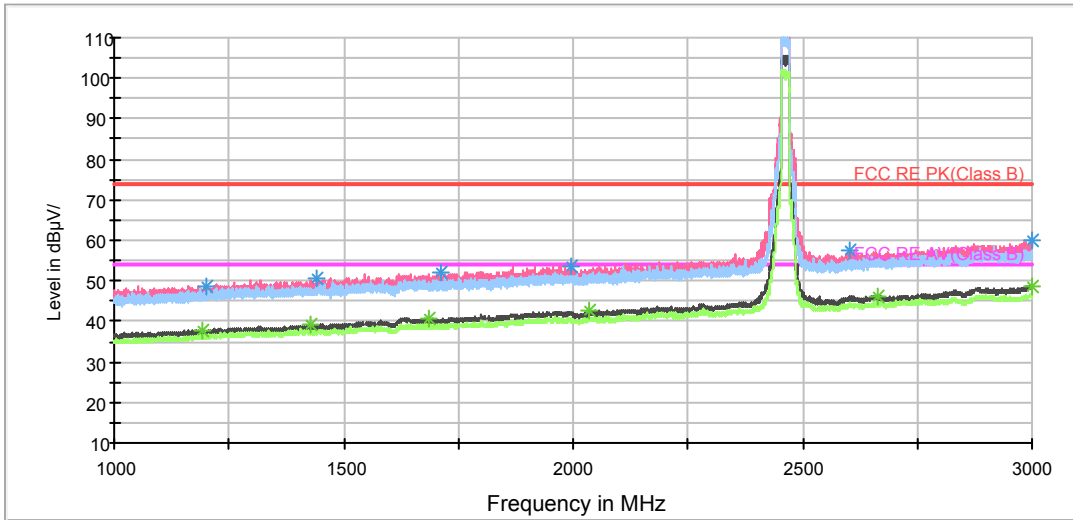

Note: The signal beyond the limit is carrier.
Radiates Emission from 1GHz to 3GHz

RE 3-18GHz PK+AV

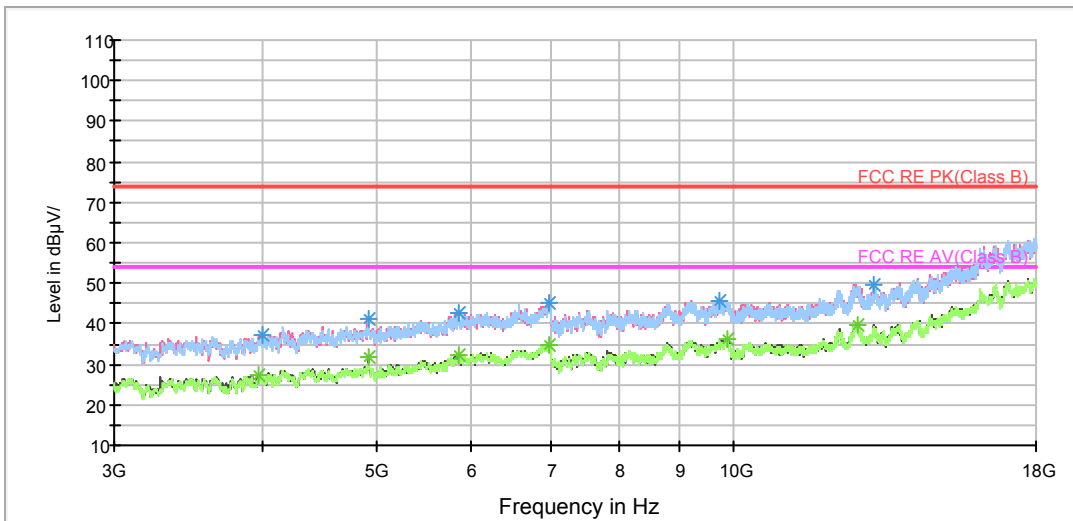

Radiates Emission from 3GHz to 18GHz



Frequency (MHz)	Peak (dBuV/m)	Height (cm)	Polarization	Azimuth (deg)	Reading value (dBuV/m)	Correct Factor (dB)	Margin (dB)	Limit (dBuV/m)
1198.750000	48.8	200.0	V	0.0	47.0	1.8	25.2	74
1439.500000	50.5	200.0	V	322.0	47.4	3.1	23.5	74
1710.250000	52.0	200.0	V	0.0	46.8	5.2	22.0	74
1994.500000	53.7	200.0	V	0.0	46.9	6.8	20.3	74
2603.000000	57.4	200.0	V	184.0	47.1	10.3	16.6	74
2998.500000	60.0	200.0	V	304.0	47.7	12.3	14.0	74

Remark: 1. Correction Factor = Antenna factor+ Insertion loss (cable loss + amplifier gain)

Frequency (MHz)	Average (dBuV/m)	Height (cm)	Polarization	Azimuth (deg)	Reading value (dBuV/m)	Correct Factor (dB)	Margin (dB)	Limit (dBuV/m)
1193.500000	37.7	200.0	V	214.0	35.9	1.8	16.3	54
1426.000000	39.1	200.0	V	345.0	36.0	3.1	14.9	54
1686.250000	40.9	200.0	V	264.0	35.9	5.0	13.1	54
2033.750000	42.6	200.0	V	252.0	35.9	6.7	11.4	54
2662.250000	46.2	200.0	V	244.0	35.9	10.3	7.8	54
2998.750000	48.8	200.0	V	0.0	36.5	12.3	5.2	54

Remark: 1. Correction Factor = Antenna factor+ Insertion loss (cable loss + amplifier gain)

802.11n (HT20) CH1

RE 1G-3GHz PK+AV

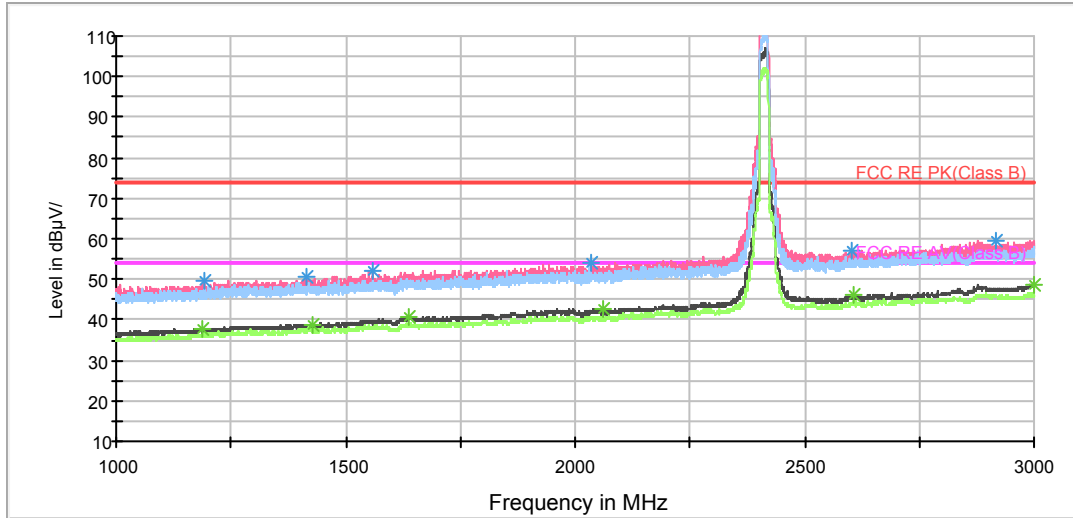

Note: The signal beyond the limit is carrier.
Radiates Emission from 1GHz to 3GHz

RE 3-18GHz PK+AV

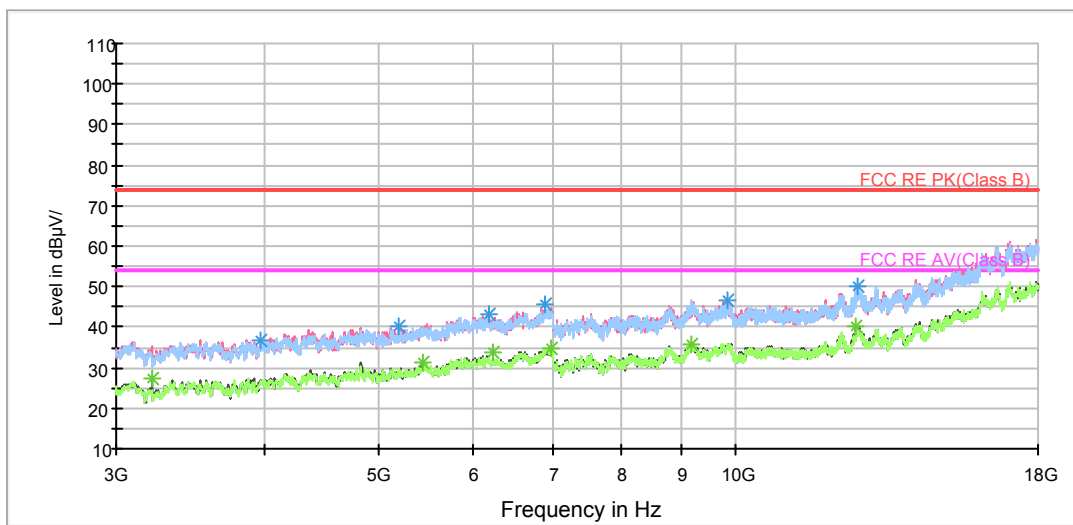

Radiates Emission from 3GHz to 18GHz



Frequency (MHz)	Peak (dBuV/m)	Height (cm)	Polarization	Azimuth (deg)	Reading value (dBuV/m)	Correct Factor (dB)	Margin (dB)	Limit (dBuV/m)
1191.000000	49.5	200.0	V	0.0	47.7	1.8	24.5	74
1413.500000	50.4	200.0	V	250.0	47.4	3.0	23.6	74
1558.750000	52.3	200.0	V	275.0	48.9	3.4	21.7	74
2033.250000	54.0	200.0	V	264.0	47.3	6.7	20.0	74
2603.250000	57.1	200.0	V	186.0	46.8	10.3	16.9	74
2917.000000	59.7	200.0	V	269.0	47.9	11.8	14.3	74

Remark: 1. Correction Factor = Antenna factor+ Insertion loss (cable loss + amplifier gain)

Frequency (MHz)	Average (dBuV/m)	Height (cm)	Polarization	Azimuth (deg)	Reading value (dBuV/m)	Correct Factor (dB)	Margin (dB)	Limit (dBuV/m)
1189.750000	37.9	200.0	V	150.0	36.1	1.8	16.1	54
1426.250000	38.9	200.0	V	0.0	35.8	3.1	15.1	54
1636.250000	40.9	200.0	V	314.0	35.6	5.3	13.1	54
2062.250000	42.6	200.0	V	331.0	35.7	6.9	11.4	54
2608.750000	45.9	200.0	V	0.0	35.7	10.2	8.1	54
2998.250000	48.6	200.0	V	157.0	36.3	12.3	5.4	54

Remark: 1. Correction Factor = Antenna factor+ Insertion loss (cable loss + amplifier gain)

802.11n (HT20) CH6

RE 1G-3GHz PK+AV

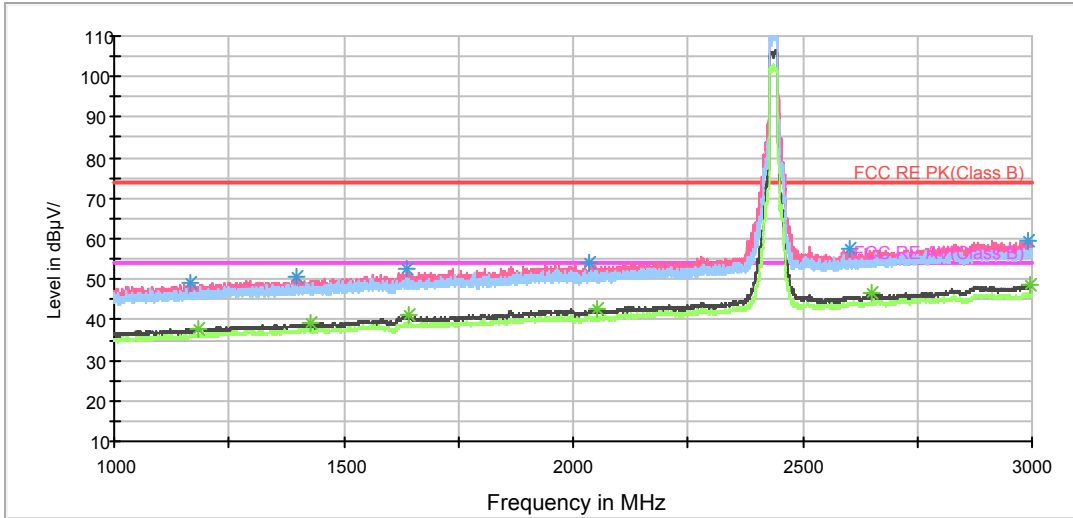

Note: The signal beyond the limit is carrier.
Radiates Emission from 1GHz to 3GHz

RE 3-18GHz PK+AV

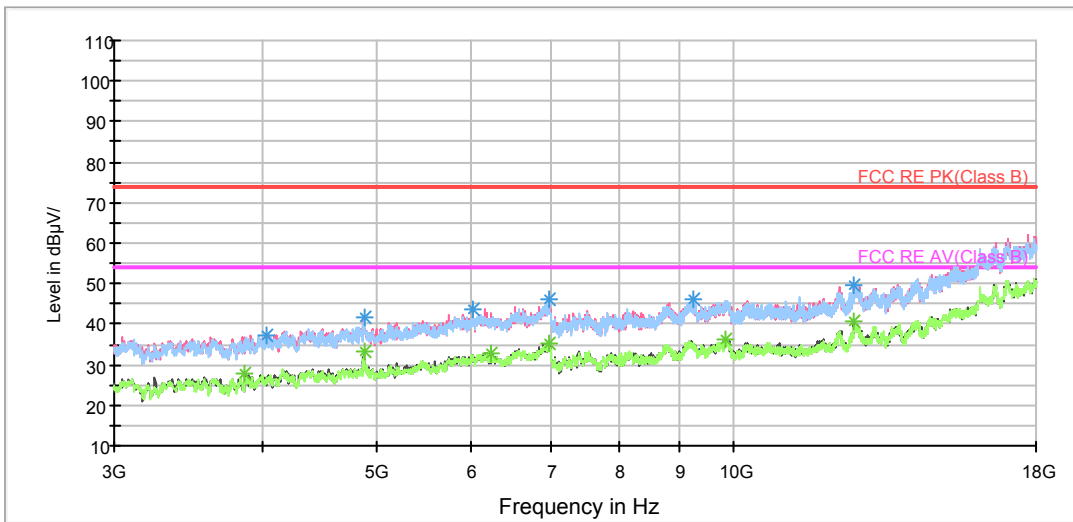

Radiates Emission from 3GHz to 18GHz



Frequency (MHz)	Peak (dBuV/m)	Height (cm)	Polarization	Azimuth (deg)	Reading value (dBuV/m)	Correct Factor (dB)	Margin (dB)	Limit (dBuV/m)
1167.750000	48.9	200.0	V	0.0	47.1	1.8	25.1	74
1397.750000	50.6	200.0	V	144.0	47.7	2.9	23.4	74
1638.250000	52.4	200.0	V	304.0	47.1	5.3	21.6	74
2035.500000	54.2	200.0	V	345.0	47.5	6.7	19.8	74
2602.250000	57.6	200.0	V	243.0	47.2	10.4	16.4	74
2992.500000	59.5	200.0	V	298.0	47.3	12.2	14.5	74

Remark: 1. Correction Factor = Antenna factor+ Insertion loss (cable loss + amplifier gain)

Frequency (MHz)	Average (dBuV/m)	Height (cm)	Polarization	Azimuth (deg)	Reading value (dBuV/m)	Correct Factor (dB)	Margin (dB)	Limit (dBuV/m)
1183.750000	37.7	200.0	V	327.0	35.8	1.9	16.3	54
1426.000000	39.1	200.0	V	0.0	36.0	3.1	14.9	54
1640.250000	41.0	200.0	V	258.0	35.7	5.3	13.0	54
2054.000000	42.5	200.0	V	97.0	35.7	6.8	11.5	54
2650.750000	46.4	200.0	V	345.0	36.0	10.4	7.6	54
2994.750000	48.8	200.0	V	339.0	36.5	12.3	5.2	54

Remark: 1. Correction Factor = Antenna factor+ Insertion loss (cable loss + amplifier gain)

802.11n (HT20) CH11

RE 1G-3GHz PK+AV

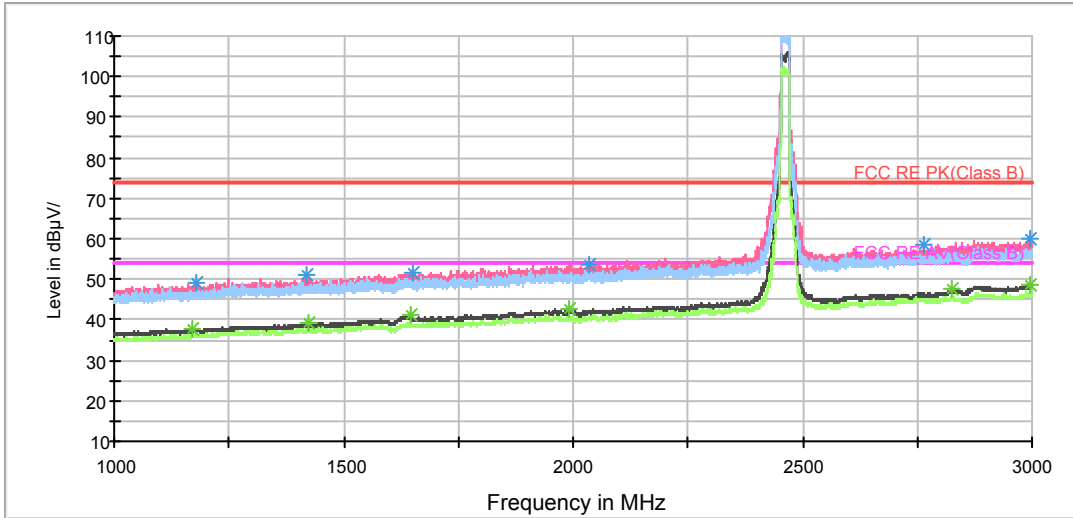

Note: The signal beyond the limit is carrier.
Radiates Emission from 1GHz to 3GHz

RE 3-18GHz PK+AV

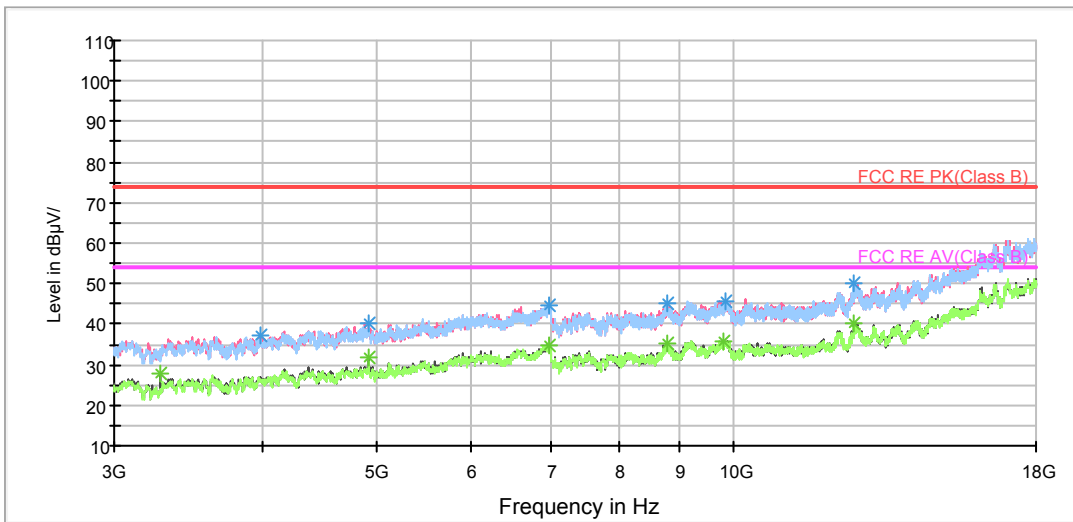

Radiates Emission from 3GHz to 18GHz



Frequency (MHz)	Peak (dBuV/m)	Height (cm)	Polarization	Azimuth (deg)	Reading value (dBuV/m)	Correct Factor (dB)	Margin (dB)	Limit (dBuV/m)
1180.000000	49.0	200.0	V	109.0	47.0	2.0	25.0	74
1420.000000	51.0	200.0	V	0.0	47.9	3.1	23.0	74
1651.500000	51.7	200.0	V	0.0	46.8	4.9	22.3	74
2036.250000	53.7	200.0	V	0.0	47.0	6.7	20.3	74
2764.500000	58.4	200.0	V	271.0	47.6	10.8	15.6	74
2995.500000	59.8	200.0	V	159.0	47.5	12.3	14.2	74

Remark: 1. Correction Factor = Antenna factor+ Insertion loss (cable loss + amplifier gain)

Frequency (MHz)	Average (dBuV/m)	Height (cm)	Polarization	Azimuth (deg)	Reading value (dBuV/m)	Correct Factor (dB)	Margin (dB)	Limit (dBuV/m)
1169.500000	37.7	200.0	V	0.0	35.8	1.9	16.3	54
1425.250000	39.1	200.0	V	140.0	36.0	3.1	14.9	54
1646.000000	41.0	200.0	V	259.0	35.9	5.1	13.0	54
1992.750000	42.5	200.0	V	188.0	35.8	6.7	11.5	54
2827.500000	47.9	200.0	V	294.0	36.3	11.6	6.1	54
2993.750000	48.7	200.0	V	324.0	36.5	12.2	5.3	54

Remark: 1. Correction Factor = Antenna factor+ Insertion loss (cable loss + amplifier gain)

802.11n (HT40) CH3

RE 1G-3GHz PK+AV

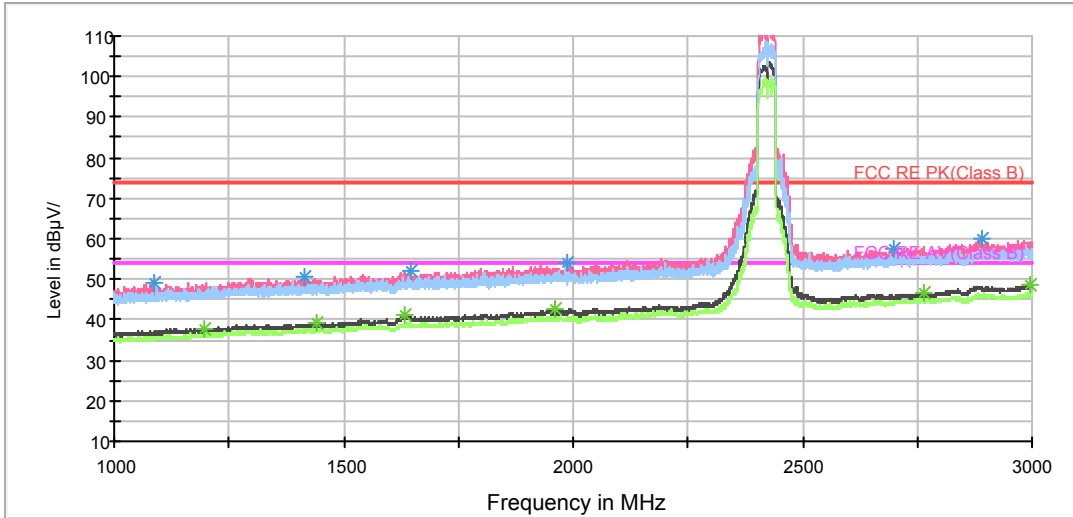

Note: The signal beyond the limit is carrier.
Radiates Emission from 1GHz to 3GHz

RE 3-18GHz PK+AV

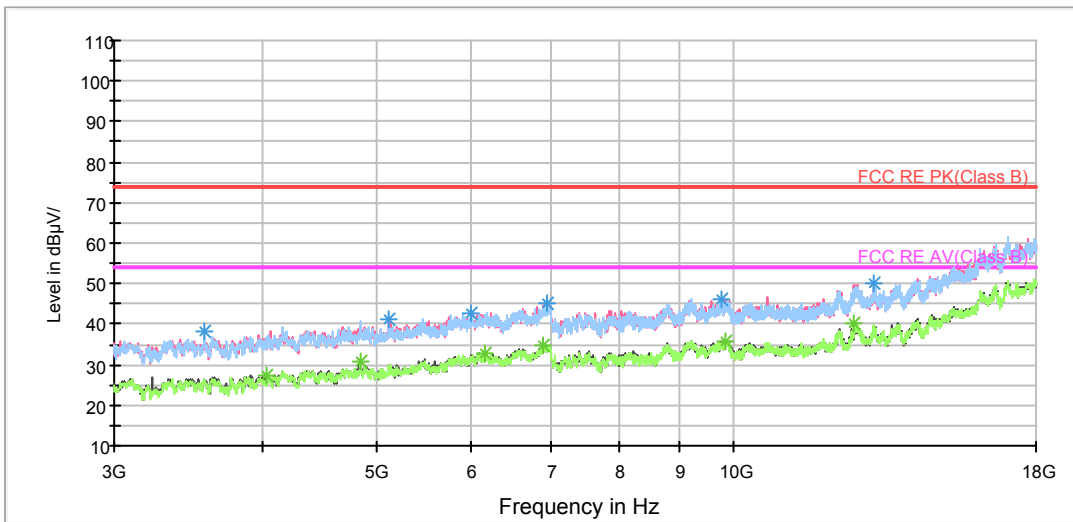

Radiates Emission from 3GHz to 18GHz



Frequency (MHz)	Peak (dBuV/m)	Height (cm)	Polarization	Azimuth (deg)	Reading value (dBuV/m)	Correct Factor (dB)	Margin (dB)	Limit (dBuV/m)
1088.750000	49.2	200.0	V	289.0	48.1	1.1	24.8	74
1415.250000	50.3	200.0	V	237.0	47.3	3.0	23.7	74
1647.500000	52.1	200.0	V	347.0	47.1	5.0	21.9	74
1988.750000	54.0	200.0	V	324.0	47.5	6.5	20.0	74
2698.250000	57.5	200.0	V	185.0	47.5	10.0	16.5	74
2892.250000	59.9	200.0	V	307.0	47.8	12.1	14.1	74

Remark: 1. Correction Factor = Antenna factor+ Insertion loss (cable loss + amplifier gain)

Frequency (MHz)	Average (dBuV/m)	Height (cm)	Polarization	Azimuth (deg)	Reading value (dBuV/m)	Correct Factor (dB)	Margin (dB)	Limit (dBuV/m)
1195.500000	37.7	200.0	V	347.0	35.9	1.8	16.3	54
1439.750000	39.4	200.0	V	185.0	36.3	3.1	14.6	54
1634.750000	40.9	200.0	V	0.0	35.6	5.3	13.1	54
1961.500000	42.8	200.0	V	335.0	36.0	6.8	11.2	54
2762.500000	46.9	200.0	V	220.0	36.0	10.9	7.1	54
2996.500000	48.7	200.0	V	289.0	36.4	12.3	5.3	54

Remark: 1. Correction Factor = Antenna factor+ Insertion loss (cable loss + amplifier gain)

802.11n (HT40) CH6

RE 1G-3GHz PK+AV

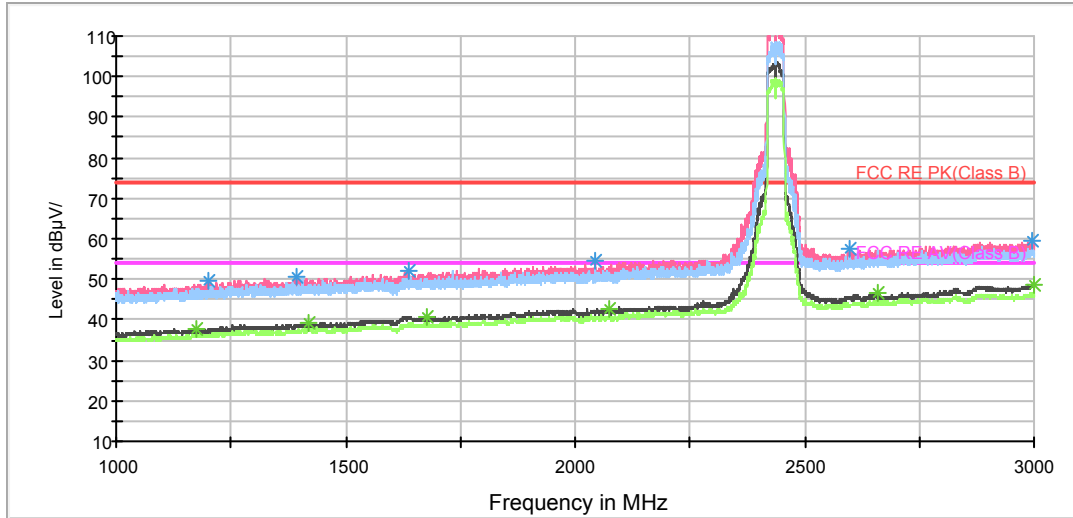

Note: The signal beyond the limit is carrier.
Radiates Emission from 1GHz to 3GHz

RE 3-18GHz PK+AV

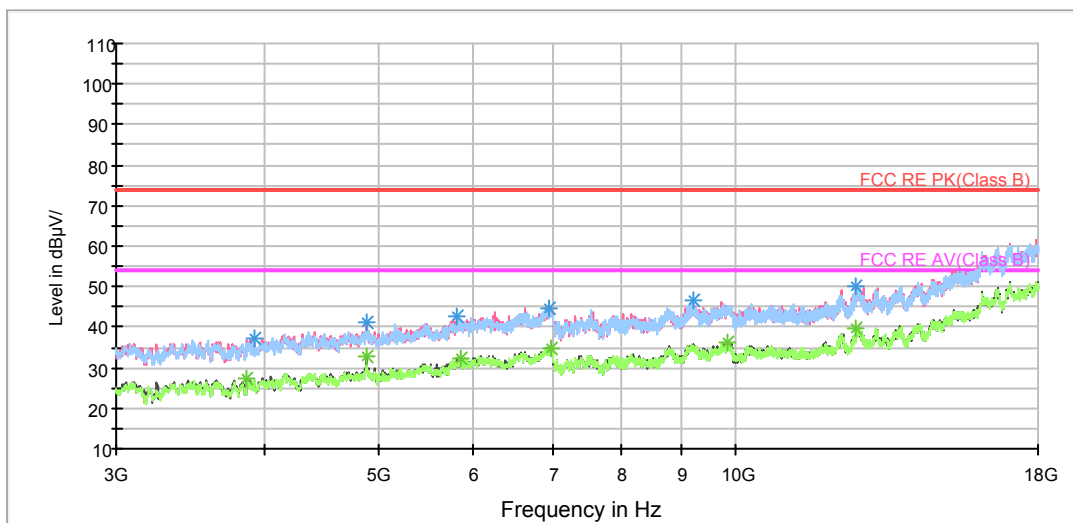

Radiates Emission from 3GHz to 18GHz



Frequency (MHz)	Peak (dBuV/m)	Height (cm)	Polarization	Azimuth (deg)	Reading value (dBuV/m)	Correct Factor (dB)	Margin (dB)	Limit (dBuV/m)
1199.500000	49.5	200.0	V	294.0	47.7	1.8	24.5	74
1393.750000	50.7	200.0	V	218.0	47.7	3.0	23.3	74
1637.750000	52.0	200.0	V	352.0	46.7	5.3	22.0	74
2042.500000	54.3	200.0	V	200.0	47.5	6.8	19.7	74
2598.750000	57.8	200.0	V	0.0	47.4	10.4	16.2	74
2996.000000	59.7	200.0	V	305.0	47.4	12.3	14.3	74

Remark: 1. Correction Factor = Antenna factor+ Insertion loss (cable loss + amplifier gain)

Frequency (MHz)	Average (dBuV/m)	Height (cm)	Polarization	Azimuth (deg)	Reading value (dBuV/m)	Correct Factor (dB)	Margin (dB)	Limit (dBuV/m)
1176.000000	37.7	200.0	V	253.0	35.7	2.0	16.3	54
1419.250000	39.3	200.0	V	229.0	36.2	3.1	14.7	54
1677.250000	40.9	200.0	V	128.0	36.0	4.9	13.1	54
2074.500000	42.6	200.0	V	299.0	35.7	6.9	11.4	54
2660.250000	46.7	200.0	V	235.0	36.3	10.4	7.3	54
2999.750000	48.7	200.0	V	352.0	36.4	12.3	5.3	54

Remark: 1. Correction Factor = Antenna factor+ Insertion loss (cable loss + amplifier gain)

802.11n (HT40) CH9

RE 1G-3GHz PK+AV

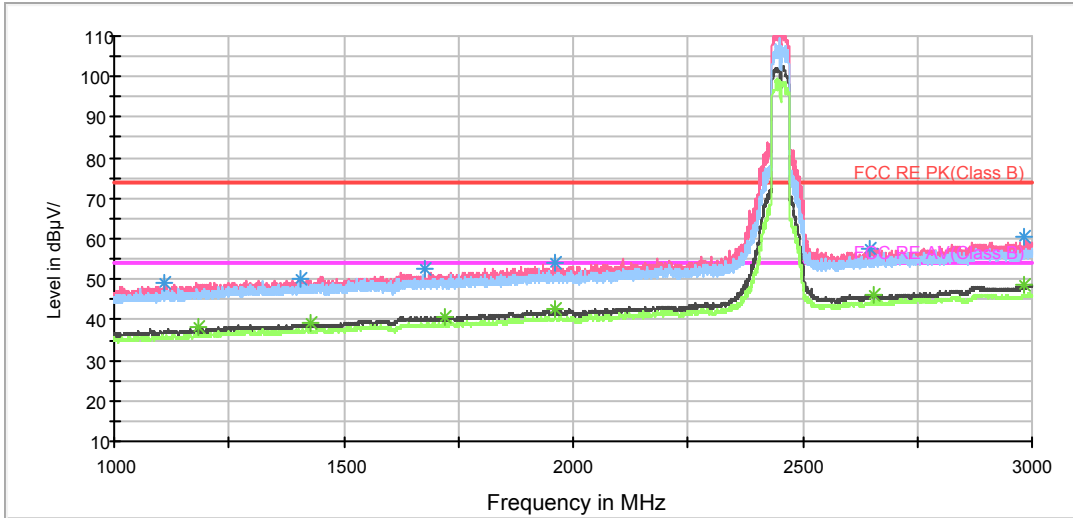

Note: The signal beyond the limit is carrier.
Radiates Emission from 1GHz to 3GHz

RE 3-18GHz PK+AV

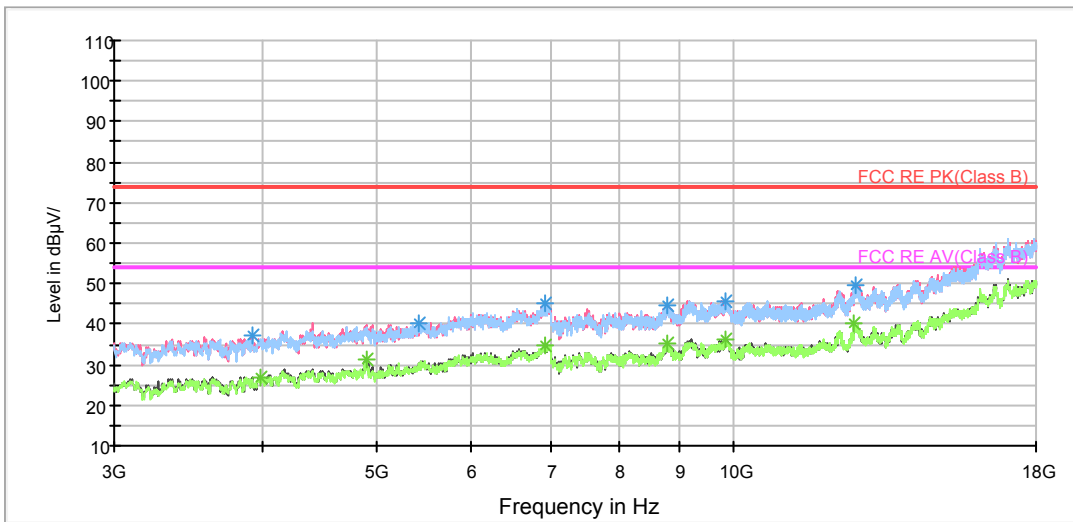

Radiates Emission from 3GHz to 18GHz



Frequency (MHz)	Peak (dBuV/m)	Height (cm)	Polarization	Azimuth (deg)	Reading value (dBuV/m)	Correct Factor (dB)	Margin (dB)	Limit (dBuV/m)
1111.250000	49.2	200.0	V	355.0	47.9	1.3	24.8	74
1405.000000	50.2	200.0	V	355.0	47.3	2.9	23.8	74
1675.500000	52.3	200.0	V	59.0	47.4	4.9	21.7	74
1962.250000	53.9	200.0	V	123.0	47.2	6.7	20.1	74
2645.750000	57.7	200.0	V	264.0	47.4	10.3	16.3	74
2983.000000	60.3	200.0	V	0.0	48.1	12.2	13.7	74

Remark: 1. Correction Factor = Antenna factor+ Insertion loss (cable loss + amplifier gain)

Frequency (MHz)	Average (dBuV/m)	Height (cm)	Polarization	Azimuth (deg)	Reading value (dBuV/m)	Correct Factor (dB)	Margin (dB)	Limit (dBuV/m)
1181.750000	38.2	200.0	V	155.0	36.2	2.0	15.8	54
1427.000000	39.1	200.0	V	275.0	36.0	3.1	14.9	54
1720.250000	40.7	200.0	V	246.0	35.6	5.1	13.3	54
1960.500000	42.6	200.0	V	197.0	35.8	6.8	11.4	54
2653.000000	46.3	200.0	V	321.0	35.9	10.4	7.7	54
2983.750000	48.7	200.0	V	258.0	36.5	12.2	5.3	54

Remark: 1. Correction Factor = Antenna factor+ Insertion loss (cable loss + amplifier gain)

BLE-Channel 0

RE 1G-3GHz PK+AV

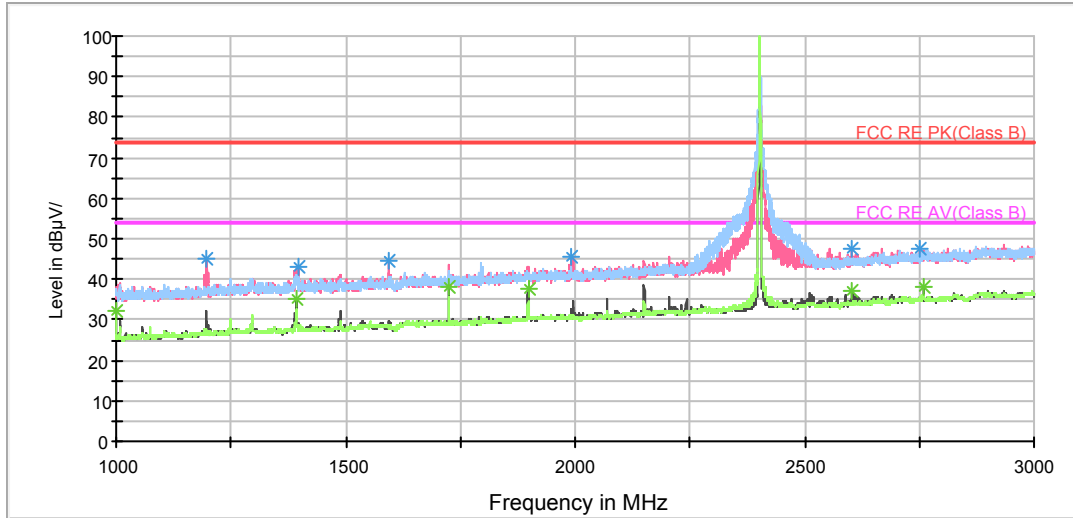

Note: The signal beyond the limit is carrier.
Radiates Emission from 1GHz to 3GHz

RE 3-18GHz PK+AV

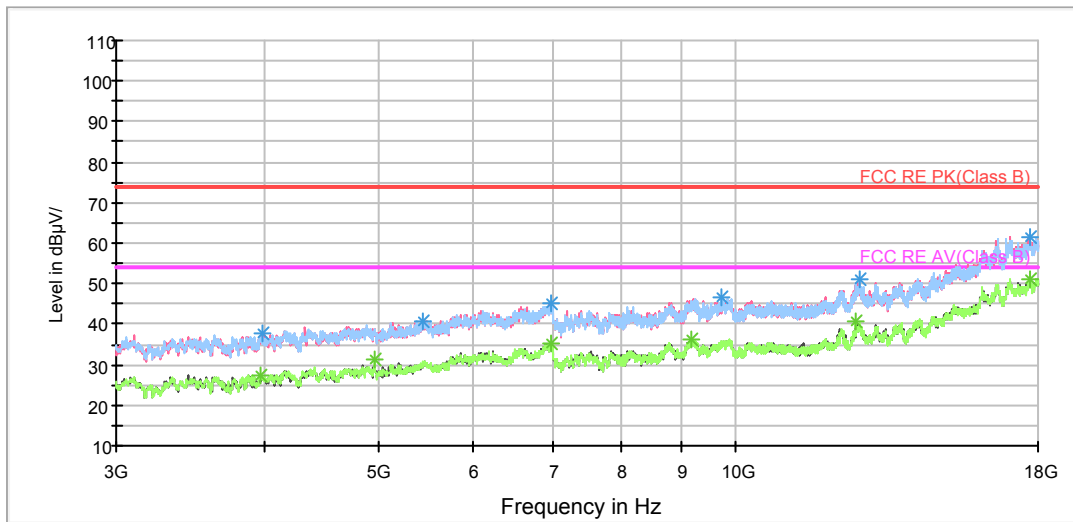

Radiates Emission from 3GHz to 18GHz



Frequency (MHz)	Peak (dBuV/m)	Height (cm)	Polarization	Azimuth (deg)	Reading value (dBuV/m)	Correct Factor (dB)	Margin (dB)	Limit (dBuV/m)
1195.000000	44.9	200.0	V	270.0	53.1	-8.2	29.1	74
1398.750000	42.9	100.0	V	269.0	50.0	-7.1	31.1	74
1594.250000	44.4	100.0	V	269.0	50.8	-6.4	29.6	74
1992.500000	45.7	200.0	V	283.0	49.0	-3.3	28.3	74
2602.750000	47.6	200.0	V	304.0	47.3	0.3	26.4	74
2750.500000	47.4	200.0	V	148.0	46.5	0.9	26.6	74

Remark: 1. Correction Factor = Antenna factor+ Insertion loss (cable loss + amplifier gain)

Frequency (MHz)	Average (dBuV/m)	Height (cm)	Polarization	Azimuth (deg)	Reading value (dBuV/m)	Correct Factor (dB)	Margin (dB)	Limit (dBuV/m)
1000.000000	32.2	200.0	V	45.0	41.4	-9.2	21.8	54
1392.750000	35.2	100.0	V	158.0	42.2	-7.0	18.8	54
1725.000000	38.2	200.0	V	251.0	43.2	-5.0	15.8	54
1897.500000	37.4	100.0	V	0.0	41.3	-3.9	16.6	54
2604.750000	37.3	200.0	V	297.0	37.0	0.3	16.7	54
2760.000000	38.2	100.0	V	354.0	37.3	0.9	15.8	54

Remark: 1. Correction Factor = Antenna factor+ Insertion loss (cable loss + amplifier gain)

BLE-Channel 19

RE 1G-3GHz PK+AV

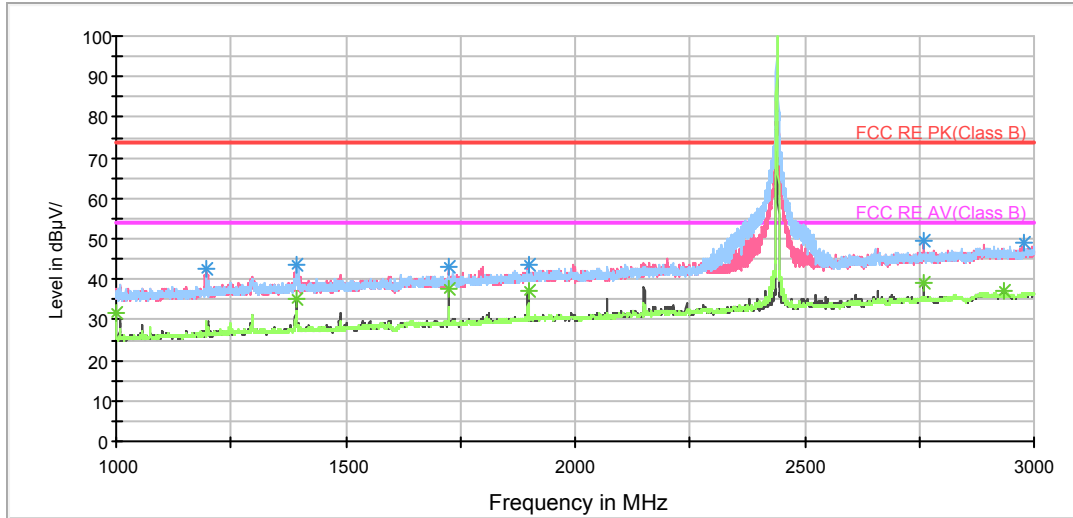

Note: The signal beyond the limit is carrier.
Radiates Emission from 1GHz to 3GHz

RE 3-18GHz PK+AV

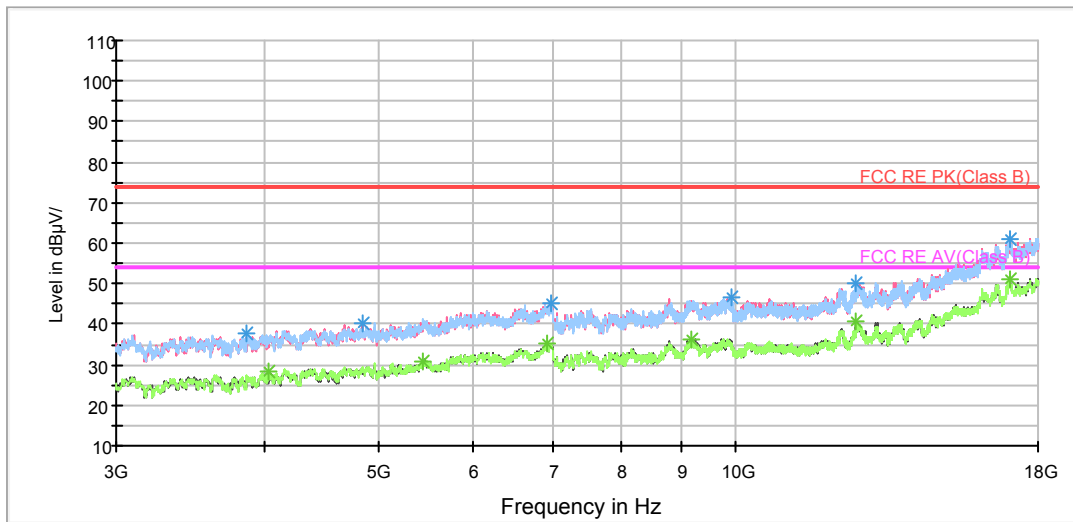

Radiates Emission from 3GHz to 18GHz



Frequency (MHz)	Peak (dBuV/m)	Height (cm)	Polarization	Azimuth (deg)	Reading value (dBuV/m)	Correct Factor (dB)	Margin (dB)	Limit (dBuV/m)
1198.250000	42.4	100.0	V	279.0	50.6	-8.2	31.6	74
1394.750000	43.3	200.0	V	132.0	50.4	-7.1	30.7	74
1725.250000	42.9	200.0	V	251.0	47.9	-5.0	31.1	74
1897.500000	43.5	100.0	V	0.0	47.4	-3.9	30.5	74
2760.000000	49.5	100.0	V	290.0	48.6	0.9	24.5	74
2977.750000	49.0	200.0	V	0.0	46.8	2.2	25.0	74

Remark: 1. Correction Factor = Antenna factor+ Insertion loss (cable loss + amplifier gain)

Frequency (MHz)	Average (dBuV/m)	Height (cm)	Polarization	Azimuth (deg)	Reading value (dBuV/m)	Correct Factor (dB)	Margin (dB)	Limit (dBuV/m)
1000.000000	31.6	200.0	V	45.0	40.8	-9.2	22.4	54
1392.500000	35.2	100.0	V	164.0	42.2	-7.0	18.8	54
1725.000000	37.6	200.0	V	251.0	42.6	-5.0	16.4	54
1897.500000	37.2	100.0	V	0.0	41.1	-3.9	16.8	54
2760.000000	39.2	100.0	V	290.0	38.3	0.9	14.8	54
2932.500000	37.3	100.0	V	239.0	35.5	1.8	16.7	54

Remark: 1. Correction Factor = Antenna factor+ Insertion loss (cable loss + amplifier gain)

BLE-Channel 38

RE 1G-3GHz PK+AV

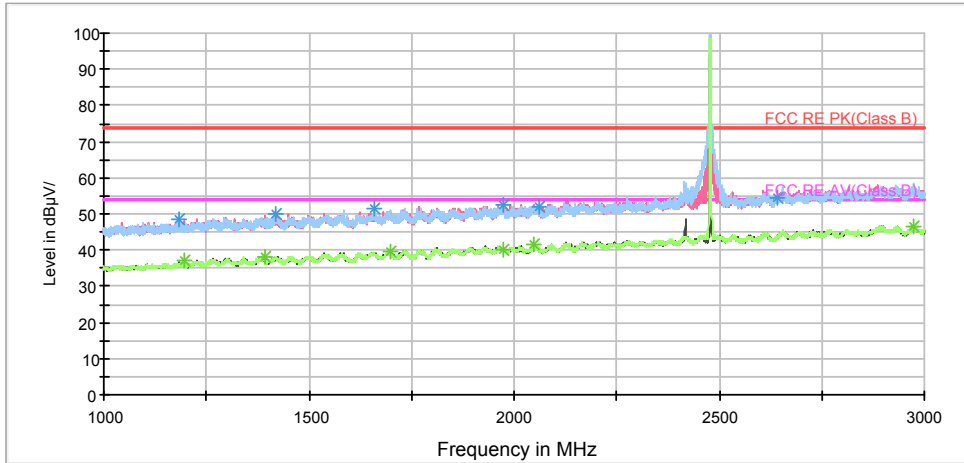

Note: The signal beyond the limit is carrier.
Radiates Emission from 1GHz to 3GHz

RE 3-18GHz PK+AV

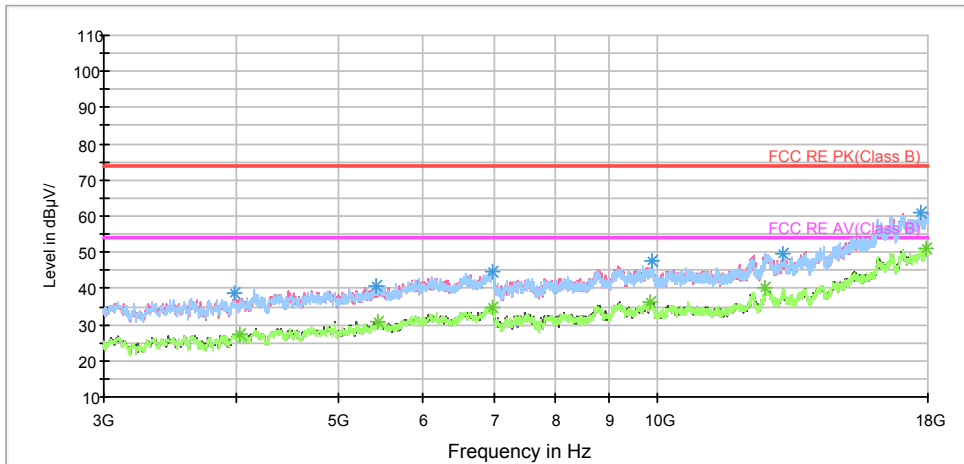

Radiates Emission from 3GHz to 18GHz



Frequency (MHz)	Peak (dBuV/m)	Height (cm)	Polarization	Azimuth (deg)	Reading value (dBuV/m)	Correct Factor (dB)	Margin (dB)	Limit (dBuV/m)
1181.250000	48.7	101.0	H	29.0	46.7	2.0	25.3	74
1419.250000	49.9	200.0	V	179.0	46.8	3.1	24.1	74
1658.000000	51.3	200.0	H	326.0	46.5	4.8	22.7	74
1974.750000	52.6	200.0	H	326.0	46.2	6.4	21.4	74
2059.500000	52.2	200.0	H	36.0	45.3	6.9	21.8	74
2641.250000	54.6	200.0	V	24.0	44.4	10.2	19.4	74

Remark: 1. Correction Factor = Antenna factor+ Insertion loss (cable loss + amplifier gain)

Frequency (MHz)	Average (dBuV/m)	Height (cm)	Polarization	Azimuth (deg)	Reading value (dBuV/m)	Correct Factor (dB)	Margin (dB)	Limit (dBuV/m)
1196.500000	37.0	100.0	V	280.0	35.2	1.8	17.0	54
1392.000000	38.2	200.0	V	24.0	35.2	3.0	15.8	54
1696.750000	39.6	200.0	V	110.0	34.6	5.0	14.4	54
1975.250000	40.3	101.0	H	47.0	33.9	6.4	13.7	54
2049.250000	41.4	101.0	H	264.0	34.6	6.8	12.6	54
2974.250000	46.6	200.0	V	24.0	34.4	12.2	7.4	54

Remark: 1. Correction Factor = Antenna factor+ Insertion loss (cable loss + amplifier gain)

5.8. Conducted Emission

Ambient condition

Temperature	Relative humidity	Pressure
23°C ~25°C	45%~50%	101.5kPa

Methods of Measurement

The EUT is placed on a non-metallic table of 80cm height above the horizontal metal reference ground plane. During the test, the EUT was operating in its typical mode. The test method is according to ANSI C63.10-2013. Connect the AC power line of the EUT to the L.I.S.N. Use EMI receiver to detect the average and Quasi-peak value. RBW is set to 9 kHz, VBW is set to 30kHz. The measurement result should include both L line and N line.

The test is in transmitting mode.

Test Setup

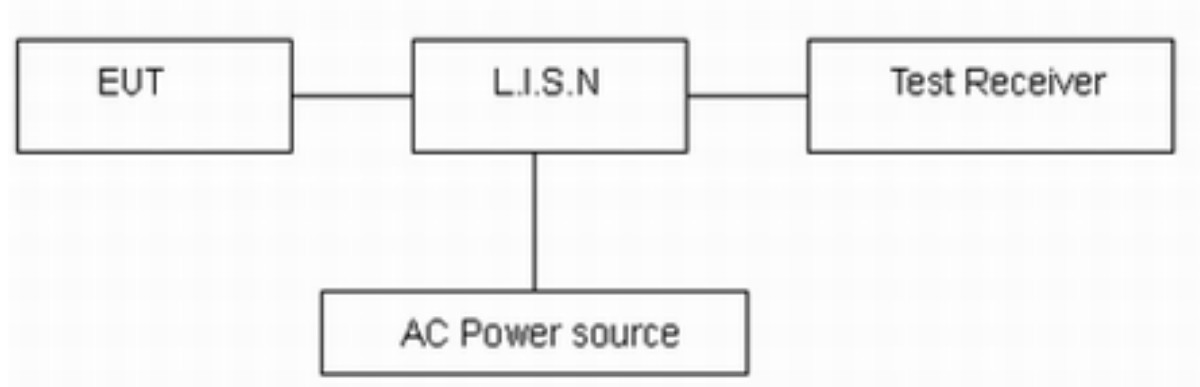

Note: AC Power source is used to change the voltage 110V/60Hz.

Limits

Frequency (MHz)	Conducted Limits(dBμV)	
	Quasi-peak	Average
0.15 - 0.5	66 to 56 *	56 to 46*
0.5 - 5	56	46
5 - 30	60	50

*: Decreases with the logarithm of the frequency.

Measurement Uncertainty

The assessed measurement uncertainty to ensure 95% confidence level for the normal distribution is with the coverage factor $k = 1.96$, $U = 2.69$ dB.

Test Results:

Following plots, Blue trace uses the peak detection and Green trace uses the average detection. During the test, the Conducted Emission was performed in all modes (WIFI 2.4G /BLE) with all channels, 802.11b, Channel 6 are selected as the worst condition. The test data of the worst-case condition was recorded in this report.

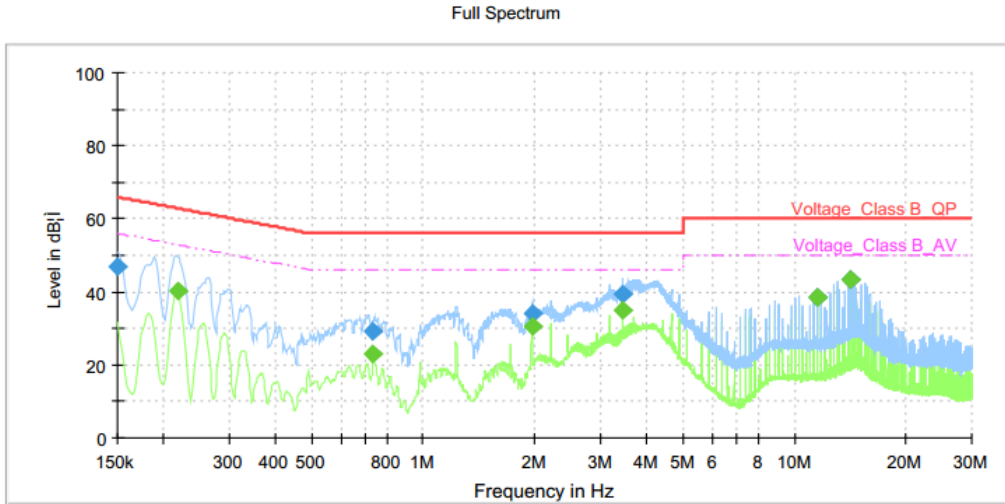

Final Result

Frequency (MHz)	QuasiPeak (dB; i V)	Average (dB; i V)	Limit (dB; i V)	Margin (dB)	Meas. Time (ms)	Bandwidth (kHz)	Line	Filter	Corr. (dB)
0.150000	46.86	---	66.00	19.14	1000.0	9.000	L1	ON	19.1
0.217500	---	40.20	52.91	12.71	1000.0	9.000	L1	ON	19.2
0.735000	---	22.82	46.00	23.18	1000.0	9.000	L1	ON	19.2
0.735000	29.32	---	56.00	26.68	1000.0	9.000	L1	ON	19.2
1.961250	---	30.55	46.00	15.45	1000.0	9.000	L1	ON	19.1
1.963500	33.87	---	56.00	22.13	1000.0	9.000	L1	ON	19.1
3.432750	---	34.85	46.00	11.15	1000.0	9.000	L1	ON	19.0
3.435000	39.20	---	56.00	16.80	1000.0	9.000	L1	ON	19.0
11.526000	38.65	---	60.00	21.35	1000.0	9.000	L1	ON	19.4
11.526000	---	38.32	50.00	11.68	1000.0	9.000	L1	ON	19.4
14.221500	---	43.34	50.00	6.66	1000.0	9.000	L1	ON	19.5
14.221500	43.54	---	60.00	16.46	1000.0	9.000	L1	ON	19.5

L Line

Full Spectrum

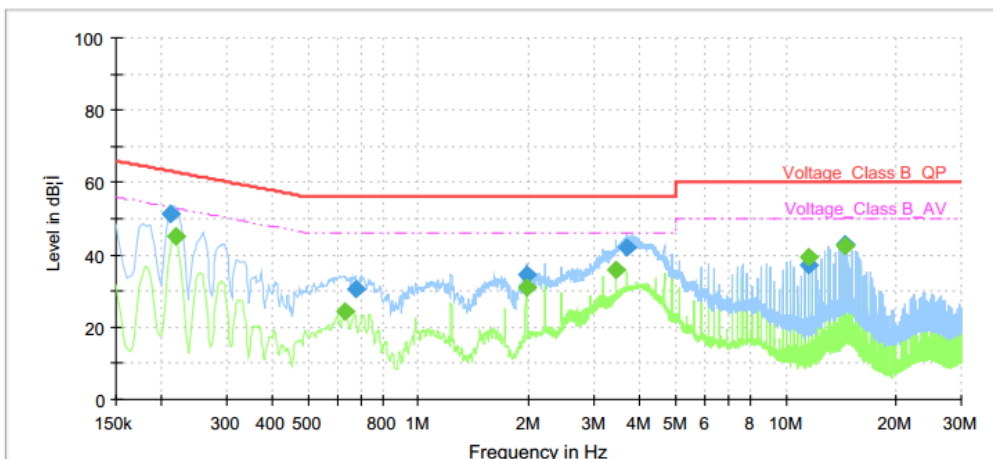

**Final Result**

Frequency (MHz)	QuasiPeak (dB _i V)	Average (dB _i V)	Limit (dB _i V)	Margin (dB)	Meas. Time (ms)	Bandwidth (kHz)	Line	Filter	Corr. (dB)
0.210750	51.14	---	63.18	12.04	1000.0	9.000	N	ON	19.2
0.217500	---	45.35	52.91	7.57	1000.0	9.000	N	ON	19.2
0.631500	---	24.16	46.00	21.84	1000.0	9.000	N	ON	19.3
0.678750	30.41	---	56.00	25.59	1000.0	9.000	N	ON	19.3
1.961250	34.33	---	56.00	21.67	1000.0	9.000	N	ON	19.1
1.961250	---	30.99	46.00	15.01	1000.0	9.000	N	ON	19.1
3.432750	---	35.93	46.00	10.07	1000.0	9.000	N	ON	19.0
3.678000	41.86	---	56.00	14.14	1000.0	9.000	N	ON	19.1
11.526000	---	39.22	50.00	10.78	1000.0	9.000	N	ON	19.4
11.528250	36.96	---	60.00	23.04	1000.0	9.000	N	ON	19.4
14.469000	---	42.47	50.00	7.53	1000.0	9.000	N	ON	19.5
14.471250	42.99	---	60.00	17.01	1000.0	9.000	N	ON	19.5

N Line

6. Main Test Instruments

Name	Manufacturer	Type	Serial Number	Calibration Date	Expiration Date
Spectrum Analyzer	R&S	FSV30	100815	2017-12-17	2018-12-16
EMI Test Receiver	R&S	ESCI	100948	2018-05-20	2019-05-19
TRILOG Broadband Antenna	Schwarzbeck	VULB 9163	9163-201	2017-11-18	2020-11-17
Double Ridged Waveguide Horn Antenna	R&S	HF907	100126	2014-12-06	2019-12-05
Loop Antenna	SCHWARZBECK	FMZB1519	1519-047	2017-11-18	2020-11-17
Standard Gain Horn	ETS-Lindgren	3160-09	00102644	2015-01-30	2020-01-29
EMI Test Receiver	R&S	ESR	101667	2017-09-06	2018-09-05
LISN	R&S	ENV216	101171	2016-12-16	2019-12-15
Spectrum Analyzer	Agilent	N9010A	MY47191109	2018-05-20	2019-05-19
Power Meter	R&S	NRP2	1144.1374K02 -104306-EX	2017-12-21	2018-12-20
Power Sensor	R&S	NRP-Z21	104799	2018-05-20	2019-05-19
RF Cable	Agilent	SMA 15cm	0001	/	/
Software (CE)	ROHDE&SCHW ARZ	EMC32	9.26.0	/	/
Software (RE/RSE)	ROHDE&SCHW ARZ	EMC32	8.52.0	/	/

*****END OF REPORT *****

ANNEX A: EUT Appearance and Test Setup

A.1 EUT Appearance



a: EUT

Picture 1 EUT and Accessory

A.2 Test Setup



30M Hz-1GHz

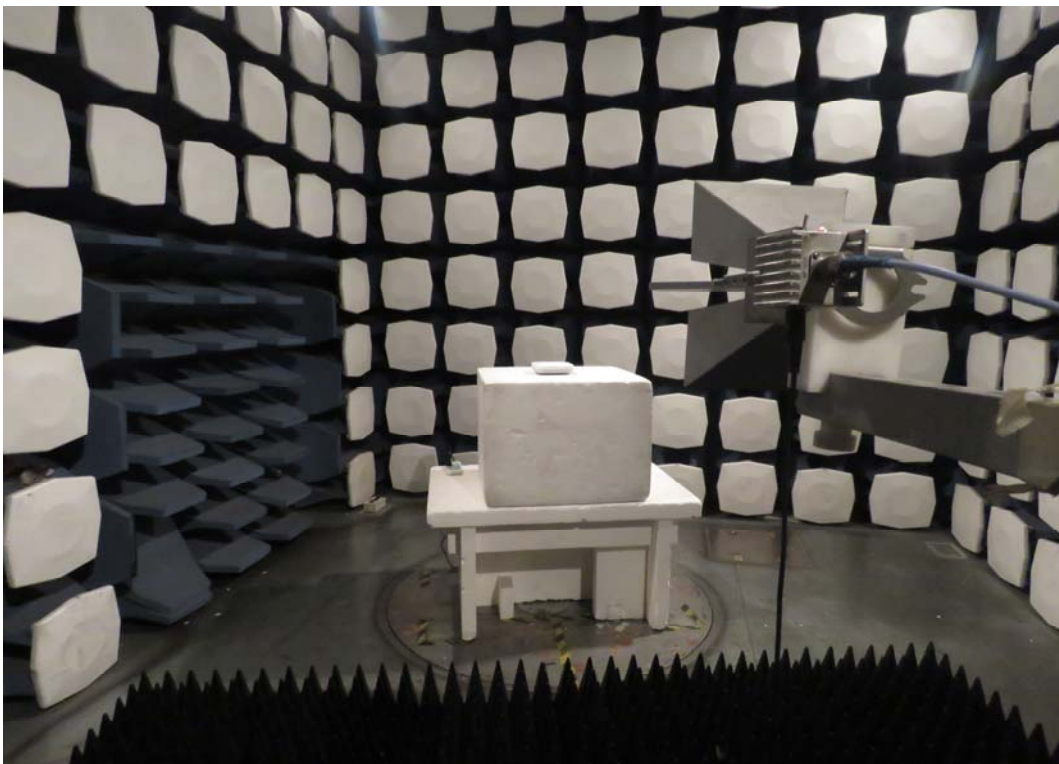

Above 1GHz

Picture 2 Radiated Emission Test Setup



Picture 3 Conducted Emission Test Setup