



**FCC CFR47 PART 15 SUBPART C
CERTIFICATION
TEST REPORT**

FOR

BROADCOM USB BLUETOOTH DONGLE

MODEL NUMBER: BCM92035BTSD

FCC ID: QDS-BRCM1008

REPORT NUMBER: 03U2092-1

ISSUE DATE: AUGUST 27TH, 2003

Prepared for

**BROADCOM CORPORATION
190 MATHILDA PLACE
SUNNYVALE, CALIFORNIA 94086
U.S.A**

Prepared by

**COMPLIANCE CERTIFICATION SERVICES
561F MONTEREY ROAD,
MORGAN HILL, CA 95037, USA
TEL: (408) 463-0885
FAX: (408) 463-0888**

TABLE OF CONTENTS

1. TEST RESULT CERTIFICATION	3
2. EUT DESCRIPTION	4
3. TEST METHODOLOGY.....	5
4. FACILITIES AND ACCREDITATION.....	5
4.1. <i>FACILITIES AND EQUIPMENT</i>	<i>5</i>
4.2. <i>TABLE OF ACCREDITATIONS AND LISTINGS</i>	<i>6</i>
5. CALIBRATION AND UNCERTAINTY	7
5.1. <i>MEASURING INSTRUMENT CALIBRATION</i>	<i>7</i>
5.2. <i>MEASUREMENT UNCERTAINTY.....</i>	<i>7</i>
5.3. <i>TEST AND MEASUREMENT EQUIPMENT.....</i>	<i>8</i>
6. SETUP OF EQUIPMENT UNDER TEST.....	9
7. APPLICABLE LIMITS AND TEST RESULTS.....	13
7.1. <i>20 dB BANDWIDTH</i>	<i>13</i>
7.2. <i>PEAK OUTPUT POWER</i>	<i>17</i>
7.3. <i>MAXIMUM PERMISSIBLE EXPOSURE.....</i>	<i>21</i>
7.4. <i>AVERAGE POWER.....</i>	<i>23</i>
7.5. <i>PEAK POWER SPECTRAL DENSITY</i>	<i>24</i>
7.6. <i>CONDUCTED SPURIOUS EMISSIONS</i>	<i>28</i>
7.7. <i>NUMBER OF HOPPING CHANNELS.....</i>	<i>37</i>
7.8. <i>HOPPING FREQUENCY SEPARATION.....</i>	<i>41</i>
7.9. <i>AVERAGE TIME OF OCCUPANCY</i>	<i>43</i>
7.10. <i>RADIATED EMISSIONS</i>	<i>46</i>
7.11. <i>POWERLINE CONDUCTED EMISSIONS</i>	<i>65</i>
8. SETUP PHOTOS	69

1. TEST RESULT CERTIFICATION

COMPANY NAME: BROADCOM CORP.
190 MATHILDA PLACE
SUNNYVALE, CA 94086
U.S.A

EUT DESCRIPTION: BROADCOM USB BLUETOOTH DONGLE

MODEL: BCM92035BTSD

DATE TESTED: JULY 31 – AUGUST 27, 2003

APPLICABLE STANDARDS	
STANDARD	TEST RESULTS
FCC PART 15 SUBPART C	NO NON-COMPLIANCE NOTED

Compliance Certification Services, Inc. tested the above equipment in accordance with the requirements set forth in the above standards. The test results show that the equipment tested is capable of demonstrating compliance with the requirements as documented in this report.

Note: This document reports conditions under which testing was conducted and results of tests performed. This document may not be altered or revised in any way unless done so by Compliance Certification Services and all revisions are duly noted in the revisions section. Any alteration of this document not carried out by Compliance Certification Services will constitute fraud and shall nullify the document.

Approved & Released For CCS By:

Tested By:

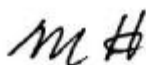

MIKE HECKROTTE
CHIEF ENGINEER
COMPLIANCE CERTIFICATION SERVICES

NEELESH RAJ
EMC ENGINEER
COMPLIANCE CERTIFICATION SERVICES

2. EUT DESCRIPTION

The EUT is a USB BLUETOOTH DONGLE operating in the 2400-2483.5 MHz range with 79 channels. The EUT has a peak output power of 2.78 dBm (1.9 mW) with an antenna gain of 2.8 dBi.

3. TEST METHODOLOGY

The tests documented in this report were performed in accordance with ANSI C63.4/1992, FCC CFR 47 Part 2 and FCC CFR 47 Part 15.







4. FACILITIES AND ACCREDITATION

4.1. FACILITIES AND EQUIPMENT

The open area test sites and conducted measurement facilities used to collect the radiated data are located at 561F Monterey Road, Morgan Hill, California, USA. The sites are constructed in conformance with the requirements of ANSI C63.7, ANSI C63.4 and CISPR Publication 22.

All receiving equipment conforms to CISPR Publication 16-1, "Radio Interference Measuring Apparatus and Measurement Methods."

4.2. TABLE OF ACCREDITATIONS AND LISTINGS

Country	Agency	Scope of Accreditation	Logo
USA	FCC	3/10 meter Open Area Test Sites to perform FCC Part 15/18 measurements	 1300
Japan	VCCI	CISPR 22 Two OATS and one conducted Site	 R-1014, R-619, C-640
Norway	NEMKO	EN50081-1, EN50081-2, EN50082-1, EN50082-2, IEC61000-6-1, IEC61000-6-2, EN50083-2, EN50091-2, EN50130-4, EN55011, EN55013, EN55014-1, EN55104, EN55015, EN61547, EN55022, EN55024, EN61000-3-2, EN61000-3-3, EN60945, EN61326-1	 ELA 117
Norway	NEMKO	EN60601-1-2 and IEC 60601-1-2, the Collateral Standards for Electro-Medical Products. MDD, 93/42/EEC, AIMD 90/385/EEC	 ELA-171
Taiwan	BSMI	CNS 13438	 SL2-IN-E-1012
Canada	Industry Canada	RSS210 Low Power Transmitter and Receiver	 IC2324 A,B,C, and F

5. CALIBRATION AND UNCERTAINTY

5.1. MEASURING INSTRUMENT CALIBRATION

The measurement instruments utilized to perform the tests documented in this report have been calibrated in accordance with the manufacturer's recommendations, and are traceable to national standards.

5.2. MEASUREMENT UNCERTAINTY

Where relevant, the following measurement uncertainty levels have been estimated for tests performed on the apparatus:

Radiated Emission, 30 to 200 MHz	+/- 3.3 dB
Radiated Emission, 200 to 1000 MHz	+4.5 / -2.9 dB
Radiated Emission, 1000 to 2000 MHz	+4.5 / -2.9 dB
Power Line Conducted Emission	+/- 2.9 dB

Uncertainty figures are valid to a confidence level of 95%.

5.3. TEST AND MEASUREMENT EQUIPMENT

The following test and measurement equipment was utilized for the tests documented in this report:

TEST EQUIPMENT LIST				
Name of Equipment	Manufacturer	Model No.	Serial No.	Due Date
LISN, 10 kHz ~ 30 MHz	Solar	8012-50-R-24-BNC	837990	9/6/2003
Line Filter	Lindgren	LMF-3489	497	CNR
LISN, 10 kHz ~ 30 MHz	FCC	50/250-25-2	114	9/6/2003
EMI Test Receiver	R & S	ESHS 20	827129/006	7/17/2004
Antenna, Horn 1 ~ 18 GHz	EMCO	3115	2238	2/4/2004
Preamplifier, 1 ~ 26 GHz	Miteq	NSP10023988	646456	4/25/2004
Power Sensor, 100 kHz ~ 4.2 GHz	HP	8482A	2349A08568	7/15/2004
Power Meter	HP	436A	2709A29209	7/15/2004
Spectrum Analyzer 20 Hz ~ 44 GHz	Agilent	E4446A	US42070220	1/13/2004
Antenna, Bicon/Log, 25 ~ 2000 MHz	ARA	LPB-2520/A	1185	3/6/2004
EMI Receiver, 9 kHz ~ 2.9 GHz	HP	8542E	3942A00286	11/20/2003
10dB Attenuator	Weinschel	56-10	k16148	N/A
2.4-2.5 Reject Filter	Micro-Tronics	BRM50702	1	N/A

6. SETUP OF EQUIPMENT UNDER TEST

SUPPORT EQUIPMENT

PERIPHERAL SUPPORT EQUIPMENT LIST				
Device Type	Manufacturer	Model	Serial Number	FCC ID
LAPTOP	DELL	PP01L	N/A	DoC
AC ADAPTER	DELL	AA20031	09364U16291-297	N/A

I/O CABLES

Cable No.	Port	# of Identical Ports	Connector Type	Cable Type	Cable Length	Remarks
1	USB	1	USB	SHIELDED	1.86M	N/A

TEST SETUP

The EUT was connected to the laptop via its USB port. The EUT was tested at X, Y, and Z positions, Y axis was found to be the worst case. During the testing process the laptop and ac adapter were located under the table.

SETUP DIAGRAM

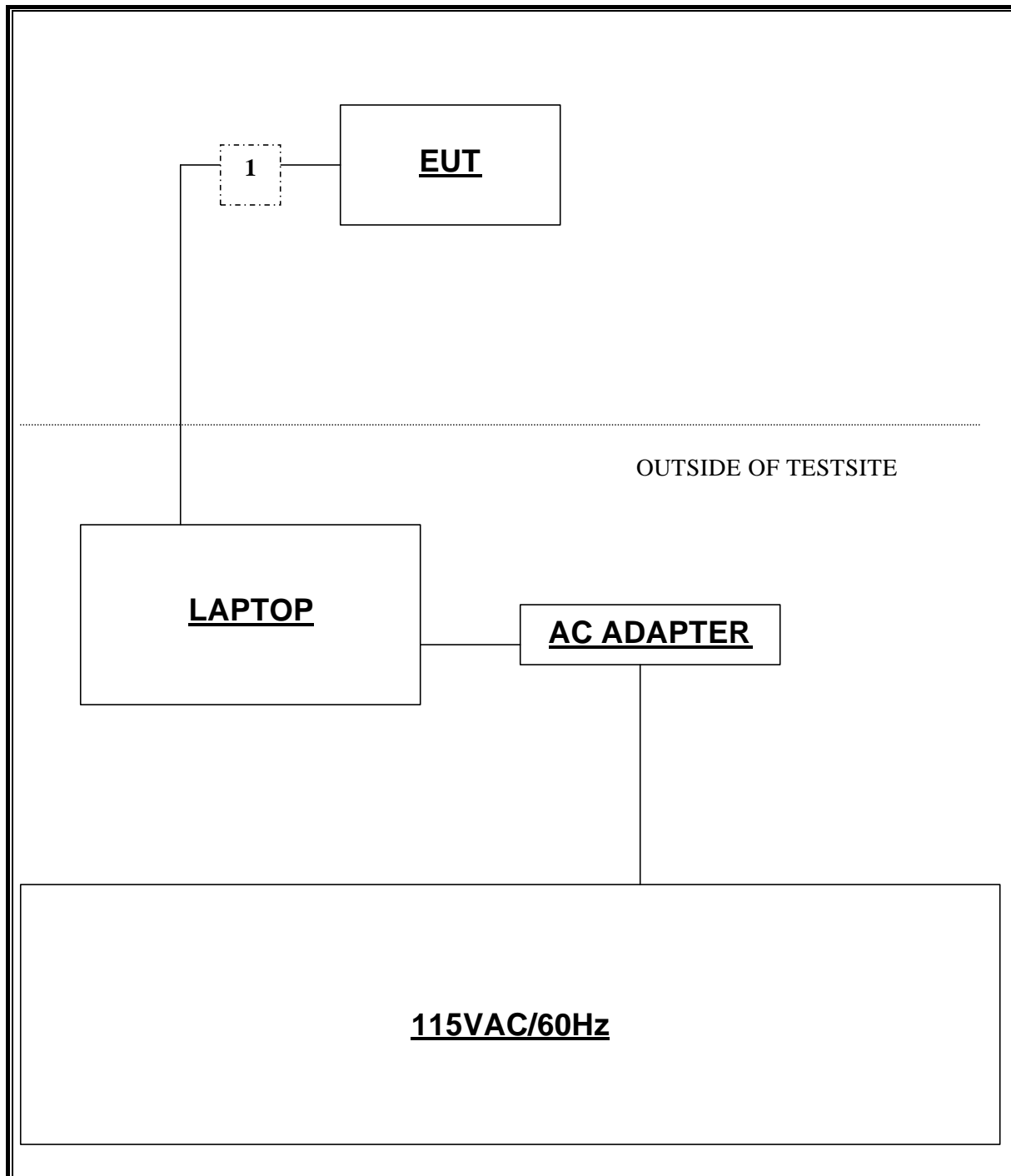

SETUP FOR DIGITAL DEVICE TESTS

SUPPORT EQUIPMENT

PERIPHERAL SUPPORT EQUIPMENT LIST				
Device Type	Manufacturer	Model	Serial Number	FCC ID
LAPTOP	DELL	PP01L	N/A	DoC
AC ADAPTER	DELL	AA20031	09364U16291-297	N/A
MODEM	ACEEX	1414	9013537	IFAXDM1414
PRINTER	HP	N/A	N/A	N/A
AC/DC ADAPTER	ILSUNG ELECTRONICS	ISA-30509	N/A	N/A
AC/DC ADAPTER	N/A	FB13130	N/A	N/A

I/O CABLES

Cable No.	Port	# of Identical Ports	Connector Type	Cable Type	Cable Length	Remarks
1	USB	1	USB	SHIELDED	1.86M	N/A
2	DC PWR	1	DC PWR	UNSHIELDED	1.86M	FERRITE LAPTOP END
3	AC PWR	1	AC PWR	UNSHIELDED	1.86M	N/A
4	PARALLEL	1	DB-25	SHIELDED	1.86M	FERRITE PRINTER END
5	SERIAL	1	DB-9	UNSHIELDED	1.86M	N/A
6 & 7	DC PWR	1	DC PWR	UNSHIELDED	1.86M	N/A

TEST SETUP

The EUT was connected to the laptop via its USB port. The EUT was tested at X, Y, and Z positions, Y axis was found to be the worst case.

SETUP DIAGRAM FOR DIGITAL DEVICE TESTS

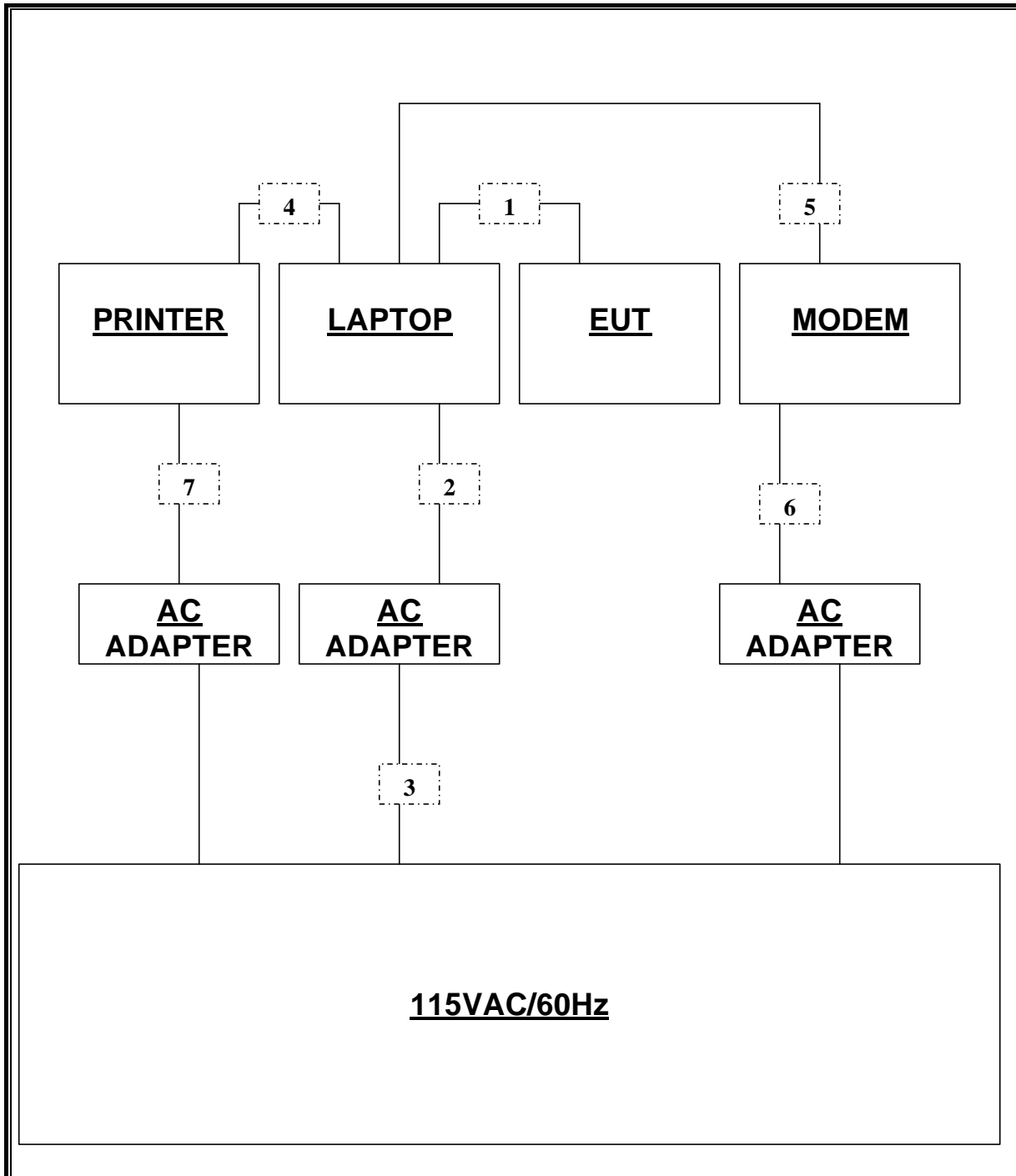

7. APPLICABLE LIMITS AND TEST RESULTS

7.1. 20 dB BANDWIDTH

LIMIT

None; for reporting purposes only.

TEST PROCEDURE

The transmitter output is connected to a spectrum analyzer. The RBW is set to 1% to 3% of the 20 dB bandwidth. The VBW is set to 3 times the RBW. The sweep time is coupled.

RESULTS

No non-compliance noted:

Channel	Frequency (MHz)	20 dB Bandwidth (kHz)
Low	2402	935
Middle	2441	940
High	2480	935

20 DB BANDWIDTH

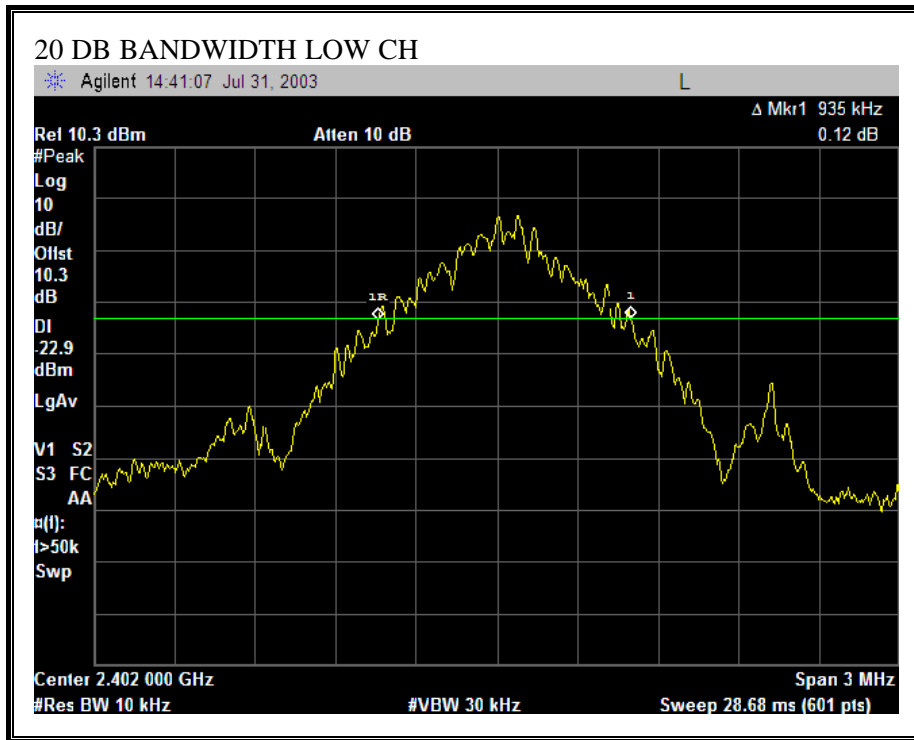

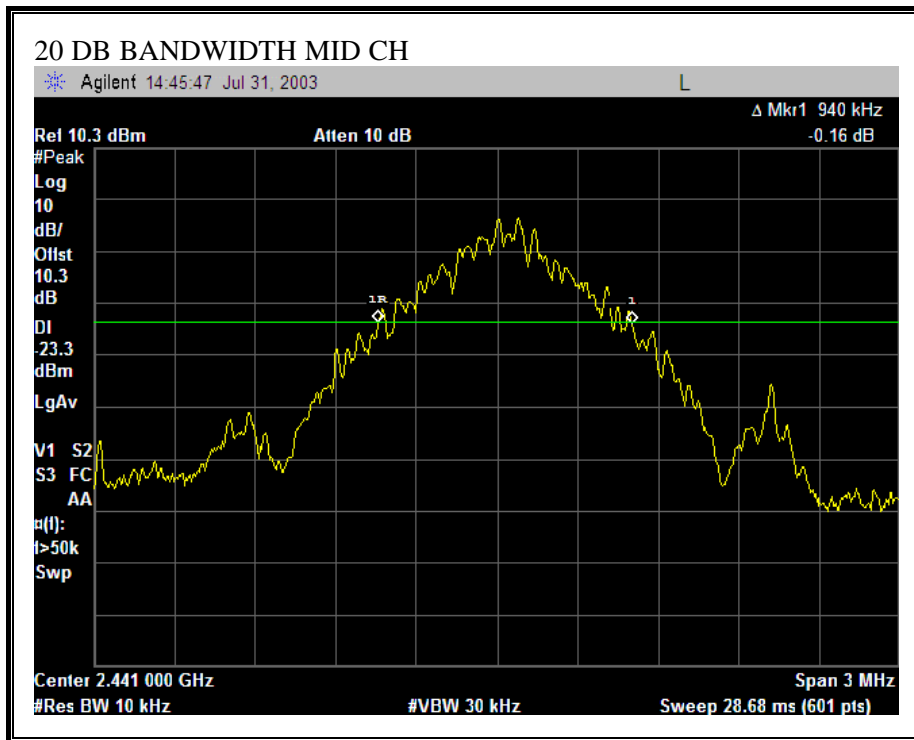

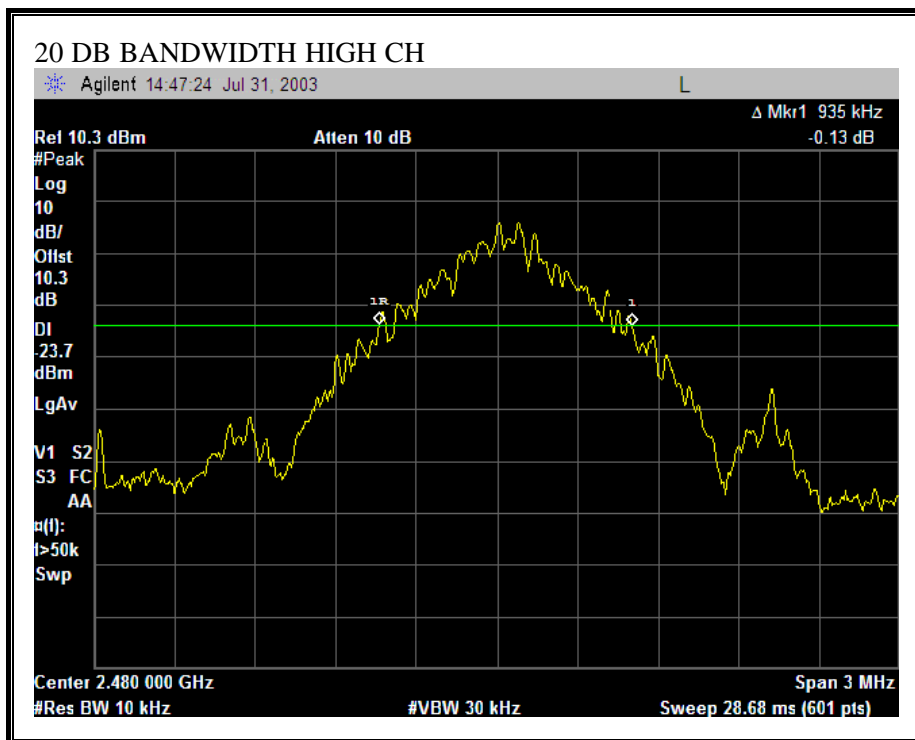

7.2. PEAK OUTPUT POWER

PEAK POWER LIMIT

§15.247 (b) The maximum peak output power of the intentional radiator shall not exceed the following:

§15.247 (b) (1) For frequency hopping systems operating in the 2400-2483.5 MHz band employing at least 75 hopping channels: 1 watt.

§15.247 (b) (4) Except as shown in paragraphs (b)(3) (i), (ii) and (iii) of this section, if transmitting antennas of directional gain greater than 6 dBi are used the peak output power from the intentional radiator shall be reduced below the stated values in paragraphs (b)(1) or (b)(2) of this section, as appropriate, by the amount in dB that the directional gain of the antenna exceeds 6 dBi.

The maximum antenna gain is 2.8 dBi, therefore the limit is 30 dBm.

TEST PROCEDURE

The transmitter output is connected to a spectrum analyzer and the analyzer bandwidth is set to a value greater than the 20 dB bandwidth of the EUT.

RESULTS

No non-compliance noted:

Channel	Frequency (MHz)	Peak Power (dBm)	Limit (dBm)	Margin (dB)
Low	2402	2.78	30	-27.22
Middle	2441	2.49	30	-27.51
High	2480	2.03	30	-27.97

OUTPUT POWER

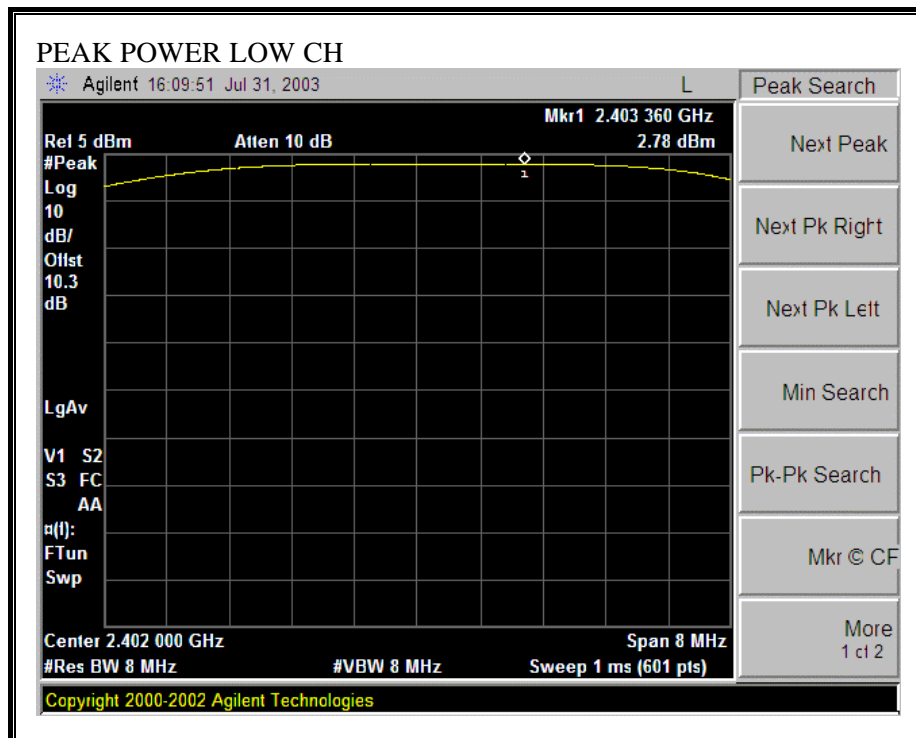

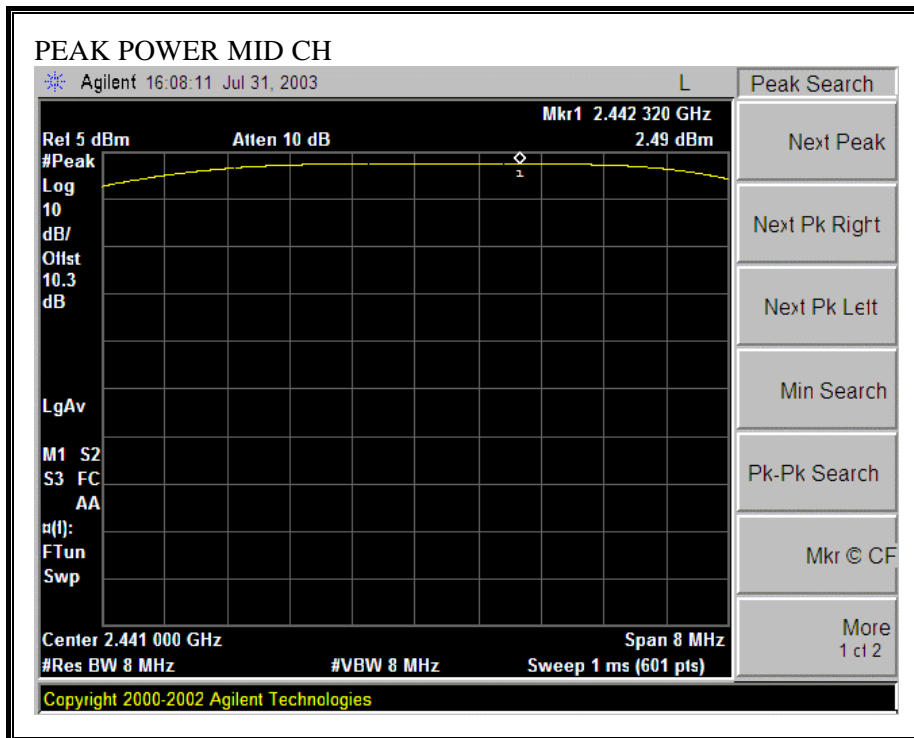

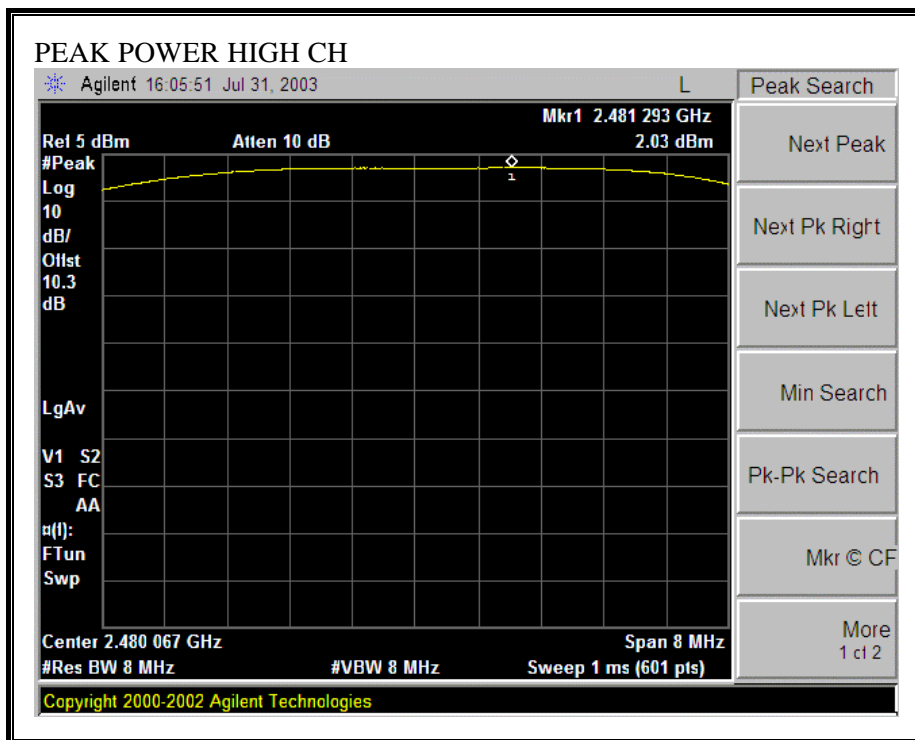

7.3. MAXIMUM PERMISSIBLE EXPOSURE

LIMITS

§15.247 (b) (5) Systems operating under the provisions of this section shall be operated in a manner that ensures that the public is not exposed to radio frequency energy levels in excess of the Commission's guidelines. See §1.1307(b)(1) of this chapter.

CALCULATIONS

Given

$$E = \sqrt{(30 * P * G) / d}$$

and

$$S = E^2 / 3770$$

where

E = Field Strength in Volts / meter

P = Power in Watts

G = Numeric antenna gain

d = distance in meters

S = Power Density in milliwatts / square centimeter

Combining equations and rearranging the terms to express the distance as a function of the remaining variables yields:

$$d = \sqrt{((30 * P * G) / (3770 * S))}$$

Changing to units of mW and cm, using:

$$P \text{ (mW)} = P \text{ (W)} / 1000 \text{ and}$$

$$d \text{ (cm)} = 100 * d \text{ (m)}$$

yields

$$d = 100 * \sqrt{((30 * (P / 1000) * G) / (3770 * S))}$$

$$d = 0.282 * \sqrt{(P * G / S)}$$

where

d = distance in cm

P = Power in mW

G = Numeric antenna gain

S = Power Density in mW / cm²

Substituting the logarithmic form of power and gain using:

$$P \text{ (mW)} = 10^{(P \text{ (dBm)} / 10)} \text{ and}$$

$$G \text{ (numeric)} = 10^{(G \text{ (dBi)} / 10)}$$

yields

$$d = 0.282 * 10^{((P + G) / 20) / \sqrt{S}} \quad \text{Equation (1)}$$

where

d = MPE distance in cm

P = Power in dBm

G = Antenna Gain in dBi

S = Power Density Limit in mW / cm²

Equation (1) and the measured peak power is used to calculate the MPE distance.

LIMITS

S = 1.0 mW / cm² from 1.1310 Table 1

RESULTS

No non-compliance noted:

Power Density Limit (mW/cm ²)	Output Power (dBm)	Antenna Gain (dBi)	MPE Distance (cm)
1.0	2.78	2.80	0.54

NOTE: For mobile or fixed location transmitters, the minimum separation distance is 20 cm, even if calculations indicate that the MPE distance would be less.

7.4. AVERAGE POWER

AVERAGE POWER LIMIT

None; for reporting purposes only.

TEST PROCEDURE

The transmitter output is connected to a power meter.

RESULTS

No non-compliance noted:

The cable assembly insertion loss of 10.3 dB (including 10 dB pad and 0.3 dB cable) was entered as an offset in the power meter to allow for direct reading of power.

802.11b Mode

Channel	Frequency (MHz)	Average Power (dBm)
Low	2402	2.38
Middle	2441	2.18
High	2480	1.83

7.5. PEAK POWER SPECTRAL DENSITY

LIMIT

§15.247 (d) For direct sequence systems, the peak power spectral density conducted from the intentional radiator to the antenna shall not be greater than 8 dBm in any 3 kHz band during any time interval of continuous transmission.

§15.247 (f) The digital modulation operation of the hybrid system, with the frequency hopping turned off, shall comply with the power density requirements of paragraph (d) of this section.

TEST PROCEDURE

The transmitter output is connected to a spectrum analyzer, the maximum level in a 3 kHz bandwidth is measured with the spectrum analyzer using RBW = 3 kHz and VBW > 3 kHz, sweep time = span / 3 kHz, and video averaging is turned off. The PPSD is the highest level found across the emission in any 3 kHz band.

RESULTS

No non-compliance noted:

Channel	Frequency (MHz)	PPSD (dBm)	Limit (dBm)	Margin (dB)
Low	2402	-10.78	8	-18.78
Middle	2441	-10.91	8	-18.91
High	2480	-11.07	8	-19.07

PEAK POWER SPECTRAL DENSITY

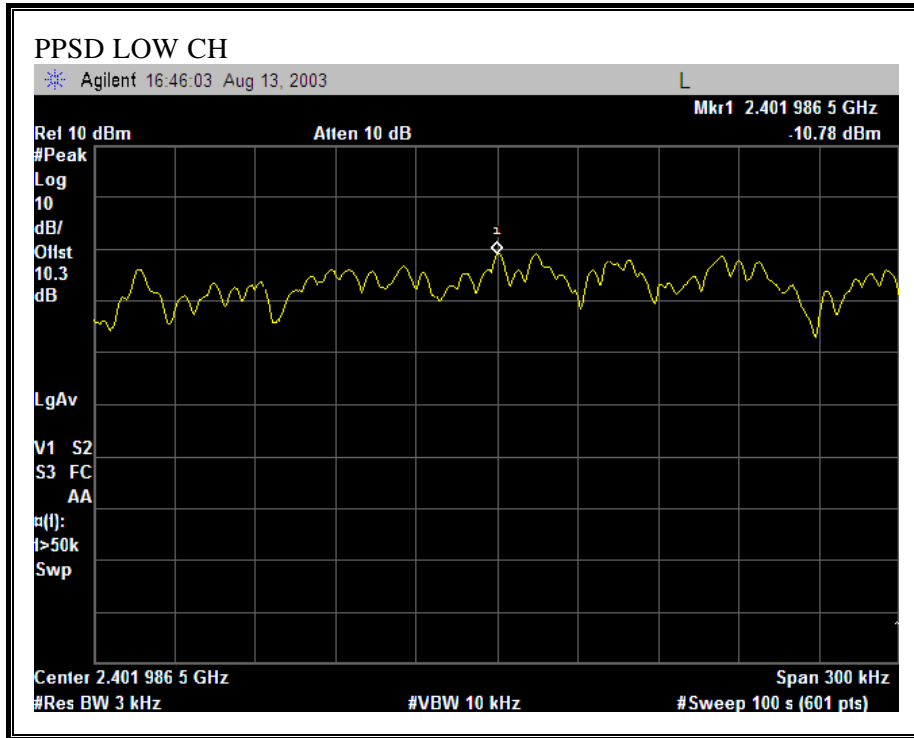

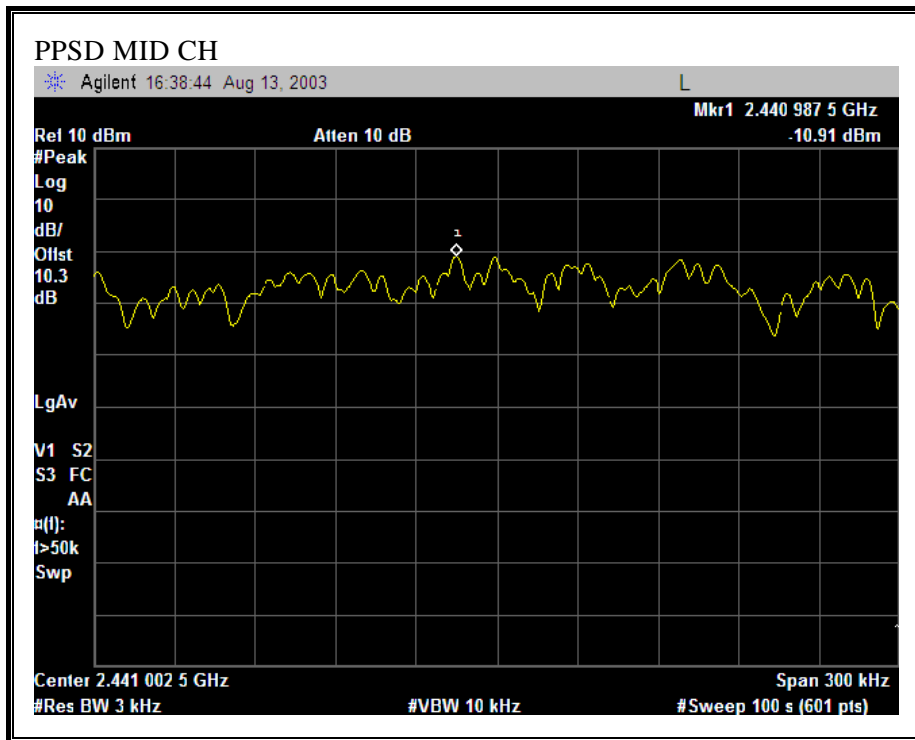

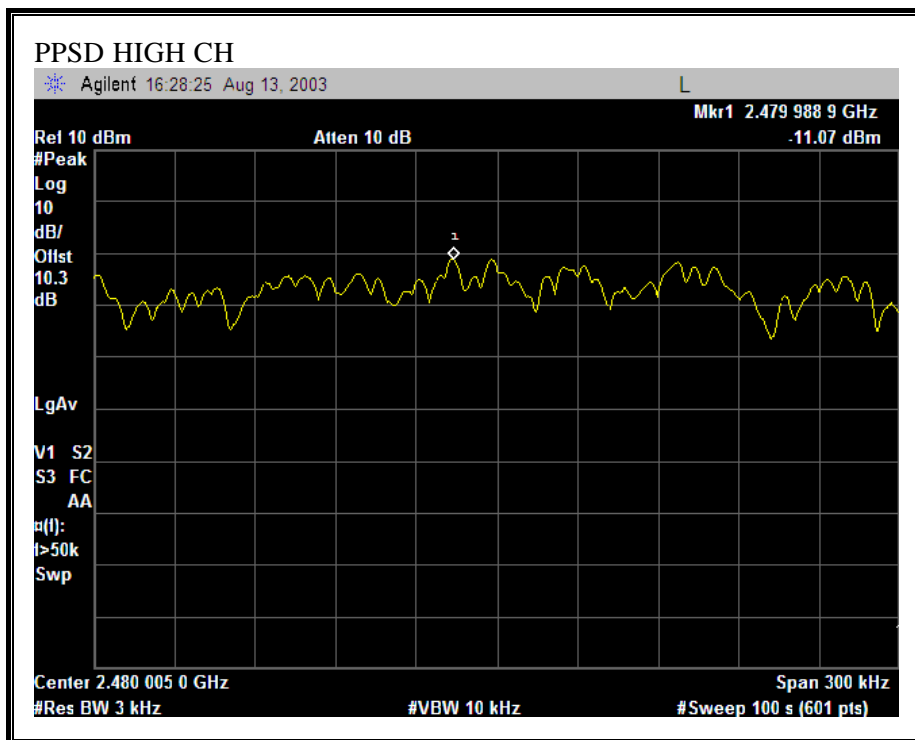

7.6. CONDUCTED SPURIOUS EMISSIONS

LIMITS

§15.247 (c) In any 100 kHz bandwidth outside the frequency band in which the spread spectrum intentional radiator is operating, the radio frequency power that is produced by the intentional radiator shall be at least 20 dB below that in the 100 kHz bandwidth within the band that contains the highest level of the desired power, based on either an RF conducted or a radiated measurement. Attenuation below the general limits specified in §15.209(a) is not required. In addition, radiated emissions which fall in the restricted bands, as defined in §15.205(a), must also comply with the radiated emission limits specified in §15.209(a) (see §15.205(c)).

TEST PROCEDURE

The transmitter output is connected to a spectrum analyzer. The resolution bandwidth is set to 100 kHz. The video bandwidth is set to 100 kHz.

The spectrum from 30 MHz to 26 GHz is investigated with the transmitter set to the lowest, middle, and highest channels.

RESULTS

No non-compliance noted:

SPURIOUS EMISSIONS, LOW CHANNEL

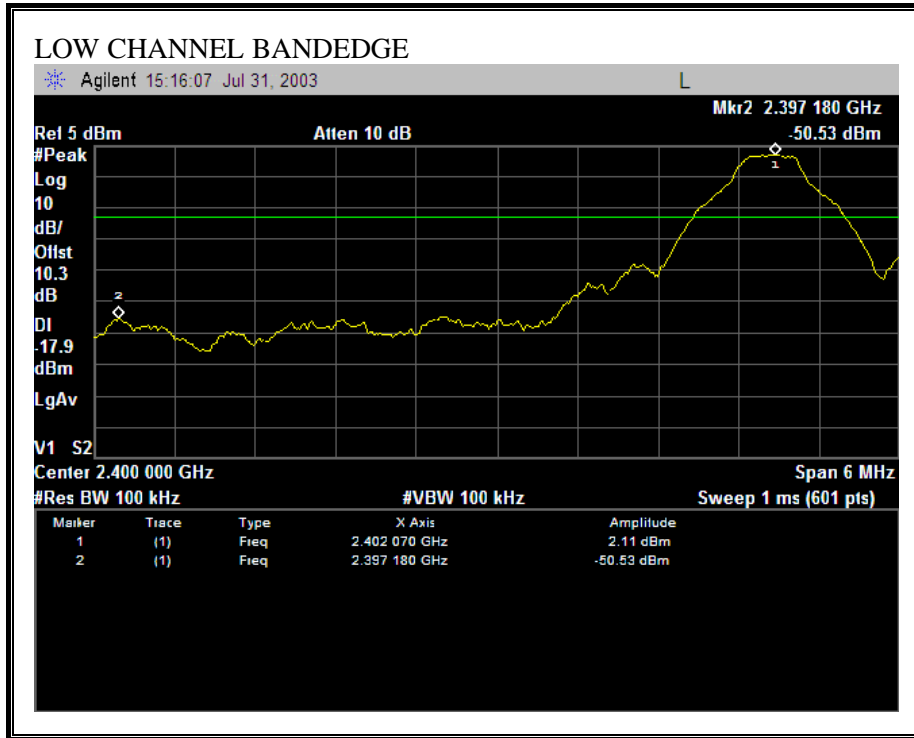

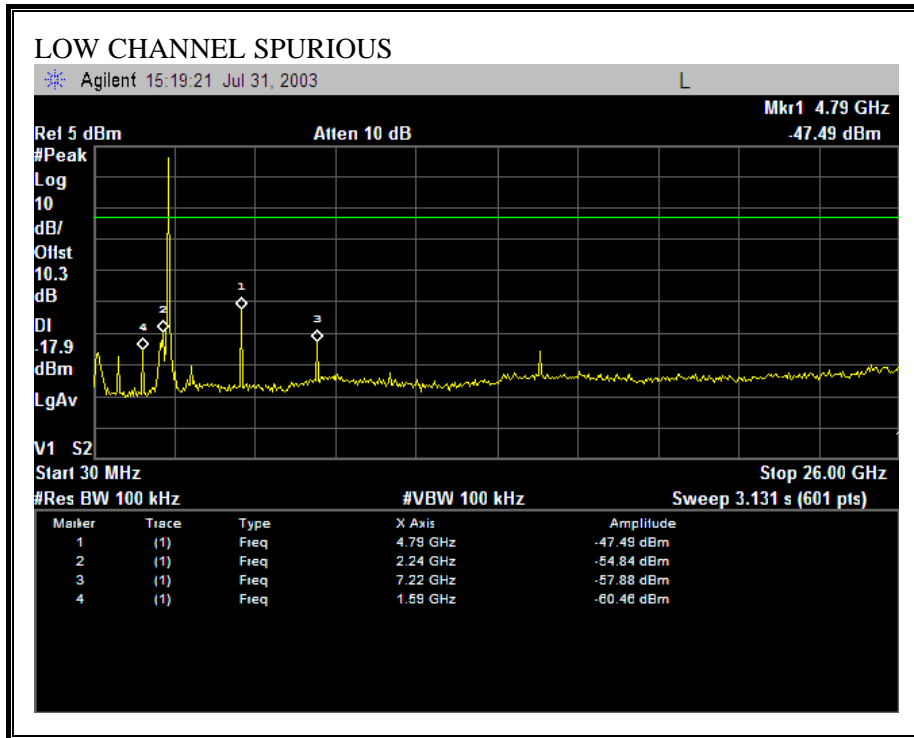

SPURIOUS EMISSIONS, MID CHANNEL

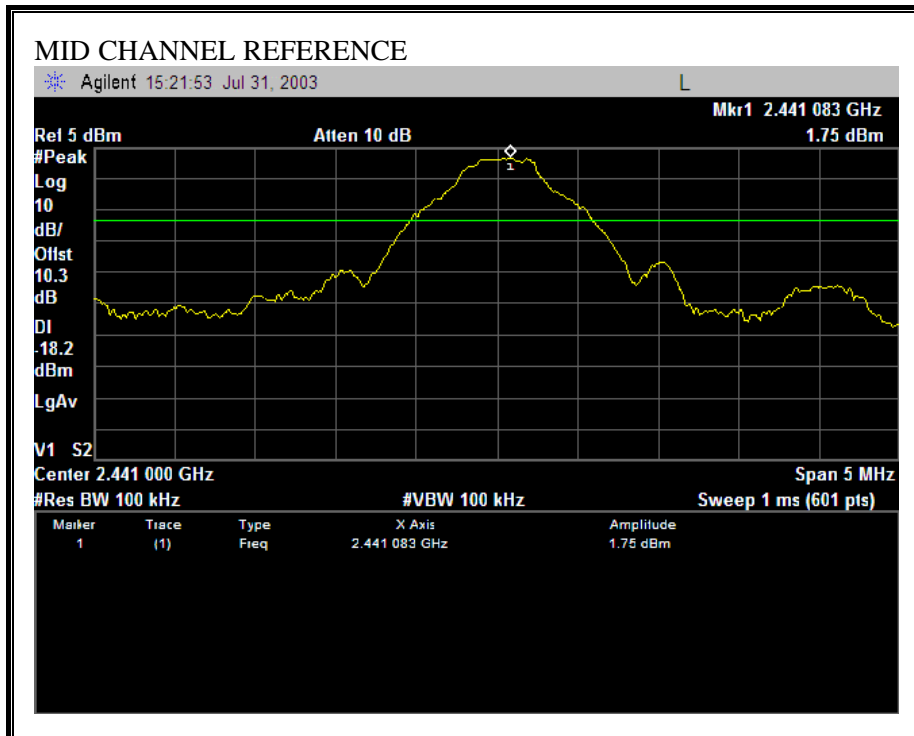

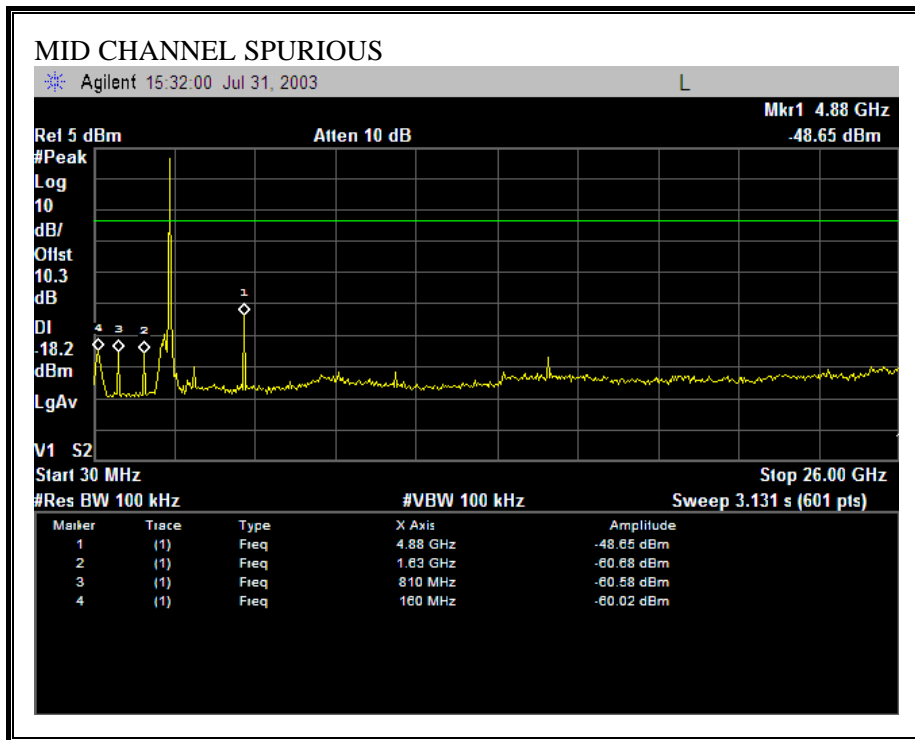

SPURIOUS EMISSIONS, HIGH CHANNEL

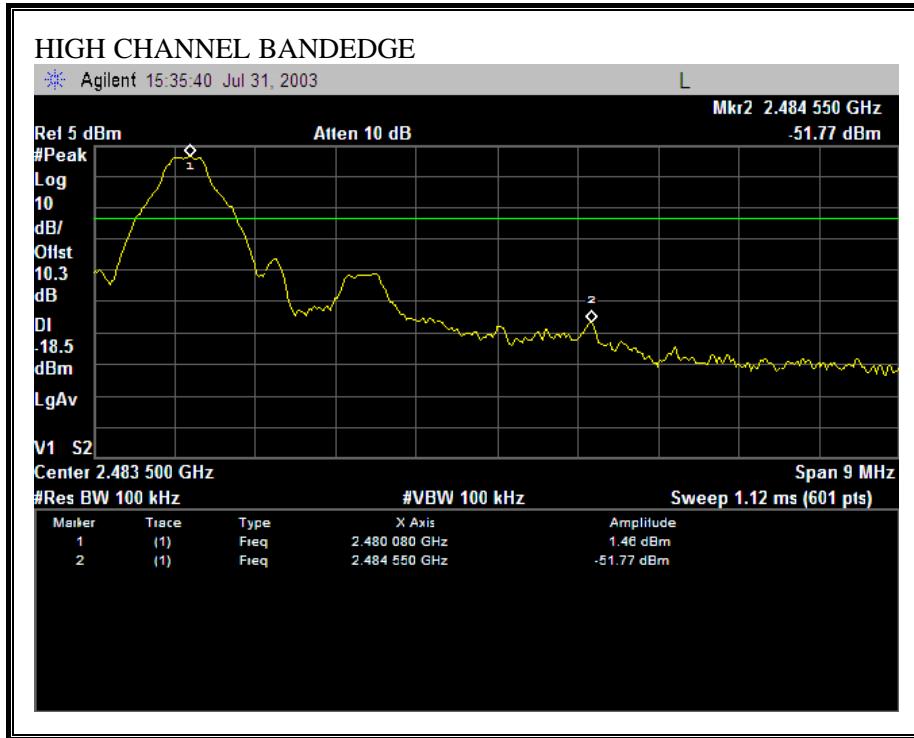

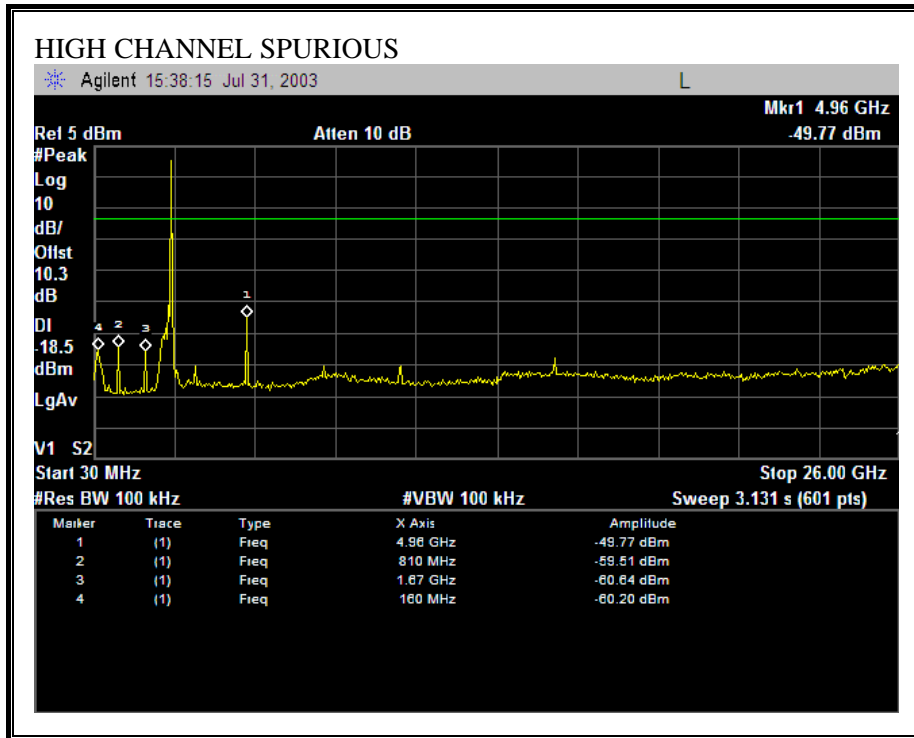

SPURIOUS BANDEDGE EMISSIONS WITH HOPPING ON

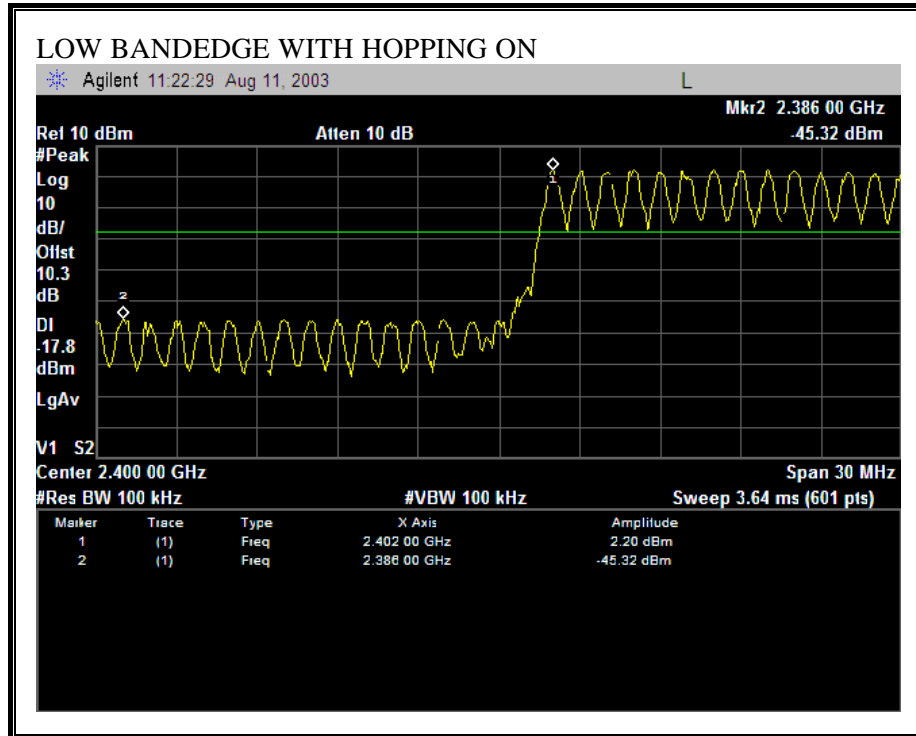

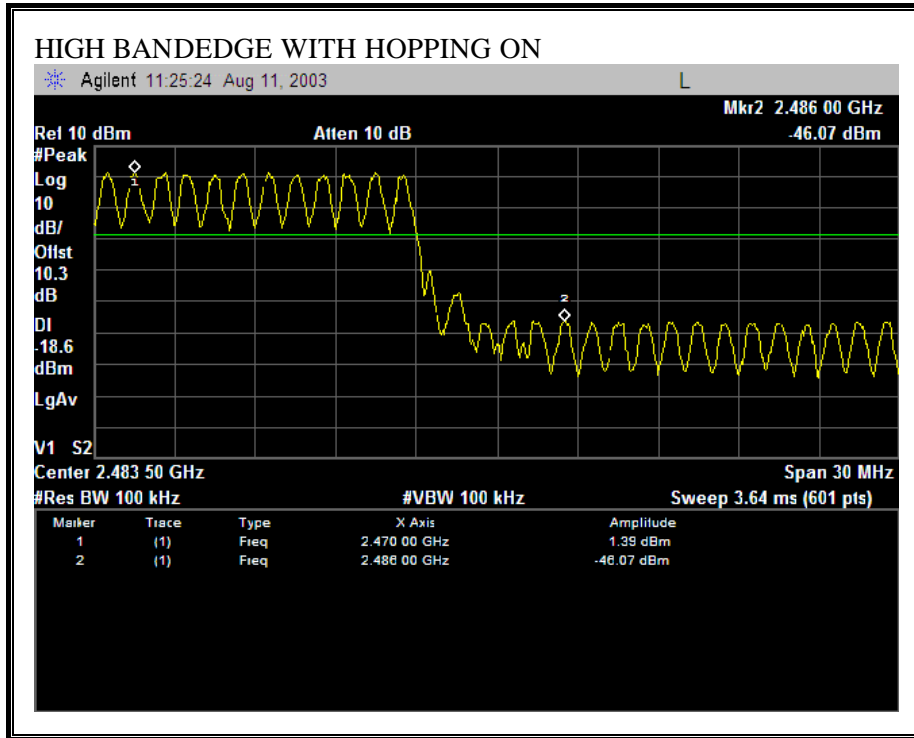

7.7. NUMBER OF HOPPING CHANNELS

LIMIT

§15.247 (a) (1) (iii) Frequency hopping systems in the 2400 – 2483.5 MHz band shall use at least 15 non-overlapping channels.

TEST PROCEDURE

The transmitter output is connected to a spectrum analyzer. The span is set to cover the entire authorized band, in either a single sweep or in multiple contiguous sweeps. The RBW is set to 1 % of the span. The analyzer is set to Max Hold.

RESULTS

No non-compliance noted:

79 Channels observed.

NUMBER OF HOPPING CHANNELS

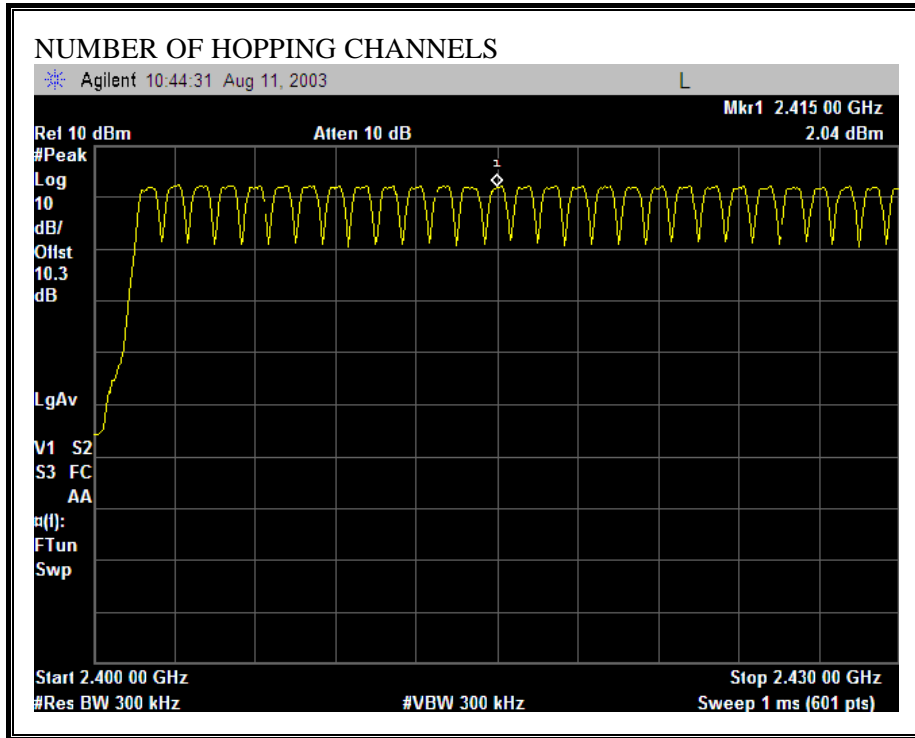

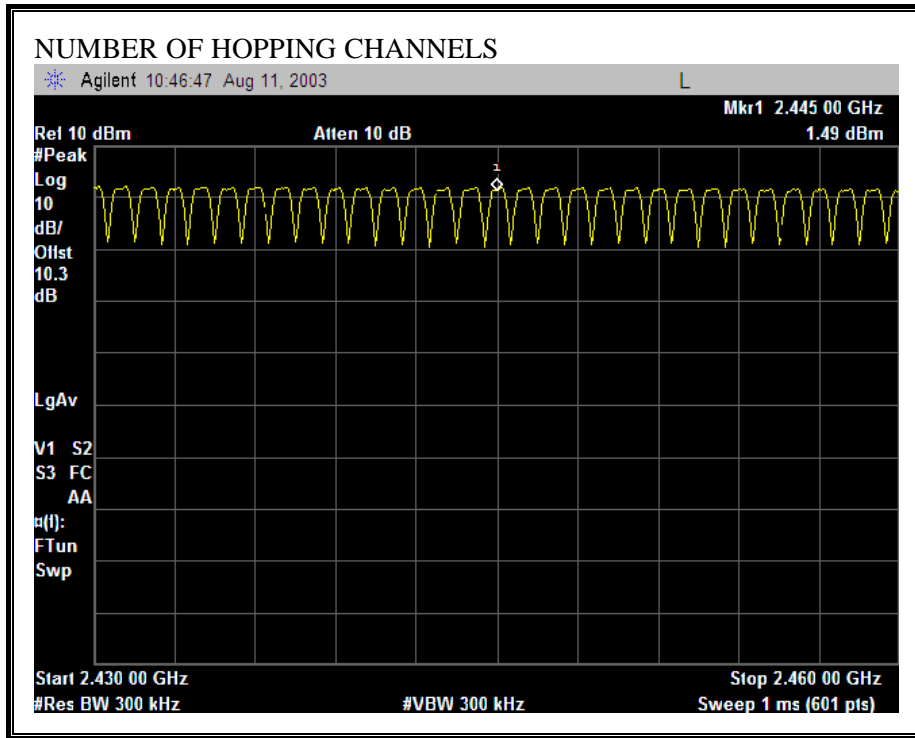

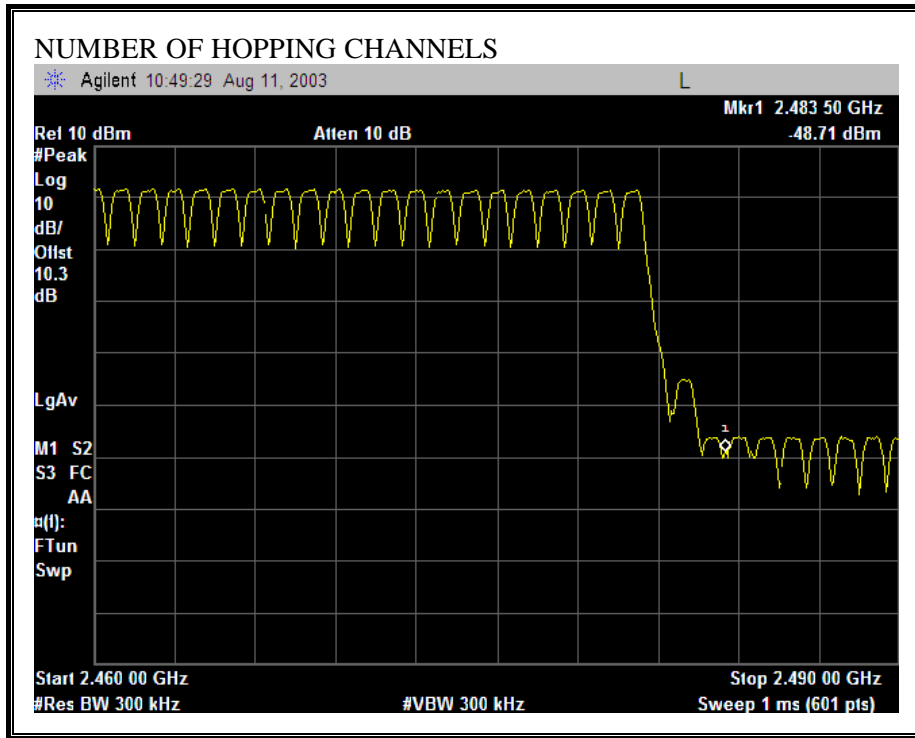

7.8. HOPPING FREQUENCY SEPARATION

LIMIT

§15.247 (a) (1) Frequency hopping systems shall have hopping channel carrier frequencies separated by a minimum of 25 kHz or the 20 dB bandwidth of the hopping channel, whichever is greater.

TEST PROCEDURE

The transmitter output is connected to a spectrum analyzer. The RBW is set to 100 kHz and the VBW is set to 100 kHz. The sweep time is coupled.

RESULTS

No non-compliance noted:

802.11b Mode

Channel	Frequency (MHz)	Channel Separation (kHz)	20dB Bandwidth (kHz)	Margin (kHz)
Middle	2441	1000	940	60

HOPPING FREQUENCY SEPARATION

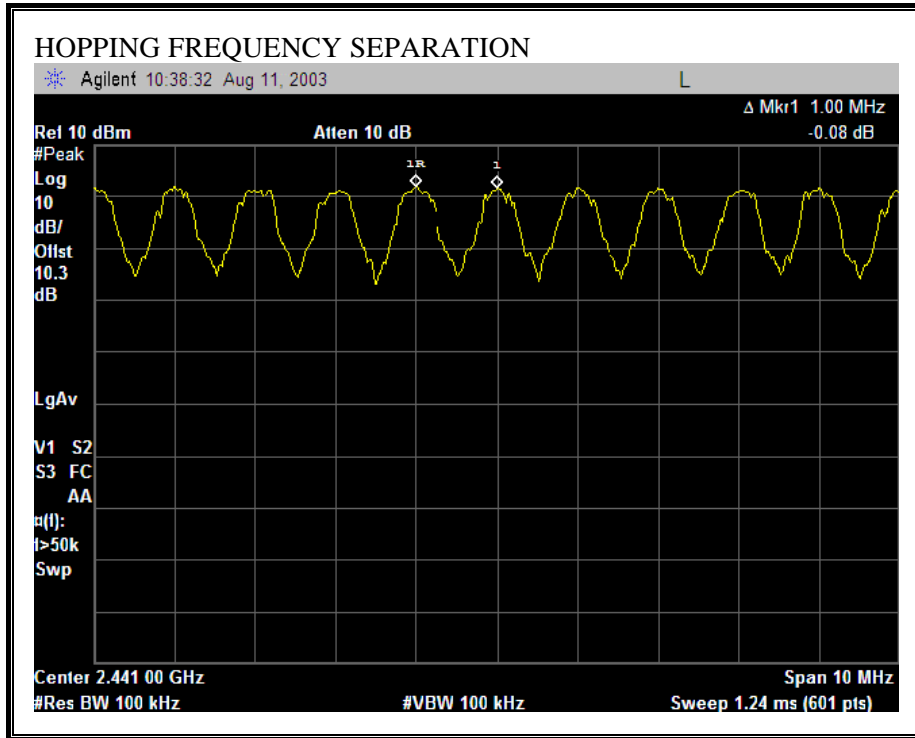

7.9. AVERAGE TIME OF OCCUPANCY

LIMIT

§15.247 (a) (1) (iii) Frequency hopping systems in the 2400 – 2483.5 MHz band shall use at least 15 non-overlapping channels. The average time of occupancy on any channel shall not be greater than 0.4 seconds within a period of 0.4 seconds multiplied by the number of hopping channels employed.

TEST PROCEDURE

The transmitter output is connected to a spectrum analyzer. The span is set to 0 Hz, centered on a single, selected hopping channel. The width of a single pulse is measured in a fast scan. The number of pulses is measured in a slow scan.

RESULTS

No non-compliance noted:

OCCURANCE
3.16 sec
8

OCCURANCE IN 31.6 SECONDS (79 CHANNELS x 0.4 SEC)

8 x 10 = 80 (PULSES IN 31.6 SECONDS)

PULSE WIDTH	PULSES IN	TIME OF	LIMIT	MARGIN
(mS)	31.6 SECONDS	OCCUPANCY	(sec)	(sec)
		(sec)		
2.933	80	0.234	0.400	0.166

PULSE WIDTH

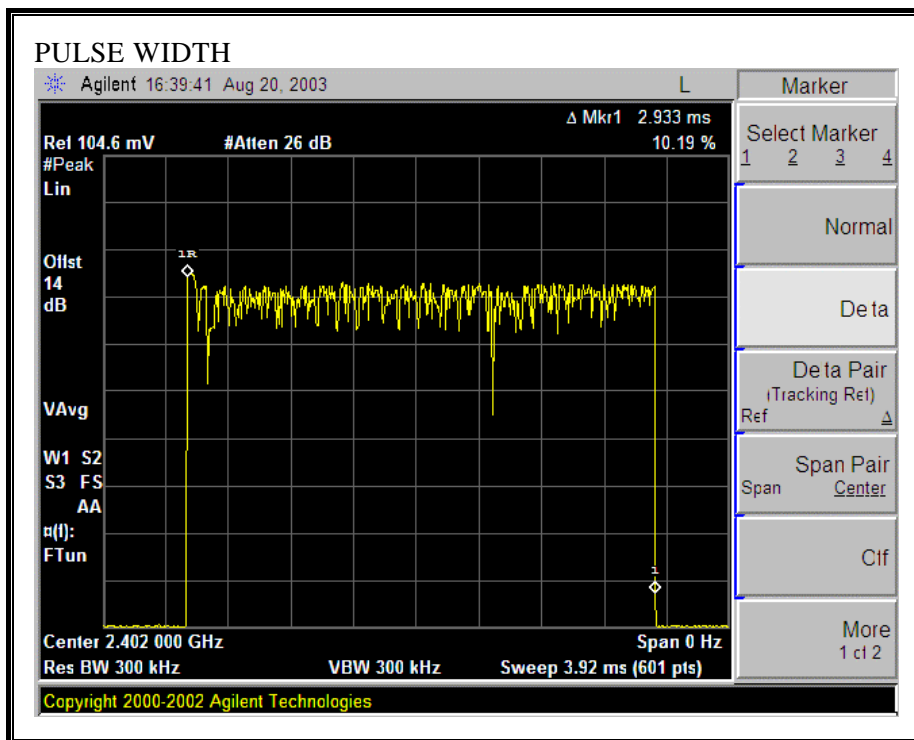

NUMBER OF PULSES

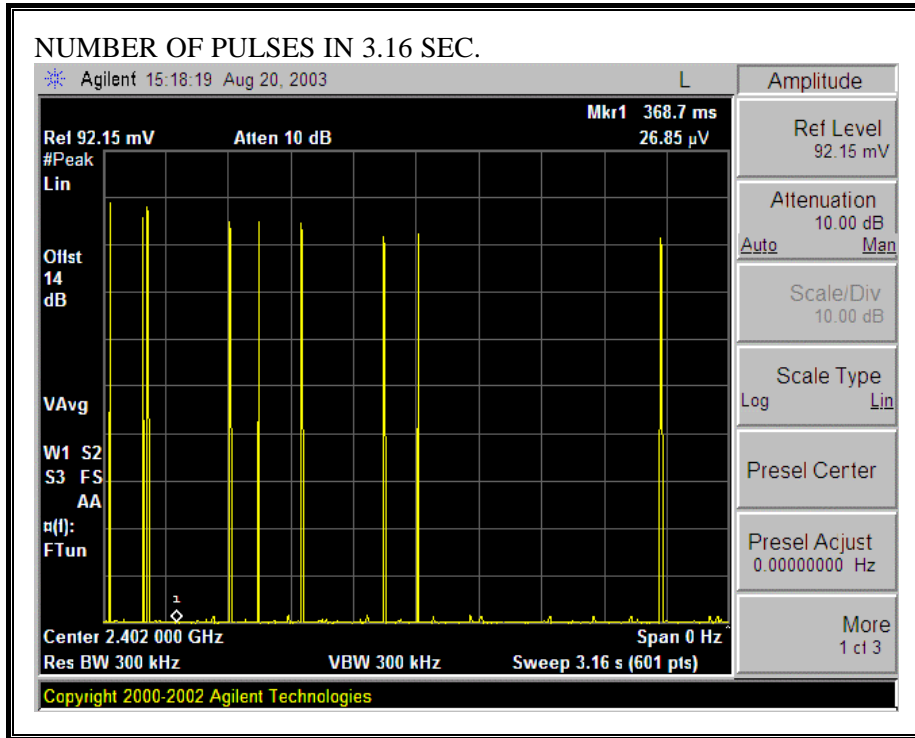

7.10. RADIATED EMISSIONS

LIMITS

§15.205 (a) Except as shown in paragraph (d) of this section, only spurious emissions are permitted in any of the frequency bands listed below:

MHz	MHz	MHz	GHz
0.090 - 0.110	16.42 - 16.423	399.9 - 410	4.5 - 5.15
¹ 0.495 - 0.505	16.69475 - 16.69525	608 - 614	5.35 - 5.46
2.1735 - 2.1905	16.80425 - 16.80475	960 - 1240	7.25 - 7.75
4.125 - 4.128	25.5 - 25.67	1300 - 1427	8.025 - 8.5
4.17725 - 4.17775	37.5 - 38.25	1435 - 1626.5	9.0 - 9.2
4.20725 - 4.20775	73 - 74.6	1645.5 - 1646.5	9.3 - 9.5
6.215 - 6.218	74.8 - 75.2	1660 - 1710	10.6 - 12.7
6.26775 - 6.26825	108 - 121.94	1718.8 - 1722.2	13.25 - 13.4
6.31175 - 6.31225	123 - 138	2200 - 2300	14.47 - 14.5
8.291 - 8.294	149.9 - 150.05	2310 - 2390	15.35 - 16.2
8.362 - 8.366	156.52475 - 156.52525	2483.5 - 2500	17.7 - 21.4
8.37625 - 8.38675	156.7 - 156.9	2655 - 2900	22.01 - 23.12
8.41425 - 8.41475	162.0125 - 167.17	3260 - 3267	23.6 - 24.0
12.29 - 12.293	167.72 - 173.2	3332 - 3339	31.2 - 31.8
12.51975 - 12.52025	240 - 285	3345.8 - 3358	36.43 - 36.5
12.57675 - 12.57725	322 - 335.4	3600 - 4400	(²)
13.36 - 13.41			

¹ Until February 1, 1999, this restricted band shall be 0.490-0.510 MHz.

² Above 38.6

§15.205 (b) Except as provided in paragraphs (d) and (e), the field strength of emissions appearing within these frequency bands shall not exceed the limits shown in Section 15.209. At frequencies equal to or less than 1000 MHz, compliance with the limits in Section 15.209 shall be demonstrated using measurement instrumentation employing a CISPR quasi-peak detector. Above 1000 MHz, compliance with the emission limits in Section 15.209 shall be demonstrated based on the average value of the measured emissions. The provisions in Section 15.35 apply to these measurements.

§15.209 (a) Except as provided elsewhere in this Subpart, the emissions from an intentional radiator shall not exceed the field strength levels specified in the following table:

Frequency (MHz)	Field Strength (microvolts/meter)	Measurement Distance (meters)
30 - 88	100 **	3
88 - 216	150 **	3
216 - 960	200 **	3
Above 960	500	3

** Except as provided in paragraph (g), fundamental emissions from intentional radiators operating under this Section shall not be located in the frequency bands 54-72 MHz, 76-88 MHz, 174-216 MHz or 470-806 MHz. However, operation within these frequency bands is permitted under other sections of this Part, e.g., Sections 15.231 and 15.241.

§15.209 (b) In the emission table above, the tighter limit applies at the band edges.

TEST PROCEDURE

The EUT is placed on a non-conducting table 80 cm above the ground plane. The antenna to EUT distance is 3 meters. The EUT is configured in accordance with ANSI C63.4. The EUT is set to transmit in a continuous mode.

For measurements below 1 GHz the resolution bandwidth is set to 100 kHz for peak detection measurements or 120 kHz for quasi-peak detection measurements. Peak detection is used unless otherwise noted as quasi-peak.

For measurements above 1 GHz the resolution bandwidth is set to 1 MHz, then the video bandwidth is set to 1 MHz for peak measurements and 10 Hz for average measurements.

The spectrum from 30 MHz to 26 GHz is investigated with the transmitter set to the lowest, middle, and highest channels.

The frequency range of interest is monitored at a fixed antenna height and EUT azimuth. The EUT is rotated through 360 degrees to maximize emissions received. The antenna is scanned from 1 to 4 meters above the ground plane to further maximize the emission. Measurements are made with the antenna polarized in both the vertical and the horizontal positions.

RESULTS

No non-compliance noted:

RESTRICTED BANDEDGE (LOW CHANNEL, HORIZONTAL)

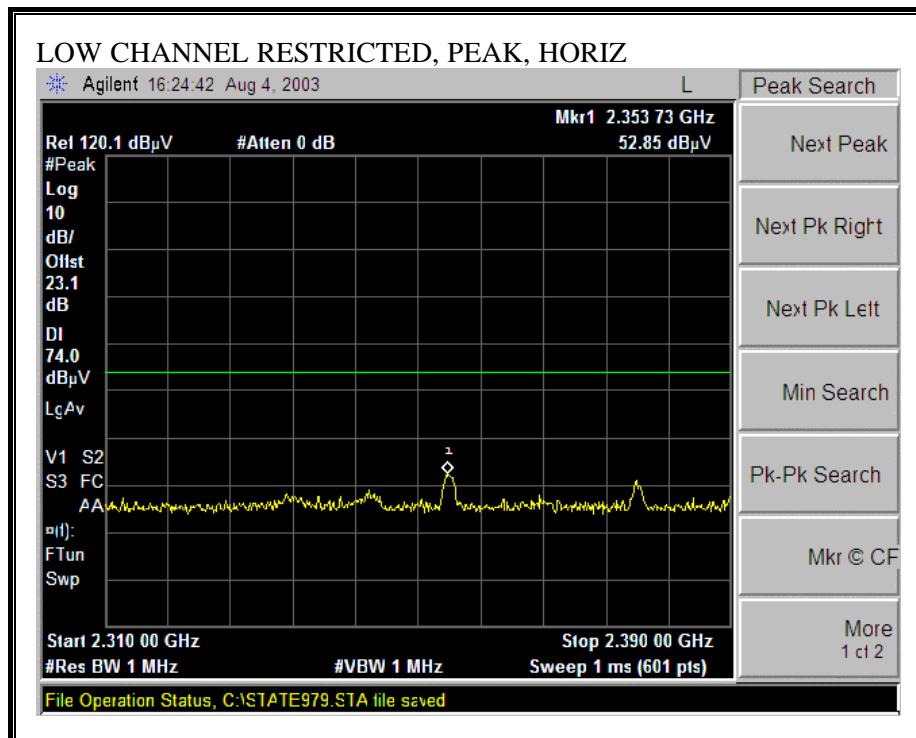

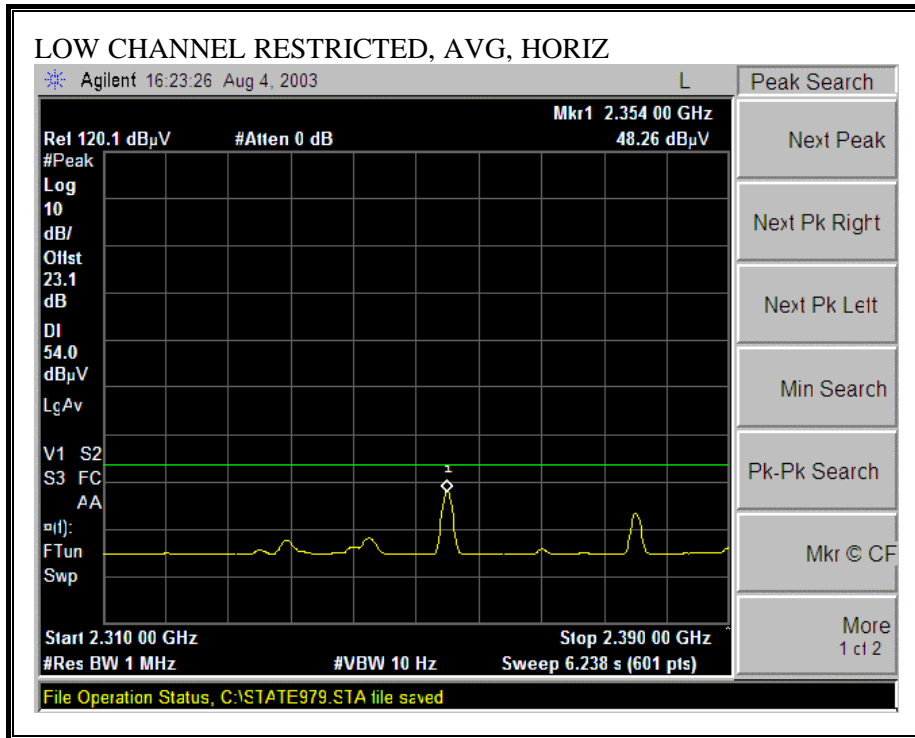

RESTRICTED BANDEDGE (LOW CHANNEL, VERTICAL)

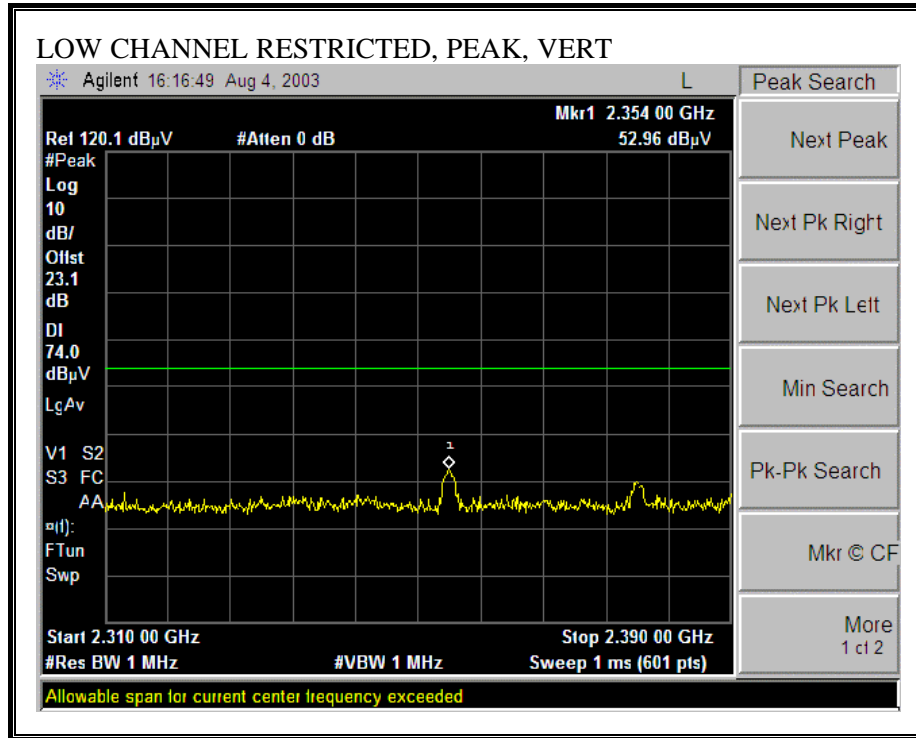

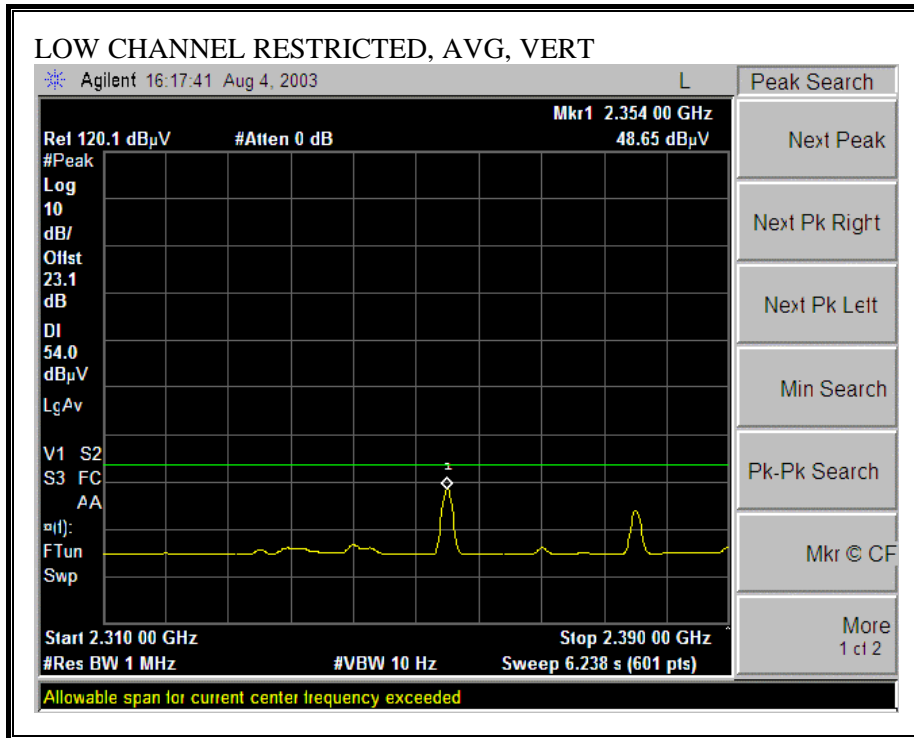

RESTRICTED BANDEDGE (HIGH CHANNEL, HORIZONTAL)

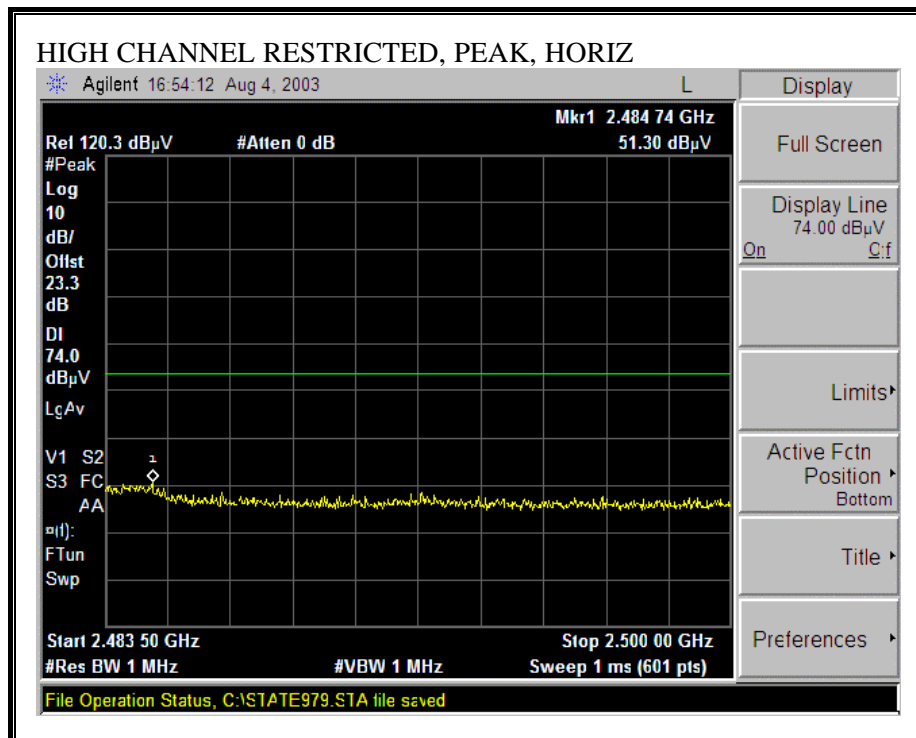

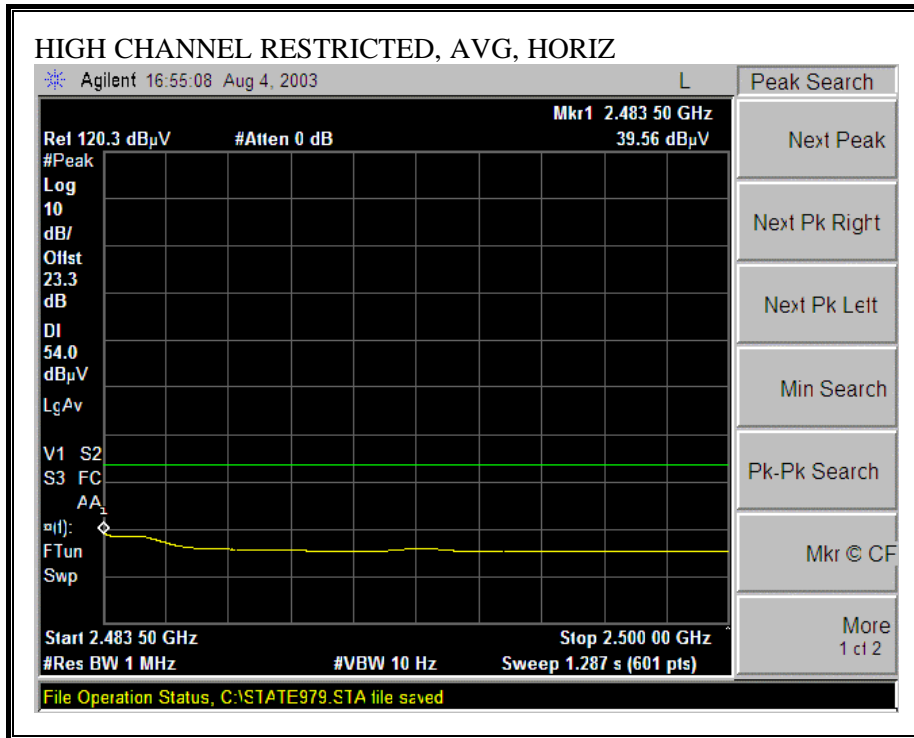

RESTRICTED BANDEDGE (HIGH CHANNEL, VERTICAL)

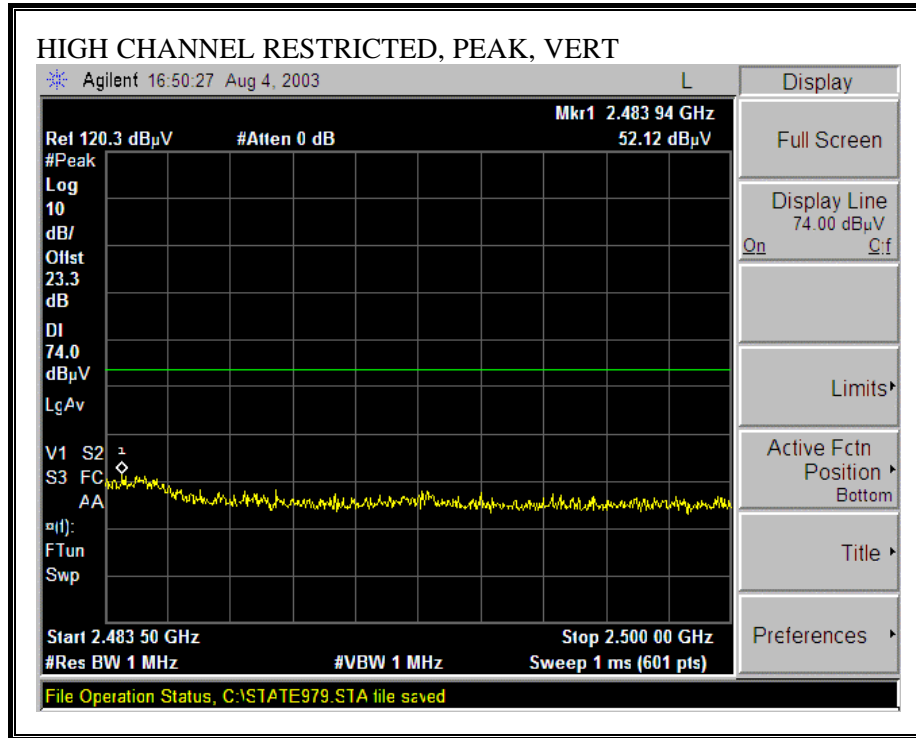

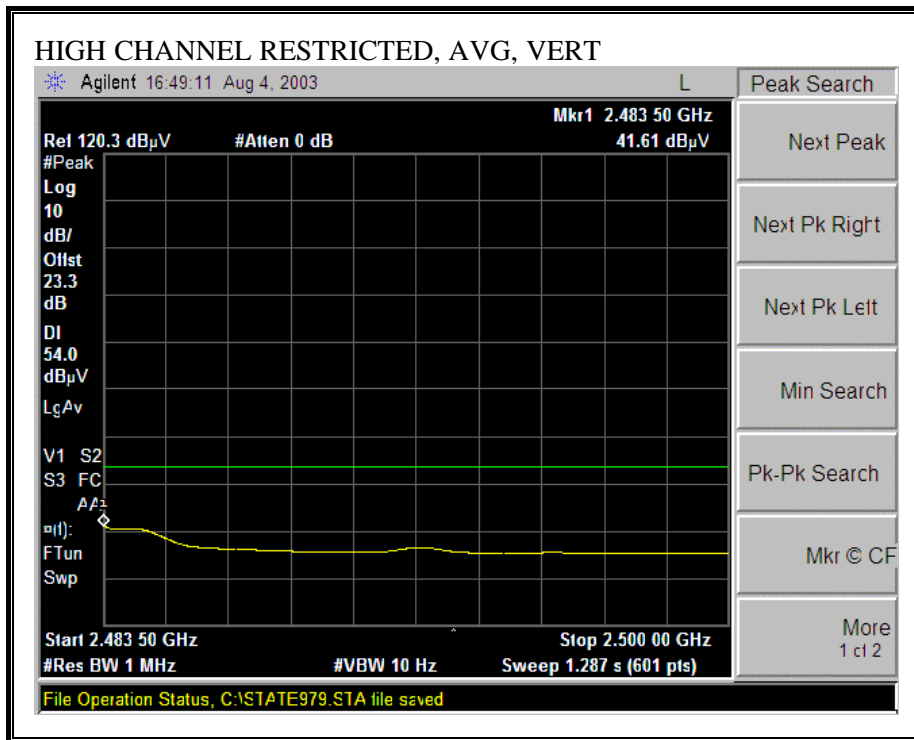

DUTY CYCLE CORRECTION FACTOR

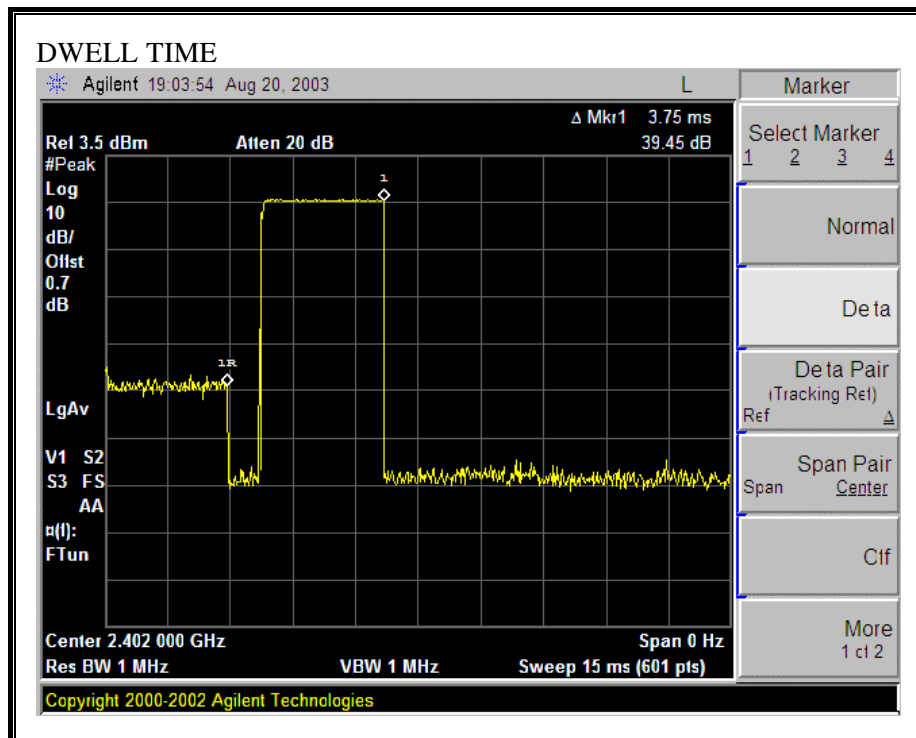

*IN ACCORDANCE WITH FCC PUBLIC NOTICE DA-00-705, THE “DUTY CYCLE CORRECTION FACTOR” FOR SPURIOUS RADIATED EMISSIONS IS; $20 \log * (3.75 \text{ ms} / 100 \text{ ms}) = -28.5 \text{ dB}$, WHICH WAS USED TO CORRECT THE AVERAGE SPURIOUS READING.

HARMONICS AND SPURIOUS EMISSIONS (LOW, MIDDLE, AND HIGH CHANNELS)

080403 High Frequency Measurement
 Compliance Certification Services, Morgan Hill Open Field Site

Test Eng: NEELISH RAJ
 Project #: 03U2092-1
 Company: BROADCOM CORP
 EUT Descr: BLUETOOTH DONGLE
 EUT M/N: BCM9201S8TSD
 Test Target: FCC
 Mode Oper: TX (power @ +3dBm all channels)

Test Equipment:

EMCO Horn 1-18GHz T60; S/N: 2238 @3m	Pre-amplifier 1-26GHz T63 Miniq 646456	Spectrum Analyzer psa	Horn > 18GHz T87; ARA 18-26GHz; S/N:1049	Limit FCC 15.205
---	---	--------------------------	---	---------------------

High Frequency Cables:
 (2 ft) (2 ~ 3 ft) (4 ~ 6 ft) (12 ft)

Peak Measurements: 1 MHz Resolution Bandwidth, 1 MHz Video Bandwidth
 Average Measurements: 1 MHz Resolution Bandwidth, 10 Hz Video Bandwidth

f GHz	Dist feet	Raw Pk dBuV	Raw Avg dBuV	AF dB/m	CL dB	Amp dB	D Corr dB	HPF	Peak dBuV/m	Avg dBuV/m	Pk Lim dBuV/m	Avg Lim dBuV/m	Pk Mar dB	Avg Mar dB	Notes
HIGH CHANNEL															
4.960	9.8	54.4	51.9	33.2	3.0	-35.3	0.0	1.0	56.2	25.2	74.0	54.0	-17.8	-28.8	Y
4.960	9.8	50.6	48.9	33.2	3.0	-35.3	0.0	1.0	52.5	22.3	74.0	54.0	-21.5	-31.7	H
7.439	9.8	45.3	41.5	36.4	3.8	-34.5	0.0	1.0	52.0	19.7	74.0	54.0	-22.0	-34.3	Y
7.439	9.8	44.3	40.5	36.4	3.8	-34.5	0.0	1.0	51.0	18.7	74.0	54.0	-23.0	-35.3	H
MIDDLE CHANNEL															
4.882	9.8	53.9	51.8	33.2	3.0	-35.3	0.0	1.0	55.7	25.1	74.0	54.0	-18.3	-28.9	Y
4.882	9.8	50.7	49.2	33.2	3.0	-35.3	0.0	1.0	52.5	22.5	74.0	54.0	-21.5	-31.5	H
7.323	9.8	44.3	40.2	36.2	3.8	-34.6	0.0	1.0	50.7	18.1	74.0	54.0	-23.3	-35.9	Y
7.323	9.8	45.7	41.3	36.2	3.8	-34.6	0.0	1.0	52.1	19.2	74.0	54.0	-21.9	-34.8	H
LOW CHANNEL															
4.802	9.8	54.2	51.8	33.1	2.9	-35.3	0.0	1.0	55.9	25.0	74.0	54.0	-18.1	-29.0	Y
4.802	9.8	50.8	49.0	33.1	2.9	-35.3	0.0	1.0	52.5	22.2	74.0	54.0	-21.5	-31.8	H
12.010	9.8	43.7	34.0	39.3	5.1	-34.9	0.0	1.0	54.2	16.0	74.0	54.0	-19.8	-38.0	Y
12.010	9.8	44.0	34.1	39.3	5.1	-34.9	0.0	1.0	54.5	16.1	74.0	54.0	-19.5	-37.9	H
NO OTHER SPURIOUS EMISSIONS DETECTED WITHIN THE RESTRICTED BANDS ABOVE -20DB OF THE LIMIT															
NOTE: AVERAGE FIELD STRENGTH INCLUDES DUTY CYCLE CORRECTION FACTOR OF -28.54dB															

f	Measurement Frequency	Amp	Preamp Gain	Avg Lim	Average Field Strength Limit
Dist	Distance to Antenna	D Corr	Distance Correct to 3 meters	Pk Lim	Peak Field Strength Limit
Read	Analyzer Reading	Avg	Average Field Strength @ 3 m	Avg Mar	Margin vs. Average Limit
AF	Antenna Factor	Peak	Calculated Peak Field Strength	Pk Mar	Margin vs. Peak Limit
CL	Cable Loss	HPF	High Pass Filter		

SPURIOUS EMISSIONS 30 TO 230 MHz (WORST-CASE CONFIGURATION; VERTICAL)

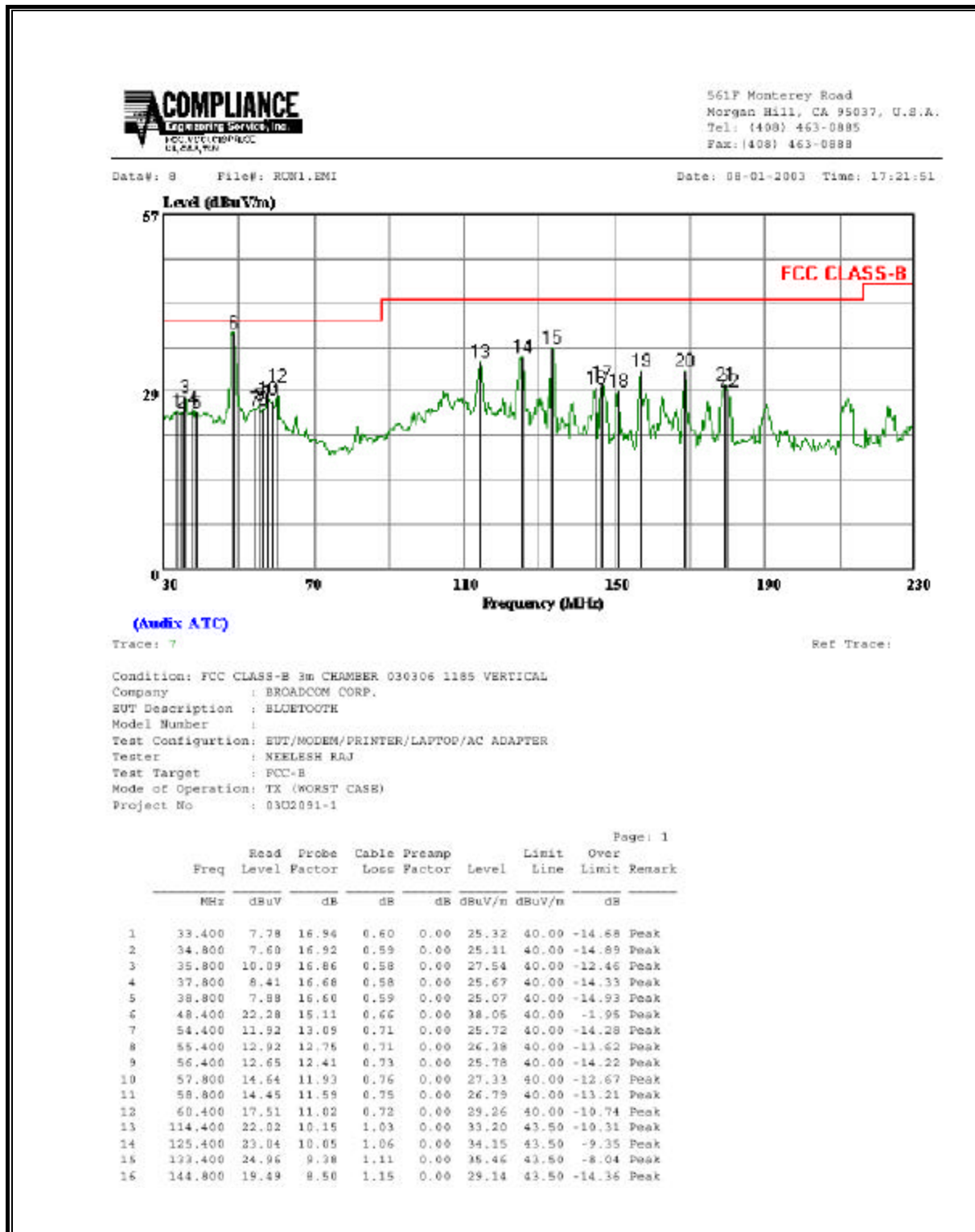

SPURIOUS EMISSIONS 30 TO 230 MHz (WORST-CASE CONFIGURATION; VERTICAL)

Data#:		File#:		Date:		Time:		Page:	
0		R0M1.EMI		08-01-2003		17:21:51		2	
Freq	Read Level	Probe Factor	Cable Loss	Preamp Factor	Level	Limit Line	Over Limit	Remark	
MHz	dBuV	dB	dB	dB	dBuV/m	dBuV/n	dB		
17	146.800	20.25	8.37	1.19	0.00	29.80	43.50	-13.70	Peak
18	150.800	19.35	8.19	1.19	0.00	28.73	43.50	-14.77	Peak
19	156.800	22.01	8.48	1.24	0.00	31.73	43.50	-11.77	Peak
20	168.800	21.85	8.80	1.28	0.00	31.94	43.50	-11.56	Peak
21	179.400	19.78	8.58	1.31	0.00	29.67	43.50	-13.83	Peak
22	180.400	18.75	8.60	1.32	0.00	28.67	43.50	-14.83	Peak

SPURIOUS EMISSIONS 230-1000 MHz (WORST-CASE CONFIGURATION; VERTICAL)

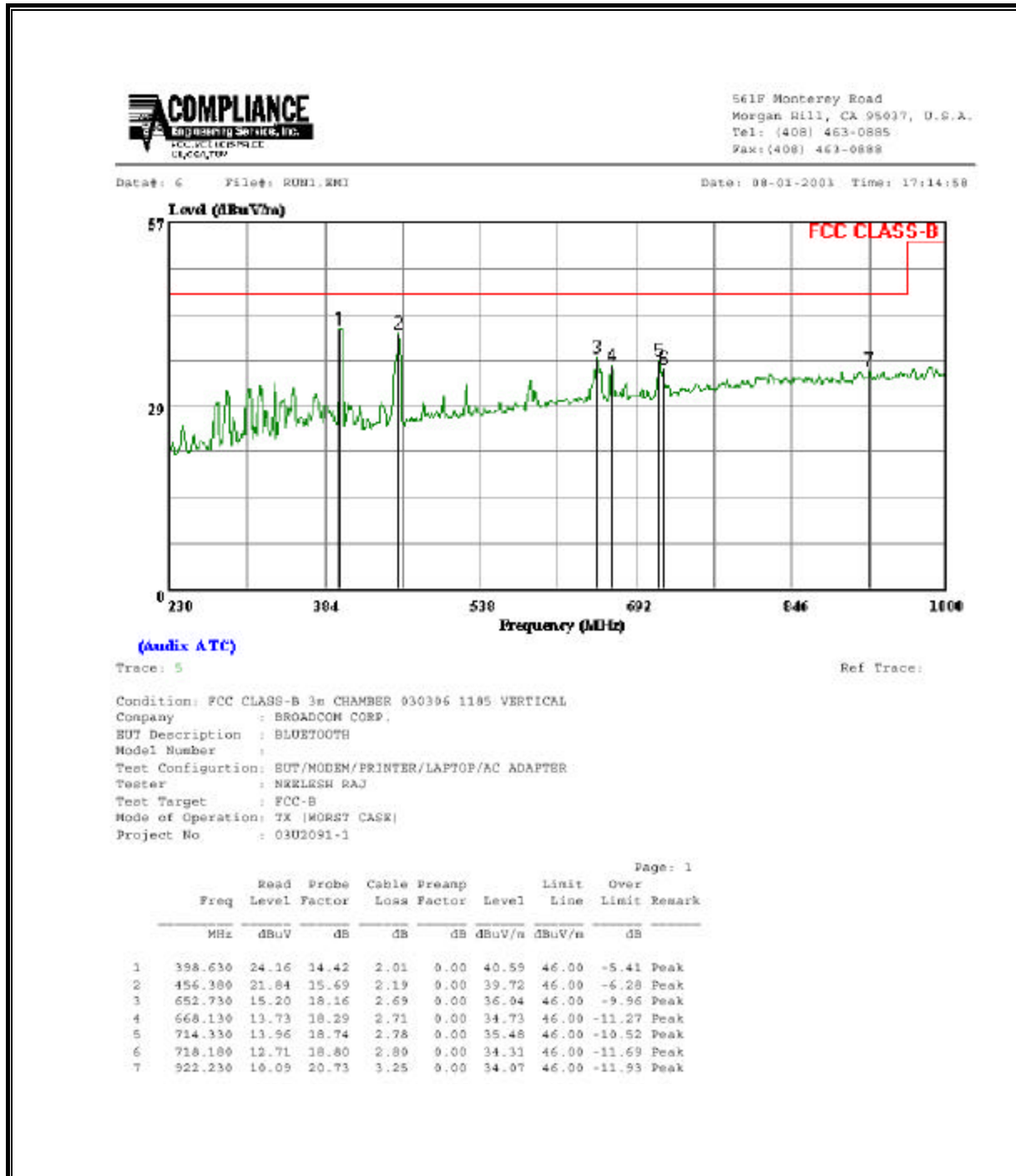

SPURIOUS EMISSIONS 30 TO 230 MHz (WORST-CASE CONFIGURATION; HORIZONTAL)

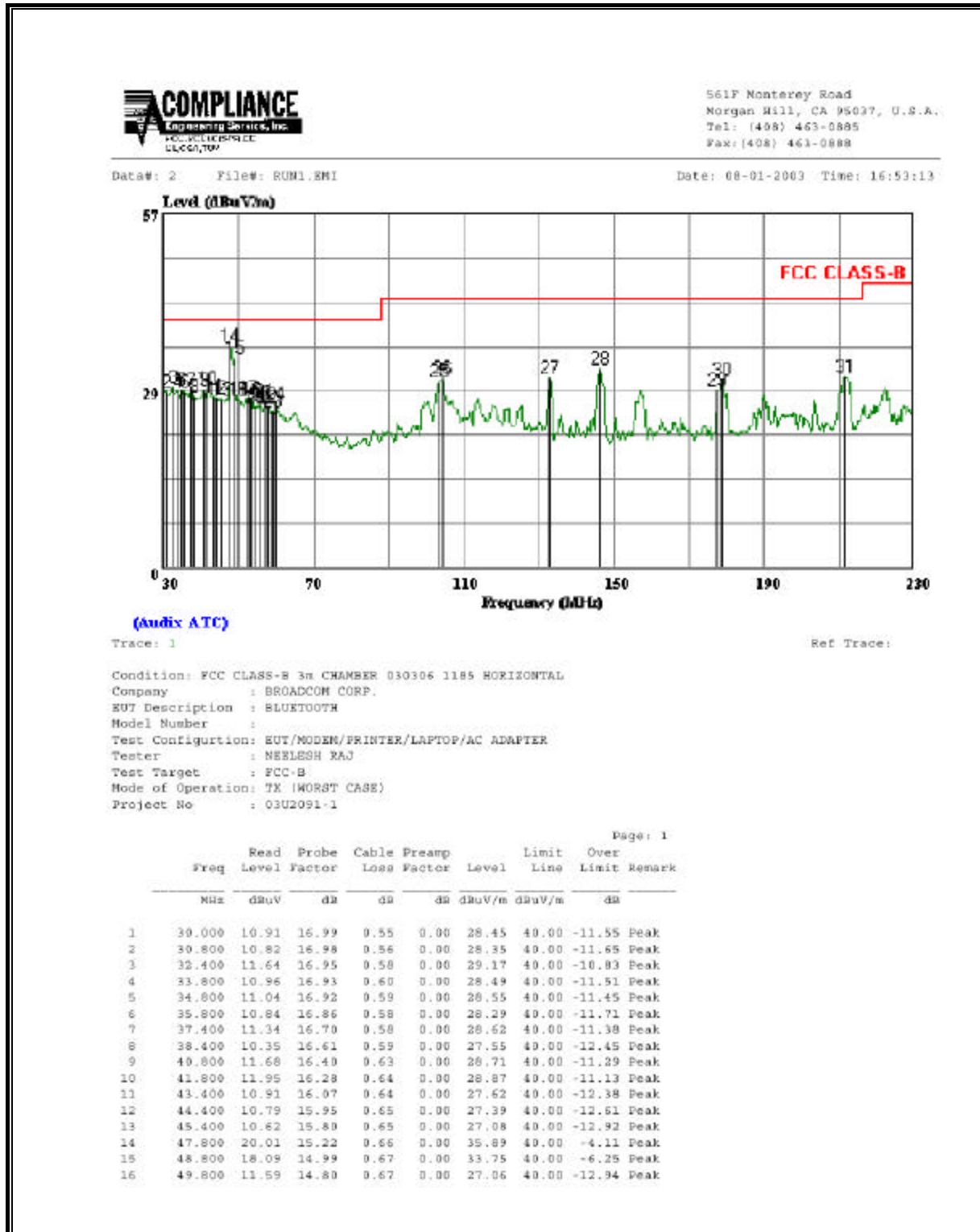

SPURIOUS EMISSIONS 30 TO 230 MHz (WORST-CASE CONFIGURATION; HORIZONTAL)

Data#:		File#:		Date:		Time:		Page:	
Freq	Read Level	Probe Factor	Cable Loss	Preamp Factor	Level	Limit Line	Over Limit	Remark	
MHz	dBuV	dB	dB	dB	dBuV/m	dBuV/m	dB		
17	52.400	12.87	13.84	0.70	0.00	27.41	40.00	-12.59	Peak
18	53.400	12.94	13.49	0.71	0.00	27.14	40.00	-12.86	Peak
19	54.400	12.17	13.09	0.71	0.00	25.97	40.00	-14.03	Peak
20	55.400	12.99	12.75	0.71	0.00	26.45	40.00	-13.55	Peak
21	56.800	13.87	12.27	0.74	0.00	26.87	40.00	-13.13	Peak
22	57.800	13.21	11.93	0.76	0.00	25.90	40.00	-14.10	Peak
23	58.800	12.81	11.69	0.75	0.00	25.15	40.00	-14.85	Peak
24	59.800	14.39	11.25	0.73	0.00	26.37	40.00	-13.63	Peak
25	103.400	19.99	9.17	0.98	0.00	30.15	43.50	-13.35	Peak
26	104.400	20.24	9.28	1.01	0.00	30.53	43.50	-12.98	Peak
27	132.800	19.99	9.42	1.10	0.00	30.51	43.50	-12.99	Peak
28	146.400	22.94	8.40	1.17	0.00	32.12	43.50	-11.38	Peak
29	177.400	18.57	8.73	1.30	0.00	28.60	43.50	-14.90	Peak
30	178.800	20.36	8.63	1.30	0.00	30.29	43.50	-13.21	Peak
31	211.400	19.68	9.69	1.42	0.00	30.80	43.50	-12.70	Peak

SPURIOUS EMISSIONS 230-1000 MHz (WORST-CASE CONFIGURATION; HORIZONTAL)

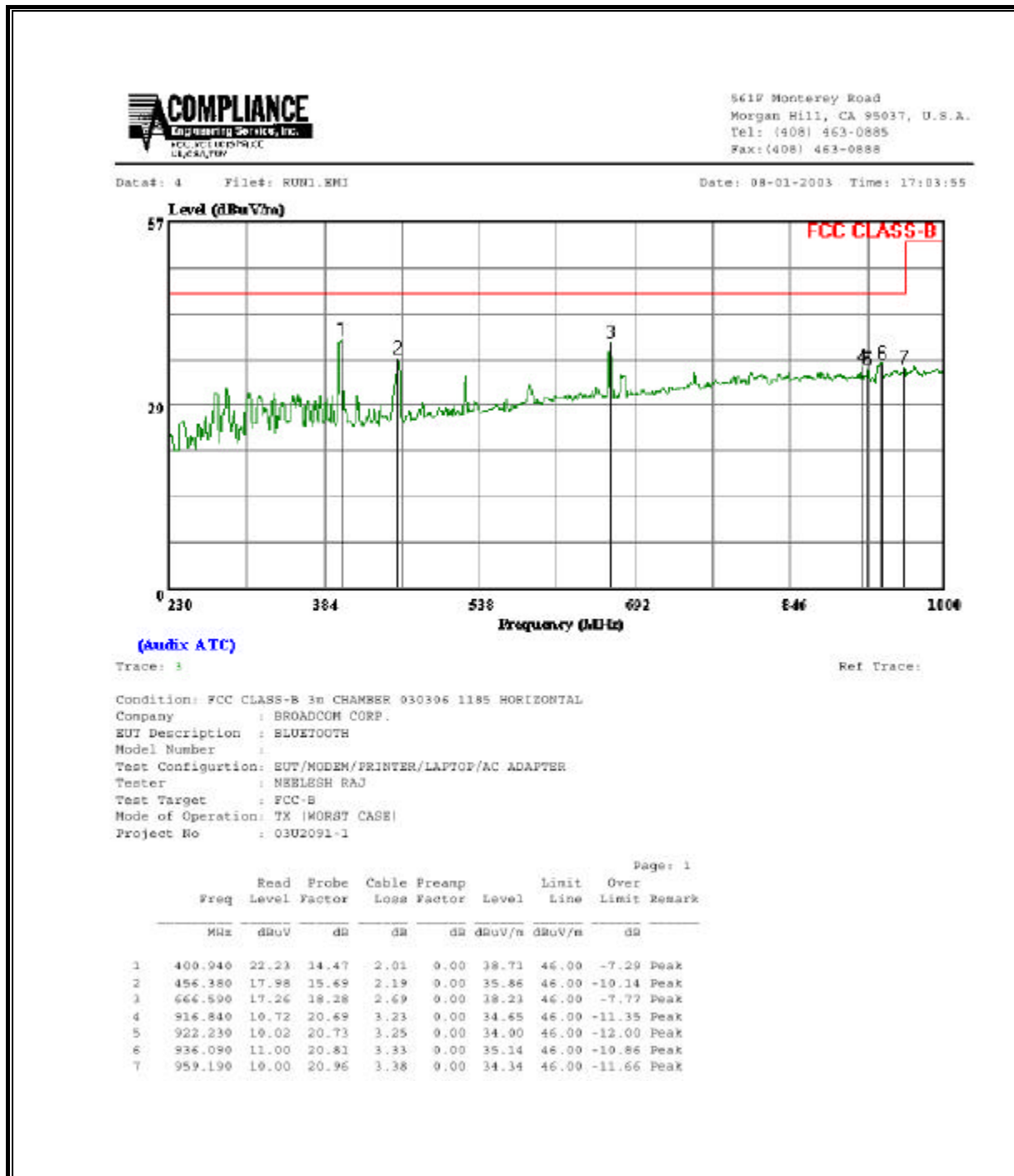

7.11. POWERLINE CONDUCTED EMISSIONS

LIMIT

§15.207 (a) Except as shown in paragraphs (b) and (c) of this section, for an intentional radiator that is designed to be connected to the public utility (AC) power line, the radio frequency voltage that is conducted back onto the AC power line on any frequency or frequencies within the band 150 kHz to 30 MHz shall not exceed the limits in the following table, as measured using a 50 μ H/50 ohms line impedance stabilization network (LISN). Compliance with the provisions of this paragraph shall be based on the measurement of the radio frequency voltage between each power line and ground at the power terminal.

The lower limit applies at the boundary between the frequency ranges.

Frequency of Emission (MHz)	Conducted Limit (dBuV)	
	Quasi-peak	Average
0.15-0.5	66 to 56*	56 to 46*
0.5-5	56	46
5-30	60	50

*Decreases with the logarithm of the frequency.

TEST PROCEDURE

The EUT is placed on a non-conducting table 40 cm from the vertical ground plane and 80 cm above the horizontal ground plane. The EUT is configured in accordance with ANSI C63.4.

The resolution bandwidth is set to 9 kHz for both peak detection and quasi-peak detection measurements. Peak detection is used unless otherwise noted as quasi-peak.

Line conducted data is recorded for both NEUTRAL and HOT lines.

RESULTS

No non-compliance noted:

6 WORST EMISSIONS

CONDUCTED EMISSIONS DATA (115VAC 60Hz)									
Freq.	Reading			Closs	Limit	EN B	Margin		Remark
(MHz)	PK (dBuV)	QP (dBuV)	AV (dBuV)	(dB)	QP	AV	QP (dB)	AV (dB)	L1 / L2
0.15	54.80	--	17.94	0.00	66.00	56.00	-11.20	-38.06	L1
0.19	51.09	--	29.79	0.00	64.97	54.97	-13.88	-25.18	L1
0.21	49.78	--	37.65	0.00	64.34	54.34	-14.56	-16.69	L1
0.15	54.74	--	17.02	0.00	65.94	55.94	-11.20	-38.92	L2
0.19	52.88	--	36.90	0.00	64.83	54.83	-11.95	-17.93	L2
0.21	51.24	--	37.09	0.00	64.31	54.31	-13.07	-17.22	L2
6 Worst Data									

LINE 1 RESULTS

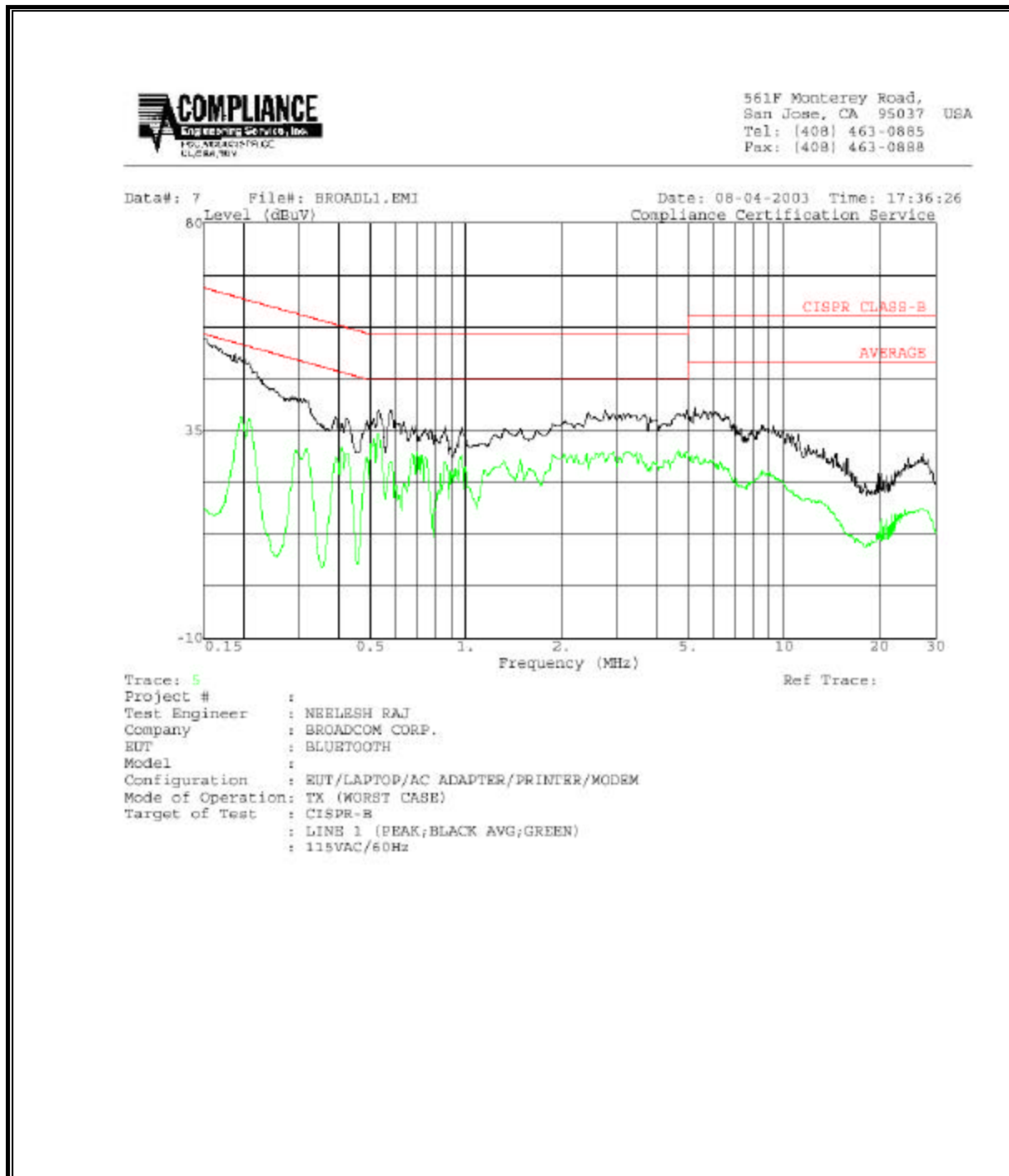

LINE 2 RESULTS

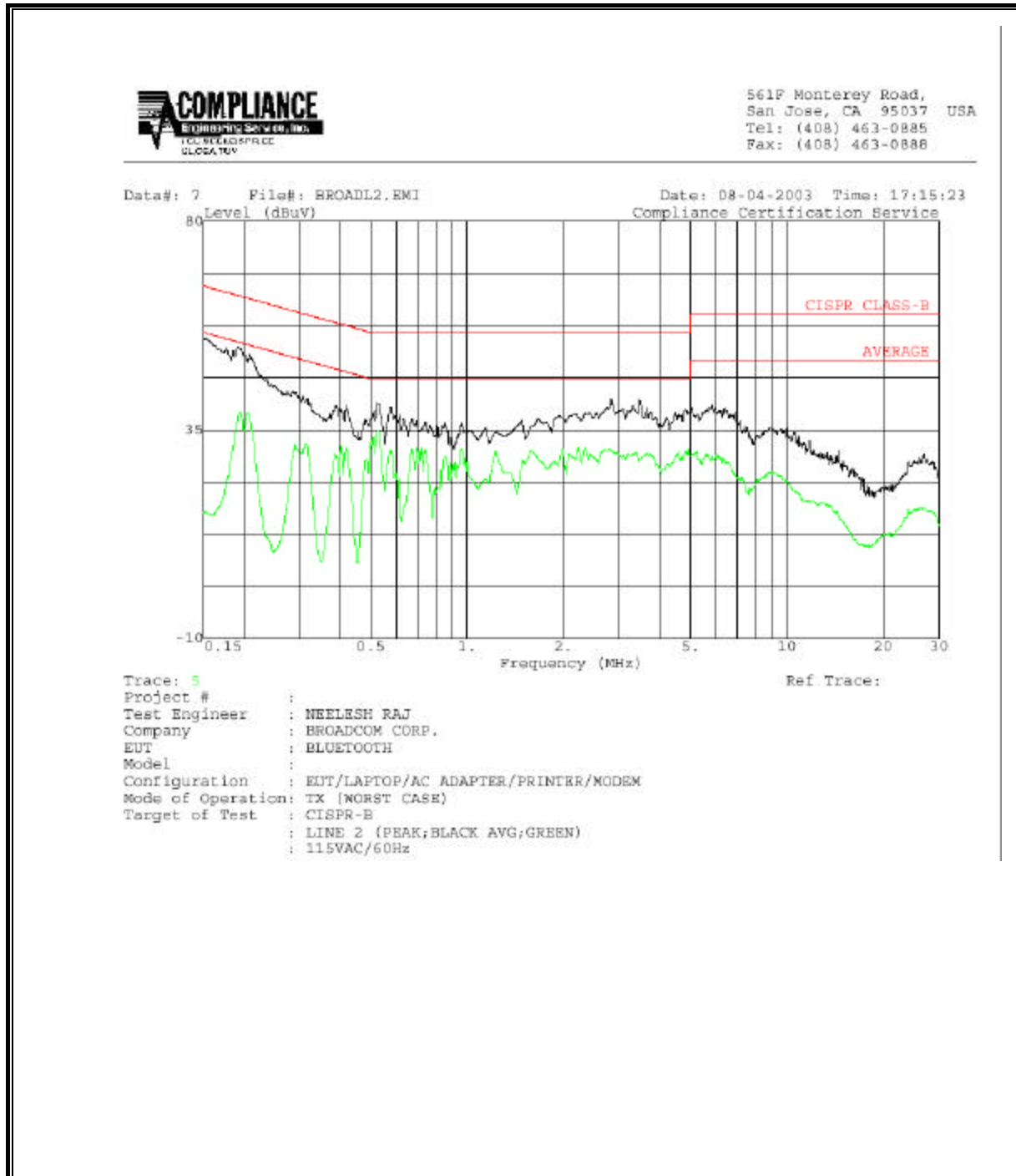

8. SETUP PHOTOS

ANTENNA PORT CONDUCTED RF MEASUREMENT SETUP

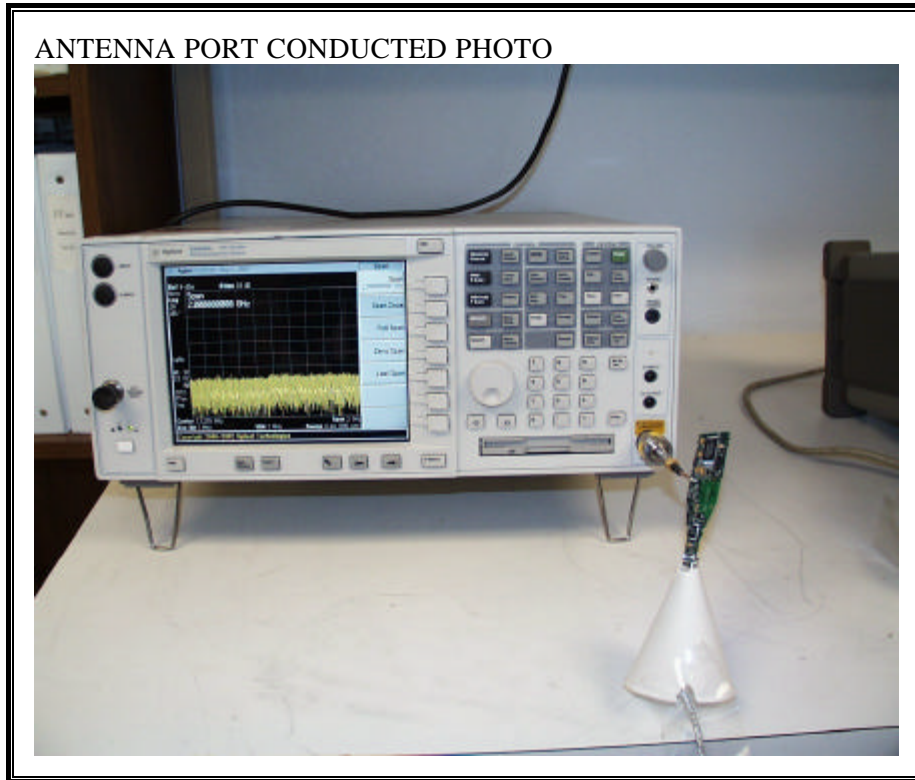

RADIATED RF MEASUREMENT SETUP

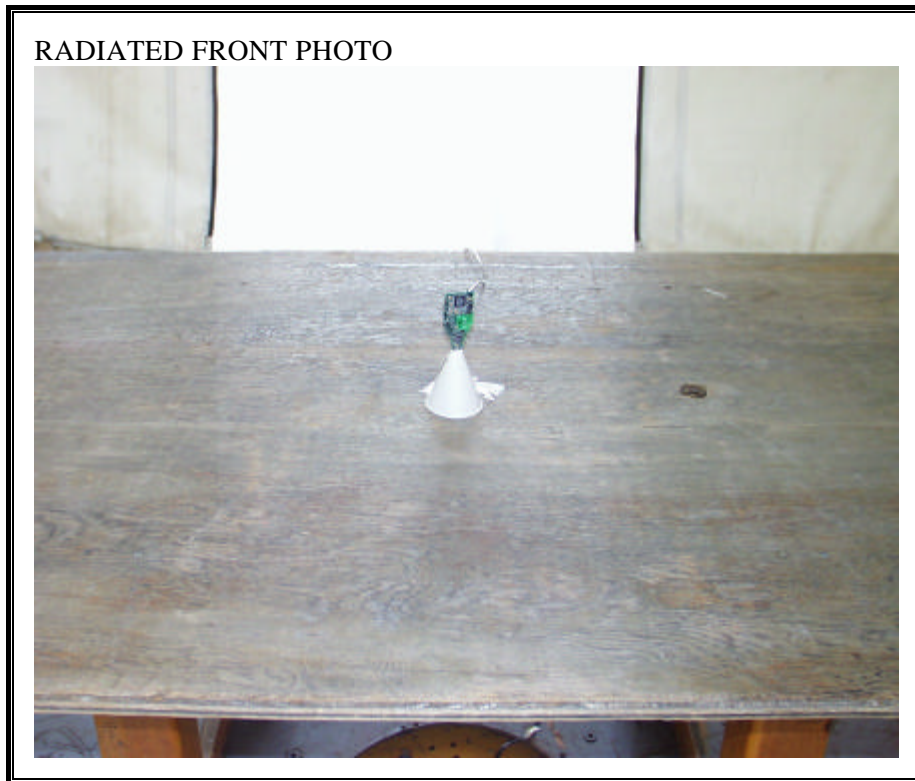

DIGITAL DEVICE RADIATED EMISSIONS SETUP

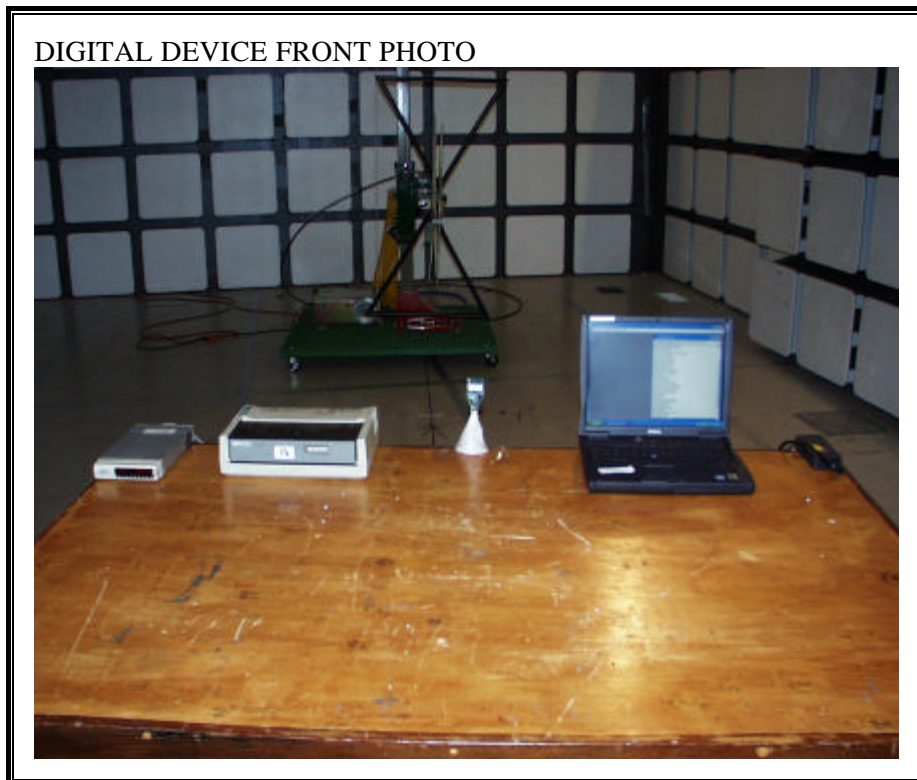

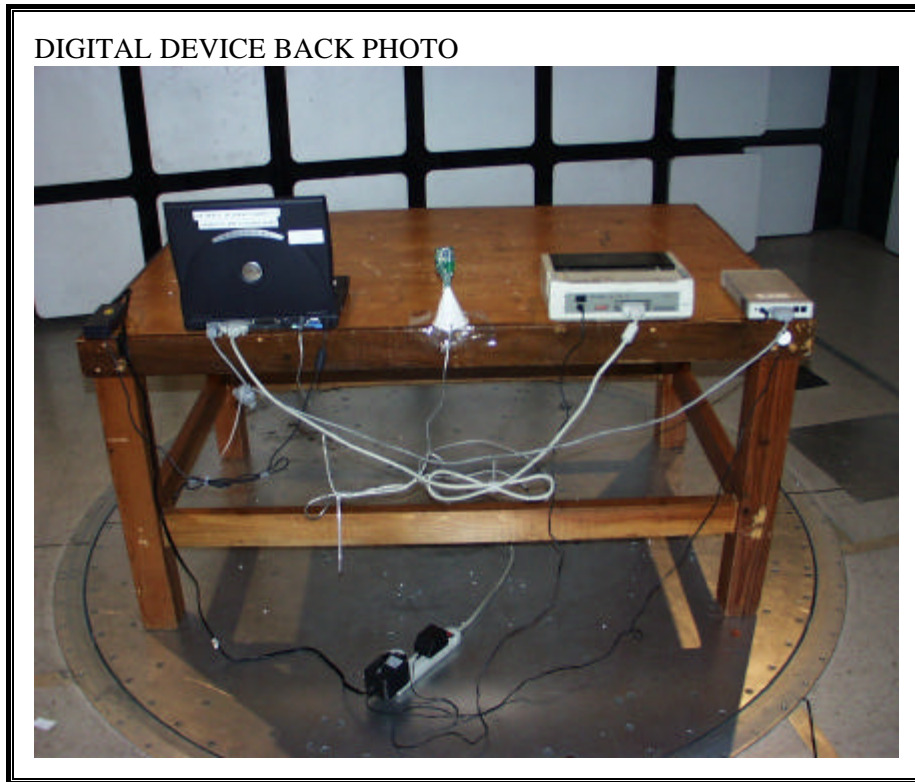

POWERLINE CONDUCTED EMISSIONS MEASUREMENT SETUP

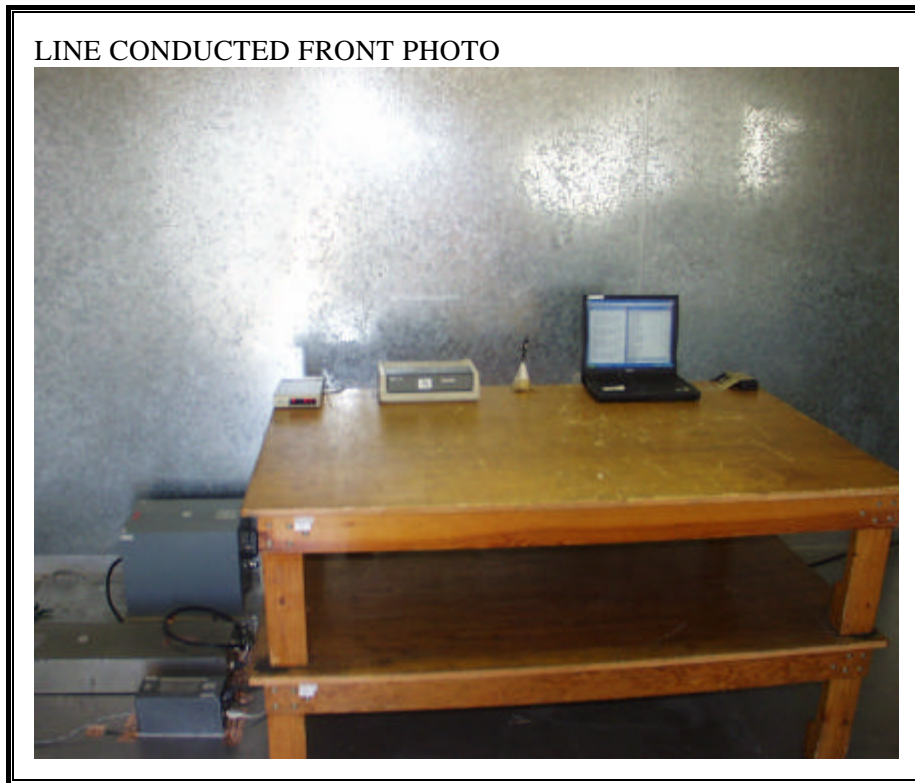

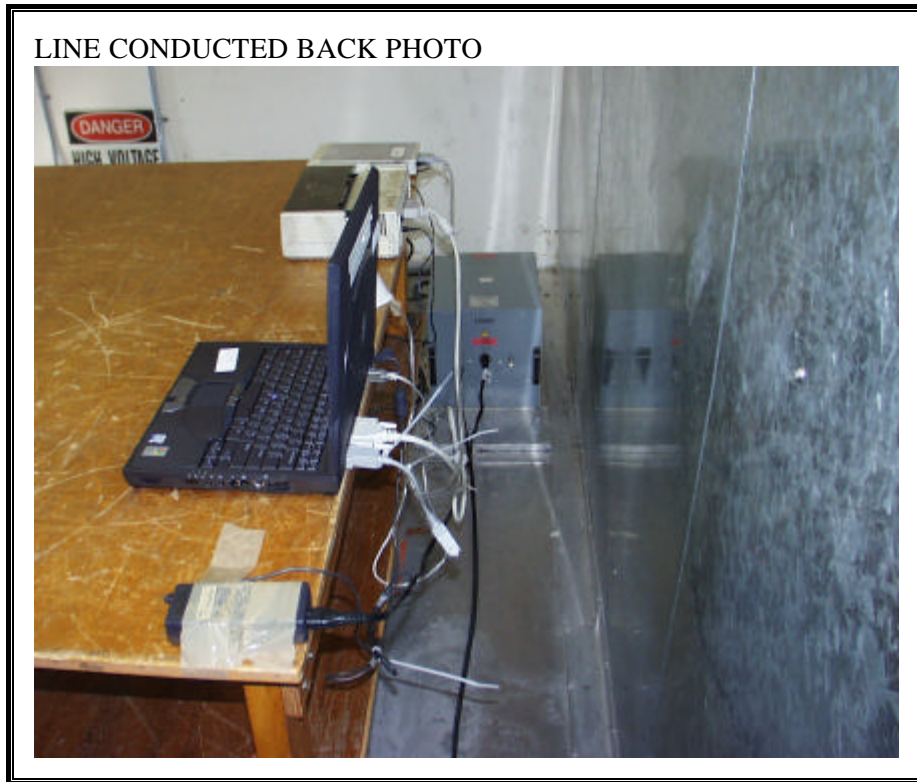

END OF REPORT