



Shenzhen CTL Testing Technology Co., Ltd.
Tel: +86-755-89486194 Fax: +86-755-26636041

FCC PART 15 SUBPART C TEST REPORT

Report Reference No.: CTL1508042163-WF

Compiled by:
(position+printed name+signature)

Happy Guo
(File administrators)

Happy Guo

Tested by:
(position+printed name+signature)

Nice Nong
(Test Engineer)

Nice Nong

Approved by:
(position+printed name+signature)

Tracy Qi
(Manager)

Tracy Qi

Product Name.....: Bluetooth Transmitter

Model/Type reference.....: BT06-T

Trade Mark.....: W-king

FCC ID.....: Q8W-BT06-T

Applicant's name.....: **SHENZHEN WEIKING TECHNOLOGY CO.,LTD**

Address of applicant.....: W-king Technology Park, NO.431, Huating Road, Dalang Street, Longhua Town, Baoan District, Shenzhen City, China

Test Firm.....: **Shenzhen CTL Testing Technology Co., Ltd.**

Address of Test Firm.....: Floor 1-A, Baisha Technology Park, No.3011, Shahexi Road, Nanshan District, Shenzhen, China 518055

Test specification.....:

Standard.....: **FCC Part 15.249:** Operation within the bands 920-928 MHz, 2400-2483.5 MHz, 5725-5850 MHz and 24.0 - 24.25 GHz.

TRF Originator.....: Shenzhen CTL Testing Technology Co., Ltd.

Master TRF.....: Dated 2011-01

Date of Receipt.....: Aug. 04, 2015

Date of Test Date.....: Aug. 04, 2015 - Aug. 11, 2015

Data of Issue.....: Aug. 11, 2015

Result.....: Positive

Shenzhen CTL Testing Technology Co., Ltd. All rights reserved.

This publication may be reproduced in whole or in part for non-commercial purposes as long as the Shenzhen CTL Testing Technology Co., Ltd. is acknowledged as copyright owner and source of the material. Shenzhen CTL Testing Technology Co., Ltd. takes no responsibility for and will not assume liability for damages resulting from the reader's interpretation of the reproduced material due to its placement and context.

TEST REPORT

Test Report No. :	CTL1508042163-WF	Aug. 11, 2015
		Date of issue

Equipment under Test : Bluetooth Transmitter

Model /Type : BT06-T

Applicant : **SHENZHEN WEIKING TECHNOLOGY CO.,LTD**

Address : W-king Technology Park, NO.431, Huating Road, Dalang Street, Longhua Town, Baoan District, Shenzhen City, China

Manufacturer : **SHENZHEN WEIKING TECHNOLOGY CO.,LTD**

Address : W-king Technology Park, NO.431, Huating Road, Dalang Street, Longhua Town, Baoan District, Shenzhen City, China

Test Result according to the standards on page 4:	Positive
--	-----------------

The test report merely corresponds to the test sample.
It is not permitted to copy extracts of these test result without the written permission of the test laboratory.

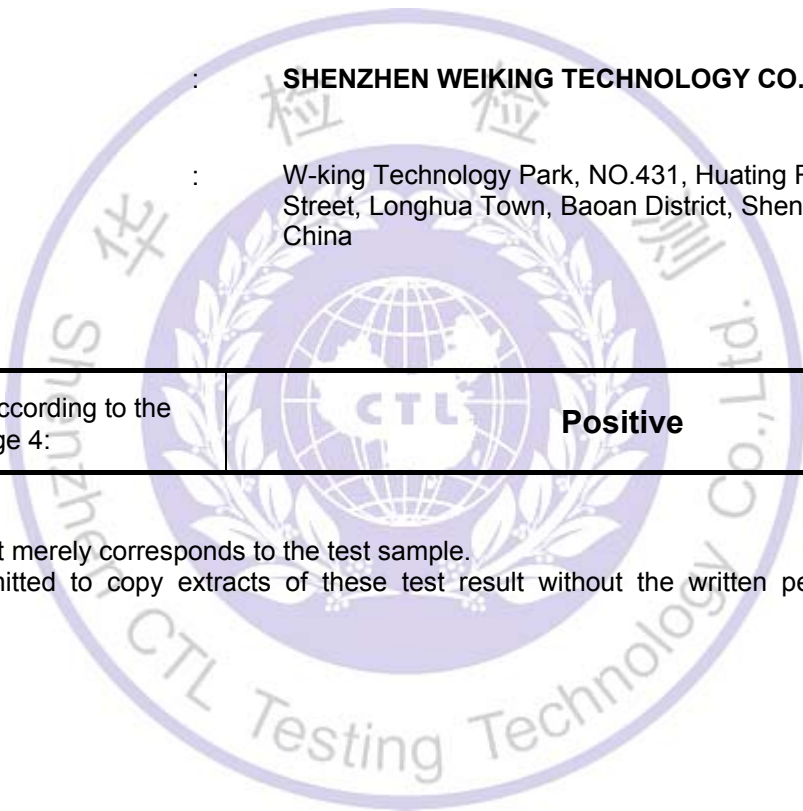

Contents

<u>1.</u>	<u>TEST STANDARDS</u>	<u>4</u>
<u>2.</u>	<u>SUMMARY</u>	<u>5</u>
2.1.	Equipment Under Test	5
2.2.	Description of the Equipment under Test (EUT)	5
2.3.	EUT operation mode	6
2.4.	EUT configuration	6
2.5.	Related Submittal(s) / Grant (s)	6
2.6.	Modifications	6
<u>3.</u>	<u>TEST ENVIRONMENT</u>	<u>7</u>
3.1.	Address of the test laboratory	7
3.2.	Test Facility	7
3.3.	Environmental conditions	7
3.4.	Configuration of Tested System	7
3.5.	Statement of the measurement uncertainty	8
3.6.	Equipments Used during the Test	9
<u>4.</u>	<u>TEST CONDITIONS AND RESULTS</u>	<u>10</u>
4.1.	Conducted Emissions Test	10
4.2.	Transmitter Radiated Unwanted Emissions and Bandedge	14
4.3.	Occupied Bandwidth Measurement	20
<u>5.</u>	<u>ANTENNA REQUIREMENT</u>	<u>24</u>
<u>6.</u>	<u>TEST SETUP PHOTOS OF THE EUT</u>	<u>25</u>
<u>7.</u>	<u>EXTERNAL AND INTERNAL PHOTOS OF THE EUT</u>	<u>27</u>

1. TEST STANDARDS

The tests were performed according to following standards:

[FCC Rules Part 15.249](#): Operation within the bands 902 - 928 MHz, 2400 - 2483.5 MHz, 5725 - 5875 MHz, and 24.0 - 24.25 GHz.

[ANSI C63.10-2013](#)



2.3. EUT operation mode

Test Mode(TM)	Description	Remark
TM1	Bottom Channel Transmitting	/
TM2	Middle Channel Transmitting	/
TM3	Top Channel Transmitting	/
TM4	Charging and keeping TX	power by battery

The field strength of radiation emission was measured in the following position: EUT stand-up position (Y axis), lie-down position (X, Z axis).

The following data show only with the worst case setup.

The worst case of X axis was reported.

Based on client request, all normal using modes of the normal function were tested but only the worst test data of the worst mode is reported by this report.

Remark: The worst case mode is TM1(1Mbps) reported for unwanted emission and band edge test.

2.4. EUT configuration

The following peripheral devices and interface cables were connected during the measurement:

○ - supplied by the manufacturer

● - supplied by the lab

● AC adapter

Manufacturer: Shenzhen Jihongda Power Co.,Ltd

Model: JHD-AP006U-050100BB-2

Input: 100-240VAC 50/60Hz 0.2A

Output: 5VDC 1000mA

2.5. Related Submittal(s) / Grant (s)

This submittal(s) (test report) is intended for FCC ID: Q8W- BT06-T filing to comply with Section 15.249 of the FCC Part 15, Subpart C Rules.

2.6. Modifications

No modifications were implemented to meet testing criteria.

3. TEST ENVIRONMENT

3.1. Address of the test laboratory

Shenzhen CTL Testing Technology Co., Ltd.
Floor 1-A, Baisha Technology Park, No. 3011, Shahexi Road, Nanshan, Shenzhen 518055 China

There is one 3m semi-anechoic chamber and two line conducted labs for final test. The Test Sites meet the requirements in documents ANSI C63.4 and CISPR 22/EN 55022 requirements.

3.2. Test Facility

The test facility is recognized, certified, or accredited by the following organizations:

IC Registration No.: 9618B

The 3m alternate test site of Shenzhen CTL Testing Technology Co., Ltd. EMC Laboratory has been registered by Certification and Engineer Bureau of Industry Canada for the performance of with Registration No.: 9618B on November 13, 2013.

FCC-Registration No.: 970318

Shenzhen CTL Testing Technology Co., Ltd. EMC Laboratory has been registered and fully described in a report filed with the (FCC) Federal Communications Commission. The acceptance letter from the FCC is maintained in our files. Registration 970318, December 19, 2013.

3.3. Environmental conditions

During the measurement the environmental conditions were within the listed ranges:

Temperature: 15-35 ° C

Humidity: 30-60 %

Atmospheric pressure: 950-1050mbar

3.4. Configuration of Tested System

Fig. 2-1 Configuration of Tested System

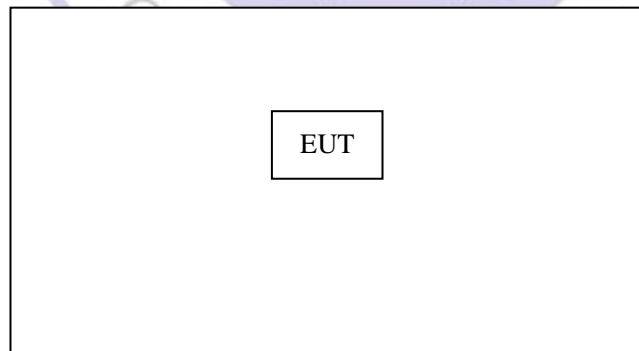

3.5. Statement of the measurement uncertainty

The data and results referenced in this document are true and accurate. The reader is cautioned that there may be errors within the calibration limits of the equipment and facilities. The measurement uncertainty was calculated for all measurements listed in this test report acc. to CISPR 16 - 4 „Specification for radio disturbance and immunity measuring apparatus and methods – Part 4: Uncertainty in EMC Measurements“ and is documented in the Shenzhen CTL Testing Technology Co., Ltd. quality system acc. to DIN EN ISO/IEC 17025. Furthermore, component and process variability of devices similar to that tested may result in additional deviation. The manufacturer has the sole responsibility of continued compliance of the device.

Hereafter the best measurement capability for CTL laboratory is reported:

Test	Range	Measurement Uncertainty	Notes
Radiated Emission	30~1000MHz	4.10dB	(1)
Radiated Emission	1~26.5GHz	4.32dB	(1)
Conducted Disturbance	0.15~30MHz	3.20dB	(1)

- (1) This uncertainty represents an expanded uncertainty expressed at approximately the 95% confidence level using a coverage factor of k=2.



3.6. Equipments Used during the Test

Test Equipment	Manufacturer	Model No.	Serial No.	Calibration Date	Calibration Due Date
BilogAntenna	Sunol Sciences Corp.	JB1	A061713	2015/06/02	2016/06/01
EMI Test Receiver	R&S	ESCI3	103710	2015/06/02	2016/06/01
Spectrum Analyzer	Agilent	E4407B	MY45108355	2015/05/21	2016/05/20
Controller	EM Electronics	Controller EM 1000	N/A	2015/05/21	2016/05/20
Horn Antenna	Sunol Sciences Corp.	DRH-118	A062013	2015/05/19	2016/05/18
Active Loop Antenna	Daze	ZN30900A	N/A	2015/05/19	2016/05/18
LISN	R&S	ENV216	101316	2015/06/02	2016/06/01
LISN	SCHWARZBECK	NSLK8127	8127687	2015/06/02	2016/06/01
Microwave Preamplifier	HP	8349B	3155A00882	2015/05/19	2016/05/18
Amplifier	HP	8447D	3113A07663	2015/05/19	2016/05/18
Transient Limiter	Com-Power	LIT-153	532226	2015/06/02	2016/06/01
Temperature/Humidity Meter	Gangxing	CTH-608	02	2015/05/20	2016/05/19
Climate Chamber	ESPEC	EL-10KA	A20120523	2015/05/20	2016/05/19
High-Pass Filter	K&L	9SH10-2700/X12750-O/O	N/A	2015/05/20	2016/05/19
High-Pass Filter	K&L	41H10-1375/U12750-O/O	N/A	2015/05/20	2016/05/19
Ultra-Broadband Antenna	ShwarzBeck	BBHA9170	25841	2015/05/19	2016/05/18
The temporary antenna connector	MMCX - SMA	1547	23657478	2015/05/20	2016/05/19
RF Cable(1-25GHz)	HUBER+SUHNER	RG214	N/A	2015/05/20	2016/05/19
RF Cable(0-1GHz)	HUBER+SUHNER	RG174	N/A	2015/05/20	2016/05/19

Note: The temporary antenna connector is soldered on the PCB board in order to perform conducted tests and this temporary antenna connector is listed in the equipment list.

4. TEST CONDITIONS AND RESULTS

4.1. Conducted Emissions Test

TEST CONFIGURATION

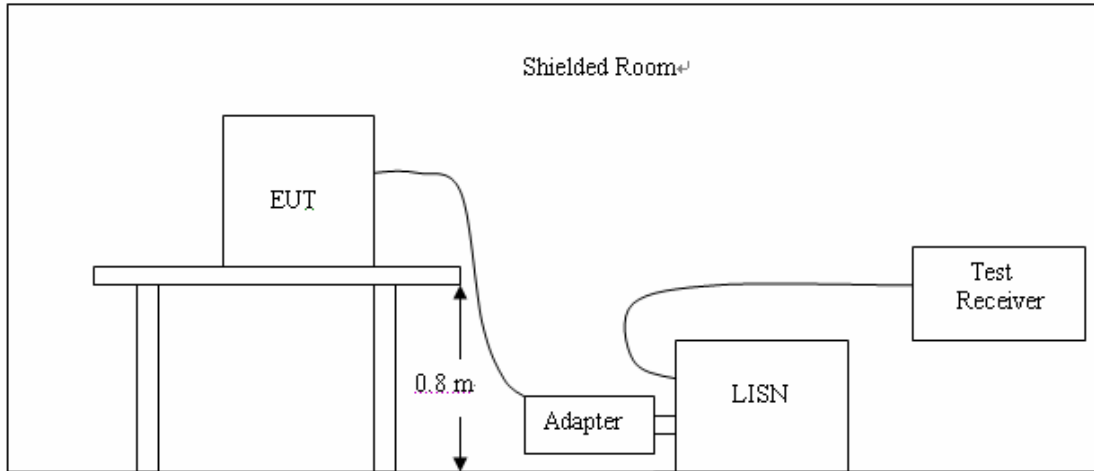

TEST PROCEDURE

- 1 The equipment was set up as per the test configuration to simulate typical actual usage per the user's manual. The EUT is a tabletop system, a wooden table with a height of 0.8 meters is used and is placed on the ground plane as per ANSI C63.10.
- 2 Support equipment, if needed, was placed as per ANSI C63.10.
- 3 All I/O cables were positioned to simulate typical actual usage as per ANSI C63.10.
- 4 If a EUT received DC power from the USB Port of Notebook PC, the PC's adapter received AC120V/60Hz power through a Line Impedance Stabilization Network (LISN) which supplied power source and was grounded to the ground plane.
- 5 All support equipments received AC power from a second LISN, if any.
- 6 The EUT test program was started. Emissions were measured on each current carrying line of the EUT using a spectrum Analyzer / Receiver connected to the LISN powering the EUT. The LISN has two monitoring points: Line 1 (Hot Side) and Line 2 (Neutral Side). Two scans were taken: one with Line 1 connected to Analyzer / Receiver and Line 2 connected to a 50 ohm load; the second scan had Line 1 connected to a 50 ohm load and Line 2 connected to the Analyzer / Receiver.
- 7 Analyzer / Receiver scanned from 150 KHz to 30MHz for emissions in each of the test modes.
- 8 During the above scans, the emissions were maximized by cable manipulation.

The RBW/VBW for 150KHz to 30MHz: 9KHz

CONDUCTED POWER LINE EMISSION LIMIT

For unintentional device, according to § 15.207(a) Line Conducted Emission Limits is as following :

Frequency (MHz)	Maximum RF Line Voltage (dB μ V)			
	CLASS A		CLASS B	
	Q.P.	Ave.	Q.P.	Ave.
0.15 - 0.50	79	66	66-56*	56-46*
0.50 - 5.00	73	60	56	46
5.00 - 30.0	73	60	60	50

* Decreasing linearly with the logarithm of the frequency

For intentional device, according to §15.207(a) Line Conducted Emission Limit is same as above table.

TEST RESULTS

Test Voltage: AC120V/60Hz

Charging and keeping TX mode(TM4):

Please next page:



SCAN TABLE: "Voltage (9K-30M) FIN"

Short Description: 150K-30M Voltage

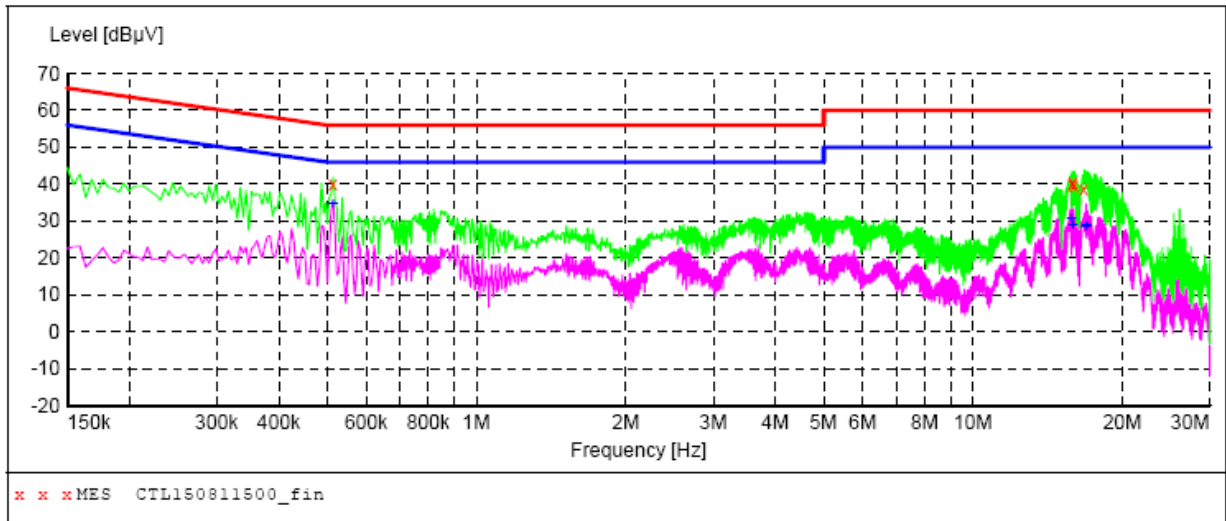

MEASUREMENT RESULT: "CTL150811500_fin"

8/11/2015 10:10AM

Frequency MHz	Level dBµV	Transd dB	Limit dBµV	Margin dB	Detector	Line	PE
0.514501	40.00	10.2	56	16.0	QP	L1	GND
15.837001	40.10	10.7	60	19.9	QP	L1	GND
15.886501	40.20	10.7	60	19.8	QP	L1	GND
15.985501	39.70	10.7	60	20.3	QP	L1	GND
16.701001	38.50	10.8	60	21.5	QP	L1	GND

MEASUREMENT RESULT: "CTL150811500_fin2"

8/11/2015 10:10AM

Frequency MHz	Level dBµV	Transd dB	Limit dBµV	Margin dB	Detector	Line	PE
0.514501	34.80	10.2	46	11.2	AV	L1	GND
15.792001	30.80	10.7	50	19.2	AV	L1	GND
15.891001	28.70	10.7	50	21.3	AV	L1	GND
16.894501	28.30	10.8	50	21.7	AV	L1	GND
16.939501	28.90	10.8	50	21.1	AV	L1	GND

SCAN TABLE: "Voltage (9K-30M)FIN"

Short Description: 150K-30M Voltage

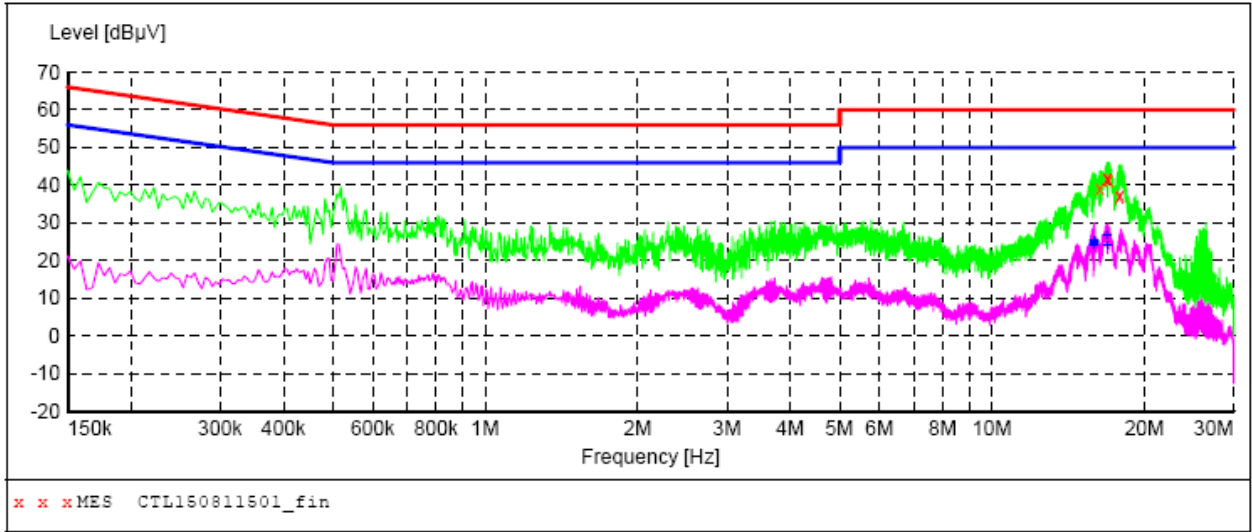

MEASUREMENT RESULT: "CTL150811501_fin"

8/11/2015 10:14AM

Frequency MHz	Level dBµV	Transd dB	Limit dBµV	Margin dB	Detector	Line	PE
16.332001	39.30	10.7	60	20.7	QP	N	GND
16.863001	41.70	10.8	60	18.3	QP	N	GND
16.926001	41.90	10.8	60	18.1	QP	N	GND
17.007001	41.10	10.8	60	18.9	QP	N	GND
17.803501	36.80	10.8	60	23.2	QP	N	GND
17.898001	37.30	10.8	60	22.7	QP	N	GND

MEASUREMENT RESULT: "CTL150811501_fin2"

8/11/2015 10:14AM

Frequency MHz	Level dBµV	Transd dB	Limit dBµV	Margin dB	Detector	Line	PE
15.846001	23.80	10.7	50	26.2	AV	N	GND
15.882001	24.50	10.7	50	25.5	AV	N	GND
15.900001	25.10	10.7	50	24.9	AV	N	GND
15.936001	24.70	10.7	50	25.3	AV	N	GND
16.863001	26.40	10.8	50	23.6	AV	N	GND
16.917001	23.90	10.8	50	26.1	AV	N	GND

4.2. Transmitter Radiated Unwanted Emissions and Bandedge

TEST CONFIGURATION

(A) Radiated Emission Test Set-Up, Frequency Below 30MHz

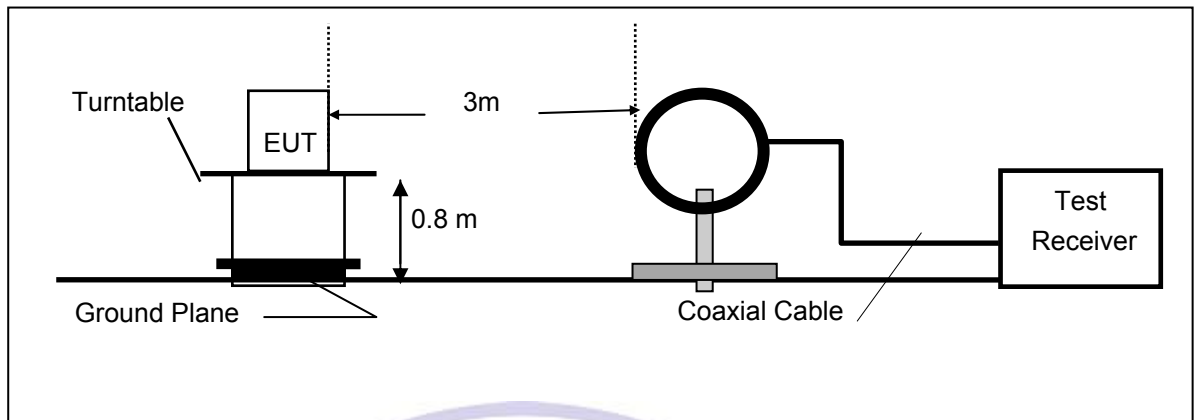

(B) Radiated Emission Test Set-Up, Frequency below 1000MHz

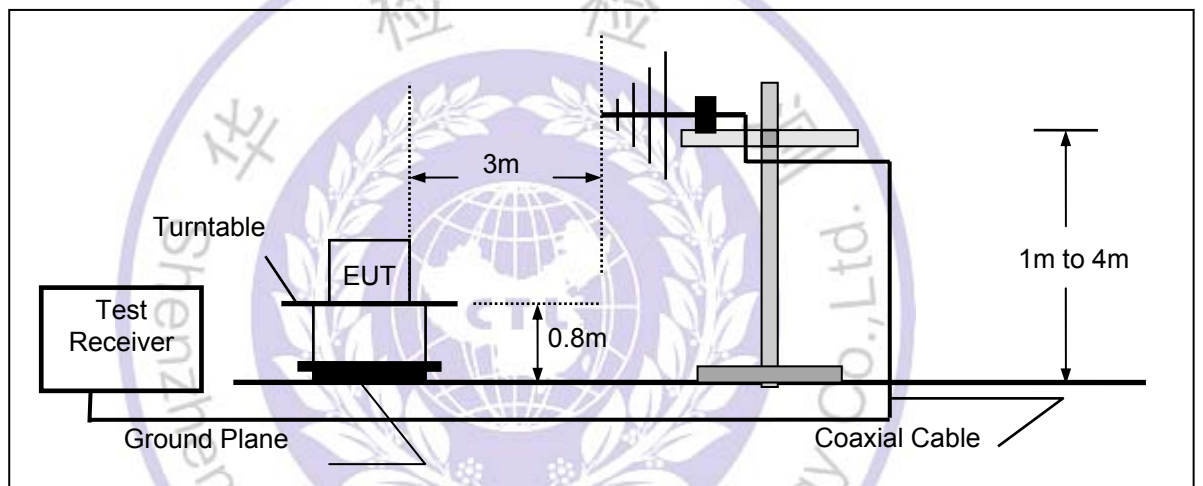

(C) Radiated Emission Test Set-Up, Frequency above 1000MHz

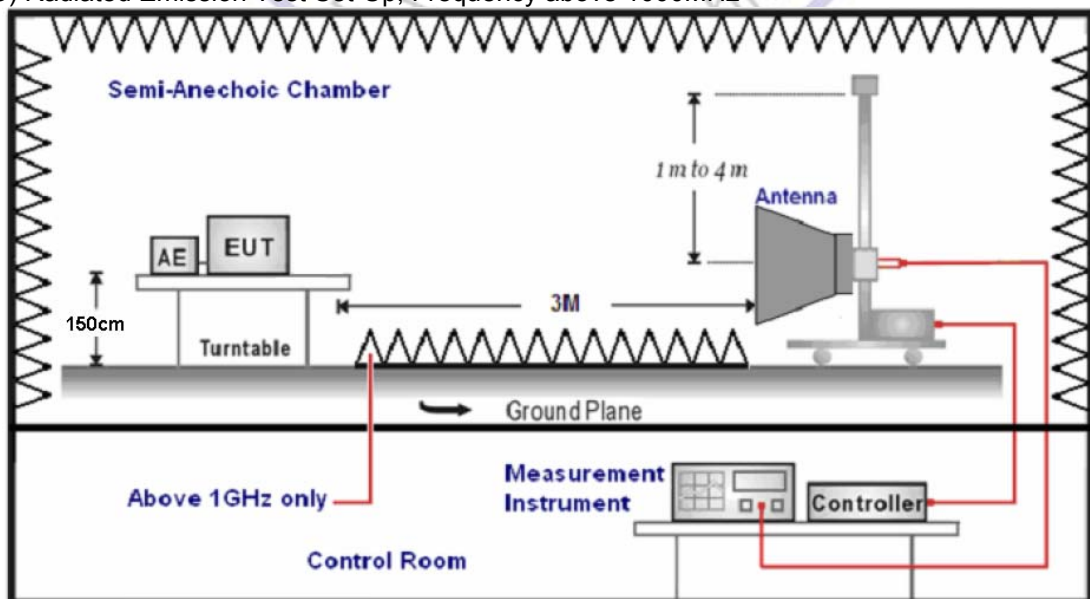

FIELD STRENGTH CALCULATION

The field strength is calculated by adding the Antenna Factor and Cable Factor and subtracting the Amplifier Gain and Duty Cycle Correction Factor(if any) from the measured reading. The basic equation with a sample calculation is as follows:

$$FS = RA + AF + CL - AG$$

Where FS = Field Strength	CL = Cable Attenuation Factor (Cable Loss)
RA = Reading Amplitude	AG = Amplifier Gain
AF = Antenna Factor	

RADIATION LIMIT

For unintentional device, according to § 15.209(a), except for Class A digital devices, the field strength of radiated emissions from unintentional radiators at a distance of 3 meters shall not exceed the following values:

Frequency (MHz)	Distance (Meters)	Radiated (dBµV/m)	Radiated (µV/m)
30-88	3	40.0	100
88-216	3	43.5	150
216-960	3	46.0	200
Above 960	3	54.0	500

For intentional device, according to § 15.209(a), the general requirement of field strength of radiated emissions from intentional radiators at a distance of 3 meters shall not exceed the above table.

TEST PROCEDURE

1. The EUT is placed on a turntable, which is 0.8m above ground plane below 1GHz and 1.5m above ground plane above 1GHz .
2. The turntable shall be rotated for 360 degrees to determine the position of maximum emission level.
3. EUT is set 3m away from the receiving antenna, which is varied from 1m to 4m to find out the highest emissions.
4. For the radiated emission test above 1GHz: Place the measurement antenna away from each area of the EUT determined to be a source of emissions at the specified measurement distance, while keeping the measurement antenna aimed at the source of emissions at each frequency of significant emissions, with polarization oriented for maximum response. The measurement antenna may have to be higher or lower than the EUT, depending on the radiation pattern of the emission and staying aimed at the emission source for receiving the maximum signal. The final measurement antenna elevation shall be that which maximizes the emissions. The measurement antenna elevation for maximum emissions shall be restricted to a range of heights of from 1 m to 4 m above the ground or reference ground plane.
5. Maximum procedure was performed on the six highest emissions to ensure EUT compliance.
6. And also, each emission was to be maximized by changing the polarization of receiving antenna both horizontal and vertical.
7. Repeat above procedures until the measurements for all frequencies are complete.
8. Based on the Frequency Generator in the device include 16MHz.The test frequency range from 9KHz to 25GHz per FCC PART 15.33(a).

Note:

Three axes are chosen for pretest, the X axis is the worst mode for final test.
For battery operated equipment, the equipment tests shall be performed using a fully-charged battery.

TEST RESULTS

All the test modes (TM1, TM2, TM3 and TM4) completed for test. The worst case of Radiated Emission is TM1; the test data of this mode was reported.

Below 1GHz Test Results:

SWEEP TABLE: "test (30M-1G)"

Short Description:		Field Strength			
Start	Stop	Detector	Meas. Time	IF Bandw.	Transducer
Frequency	Frequency				
30.0 MHz	1.0 GHz	MaxPeak	300.0 ms	120 kHz	JB1

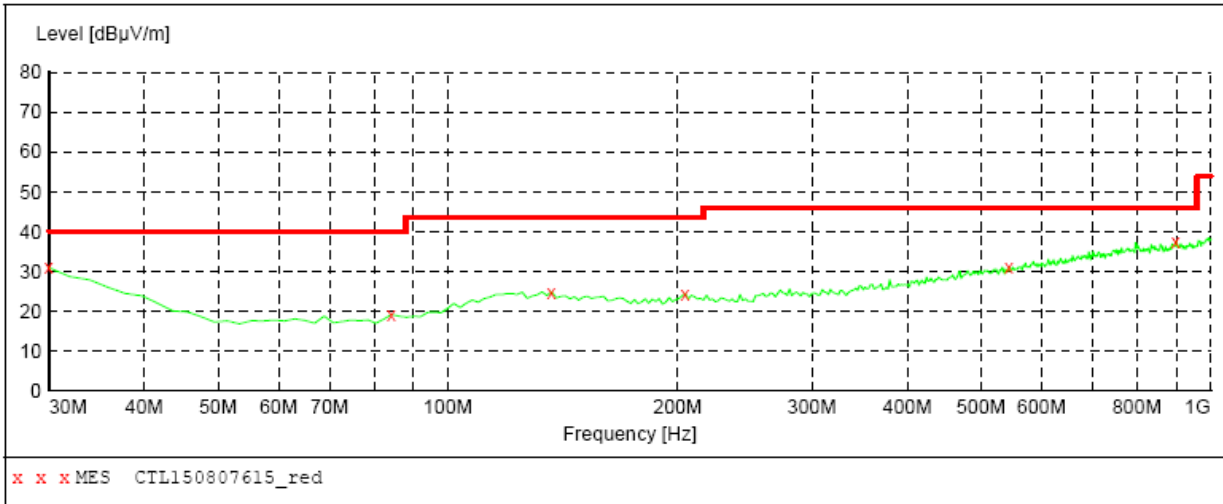

MEASUREMENT RESULT: "CTL150807615_red"

8/7/2015 1:56PM

Frequency MHz	Level dBµV/m	Transd dB	Limit dBµV/m	Margin dB	Det.	Height cm	Azimuth deg	Polarization
30.000000	30.90	21.1	40.0	9.1	---	0.0	0.00	VERTICAL
84.320000	19.10	9.2	40.0	20.9	---	0.0	0.00	VERTICAL
136.700000	24.80	14.7	43.5	18.7	---	0.0	0.00	VERTICAL
204.600000	24.40	14.4	43.5	19.1	---	0.0	0.00	VERTICAL
544.100000	31.10	20.9	46.0	14.9	---	0.0	0.00	VERTICAL
899.120000	37.60	26.1	46.0	8.4	---	0.0	0.00	VERTICAL

Remark:

- (1) Measuring frequencies from 9 KHz to the 1 GHz, Radiated emission test from 9KHz to 30MHz was verified, and no any emission was found except system noise floor.
- (2) * denotes emission frequency which appearing within the Restricted Bands specified in provision of 15.205, then the general radiated emission limits in 15.209 apply.
- (3) The IF bandwidth of EMI Test Receiver between 30MHz to 1GHz was 120KHz, 1 MHz for measuring above 1 GHz, below 30MHz was 10KHz.

SWEEP TABLE: "test (30M-1G)"

Short Description:		Field Strength				Transducer
Start	Stop	Detector	Meas. Time	IF Bandw.		
30.0 MHz	1.0 GHz	MaxPeak	300.0 ms	120 kHz	JB1	

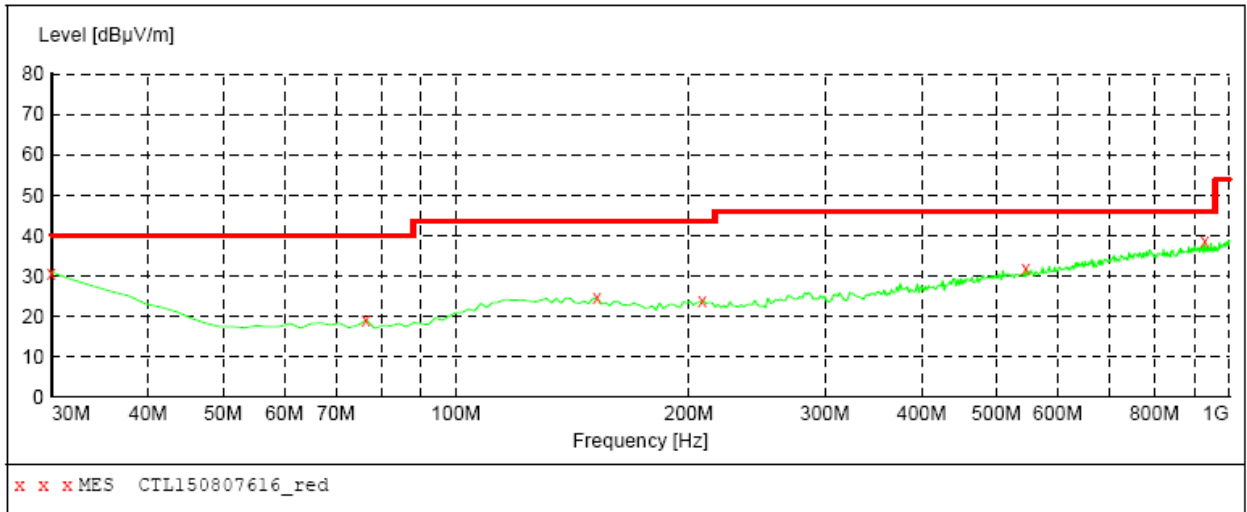

MEASUREMENT RESULT: "CTL150807616_red"

8/7/2015 1:58PM

Frequency MHz	Level dBµV/m	Transd dB	Limit dBµV/m	Margin dB	Det.	Height cm	Azimuth deg	Polarization
30.000000	30.80	21.1	40.0	9.2	---	0.0	0.00	HORIZONTAL
76.560000	19.00	8.6	40.0	21.0	---	0.0	0.00	HORIZONTAL
152.220000	24.60	14.1	43.5	18.9	---	0.0	0.00	HORIZONTAL
208.480000	23.90	14.3	43.5	19.6	---	0.0	0.00	HORIZONTAL
546.040000	31.70	20.9	46.0	14.3	---	0.0	0.00	HORIZONTAL
930.160000	38.60	26.4	46.0	7.4	---	0.0	0.00	HORIZONTAL

Remark:

- (1) Measuring frequencies from 9 KHz to the 1 GHz, Radiated emission test from 9KHz to 30MHz was verified, and no any emission was found except system noise floor.
- (2) * denotes emission frequency which appearing within the Restricted Bands specified in provision of 15.205, then the general radiated emission limits in 15.209 apply.
- (3) The IF bandwidth of EMI Test Receiver between 30MHz to 1GHz was 120KHz, 1 MHz for measuring above 1 GHz, below 30MHz was 10KHz.

Above 1 GHz Test Results:

Note: Measurement worst emissions of receive antenna polarization: Vertical.

Frequency	Emission		Limit	Margin	Raw	Antenna Factor	Cable	Pre-amplifier	Correction
(MHz)	Level		(dBuV/m)	(dB)	Value	(dB/m)	Factor	(dB)	Factor
	(dBuV/m)				(dBuV)		(dB)		(dB/m)
2402.00	96.75	PK	114	17.25	98.71	28.78	4.61	35.36	-1.96
2402.00	84.39	AV	94	9.61	86.35	28.78	4.61	35.36	-1.96
2390.00	59.24	PK	74	14.76	61.28	28.72	4.60	35.36	-2.04
2390.00	46.91	AV	54	7.09	48.95	28.72	4.60	35.36	-2.04
3603.00	54.22	PK	74	19.78	51.86	32.04	5.94	35.62	2.36
3603.00	43.36	AV	54	10.64	41.00	32.04	5.94	35.62	2.36
4804.00	63.57	PK	74	10.43	57.42	33.49	6.91	34.25	6.15
4804.00	49.82	AV	54	4.18	43.67	33.49	6.91	34.25	6.15
6005.00	54.38	PK	74	19.62	46.25	35.12	7.60	34.59	8.13
6005.00	42.64	AV	54	11.36	34.51	35.12	7.60	34.59	8.13
7206.00	57.79	PK	74	16.21	46.68	36.95	9.18	35.03	11.11
7206.00	46.06	AV	54	7.94	34.95	36.95	9.18	35.03	11.11

Frequency	Emission		Limit	Margin	Raw	Antenna Factor	Cable	Pre-amplifier	Correction
(MHz)	Level		(dBuV/m)	(dB)	Value	(dB/m)	Factor	(dB)	Factor
	(dBuV/m)				(dBuV)		(dB)		(dB/m)
2441.00	95.04	PK	114	18.96	96.90	28.85	4.66	35.37	-1.86
2441.00	81.17	AV	94	12.83	83.03	28.85	4.66	35.37	-1.86
3200.00	62.98	PK	74	11.02	61.62	31.24	5.47	35.35	1.36
3200.00	50.01	AV	54	3.99	48.65	31.24	5.47	35.35	1.36
3657.00	63.39	PK	74	10.61	60.04	32.37	6.01	35.04	3.35
3657.00	51.18	AV	54	2.82	47.83	32.37	6.01	35.04	3.35
4882.00	62.77	PK	74	11.23	56.41	33.60	6.95	34.19	6.36
4882.00	49.75	AV	54	4.25	43.39	33.60	6.95	34.19	6.36
6103.00	64.84	PK	74	9.16	56.54	35.20	7.74	34.64	8.30
6103.00	53.06	AV	54	0.94	44.76	35.20	7.74	34.64	8.30
7323.00	55.72	PK	74	18.28	44.02	37.46	9.23	35.00	11.70
7323.00	46.13	AV	54	7.87	34.43	37.46	9.23	35.00	11.70

Frequency	Emission		Limit	Margin	Raw	Antenna Factor	Cable	Pre-amplifier	Correction
(MHz)	Level		(dBuV/m)	(dB)	Value	(dB/m)	Factor	(dB)	Factor
	(dBuV/m)				(dBuV)		(dB)		(dB/m)
2480.00	96.89	PK	114	17.11	98.64	28.92	4.70	35.38	-1.75
2480.00	84.15	AV	94	9.85	85.90	28.92	4.70	35.38	-1.75
2483.50	53.07	PK	74	20.93	54.81	28.93	4.70	35.38	-1.74
2483.50	40.92	AV	54	13.08	42.66	28.93	4.70	35.38	-1.74
3720.00	55.61	PK	74	18.39	52.41	32.77	6.08	35.65	3.20
3720.00	41.86	AV	54	12.14	38.66	32.77	6.08	35.65	3.20
4960.00	64.02	PK	74	9.98	57.32	33.84	7.00	34.14	6.70
4960.00	51.74	AV	54	2.26	45.04	33.84	7.00	34.14	6.70
6200.00	54.41	PK	74	19.59	46.01	35.19	7.90	34.69	8.40
6200.00	42.09	AV	54	11.91	33.69	35.19	7.90	34.69	8.40
7440.00	56.33	PK	74	17.67	44.38	37.64	9.28	34.97	11.95
7440.00	45.58	AV	54	8.42	33.63	37.64	9.28	34.97	11.95

Note: above 10GHz up to 25GHz was verified, and no any emission was found except system noise floor.

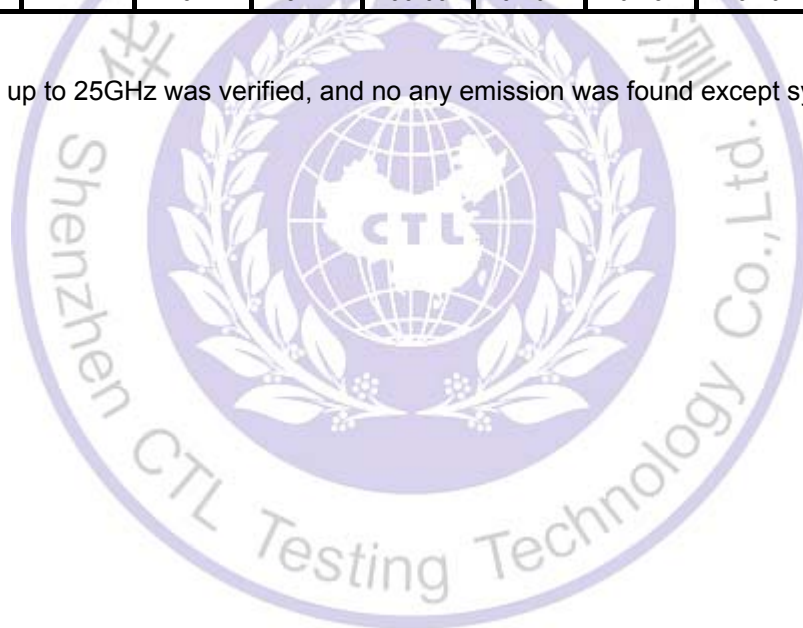

4.3. Occupied Bandwidth Measurement

Measurement Procedure

1. Set EUT as normal operation.
2. $RBW \geq 1\%$ of the 20 dB bandwidth, $VBW \geq RBW$.
3. The useful conducted emission from the EUT was detected by the spectrum analyser with peak detector.

Measurement Results

GFSK:

2402MHz

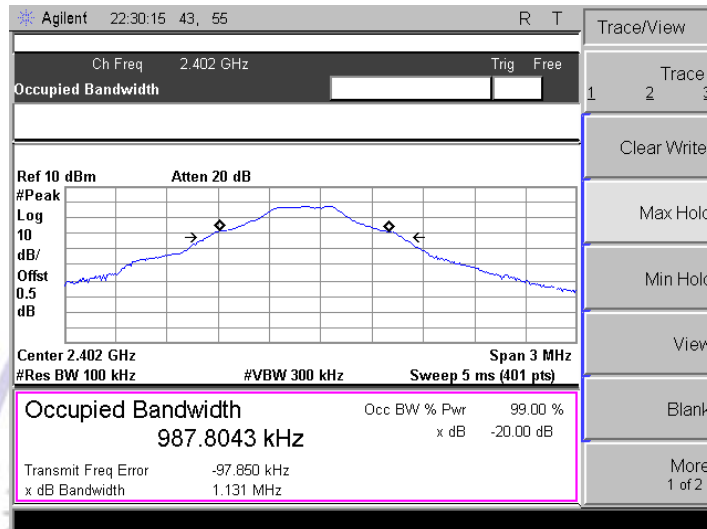

20dB Bandwidth: 1131 KHz

2441MHz

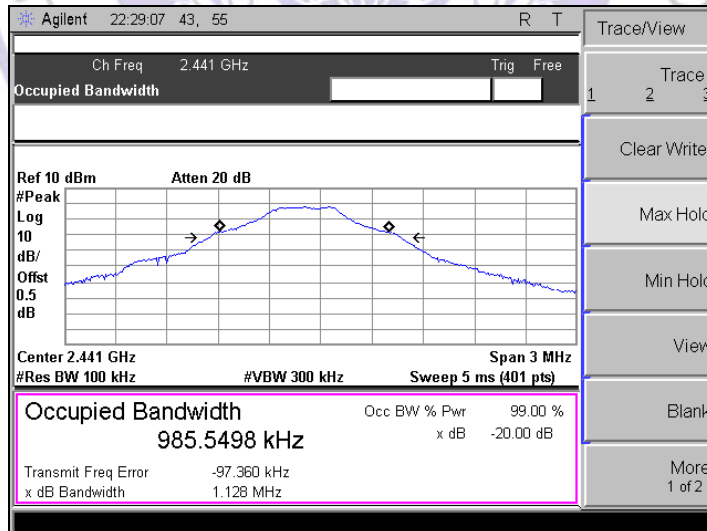

20dB Bandwidth: 1128 KHz

2480MHz

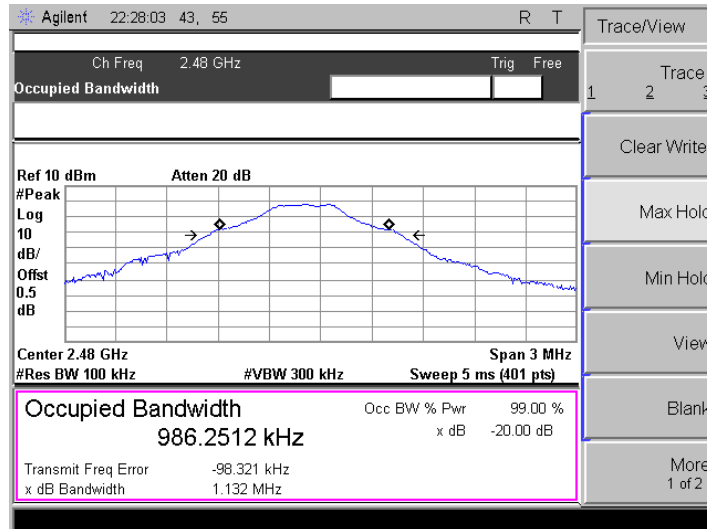

20dB Bandwidth: 1132 KHz

8DPSK mode:

2402MHz

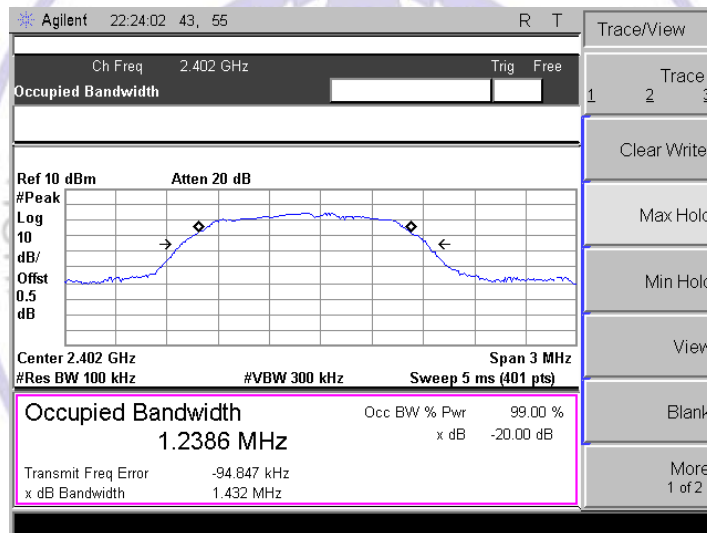

20dB Bandwidth: 1432 KHz

2441MHz

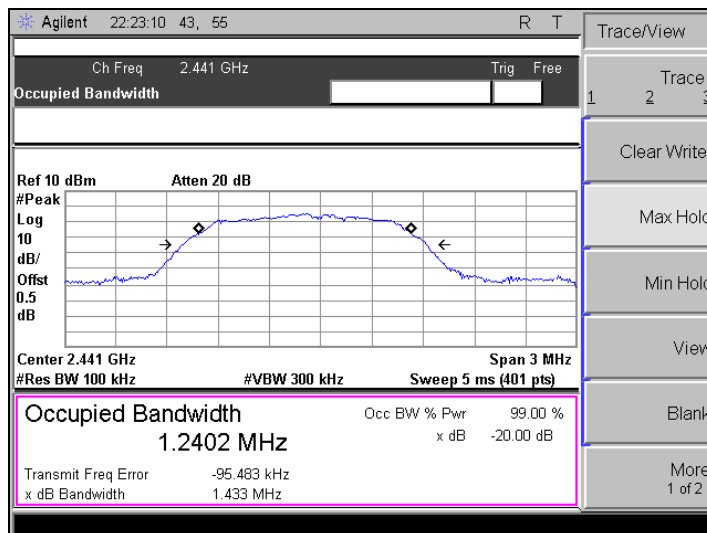

20dB Bandwidth: 1433 KHz

2480MHz

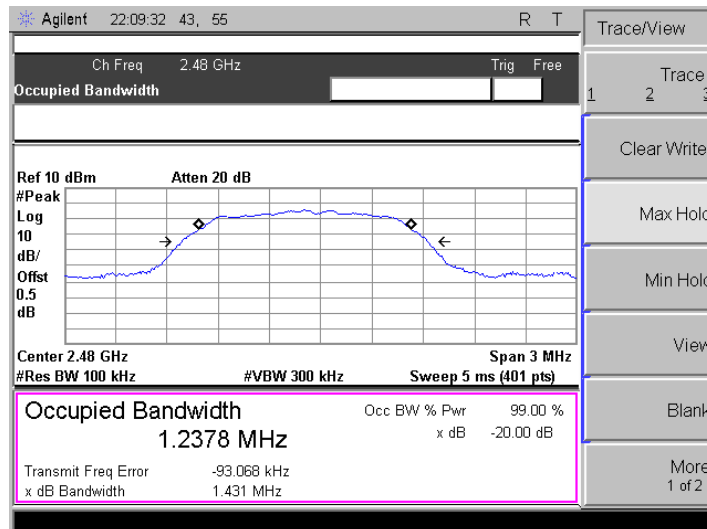

20dB Bandwidth: 1431 KHz

π /4DQPSK mode:

2402MHz

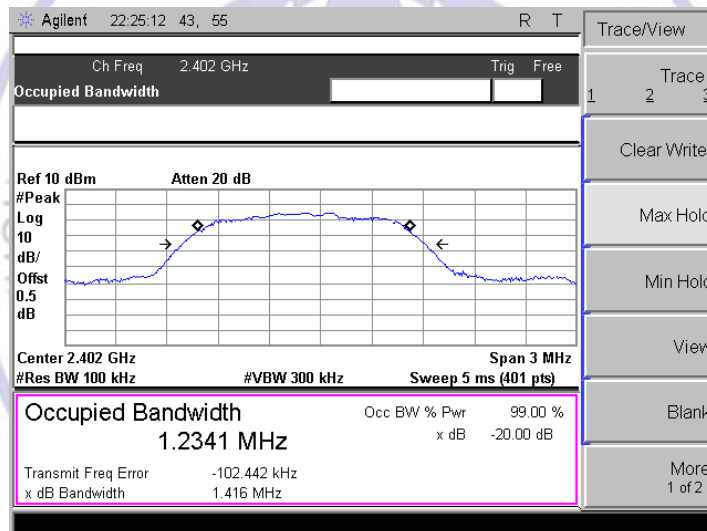

20dB Bandwidth: 1416 KHz

2441MHz

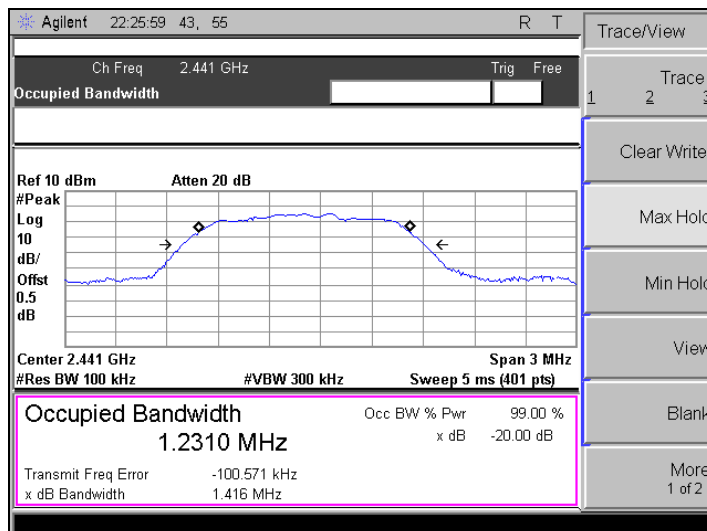

20dB Bandwidth: 1416 KHz

2480MHz

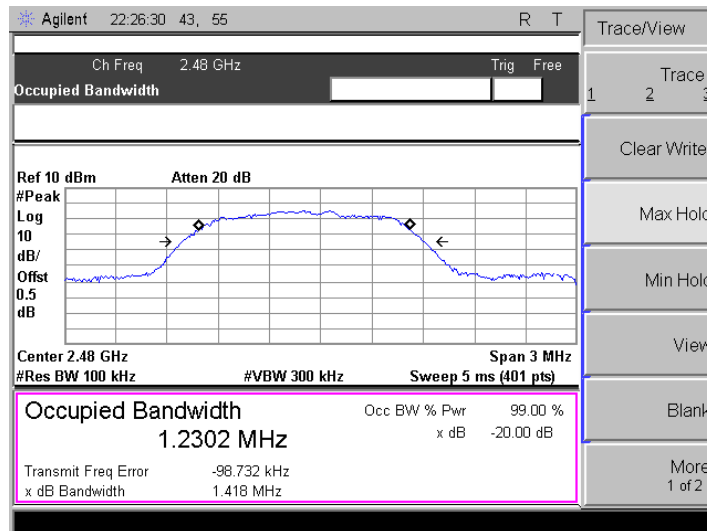

20dB Bandwidth: 1418 KHz



5. Antenna Requirement

Standard Applicable

For intentional device, according to FCC 47 CFR Section 15.203, an intentional radiator shall be designed to ensure that no antenna other than that furnished by the responsible party shall be used with the device.

And according to FCC 47 CFR Section 15.247 (c), if transmitting antennas of directional gain greater than 6dBi are used, the power shall be reduced by the amount in dB that the directional gain of the antenna exceeds 6dBi.

Refer to statement below for compliance.

The manufacturer may design the unit so that the user can replace a broken antenna, but the use of a standard antenna jack or electrical connector is prohibited. Further, this requirement does not apply to intentional radiators that must be professionally installed.

Antenna Connected Construction

The antenna used in this product is an internal Antenna, The directional gains of antenna used for transmitting is 0 dBi.



6. Test Setup Photos of the EUT

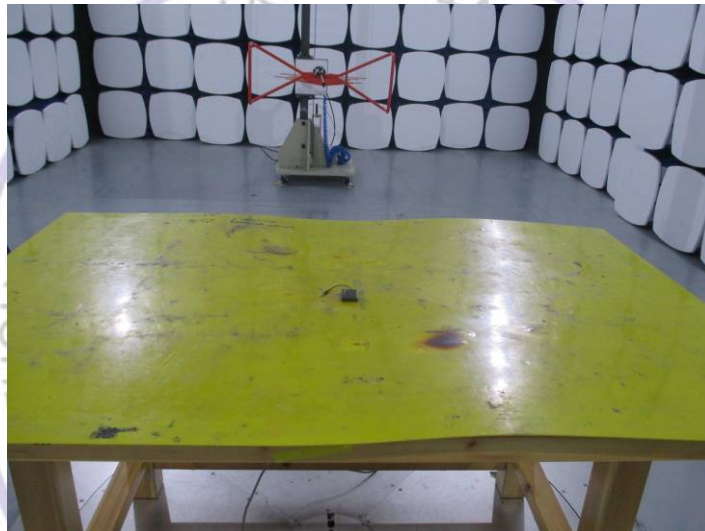
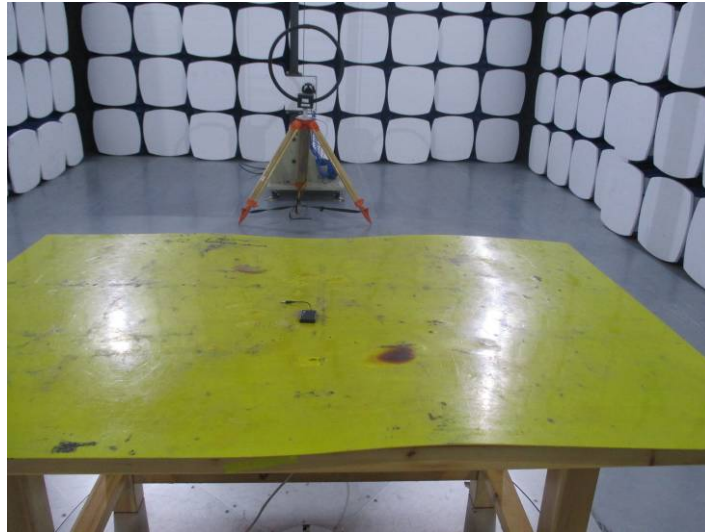



7. External and Internal Photos of the EUT

External Photos



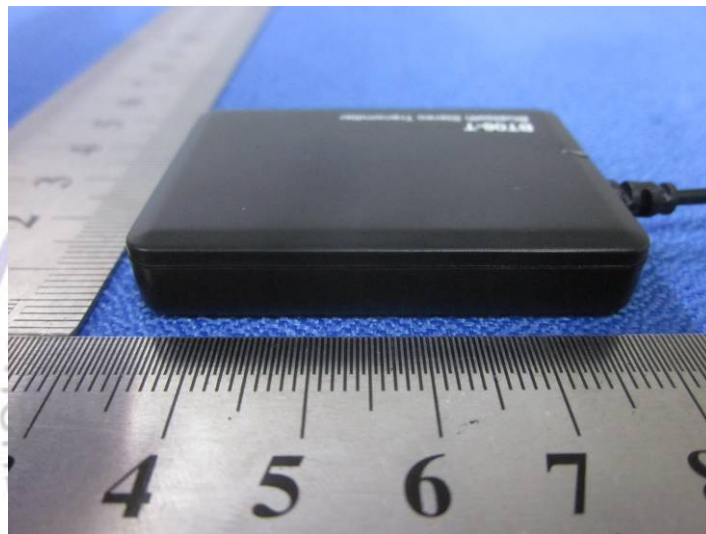

Internal Photos of EUT

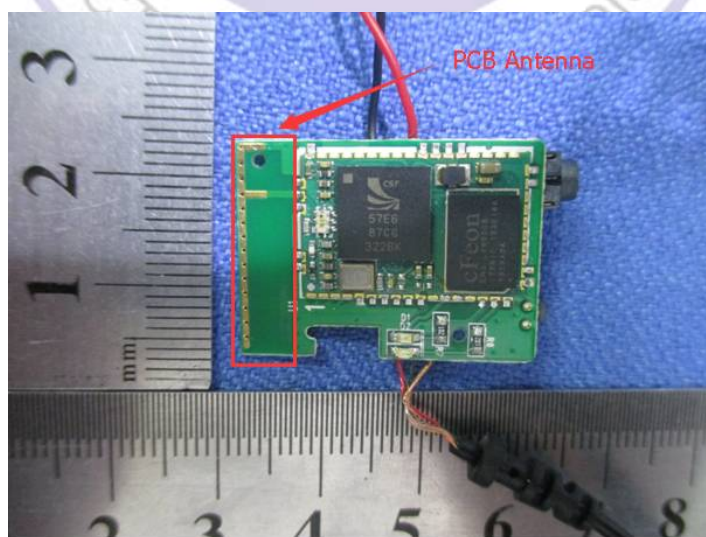
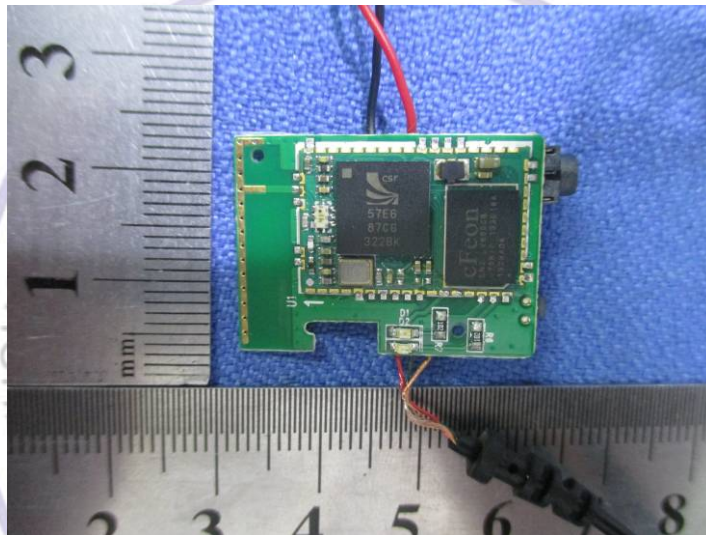
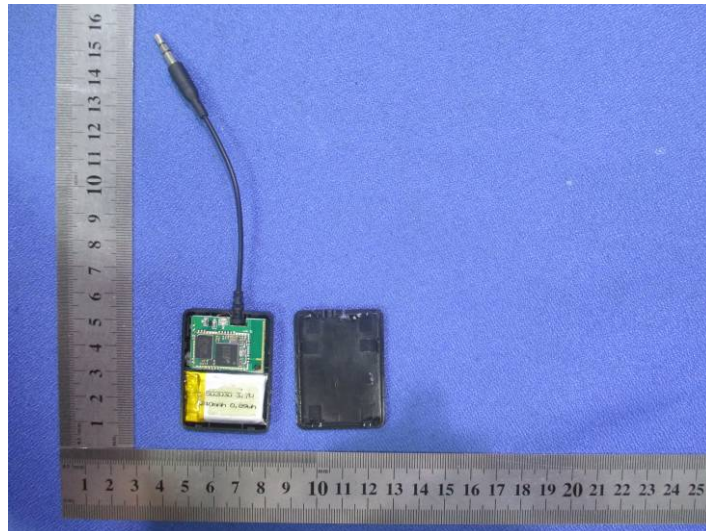

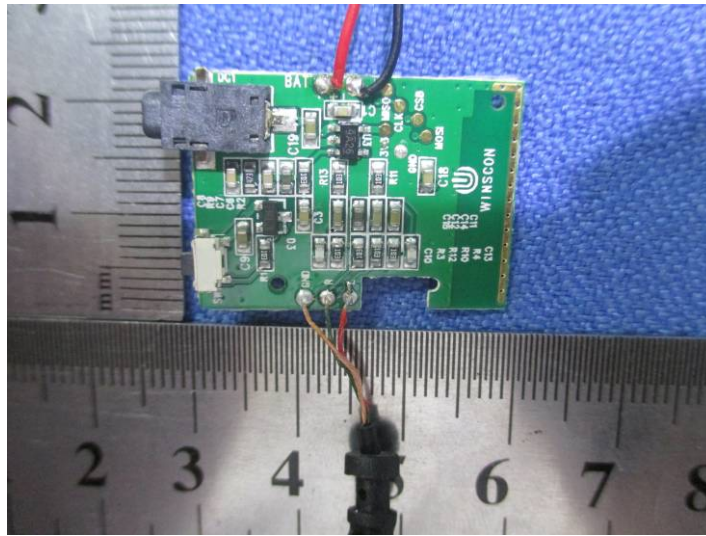

.....End of Report.....

