



A D T

FCC TEST REPORT (PART 22)

REPORT NO.: RF141226C02-4
MODEL NO.: RS30
FCC ID: Q3N-RS30
RECEIVED: Dec. 17, 2014
TESTED: Dec. 19, 2014 ~ Jan. 14, 2015
ISSUED: Jan. 15, 2015

APPLICANT: CIPHERLAB CO., LTD

ADDRESS: 12F, 333 Dunhua S. Rd., Sec.2 Taipei, Taiwan 106

ISSUED BY: Bureau Veritas Consumer Products Services
(H.K.) Ltd., Taoyuan Branch

LAB ADDRESS: No. 47-2, 14th Ling, Chia Pau Vil., Lin Kou Dist.,
New Taipei City, Taiwan, R.O.C.

TEST LOCATION: No. 19, Hwa Ya 2nd Rd, Wen Hwa Tsuen, Kwei
Shan Hsiang, Taoyuan Hsien 333, Taiwan, R.O.C.

This report should not be used by the client to claim product certification, approval, or endorsement by TAF or any government agencies.



This report is for your exclusive use. Any copying or replication of this report to or for any other person or entity, or use of our name or trademark, is permitted only with our prior written permission. This report sets forth our findings solely with respect to the test samples identified herein. The results set forth in this report are not indicative or representative of the quality or characteristics of the lot from which a test sample was taken or any similar or identical product unless specifically and expressly noted. Our report includes all of the tests requested by you and the results thereof based upon the information that you provided to us. You have 60 days from date of issuance of this report to notify us of any material error or omission caused by our negligence, provided, however, that such notice shall be in writing and shall specifically address the issue you wish to raise. A failure to raise such issue within the prescribed time shall constitute your unqualified acceptance of the completeness of this report, the tests conducted and the correctness of the report contents. Unless specific mention, the uncertainty of measurement has been explicitly taken into account to declare the compliance or non-compliance to the specification.



TABLE OF CONTENTS

RELEASE CONTROL RECORD	4
1 CERTIFICATION	5
2 SUMMARY OF TEST RESULTS	6
2.1 MEASUREMENT UNCERTAINTY	6
2.2 TEST SITE AND INSTRUMENTS	7
3 GENERAL INFORMATION	8
3.1 GENERAL DESCRIPTION OF EUT	8
3.2 CONFIGURATION OF SYSTEM UNDER TEST	9
3.3 DESCRIPTION OF SUPPORT UNITS	9
3.4 TEST ITEM AND TEST CONFIGURATION	10
3.5 EUT OPERATING CONDITIONS	11
3.6 GENERAL DESCRIPTION OF APPLIED STANDARDS	11
4 TEST TYPES AND RESULTS	12
4.1 OUTPUT POWER MEASUREMENT	12
4.1.1 LIMITS OF OUTPUT POWER MEASUREMENT	12
4.1.2 TEST PROCEDURES	12
4.1.3 TEST SETUP	13
4.1.4 TEST RESULTS	14
4.2 FREQUENCY STABILITY MEASUREMENT	18
4.2.1 LIMITS OF FREQUENCY STABILITY MEASUREMENT	18
4.2.2 TEST PROCEDURE	18
4.2.3 TEST SETUP	18
4.2.4 TEST RESULTS	19
4.3 OCCUPIED BANDWIDTH MEASUREMENT	20
4.3.1 TEST PROCEDURES	20
4.3.2 TEST SETUP	20
4.3.3 TEST RESULTS	21
4.4 BAND EDGE MEASUREMENT	23
4.4.1 LIMITS OF BAND EDGE MEASUREMENT	23
4.4.2 TEST SETUP	23
4.4.3 TEST PROCEDURES	23
4.4.4 TEST RESULTS	24
4.5 PEAK TO AVERAGE RATIO	26
4.5.1 LIMITS OF PEAK TO AVERAGE RATIO MEASUREMENT	26
4.5.2 TEST SETUP	26
4.5.3 TEST PROCEDURES	26
4.5.4 TEST RESULTS	27
4.6 CONDUCTED SPURIOUS EMISSIONS	29
4.6.1 LIMITS OF CONDUCTED SPURIOUS EMISSIONS MEASUREMENT	29
4.6.2 TEST PROCEDURE	29
4.6.3 TEST SETUP	29
4.6.4 TEST RESULTS	30
4.7 RADIATED EMISSION MEASUREMENT	48
4.7.1 LIMITS OF RADIATED EMISSION MEASUREMENT	48
4.7.2 TEST PROCEDURES	48
4.7.3 DEVIATION FROM TEST STANDARD	48
4.7.4 TEST SETUP	49
4.7.5 TEST RESULTS	50
5 PHOTOGRAPHS OF THE TEST CONFIGURATION	62



A D T

6	INFORMATION ON THE TESTING LABORATORIES	63
7	APPENDIX A – MODIFICATIONS RECORDERS FOR ENGINEERING CHANGES TO THE EUT BY THE LAB.....	64



A D T

RELEASE CONTROL RECORD

ISSUE NO.	REASON FOR CHANGE	DATE ISSUED
RF141226C02-4	Original release	Jan. 15, 2015



A D T

1 CERTIFICATION

PRODUCT: Mobile Computer

MODEL: RS30

BRAND: CIPHERLAB

APPLICANT: CIPHERLAB CO., LTD

TESTED: Dec. 19, 2014 ~ Jan. 14, 2015

TEST SAMPLE: ENGINEERING SAMPLE

STANDARDS: FCC PART 22, Subpart H

The above equipment (model: RS30) has been tested by **Bureau Veritas Consumer Products Services (H.K.) Ltd., Taoyuan Branch**, and found compliance with the requirement of the above standards. The test record, data evaluation & Equipment Under Test (EUT) configurations represented herein are true and accurate accounts of the measurements of the sample's EMC characteristics under the conditions specified in this report.

PREPARED BY : Celine Chou , **DATE** : Jan. 15, 2015
Celine Chou / Specialist

APPROVED BY : Bruce Chen , **DATE** : Jan. 15, 2015
Bruce Chen / Project Engineer



2 SUMMARY OF TEST RESULTS

The EUT has been tested according to the following specifications:

APPLIED STANDARD: FCC Part 22 & Part 2			
STANDARD SECTION	TEST TYPE	RESULT	REMARK
2.1046 22.913 (a)	Effective radiated power	PASS	Meet the requirement of limit.
---	Peak To Average Ratio	PASS	Meet the requirement of limit.
2.1055 22.355	Frequency Stability	PASS	Meet the requirement of limit.
2.1049	Occupied Bandwidth	PASS	Meet the requirement of limit.
22.917	Band Edge Measurements	PASS	Meet the requirement of limit.
2.1051 22.917	Conducted Spurious Emissions	PASS	Meet the requirement of limit.
2.1053 22.917	Radiated Spurious Emissions	PASS	Meet the requirement of limit. Minimum passing margin is -16.13dB at 1648.40MHz.

2.1 MEASUREMENT UNCERTAINTY

Where relevant, the following measurement uncertainty levels have been estimated for tests performed on the EUT as specified in CISPR 16-4-2:

MEASUREMENT	FREQUENCY	UNCERTAINTY
Conducted emissions	150kHz~30MHz	2.44 dB
Radiated emissions	30MHz ~ 200MHz	3.59 dB
	200MHz ~1000MHz	3.60 dB
	1GHz ~ 18GHz	2.29 dB
	18GHz ~ 40GHz	2.29 dB

This uncertainty represents an expanded uncertainty expressed at approximately the 95% confidence level using a coverage factor of k=2.



A D T

2.2 TEST SITE AND INSTRUMENTS

DESCRIPTION & MANUFACTURER	MODEL NO.	SERIAL NO.	DATE OF CALIBRATION	DUE DATE OF CALIBRATION
Test Receiver ROHDE & SCHWARZ	ESCI	100424	Oct. 06, 2014	Oct. 05, 2015
Spectrum Analyzer ROHDE & SCHWARZ	FSU 43	100115	Dec. 18, 2013	Dec. 17, 2014
			Dec. 18, 2014	Dec. 17, 2015
BILOG Antenna SCHWARZBECK	VULB9168	9168-155	Feb. 26, 2014	Feb. 25, 2015
HORN Antenna SCHWARZBECK	BBHA 9120D	9120D-404	Jan. 05, 2014	Jan. 04, 2015
			Jan. 05, 2015	Jan. 04, 2016
HORN Antenna SCHWARZBECK	BBHA 9170	BBHA9170241	Feb. 17, 2014	Feb. 16, 2015
Preamplifier Agilent	8449B	3008A01961	Oct. 18, 2014	Oct. 17, 2015
Preamplifier Agilent	8447D	2944A10738	Oct. 18, 2014	Oct. 17, 2015
RF signal cable HUBER+SUHNNER	SUCOFLEX 104	309220/4	Aug. 09, 2014	Aug. 08, 2015
RF signal cable HUBER+SUHNNER	SUCOFLEX 104	250724/4	Aug. 09, 2014	Aug. 08, 2015
RF signal cable HUBER+SUHNNER	SUCOFLEX 104	295012/4	Aug. 09, 2014	Aug. 08, 2015
Software BV ADT	ADT_Radiated_ V7.6.15.9.4	NA	NA	NA
Antenna Tower inn-co GmbH	MA 4000	010303	NA	NA
Antenna Tower Controller inn-co GmbH	CO2000	019303	NA	NA
Turn Table BV ADT	TT100.	TT93021704	NA	NA
Turn Table Controller BV ADT	SC100.	SC93021704	NA	NA
Mini-Circuits Power Splitter	ZN2PD-9G	NA	Apr. 25, 2014	Apr. 24, 2015
JFW 20dB attenuation	50HF-020-SMA	NA	NA	NA

NOTE: 1. The calibration interval of the above test instruments is 12 months and the calibrations are traceable to NML/ROC and NIST/USA.

2. The test was performed in HwaYa Chamber 4.

3. The horn antenna and HP preamplifier (model: 8449B) are used only for the measurement of emission frequency above 1GHz if tested.

4. The FCC Site Registration No. is 460141.

5. The IC Site Registration No. is IC7450F-4.



A D T

3 GENERAL INFORMATION

3.1 GENERAL DESCRIPTION OF EUT

EUT	Mobile Computer
MODEL NO.	RS30
POWER SUPPLY	3.8Vdc (Battery) 5Vdc (Adapter)
MODULATION TYPE	GSM, GPRS: GMSK EDGE: 8PSK WCDMA: BPSK, QPSK HSPDA: BPSK HUPDA: QPSK
FREQUENCY RANGE	GSM, GPRS, EDGE: 824.2MHz ~ 848.8MHz WCDMA: 826.4MHz ~ 846.6MHz
MAX. ERP POWER	GSM: 928.966mW (29.68dBm) EDGE: 899.498mW (29.54dBm) WCDMA: 72.946mW (18.63dBm)
ANTENNA TYPE	PIFA antenna with -4.90dBi gain
ANTENNA CONNECTOR	Spring
DATA CABLE	1.0m shielded USB cable without core 1.6m non-shielded snap-on cable with one core
DATA CABLE	Refer to users' manual
ACCESSORY DEVICES	Adapter, Battery

NOTE:

1. The EUT consumes power from the following adapter and battery.

ADAPTER	
BRAND	Sunny COMPUTER TECHNOLOGY CO., LTD.
MODEL	SYS1460-1005
INPUT POWER	100-240Vac, 50-60Hz, 1.0A
OUTPUT POWER	5Vdc, 2A

BATTERY	
BRAND	CIPHERLAB
MODEL	BA-0093A1
POWER RATING	3.8Vdc, 3000mAh, 11.4wh

2. The above EUT information is declared by manufacturer and for more detailed features description, please refer to the manufacturer's specifications or User's Manual.

3.2 CONFIGURATION OF SYSTEM UNDER TEST

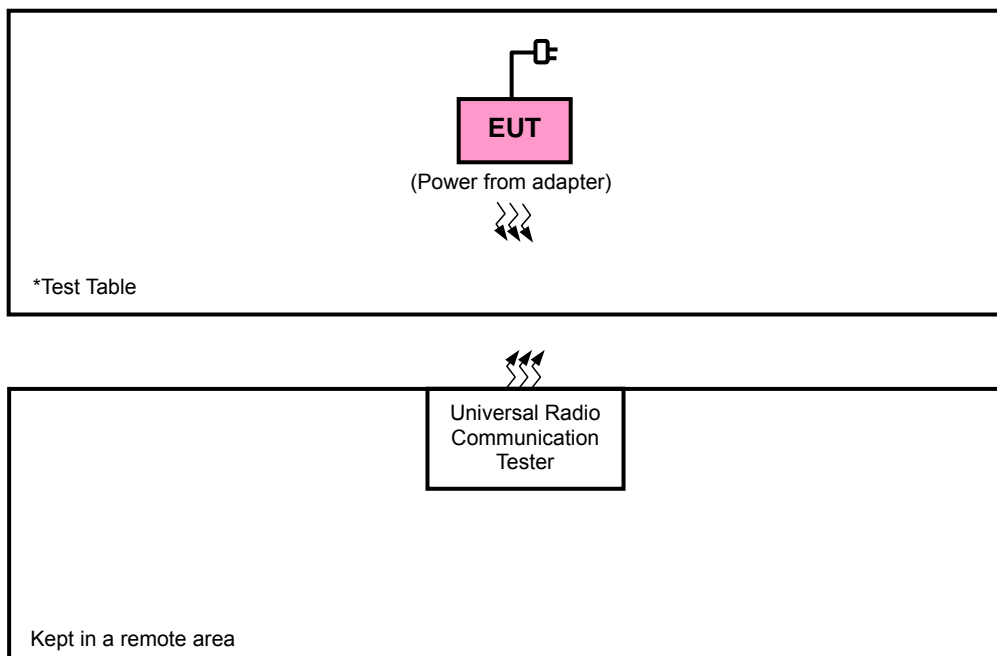

3.3 DESCRIPTION OF SUPPORT UNITS

The EUT has been tested as an independent unit together with other necessary accessories or support units. The following support units or accessories were used to form a representative test configuration during the tests.

NO.	PRODUCT	BRAND	MODEL NO.	SERIAL NO.	FCC ID
1	UNIVERSAL RADIO COMMUNICATION TESTER	R&S	CMU200	123112	NA

NO.	SIGNAL CABLE DESCRIPTION OF THE ABOVE SUPPORT UNITS
1	NA

NOTE:

1. All power cords of the above support units are non shielded (1.8m).
2. Item 1 acted as a communication partner to transfer data.



3.4 TEST ITEM AND TEST CONFIGURATION

Pre-Scan has been conducted to determine the worst-case mode from all possible combinations between available modulations, data rates, XYZ axis and antenna ports. The worst case was found when positioned on **Y-plane**. Following channel(s) was (were) selected for the final test as listed below:

GSM MODE

EUT CONFIGURE MODE	TEST ITEM	AVAILABLE CHANNEL	TESTED CHANNEL	MODE
-	ERP	128 to 251	128, 189, 251	GSM, EDGE
-	FREQUENCY STABILITY	128 to 251	189	GSM
-	OCCUPIED BANDWIDTH	128 to 251	128, 189, 251	GSM, GPRS, EDGE
-	BAND EDGE	128 to 251	128, 251	GSM, GPRS, EDGE
-	PEAK TO AVERAGE RATIO	128 to 251	128, 189, 251	GSM, GPRS, EDGE
-	CONDCUDETED EMISSION	128 to 251	128, 189, 251	GSM, GPRS, EDGE
-	RADIATED EMISSION BELOW 1GHz	128 to 251	128	GSM, EDGE
-	RADIATED EMISSION ABOVE 1GHz	128 to 251	128, 189, 251	GSM, EDGE

WCDMA MODE

EUT CONFIGURE MODE	TEST ITEM	AVAILABLE CHANNEL	TESTED CHANNEL	MODE
-	ERP	4132 to 4233	4132, 4182, 4233	WCDMA
-	FREQUENCY STABILITY	4132 to 4233	4182	WCDMA
-	OCCUPIED BANDWIDTH	4132 to 4233	4132, 4182, 4233	WCDMA, HSDPA, HSUPA
-	BAND EDGE	4132 to 4233	4132, 4233	WCDMA, HSDPA, HSUPA
-	PEAK TO AVERAGE RATIO	4132 to 4233	4132, 4182, 4233	WCDMA, HSDPA, HSUPA
-	CONDCUDETED EMISSION	4132 to 4233	4132, 4182, 4233	WCDMA, HSDPA, HSUPA
-	RADIATED EMISSION BELOW 1GHz	4132 to 4233	4132	WCDMA
-	RADIATED EMISSION ABOVE 1GHz	4132 to 4233	4132, 4182, 4233	WCDMA

TEST CONDITION:

TEST ITEM	ENVIRONMENTAL CONDITIONS	INPUT POWER	TESTED BY
ERP	24deg. C, 63%RH	120Vac, 60Hz	Alan Wu
FREQUENCY STABILITY	24deg. C, 64%RH	3.9Vdc	Match Tsui
OCCUPIED BANDWIDTH	24deg. C, 64%RH	120Vac, 60Hz	Match Tsui
BAND EDGE	24deg. C, 64%RH	120Vac, 60Hz	Match Tsui
PEAK TO AVERAGE RATIO	24deg. C, 64%RH	120Vac, 60Hz	Match Tsui
CONDCUDETED EMISSION	24deg. C, 64%RH	120Vac, 60Hz	Match Tsui
RADIATED EMISSION	27deg. C, 66%RH	120Vac, 60Hz	Alan Wu



A D T

3.5 EUT OPERATING CONDITIONS

The EUT makes a call to the communication simulator. The communication simulator station system controlled a EUT to export maximum output power under transmission mode and specific channel frequency

3.6 GENERAL DESCRIPTION OF APPLIED STANDARDS

The EUT is a RF product. According to the specifications of the manufacturer, it must comply with the requirements of the following standards:

FCC 47 CFR Part 2

FCC 47 CFR Part 22

ANSI/TIA/EIA-603-C 2004

NOTE: All test items have been performed and recorded as per the above standards.

4 TEST TYPES AND RESULTS

4.1 OUTPUT POWER MEASUREMENT

4.1.1 LIMITS OF OUTPUT POWER MEASUREMENT

Mobile / Portable station are limited to 7 watts e.r.p.

4.1.2 TEST PROCEDURES

ERP MEASUREMENT:

- a. All measurements were done at low, middle and high operational frequency range. RBW and VBW is 1MHz for GSM and 5MHz for WCDMA mode.
- b. Substitution method is used for E.I.R.P measurement. In the semi-anechoic chamber, EUT placed on the 0.8m height of Turn Table, rotated the table around 360 degrees to search the maximum radiation power and receiver antenna shall be rotated vertical and horizontal polarization and moved height from 1m to 4m to find the maximum polar radiated power. The "Read Value" is the spectrum reading the maximum power value.
- c. The substitution horn antenna is substituted for EUT at the same position and signals generator export the CW signal to the substitution antenna via a TX cable. Rotated the Turn Table and moved receiving antenna to find the maximum radiation power. Adjust output power level of S.G to get a Value of spectrum reading equal to "Read Value" of step b. Record the power level of S.G
- d. $EIRP = \text{Output power level of S.G} - \text{TX cable loss} + \text{Antenna gain of substitution horn.}$ E.R.P power can be calculated form E.I.R.P power by subtracting the gain of dipole, $E.R.P \text{ power} = E.I.R.P \text{ power} - 2.15\text{dBi.}$

CONDUCTED POWER MEASUREMENT:

The EUT was set up for the maximum power with GSM & WCDMA link data modulation and link up with simulator. Set the EUT to transmit under low, middle and high channel and record the power level shown on simulator.

4.1.3 TEST SETUP

ERP MEASUREMENT:

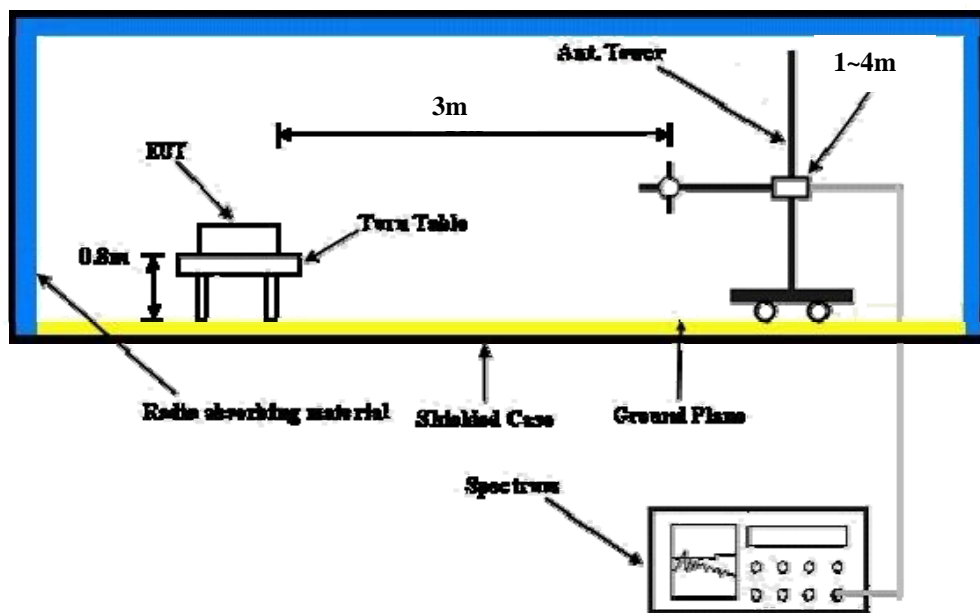

For the actual test configuration, please refer to the attached file (Test Setup Photo).

CONDUCTED POWER MEASUREMENT:

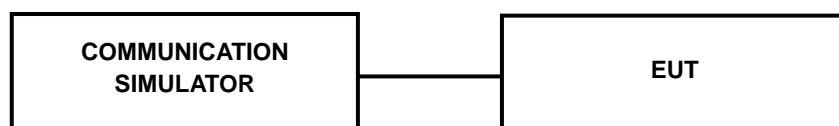

For the actual test configuration, please refer to the attached file (Test Setup Photo).



4.1.4 TEST RESULTS

CONDUCTED OUTPUT POWER (dBm)

Band	GSM850		
Channel	128	189	251
Frequency (MHz)	824.2	836.4	848.8
GSM	32.29	32.31	32.30
GPRS 8	32.23	32.25	32.24
GPRS 10	31.53	31.55	31.54
GPRS 11	29.86	29.88	29.87
GPRS 12	28.87	28.89	28.88
EDGE 8 (MCS1)	32.22	32.24	32.23
EDGE 10 (MCS1)	31.50	31.52	31.51
EDGE 11 (MCS1)	29.85	29.87	29.86
EDGE 12 (MCS1)	28.85	28.87	28.86
EDGE 8 (MCS9)	26.43	26.45	26.44
EDGE 10 (MCS9)	25.20	25.22	25.21
EDGE 11 (MCS9)	22.99	23.01	23.00
EDGE 12 (MCS9)	21.72	21.74	21.73

Band	WCDMA V		
Channel	4132	4182	4233
Frequency (MHz)	826.4	836.4	846.6
RMC 12.2K	22.54	22.52	22.45
HSDPA Subtest-1	21.56	21.52	21.43
HSDPA Subtest-2	21.52	21.53	21.41
HSDPA Subtest-3	21.08	21.02	20.96
HSDPA Subtest-4	21.04	21.00	20.92
HSUPA Subtest-1	21.60	21.50	21.50
HSUPA Subtest-2	19.59	19.54	19.51
HSUPA Subtest-3	19.64	19.55	19.51
HSUPA Subtest-4	19.08	19.00	18.98
HSUPA Subtest-5	20.61	20.57	20.51



A D T

ERP POWER (dBm)**FOR GSM MODE:**

MODE		TX channel 128					
ANTENNA POLARITY & TEST DISTANCE: HORIZONTAL AT 3 M							
No.	Freq. (MHz)	Reading (dBm)	S.G Power Value (dBm)	Correction Factor (dB)	ERP (dBm)	Limit (dBm)	Margin (dB)
1	824.20	-1.51	29.67	0.01	29.68	38.45	-8.77
ANTENNA POLARITY & TEST DISTANCE: VERTICAL AT 3 M							
No.	Freq. (MHz)	Reading (dBm)	S.G Power Value (dBm)	Correction Factor (dB)	ERP (dBm)	Limit (dBm)	Margin (dB)
1	824.20	-6.40	25.51	0.01	25.52	38.45	-12.93

MODE		TX channel 189					
ANTENNA POLARITY & TEST DISTANCE: HORIZONTAL AT 3 M							
No.	Freq. (MHz)	Reading (dBm)	S.G Power Value (dBm)	Correction Factor (dB)	ERP (dBm)	Limit (dBm)	Margin (dB)
1	836.40	-2.79	28.25	0.29	28.54	38.45	-9.91
ANTENNA POLARITY & TEST DISTANCE: VERTICAL AT 3 M							
No.	Freq. (MHz)	Reading (dBm)	S.G Power Value (dBm)	Correction Factor (dB)	ERP (dBm)	Limit (dBm)	Margin (dB)
1	836.40	-10.72	20.97	0.29	21.26	38.45	-17.19

MODE		TX channel 251					
ANTENNA POLARITY & TEST DISTANCE: HORIZONTAL AT 3 M							
No.	Freq. (MHz)	Reading (dBm)	S.G Power Value (dBm)	Correction Factor (dB)	ERP (dBm)	Limit (dBm)	Margin (dB)
1	848.80	-2.59	27.87	0.51	28.38	38.45	-10.07
ANTENNA POLARITY & TEST DISTANCE: VERTICAL AT 3 M							
No.	Freq. (MHz)	Reading (dBm)	S.G Power Value (dBm)	Correction Factor (dB)	ERP (dBm)	Limit (dBm)	Margin (dB)
1	848.80	-9.50	21.81	0.51	22.32	38.45	-16.13

NOTE: ERP (dBm) = S.G Power Value (dBm) + Correction Factor (dB).



A D T

FOR EDGE MODE:

MODE		TX channel 128					
ANTENNA POLARITY & TEST DISTANCE: HORIZONTAL AT 3 M							
No.	Freq. (MHz)	Reading (dBm)	S.G Power Value (dBm)	Correction Factor (dB)	ERP (dBm)	Limit (dBm)	Margin (dB)
1	824.20	-1.65	29.53	0.01	29.54	38.45	-8.91
ANTENNA POLARITY & TEST DISTANCE: VERTICAL AT 3 M							
No.	Freq. (MHz)	Reading (dBm)	S.G Power Value (dBm)	Correction Factor (dB)	ERP (dBm)	Limit (dBm)	Margin (dB)
1	824.20	-6.85	25.06	0.01	25.07	38.45	-13.38

MODE		TX channel 189					
ANTENNA POLARITY & TEST DISTANCE: HORIZONTAL AT 3 M							
No.	Freq. (MHz)	Reading (dBm)	S.G Power Value (dBm)	Correction Factor (dB)	ERP (dBm)	Limit (dBm)	Margin (dB)
1	836.40	-2.94	28.10	0.29	28.39	38.45	-10.06
ANTENNA POLARITY & TEST DISTANCE: VERTICAL AT 3 M							
No.	Freq. (MHz)	Reading (dBm)	S.G Power Value (dBm)	Correction Factor (dB)	ERP (dBm)	Limit (dBm)	Margin (dB)
1	836.40	-11.60	20.09	0.29	20.38	38.45	-18.07

MODE		TX channel 251					
ANTENNA POLARITY & TEST DISTANCE: HORIZONTAL AT 3 M							
No.	Freq. (MHz)	Reading (dBm)	S.G Power Value (dBm)	Correction Factor (dB)	ERP (dBm)	Limit (dBm)	Margin (dB)
1	848.80	-2.86	27.60	0.51	28.11	38.45	-10.34
ANTENNA POLARITY & TEST DISTANCE: VERTICAL AT 3 M							
No.	Freq. (MHz)	Reading (dBm)	S.G Power Value (dBm)	Correction Factor (dB)	ERP (dBm)	Limit (dBm)	Margin (dB)
1	848.80	-10.27	21.04	0.51	21.55	38.45	-16.90

NOTE: ERP (dBm) = S.G Power Value (dBm) + Correction Factor (dB).



A D T

FOR WCDMA MODE:

MODE		TX channel 4132					
ANTENNA POLARITY & TEST DISTANCE: HORIZONTAL AT 3 M							
No.	Freq. (MHz)	Reading (dBm)	S.G Power Value (dBm)	Correction Factor (dB)	ERP (dBm)	Limit (dBm)	Margin (dB)
1	826.40	-12.96	18.15	0.06	18.21	38.45	-20.24
ANTENNA POLARITY & TEST DISTANCE: VERTICAL AT 3 M							
No.	Freq. (MHz)	Reading (dBm)	S.G Power Value (dBm)	Correction Factor (dB)	ERP (dBm)	Limit (dBm)	Margin (dB)
1	826.40	-17.99	13.79	0.06	13.85	38.45	-24.60

MODE		TX channel 4182					
ANTENNA POLARITY & TEST DISTANCE: HORIZONTAL AT 3 M							
No.	Freq. (MHz)	Reading (dBm)	S.G Power Value (dBm)	Correction Factor (dB)	ERP (dBm)	Limit (dBm)	Margin (dB)
1	836.40	-13.95	17.09	0.29	17.38	38.45	-21.07
ANTENNA POLARITY & TEST DISTANCE: VERTICAL AT 3 M							
No.	Freq. (MHz)	Reading (dBm)	S.G Power Value (dBm)	Correction Factor (dB)	ERP (dBm)	Limit (dBm)	Margin (dB)
1	836.40	-18.21	13.48	0.29	13.77	38.45	-24.68

MODE		TX channel 4233					
ANTENNA POLARITY & TEST DISTANCE: HORIZONTAL AT 3 M							
No.	Freq. (MHz)	Reading (dBm)	S.G Power Value (dBm)	Correction Factor (dB)	ERP (dBm)	Limit (dBm)	Margin (dB)
1	846.60	-12.22	18.16	0.47	18.63	38.45	-19.82
ANTENNA POLARITY & TEST DISTANCE: VERTICAL AT 3 M							
No.	Freq. (MHz)	Reading (dBm)	S.G Power Value (dBm)	Correction Factor (dB)	ERP (dBm)	Limit (dBm)	Margin (dB)
1	846.60	-18.26	12.96	0.47	13.43	38.45	-25.02

NOTE: ERP (dBm) = S.G Power Value (dBm) + Correction Factor (dB).

4.2 FREQUENCY STABILITY MEASUREMENT

4.2.1 LIMITS OF FREQUENCY STABILITY MEASUREMENT

1.5 ppm is for base and fixed station. 2.5 ppm is for mobile station.

4.2.2 TEST PROCEDURE

- Device is placed at the oven room. The oven room could control the temperatures and humidity. Power warm up is at least 15 min and power applied should perform before recording frequency error.
- EUT is connected the external power supply to control the AC input power. The test voltage range is from minimum to maximum working voltage. Each step shall be record the frequency error rate.
- The temperature range step is 10 degrees in this test items. All temperature levels shall be hold the $\pm 0.5^{\circ}\text{C}$ during the measurement testing. The each temperature step shall be at least 0.5 hours, consider the EUT could be test under the stability condition.

NOTE: The frequency error was recorded frequency error from the communication simulator.

4.2.3 TEST SETUP

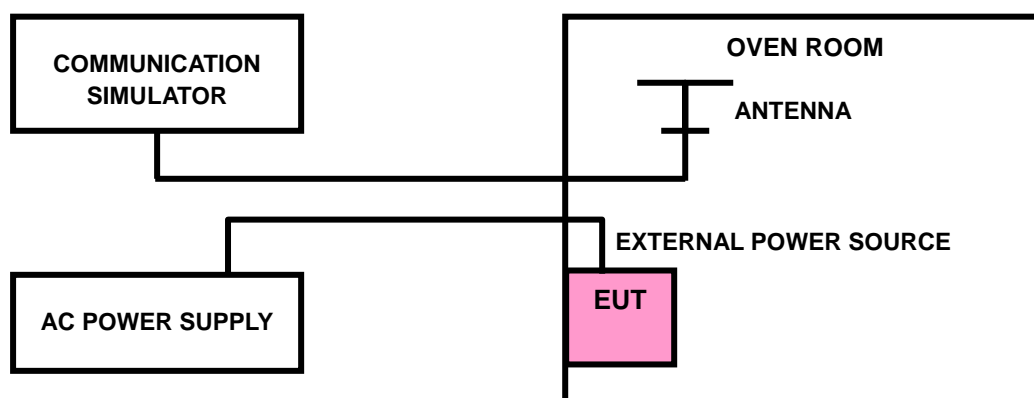



4.2.4 TEST RESULTS

FREQUENCY ERROR vs. VOLTAGE

VOLTAGE (Volts)	FREQUENCY ERROR (ppm)		LIMIT (ppm)
	GSM	WCDMA	
4.2	-0.014	-0.014	2.5
3.9	-0.013	-0.013	2.5
3.6	-0.013	-0.011	2.5

NOTE: The applicant defined the normal working voltage is from 3.65Vdc to 4.35Vdc.

FREQUENCY ERROR vs. TEMPERATURE.

TEMP. (°C)	FREQUENCY ERROR (ppm)		LIMIT (ppm)
	GSM	WCDMA	
50	-0.025	-0.038	2.5
40	-0.029	-0.035	2.5
30	-0.020	-0.018	2.5
20	-0.013	-0.013	2.5
10	-0.023	-0.023	2.5
0	-0.020	-0.029	2.5
-10	-0.029	-0.035	2.5
-20	-0.037	-0.045	2.5

4.3 OCCUPIED BANDWIDTH MEASUREMENT

4.3.1 TEST PROCEDURES

The EUT makes a call to the communication simulator. All measurements were done at low, middle and high operational frequency range. The communication simulator station system controlled a EUT to export maximum output power under transmission mode and specific channel frequency. Use OBW measurement function of Spectrum analyzer to measure 99 % occupied bandwidth.

4.3.2 TEST SETUP

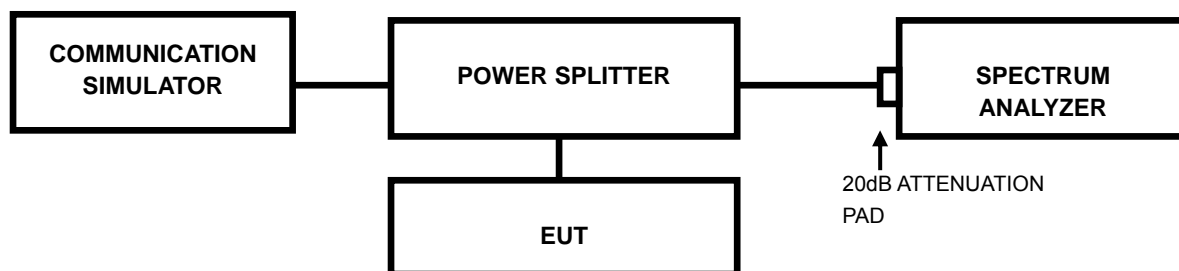



A D T

4.3.3 TEST RESULTS

CHANNEL	FREQ. (MHz)	99% OCCUPIED BANDWIDTH (kHz)			CHANNEL	FREQ. (MHz)	99% OCCUPIED BANDWIDTH (MHz)		
		GSM	GPRS	EDGE			WCDMA	HSDPA	HSUPA
128	824.2	255	260	250	4132	826.4	4.13	4.13	4.15
189	836.4	255	260	250	4182	836.4	4.17	4.18	4.18
251	848.8	255	255	255	4233	846.6	4.17	4.18	4.15

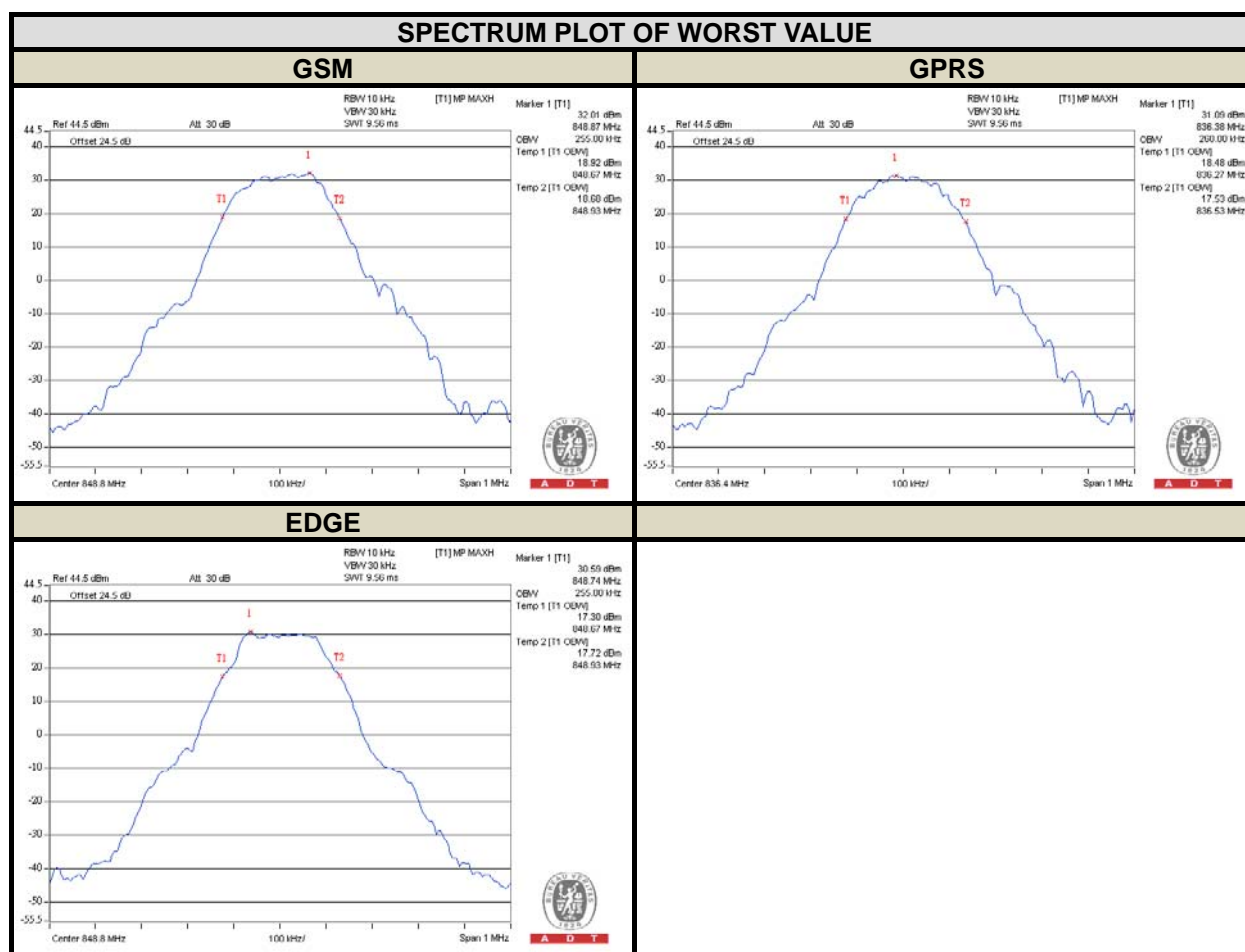



A D T

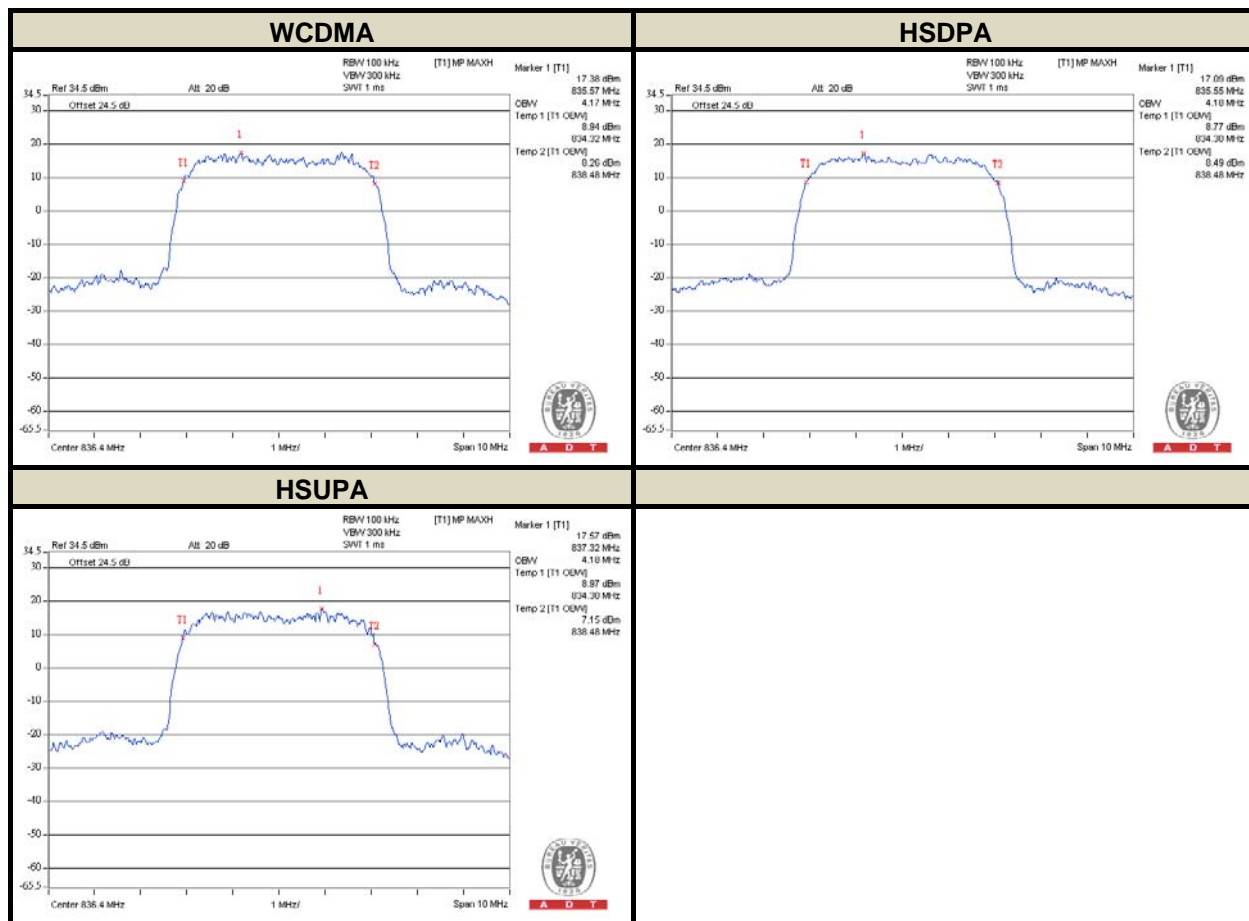

4.4 BAND EDGE MEASUREMENT

4.4.1 LIMITS OF BAND EDGE MEASUREMENT

Power of any emission outside of the authorized operating frequency ranges must be attenuated below the transmitting power (P) by a factor of at least $43 + 10 \log(P)$ dB. In the 1 MHz bands immediately outside and adjacent to the frequency block a resolution bandwidth of at least one percent of the emission bandwidth of the fundamental emission of the transmitter may be employed.

4.4.2 TEST SETUP

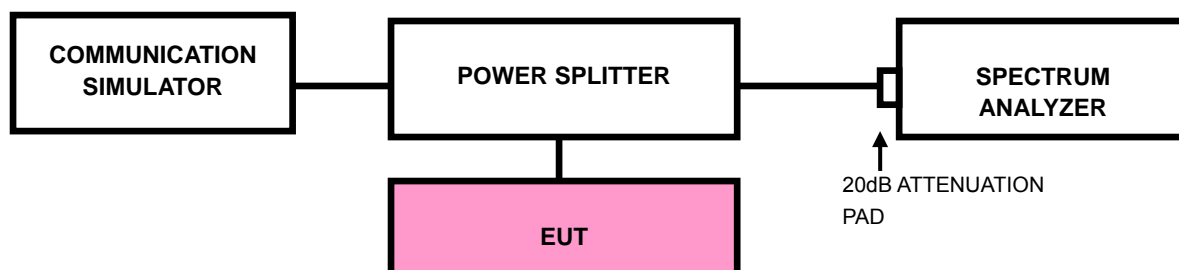

4.4.3 TEST PROCEDURES

- a. All measurements were done at low and high operational frequency range.
- b. The center frequency of spectrum is the band edge frequency and span is 1.5 MHz. RB of the spectrum is 3kHz and VB of the spectrum is 10kHz (GSM).
- c. The center frequency of spectrum is the band edge frequency and span is 10MHz. RB of the spectrum is 100kHz and VB of the spectrum is 300kHz (WCDMA/HSDPA/HSUPA).
- d. Record the max trace plot into the test report.

4.4.4 TEST RESULTS

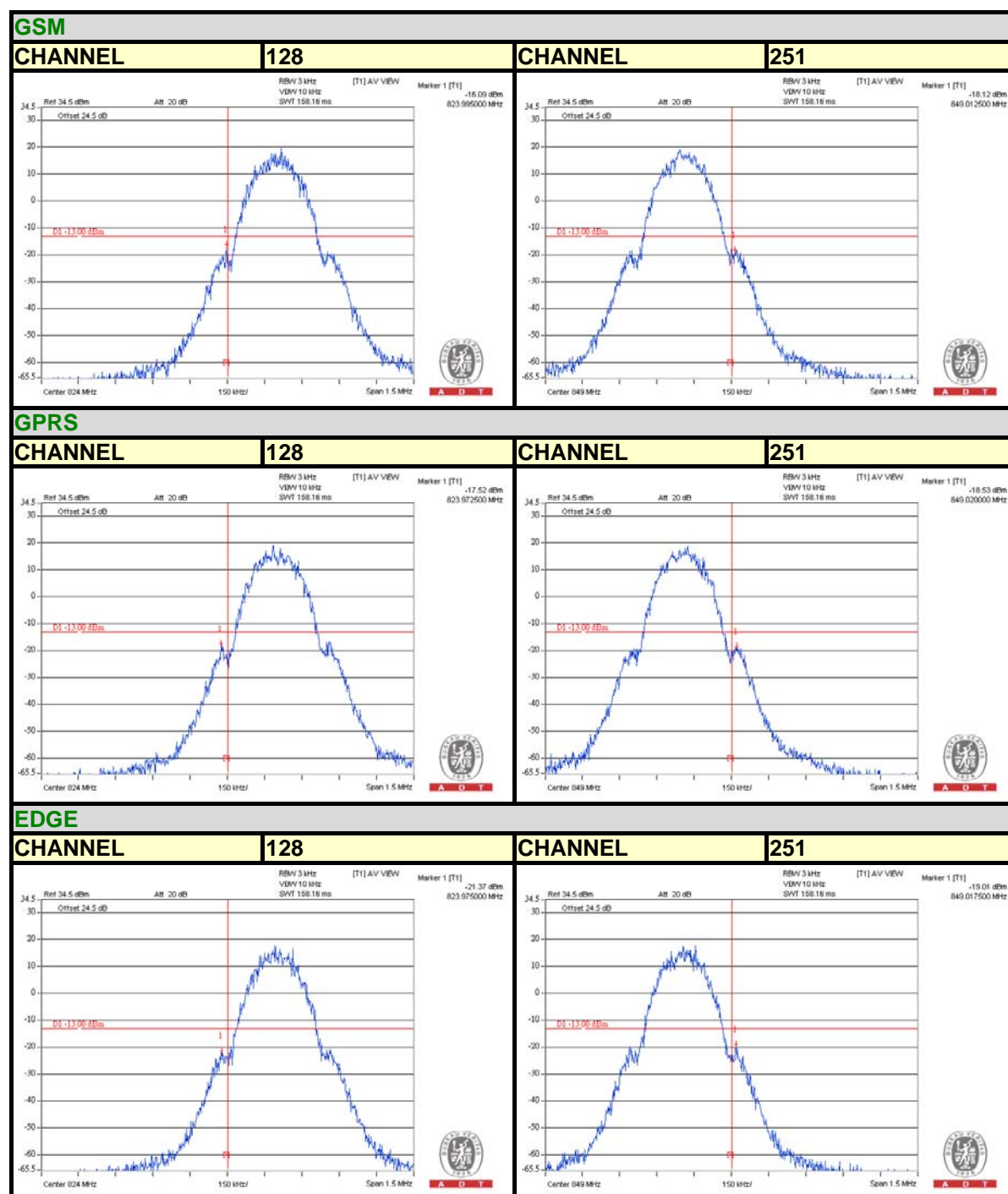



A D T

WCDMA

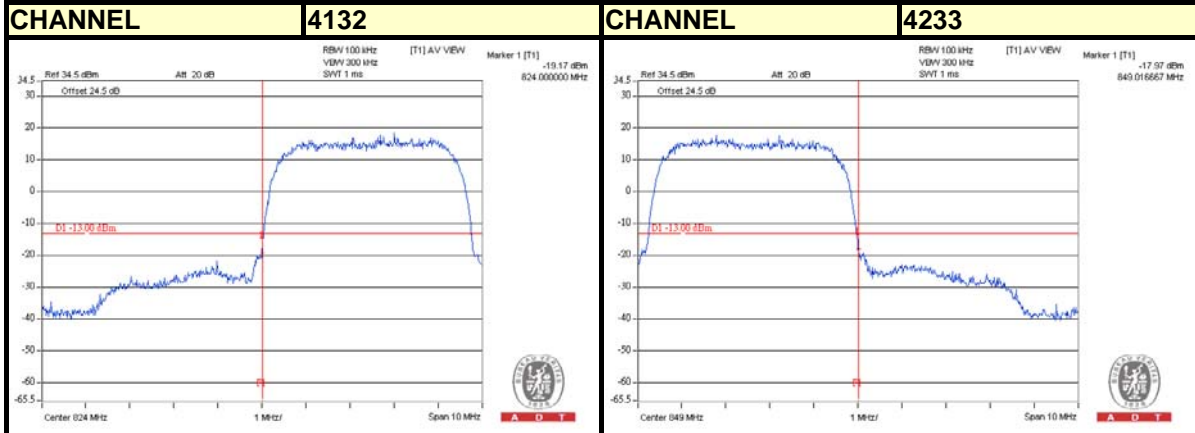

HSDPA

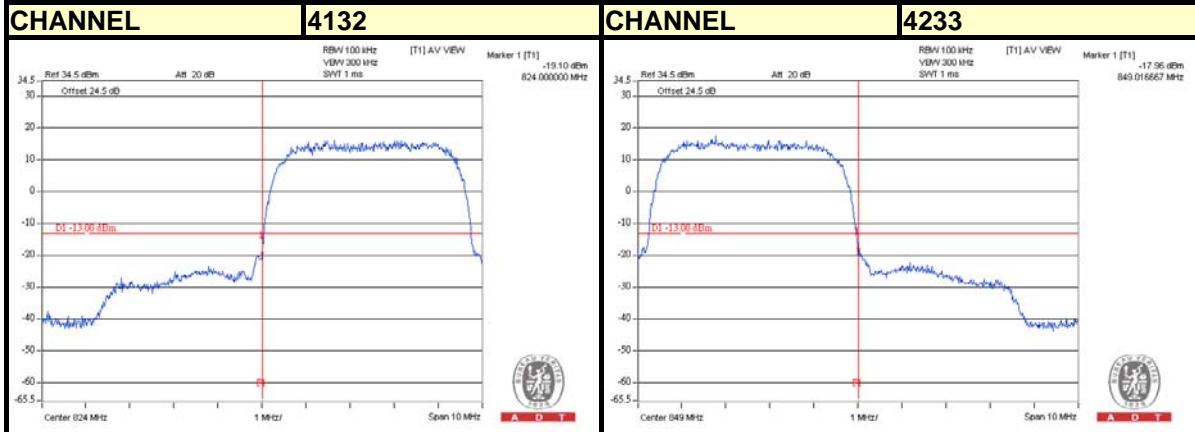

HSUPA

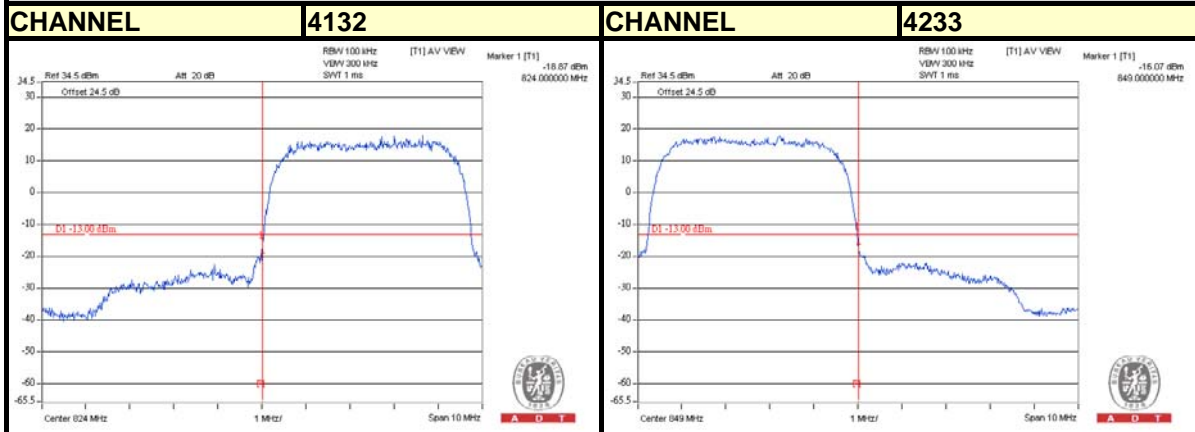

4.5 PEAK TO AVERAGE RATIO

4.5.1 LIMITS OF PEAK TO AVERAGE RATIO MEASUREMENT

In measuring transmissions in this band using an average power technique, the peak to-average ratio (PAR) of the transmission may not exceed 13 dB

4.5.2 TEST SETUP

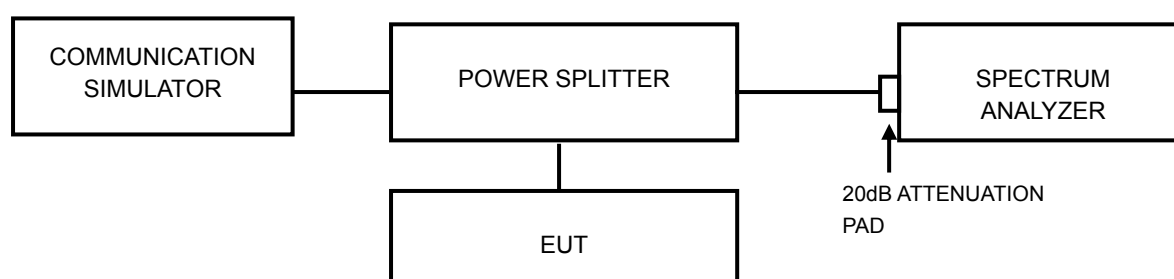

4.5.3 TEST PROCEDURES

- Set resolution/measurement bandwidth \geq signal's occupied bandwidth;
- Set the number of counts to a value that stabilizes the measured CCDF curve;
- Record the maximum PAPR level associated with a probability of 0.1%.



A D T

4.5.4 Test Results

CHANNEL	FREQ. (MHz)	Peak To Average Ratio (dB)			CHANNEL	FREQ. (MHz)	Peak To Average Ratio (dB)		
		GSM	GPRS	EDGE			WCDMA	HSDPA	HSUPA
128	824.2	3.00	2.49	3.35	4132	826.4	3.22	3.24	3.24
189	836.4	3.58	2.80	3.13	4182	836.4	3.05	3.26	3.06
251	848.8	2.60	2.88	4.59	4233	846.6	3.15	3.16	3.16





A D T



4.6 CONDUCTED SPURIOUS EMISSIONS

4.6.1 LIMITS OF CONDUCTED SPURIOUS EMISSIONS MEASUREMENT

The power of any emission outside of the authorized operating frequency ranges must be attenuated below the transmitting power (P) by a factor of at least $43 + 10 \log(P)$ dB. The emission limit equal to -13dBm .

4.6.2 TEST PROCEDURE

- a. The EUT makes a phone call to the communication simulator. All measurements were done at low, middle and high operational frequency range.
- b. Measuring frequency range is from 9 kHz to 9GHz. 20dB attenuation pad is connected with spectrum. RBW=1MHz and VBW=3MHz is used for conducted emission measurement.

4.6.3 TEST SETUP

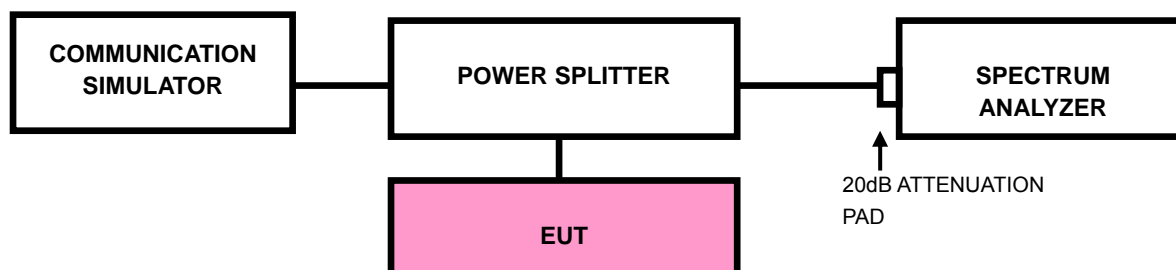

4.6.4 TEST RESULTS

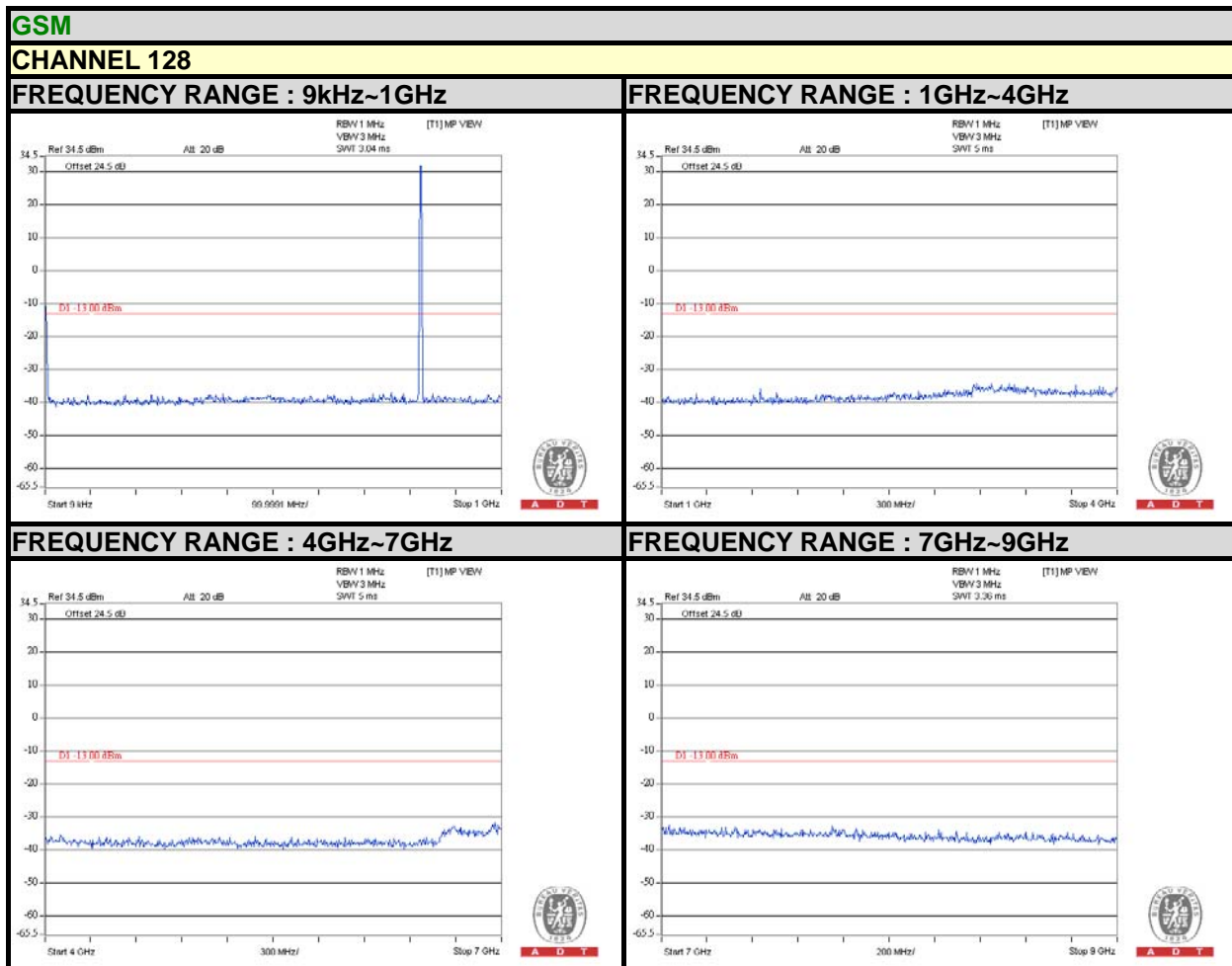



A D T

GSM

CHANNEL 189

FREQUENCY RANGE : 9kHz~1GHz

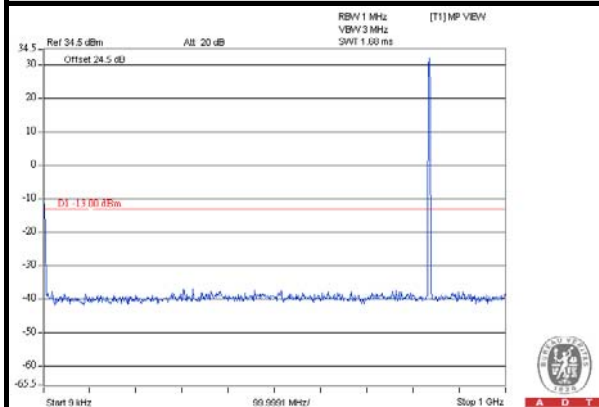

FREQUENCY RANGE : 1GHz~4GHz

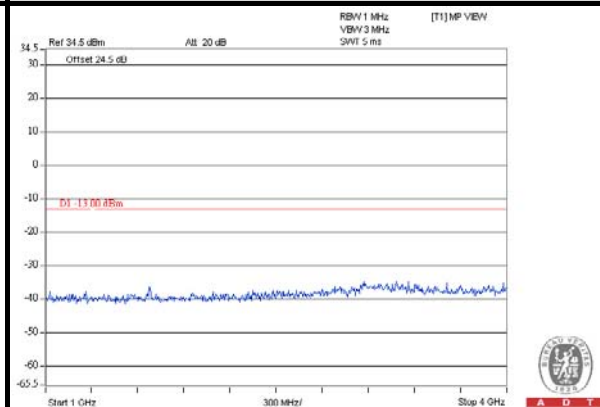

FREQUENCY RANGE : 4GHz~7GHz

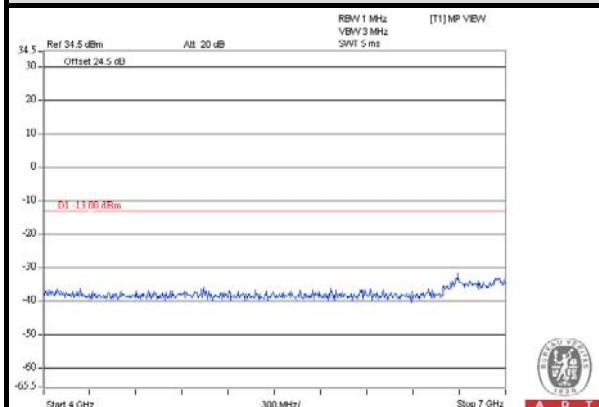

FREQUENCY RANGE : 7GHz~9GHz

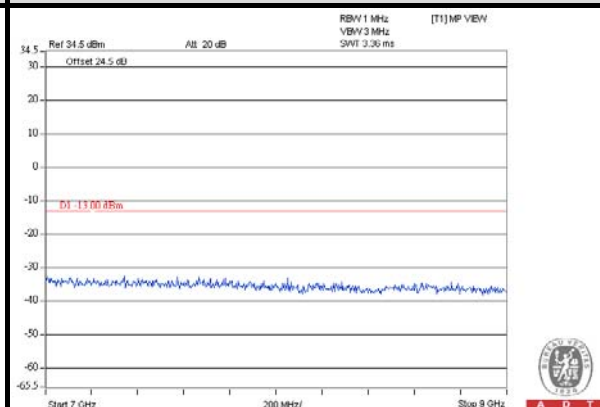



A D T

GSM

CHANNEL 251

FREQUENCY RANGE : 9kHz~1GHz

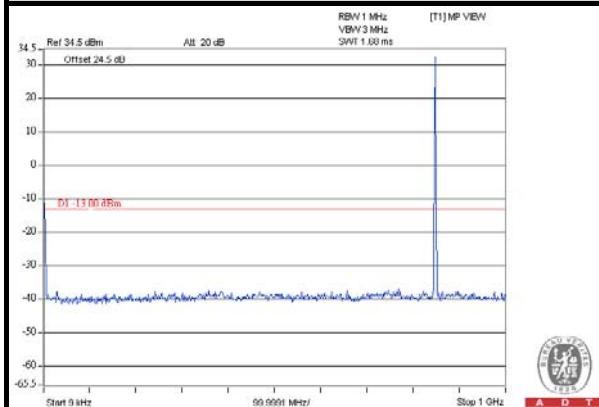

FREQUENCY RANGE : 1GHz~4GHz

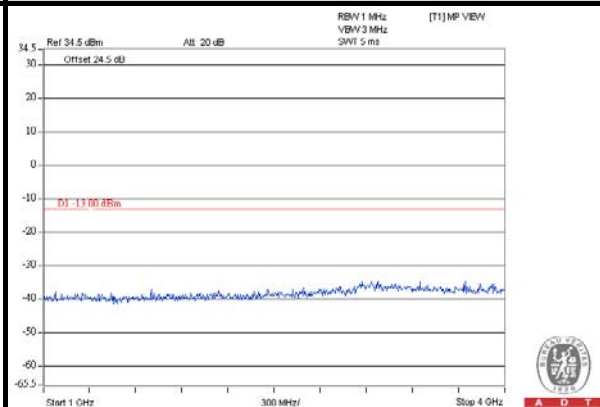

FREQUENCY RANGE : 4GHz~7GHz

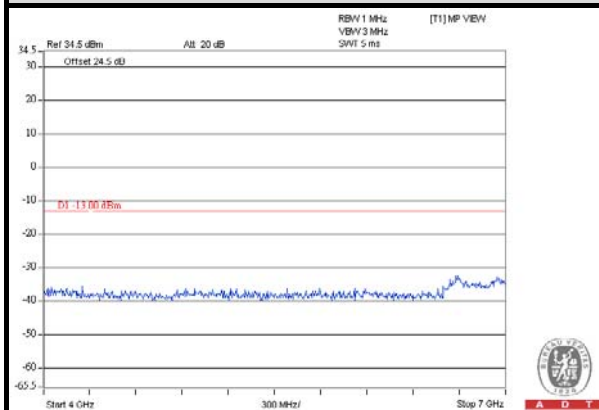

FREQUENCY RANGE : 7GHz~9GHz

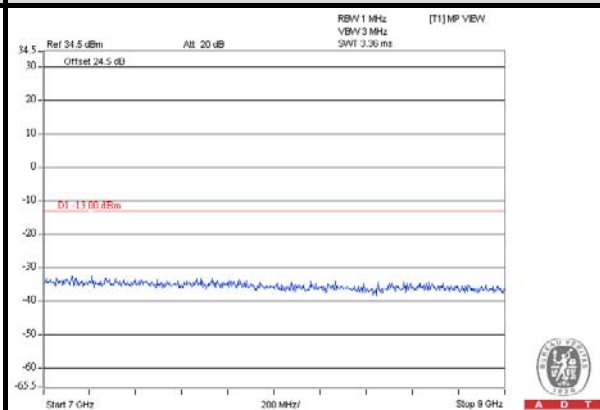



A D T

GPRS

CHANNEL 128

FREQUENCY RANGE : 9kHz~1GHz

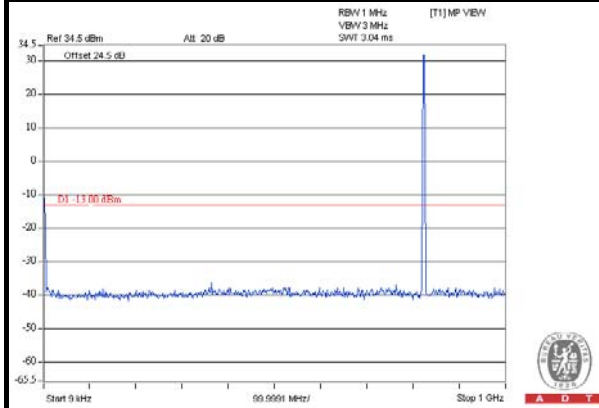

FREQUENCY RANGE : 1GHz~4GHz

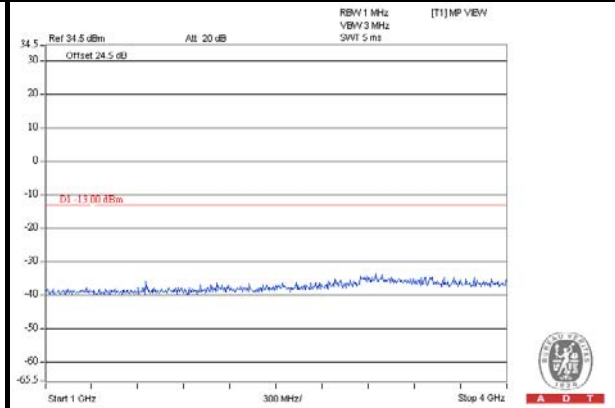

FREQUENCY RANGE : 4GHz~7GHz

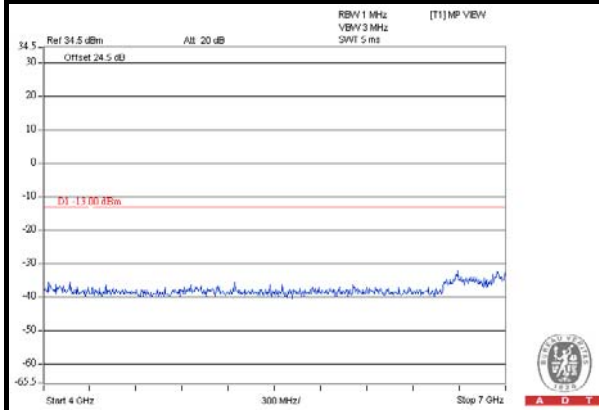

FREQUENCY RANGE : 7GHz~9GHz

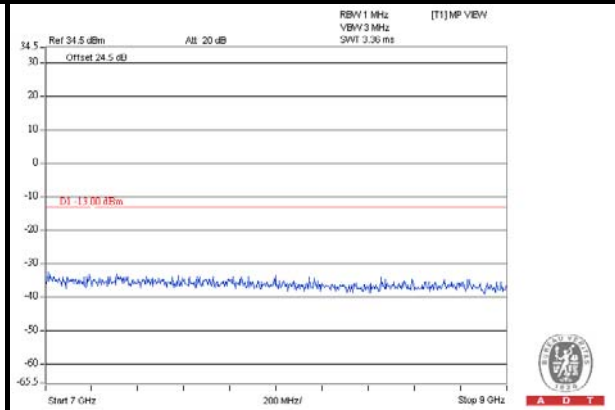



A D T

GPRS

CHANNEL 189

FREQUENCY RANGE : 9kHz~1GHz

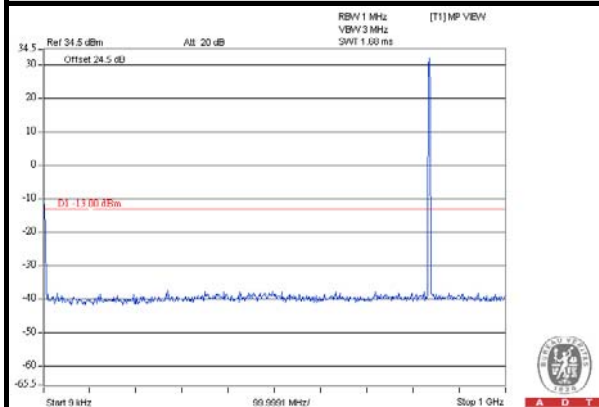

FREQUENCY RANGE : 1GHz~4GHz

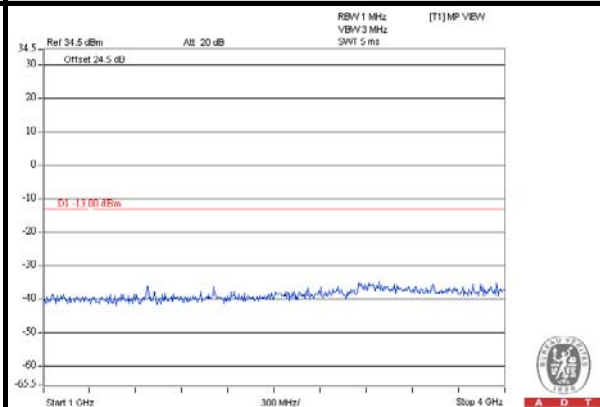

FREQUENCY RANGE : 4GHz~7GHz

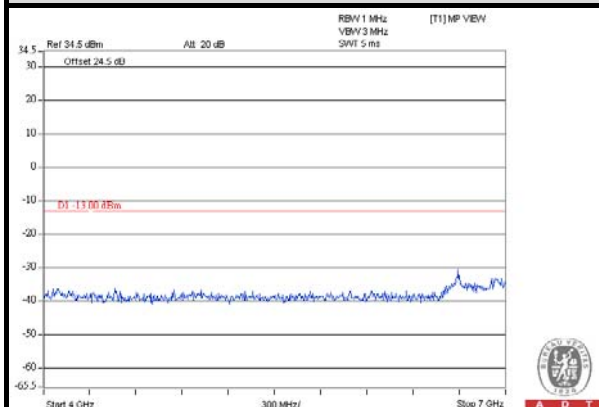

FREQUENCY RANGE : 7GHz~9GHz

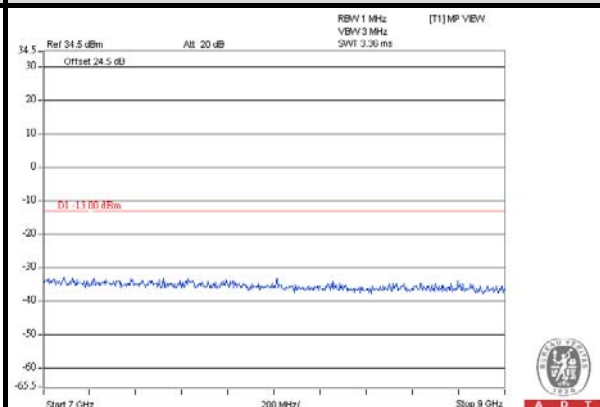



A D T

GPRS

CHANNEL 251

FREQUENCY RANGE : 9kHz~1GHz

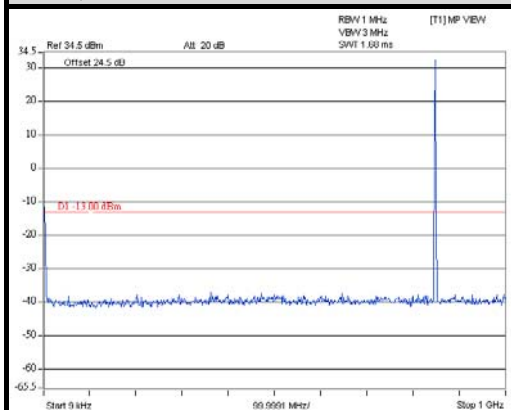

FREQUENCY RANGE : 1GHz~4GHz

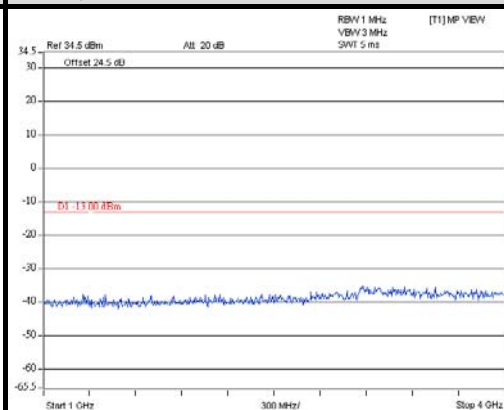

FREQUENCY RANGE : 4GHz~7GHz

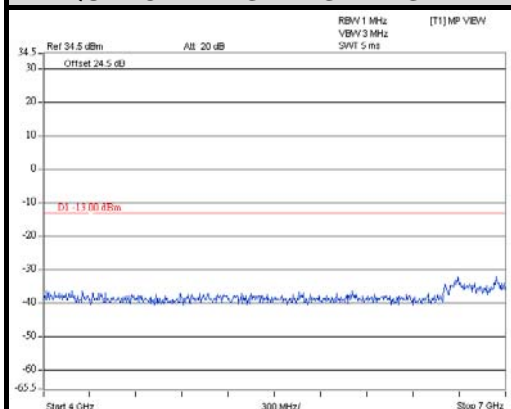

FREQUENCY RANGE : 7GHz~9GHz

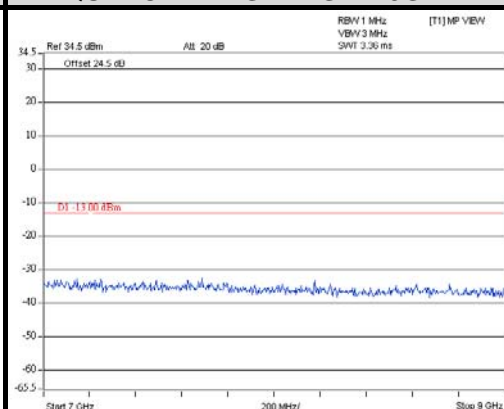



A D T

EDGE

CHANNEL 128

FREQUENCY RANGE : 9kHz~1GHz

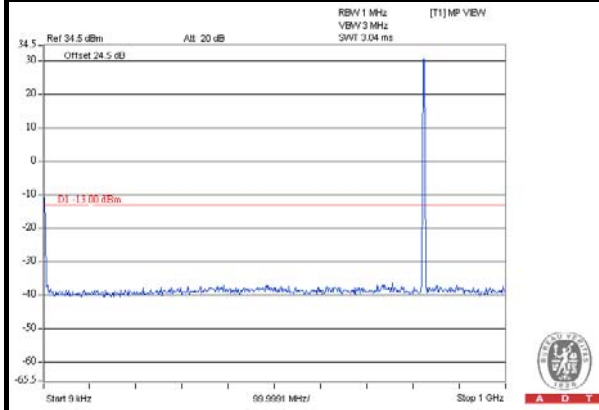

FREQUENCY RANGE : 1GHz~4GHz

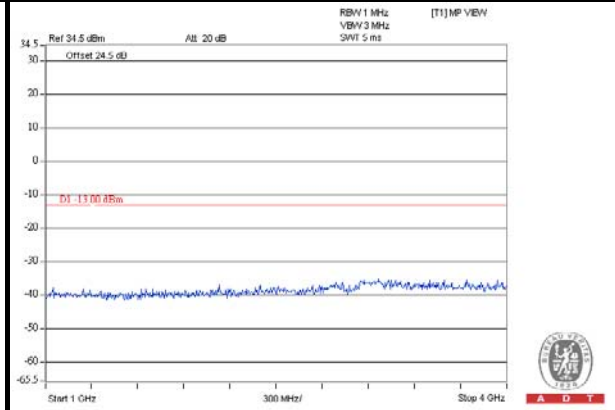

FREQUENCY RANGE : 4GHz~7GHz

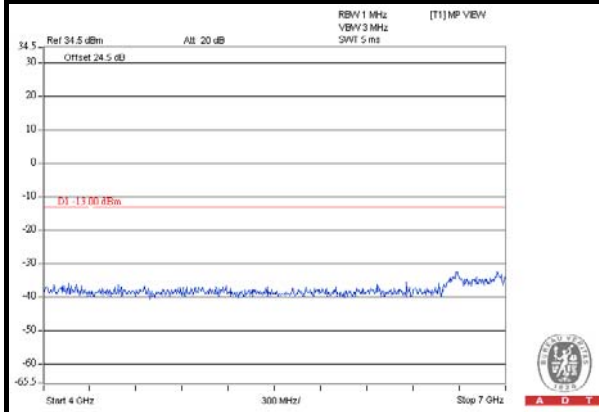

FREQUENCY RANGE : 7GHz~9GHz

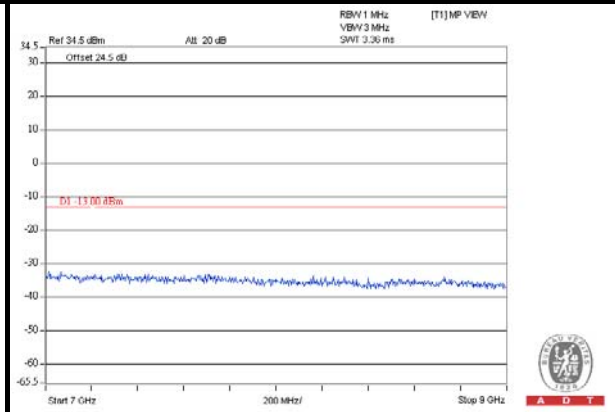



A D T

EDGE

CHANNEL 189

FREQUENCY RANGE : 9kHz~1GHz

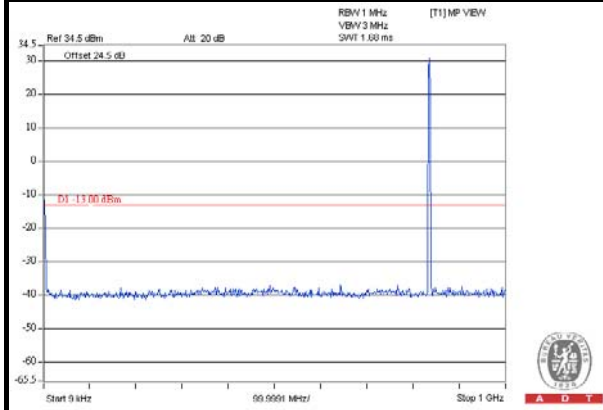

FREQUENCY RANGE : 1GHz~4GHz

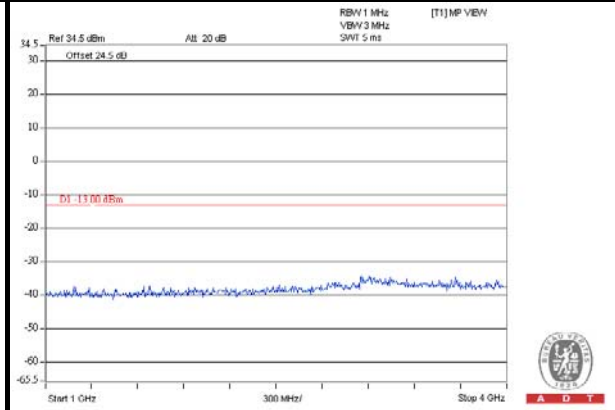

FREQUENCY RANGE : 4GHz~7GHz

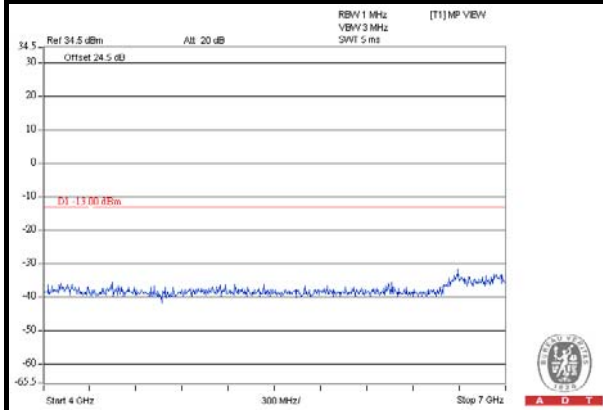

FREQUENCY RANGE : 7GHz~9GHz

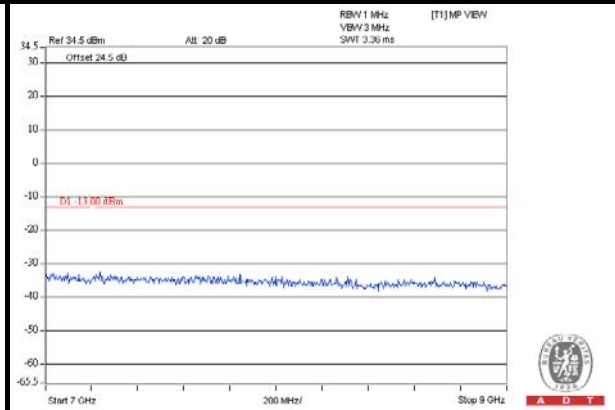



A D T

EDGE

CHANNEL 251

FREQUENCY RANGE : 9kHz~1GHz

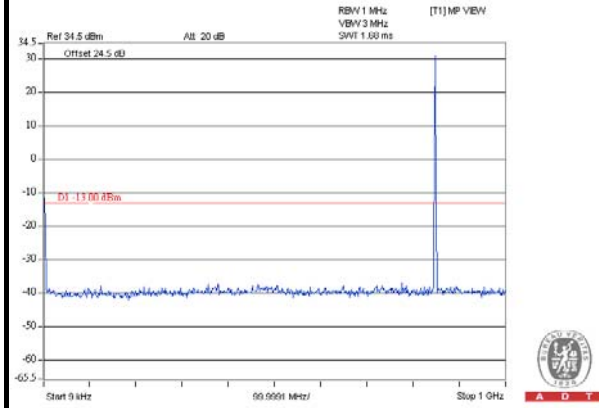

FREQUENCY RANGE : 1GHz~4GHz

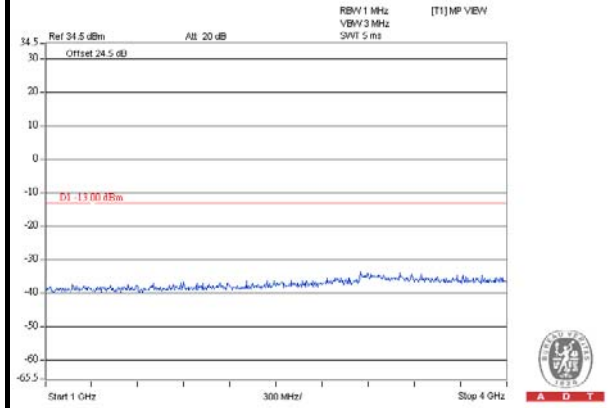

FREQUENCY RANGE : 4GHz~7GHz

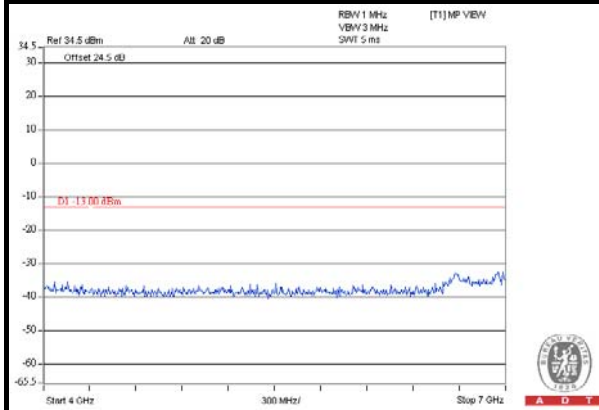

FREQUENCY RANGE : 7GHz~9GHz

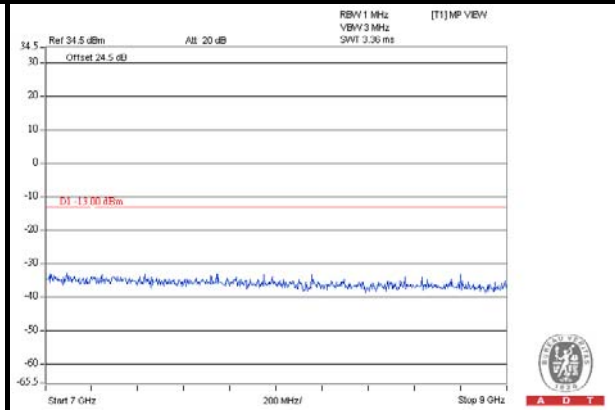



A D T

WCDMA

CHANNEL 4132

FREQUENCY RANGE : 9kHz~1GHz

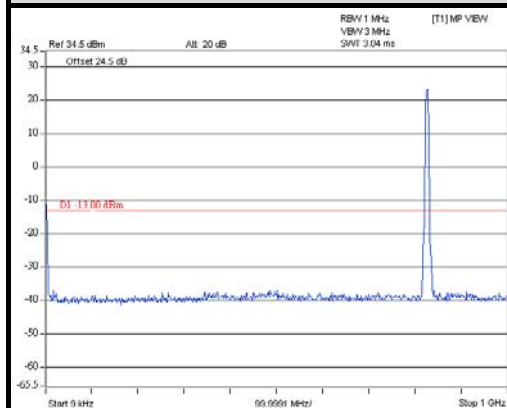

FREQUENCY RANGE : 1GHz~4GHz

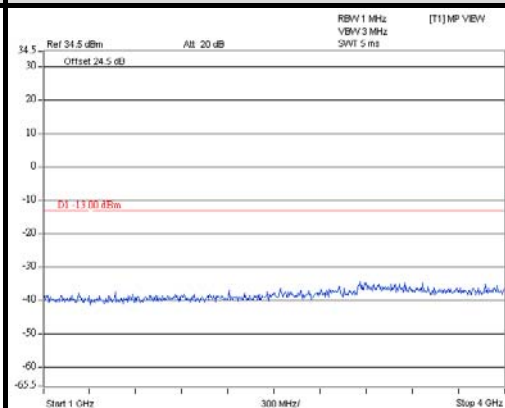

FREQUENCY RANGE : 4GHz~7GHz

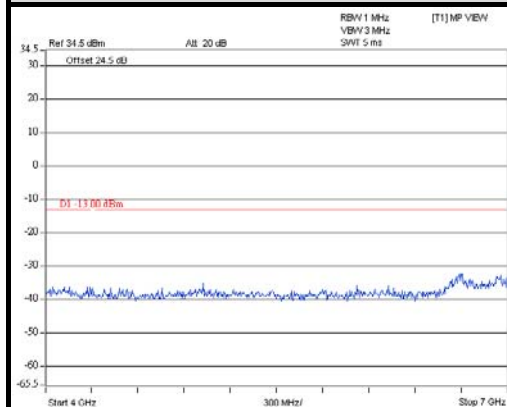

FREQUENCY RANGE : 7GHz~9GHz

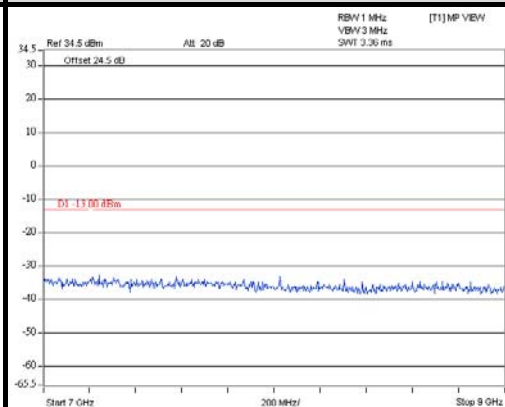



A D T

WCDMA

CHANNEL 4182

FREQUENCY RANGE : 9kHz~1GHz

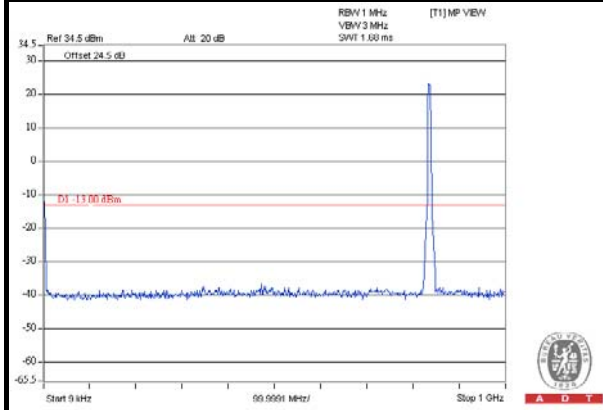

FREQUENCY RANGE : 1GHz~4GHz

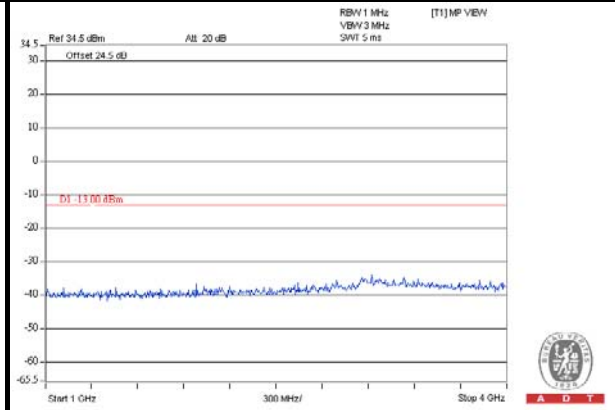

FREQUENCY RANGE : 4GHz~7GHz

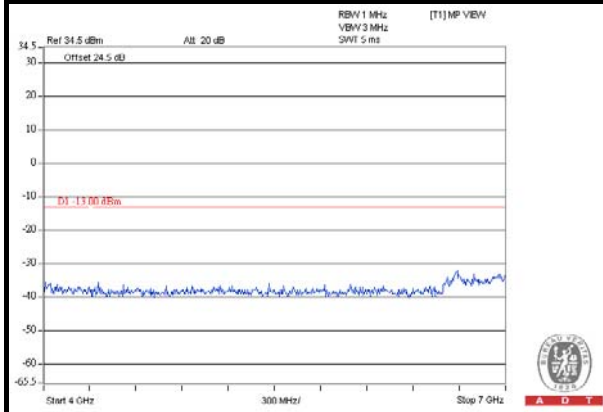

FREQUENCY RANGE : 7GHz~9GHz

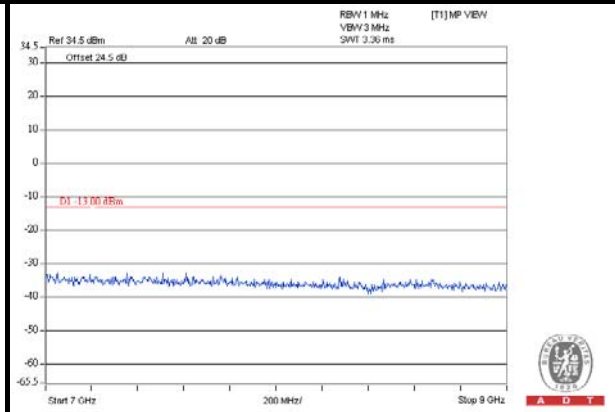



A D T

WCDMA

CHANNEL 4233

FREQUENCY RANGE : 9kHz~1GHz

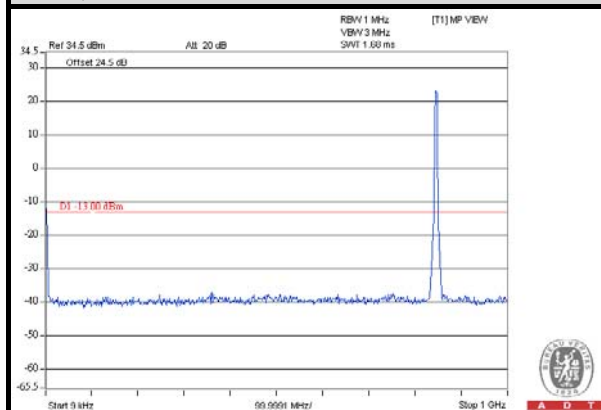

FREQUENCY RANGE : 1GHz~4GHz

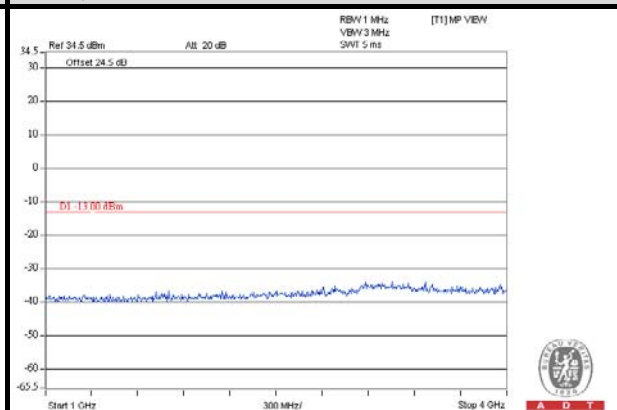

FREQUENCY RANGE : 4GHz~7GHz

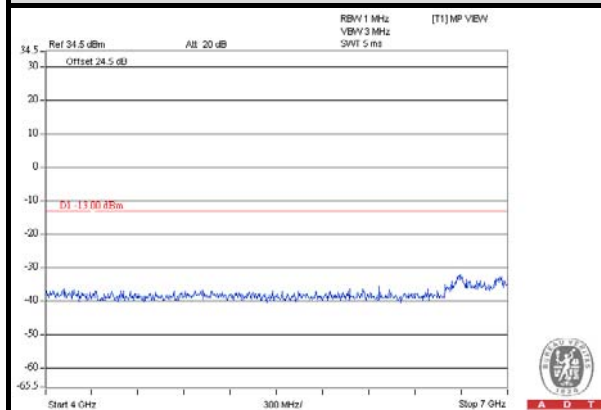

FREQUENCY RANGE : 7GHz~9GHz

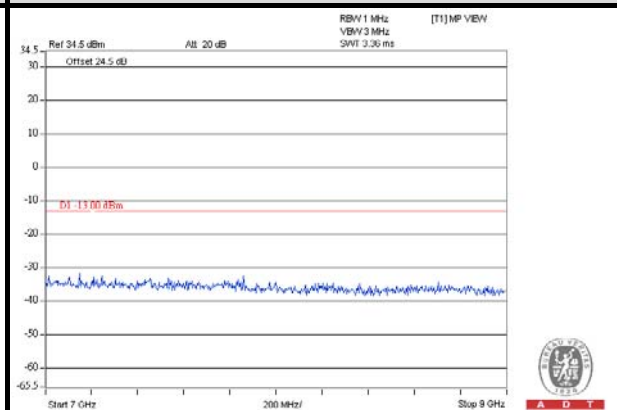



A D T

HSDPA

CHANNEL 4132

FREQUENCY RANGE : 9kHz~1GHz

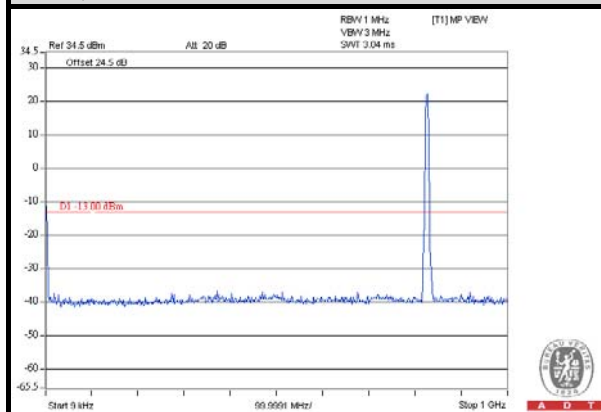

FREQUENCY RANGE : 1GHz~4GHz

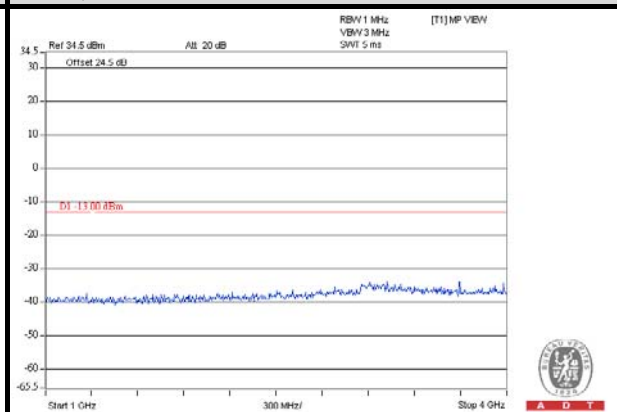

FREQUENCY RANGE : 4GHz~7GHz

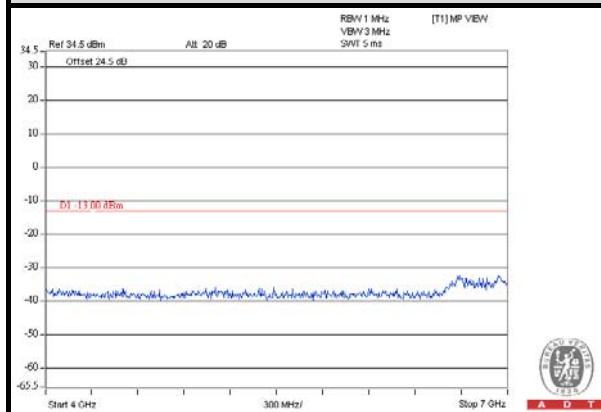

FREQUENCY RANGE : 7GHz~9GHz

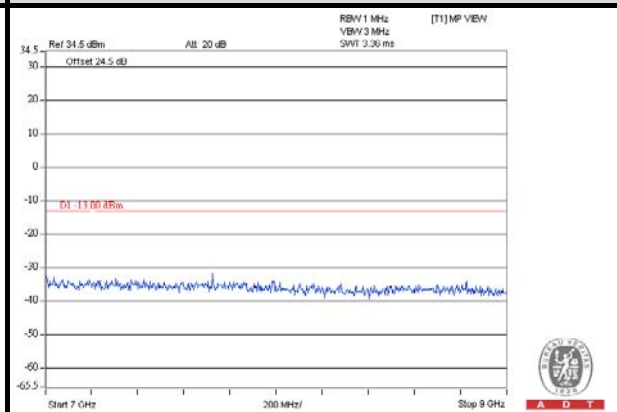



A D T

HSDPA

CHANNEL 4182

FREQUENCY RANGE : 9kHz~1GHz

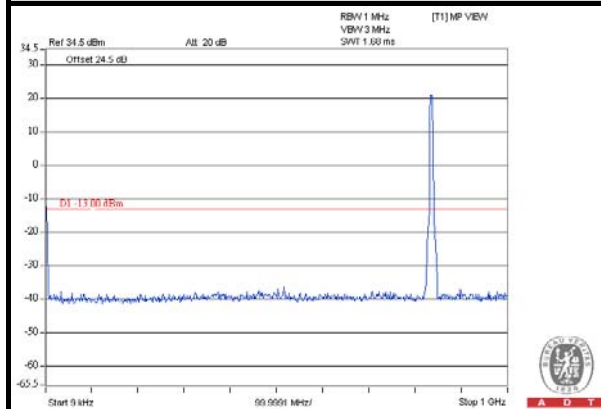

FREQUENCY RANGE : 1GHz~4GHz

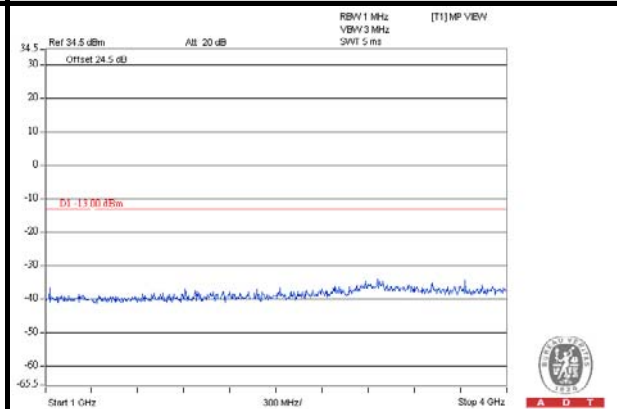

FREQUENCY RANGE : 4GHz~7GHz

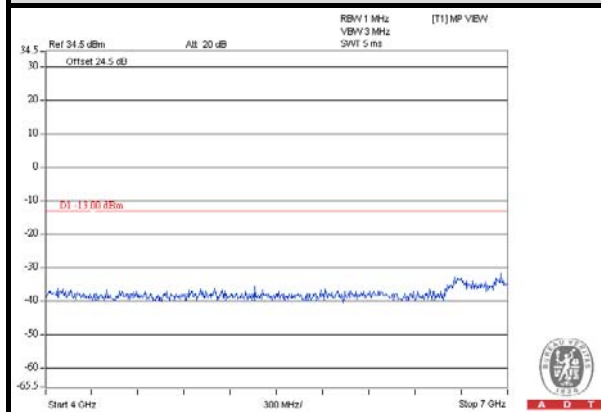

FREQUENCY RANGE : 7GHz~9GHz

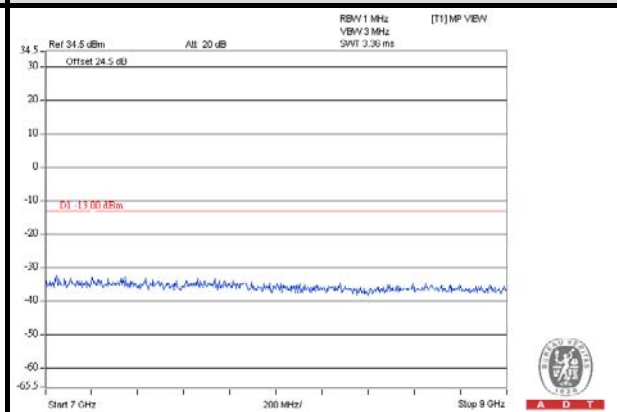



A D T

HSDPA

CHANNEL 4233

FREQUENCY RANGE : 9kHz~1GHz

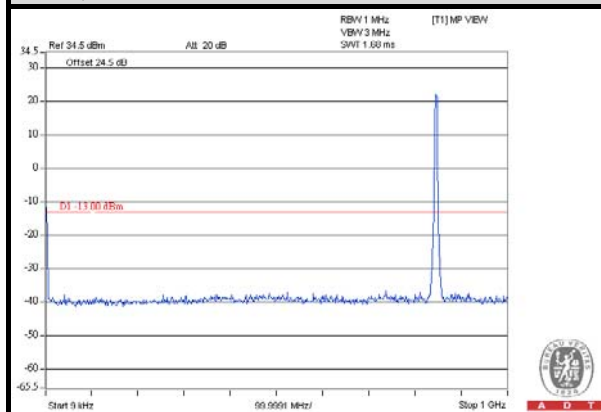

FREQUENCY RANGE : 1GHz~4GHz

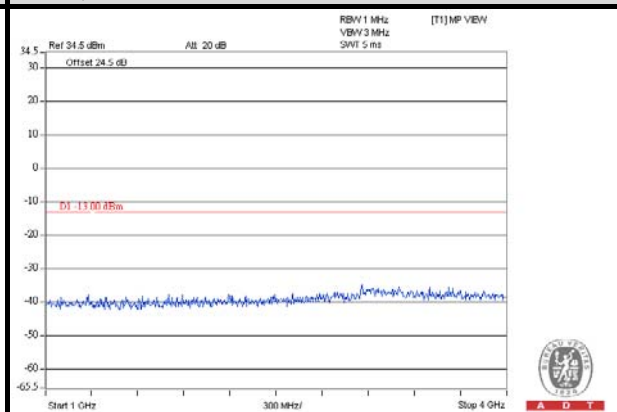

FREQUENCY RANGE : 4GHz~7GHz

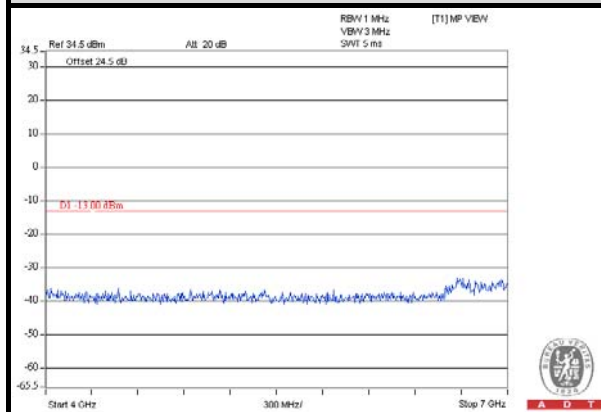

FREQUENCY RANGE : 7GHz~9GHz

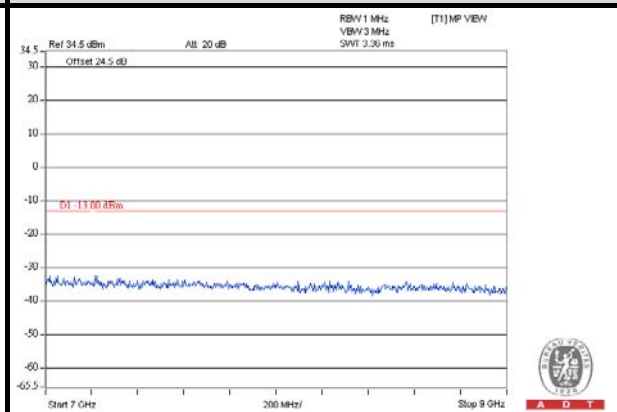



A D T

HSUPA

CHANNEL 4132

FREQUENCY RANGE : 9kHz~1GHz

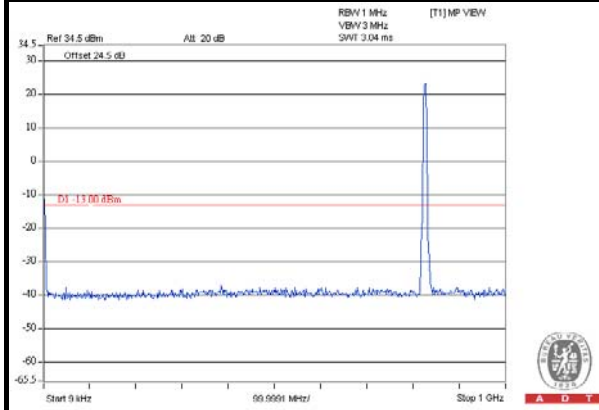

FREQUENCY RANGE : 1GHz~4GHz

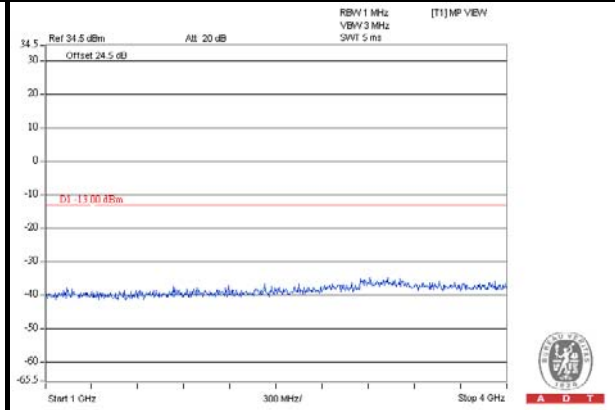

FREQUENCY RANGE : 4GHz~7GHz

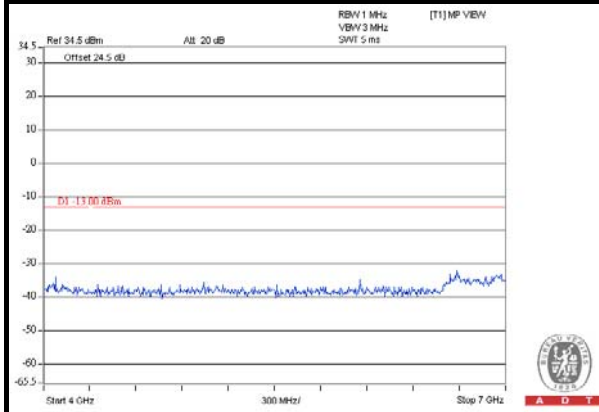

FREQUENCY RANGE : 7GHz~9GHz

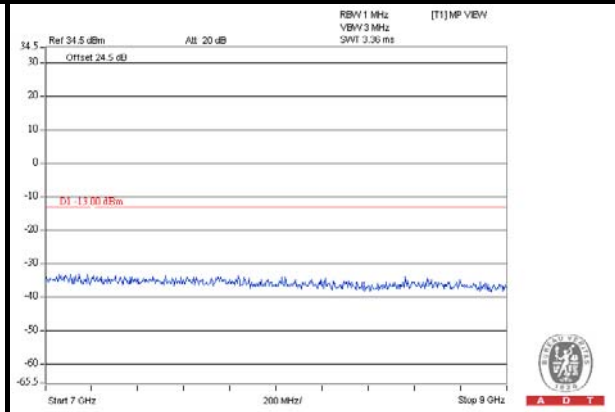



A D T

HSUPA

CHANNEL 4182

FREQUENCY RANGE : 9kHz~1GHz

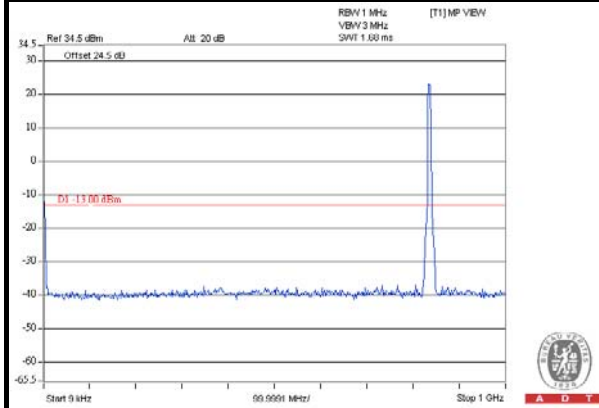

FREQUENCY RANGE : 1GHz~4GHz

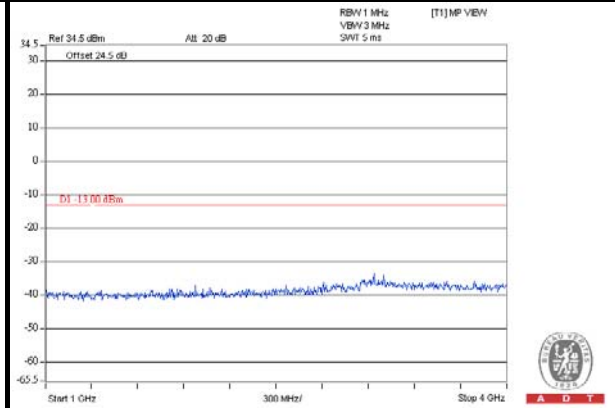

FREQUENCY RANGE : 4GHz~7GHz

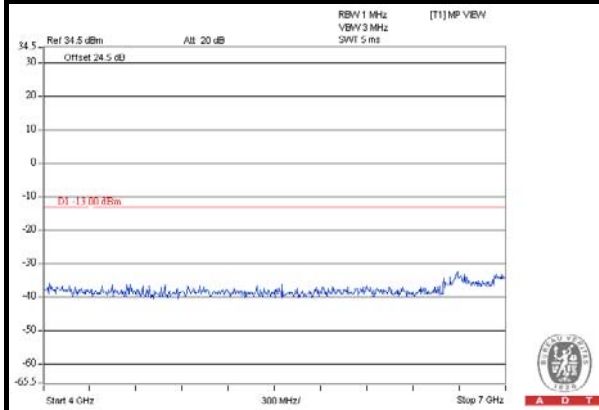

FREQUENCY RANGE : 7GHz~9GHz

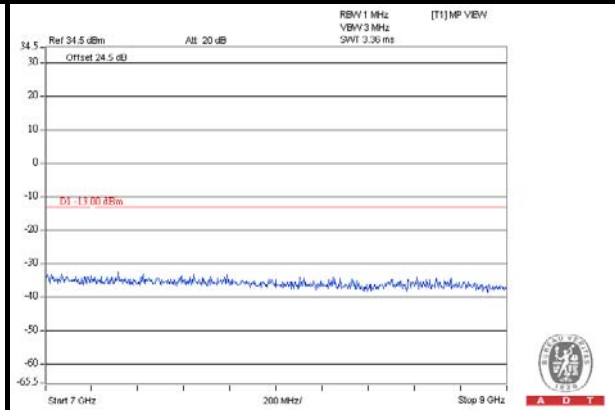



A D T

HSUPA

CHANNEL 4233

FREQUENCY RANGE : 9kHz~1GHz

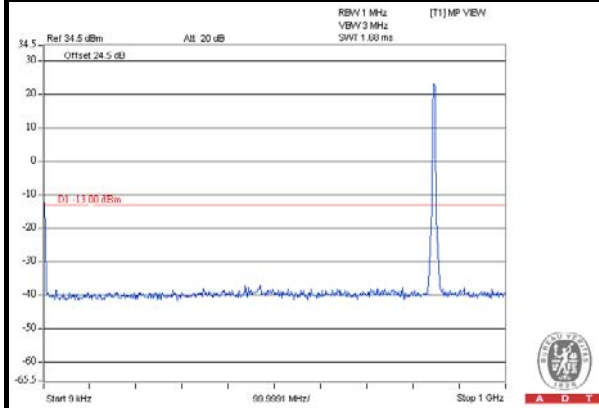

FREQUENCY RANGE : 1GHz~4GHz

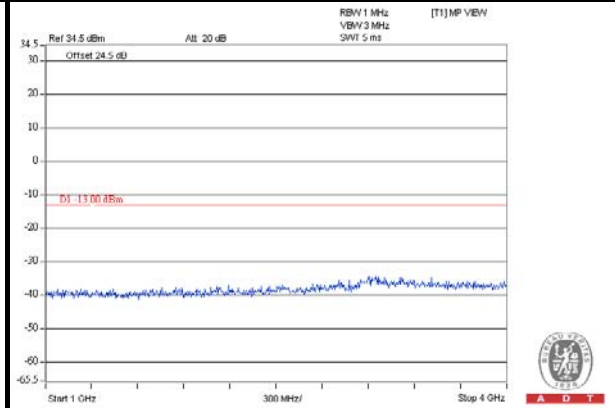

FREQUENCY RANGE : 4GHz~7GHz

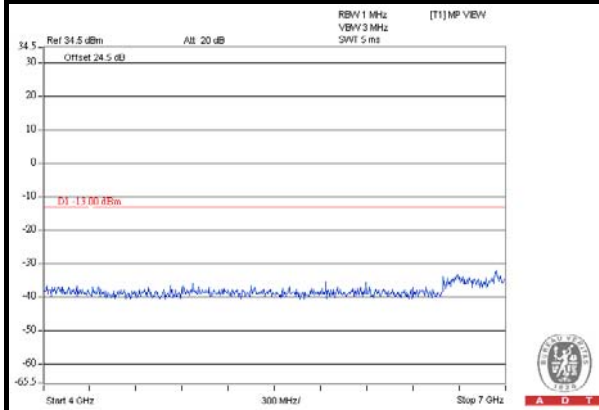

FREQUENCY RANGE : 7GHz~9GHz

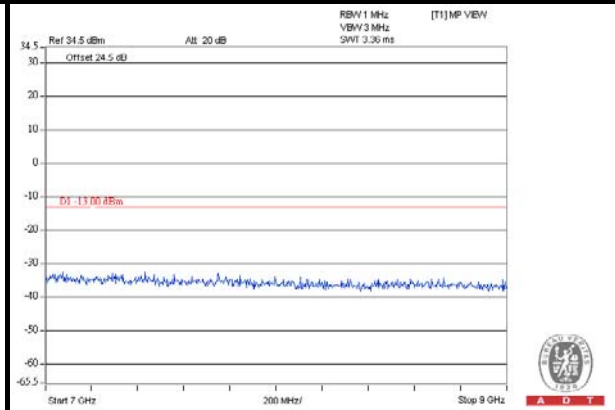

4.7 RADIATED EMISSION MEASUREMENT

4.7.1 LIMITS OF RADIATED EMISSION MEASUREMENT

The power of any emission outside of the authorized operating frequency ranges must be attenuated below the transmitting power (P) by a factor of at least $43 + 10 \log(P)$ dB. The emission limit equal to -13dBm .

4.7.2 TEST PROCEDURES

- a. Substitution method is used for E.I.R.P measurement. In the semi-anechoic chamber, EUT placed on the 0.8m height of Turn Table, rotated the table around 360 degrees to search the maximum radiation power and receiver antenna shall be rotated vertical and horizontal polarization and moved height from 1m to 4m to find the maximum polar radiated power. The “Read Value” is the spectrum reading the maximum power value.
- b. The substitution horn antenna is substituted for EUT at the same position and signals generator export the CW signal to the substitution antenna via a TX cable. Rotated the Turn Table and moved receiving antenna to find the maximum radiation power. Adjust output power level of S.G to get a Value of spectrum reading equal to “Read Value” of step a. Record the power level of S.G
- c. $\text{EIRP} = \text{Output power level of S.G} - \text{TX cable loss} + \text{Antenna gain of substitution horn}$.
- d. E.R.P power can be calculated form E.I.R.P power by subtracting the gain of dipole, $\text{E.R.P power} = \text{E.I.R.P power} - 2.15\text{dBi}$.

NOTE: The resolution bandwidth and video bandwidth of test receiver/spectrum analyzer is 1MHz/3MHz.

4.7.3 DEVIATION FROM TEST STANDARD

No deviation

4.7.4 TEST SETUP

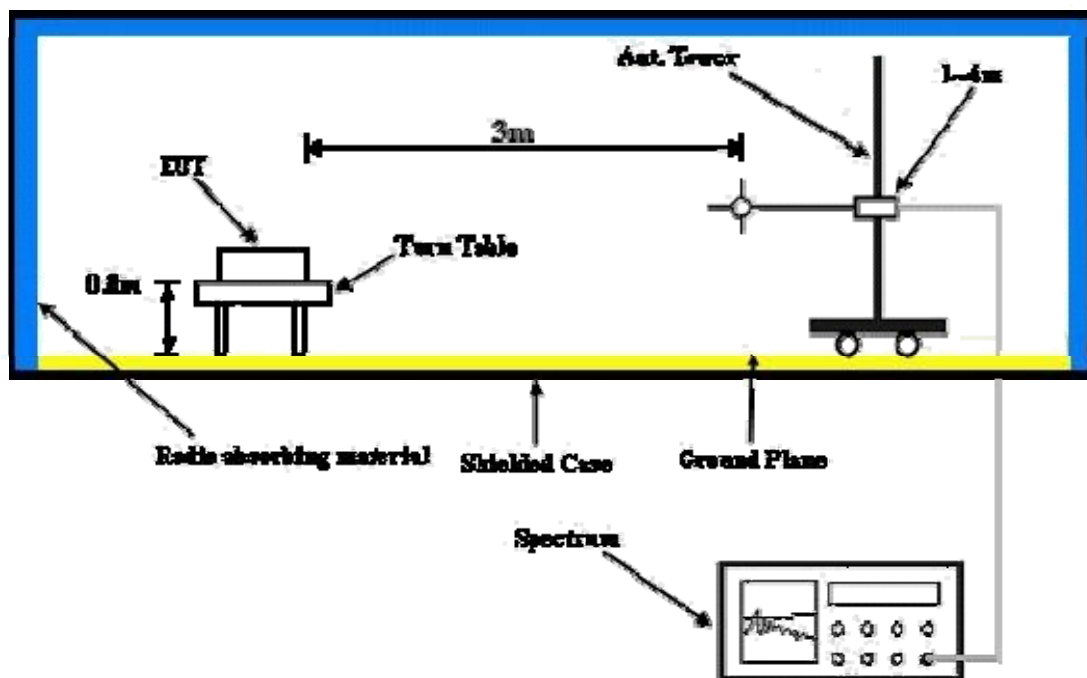

For the actual test configuration, please refer to the attached file (Test Setup Photo).

4.7.5 TEST RESULTS

BELOW 1GHz WORST-CASE DATA:

FOR GSM MODE

MODE	TX channel 128	FREQUENCY RANGE	Below 1000MHz
ENVIRONMENTAL CONDITIONS	27deg. C, 66%RH	INPUT POWER	120Vac, 60Hz
TESTED BY	Alan Wu		

ANTENNA POLARITY & TEST DISTANCE: HORIZONTAL AT 3 M							
No.	Freq. (MHz)	Reading (dBm)	S.G Power Value (dBm)	Correction Factor (dB)	ERP (dBm)	Limit (dBm)	Margin (dB)
1	49.40	-43.24	-35.35	-9.85	-45.20	-13.00	-32.20
2	140.58	-36.70	-44.13	-0.31	-44.44	-13.00	-31.44
3	158.04	-53.24	-60.66	0.29	-60.37	-13.00	-47.37
4	520.82	-53.38	-61.25	4.80	-56.45	-13.00	-43.45
5	759.44	-53.61	-56.37	4.53	-51.84	-13.00	-38.84
6	782.72	-54.42	-55.64	4.25	-51.39	-13.00	-38.39
ANTENNA POLARITY & TEST DISTANCE: VERTICAL AT 3 M							
No.	Freq. (MHz)	Reading (dBm)	S.G Power Value (dBm)	Correction Factor (dB)	ERP (dBm)	Limit (dBm)	Margin (dB)
1	37.76	-31.28	-30.72	-11.18	-41.90	-13.00	-28.90
2	64.92	-46.22	-49.09	-6.32	-55.41	-13.00	-42.41
3	255.04	-58.43	-65.45	5.37	-60.08	-13.00	-47.08
4	353.98	-58.09	-66.79	5.21	-61.58	-13.00	-48.58
5	544.10	-58.77	-64.59	4.67	-59.92	-13.00	-46.92
6	759.44	-61.62	-62.45	4.53	-57.92	-13.00	-44.92

REMARKS:

1. $ERP(dBm) = S.G \text{ Power Value (dBm)} + \text{Correction Factor (dB)}$.
2. Correction Factor = gain of substitution antenna + cable loss



A D T

FOR EDGE MODE

MODE	TX channel 128	FREQUENCY RANGE	Below 1000MHz
ENVIRONMENTAL CONDITIONS	27deg. C, 66%RH	INPUT POWER	120Vac, 60Hz
TESTED BY	Alan Wu		

ANTENNA POLARITY & TEST DISTANCE: HORIZONTAL AT 3 M

No.	Freq. (MHz)	Reading (dBm)	S.G Power Value (dBm)	Correction Factor (dB)	ERP (dBm)	Limit (dBm)	Margin (dB)
1	41.64	-58.70	-47.28	-10.62	-57.90	-13.00	-44.90
2	86.26	-51.46	-60.44	0.09	-60.35	-13.00	-47.35
3	152.22	-58.83	-65.22	-0.04	-65.26	-13.00	-52.26
4	299.66	-55.77	-66.50	5.13	-61.37	-13.00	-48.37
5	425.76	-58.00	-66.85	5.17	-61.68	-13.00	-48.68
6	778.84	-55.44	-56.70	4.29	-52.41	-13.00	-39.41

ANTENNA POLARITY & TEST DISTANCE: VERTICAL AT 3 M

No.	Freq. (MHz)	Reading (dBm)	S.G Power Value (dBm)	Correction Factor (dB)	ERP (dBm)	Limit (dBm)	Margin (dB)
1	41.64	-46.64	-44.91	-10.62	-55.53	-13.00	-42.53
2	74.62	-57.29	-60.47	-3.45	-63.92	-13.00	-50.92
3	169.68	-61.72	-65.19	1.61	-63.58	-13.00	-50.58
4	299.66	-59.36	-67.22	5.13	-62.09	-13.00	-49.09
5	425.76	-50.10	-58.98	5.17	-53.81	-13.00	-40.81
6	790.48	-66.05	-66.07	4.15	-61.92	-13.00	-48.92

REMARKS:

1. $ERP(dBm) = S.G\ Power\ Value\ (dBm) + Correction\ Factor\ (dB)$.
2. Correction Factor = gain of substitution antenna + cable loss



A D T

FOR WCDMA MODE

MODE	TX channel 4132	FREQUENCY RANGE	Below 1000MHz
ENVIRONMENTAL CONDITIONS	27deg. C, 66%RH	INPUT POWER	120Vac, 60Hz
TESTED BY	Alan Wu		

ANTENNA POLARITY & TEST DISTANCE: HORIZONTAL AT 3 M

No.	Freq. (MHz)	Reading (dBm)	S.G Power Value (dBm)	Correction Factor (dB)	ERP (dBm)	Limit (dBm)	Margin (dB)
1	49.40	-47.44	-39.55	-9.85	-49.40	-13.00	-36.40
2	80.44	-55.62	-62.13	-1.52	-63.65	-13.00	-50.65
3	140.58	-55.99	-63.42	-0.31	-63.73	-13.00	-50.73
4	206.54	-48.66	-65.09	5.47	-59.62	-13.00	-46.62
5	470.38	-60.22	-68.39	5.00	-63.39	-13.00	-50.39
6	761.38	-63.13	-65.73	4.51	-61.22	-13.00	-48.22

ANTENNA POLARITY & TEST DISTANCE: VERTICAL AT 3 M

No.	Freq. (MHz)	Reading (dBm)	S.G Power Value (dBm)	Correction Factor (dB)	ERP (dBm)	Limit (dBm)	Margin (dB)
1	47.46	-39.89	-37.88	-10.16	-48.04	-13.00	-35.04
2	84.32	-49.35	-55.20	-0.45	-55.65	-13.00	-42.65
3	127.00	-47.23	-54.91	-0.06	-54.97	-13.00	-41.97
4	156.10	-50.27	-53.44	0.17	-53.27	-13.00	-40.27
5	538.28	-52.49	-58.60	4.71	-53.89	-13.00	-40.89
6	761.38	-63.58	-64.40	4.51	-59.89	-13.00	-46.89

REMARKS:

1. $ERP(dBm) = S.G\ Power\ Value\ (dBm) + Correction\ Factor\ (dB)$.
2. Correction Factor = gain of substitution antenna + cable loss



A D T

ABOVE 1GHz

FOR GSM MODE

MODE	TX channel 128	FREQUENCY RANGE	Above 1000MHz
ENVIRONMENTAL CONDITIONS	27deg. C, 66%RH	INPUT POWER	120Vac, 60Hz
TESTED BY	Alan Wu		

ANTENNA POLARITY & TEST DISTANCE: HORIZONTAL AT 3 M							
No.	Freq. (MHz)	Reading (dBm)	S.G Power Value (dBm)	Correction Factor (dB)	ERP (dBm)	Limit (dBm)	Margin (dB)
1	1648.40	-39.65	-42.90	5.48	-37.42	-13.00	-24.42
2	2472.60	-38.75	-38.76	6.43	-32.33	-13.00	-19.33

ANTENNA POLARITY & TEST DISTANCE: VERTICAL AT 3 M							
No.	Freq. (MHz)	Reading (dBm)	S.G Power Value (dBm)	Correction Factor (dB)	ERP (dBm)	Limit (dBm)	Margin (dB)
1	1648.40	-33.49	-34.61	5.48	-29.13	-13.00	-16.13
2	2472.60	-43.20	-40.81	6.43	-34.38	-13.00	-21.38

REMARKS:

1. $ERP(dBm) = S.G \text{ Power Value (dBm)} + \text{Correction Factor (dB)}$.
2. Correction Factor = gain of substitution antenna + cable loss



A D T

MODE	TX channel 189	FREQUENCY RANGE	Above 1000MHz
ENVIRONMENTAL CONDITIONS	27deg. C, 66%RH	INPUT POWER	120Vac, 60Hz
TESTED BY	Alan Wu		

ANTENNA POLARITY & TEST DISTANCE: HORIZONTAL AT 3 M							
No.	Freq. (MHz)	Reading (dBm)	S.G Power Value (dBm)	Correction Factor (dB)	ERP (dBm)	Limit (dBm)	Margin (dB)
1	1672.80	-42.50	-45.55	5.54	-40.01	-13.00	-27.01
2	2509.20	-39.67	-39.41	6.45	-32.96	-13.00	-19.96

ANTENNA POLARITY & TEST DISTANCE: VERTICAL AT 3 M							
No.	Freq. (MHz)	Reading (dBm)	S.G Power Value (dBm)	Correction Factor (dB)	ERP (dBm)	Limit (dBm)	Margin (dB)
1	1672.80	-38.03	-38.85	5.54	-33.31	-13.00	-20.31
2	2509.20	-42.94	-40.37	6.45	-33.92	-13.00	-20.92

REMARKS:

1. $ERP(dBm) = S.G \text{ Power Value (dBm)} + \text{Correction Factor (dB)}$.
2. Correction Factor = gain of substitution antenna + cable loss



A D T

MODE	TX channel 251	FREQUENCY RANGE	Above 1000MHz
ENVIRONMENTAL CONDITIONS	27deg. C, 66%RH	INPUT POWER	120Vac, 60Hz
TESTED BY	Alan Wu		

ANTENNA POLARITY & TEST DISTANCE: HORIZONTAL AT 3 M							
No.	Freq. (MHz)	Reading (dBm)	S.G Power Value (dBm)	Correction Factor (dB)	ERP (dBm)	Limit (dBm)	Margin (dB)
1	1697.60	-43.83	-46.66	5.59	-41.07	-13.00	-28.07
2	2546.40	-40.50	-40.08	6.44	-33.64	-13.00	-20.64

ANTENNA POLARITY & TEST DISTANCE: VERTICAL AT 3 M							
No.	Freq. (MHz)	Reading (dBm)	S.G Power Value (dBm)	Correction Factor (dB)	ERP (dBm)	Limit (dBm)	Margin (dB)
1	1697.60	-40.00	-40.50	5.59	-34.91	-13.00	-21.91
2	2546.40	-46.29	-43.64	6.44	-37.20	-13.00	-24.20

REMARKS:

1. $ERP(dBm) = S.G\ Power\ Value\ (dBm) + Correction\ Factor\ (dB)$.
2. Correction Factor = gain of substitution antenna + cable loss



A D T

FOR EDGE MODE

MODE	TX channel 128	FREQUENCY RANGE	Above 1000MHz
ENVIRONMENTAL CONDITIONS	27deg. C, 66%RH	INPUT POWER	120Vac, 60Hz
TESTED BY	Alan Wu		

ANTENNA POLARITY & TEST DISTANCE: HORIZONTAL AT 3 M

No.	Freq. (MHz)	Reading (dBm)	S.G Power Value (dBm)	Correction Factor (dB)	ERP (dBm)	Limit (dBm)	Margin (dB)
1	1648.40	-40.39	-43.64	5.48	-38.16	-13.00	-25.16
2	2472.60	-38.98	-38.99	6.43	-32.56	-13.00	-19.56

ANTENNA POLARITY & TEST DISTANCE: VERTICAL AT 3 M

No.	Freq. (MHz)	Reading (dBm)	S.G Power Value (dBm)	Correction Factor (dB)	ERP (dBm)	Limit (dBm)	Margin (dB)
1	1648.40	-34.38	-35.50	5.48	-30.02	-13.00	-17.02
2	2472.60	-43.53	-41.14	6.43	-34.71	-13.00	-21.71

REMARKS:

1. $ERP(dBm) = S.G \text{ Power Value (dBm)} + \text{Correction Factor (dB)}$.
2. Correction Factor = gain of substitution antenna + cable loss



A D T

MODE	TX channel 189	FREQUENCY RANGE	Above 1000MHz
ENVIRONMENTAL CONDITIONS	27deg. C, 66%RH	INPUT POWER	120Vac, 60Hz
TESTED BY	Alan Wu		

ANTENNA POLARITY & TEST DISTANCE: HORIZONTAL AT 3 M							
No.	Freq. (MHz)	Reading (dBm)	S.G Power Value (dBm)	Correction Factor (dB)	ERP (dBm)	Limit (dBm)	Margin (dB)
1	1672.80	-42.60	-45.65	5.54	-40.11	-13.00	-27.11
2	2509.20	-39.86	-39.60	6.45	-33.15	-13.00	-20.15

ANTENNA POLARITY & TEST DISTANCE: VERTICAL AT 3 M							
No.	Freq. (MHz)	Reading (dBm)	S.G Power Value (dBm)	Correction Factor (dB)	ERP (dBm)	Limit (dBm)	Margin (dB)
1	1672.80	-38.36	-39.18	5.54	-33.64	-13.00	-20.64
2	2509.20	-43.23	-40.66	6.45	-34.21	-13.00	-21.21

REMARKS:

1. $ERP(dBm) = S.G\ Power\ Value\ (dBm) + Correction\ Factor\ (dB)$.
2. Correction Factor = gain of substitution antenna + cable loss



A D T

MODE	TX channel 251	FREQUENCY RANGE	Above 1000MHz
ENVIRONMENTAL CONDITIONS	27deg. C, 66%RH	INPUT POWER	120Vac, 60Hz
TESTED BY	Alan Wu		

ANTENNA POLARITY & TEST DISTANCE: HORIZONTAL AT 3 M							
No.	Freq. (MHz)	Reading (dBm)	S.G Power Value (dBm)	Correction Factor (dB)	ERP (dBm)	Limit (dBm)	Margin (dB)
1	1697.60	-43.93	-46.76	5.59	-41.17	-13.00	-28.17
2	2546.40	-40.76	-40.34	6.44	-33.90	-13.00	-20.90

ANTENNA POLARITY & TEST DISTANCE: VERTICAL AT 3 M							
No.	Freq. (MHz)	Reading (dBm)	S.G Power Value (dBm)	Correction Factor (dB)	ERP (dBm)	Limit (dBm)	Margin (dB)
1	1697.60	-40.39	-40.89	5.59	-35.30	-13.00	-22.30
2	2546.40	-47.01	-44.36	6.44	-37.92	-13.00	-24.92

REMARKS:

1. $ERP(dBm) = S.G\ Power\ Value\ (dBm) + Correction\ Factor\ (dB)$.
2. Correction Factor = gain of substitution antenna + cable loss



A D T

FOR WCDMA MODE

MODE	TX channel 4132	FREQUENCY RANGE	Above 1000MHz
ENVIRONMENTAL CONDITIONS	27deg. C, 66%RH	INPUT POWER	120Vac, 60Hz
TESTED BY	Alan Wu		

ANTENNA POLARITY & TEST DISTANCE: HORIZONTAL AT 3 M

No.	Freq. (MHz)	Reading (dBm)	S.G Power Value (dBm)	Correction Factor (dB)	ERP (dBm)	Limit (dBm)	Margin (dB)
1	1652.80	-49.79	-53.00	5.49	-47.51	-13.00	-34.51
2	2479.20	-58.58	-58.54	6.44	-52.10	-13.00	-39.10

ANTENNA POLARITY & TEST DISTANCE: VERTICAL AT 3 M

No.	Freq. (MHz)	Reading (dBm)	S.G Power Value (dBm)	Correction Factor (dB)	ERP (dBm)	Limit (dBm)	Margin (dB)
1	1652.80	-52.18	-53.24	5.49	-47.75	-13.00	-34.75
2	2479.20	-57.86	-55.43	6.44	-48.99	-13.00	-35.99

REMARKS:

1. $ERP(dBm) = S.G \text{ Power Value (dBm)} + \text{Correction Factor (dB)}$.
2. Correction Factor = gain of substitution antenna + cable loss



A D T

MODE	TX channel 4182	FREQUENCY RANGE	Above 1000MHz
ENVIRONMENTAL CONDITIONS	27deg. C, 66%RH	INPUT POWER	120Vac, 60Hz
TESTED BY	Alan Wu		

ANTENNA POLARITY & TEST DISTANCE: HORIZONTAL AT 3 M							
No.	Freq. (MHz)	Reading (dBm)	S.G Power Value (dBm)	Correction Factor (dB)	ERP (dBm)	Limit (dBm)	Margin (dB)
1	1672.80	-49.50	-52.55	5.54	-47.01	-13.00	-34.01
2	2509.20	-57.86	-57.60	6.45	-51.15	-13.00	-38.15

ANTENNA POLARITY & TEST DISTANCE: VERTICAL AT 3 M							
No.	Freq. (MHz)	Reading (dBm)	S.G Power Value (dBm)	Correction Factor (dB)	ERP (dBm)	Limit (dBm)	Margin (dB)
1	1672.80	-52.34	-53.16	5.54	-47.62	-13.00	-34.62
2	2509.20	-57.23	-54.66	6.45	-48.21	-13.00	-35.21

REMARKS:

1. $ERP(dBm) = S.G\ Power\ Value\ (dBm) + Correction\ Factor\ (dB)$.
2. Correction Factor = gain of substitution antenna + cable loss



A D T

MODE	TX channel 4233	FREQUENCY RANGE	Above 1000MHz
ENVIRONMENTAL CONDITIONS	27deg. C, 66%RH	INPUT POWER	120Vac, 60Hz
TESTED BY	Alan Wu		

ANTENNA POLARITY & TEST DISTANCE: HORIZONTAL AT 3 M							
No.	Freq. (MHz)	Reading (dBm)	S.G Power Value (dBm)	Correction Factor (dB)	ERP (dBm)	Limit (dBm)	Margin (dB)
1	1693.20	-49.88	-52.76	5.59	-47.17	-13.00	-34.17
2	2539.80	-58.73	-58.33	6.43	-51.90	-13.00	-38.90
ANTENNA POLARITY & TEST DISTANCE: VERTICAL AT 3 M							
No.	Freq. (MHz)	Reading (dBm)	S.G Power Value (dBm)	Correction Factor (dB)	ERP (dBm)	Limit (dBm)	Margin (dB)
1	1693.20	-52.32	-52.89	5.59	-47.30	-13.00	-34.30
2	2539.80	-58.00	-55.35	6.43	-48.92	-13.00	-35.92

REMARKS:

1. ERP(dBm) = S.G Power Value (dBm) + Correction Factor (dB).
2. Correction Factor = gain of substitution antenna + cable loss



A D T

5 PHOTOGRAPHS OF THE TEST CONFIGURATION

Please refer to the attached file (Test Setup Photo).



A D T

6 INFORMATION ON THE TESTING LABORATORIES

We, Bureau Veritas Consumer Products Services (H.K.) Ltd., Taoyuan Branch, were founded in 1988 to provide our best service in EMC, Radio, Telecom and Safety consultation. Our laboratories are accredited and approved according to ISO/IEC 17025.

If you have any comments, please feel free to contact us at the following:

Linko EMC/RF Lab:

Tel: 886-2-26052180

Fax: 886-2-26051924

Hsin Chu EMC/RF/Telecom Lab:

Tel: 886-3-5935343

Fax: 886-3-5935342

Hwa Ya EMC/RF/Safety Lab:

Tel: 886-3-3183232

Fax: 886-3-3270892

Email: service.adt@tw.bureauveritas.com

Web Site: www.bureauveritas-adt.com

The address and road map of all our labs can be found in our web site also.



A D T

7 APPENDIX A – MODIFICATIONS RECORDERS FOR ENGINEERING CHANGES TO THE EUT BY THE LAB

No any modifications are made to the EUT by the lab during the test.

---END---