

# CipherLab User Guide

## 1660/1661 Barcode Scanner

Setup barcodes included.

Version 1.14



Copyright © 2008~2010 CIPHERLAB CO., LTD.  
All rights reserved

The software contains proprietary information of CIPHERLAB CO., LTD.; it is provided under a license agreement containing restrictions on use and disclosure and is also protected by copyright law. Reverse engineering of the software is prohibited.

Due to continued product development this information may change without notice. The information and intellectual property contained herein is confidential between CIPHERLAB and the client and remains the exclusive property of CIPHERLAB CO., LTD. If you find any problems in the documentation, please report them to us in writing. CIPHERLAB does not warrant that this document is error-free.

No part of this publication may be reproduced, stored in a retrieval system, or transmitted in any form or by any means, electronic, mechanical, photocopying, recording or otherwise without the prior written permission of CIPHERLAB CO., LTD.

For product consultancy and technical support, please contact your local sales representative. Also, you may visit our web site for more information.

The CipherLab logo is a registered trademark of CIPHERLAB CO., LTD.

All brand, product and service, and trademark names are the property of their registered owners.

The editorial use of these names is for identification as well as to the benefit of the owners, with no intention of infringement.

**CIPHERLAB CO., LTD.**

Website: <http://www.cipherlab.com>

## IMPORTANT NOTICES

---

## FOR USA

This equipment has been tested and found to comply with the limits for a **Class B** digital device, pursuant to Part 15 of the FCC Rules. These limits are designed to provide reasonable protection against harmful interference in a residential installation. This equipment generates, uses and can radiate radio frequency energy and, if not installed and used in accordance with the instructions, may cause harmful interference to radio communications. However, there is no guarantee that interference will not occur in a particular installation. If this equipment does cause harmful interference to radio or television reception, which can be determined by turning the equipment off and on, the user is encouraged to try to correct the interference by one or more of the following measures:

- ▶ Reorient or relocate the receiving antenna.
- ▶ Increase the separation between the equipment and receiver.
- ▶ Connect the equipment into an outlet on a circuit different from that to which the receiver is connected.
- ▶ Consult the dealer or an experienced radio/TV technician for help.

This device complies with Part 15 of the FCC Rules. Operation is subject to the following two conditions: (1) This device may not cause harmful interference, and (2) this device must accept any interference received, including interference that may cause undesired operation.

## FOR CANADA

This digital apparatus does not exceed the Class B limits for radio noise emissions from digital apparatus as set out in the interference-causing equipment standard entitled "Digital Apparatus," ICES-003 of Industry Canada. This device complies with Part 15 of the FCC Rules. Operation is subject to the following two conditions: (1) This device may not cause harmful interference, and (2) this device must accept any interference received, including interference that may cause undesired operation.

Cet appareil numérique respecte les limites de bruits radioélectriques applicables aux appareils numériques de Classe B prescrites dans la norme sur le matériel brouilleur: "Appareils Numériques," NMB-003 édictée par l'Industrie.

## FOR HAND-HELD PRODUCT WITH RF FUNCTIONS

The 1660/1661 unit (FCC ID: Q3N-1660, Q3N-1661) complies with FCC radiation exposure limits set forth for uncontrolled environment and meets the FCC radio frequency (RF) Exposure Guidelines in Supplement C to OET65. The unit has very low level of RF energy that it is deemed to comply without testing of specific absorption ratio (SAR).

The 3610 unit (FCC ID: Q3N-3610) complies with FCC radiation exposure limits set forth for an uncontrolled environment. This equipment should be installed and operated with minimum distance 20 cm between the radiator & your body. It only operated in hand-held used. If you only transfer data to Host wirelessly, please keep the minimum distance 20 cm between machine & your body.

## SAFETY PRECAUTIONS

**RISK OF EXPLOSION IF BATTERY IS REPLACED BY AN INCORRECT TYPE. DISPOSE OF USED BATTERIES ACCORDING TO THE INSTRUCTIONS.**

- ▶ DO NOT disassemble, incinerate or short circuit the battery.
- ▶ DO NOT expose the scanner or the battery to any flammable sources.
- ▶ For green-environment issue, it's important that batteries should be recycled in a proper way.
- ▶ Under no circumstances, internal components are self-serviceable.

## CARE & MAINTENANCE

- ▶ Use a clean cloth to wipe dust off the scanning window and the body of the scanner. DO NOT use/mix any bleach or cleaner.
- ▶ If you want to put away the scanner for a period of time, download the collected data to a host computer when in the memory mode, and then take out the battery. Store the scanner and battery separately.
- ▶ When the scanner resumes its work, make sure the battery is fully charged before use.
- ▶ If you shall find the scanner malfunctioning, write down the specific scenario and consult your local sales representative.

## RELEASE NOTES

---

Version	Date	Notes
---------	------	-------

---

# CONTENTS

---

- IMPORTANT NOTICES** ..... - 2 -
  - For USA ..... - 3 -
  - For Canada ..... - 3 -
  - For Hand-held Product with RF Functions ..... - 3 -
  - Safety Precautions ..... - 4 -
  - Care & Maintenance ..... - 4 -
- RELEASE NOTES** ..... - 4 -
- INTRODUCTION** ..... 1
  - Getting Familiarized with 1660/1661 and 3610 ..... 2
    - Installing Batteries to 1660/1661 ..... 2
    - Charging the Battery for 1661 ..... 3
    - Charging the Battery via Charger ..... 4
    - Using 3610 ..... 5
  - Inside the Package ..... 6
  - Product Highlights ..... 6
  - Symbologies Supported ..... 7
- QUICK START** ..... 9
  - Enter Configuration Mode ..... 11
  - Exit Configuration Mode ..... 11
  - Default Settings ..... 12
    - Save User Settings as Defaults ..... 12
    - Restore User Defaults ..... 12
    - Restore System Defaults ..... 12
  - Read a Setup Barcode ..... 13
    - Configure Parameters ..... 13
    - List the Current Settings ..... 17
  - Create One-Scan Setup Barcodes ..... 19
- UNDERSTANDING THE BARCODE SCANNER** ..... 21
  - 1.1 Battery ..... 21
    - 1.1.1 How to Operate the Scanner ..... 21
    - 1.1.2 Auto Power Off & Power-Saving ..... 23
  - 1.2 Memory ..... 26
    - 1.2.1 Transmit Buffer ..... 26
    - 1.2.2 Memory Mode ..... 27
  - 1.3 LED Indicator ..... 29
    - 1.3.1 Good Read LED ..... 30
    - 1.3.2 Good Read LED Duration ..... 30
  - 1.4 Beeper ..... 31
    - 1.4.1 Beeper Volume ..... 32

1.4.2 Good Read Beep .....	33
1.4.3 Low Battery Alarm (1660) .....	34
1.4.4 Low Battery Alarm (1661) .....	34
1.5 Send "NR" to Host .....	35
1.6 Scan Modes .....	36
1.6.1 Continuous Mode .....	37
1.6.2 Test Mode .....	37
1.6.3 Default mode .....	38
1.6.4 Auto Off Mode .....	38
1.6.5 Auto Power Off Mode .....	38
1.6.6 Alternate Mode .....	39
1.6.7 Aiming Mode .....	39
1.6.8 Multi-Barcode Mode .....	40
1.7 Scanning Timeout .....	41
1.8 Delay between Re-read .....	42
1.9 Read Redundancy for All Symbologies .....	43
1.10 Addon Security for UPC/EAN Barcodes .....	44
1.11 Negative Barcodes .....	45
1.12 Effective Decoding Area .....	46
1.12.1 Positioning Window .....	46
1.12.2 Adjusting Window .....	47
<b>SELECTING OUTPUT INTERFACE .....</b>	<b>49</b>
2.1 BT HID .....	50
2.1.1 Activate BT HID & Select Keyboard Type .....	50
2.1.2 Reset Connection .....	51
2.1.3 Keyboard Settings .....	52
2.1.4 Inter-Function Delay .....	59
2.1.5 HID Character Transmit Mode .....	59
2.1.6 Keypad Support for iPhone/iPad .....	60
2.2 BT SPP Slave .....	61
2.2.1 Activate BT SPP Slave Mode .....	61
2.2.2 Inter-Function Delay .....	61
2.2.3 ACK/NAK Timeout .....	62
2.3 BT SPP Master .....	63
2.3.1 Activate BT SPP Master Mode .....	63
2.3.2 Inter-Function Delay .....	65
2.3.3 ACK/NAK Timeout .....	66
2.3.4 Switch between Master/Slave Mode .....	66
2.4 USB HID via 3610 .....	67
2.4.1 Activate USB HID & Select Keyboard Type .....	67
2.4.2 Keyboard Settings .....	68
2.4.3 Inter-Function Delay .....	75
2.4.4 HID Character Transmit Mode .....	75
2.5 USB Virtual COM via 3610 .....	76
2.5.1 Activate USB Virtual COM .....	76
2.5.2 Inter-Function Delay .....	76
2.5.3 ACK/NAK Timeout .....	77

<b>SETTING UP A WPAN CONNECTION .....</b>	<b>79</b>
3.1 Connecting via 3610 .....	80
3.1.1 Connect to 3610 .....	80
3.1.2 Change Interface.....	81
3.1.3 Configure Related Settings .....	82
3.2 Connecting via <i>Bluetooth</i> <sup>®</sup> Dongle .....	83
3.2.1 Change Interface.....	83
3.2.2 Configure Related Settings .....	84
3.2.3 Connect to Dongle .....	87
<b>SPECIFICATIONS .....</b>	<b>95</b>





# INTRODUCTION

---

CipherLab's small-form-factor 1660 Series Barcode Scanners are specifically designed to answer your mobile demands. The palm-sized scanners are designed to help accelerate productivity while lowering the total cost of ownership. Intensive data collection jobs are made easier with fast, accurate barcode scanning in various working environments, especially in small businesses. Integrating short-distance wireless technology to small-form-factor scanners, the scanners are ideal for carrying in your pocket, and thus give workers tether-free mobility anytime anywhere and get job done more efficiently. This line of scanners deliver data over a wireless personal network at a range of up to 10 meters and a prolonged battery life to keep business running.

Owing to the compact design, extremely low power consumption, and powerful decoding capability, the 1660 Series Barcode Scanners are the best choice for the following applications –

- ▶ Receiving in Retail
- ▶ Product labeling & Tracking
- ▶ Shelf Product Replenishment
- ▶ Mobile Point of Sale (POS)
- ▶ Mobile Inventory Management
- ▶ Order Picking & Staging
- ▶ Work-In-Process Tracking
- ▶ Material Flow Control
- ▶ Transportation & Distribution
- ▶ Warehousing
- ▶ Asset Management

This manual contains information on operating the scanner and using its features. We recommend you to keep one copy of the manual at hand for quick reference or maintenance purposes. To avoid any improper disposal or operation, please read the manual thoroughly before use.

Thank you for choosing CipherLab products!



## GETTING FAMILIARIZED WITH 1660/1661 AND 3610

### INSTALLING BATTERIES TO 1660/1661

- 1) Hold the scanner face down in one hand.
- 2) Press the battery lid release and slide the battery lid.
- 3) Remove the battery lid by the other hand.

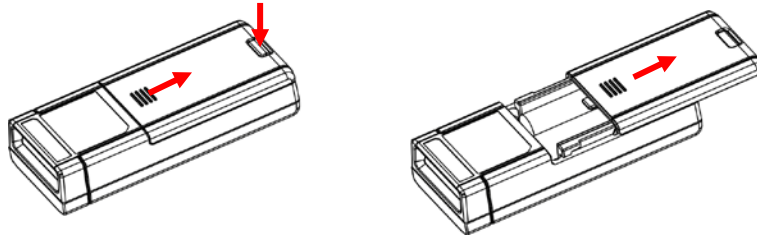

- 4) Hold the scanner still and insert the battery or batteries into the battery compartment.
  - ▶ For 1660, install two AAA Alkaline batteries into the battery compartment, each in the right direction.
- 5) Replace the battery lid and lock it firmly.
- 6) Hold down the [Power/Delete] key for about 2 seconds to turn on the scanner.

The scanner will respond with a long beep (high tone) and its LED indicator will become solid red and go off quickly.

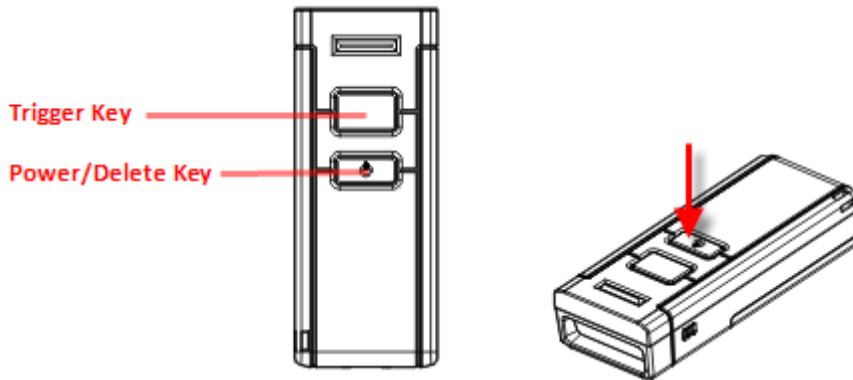

Note: (1) To turn off the scanner, press the [Power/Delete] key for 2 seconds. The scanner will respond with two short beeps (high tone) and the LED will finally become solid red. Release the key then. Otherwise, let the scanner turn off automatically in specific circumstances. Refer to settings of "[Auto Power Off](#)".  
(2) For shipping and storage purposes, save the scanner and the batteries separately. This will keep the batteries in good condition for future use.



## CHARGING THE BATTERY FOR 1661

The battery may not be charged to full for shipment. When you first receive the package, you will need to charge the battery to full before using the scanner. For 1661, use the Direct USB cable to connect the scanner to PC for charging.

Note: Battery charging stops when the temperature drops below 0°C or exceeds 40°C. It is recommended to charge the battery at room temperature (18°C to 25°C) for optimal performance. It takes approximately 4 hours to charge the battery to full.

---

- 1) Install the battery to 1661.
- 2) Connect 1661 to your computer or notebook via the USB cable.
- 3) The scanner LED will be flashing red during charging.

When the charging is done, the LED will turn off.

When charging error occurs, the LED will turn solid red.



## CHARGING THE BATTERY VIA CHARGER

The battery charger is provided for charging the battery only. You may purchase the charger separately.

Note: Battery charging stops when the temperature drops below 0°C or exceeds 40°C. It is recommended to charge the battery at room temperature (18°C to 25°C) for optimal performance. It takes approximately 3 hours to charge the battery to full.

- 1) Insert the battery.
- 2) Connect the power supply cord to the charger.
- 3) Connect the other end of the power cord to a suitable power outlet.

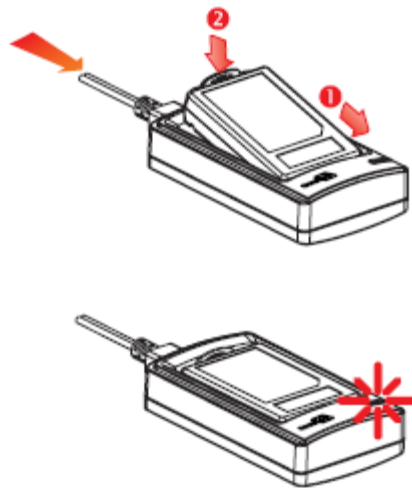

Status LED		Meaning
Red, solid	---	Charger power ON (LED on for 0.5 second)
Red, solid	---	Charging battery
---	Green, solid	Charging done
Red, solid	Green, solid	Pre-charging when battery voltage under 3V (Typical)
---	---	Power or battery not ready



## USING 3610

The BT Transponder (3610) is specifically designed for the scanner to communicate with a host computer wirelessly. The connection between the scanners and 3610 is made easy and reliable. Refer to [3.1.1 Connect to 3610](#).

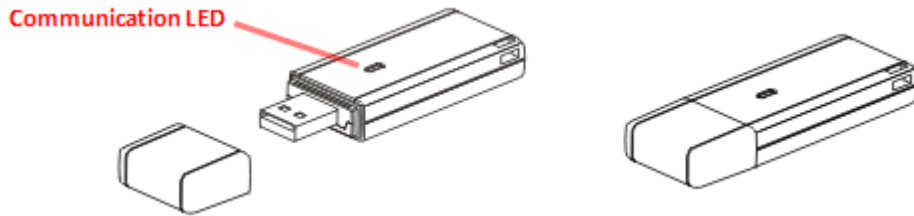

There is one LED indicator provided for communications status.

Communication LED		Meaning
---	Blue, solid	Initialize
Red, solid	---	Failed to establish a USB connection
Red, solid	Blue, flashing	Serial command mode with USB Virtual COM: wait 3 seconds for starting a serial command
Red, flashing	Blue, flashing	Serial command mode with USB HID: wait 3 seconds for pressing [Num Lock] or [Caps Lock] 5 times via keyboard
---	Blue, flashing	Wait for connection request from the scanner (Slow flash at 0.5 Hz)
---	Blue, flashing	Connected with the scanner (Fast flash at 1 Hz)
Red, solid	Blue, flashing	Failed to send data to host via USB Virtual COM (Fast flash at 1 Hz)
Red, flashing	---	Enter Download Mode



## INSIDE THE PACKAGE

The items included in the package may be different, depending on your order. Save the box and packaging material for future use in case you need to store or ship the scanner.

- ▶ Barcode Scanner (1660 or 1661)
- ▶ BT Transponder (3610)
- ▶ Rechargeable Li-ion battery (for 1661)
- ▶ Direct USB Cable (for 1661)
- ▶ Product CD

---

Note: The CD-ROM includes this manual and Windows-based *ScanMaster* software for configuration, as well as the USB Virtual COM driver.

---

## PRODUCT HIGHLIGHTS

- ▶ Small-form-factor and built tough to survive drop test
- ▶ Extremely low power consumption
- ▶ Firmware upgradeable
- ▶ Supports most popular barcode symbologies, including GS1-128 (EAN-128), GS1 DataBar (RSS), etc.
- ▶ Supports negative barcodes
- ▶ Supports different scan modes, including Aiming Mode and Multi-Barcode Mode
- ▶ User feedback via LED indicator and beeper
- ▶ Beeping tone and duration programmable for Good Read
- ▶ 256 KB flash memory for Memory Mode operation, storing up to 16,384 scans based on EAN-13 barcodes
- ▶ Provides up to 1 KB SRAM for reserve buffer while getting out of range over a wireless personal area network (WPAN), storing up to 64 scans based on EAN-13 barcodes
- ▶ Capable of transmitting scanned data, emulating a serial cable (BT SPP) or as keyboard input (BT HID), to a notebook computer or PDA with *Bluetooth*<sup>®</sup> wireless technology
- ▶ Supports BT SPP Slave & Master Mode operations
- ▶ Programmable parameters include data output format, editing format, symbologies, etc.



## SYMBOLOLOGIES SUPPORTED

Most of the popular barcode symbologies are supported, as listed below. Each can be individually enabled or disabled. The scanner will automatically discriminate and recognize all the symbologies that are enabled. Refer to [Chapter 4 Changing Symbology Settings](#) for details of each symbology.

Symbologies Supported: Enable/Disable		Default	
<b>Codabar</b>		Enabled	
<b>Code 93</b>		Enabled	
<b>MSI</b>			Disabled
<b>Plessey</b>			Disabled
<b>Telepen</b>			Disabled
<b>Code 128</b>	Code 128	Enabled	
	GS1-128 (EAN-128)		Disabled
	ISBT 128	Enabled	
<b>Code 2 of 5</b>	Industrial 25	Enabled	
	Interleaved 25	Enabled	
	Matrix 25		Disabled
<b>Code 3 of 9</b>	Code 39	Enabled	
	Italian Pharmacode		Disabled
	French Pharmacode		Disabled
<b>EAN/UPC</b>	EAN-8	Enabled	
	EAN-8 Addon 2		Disabled
	EAN-8 Addon 5		Disabled
	EAN-13	Enabled	
	EAN-13 & UPC-A Addon 2		Disabled
	EAN-13 & UPC-A Addon 5		Disabled
	ISBN		Disabled
	UPC-E0	Enabled	
	UPC-E1		Disabled
	UPC-E Addon 2		Disabled
	UPC-E Addon 5		Disabled
	UPC-A	Enabled	



<b>GS1 DataBar (RSS)</b>	GS1 DataBar Omnidirectional (RSS-14)		Disabled
	GS1 DataBar Truncated		Disabled
	GS1 DataBar Stacked		Disabled
	GS1 DataBar Stacked Omnidirectional		Disabled
	GS1 DataBar Limited (RSS Limited)		Disabled
	GS1 DataBar Expanded (RSS Expanded)		Disabled
	GS1 DataBar Expanded Stacked		Disabled





# QUICK START

---

The configuration of the scanner can be done by reading the setup barcodes contained in this manual or via the *ScanMaster* software.

This section describes the procedure of configuring the scanner by reading the setup barcodes and provides some examples for demonstration.

## Configuration Mode

---

1. Hold down the [Power/Delete] key for about 2 seconds to turn on the scanner. It will respond with a long beep and its LED will come on-off shortly.
2. Have the scanner read the "Enter Setup" barcode. It will respond with six beeps and its LED indicator will become flashing red after reading the barcode.
3. Have the scanner read more setup barcodes... Most of the setup barcodes are normal, and the scanner will respond with two beeps (low-high tone). For special setup barcodes, it requires reading more than one setup barcode to complete the setting.
4. Have the scanner read the "Update" or "Abort" barcode. It will respond with six beeps and its LED indicator will become flashing red after reading the barcode.
5. The scanner will restart automatically upon reading the "Update" or "Abort" barcode. It will respond with a long beep and its LED will come on-off shortly.



---

Note: Refer to [Appendix II Host Serial Commands](#) for how to configure the 3610 dongle by having the scanner read 3610-related setup barcodes or using serial commands.

---



### Working Mode

Upon powering up, the scanner will try to establish a connection with 3610 or a computer with *Bluetooth*<sup>®</sup> wireless technology. Refer to [Chapter 3 – Setting up a WPAN Connection](#) for details. The connection between the scanners and 3610 is made easy and reliable. Now, it also supports BT SPP Master Mode as an alternative. Refer to [2.3 BT SPP Master](#).



---

Note: If USB Virtual COM or BT SPP is selected for output interface, the host can directly send serial commands to configure the scanner. For example, run HyperTerminal.exe and type the 6-digit command located under each setup barcode. Refer to [Appendix II Host Serial Commands](#).

---



## ENTER CONFIGURATION MODE

For the scanner to enter the configuration mode, you must have it read the "Enter Setup" barcode, which can be located at the bottom of almost every even page of this manual.

- ▶ The scanner will respond with six beeps and its LED indicator will become flashing red after reading the barcode.

Enter Setup



For configuring scanner parameters, see "Read a Setup Barcode" below.

## EXIT CONFIGURATION MODE

For the scanner to save settings and exit the configuration mode, you must have it read the "Update" barcode, which can be located at the bottom of almost every odd page of this manual. If you want to exit the configuration mode without saving any changes, have the scanner read the "Abort" barcode instead.

- ▶ Just like reading the "Enter Setup" barcode, the scanner will respond with six beeps and its LED indicator will become flashing red after reading the barcode. Wait for a few seconds for the scanner to restart itself.

Update



109999

Abort



109998



Update

## DEFAULT SETTINGS

### SAVE USER SETTINGS AS DEFAULTS

For the scanner to keep the customized settings as user defaults, you must have it read the “Save as User Defaults” barcode. This is a normal setup barcode, and the scanner will respond with two beeps (low-high tone).

- ▶ After reading the “Update” barcode, the current settings will be saved as user defaults.

Save as User  
Defaults



### RESTORE USER DEFAULTS

For the scanner to restore the user defaults, which you have saved earlier, you must have it read the “Restore User Defaults” barcode. This is a normal setup barcode, and the scanner will respond with two beeps (low-high tone).

- ▶ After reading the “Update” barcode, all the parameters of the scanner will return to their customized values.

Restore User  
Defaults



### RESTORE SYSTEM DEFAULTS

For the scanner to restore the factory defaults, you must have it read the “Restore System Defaults” barcode. This is a normal setup barcode, and the scanner will respond with two beeps (low-high tone). After reading the “Update” barcode, all the parameters of the scanner will return to their default values. The current connection record will be cleared as well. Refer to [1.1.1 How to Operate the Scanner](#) for the key combination used to restore defaults during operation.

For 3610 to restore factory defaults, refer to [3610 Setup Barcodes](#) & Serial Commands.

Restore System  
Defaults



Note: The system default value (if there is) for each setting is indicated by an asterisk “\*”.



## READ A SETUP BARCODE

### CONFIGURE PARAMETERS

For most of the scanner parameters, only one read is required to set them to new values. The scanner will respond with two beeps (low-high tone) when each parameter is set successfully. Refer to [Create One-Scan Setup Barcodes](#).



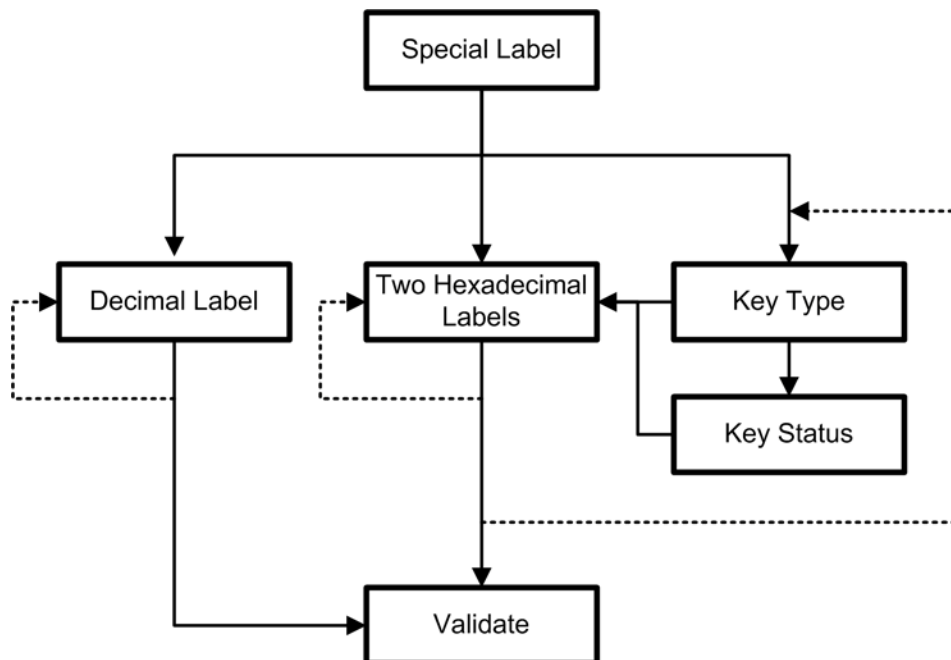

But for a number of special parameters, multiple reads are required to complete the setting. In this case, the scanner will respond with a short beep to indicate it needs to read more setup barcodes. These special parameters may require reading one or more setup barcodes, such as

- ▶ Numeric barcodes, say, for keyboard type, inter-character delay, length qualification
- ▶ Hexadecimal barcodes, say, for character strings as prefix, suffix, etc.
- ▶ When "BT HID" or "USB HID" is configured for interface, Key Type and Key Status will then become applicable. You may decide whether or not to change key status when "Normal Key" is selected for Key Type.

To complete the configuration of these special parameters, it requires reading the "Validate" barcode, and the scanner will respond with two beeps (low-high tone) to indicate the input values are validated.











The example below shows how to save your settings as “User Default” so that you may restore user defaults at a later time:

Steps	Action	User Feedback if Successful
1	Power on the scanner...	The scanner will respond with a long beep (high tone) and its LED indicator will become solid red and go off quickly.
2	Enter the Configuration Mode... <div data-bbox="384 524 767 622" style="text-align: center;"> <p>Enter Setup</p>  </div>	The scanner will respond with six beeps (high-low tone repeats three times), and its LED indicator will be flashing red.
3	Read a Setup barcode... For example, <div data-bbox="427 730 711 981" style="text-align: center;"> <p>*Enable Industrial 25</p>  <p>100307</p> <p>Save as User Default</p>  <p>109986</p> </div>	The scanner will respond with two beeps (low-high tone) if reading a normal setup barcode.
4	Exit the Configuration Mode... <div data-bbox="317 1048 820 1173" style="text-align: center;"> <p>Update                      Abort</p>  <p>109999</p> <p>OR</p>  <p>109998</p> </div>	Same as for <i>Enter the Configuration Mode</i> .
5	The scanner will automatically restart itself...	Same as for <i>Power on the scanner</i> .
*	When any configuration error occurs...	The scanner will respond with one long beep (low tone).











The example below shows how to set numeric parameters:

Steps	Action	User Feedback if Successful
1	Power on the scanner...	The scanner will respond with a long beep (high tone) and its LED indicator will become solid red and go off quickly.
2	Enter the Configuration Mode... <div style="text-align: center;"> <p>Enter Setup</p>  </div>	The scanner will respond with six beeps (high-low tone repeats three times), and its LED indicator will become flashing red.
3	Read a Setup barcode... For example,	The scanner will respond with two beeps (low-high tone) if reading a normal setup barcode.
	<div style="text-align: center;"> <p>*Enable Interleaved 25</p>  <p>100309</p> </div> <div style="border: 1px solid red; padding: 2px; display: inline-block; margin-bottom: 10px;">Normal setup barcode</div>	
	<div style="text-align: center;"> <p>Enable Fixed Length(s) ...</p>  <p>100604</p> </div> <div style="border: 1px solid red; padding: 2px; display: inline-block; margin-bottom: 10px;">Normal setup barcode</div>	
	<div style="text-align: center;"> <p>Max. Length (*126) Or Fixed Length 1</p>  <p>100606</p> </div> <div style="border: 1px solid red; padding: 2px; display: inline-block; margin-bottom: 10px;">Special setup barcode</div>	The scanner will respond with one short beep if reading a special setup barcode such as "Max. Length", indicating the setup requires reading more barcodes.
	<div style="text-align: center;"> <p>1</p>  <p>109901</p> </div> <div style="border: 1px solid red; padding: 2px; display: inline-block; margin-bottom: 10px;">Decimal barcodes</div>	Read the "Decimal Value" barcode(s). <ul style="list-style-type: none"> <li>▶ Refer to Appendix IV "Decimal System"</li> </ul>
	<div style="text-align: center;"> <p>5</p>  <p>109905</p> </div>	
	<div style="text-align: center;"> <p>Validate</p>  <p>109994</p> </div>	The scanner will respond with two beeps (low-high tone) when the input values are validated.
4	Exit the Configuration Mode... <div style="display: flex; justify-content: space-around; align-items: center;"> <div style="text-align: center;"> <p>Update</p>  <p>109999</p> </div> <p>OR</p> <div style="text-align: center;"> <p>Abort</p>  <p>109998</p> </div> </div>	Same as for <i>Enter the Configuration Mode</i> .
5	The scanner will automatically restart itself...	Same as for <i>Power on the scanner</i> .



Update

The example below shows how to set string parameters:

Steps	Action	User Feedback if Successful
1	Power on the scanner...	The scanner will respond with a long beep (high tone) and its LED indicator will become solid red and go off quickly.
2	Enter the Configuration Mode...	The scanner will respond with six beeps (high-low tone repeats three times), and its LED indicator will become flashing red.
3	Read a Setup barcode...	The scanner will respond with one short beep if reading a special setup barcode such as "Prefix Code", indicating the setup requires reading more barcodes.
	For example,	
	<div style="border: 1px solid red; padding: 2px; display: inline-block;">Special setup barcodes</div>	
	<p style="text-align: center;">Configure Prefix</p>  <p style="text-align: center;">101230</p>	
		When "BT HID" or "USB HID" is configured for interface, Key Type and Key Status will then become applicable. You may decide whether or not to change key status when "Normal Key" is selected for Key Type.
		▶ Refer to Appendix III
	<div style="border: 1px solid red; padding: 2px; display: inline-block;">Hexadecimal barcodes</div>	
	<p style="text-align: center;">*Normal</p>  <p style="text-align: center;">109926</p>	
	<p style="text-align: center;">Add Left Alt</p>  <p style="text-align: center;">109932</p>	
	<p style="text-align: center;">2</p>  <p style="text-align: center;">109902</p>	Read the "Hexadecimal Value" barcodes for the desired character string. For example, read "2" and "B" for the scanner to prefix the character "+".
	<p style="text-align: center;">B</p>  <p style="text-align: center;">109911</p>	▶ Refer to Appendix IV "Hexadecimal System"
	<p style="text-align: center;">Validate</p>  <p style="text-align: center;">109994</p>	The scanner will respond with two beeps (low-high tone) when the input values are validated.
4	Exit the Configuration Mode...	Same as for <i>Enter the Configuration Mode</i> .
	<div style="display: flex; justify-content: space-around; align-items: center;"> <div style="text-align: center;"> <p>Update</p>  <p>109999</p> </div> <div style="text-align: center;">OR</div> <div style="text-align: center;"> <p>Abort</p>  <p>109998</p> </div> </div>	
5	The scanner will automatically restart itself...	Same as for <i>Power on the scanner</i> .





## LIST THE CURRENT SETTINGS

The current settings of all scanner parameters can be sent to the host computer for user inspection. The listing includes pages as shown below. You can select the page of interest by having the scanner read the “List Page x” barcode. The scanner will respond with two beeps (low-high tone) and send the selected page to the host immediately.

List settings regarding Firmware Version, Serial Number, Interface, Buzzer, and Other Scanner Parameters

List Page 1



List settings regarding Prefix, Suffix, and Length Code Setting

List Page 2



List settings regarding Code ID

List Page 3



List settings regarding: Readable Symbologies

List Page 4



List settings regarding Symbology Parameters (1/3)

List Page 5



List settings regarding Symbology Parameters (2/3)

List Page 6



List settings regarding Symbology Parameters (3/3)

List Page 7



List settings regarding Editing Format 1

List Page 8



List settings regarding Editing Format 2

List Page 9



List settings regarding Editing Format 3

List Page 10



List settings regarding Editing Format 4

List Page 11



109937

List settings regarding Editing Format 5

List Page 12



109938



## CREATE ONE-SCAN SETUP BARCODES

The fact is most of the scanner parameters require only one read for setting new values. To facilitate configuring the scanner, you may create One-Scan setup barcodes for use.

The requirements of a One-Scan setup barcode are:

- ▶ a prefix of the “#@” characters
- ▶ the six digits of command parameters
- ▶ a suffix of the “#”character

For example, the scanner needs reading three setup barcodes for the command parameter “109952” to take effect:

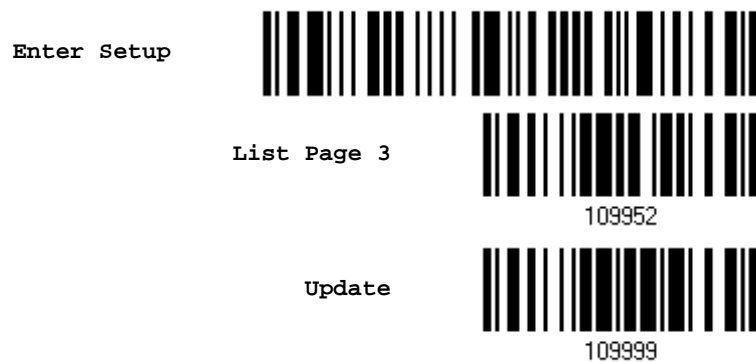

Now, it requires only one read:



Note: The scanner will restart automatically upon reading the One-Scan setup barcode for (1) changing the interface or (2) setting memory mode, enable or disable. It will respond with a long beep and its LED will come on-off shortly.





## UNDERSTANDING THE BARCODE SCANNER

---

This chapter explains the features and usage of the barcode scanner.

### IN THIS CHAPTER

---

1.1 Battery .....	21
1.2 Memory .....	26
1.3 LED Indicator .....	29
1.4 Beeper.....	31
1.5 Send "NR" to Host.....	35
1.6 Scan Modes.....	36
1.7 Scanner Time-out .....	41
1.8 Delay between Re-read.....	42
1.9 Read Redundancy for All Symbologies .....	43
1.10 Addon Security for UPC/EAN Barcodes .....	44
1.11 Negative Barcodes.....	45
1.12 Effective Decoding Area .....	46

### 1.1 BATTERY

The scanner is battery-powered: 1660 uses two AAA Alkaline batteries, while 1661 uses a rechargeable 3.7 V/850 mAh Li-ion battery. For intensive data collection, you may prepare spare battery or batteries for non-stop operation.

---

Note: (1) The rechargeable battery for 1661 may not be charged to full for shipment. We suggest charging it to full before use.  
(2) The scanner can be configured to save battery power. Refer to settings of "[Auto Power Off & Power-Saving](#)", "[Sniff Mode](#)", as well as "[Low Battery Alarm](#)".

---

#### 1.1.1 HOW TO OPERATE THE SCANNER

##### Turn on the scanner...

---

Press the [Power/Delete] key for about 2 seconds. The scanner will respond with a long beep (high tone), and its LED indicator will become solid red and go off quickly.

##### Turn off the scanner...

---

Press the [Power/Delete] key for about 2 seconds. The scanner will respond with two short beeps (high tone) and the LED will finally become solid red. Release the key then. Otherwise, let the scanner turn off automatically in specific circumstances.



**Delete the last collected data when in memory mode ...**

---

Press the [Power/Delete] key. The scanner will respond with two short beeps (high tone) and the LED will become solid red. Before the LED goes off (within 1 second), press the [Power/Delete] key again to confirm the deletion.

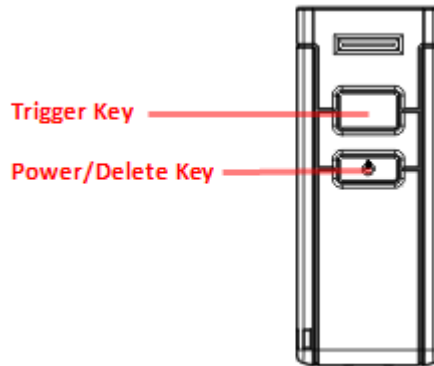

---

Note: For the scanner to restore system defaults during operation, use key combination in the following sequence: Hold down the [Power/Delete] key until its LED indicator becomes solid red, and without releasing the key, you must press the [Trigger] key simultaneously for 3 seconds. Then, the scanner will respond with a long beep (high tone), and the indicator will go off.

---



## 1.1.2 AUTO POWER OFF & POWER-SAVING

The scanner will stay active at power-on, which may be followed by a transition from full CPU speed to low CPU speed (Power-Saving) to auto shutdown (Auto Power Off).

- ▶ Power-Saving (1~254 min.; 0= Disable): By default, it is set to stand by at full-speed for 2 minutes before it enters low-speed mode. If this feature is not desired, set it to 0.
- ▶ Auto Power Off (1~254 min.; 0= Disable): By default, it is set to automatically shut down after 10 minutes. If this feature is not desired, set it to 0.

Note: The Power-Saving setting will not take effect when a WPAN connection has been established successfully, via BT HID or SPP.

### Before establishing a WPAN connection successfully...

1. The scanner will stay active for a specified period of time (2 minutes by default) for the following scenarios. Its CPU is running at full speed, and the LED is flashing blue (On/Off ratio 0.5 s: 0.5 s).
  - (a) waiting for a connection request from the host (BT SPP Slave Mode)
  - (b) trying to connect to the host (BT HID or BT SPP Master Mode)
  - (c) trying to connect to 3610
2. If it fails to connect within 2 minutes, the scanner will become inactive to save power for the remaining period of time (the specified value minus 2 minutes). Its CPU is running at low speed, and the LED is flashing red (On/Off ratio 0.3 s: 2.5 s).

Press the [Trigger] key to wake up the scanner when it becomes inactive, and the scanner will stay active again.
3. If it fails to connect again and again, and finally stays inactive until the specified time interval for Auto Power Off has elapsed, the scanner will automatically turn off in order to conserve battery power.

Hold down the [Power/Delete] key for about 2 seconds to turn it on.

Note: For scenarios (a) and (b) in step 1, on your computer you may need to search for the scanner again.



### After establishing a WPAN connection successfully...

---

1. Once a WPAN connection is established successfully, the scanner will stay active for a specified period of time (2 minutes by default) for data transmission. Its CPU is running at full speed, and the LED is flashing blue (On/Off ratio 0.02 s: 3 s).
2. If it is idle within 2 minutes, the scanner will become inactive to save power for the remaining period of time (the specified value minus 2 minutes). Its CPU is running at low speed, and the LED is flashing red (On/Off ratio 0.3 s: 2.5 s).

Press the [Trigger] key to wake up the scanner when it becomes inactive, and the scanner will stay active again.

- ▶ For BT HID or SPP, there is no transition from full CPU speed to low CPU speed. However, when connecting with 3610, the scanner will go through the transition in order to save power.
3. If it is idle and finally stays inactive until the specified time interval for Auto Power Off has elapsed, the scanner will automatically turn off in order to conserve battery power. You will hear three short beeps, tone descending from high to low.

Hold down the [Power/Delete] key for about 2 seconds to turn it on.

- ▶ For BT HID, the scanner will resume connection with the host upon powering on again, as long as the host application is running. You will hear three short beeps, tone ascending from low to high. If the scanner fails to resume connection, it will try every 5 seconds to re-connect to the host unless you have the scanner read the "Reset Connection" barcode.
- ▶ For BT SPP Slave Mode, the scanner must wait for the host to re-connect.
- ▶ For BT SPP Master Mode, the scanner will resume connection with the host upon powering on again, as long as the host application is running. You will hear three short beeps, tone ascending from low to high. If the scanner fails to resume connection, it will try every 5 seconds to re-connect to the host unless you have the scanner read the "Reset Connection" or "Restore System Defaults" barcode.
- ▶ With the use of 3610, the scanner will try re-connecting to 3610 unless you turn off the scanner.





---

Auto Off after  
0~254 min. (\*10)



101000

- 1) Read the barcode above to specify the time interval before the scanner automatically turns off.
- 2) Read the "[Decimal Value](#)" barcode on page [錯誤! 尚未定義書籤](#). For example, read "1" and "5" for the scanner to automatically turn off after being idle for 15 minutes.
- 3) Read the "Validate" barcode on the same page to complete this setting.

---

Note: Auto Power Off will not take effect when the scanner is in the configuration mode.

---

Power-Saving after  
0~254 min. (\*2)



101021

- 1) Read the barcode above to specify the time interval before the scanner enters low-speed mode.
- 2) Read the "[Decimal Value](#)" barcode on page [錯誤! 尚未定義書籤](#). For example, read "5" for the scanner to enter low-speed mode after being idle for 5 minutes.
- 3) Read the "Validate" barcode on the same page to complete this setting.

---

Note: Power-Saving will not take effect when one of the following conditions is met:

- (1) the scanner has already established a BT HID/SPP connection,
- (2) the scanner is in the configuration mode,
- (3) the scan mode is set to Test, Continuous or Alternate Mode, or
- (4) the setting value of Power-Saving is greater than that of Auto Power Off.

---



## 1.2 MEMORY

The collected data can be sent back to a host computer one by one via the WPAN connection or stored in flash memory when the scanner is set to Memory mode.

### 1.2.1 TRANSMIT BUFFER

By default, transmit buffer is enabled and for use when the scanner is out of range. Upon reading a barcode successfully within range, the scanner responds with one short beep (high tone) and its LED indicator becomes solid green and goes off quickly. However, the host computer may not receive the data immediately if getting out of range. With the 1 KB transmit buffer, the scanner can ignore the transmission status and keep on reading barcodes until the buffer is full.

#### When transmit buffer is enabled...

---

If the scanner is out of range, it will respond with two short beeps, high-low tone, upon reading a barcode successfully.

When transmit buffer is full, the scanner will respond with one long beep (low tone) and its LED indicator will become solid red and go off quickly. You are advised to get back to range.

#### When transmit buffer is disabled...

---

If the scanner is out of range, it will respond with one long beep (low tone) and its LED indicator will become solid red and go off quickly. You are advised to get back to range.

\*Enable



Disable



---

Note: The 1 KB transmit buffer on the scanner can hold as many as 64 scans based on EAN-13 barcodes. Data will be cleared out once the scanner is turned off or running out of battery power!

---



## 1.2.2 MEMORY MODE

The scanner keeps 256 KB flash memory for memory mode operation. When the scanner is in memory mode, it means any connection established with host is disabled.



Warning: No connection is allowed unless the memory mode is disabled.

### Memory Data Delay

You may set a delay between each data record while transmitting data back to the server.



8 sec



---

### Send Data

The 256 KB flash memory on the scanner can store up to 16,384 scans based on EAN-13 barcodes. When it is used up, the scanner will respond with two short beeps (high-low tone) as a warning.

You are advised to send data to the server immediately by having the scanner read the “Send Data” barcode below. It will resume connection with host automatically.

Send Data



---

### Clear Data & Confirm

Even though data has been sent back to the server, the flash memory is still occupied unless you erase the memory by having the scanner read two barcodes – “Clear Data” and “Confirm”.

1. Read the “Clear Data” barcode to clear the flash memory.
2. Read the “Confirm” barcode to confirm the action.

Clear Data



Confirm



## 1.3 LED INDICATOR

The triple-color LED on top of the scanner is used to provide user feedback. For example, the LED becomes solid red and goes off quickly upon powering on or running out of transmit buffer. You may tell the difference by the beeps – you will hear a long beep of high tone when powering on the scanner, and a long beep of low tone when the transmit buffer becomes full.

Scanner LED			Meaning
Red, on-off	---	---	<ul style="list-style-type: none"> <li>▶ Power on, with one long beep (high tone, LED on for 1 second)</li> <li>▶ Data saved to buffer when transmit buffer is enabled and the scanner is out of range, with two short beeps (high-low tone)</li> <li>▶ Transmit buffer full, with one long beep (low tone)</li> <li>▶ Transmit buffer disabled, with one long beep (low tone)</li> <li>▶ Delete the last collected data in memory mode, with two short beeps (high tone, LED on for 1 second)</li> <li>▶ Memory full in memory mode, with two short beeps (high-low tone)</li> </ul>
Red, flashing	---	---	<ul style="list-style-type: none"> <li>▶ Flashing red (On/Off ratio 0.3 s: 2.5 s) indicates the scanner is inactive and its CPU running at low speed to save power (because no WPAN connection is established after waiting for two minutes)</li> <li>▶ Configuration Mode (On/Off ratio 0.5 s: 0.5 s)</li> </ul>
---	---	Green, on-off	Good Read, with one short beep (high tone) and beeper pitch and duration programmable
---	Blue, flashing	---	<p>First, flashing blue (On/Off ratio 0.5 s: 0.5 s) for two minutes indicates the scanner is waiting for connection, and goes off if no connection is established, then flashing red (On/Off ratio 0.3 s: 2.5 s) indicates the scanner is inactive.</p> <p>It is ready for connection only while the LED is flashing blue —</p> <ul style="list-style-type: none"> <li>▶ SPP Slave: waiting host to connect</li> <li>▶ HID or SPP Master: trying to connect to host</li> <li>▶ Using 3610: trying to connect to 3610</li> </ul>
---	Blue, flashing	---	Flashing blue (On/Off ratio 0.1 s: 0.1 s) indicates the scanner receives a PIN code request from host (flashing more quickly than waiting connection).
---	Blue, flashing	---	Flashing blue (On/Off ratio 0.02 s: 3 s) indicates the scanner has established a WPAN connection successfully.
---	Blue, flashing	Green, flashing	Flashing blue and green (On/Off ratio 0.1 s: 0.1 s) indicates an error occurs while entering the PIN code. Press the [Trigger] key to get ready for re-connecting.



### 1.3.1 GOOD READ LED

\*Enable  
Good Read LED



101014

Disable  
Good Read LED



101013

### 1.3.2 GOOD READ LED DURATION

By default, the Good Read LED stays on for 40 milliseconds. Specify a value, ranging from 1 to 254 in units of 10 milliseconds.

Good Read LED  
Time-out after  
0.01~2.54 sec.  
(\*40 ms)



101020

- 1) Read the barcode above to specify the time interval before the Good Read LED goes off.
- 2) Read the "[Decimal Value](#)" barcode on page ~~錯誤! 尚未定義書籤~~. For example, read "1" and "5" for the Good Read LED to go off after 150 milliseconds.
- 3) Read the "Validate" barcode on the same page to complete this setting.



## 1.4 BEEPER

The scanner has a buzzer to provide user feedback in various operating conditions.

Beeping	Meaning
One long beep, high tone	Power on, with red LED on (1 second) and off quickly
two short beeps, high tone	<ul style="list-style-type: none"> <li>▶ Power off, with red LED on (until the key is released)</li> <li>▶ Delete the last collected data in memory mode, with red LED on (1 second) and off quickly</li> </ul>
One short beep, high tone ▶ Programmable, default to 4 KHz	Good Read, with green LED on-off quickly
Six short beeps ▶ High-low tone repeats three times	<ul style="list-style-type: none"> <li>▶ Enter Configuration Mode, with red LED flashing</li> <li>▶ Exit Configuration Mode</li> </ul>
Two short beeps, low-high tone	Setup barcode read successfully
One short beep, high tone	<ul style="list-style-type: none"> <li>▶ More setup barcode required</li> <li>▶ Input PIN code</li> <li>▶ Clear PIN code</li> </ul>
One short beep, low tone	More barcodes required to complete the "output sequence" requirements of Multi-Barcode Editor, with green LED on-off quickly (Upon completion, same as Good Read.)
One long beep, low tone	<ul style="list-style-type: none"> <li>▶ Transmit buffer full, with red LED on-off quickly</li> <li>▶ Transmit buffer disabled, with red LED on-off quickly</li> <li>▶ Configuration error (Wrong barcode...)</li> <li>▶ PIN code input error</li> <li>▶ Reject random PIN request</li> <li>▶ Fail to send data in memory mode</li> </ul>
Two short beeps, high-low tone	<ul style="list-style-type: none"> <li>▶ Data saved to buffer when transmit buffer is enabled and the scanner is out of range, with red LED on-off quickly</li> <li>▶ Memory Mode – Memory full, with red LED on-off quickly</li> </ul>
Two short beeps, high tone	Low Battery Alarm
Two long beeps, high-low tone	Multi-Barcode Mode – Buffer full
Three short beeps, tone ascending from low to high	<ul style="list-style-type: none"> <li>▶ WPAN connection established, with blue LED flashing</li> <li>▶ WPAN connection resumed, with blue LED flashing</li> </ul>
Three short beeps, tone ascending from high to low	WPAN connection out of range or suspended



### 1.4.1 BEEPER VOLUME

Mute



101009

Minimum Volume



101010

Medium Volume



101011

\*Maximum Volume



101012





## 1.4.2 GOOD READ BEEP

### Frequency



### Duration

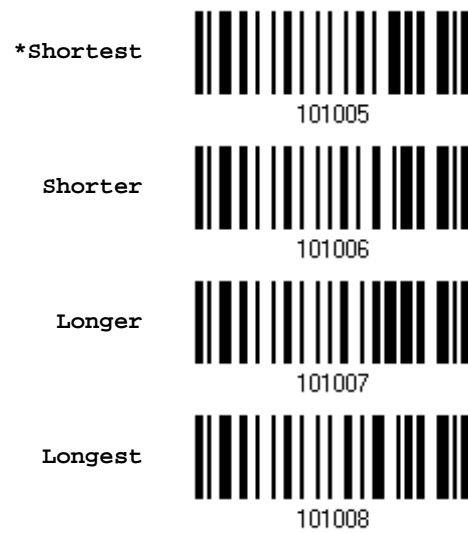

### 1.4.3 LOW BATTERY ALARM (1660)

By default, "2.6 V (Alkaline)" is selected for low battery level. When the battery level inside the 1660 scanner reaches 2.6 V, it will activate the beeper to give a warning. If you are using Ni-MH batteries, select "2.1 V (Ni-MH)". In order to prevent data loss, you are advised to replace the batteries immediately when you hear two short beeps (high tone).

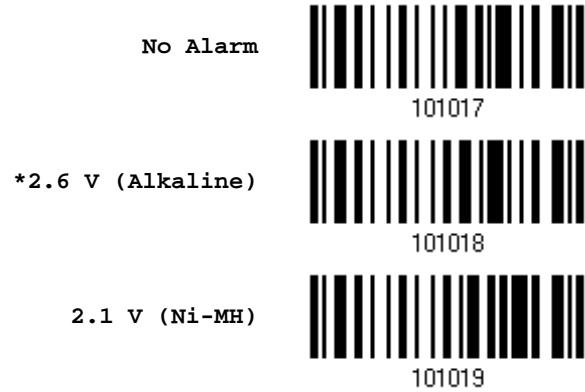

Note: Ni-MH batteries available in retail stores can be used to replace the two AAA Alkaline batteries.

### 1.4.4 LOW BATTERY ALARM (1661)

By default, it will activate the beeper to give a warning when the battery charge gets low. In order to prevent data loss, you are advised to replace the battery immediately when you hear two short beeps (high tone).

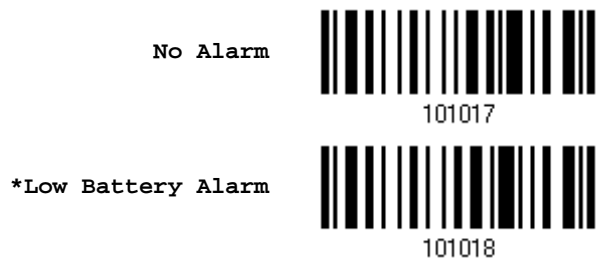

## 1.5 SEND "NR" TO HOST

The scanner can send the "NR" string to the host to notify the No Read event.

Enable



100267

\*Disable



100266



Update

## 1.6 SCAN MODES

Different scan modes are supported – select the scan mode that best suits the requirements of a specific application. Refer to the comparison table below.

Scan Mode	Start to Scan				Stop Scanning			
	Always	Press trigger once	Hold trigger	Press trigger twice	Release trigger	Press trigger once	Barcode being read	Timeout
Continuous mode	✓							
Test mode	✓							
Default mode			✓		✓		✓	✓
Auto Off mode		✓					✓	✓
Auto Power Off mode		✓						✓
Alternate mode		✓				✓		
Aiming mode				✓			✓	✓
Multi-Barcode mode			✓		✓			

Note: By default, the scan mode is set to Default mode.



### 1.6.1 CONTINUOUS MODE

The scanner is always scanning.

- ▶ After a successful decoding, the removal of barcode is required. It is not allowed to proceed to decode until the decoding delay time has passed.
- ▶ To decode the same barcode repeatedly, move away the barcode and put it back again and again for scanning.

Note: Refer to "Delay between Re-read".

Continuous Mode



#### Decoding Delay

Set the time interval between each decoding.

\*Disable



0.5 sec



1 sec



2 sec



### 1.6.2 TEST MODE

The scanner is always scanning.

- ▶ Capable of decoding the same barcode repeatedly without removing it, for testing purpose.

Test Mode



### 1.6.3 DEFAULT MODE

The scanner will start scanning once the trigger is held down.

- ▶ The scanning won't stop until (1) a barcode is decoded, (2) the pre-set timeout expires, or (3) you release the trigger.

---

Note: Refer to "Scanning Timeout".

---

\*Default mode



### 1.6.4 AUTO OFF MODE

The scanner will start scanning once the trigger is pressed.

- ▶ The scanning won't stop until (1) a barcode is decoded, and (2) the pre-set timeout expires.

---

Note: Refer to "Scanning Timeout".

---

Auto Off Mode



### 1.6.5 AUTO POWER OFF MODE

The scanner will start scanning once the trigger is pressed.

- ▶ The scanning won't stop until the pre-set timeout expires, and, the pre-set timeout period re-counts after each successful decoding.

---

Note: Refer to "Delay between Re-read" and "Scanning Timeout".

---

Auto Power Off Mode



### 1.6.6 ALTERNATE MODE

The scanner will start scanning once the trigger is pressed

- ▶ The scanning won't stop until you press the trigger again.

Alternate Mode



### 1.6.7 AIMING MODE

The scanner will aim at a barcode once the trigger is pressed, and start scanning when the trigger is pressed again within one second.

- ▶ The scanning won't stop until (1) a barcode is decoded, and (2) the pre-set timeout expires.

Aiming Mode



#### Aiming Timeout

You can limit the aiming time interval (1~15). By default, the scanner time-out is set to 1 second.

Aiming Time-out  
after 1~15 sec.  
(\*1)



1. Read the barcode above to specify the time interval before aiming ends. (It is set to 1 by default.)
2. Read the "[Decimal Value](#)" barcode on page [錯誤! 尚未定義書籤](#). For example, read "1" and "0" for the scanner to automatically shut down after being idle for 10 seconds.
3. Read the "Validate" barcode on the same page to complete this setting.



### 1.6.8 MULTI-BARCODE MODE

The scanner will be scanning as long as the trigger is held down, capable of decoding one single barcode, as well as a multiple unique barcodes one at a time. While decoding a bunch of unique barcodes, if a barcode is decoded twice, its subsequent decoding will be ignored and the scanner is expecting another unique barcode.

- ▶ The scanning won't stop until you release the trigger.



Note: (1) A barcode is considered unique when its Code Type or data is different from others.  
(2) Multi-Barcode Mode has nothing to do with the [Multi-Barcode Editor](#).

---





## 1.7 SCANNING TIMEOUT

Specify the scanning time interval (1~254 sec.; 0= Disable) when the scan mode is set to any of the following –

- ▶ Default mode
- ▶ Auto Off mode
- ▶ Auto Power Off mode
- ▶ Aiming mode

Scanner Time-out  
after 0~254 sec.  
(\*10)



- 1) Read the barcode above to specify the time interval before the scan engine times out.
- 2) Read the "[Decimal Value](#)" barcode on page [錯誤! 尚未定義書籤。](#). For example, read "1" and "5" for the scanner to automatically shut down after being idle for 15 seconds.
- 3) Read the "Validate" barcode on the same page to complete this setting.



## 1.8 DELAY BETWEEN RE-READ

This is also referred to as the “Blocking Time”, which is used to prevent the scanner from accidentally reading the same barcode twice when the scan mode is set to any of the following –

- ▶ Continuous mode
- ▶ Auto Power Off mode
- ▶ Alternate mode



## 1.9 READ REDUNDANCY FOR ALL SYMBLOGIES

Select the level of reading security. For example,

- ▶ If "No Redundancy" is selected, one successful decoding will make the reading valid and induce the "READER Event".
- ▶ If "Three Times" is selected, it will take a total of four consecutive successful decoding of the same barcode to make the reading valid. The higher the reading security is (that is, the more redundancy the user selects), the slower the reading speed gets.

It is obvious that the more redundancy you select, the higher the reading security is, and thus, the slower the reading speed becomes. You will have to compromise between reading security and decoding speed.

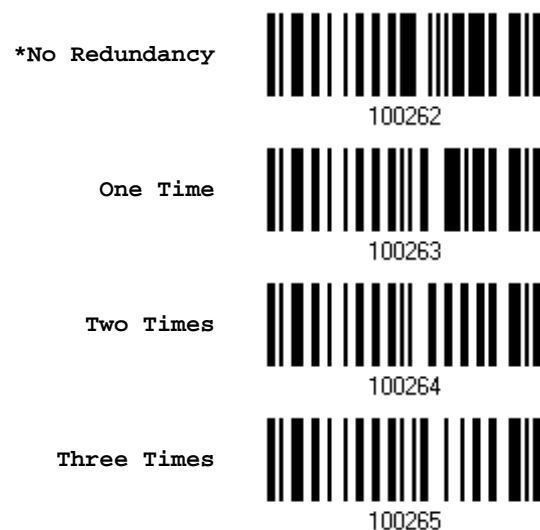

## 1.10 ADDON SECURITY FOR UPC/EAN BARCODES

The scanner is capable of decoding a mix of UPC/EAN barcodes with and without addons. The read redundancy (0~30 times) allows changing the number of times to decode a UPC/EAN barcode before transmission. The more redundancy you select, the higher the reading security is, and thus, the slower the reading speed becomes. You will have to compromise between reading security and decoding speed.

---

Note: UPC/EAN Addon 2 and Addon 5 must be enabled individually for this setting to take effect.

---

Addon Security Level  
(\*0~30)



100380

- 1) Read the barcode above to specify the read redundancy for UPC/EAN barcodes. (It is set to 0 by default.)
- 2) Read the "[Decimal Value](#)" barcode on page [錯誤! 尚未定義書籤](#). For example, read "1" and "2" for the scanner to re-read the barcode for 12 times.
- 3) Read the "Validate" barcode on the same page to complete this setting.



## 1.11 NEGATIVE BARCODES

Normally, barcodes are printed with the color of the bars darker than that of the spaces. But for negative barcodes, they are printed in the opposite sense just like negative films. The spaces of negative barcodes are printed with a color darker than that of the bars. You can configure the scanner to be able to read negative barcodes.

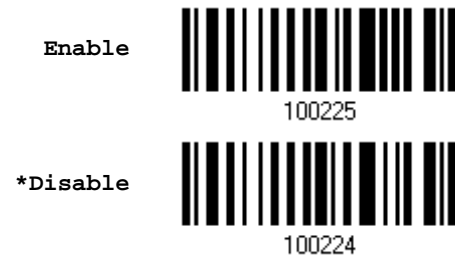

## 1.12 EFFECTIVE DECODING AREA

By default, the effective decoding area is 100% covered by the scanned area. However, you may narrow down the decoding area to prevent reading the wrong barcode when a number of barcodes are printed closely. The scanner will only read barcodes that appear in the effective decoding area.

Read the barcode "Centering On" and specify the percentage to narrow down the decoding area. For example, read "Left 10%" and then "Right 30%" for the scanner to decode barcode "A" only.

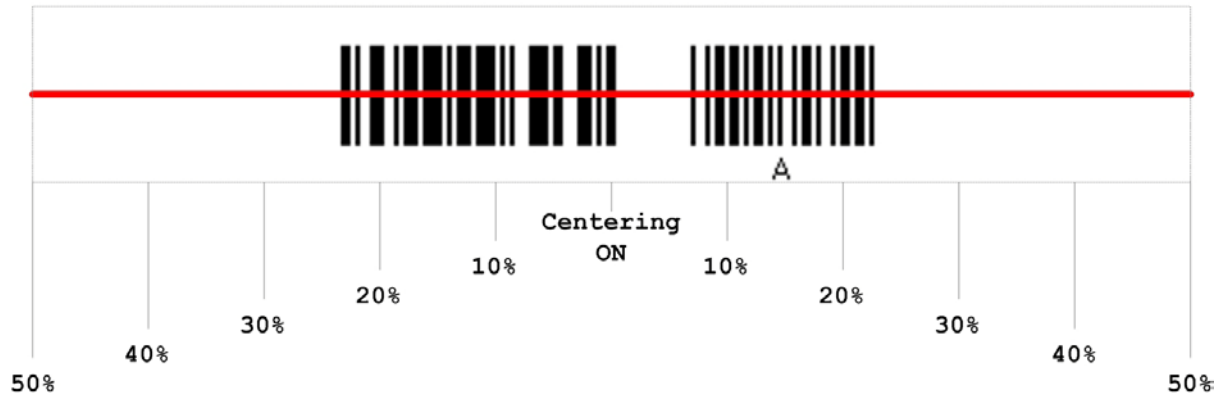

### 1.12.1 POSITIONING WINDOW

Centering On



\*Centering Off



## 1.12.2 ADJUSTING WINDOW

### Percentage for Left Half

<b>*Left 50%</b>	A barcode with 10 vertical bars of varying widths, representing a 50% left half adjustment. The bars are evenly spaced and have a consistent width.
	100280
<b>Left 40%</b>	A barcode with 10 vertical bars of varying widths, representing a 40% left half adjustment. The bars are evenly spaced and have a consistent width.
	100281
<b>Left 30%</b>	A barcode with 10 vertical bars of varying widths, representing a 30% left half adjustment. The bars are evenly spaced and have a consistent width.
	100282
<b>Left 20%</b>	A barcode with 10 vertical bars of varying widths, representing a 20% left half adjustment. The bars are evenly spaced and have a consistent width.
	100283
<b>Left 10%</b>	A barcode with 10 vertical bars of varying widths, representing a 10% left half adjustment. The bars are evenly spaced and have a consistent width.
	100284

### Percentage for Right Half

<b>Right 10%</b>	A barcode with 10 vertical bars of varying widths, representing a 10% right half adjustment. The bars are evenly spaced and have a consistent width.
	100288
<b>Right 20%</b>	A barcode with 10 vertical bars of varying widths, representing a 20% right half adjustment. The bars are evenly spaced and have a consistent width.
	100289
<b>Right 30%</b>	A barcode with 10 vertical bars of varying widths, representing a 30% right half adjustment. The bars are evenly spaced and have a consistent width.
	100290
<b>Right 40%</b>	A barcode with 10 vertical bars of varying widths, representing a 40% right half adjustment. The bars are evenly spaced and have a consistent width.
	100291
<b>*Right 50%</b>	A barcode with 10 vertical bars of varying widths, representing a 50% right half adjustment. The bars are evenly spaced and have a consistent width.
	100292







## SELECTING OUTPUT INTERFACE

---

In order to establish a proper connection between your computer and the scanner, we suggest that you follow these instructions –

- 1) Install batteries and hold down the [Power/Delete] key for about 2 seconds to turn on the scanner.
- 2) Have the scanner read the “Enter Setup” barcode to enter the configuration mode.
- 3) Have the scanner read the associated barcodes to activate the desired interface.  
See the following sections for output interfaces supported.
- 4) Have the scanner read the barcodes for related settings.
- 5) Have the scanner read the “Update” barcode to exit the configuration mode.
- 6) Turn on your computer or laptop and establish a WPAN connection with the scanner.

Refer to [Chapter 3 – Setting up a WPAN Connection](#).

---

Note: By default, the output interface is set to “BT HID”.

---

### IN THIS CHAPTER

---

2.1 BT HID .....	50
2.2 BT SPP Slave .....	61
2.3 BT SPP Master .....	63
2.4 USB HID via 3610 .....	67
2.5 USB Virtual COM via 3610 .....	76



## 2.1 BT HID

For BT HID, refer to [Chapter 3 – Setting up a WPAN Connection](#) for related connection settings. Run any text editor on your computer, and the scanned data will be transmitted to the computer.

HID Settings	Defaults
Keyboard Type	PCAT (US)
Alphabets Layout	Normal
Digits Layout	Normal
Capital Lock Type	Normal
Capital Lock State	Off
Alphabets Transmission	Case-sensitive
Digits Transmission	Alphanumeric keypad
Inter-Function Delay	0 (ms)

### 2.1.1 ACTIVATE BT HID & SELECT KEYBOARD TYPE

When BT HID interface is activated, you will have to select a keyboard type to complete this setting. By default, BT HID is activated on the scanner, and the keyboard type is set to PCAT (US).

Activate BT HID &  
Select Keyboard  
Type...



- 1) Read the barcode above to activate BT HID and select a keyboard type.

Note: If the scanner responds with one long beep (low tone) upon reading the barcode, it means the current firmware of your scanner is earlier than version 1.21. Please upgrade the firmware to version 1.21 or later!

- 2) Read the “[Decimal Value](#)” barcode on page **錯誤! 尚未定義書籤。** Refer to the table below for the number of desired keyboard type.
- 3) Read the “Validate” barcode on the same page to complete this setting.



## BT HID

By default, the keyboard type is set to PCAT (US). The following keyboard types are supported —

No.	Keyboard Type	No.	Keyboard Type
64	PCAT (US)	71	PCAT (Belgium)
65	PCAT (French)	72	PCAT (Spanish)
66	PCAT (German)	73	PCAT (Portuguese)
67	PCAT (Italy)	74	PS55 A01-2 (Japanese)
68	PCAT (Swedish)	75	User-defined table
69	PCAT (Norwegian)	76	PCAT (Turkish)
70	PCAT (UK)		

### 2.1.2 RESET CONNECTION

For BT HID, you can only have the scanner connected to one computer at a time. If you want to connect the scanner to another host, you must have it read the “Reset Connection” barcode so that the current connection record will be cleared. Then, the scanner will restart itself automatically. Go through the whole process in [3.2.3 Connect to Dongle](#) to establish a new connection.

Reset Connection



109919

Note: The “Restore System Defaults” barcode will have the current connection record cleared as well.



### 2.1.3 KEYBOARD SETTINGS

- ▶ Alphabets Layout
- ▶ Digits Layout
- ▶ Capital Lock Type
- ▶ Capital Lock Setting
- ▶ Alphabets Transmission
- ▶ Digits Transmission

Note: BT HID does not support these functions on PDAs – (1) Capital Lock Setting: Auto Detection (2) Digits Transmission: Numeric Key

---

#### Alphabets Layout

By default, the alphabets layout is set to normal mode, also known as the standard English layout. Select French or German keyboard layout if necessary. The scanner will make adjustments when sending the "A", "Q", "W", "Z", "Y", and "M" characters according to this setting.



Note: This setting only works when the keyboard type selected is US keyboard, such as PCAT (US). The Alphabets Layout and Digits Layout setting must match your keyboard.

---



### US Keyboard Style - Normal

QWERTY layout, which is normally used in western countries.

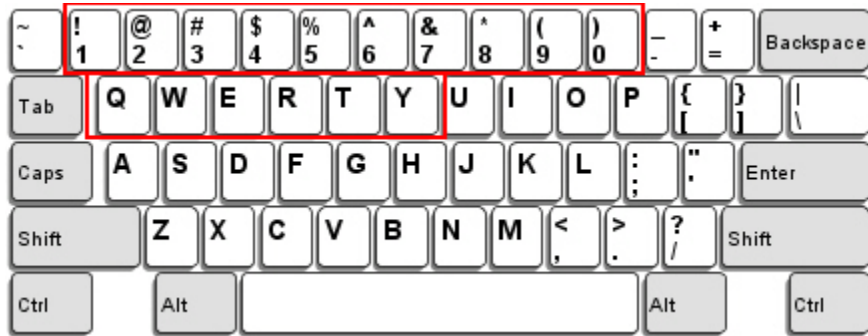

- ▶ Select "Lower Row" for the "Digits Layout" setting for the upper row is for special characters.

### French Keyboard Style - AZERTY

French layout; see below for French Keyboard Style.

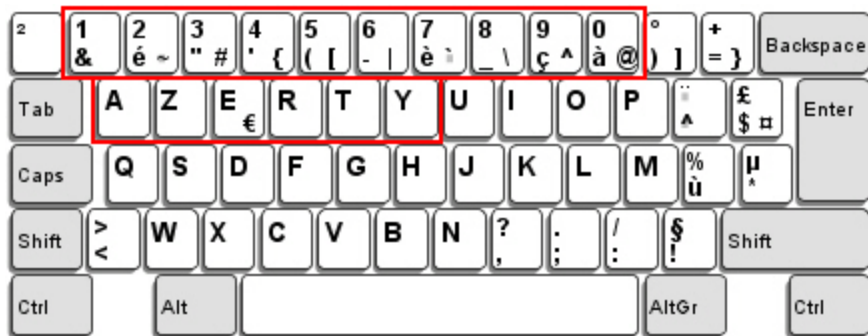

- ▶ Select "Upper Row" for the "Digits Layout" setting for the lower row is for special characters.

### German Keyboard Layout - QWERTZ

German layout; see below for German Keyboard Style.

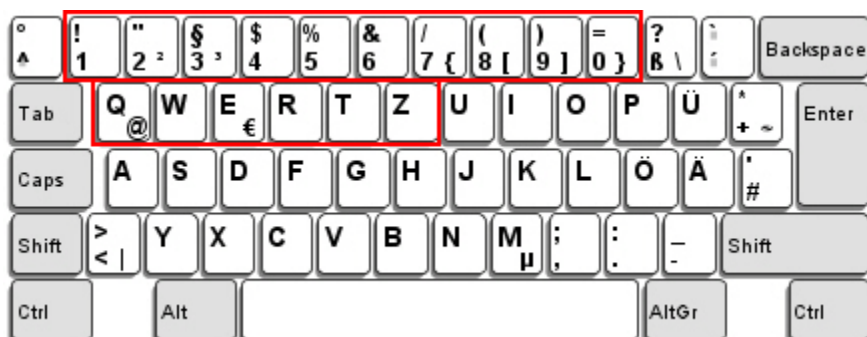

- ▶ Select "Lower Row" for the "Digits Layout" setting for the upper row is for special characters.



### Digits Layout

Select a proper layout that matches the alphabets layout. The scanner will make adjustments according to this setting.

Options	Description
Normal	Depends on the [Shift] key or [Shift Lock] setting
Lower Row	For QWERTY or QWERTZ keyboard
Upper Row	For AZERTY keyboard

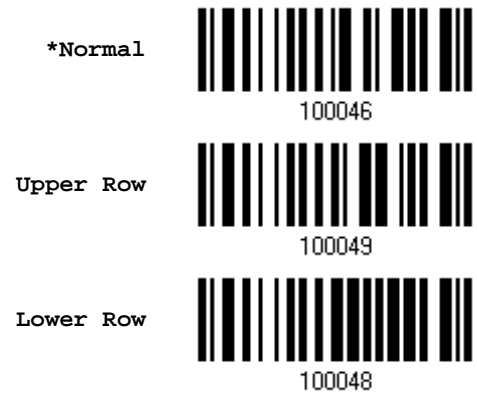

---

Note: This setting is to be used with the Character Substitution setting when support to certain keyboard types (languages) is unavailable but required.

---



## Capital Lock Type & Setting

In order to send the alphabets with correct case, the scanner needs to know the status of Caps Lock on the keyboard. Incorrect settings may result in reversed case of the alphabets being transmitted.

Cap Lock Type	Description
Normal	Normal type
Capital Lock	When enabled, the keys of alphabetic characters will be interpreted as capital letters. However, this does not affect the number or punctuation keys.
Shift Lock	When enabled, the keys of alphabetic characters will be interpreted as capital letters. In addition, this affects the number or punctuation keys.



Capital Lock State	Description
Capital Lock OFF	Assuming that the status of Caps Lock on the keyboard is OFF, transmitted characters are exactly the same as in the barcode (when "case-sensitive" is selected for Alphabets Transmission).
Capital Lock ON	Assuming that the status of Caps Lock on the keyboard is ON, transmitted characters are exactly the same as in the barcode (when "case-sensitive" is selected for Alphabets Transmission). ▶ Refer to the Capital Lock Type above.
Auto Detection	The scanner will automatically detect the status of Caps Lock on the keyboard before data is transmitted; transmitted characters are exactly the same as in the barcode (when "case-sensitive" is selected for Alphabets Transmission). ▶ This setting is not supported on PDAs.



\*Capital Lock OFF



100052



Enter Setup



## Alphabets Transmission

By default, the alphabets transmission is case-sensitive, meaning that the alphabets will be transmitted according to their original case, the status of Caps Lock on the keyboard, as well as the Capital Lock setting. Select [Ignore Case] to have alphabets transmitted according to the status of Caps Lock on the keyboard only.

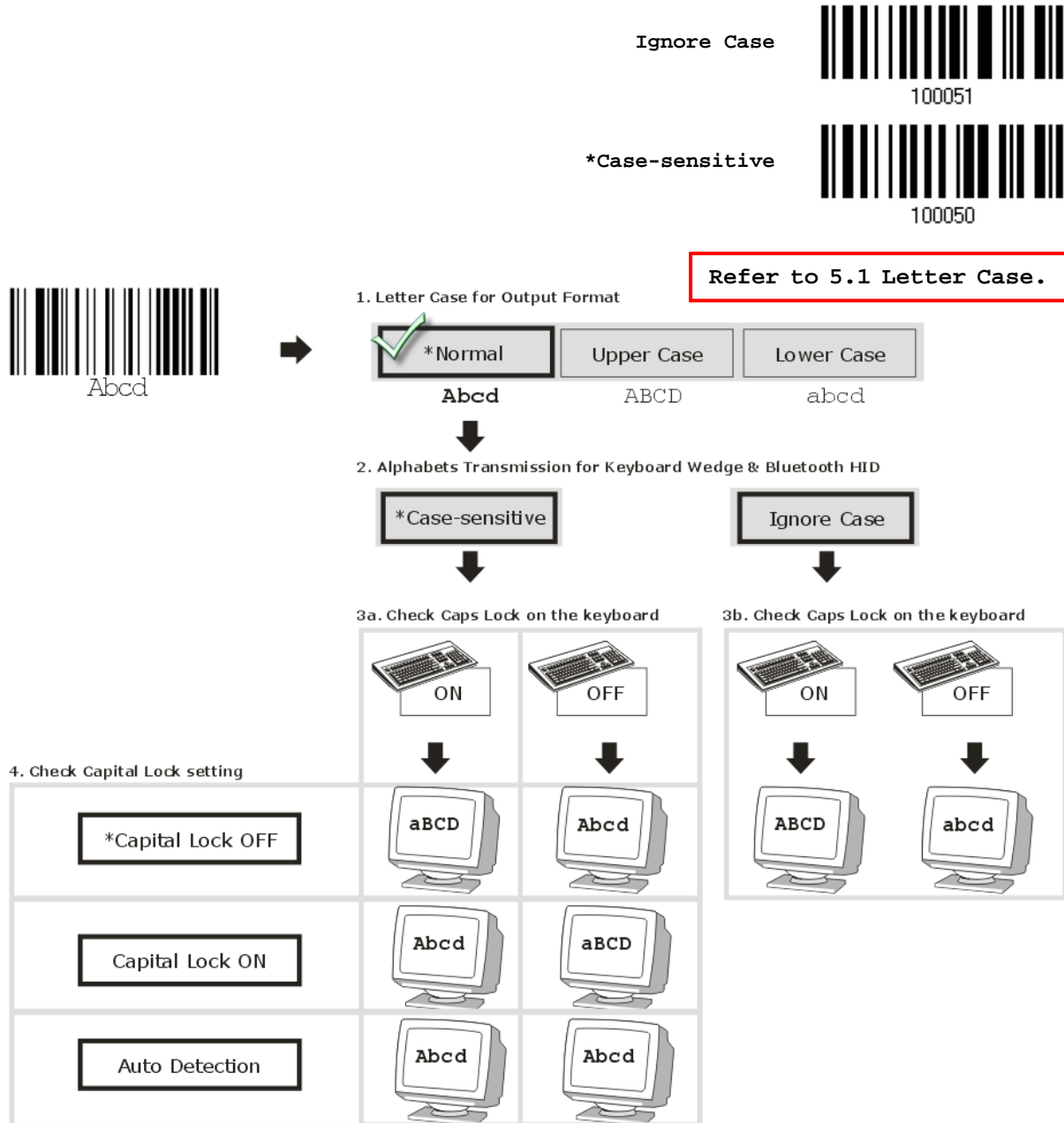

### Digits Transmission

By default, the alphanumeric keypad is used for transmitting digits. Select "Numeric Keypad" if you wish to use the keys on the numeric keypad.

Numeric Key



\*Alphanumeric Key

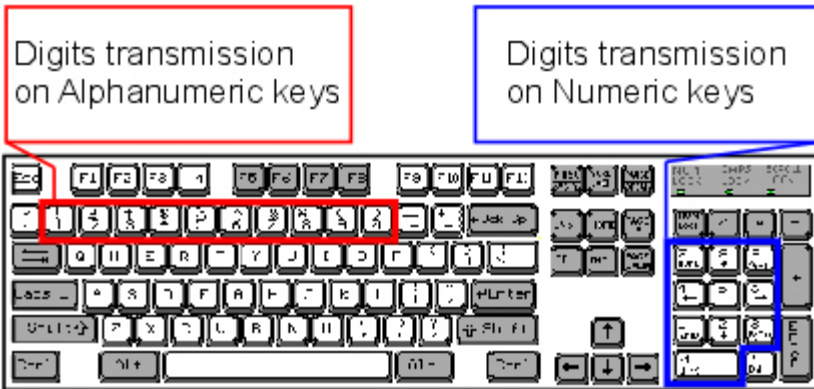

---

Note: If you select "Numeric Keypad", the Num Lock status of the physical keyboard should be "ON". This setting is not supported on PDAs.

---



### 2.1.4 INTER-FUNCTION DELAY

By default, the inter-function delay is set to zero. Specify a value, ranging from 0 to 254, to match the computer response time of the keyboard interface. Such delay time is inserted between every function code (0x01 ~ 0x1F) being transmitted. The longer the delay time is, the slower the transmission speed will be.

Value	Delay Time	Value	Delay Time
0	Disable	195 ~ 204	200 millisecond
1 ~ 14	10 millisecond	205 ~ 214	210 millisecond
15 ~ 24	20 millisecond	215 ~ 224	220 millisecond
25 ~ 34	30 millisecond	225 ~ 234	230 millisecond
35 ~ 44	40 millisecond	235 ~ 244	240 millisecond
45 ~ 54	50 millisecond	245 ~ 254	250 millisecond
...	...		

Inter-Function  
Delay... (\*0~254)



- 1) Read the barcode to specify the inter-function delay.
- 2) Read the "[Decimal Value](#)" barcode on page 錯誤! 尚未定義書籤。 for the desired inter-function delay (millisecond).
- 3) Read the "Validate" barcode on the same page to complete this setting.

### 2.1.5 HID CHARACTER TRANSMIT MODE

By default, HID interface sends data to the host in batch. You may have the scanner read the "By Character" barcode to process data one character at a time.

\*Batch Processing



By Character



Note: "By Character" transmit mode is required when working with iPhone or iPad.



### 2.1.6 KEYPAD SUPPORT FOR IPHONE/IPAD

When the scanner has been successfully connected to iPhone or iPad for data collection, the onscreen keypad of iPhone or iPad will disappear. You may have the scanner read the "Use POWER Key to Show or Hide Keypad" barcode in advance. Then, it will allow pressing the [Power/Delete] key to show or hide the onscreen keypad.

---

Note: This function only works for  
(1) iPhone 4 and 3GS version 4.1 or later, and (2) iPad version 4.2 or later.

---

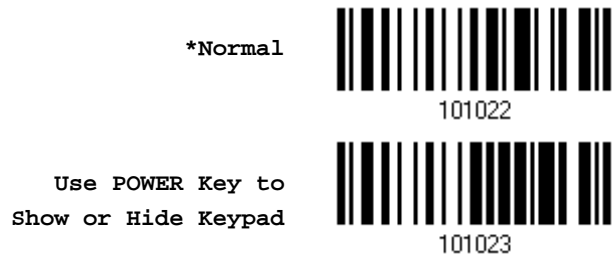

Instead of using the [Power/Delete] key, you may have the scanner read the following barcode to show or hide the keypad.

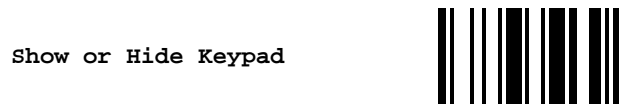

## 2.2 BT SPP SLAVE

For BT SPP Slave, refer to [Chapter 3 – Setting up a WPAN Connection](#) for related connection settings.

### 2.2.1 ACTIVATE BT SPP SLAVE MODE

This is SPP Slave Mode.

Activate BT SPP,  
Slave Mode



100003

### 2.2.2 INTER-FUNCTION DELAY

By default, the inter-function delay is set to zero. Specify a value, ranging from 0 to 254, to match the computer response time of the keyboard interface. Such delay time is inserted between every function code (0x01 ~ 0x1F) being transmitted. The longer the delay time is, the slower the transmission speed will be.

Value	Delay Time	Value	Delay Time
0	Disable	195 ~ 204	200 millisecond
1 ~ 14	10 millisecond	205 ~ 214	210 millisecond
15 ~ 24	20 millisecond	215 ~ 224	220 millisecond
25 ~ 34	30 millisecond	225 ~ 234	230 millisecond
35 ~ 44	40 millisecond	235 ~ 244	240 millisecond
45 ~ 54	50 millisecond	245 ~ 254	250 millisecond
...	...		

Inter-Function  
Delay... (\*0~254)



100012

- 1) Read the barcode above to specify the inter-function delay.
- 2) Read the "[Decimal Value](#)" barcode on page 錯誤! 尚未定義書籤。 for the desired inter-function delay (millisecond).
- 3) Read the "Validate" barcode on the same page to complete this setting.



### 2.2.3 ACK/NAK TIMEOUT

By default, the scanner sends data to the host without waiting for an ACK/NAK response before sending more data. Specify a value, ranging from 1 to 99 in units of 0.1 second. If no response within the specified period of time, the scanner will attempt to send the same data two more times. If all three attempts fail without any notification, data loss will occur.

ACK/NAK Time-out  
after ... (\*0~99)



100013

- 1) Read the barcode to specify the time interval for the scanner to send data and wait for a response from the host.
- 2) Read the "[Decimal Value](#)" barcode on page [錯誤! 尚未定義書籤](#). For example, read "1" and "0" for the scanner to automatically shut down after being idle for 1 second.
- 3) Read the "Validate" barcode on the same page to complete this setting.

#### ACK/NAK Error Beep

---

Enable Error Beep



100015

\*Disable Error Beep



100014

---

Note: We suggest enabling the error beep so that you will be notified of such data loss and have the scanner re-read data.

---



## 2.3 BT SPP MASTER

As a SPP master device, the scanner will be able to resume connection with the host upon powering on again, as long as the host application is running. If the scanner fails to resume connection, it will try every 5 seconds to re-connect to the host unless you have the scanner read the “Reset Connection” or “Restore System Defaults” barcode.

For BT SPP Master, refer to [3.2.2 Configure Related Settings](#) for related connection settings.

Note: In SPP Master Mode, if it fails to re-connect within the specified period of time (2 minutes by default), the scanner will become inactive to save power. Once the re-connection is established successfully, the scanner will not go through transition from full CPU speed to low CPU speed even though it is idle during the specified time interval for Auto Power Off. It will automatically turn off when the time is up. Refer to [1.1.2 Auto Power Off & Power-Saving](#).

### 2.3.1 ACTIVATE BT SPP MASTER MODE

This is SPP Master Mode.

Activate BT SPP,  
Master Mode



#### How to connect with the target device?

Produce two setup barcodes for the target SPP slave device, just like what we do for 3610.

- ▶ “Set Connection”
- ▶ “MAC ID”

Note: The “MAC ID” barcode must have a prefix of two characters, either “0x” or “OX”, followed by the real MAC address of the target device.

Usage:

1. Read the “Activate BT SPP, Master Mode” barcode above and barcodes for connection settings, such as authentication and preset PIN. Skip this step if no connection settings are desired.
2. Read the “Set Connection” and “MAC ID” barcodes. The scanner will respond with one beep upon reading each of the barcodes.

Set Connection



Note: Read the “Set Connection” barcode first, and then the “MAC ID” barcode within 10 seconds.

---

Instead of producing the “MAC ID” barcode, you may have the scanner read the setup barcodes for entering the MAC address.

- ▶ Have the scanner read the “Abort” barcode to cancel the operation at any time while reading setup barcodes for the MAC address. If the MAC address has not been completed yet, having the scanner read the “Validate” barcode can cancel the operation as well.

Enter MAC ID in  
Hexadecimal...



Usage:

1. Read the barcode above.
2. Read the “[Hexadecimal Value](#)” barcode on page [錯誤! 尚未定義書籤。](#) for the desired MAC address.
3. Read the “Validate” barcode on the same page to complete this setting.

### Exit SPP Master Mode

---

To stop re-connection, have the scanner read “Reset Connection” or “Restore System Defaults” barcode so that the current connection record (= MAC ID) will be cleared. Then, the scanner will restart itself automatically. Go through the whole process in [3.2.3 Connect to Dongle](#) to establish a new WPAN connection.

Reset Connection





### 2.3.2 INTER-FUNCTION DELAY

By default, the inter-function delay is set to zero. Specify a value, ranging from 0 to 254, to match the computer response time of the keyboard interface. Such delay time is inserted between every function code (0x01 ~ 0x1F) being transmitted. The longer the delay time is, the slower the transmission speed will be.

Value	Delay Time	Value	Delay Time
0	Disable	195 ~ 204	200 millisecond
1 ~ 14	10 millisecond	205 ~ 214	210 millisecond
15 ~ 24	20 millisecond	215 ~ 224	220 millisecond
25 ~ 34	30 millisecond	225 ~ 234	230 millisecond
35 ~ 44	40 millisecond	235 ~ 244	240 millisecond
45 ~ 54	50 millisecond	245 ~ 254	250 millisecond
...	...		

Inter-Function  
Delay... (\*0~254)



- 1) Read the barcode above to specify the inter-function delay.
- 2) Read the "[Decimal Value](#)" barcode on page 錯誤! 尚未定義書籤。 for the desired inter-function delay (millisecond).
- 3) Read the "Validate" barcode on the same page to complete this setting.



### 2.3.3 ACK/NAK TIMEOUT

By default, the scanner sends data to the host without waiting for an ACK/NAK response before sending more data. Specify a value, ranging from 1 to 99 in units of 0.1 second. If no response within the specified period of time, the scanner will attempt to send the same data two more times. If all three attempts fail without any notification, data loss will occur.

ACK/NAK Time-out  
after ... (\*0~99)



100013

- 1) Read the barcode above to specify the time interval for the scanner to send data and wait for a response from the host.
- 2) Read the "[Decimal Value](#)" barcode on page [錯誤! 尚未定義書籤](#). For example, read "1" and "0" for the scanner to automatically shut down after being idle for 1 second.
- 3) Read the "Validate" barcode on the same page to complete this setting.

#### ACK/NAK Error Beep

Enable Error Beep



100015

\*Disable Error Beep



100014

Note: We suggest enabling the error beep so that you will be notified of such data loss and have the scanner re-read data.

### 2.3.4 SWITCH BETWEEN MASTER/SLAVE MODE

After the scanner has established a connection as a SPP slave device, you may have it read the "Activate BT SPP, Master Mode" setup barcode to switch to SPP Master Mode. This will result in easy and reliable re-connection, just like connecting with 3610.



## 2.4 USB HID VIA 3610

For USB HID, connect 3610 to the USB port of PC, and then connect the scanner to 3610. Run any text editor on your computer, and the scanned data will be transmitted to the computer.

HID Settings	Defaults
Keyboard Type	PCAT (US)
Digits Layout	Normal
Capital Lock Type	Normal
Capital Lock State	Off
Alphabets Transmission	Case-sensitive
Digits Transmission	Alphanumeric keypad
Inter-Function Delay	0 (ms)

### 2.4.1 ACTIVATE USB HID & SELECT KEYBOARD TYPE

When USB HID interface is activated, you will have to select a keyboard type to complete this setting.

Activate  
3610 USB HID & Select  
Keyboard Type...



- 1) Read the barcode above to activate USB HID and select a keyboard type.
- 2) Read the “[Decimal Value](#)” barcode on page 錯誤! 尙未定義書籤。 . Refer to the table below for the number of desired keyboard type.
- 3) Read the “Validate” barcode on the same page to complete this setting.

#### USB HID

By default, the keyboard type is set to PCAT (US). The following keyboard types are supported —

No.	Keyboard Type	No.	Keyboard Type
64	PCAT (US)	71	PCAT (Belgium)
65	PCAT (French)	72	PCAT (Spanish)
66	PCAT (German)	73	PCAT (Portuguese)
67	PCAT (Italy)	74	PS55 A01-2 (Japanese)
68	PCAT (Swedish)	75	User-defined table
69	PCAT (Norwegian)	76	PCAT (Turkish)
70	PCAT (UK)		



## 2.4.2 KEYBOARD SETTINGS

- ▶ Alphabets Layout
- ▶ Digits Layout
- ▶ Capital Lock Type
- ▶ Capital Lock Setting
- ▶ Alphabets Transmission
- ▶ Digits Transmission

### Alphabets Layout

---

By default, the alphabets layout is set to normal mode, also known as the standard English layout. Select French or German keyboard layout if necessary. The scanner will make adjustments when sending the "A", "Q", "W", "Z", "Y", and "M" characters according to this setting.



---

Note: This setting only works when the keyboard type selected is US keyboard, such as PCAT (US). The Alphabets Layout and Digits Layout setting must match your keyboard.

---



### US Keyboard Style - Normal

QWERTY layout, which is normally used in western countries.

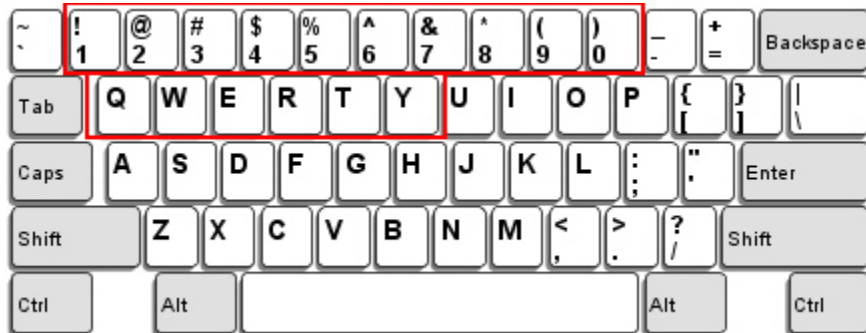

- ▶ Select "Lower Row" for the "Digits Layout" setting for the upper row is for special characters.

### French Keyboard Style - AZERTY

French layout; see below for French Keyboard Style.

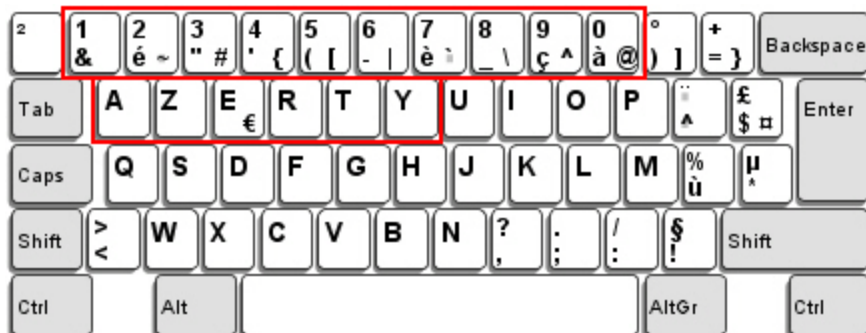

- ▶ Select "Upper Row" for the "Digits Layout" setting for the lower row is for special characters.

### German Keyboard Layout - QWERTZ

German layout; see below for German Keyboard Style.

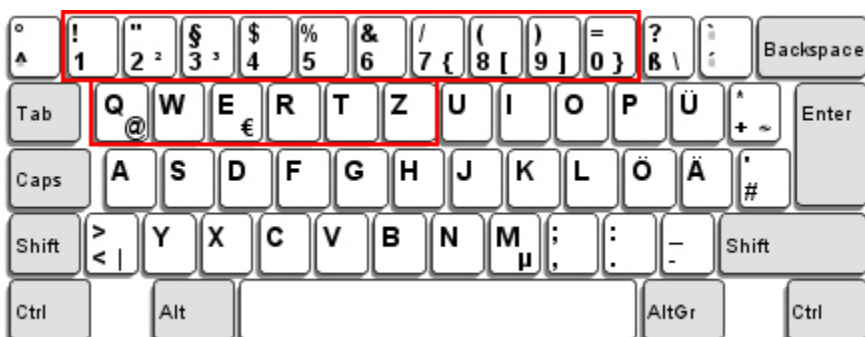

- ▶ Select "Lower Row" for the "Digits Layout" setting for the upper row is for special characters.



### Digits Layout

Select a proper layout that matches the alphabets layout. The scanner will make adjustments according to this setting.

Options	Description
Normal	Depends on the [Shift] key or [Shift Lock] setting
Lower Row	For QWERTY or QWERTZ keyboard
Upper Row	For AZERTY keyboard

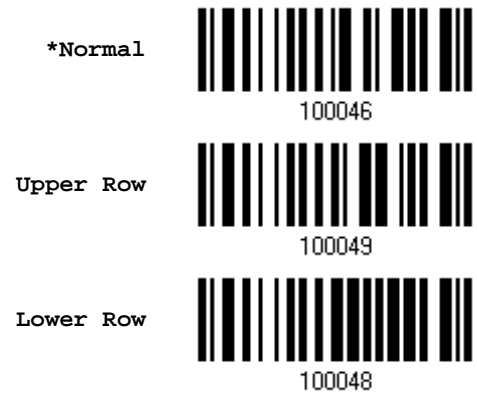

---

Note: This setting is to be used with the Character Substitution setting when support to certain keyboard types (languages) is unavailable but required.

---



## Capital Lock Type & Setting

In order to send the alphabets with correct case, the scanner needs to know the status of Caps Lock on the keyboard. Incorrect settings may result in reversed case of the alphabets being transmitted.

Cap Lock Type	Description
Normal	Normal type
Capital Lock	When enabled, the keys of alphabetic characters will be interpreted as capital letters. However, this does not affect the number or punctuation keys.
Shift Lock	When enabled, the keys of alphabetic characters will be interpreted as capital letters. In addition, this affects the number or punctuation keys.



Capital Lock State	Description
Capital Lock OFF	Assuming that the status of Caps Lock on the keyboard is OFF, transmitted characters are exactly the same as in the barcode (when "case-sensitive" is selected for Alphabets Transmission).
Capital Lock ON	Assuming that the status of Caps Lock on the keyboard is ON, transmitted characters are exactly the same as in the barcode (when "case-sensitive" is selected for Alphabets Transmission). ▶ Refer to the Capital Lock Type above.
Auto Detection	The scanner will automatically detect the status of Caps Lock on the keyboard before data is transmitted; transmitted characters are exactly the same as in the barcode (when "case-sensitive" is selected for Alphabets Transmission).

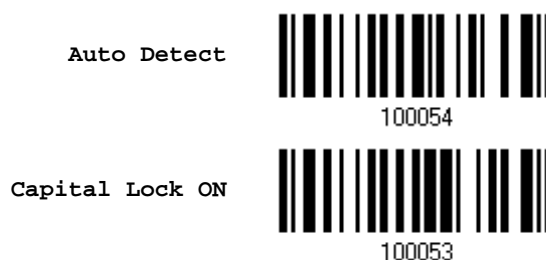

\*Capital Lock OFF



100052



Enter Setup



## Alphabets Transmission

By default, the alphabets transmission is case-sensitive, meaning that the alphabets will be transmitted according to their original case, the status of Caps Lock on the keyboard, as well as the Capital Lock setting. Select [Ignore Case] to have alphabets transmitted according to the status of Caps Lock on the keyboard only.

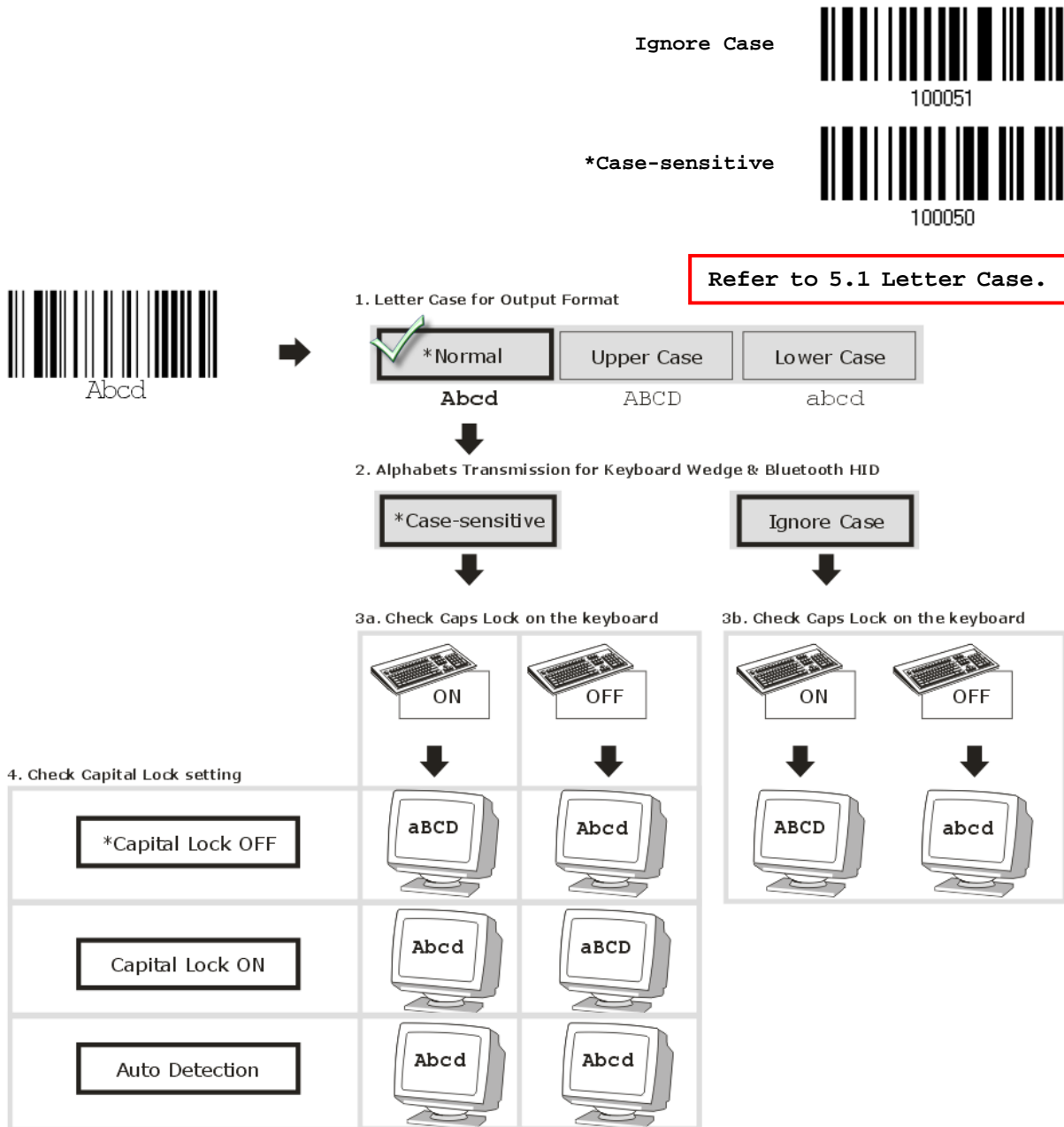

### Digits Transmission

By default, the alphanumeric keypad is used for transmitting digits. Select "Numeric Keypad" if you wish to use the keys on the numeric keypad.

Numeric Key



\*Alphanumeric Key

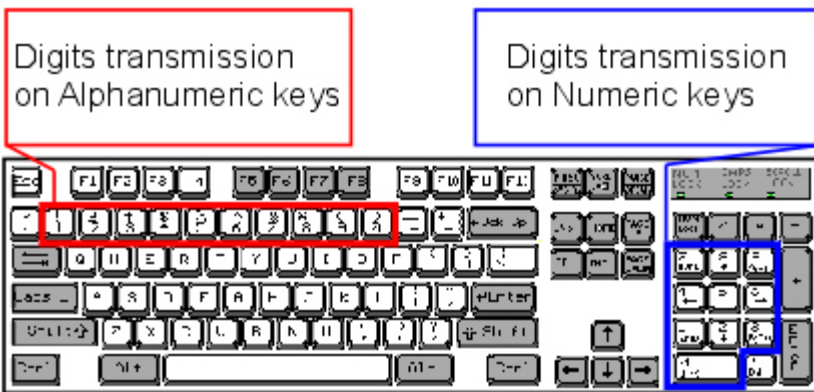

---

Note: If you select "Numeric Keypad", the Num Lock status of the physical keyboard should be "ON".

---



### 2.4.3 INTER-FUNCTION DELAY

By default, the inter-function delay is set to zero. Specify a value, ranging from 0 to 254, to match the computer response time of the keyboard interface. Such delay time is inserted between every function code (0x01 ~ 0x1F) being transmitted. The longer the delay time is, the slower the transmission speed will be.

Value	Delay Time	Value	Delay Time
0	Disable	195 ~ 204	200 millisecond
1 ~ 14	10 millisecond	205 ~ 214	210 millisecond
15 ~ 24	20 millisecond	215 ~ 224	220 millisecond
25 ~ 34	30 millisecond	225 ~ 234	230 millisecond
35 ~ 44	40 millisecond	235 ~ 244	240 millisecond
45 ~ 54	50 millisecond	245 ~ 254	250 millisecond
...	...		

Inter-Function  
Delay... (\*0~254)



- 1) Read the barcode above to specify the inter-function delay.
- 2) Read the "[Decimal Value](#)" barcode on page 錯誤! 尚未定義書籤。 for the desired inter-function delay (millisecond).
- 3) Read the "Validate" barcode on the same page to complete this setting.

### 2.4.4 HID CHARACTER TRANSMIT MODE

By default, HID interface sends data to the host in batch. You may have the scanner read the "By Character" barcode to process data one character at a time.

\*Batch Processing



By Character



## 2.5 USB VIRTUAL COM VIA 3610

Connect 3610 to the USB port of PC, and then connect the scanner to 3610. You may run HyperTerminal.exe on your computer, and the scanned data will be transmitted to the computer.

Note: If you are using USB Virtual COM for the first time, you must install its driver from the CD-ROM. Driver version 5.3 or later is required. Please remove older versions!

### 2.5.1 ACTIVATE USB VIRTUAL COM

Activate 3610 USB  
Virtual COM



### 2.5.2 INTER-FUNCTION DELAY

By default, the inter-function delay is set to zero. Specify a value, ranging from 0 to 254, to match the computer response time of the keyboard interface. Such delay time is inserted between every function code (0x01 ~ 0x1F) being transmitted. The longer the delay time is, the slower the transmission speed will be.

Value	Delay Time	Value	Delay Time
0	Disable	195 ~ 204	200 millisecond
1 ~ 14	10 millisecond	205 ~ 214	210 millisecond
15 ~ 24	20 millisecond	215 ~ 224	220 millisecond
25 ~ 34	30 millisecond	225 ~ 234	230 millisecond
35 ~ 44	40 millisecond	235 ~ 244	240 millisecond
45 ~ 54	50 millisecond	245 ~ 254	250 millisecond
...	...		

Inter-Function  
Delay... (\*0~254)



- 1) Read the barcode above to specify the inter-function delay.
- 2) Read the "[Decimal Value](#)" barcode on page 錯誤! 尙未定義書籤。 for the desired inter-function delay (millisecond).
- 3) Read the "Validate" barcode on the same page to complete this setting.



### 2.5.3 ACK/NAK TIMEOUT

By default, the scanner sends data to the host without waiting for an ACK/NAK response before sending more data. Specify a value, ranging from 1 to 99 in units of 0.1 second. If no response within the specified period of time, the scanner will attempt to send the same data two more times. If all three attempts fail without any notification, data loss will occur.

ACK/NAK Time-out  
after ... (\*0~99)



100013

- 1) Read the barcode above to specify the time interval for the scanner to send data and wait for a response from the host.
- 2) Read the "[Decimal Value](#)" barcode on page 錯誤! 尚未定義書籤。 . For example, read "1" and "0" for the scanner to automatically shut down after being idle for 1 second.
- 3) Read the "Validate" barcode on the same page to complete this setting.

#### ACK/NAK Error Beep

Enable Error Beep



100015

\*Disable Error Beep



100014

Note: We suggest enabling the error beep so that you will be notified of such data loss and have the scanner re-read data.





## SETTING UP A WPAN CONNECTION

The scanner can be configured to send data to a host computer wirelessly via the 3610 dongle, or to a notebook computer or PDA with *Bluetooth*<sup>®</sup> wireless technology. Upon powering up, the scanner will be ready for establishing a WPAN connection.

To establish a connection via 3610 after reading "Set Connection" and "Serial No." labels ...

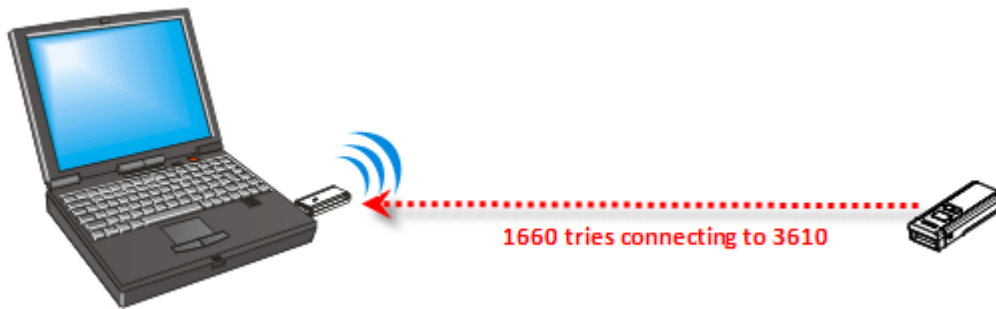

Interface Option	Reference
USB HID	<a href="#">2.4 USB HID via 3610</a>
USB Virtual COM	<a href="#">2.5 USB Virtual COM via 3610</a>

To establish a connection via *Bluetooth*<sup>®</sup> dongle after pairing ...



Interface Option	Reference
BT HID	<a href="#">2.1 BT HID</a>
BT SPP	<a href="#">2.2 BT SPP Slave</a> , <a href="#">2.3 BT SPP Master</a>

### IN THIS CHAPTER

3.1 Connecting via 3610.....	80
3.2 Connecting via <i>Bluetooth</i> <sup>®</sup> Dongle.....	83



## 3.1 CONNECTING VIA 3610

By default, the interface of 3610 is set to “USB HID”. Connect 3610 to the USB port of PC, and then connect the scanner to 3610. You can have up to seven scanners connected to one computer at the same time.

---

Note: If you are using USB Virtual COM for the first time, you must install its driver from the CD-ROM. Driver version 5.3 or later is required. Please remove older versions!

---

### 3.1.1 CONNECT TO 3610

You can connect any scanner to 3610 by having the scanner read the two labels at the back of 3610. The scanner will respond with one beep upon reading each of the labels.

- ▶ “Set Connection” label
- ▶ “Serial Number” label

After reading these labels, the scanner will stay active for a specified period of time (2 minutes by default) trying to connect to the 3610 dongle while its LED is flashing blue (On/Off ratio 0.5 s: 0.5 s). Once connected, the scanner will respond with three beeps (tone ascending from low to high), and the LED becomes flashing blue (On/Off ratio 0.02 s: 3 s). When getting out of range, the scanner will respond with three short beeps (tone descending from high to low).

Read the “Set Connection” label first, and then the “Serial Number” label. If the “Set Connection” label on 3610 is illegible, try this one —

Set Connection



88686471166254

---

Note: The 3610 settings will overwrite the interface-related settings on the scanners that are currently connected to 3610.

---





### 3.1.2 CHANGE INTERFACE

If you want to change the interface 3610, use one of the connected scanners to configure the interface-related settings and it will pass the new settings to 3610, which will then initialize and pass the settings to any other connected scanners.

- 1) Have the scanners read the "Set Connection" and "Serial Number" labels at the back of 3610.
- 2) Within two minutes, connect 3610 to the USB port of PC. For USB Virtual COM, you may need to install its driver first!
- 3) The scanners will connect to your computer via 3610.
- 4) Have one scanner read the "Enter Setup" barcode to enter the configuration mode.
- 5) Have the scanner read the desired interface barcode and configure its related settings –
  - ▶ "Activate USB HID & Select Keyboard Type"
  - ▶ "Activate USB Virtual COM"
- 6) Have the scanner read the "Update" barcode to exit the configuration mode.
- 7) After the scanner resumes connection with 3610, it will pass the interface-related settings to 3610.
- 8) Upon receipt of the new settings, 3610 will initialize itself.
- 9) Updated with new settings, 3610 will pass the settings to other connected scanners.

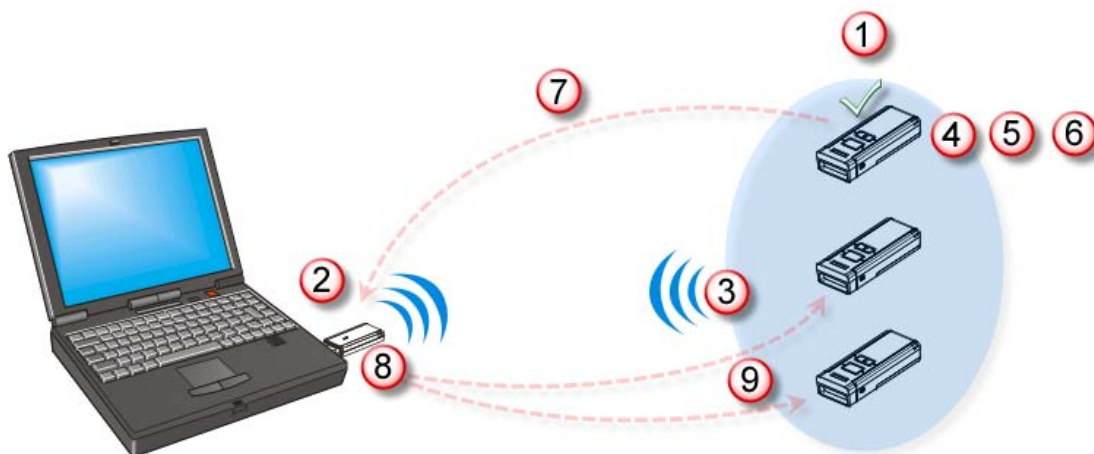

### 3.1.3 CONFIGURE RELATED SETTINGS

#### Sniff Mode (Power-saving)

By default, this feature is enabled, meaning the scanner will listen to the wireless network at a reduced rate.

**\*Enable**



100153

**Disable**



100152



## 3.2 CONNECTING VIA *BLUETOOTH*<sup>®</sup> DONGLE

### 3.2.1 CHANGE INTERFACE

Below is the procedure to configure the scanner before establishing a WPAN connection via *Bluetooth*<sup>®</sup> dongle.

- 1) Have the scanner read the "Enter Setup" barcode to enter the configuration mode.
- 2) Have the scanner read the desired interface barcode –
  - ▶ "Activate BT HID & Select Keyboard Type"
  - ▶ "Activate BT SPP Slave Mode"
  - ▶ "Activate BT SPP Master Mode"
- 3) Have the scanner read the barcodes related to WPAN settings, such as Device Name Broadcasting, Authentication & PIN Code, etc.
- 4) Have the scanner read the "Update" barcode to exit the configuration mode.
- 5) The scanner will stay active for a specified period of time (2 minutes by default) waiting for a connection request from the host (SPP Slave Mode) or trying to connect to the host (HID or SPP Master Mode). Its CPU is running at full speed, and the LED is flashing blue (On/Off ratio 0.5 s: 0.5 s).

Once connected, when getting out of range, the scanner will respond with three short beeps (tone descending from high to low).



### 3.2.2 CONFIGURE RELATED SETTINGS

#### Sniff Mode (Power-saving)

By default, this feature is enabled, meaning the scanner will listen to the wireless network at a reduced rate.

**\*Enable**



100153

**Disable**



100152

Note: When connecting more than two scanners to a notebook computer or PDA with *Bluetooth*<sup>®</sup> wireless technology, we suggest that you disable the power-saving setting for a more reliable connection.

#### Device Name Broadcasting

The scanner can be configured to hide itself from other devices equipped with *Bluetooth*<sup>®</sup> wireless technology. Simply disable the device name broadcasting setting so that it won't be discovered by any other computer or PDA. However, broadcasting must be enabled for establishing an initial connection with the scanner. For example, you can disable device name broadcasting after successfully connecting the scanner to WorkStation1. Such connection will be maintained automatically unless the scanner is removed from the paired device list (called unpairing) by WorkStation1 or any changes made to authentication and the PIN code. If you want WorkStation2 to connect to the scanner, you will have to enable device name broadcasting first.

**\*Enable**



100157

**Disable**



100156

Note: By default, device name broadcasting is enabled (which is required for initial connection).



## Authentication

When any changes are made to authentication and PIN code on the scanner side, you will have to remove the scanner from the paired device list (called unpairing) and go through the whole process to re-establish the connection.

The scanner allows up to 16 characters for a PIN code and provides two options for authentication:

### Enable Authentication with Preset PIN

Have the scanner read the “Use preset PIN” barcode, and change the preset PIN if necessary. This means you will have to enter exactly the same string for your computer or PDA to connect to the scanner. If the PIN or passkey is incorrect, any connection attempt will be turned down by the scanner. See step 8 in [3.2.3 Connect to Dongle](#).

1. Read the “Use preset PIN” barcode to enable authentication with a preset PIN.



2. Read one of the barcodes to specify the PIN code, in decimal or hexadecimal.

By default, the PIN code is set to “0000”. Maximum 16 characters are allowed.



3. Read the “[Decimal Value](#)” barcode on page [錯誤! 尚未定義書籤。](#) or the “[Hexadecimal Value](#)” barcode on page [錯誤! 尚未定義書籤。](#) for the desired digits or character string.

Read the “Clear PIN Code” barcode first if you need to re-input the PIN code.



4. Read the “Validate” barcode to complete this setting.

### Enable Authentication with Random PIN or No Authentication

By default, it is set to “No PIN or use random PIN”, which depends on the setting of the target device. (No PIN = No authentication.)



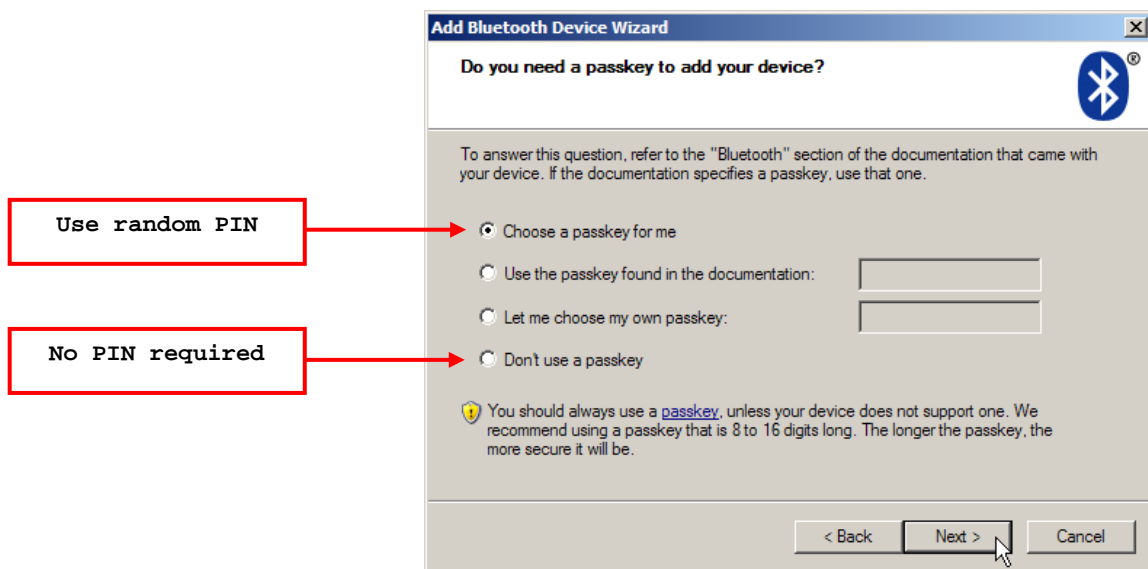

---

Note: When using BT HID, some device driver may not support pre-defined PIN code for authentication. In this case, make sure you have the scanner set to "No PIN or use random PIN" before pairing. While pairing, the host PIN code will be displayed on the computer screen. Have the scanner read the setup barcode "Enter PIN Code in Decimal" or "Enter PIN Code in Hexadecimal" to input the matching PIN code. Refer to [Disable Authentication or Use Random PIN](#).

---



### 3.2.3 CONNECT TO DONGLE

The procedure goes through associating devices for establishing a WPAN connection, which is pretty much the same except for the software you are using. If your computer is running Microsoft® Windows® XP Service Pack 3 (SP3) or Windows Vista® Service Pack 1 (SP1), you can use the software support that Windows® includes, or you can use the driver that the device manufacturer provides. Now, let's try using the software support that Windows® XP Service Pack 2 includes.

#### BT HID Procedure

By default, BT HID is activated on the scanner, and the keyboard type is set to PCAT (US). When BT HID is re-activated, you will have to select a keyboard type to complete this setting.

The procedure is the same as for BT SPP. Refer to steps 1~11 below.

#### BT SPP Slave Procedure

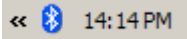
1. Turn on the *Bluetooth*® function on your computer, running Windows XP SP2.
2. Double-click the *Bluetooth*® icon from the lower right of the taskbar.  Alternatively, you may go to **Control Panel** > **Bluetooth Devices**.
3. Click [Add] to search devices nearby.

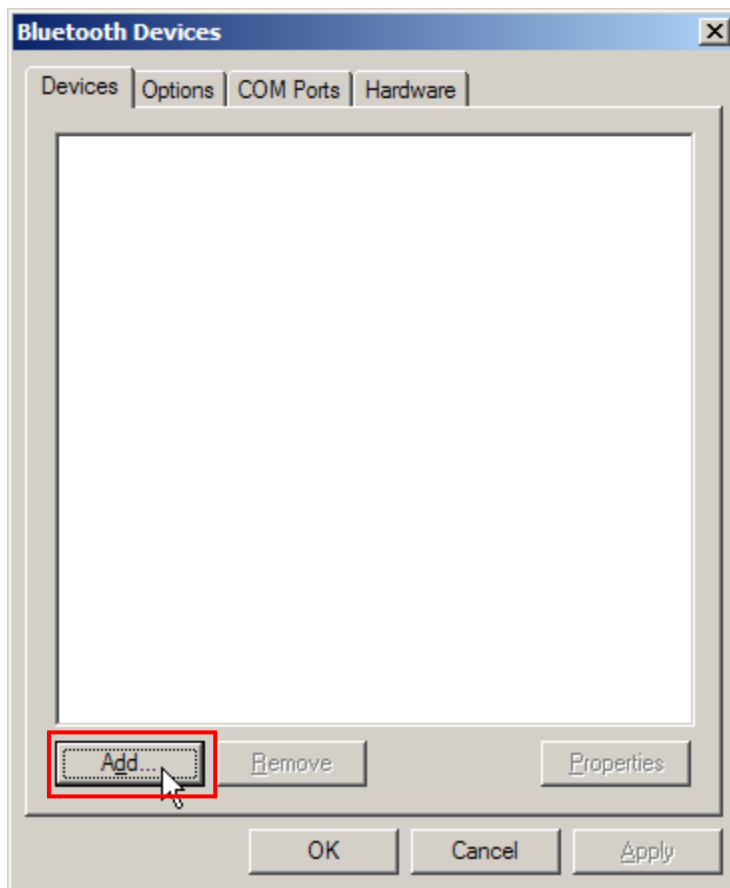

4. Turn on the scanner with correct WPAN settings, such as select BT SPP or BT HID, broadcasting enabled, authentication enabled, and PIN code specified, etc. Select the check box of [My device is set up and ready to be found] on your computer.
5. Click [Next].



6. Wait for a few seconds for the Wizard to search available devices nearby.  
The scanner will appear with its "serial number" as the device name. You may double-check the "Serial Number" label on the scanner to ensure connecting with the correct scanner. Select the target scanner. If the target scanner does not appear on the list, click [Search Again] to refresh the list. The scanner might enter Suspend Mode now, and you can press the trigger to have it active again (=discoverable). It will then stay active for a specified period of time (2 minutes by default) and wait for PC to establish a connection.

7. Click [Next].





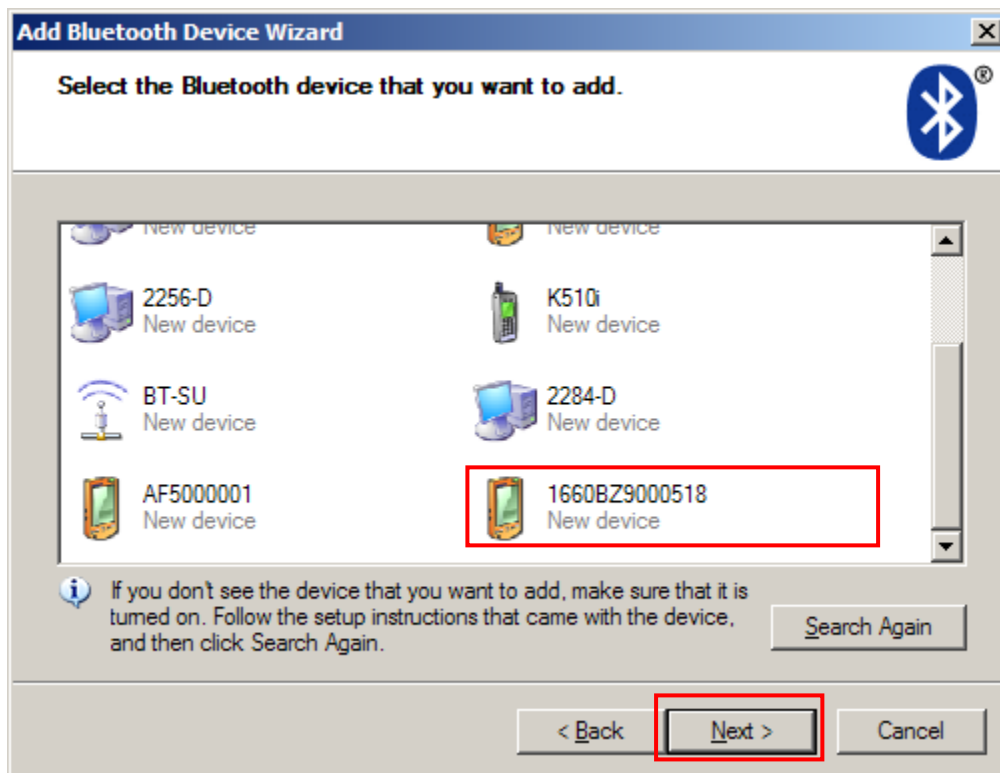

8. Enter the passkey for authentication, which must be exactly the same as configured for the scanner.

9. Click [Next]. Wait for a few seconds for Windows to exchange passkeys.



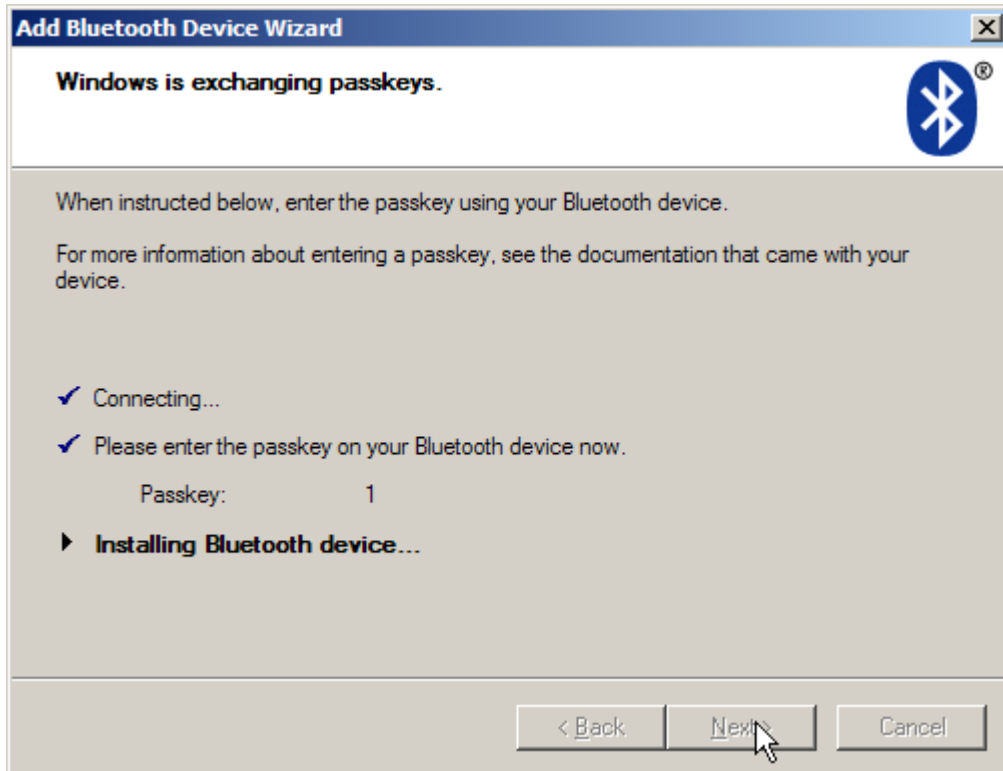
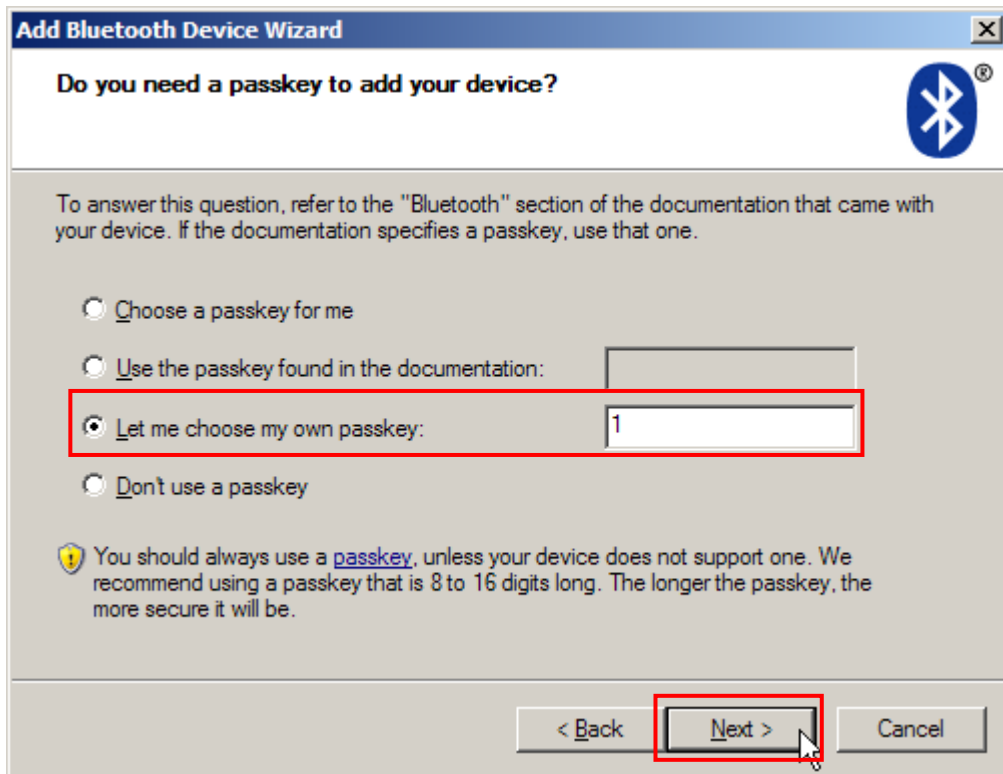

Note: When Bluetooth security is enabled without providing a pre-set PIN code, dynamic input of PIN code is supported.

10. Click [Finish].

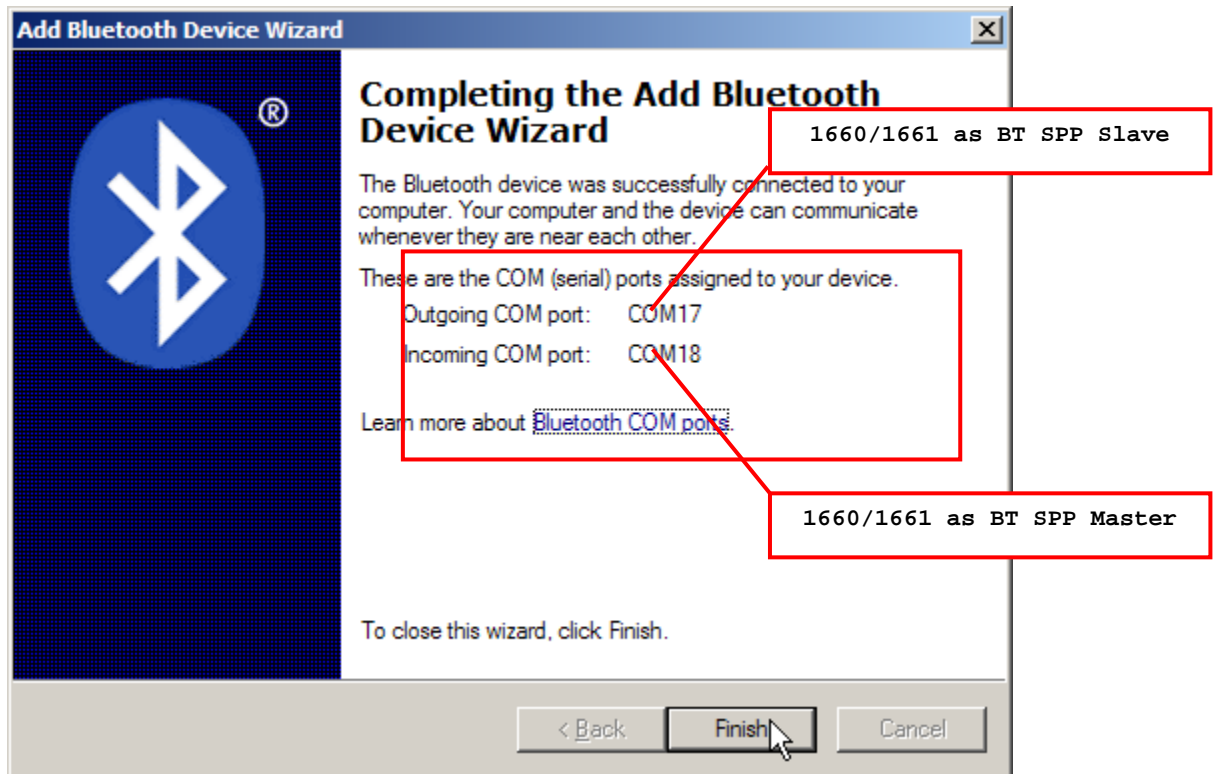

11. Now the target scanner will be listed as shown below.

You can have up to seven scanners connected to one computer at the same time.

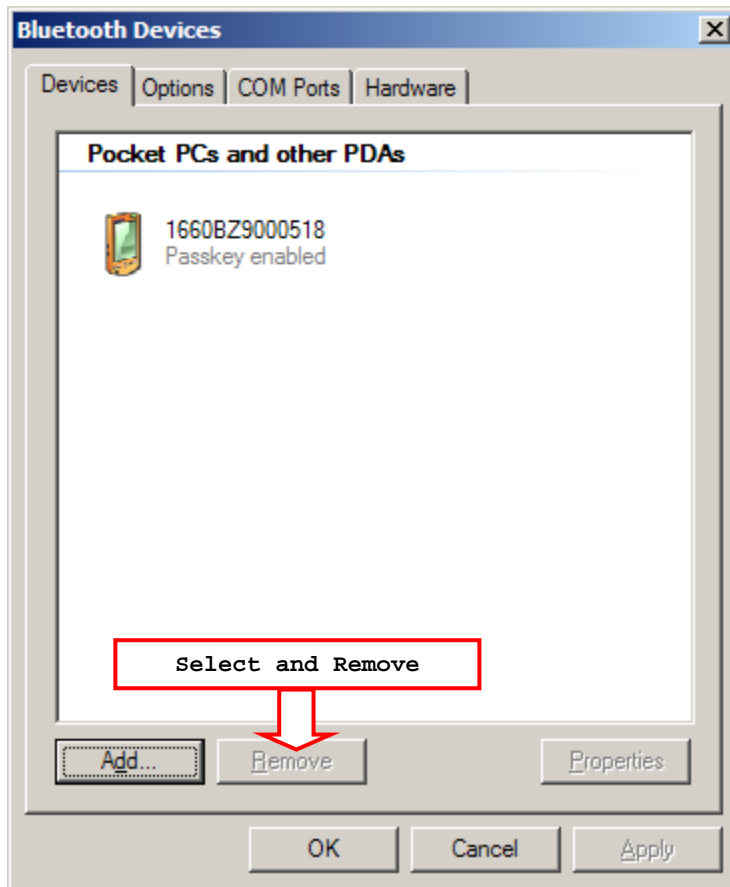

---

Note: When any changes are made to authentication and PIN code on the scanner side, or you want to change to use BT HID, it is suggested that you remove the scanner from the paired device list (called unpairing) and go through the whole process to re-establish the connection.

---

12. Run the desired application on your computer, such as HyperTerminal.exe if using BT SPP or Notepad.exe if using BT HID.

The status of the scanner listed on the device list will be updated to "Connected", indicating the WPAN connection is established successfully via the outgoing COM port if using BT SPP.

---

Note: Even though the scanner is connected to the host with authentication disabled (= no PIN code required), the host may still request a PIN code while the application is opening COM port. Dynamic input of PIN code is supported so that you may input a matching PIN code on the scanner. Refer to [Disable Authentication or Use Random PIN](#).

---



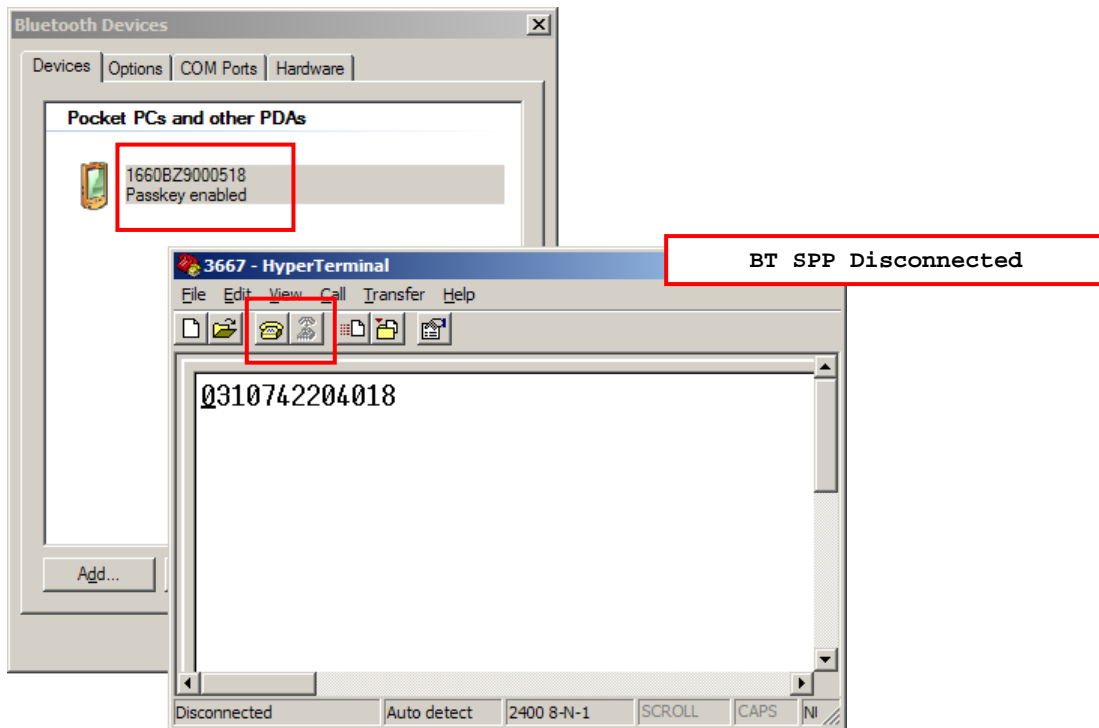
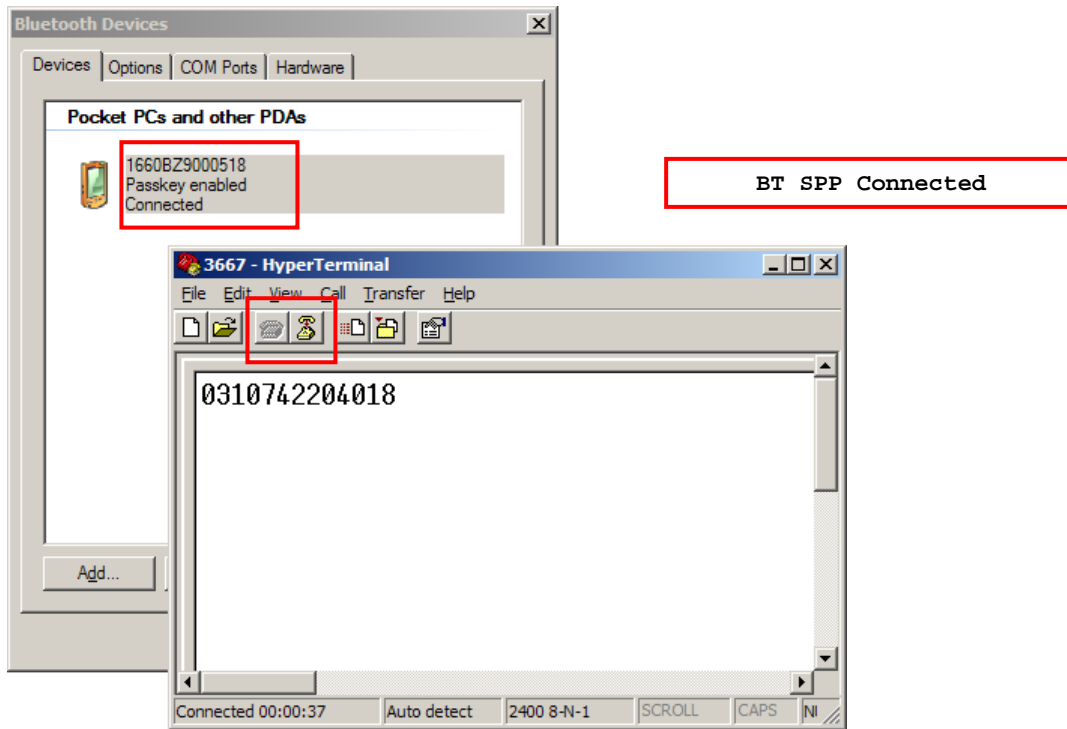



# SPECIFICATIONS

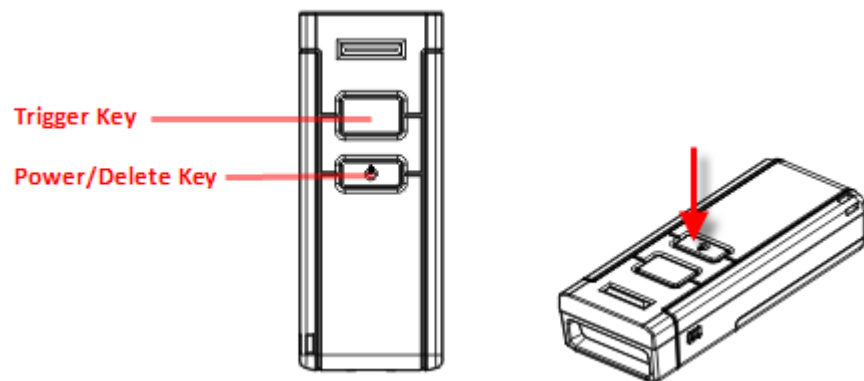

Optical Characteristics	1660	1661
Scan Engine	Non-contact type	
Optical Sensor	CCD, 2500 pixels	
Light Source	Visible red LED	
<b>RF Characteristics</b>		
WPAN Module	Wireless PAN BT Class 3 compliance	
Coverage (line-of-sight)	10 meters with 3610	
Interface Supported	<ul style="list-style-type: none"> <li>▶ Serial Port Profile (BT SPP)</li> <li>▶ Human Interface Device Profile (BT HID)</li> <li>▶ 3610</li> </ul>	
<b>Physical Characteristics</b>		
Memory	<ul style="list-style-type: none"> <li>▶ 1 KB for transmit buffer</li> <li>▶ 256 KB flash for memory mode</li> </ul>	
Switch	Push-button switch for [Trigger] key, plus [Power/Delete] key	
Indication	Triple-color LED (Red/Green/Blue) and beeper	
Dimensions	95 mm (L) 35 mm (W) 20 mm (H)	
Weight	Approx. 50 g	



<b>Electrical Characteristics</b>		
Battery	2 AAA Alkaline batteries	Rechargeable Li-ion battery — 3.7 V, 850 mAh
<b>Power Adapter</b>		
Input	---	AC 100~240 V (50/60 Hz)
Output	---	DC 5V ± 5% (via battery charger)
<b>Environmental Characteristics</b>		
Temperature	Operating	0 °C to 50 °C
	Storage	-20 °C to 60 °C
Humidity (Non-condensing)	Operating	10% to 90%
	Storage	5% to 95%
<b>Resistance</b>		
Electrostatic Discharge	± 15 kV air discharge, ± 8 kV contact discharge	
<b>Programming Support</b>		
Configuration via Setup Barcodes	Use setup barcodes or host serial commands.	
Software	Windows®-based ScanMaster	
Firmware upgradeable	Download firmware updates via the download utility.	
<b>Accessories (√ means “supported”)</b>		
BT Transponder (3610)	√	√
Rechargeable Li-ion Battery		√
Direct USB Cable		√





---

Update



Abort

