

***DENSO***

# BHT-1200 Series

## Operator's Guide

### 2D Code Handy Terminal BHT-1281QULWB-CE

Thank you for using the DENSO WAVE 2D Code Handy Terminal.  
Please read this manual thoroughly prior to operation to ensure full use of the product's functionality, and store safely in a convenient location for quick reference even after reading.  
This manual contains only the basic details required for operation.  
Please refer to the User's Manual for further details on general operation.  
The User's Manual can be downloaded free of charge from the DENSO WAVE Web site (QBdirect).  
<http://www.qbdirect.net/>

Some of the pixels on the LCD touch screen may not illuminate or stay permanently illuminated. Furthermore, there may also be inconsistencies in color and brightness. None of these aspects represent an LCD defect.

A thin Newton's ring (rainbow-like patterns) may appear on the touch panel. This does not necessarily indicate a problem with the touch panel.

## About This Manual

- Due to changes and improvements, the content of this manual may be subject to change without prior notice.
- The reproduction or duplication of the whole or part of this manual is strictly prohibited without prior consent.
- Please contact DENSO WAVE if this manual is lost.
- Every attempt has been made to ensure that the content of this manual is thorough and up to date, however, we kindly ask you to report any questionable descriptions, mistakes or omissions, if any, to DENSO WAVE.

## Liability Limitations

- DENSO WAVE INCORPORATED ("DENSO WAVE") does not assume any product liability (including damages for lost profits, interruption of operations, or the loss of business-related information) arising out of, or in connection with, the use of, or inability to use the BHT system software or related manuals.
- DENSO WAVE takes reasonable precautions to ensure its products do not infringe upon any patents or other intellectual property rights of other(s), however, DENSO WAVE cannot be responsible for any patent or other intellectual property right infringement(s) or violation(s) arising from any of the following.
  - (1) The use of DENSO WAVE's products in connection or in combination with other components, products, devices, data processing systems or software not supplied by DENSO WAVE.
  - (2) The use of DENSO WAVE's products in a manner for which they were not intended nor designed.
  - (3) The modification of DENSO WAVE's products by parties other than DENSO WAVE.
- If it is judged by DENSO WAVE that malfunction of the product is due to the product having been dropped or subjected to impact, repairs will be made at a reasonable charge even within the warranty period.

## Customer Registration

To allow us to provide our customers with comprehensive service and support, we request that all customers complete a Member Registration Form. Registered members will be offered the following privileges.

- The latest upgrade information
- Free exhibition and event information for new products
- Free web-information service "QBdirect."

### QBdirect Service Contents

Information searching service (FAQ)	Offers detailed information on each product.
Download service	The latest OS systems for the BHT Series, repair software, and sample programs can be downloaded.
E-mail inquiries	Product related queries can be sent in by e-mail.

\* Please note that these privileges may be subject to change without prior notice.

**How to Register :** Access the URL below and follow the instructions provided.

<http://www.qbdirect.net/>

# Usage Precautions

## Usage environment restrictions

- **Do not use the BHT where it may be exposed to fire, high temperatures, or direct sunlight.**  
(Failure to observe this may result in damage, overheating, explosion, or fire.)
  - \* When the BHT is stored in a high-temperature, high-humidity environment of 50 to 60°C, leave to sit in a location at room temperature and normal humidity for at least 1 day prior to use.  
Failure to observe this may cause a reading failure or damage the BHT.
- **Do not use the BHT in places with extreme temperature variations.**  
(Failure to observe this may lead to BHT malfunction due to condensation.)
  - \* Leave the BHT for a short while prior to use when moved from a cold to a warm environment.
- **Do not use the BHT in places where it may be exposed to strong impact or significant static electricity.**
- **Do not use the BHT in places where a strong magnetic field is generated.**  
(Failure to observe this may lead to BHT malfunction due to magnetic force.)

## Keep the BHT away from electromagnetic waves and metallic objects.

Wireless communication may not be possible in the following locations.

- In the vicinity of other RFID devices  
(Failure to observe this may lead to BHT malfunction.)
- **In the vicinity of the following devices operating on a 2.4 GHz waveband**  
(Communication may not be possible due to electromagnetic interference.)
  - Industrial, scientific, or medical equipment such as microwave ovens
  - Wireless LAN devices
  - Logistics systems in places such as plants or warehouses
  - Wireless devices such as personal or amateur radio stations
- **In the vicinity of household appliances emitting electromagnetic waves such as computers or televisions**  
(Communication may not be possible due to electromagnetic noise.)
- **In the vicinity of metallic objects, in places with high levels of metallic dust, or in places surrounded by metal walls**  
(Communication may not be possible due to the presence of metallic objects.)

# SAFETY PRECAUTIONS

Be sure to observe all these safety precautions.

## Meaning of Symbols



**WARNING**

Alerts you to those conditions which could cause serious bodily injury or death if the instructions are not followed correctly.



**CAUTION**

Alerts you to those conditions which could cause minor bodily injury or substantial property damage if the instructions are not followed correctly.



**WARNING**

## Handling the battery

Incorrect handling of the battery could cause the batteries to generate heat or smoke, or to rupture or burn. This is **DANGEROUS**. Be sure to observe the following.

- Never disassemble or modify the battery.
- Never connect the positive and negative terminals of the battery with a wire or other metallic materials.
- Do not carry or store the battery together with ballpoint pens, necklaces, coins, hairpins, or anything else metallic.
- Never burn or heat the battery.
- Do not use or leave the battery anywhere there is excessively high temperature (60°C or higher), such as near fire or stoves.
- Do not put the battery into water of any kind or moisten it.
- Never charge the battery near a fire or anywhere exposed to direct sunlight. Failure to do so could activate the protector due to high temperature and thus prevent the battery from being full charged. Or it may break the protector, resulting in the battery to overheat, blowout, or combustion.
- Never charge the battery where any inflammable gases may be emitted. Doing so could cause fire.
- Do not stick a needle into the battery, hammer at it, or tread on it.
- Do not let the battery undergo any shock or impact or throw it at something hard.
- Do not use batteries that are deformed, scratched or cracked remarkably.
- Solder nothing to the battery directly.
- The battery is exclusively for the BHT. Do not use the battery for purposes other than charging the BHT.
- If battery fluid leaks from the battery and it gets into your eyes, rinse them with clean water thoroughly without rubbing and consult a doctor as soon as possible. Otherwise, you may damage your eyes.
- If the battery does not finish recharging within the specified time, stop recharging.
- Never place the battery in a microwave oven or high-pressure container.
- If abnormal odor, heat, discoloration, deformation or any other abnormal conditions are noticed when the battery is in use, being charged, or is in storage, remove it from the BHT or Cradle and avoid further use.
- Only use the Cradle for charging the battery.
- The battery may be warm immediately after charging or use.

## To System Designers:

When introducing BHT in those systems that could affect human lives (e.g., medicines management system), develop applications carefully through redundancy and safety design which avoids the feasibility of affecting human lives even if a data error occurs.

## Handling the BHT

Incorrect handling of the BHT could cause electric shock, impaired vision, skin problems, injury, burns and generation of heat and smoke from the BHT. Be sure to observe the following to use the device correctly.

- Never put the BHT into a microwave oven or high-pressure container.  
Doing so could cause the BHT to break, generate heat, rupture or burn.
- Never put the BHT in places where there are excessively high temperatures, such as inside closed-up automobiles, or in places exposed to direct sunlight.  
Doing so could affect the housing or parts, resulting in a fire.
- Avoid using the BHT in extremely humid or dusty areas, or where there are drastic temperature changes.  
Moisture or dust will get into the BHT, resulting in malfunction, fire or electrical shock.
- If smoke, abnormal odors or noises come from the BHT, immediately turn off the power, pull out the battery, and contact your nearest dealer.  
Failure to do so could cause smoke or fire.
- If you drop the BHT so as to damage its housing, immediately turn off the power, pull out the battery.  
Failure to do so could cause smoke or fire.
- Do not use batteries or power sources other than the specified ones.  
Doing so could generate heat or cause malfunction.
- Never disassemble or modify the BHT; doing so could result in an accident such as break or fire.
- Do not insert foreign materials in the BHT.
- If foreign material or water gets into the BHT, immediately turn off the power, pull out the battery, and contact your nearest dealer.  
Failure to do so could cause smoke or fire.
- If the LCD breaks and the liquid leaks from the LCD by mistake, do not swallow, inhale or touch it.
- Do not place the RF tag read antenna of the BHT within 22 cm from the mounting location of an embedded medical device (a cardiac pacemaker, etc.). For more information, see the web site of the Ministry of Internal Affairs and Communications.

The 2D Code Handy Terminal uses a laser light for indicating the scanning range. The intensity of the laser light is too low to inflict bodily injury. However, do not stare into beam.

You must observe the following precautions when handling the BHT equipped with laser light.

1) Never stare into the reading window.

2) Never point the reading window at someone's eye.

The 2D Code Handy Terminal complies with IEC 60825-1 Ed. 2: 2007.

In accordance with Clause 5 and 6, IEC 60825-1, the following information is provided to the user:

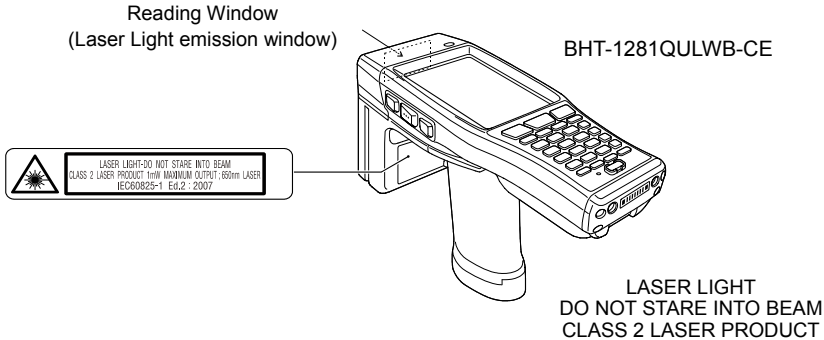

Caution – Use of controls or adjustments or performance of procedures other than those specified herein may result in hazardous laser light exposure.

## CAUTION

### Handling the BHT

- Incorrect handling of the BHT could cause generation of heat and smoke from the BHT, and malfunction. Be sure to observe the following to use the device correctly.
- When using the hand strap or neck strap, exercise due care to avoid getting them caught in other objects or entangled in rotating machinery.  
Failure to do so could result in accident or injury.
- Do not use the BHT in the vicinity of wireless devices such as personal radios and ham radios.  
This could cause malfunction of the BHT.
- Do not place magnetic cards or the like near the BHT speaker.  
Doing so may result in the loss of magnetic data from cash cards, credit cards, etc.
- Do not place your ear near the speaker/beeper when tones are being emitted.  
Doing so may result in hearing loss.
- Do not apply excessive force when inserting or removing the battery.  
Doing so will result in damage.
- In environments where static electricity can build into significant charges (e.g., if you wipe off the plastic plate with a dry cloth), do not operate the BHT.  
Doing so will result in malfunction or machine failure.
- Do not drop the BHT on the floor or apply strong shock to it.  
Doing so could cause malfunction of the BHT.
- Do not use batteries other than the specified ones.
- Make sure that the BHT and the battery are dry before putting it in the Cradle.  
Failure to do so could result in fire or electrical shock.

# Wireless Equipment

## ● Precautions relating to the frequency used by this device

In addition to industrial, scientific, and medical equipment such as microwave ovens, static wireless stations (permit required) used for mobile identification in places such as plant manufacturing lines and specified low-power wireless stations (no permit required) operate on the same frequency band as this device.

1. Before using this device, ensure that no static wireless stations or specified low-power wireless stations for mobile identification are being used in the vicinity.
2. In the event of instances of electromagnetic interference from this device to a static wireless station being used for mobile identification, either promptly alter the usage frequency, or halt the electromagnetic discharge
3. If other problems arise due to reasons such as electromagnetic interference from this device to a specified low-power wireless station being used for mobile identification, please contact DENSO WAVE through QBdirect.

## ● Requests to system designers

- Communication may not be possible depending on the environment in which the device is being used. Ensure that problem-free communication is possible prior to use.
- Use a program capable of retransmitting data if communication fails.
- If the BHT is introduced into an environment in which a device using 2.4 GHz waveband electromagnetic waves is operating, or if another device using 2.4 GHz waveband electromagnetic waves is introduced following introduction of the system, run all devices and ensure that communication with the BHT is possible prior to use.
- Check communication once again prior to use if any changes are made to the usage environment (addition of household appliances, movement or addition of shelves, equipment and so on) following introduction of the system.

# Components and Functions

BHT-1281QULWB-CE

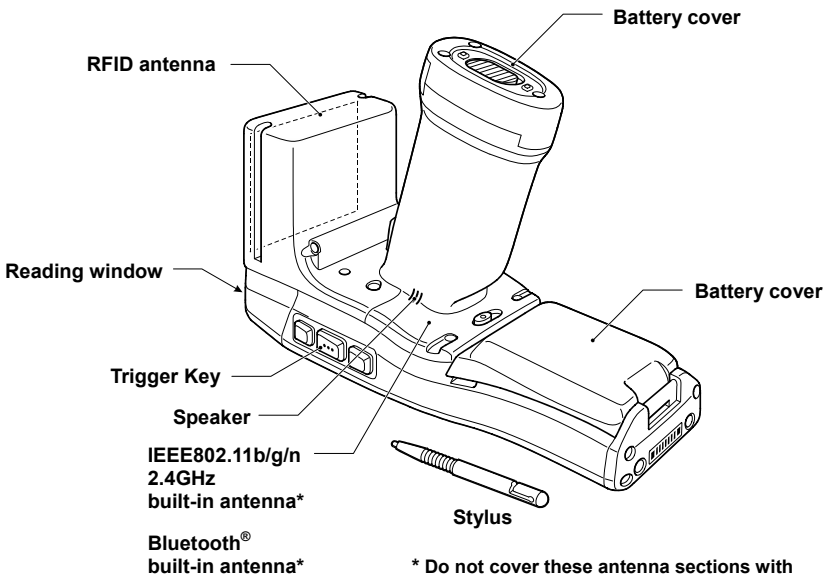
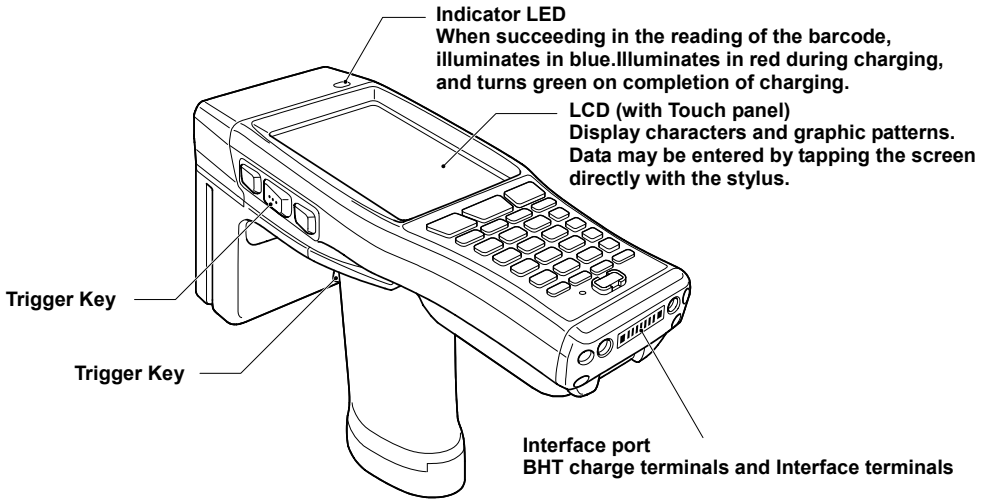

\* Do not cover these antenna sections with metal-evaporated tape or by hand. Doing so may result in communication failures.









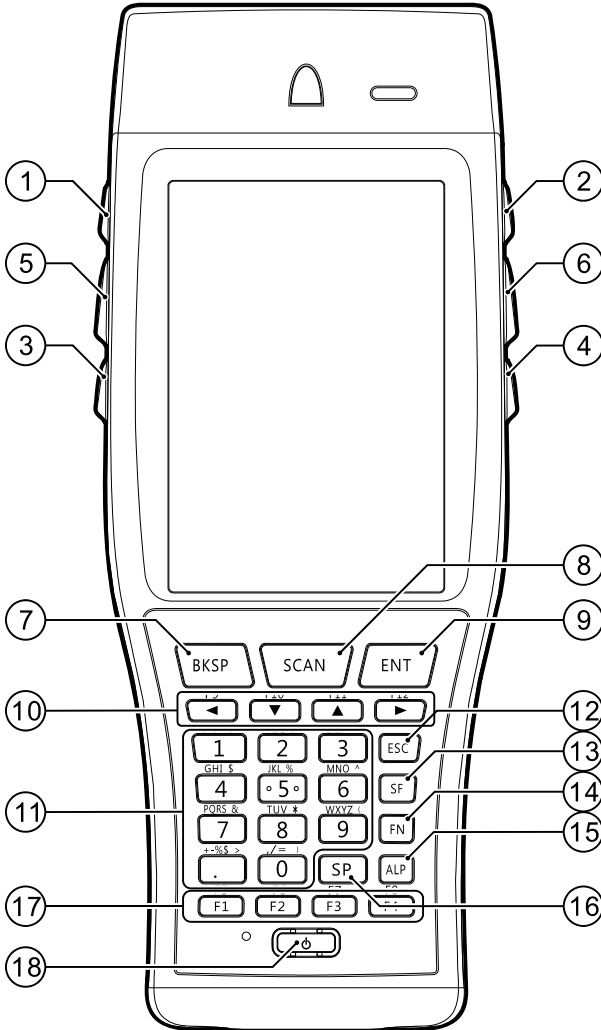







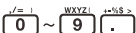

# Key pad

The BHT key functions can be set at user programs.

The diagram below shows an example of settings for each key function.



No.	Key	Name	Function and Description
①		Tab key	Used to enter a tab character.
②		M1, M2, M3 magic keys	<ul style="list-style-type: none"> <li>• The SF and ENT key functions can be assigned to these magic keys by making settings at the SYSTEM MENU.</li> <li>• Character strings can be assigned at user programs.</li> <li>* Refer to the User's Manual for details on how to operate the SYSTEM MENU.</li> </ul>
③			
④			
⑤ ⑥		Trigger keys	Press to scan codes and RF tags. (This key performs the same function as the Scan key.)
⑦		Backspace key	Moves back one character.
⑧		Scan key	Press to scan codes. (This key performs the same function as a Trigger key.)
⑨		Enter key	Press to finalize entered data or execute operations.
⑩		Cursor keys	Used to move the cursor and select menus.
⑪		Numerical keys	Used to enter data.
⑫		Escape key	Cancels the operation.
⑬		Shift key	Used in combination with other keys such as the numerical keys or power key for special input procedures.
⑭		Function mode key	Switches to Function mode.
⑮		Alphabetical mode key	Switches to alphabet entry mode.
⑯		Space key	Used to enter a space.
⑰		Function keys	Used to select functions.
⑱		Used to select functions.	Turns the BHT power ON and OFF.

# Input Method

## Using the Stylus

The BHT liquid crystal display (LCD) is a touch screen. Buttons, menus and so displayed on the screen can be selected using the stylus provided.

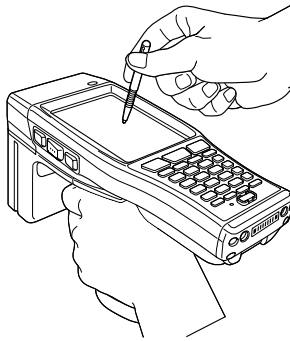

## Touch Screen Operation

Select the LCD touch screen buttons and menus and so on using the stylus provided.

Action	Description
Tap	This involves tapping the touch screen once. This function is the equivalent of a "click" with a mouse on a computer.
Double-tap	This involves tapping the touch screen twice in quick succession. This function is the equivalent of a "double-click" with a mouse on a computer.
Drag	This involves moving the stylus to an object while pressing the touch screen. This function is the equivalent of "dragging" with the mouse on a computer.
Hold	This involves tapping the touch screen for several seconds. This function is the equivalent of a "right-click" with the mouse on a computer.

- Always use the stylus provided to operate the touch screen. Never use fingernails or any pointed or hard objects, or apply strong pressure or impact to the touch screen. This may result in damage or a malfunction.
- If dirty, clean the touch screen and stylus tip prior to operation. Failure to observe this may result in scratches to the LCD screen or hinder smooth movement of the stylus.

# Proper Care of the BHT

Make sure to turn OFF the BHT before cleaning.

## ● Terminal dirt on the BHT and battery

Periodically wipe any dirt from the terminals of the BHT and battery with a cotton swab or similar soft object. The terminal should be treated with the utmost care so as not to be scratched or bent during a cleaning.

Never use organic solvents such as benzene or alcohol, as this may cause the coated surface to come off.

## ● Housing dirt

Wipe any dirt from the housing with a dry, soft cloth.

If excessively dirty, wipe with a soft cloth that has been soaked in soapy water (always use neutral detergent) and wrung out thoroughly.

Never use organic solvents such as benzene or alcohol, as this may cause the housing to be marred or paint to peel off.

## ● LCD screen dirt

Never rub or strike the LCD screen with anything hard, as this may result in scratches on the screen or breakage.

## ● Keypad dirt

When cleaning the keypad, do not scrub the surface too hard or pull on the keys, as this may break the keys.

## ● Code reading window dirt

Any dirt or dust adhering to the clear plate of the code reading window will adversely affect reading performance.

When using in dusty areas, perform periodic inspections to check whether any dust has accumulated on the clear plate of the code reading window, and if so, first blow the dust away with an airbrush, and then gently wipe the plate with a cotton swab or similar soft object.

If sand or hard particles have accumulated, rubbing the plate will result in scratches. Blow the particles away with an airbrush or wipe with a soft brush.

# Preparation

Follow the steps below to prepare the BHT for use.

## Step 1 Charging the Battery

Charge the battery.

## Step 2 Attaching the Stylus

Attach the stylus to prevent it from being lost.

## Step 3 Turning ON the Power

Preparation is now complete.

# Step 1 Charging

The battery is not charged when purchased and must therefore be charged prior to use.

The following Cradle can be used with the BHT.

Cradle: CU-1211, CU-1233

**It takes about 9 hours to charge the batteries (when both the batteries in the BHT main body and in the grip are mounted).**

- It takes about 4.5 hours when the battery is mounted only in the BHT main body.
- If a battery of which discharge amount is small is used, it takes less time to complete charging.

## ■Charging with the BHT

Place the BHT on the Cradle.\*

The LED illuminates in red and charging begins.

The BHT Indicator LED will change to green when charging is complete.

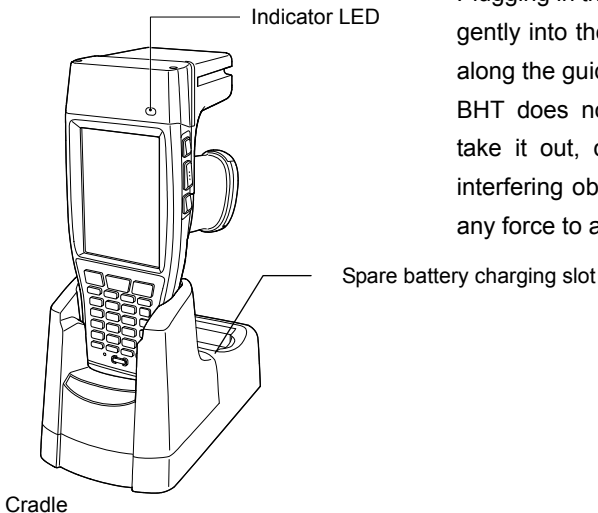

Plugging in the BHT into the CU: Slide the BHT gently into the CU. Make sure that it is placed along the guides and not tilted or twisted. If the BHT does not easily fit into the CU, please take it out, check the CU and the BHT for interfering obstacles and try again. Never use any force to attach the BHT into the CU.

\* Refer to "How to Replace the Battery" for how to insert the battery into the BHT main body.

## Caution when Installing the BHT to the CU

- Place the BHT on the CU carefully. Insert the BHT along the guides at the both sides of the CU.
- If the BHT does not fit into the guides smoothly, take it off and confirm that there is no foreign object which blocks the insertion. Then, insert the BHT again. Be sure not to install the BHT forcedly.

## When the red LED of the BHT is blinking, the conceivable causes are as follows.

### Take an appropriate action.

- The battery of the BHT main body is not mounted.  
Mount the battery of BHT main body.
- Contact of the electrodes is weak.  
Wipe the dirt, etc. on the electrodes and charge the battery again.
- An abnormal temperature of the battery is detected.  
Charge the battery in an appropriate temperature condition (0°C to 40°C).  
Move the BHT away from the areas where any heat generating materials exist in the vicinity, and the areas which are exposed to direct sunlight.  
When there is no heat generating material in the vicinity, stop charging the battery and replace it.
- Charging is not completed even after the designated charging time has passed.  
Charge the battery again in the spare battery charging slot of the CU.
- Failure or end of life of the battery  
Replace the battery with a new one.
- The battery has been left for a long time as there is no remaining battery charge.  
Charge the battery again in the spare battery charging slot of the CU.

- Remove the battery from the BHT main body or the Cradle and store at cool and dry place, when you don't use your BHT for an extended period of time.
- Check the condition of battery on the following points before you store it for a long time:
  - If the battery is full charged (a state right after charge is completed), and
  - If the remaining battery level is very low (there is not enough power left to activate the BHT).Long-term storage under these conditions may deteriorate the performance and life of the battery. You are recommended to ensure that the battery is at least at the  charge level required for long-term storage. In addition, even you don't use the battery for a long term, keep this power level by recharging once a year in order to maintain the battery performance.

## Step 2 Turning ON the Power

It is necessary to perform touch screen calibration and set the date and time when turning ON the BHT power for the first time. Press the **power** key to turn ON the BHT power. The calibration screen should then display.

If the calibration screen does not display, first perform a “full reset.” Refer to “Resetting and Full Resetting” for details of the full reset method.

Press the **power** key to turn ON the BHT power.

### Point

It may take time to display the screen after pressing the **power** key, but it is not malfunction of the BHT.

Therefore, do not keep pressing the power key more than needed or press it hard. Doing so may cause breakage or malfunction of the **power** key.

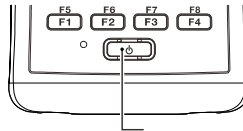

Power key

## Turning the Power OFF

Use one of the following three methods to turn OFF the BHT power.

### (1) Normal power OFF

Press the **power** key.

The BHT power turns OFF after the message right displays.

---

#### Point

Do not remove the battery while the message on the right is displayed.

Failure to observe this may result in data stored in the BHT being lost.

Shutdown  
in progress.  
Do not remove  
the battery.

### (2) Turning the power OFF after registry back-up

Hold down the **SF** key and press the **power** key.

The message right displays and registry back-up is commenced.

The power turns OFF automatically when the back-up is complete.

---

#### Point

Do not remove the battery while the message on the right is displayed.

Failure to observe this may result in data stored in the BHT being lost.

Now saving  
Registry.  
Do not remove  
the battery.

### (3) Auto power OFF

The power turns OFF automatically when the BHT is not used for the length of time set at the user program. The default time is set to 3 minutes when the BHT is shipped from the factory.

\* Refer to the User's Manual for further details of auto power OFF.

---

#### Point

Do not remove the battery while Auto power OFF is processing.

Failure to observe this may result in data stored in the BHT being lost.



# Reading/Writing RF Tags

Read and write RF tags in accordance with the procedures given below.

- 1 Press the power key  to turn the BHT power ON.

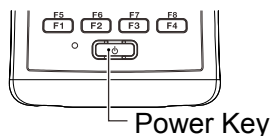

- 2 Select System Properties of BhtShell from the Desktop menu to activate RFID Menu. Select TAG READ and Start in RFID Menu in this order.

The red LED is turned ON.

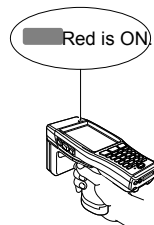
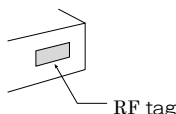

### Point

The continuous read mode is set at the time of factory shipment. You can change the read mode in the Read Mode menu.

- 3 Point the RF tag read antenna in the front side of the BHT toward the RF tag. You can confirm that the read/write operation is completed correctly with a buzzer sound or the indication on the LCD.

When the read/write operation is completed correctly, the blue LED is turned ON.

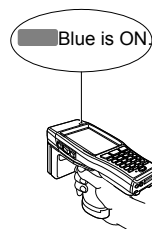
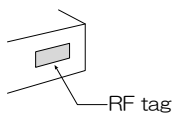

### Point

The method of confirming that the read/write operation is completed correctly may vary according to the application. Please read the operation manual of the application.

## When an RF tag cannot be read/written correctly

	Cause	Measure
Effect of metal	When an RF tag is placed on a metal plate, it may not be read/written.	Keep an RF tag 15 cm or more away from a metal plate.
Effect of electromagnetic noise	If you use the BHT near electric appliances which generate electromagnetic noise, including an inverter fluorescent light, microwave oven, and electromagnetic cooking device, etc., it may not be able to read and write RF tags.	Do not use the BHT near electric appliances which generate electromagnetic noise, including an inverter fluorescent light, microwave oven, and electromagnetic cooking device, etc.
Radio interference	If there is any other RFID device near the BHT, it may not be able to read/write RF tags.	Do not use the BHT near other RFID devices.

	If the BHT is used near other radio devices such as a personal radio station or an amateur radio station, it may not be able to read/write RF tags.	Do not use the BHT used near other radio devices such as a personal radio station or an amateur radio station.
Distance from an RF tag	If the distance from an RF tag is too close or too far, the BHT may not be able to read/write it. The writable distance may be shorter than the readable distance.	The readable and writable distances vary according to the RF tag type. Slowly move the BHT toward and away from an RF tag to find the readable and writable distances.

## Scanning codes

Follow the procedure below to scan codes.

- 1 Turn the BHT power ON.

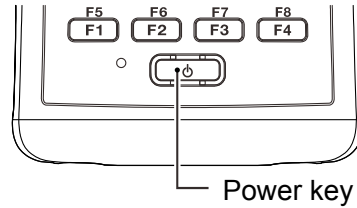

- 2 Select code scanning test of BhtShell from desktop menu.

Press the trigger key.

The BHT emits an illumination LED.

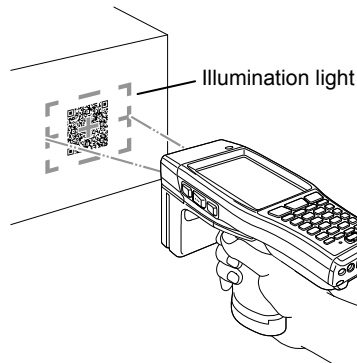

- 3 Hold the BHT close to the code to align the illumination LED.

When the BHT has read the code successfully, the indicator LED will illuminate in blue.

Codes can be read also by pressing the Scan key.

### Point

The code scanning method may differ depending on the application. Perform scanning in accordance with the instructions provided in the application User's Manual.

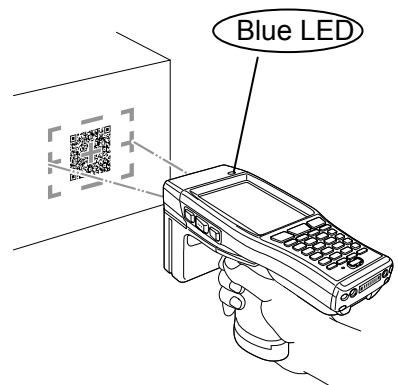

## When Unable to Successfully Read Codes

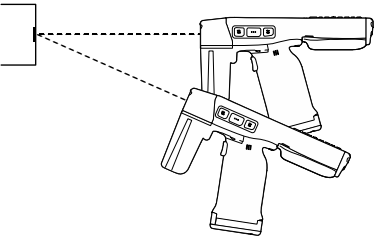
Cause		Countermeasure
Specular reflection	When the light is focused on the printed surface of the code from directly above, the BHT may not read the code due to specular reflection.	Change the BHT scanning angle and try again. 
Distance from code	Scanning may be unsuccessful if it is too close to or too far from the BHT reading window, even when the code is within the read area.	Move the BHT slowly toward or away from the code and try again.
Code surface curvature	Scanning may be unsuccessful if the code surface is curved.	Scan the barcode at the center of the barcode reading window.
Code surface dirt	Scanning may be unsuccessful if its surface is dirty.	Wipe the dirt from the code and try again.
Code reading window dirt	Scanning may be unsuccessful if the code reading window is dirty.	Blow any dust away with an airbrush, and then gently wipe the reading window with a cotton swab or similar soft object.
Direct sunlight, ambient light	Code scanning may be adversely affected by direct sunlight or the brightness of the surrounding light.	Perform code scanning away from direct sunlight. Try adjusting the brightness of the surrounding light when scanning indoors.

## Battery Power Level Indicator

The battery power level can be checked at the  icon that displays in the task tray.

The battery power displays in four levels. The battery power level indicator is a guideline to notify the operator to charge the battery promptly when discharged.

 : Sufficient battery power remains

 : The battery power is partially depleted. Charge promptly.

 : The battery power is almost fully depleted and should be charged immediately.

 : The battery power is fully depleted. Charge immediately or replace with a fully charged battery.

## Battery Service Life

The battery is a consumable part. And it should be replaced upon the earlier of one year or after being charged approximately 300 times. The performance of the battery's lithium-ion battery will deteriorate gradually with repeated charging and discharging, even during normal use. When the battery operation time becomes shorter even after charging for the specified length of time, replace the battery with a new one.

# Replacing the Batteries

- 1 Press the power key to turn OFF the BHT power. The screen on the right displays.

**Point**

Do not remove the battery until the power turns OFF and the screen display clears.

Shutdown  
In progress  
Do not remove  
The battery.

- 2 **Replacement of the battery in the main body**

Slide the battery cover lock as pushing it and remove the battery cover.

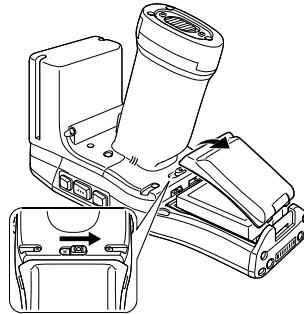

- 3 Remove the battery.

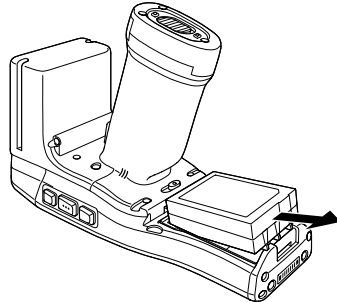

- 4 Confirm that the electrode of a new battery and that of the BHT are matched, and mount the battery in the arrow direction.

**Point**

To prevent the data from being lost, be sure to mount a new battery **within 3 minutes**.

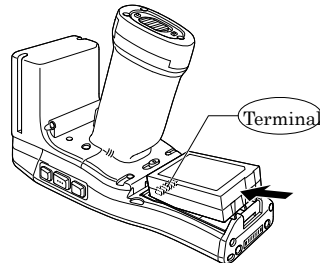

- 5** Close the battery cover and restore the battery cover lock to the original position.

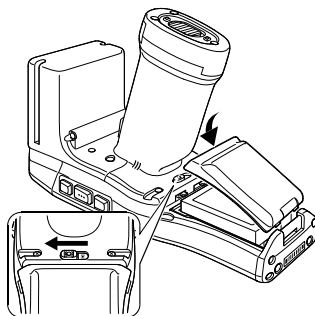

**6 Replacement of the battery in the grip**

Slide the battery cover lock as pushing it and remove the battery cover.

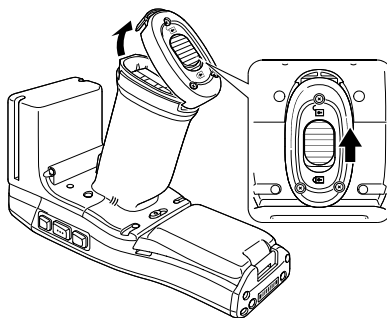

**7** Remove the battery.

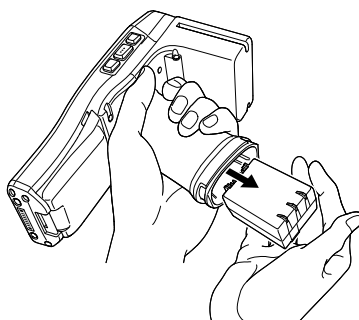

8

Check the protrusions of a new battery and mount the battery in the arrow direction.

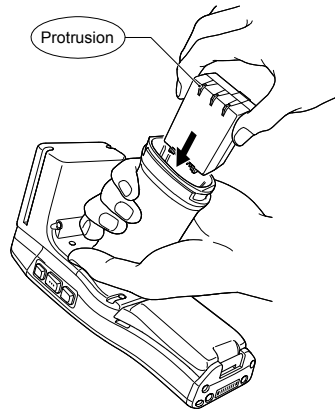

9

Close the battery cover, and restore the battery cover lock to the original position as pushing it.

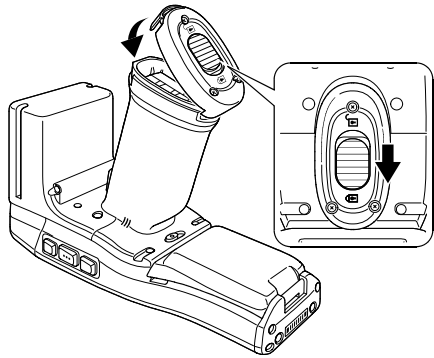

# Using the BHT after Long Non-Use

Data stored in the BHT may be lost or damaged and the calendar clock may stop if the BHT is left unused for a long period of time.

- Keep a backup copy of important or critical information.
- Reset the calendar clock if it is stopped.
- The battery is also used as a backup power source. You should not remove the battery from the BHT for at least 2 days until memory backup power is fully charged.

Please refer to the User's Manual for more information on trouble shooting.

## Troubleshooting Guide

### **Problem** The BHT power does not turn ON.

- Make sure that the battery is properly inserted into the BHT.
- Check the battery power level and charge the battery if necessary.
- Wipe any dirt from the battery and BHT terminals.

### **Problem** The BHT cannot be charged.

- Make sure that the Cradle is being used.
- Make sure that the battery is properly inserted into the BHT.
- Make sure that the BHT has been properly placed on the Cradle.  
The BHT LED will turn red when properly placed on the Cradle.
- Wipe any dirt from the battery and BHT terminals.
- If the battery in use is an old one that has been repeatedly charged 300 times or more, or if more than one year has elapsed, replace it with a new one.

### **Problem** The BHT unexpectedly turns OFF

- Make sure that the battery has been fully charged. If not, charge the battery.
- The BHT may be set to auto power OFF. If so, the BHT will automatically turn OFF when it is not used for the specified period of time.  
The auto power OFF setting can only be changed with the user program.

If the BHT cannot be tuned ON even after taking all the above measures, there is a possibility that the Cradle is broken. Notify the system administrator.

Refer to the User's Manual for appropriate measures if an error message is displayed on the BHT during the operation.

# Turning ON/OFF the Backlight

To turn the backlight ON or OFF, hold down the **Shift** key and press the **M3** Key.

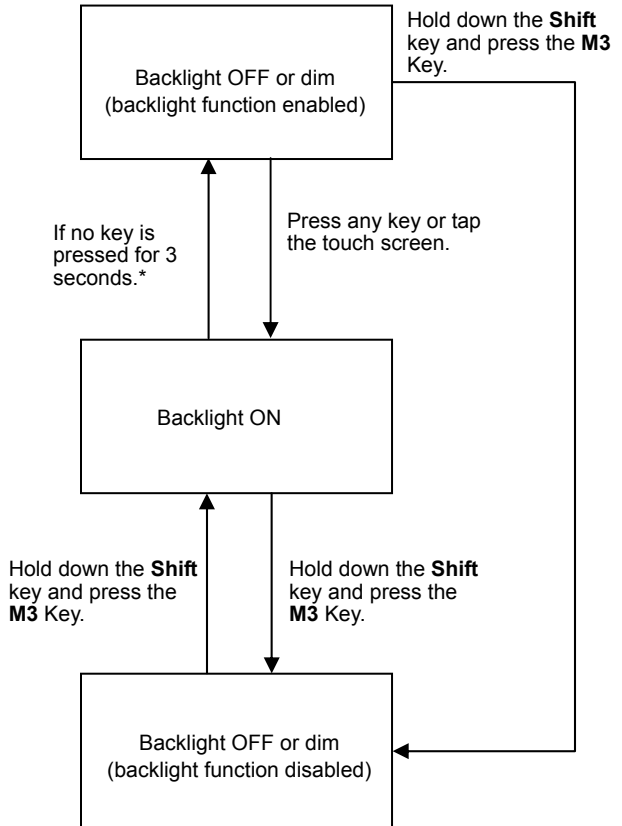
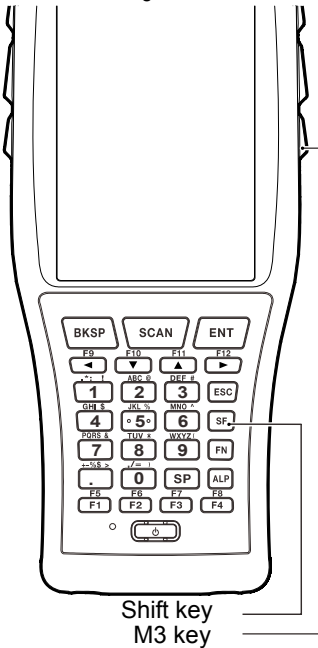

\* Within a minute if the BHT is placed on the Cradle.

- 
- Point –
- Time until auto OFF can be set at user programs.
  - As opposed to pressing the backlight function enable/disable key, the backlight function can be enabled or disabled at the Backlight settings menu.
-



# Resetting and Full Resetting

## Reset

Reset the BHT in the following cases.

- The BHT makes no response to entry from the touch screen or keys.
- Programs in the BHT malfunction for some unknown reason.

## Reset Method

With the BHT power ON, press the reset key combination (**BKSP + Right Trigger + Power**).

Then release all keys.

### Point

Data stored as a file will not be lost even after resetting. However, any data currently being edited will be lost.

## Full Reset

Perform a full reset if the problem persists even after resetting.

## Full Reset Method

With the BHT power ON, press the full reset key combination (**BKSP + ENT + Left Trigger + Power**) more than a second.

Then release all keys.

### Point

When performing full reset, all data including files and settings stored in the RAM will also be lost and the RAM will revert to the factory default. It is recommended that any important data be backed up to the "FLASH" folder or to the computer before full reset. When the BHT turns ON after the data in the RAM is deleted, the BHT starts from the "Initial Setup."

## Memory Contents after Reset/Full Reset

	<b>Reset</b>	<b>Full Reset</b>
Data in the "FLASH" folder (on-board FLASH memory)	Data retained	Data retained
Data in the "Storage Card" folder (microSD Card)	Data retained	Data retained
Data in other folders	Data retained	Data erased
Contents of the Registry	Data retained	Data erased <sup>(Note)</sup>
Data being edited	Data erased	Data erased

(Note) If the Registry has been backed up the backed up Registry will be used.

## FCC Regulation (for United States America)

This equipment has been tested and found to comply with the limits for a Class A digital device, pursuant to part 15 of the FCC Rules. These limits are designed to provide reasonable protection against harmful interference when the equipment is operated in a commercial environment. This equipment generates, uses, and can radiate radio frequency energy and, if not installed and used in accordance with the instruction manual, may cause harmful interference to radio communications. Operation of this equipment in a residential area is likely to cause harmful interference in which case the user will be required to correct the interference at his own expense.

### FCC WARNING:

Changes or modifications not expressly approved by the party responsible for compliance could void the user's authority to operate the equipment.

### Note:

This transmitter must not be co-located or operated in conjunction with any other antenna or transmitter.

This device complies with Part 15 of the FCC Rules. Operation is subject to the following two conditions: (1) This device may not cause harmful interference, and (2) this device must accept any interference received, including interference that may cause undesired operation.

<Information>

Company Name : DENSO PRODUCTS AND SERVICES AMERICAS, INC.

Address : 3900 Via Oro Avenue, Long Beach, California 90810, U.S.A.

Tel : +1-310-834-6352

## IC Regulation (for Canada)

This device complies with Industry Canada licence-exempt RSS standard(s). Operation is subject to the following two conditions: (1) this device may not cause interference, and (2) this device must accept any interference, including interference that may cause undesired operation of the device.

Le présent appareil est conforme aux CNR d'Industrie Canada applicables aux appareils radio exempts de licence. L'exploitation est autorisée aux deux conditions suivantes : (1) l'appareil ne doit pas produire de brouillage, et (2) l'utilisateur de l'appareil doit accepter tout brouillage radioélectrique subi, même si le brouillage est susceptible d'en compromettre le fonctionnement.

### 2.4 GHz WLAN

For product available in the USA/Canada market, only channel 1-11 can be operated. Selection of other channels is not possible.

## **FCC/IC Radiation Exposure Statement**

The available scientific evidence does not show that any health problems are associated with using low power wireless devices. There is no proof, however, that these low power wireless devices are absolutely safe. Low power Wireless devices emit low levels of radio frequency energy (RF) in the microwave range while being used. Whereas high levels of RF can produce health effects (by heating tissue), exposure to low-level RF that does not produce heating effects causes no known adverse health effects. Many studies of low-level RF exposures have not found any biological effects. Some studies have suggested that some biological effects might occur, but such findings have not been confirmed by additional research. This 2D code Handy Terminal (BHT-1281QULWB-CE) has been tested and found to comply with FCC/IC radiation exposure limits set forth for an uncontrolled environment and meets the FCC radio frequency (RF) Exposure Guidelines in Supplement C to OET65 and RSS-102 of the IC radio frequency (RF) Exposure rules. The maximum SAR levels tested for (BHT-1281QULWB-CE) has been shown to be 0.20 W/kg at Body.

Les connaissances scientifiques dont nous disposons n'ont mis en évidence aucun problème de santé associé à l'usage des appareils sans fil à faible puissance. Nous ne sommes cependant pas en mesure de prouver que ces appareils sans fil à faible puissance sont entièrement sans danger. Les appareils sans fil à faible puissance émettent une énergie radioélectrique (RF) très faible dans le spectre des micro-ondes lorsqu'ils sont utilisés. Alors qu'une dose élevée de RF peut avoir des effets sur la santé (en chauffant les tissus), l'exposition à de faibles RF qui ne produisent pas de chaleur n'a pas de mauvais effets connus sur la santé. De nombreuses études ont été menées sur les expositions aux RF faibles et n'ont découvert aucun effet biologique. Certaines études ont suggéré qu'il pouvait y avoir certains effets biologiques, mais ces résultats n'ont pas été confirmés par des recherches supplémentaires. Ce 2D Code Handy Terminal (BHT-1281QULWB-CE) a été testé et jugé conforme aux limites d'exposition aux rayonnements énoncées pour un environnement non contrôlé et respecte les règles des radioélectriques (RF) de la FCC lignes directrices d'exposition dans le Supplément C à OET65 et d'exposition aux fréquences radioélectriques (RF) CNR- 102 de l'IC. Le niveau maximum de DAS mesuré pour 2D Code Handy Terminal (BHT-1281QULWB-CE) est de 0.20 W/kg contre le corps.







---

# DENSO WAVE INCORPORATED

1, Yoshiike, Kusagi, Agui-cho, Chita-gun, Aichi 470-2297, Japan

<http://www.denso-wave.com/>

This manual uses recycled paper.  
본 인쇄물은 재생지를 활용합니다.  
这个印刷品正使用再生纸。