

TEST REPORT

Test report no.: 1-5831/13-10-11-B



Testing laboratory

CETECOM ICT Services GmbH
 Untertuerkheimer Strasse 6 – 10
 66117 Saarbruecken / Germany
 Phone: + 49 681 5 98 - 0
 Fax: + 49 681 5 98 - 9075
 Internet: <http://www.cetecom.com>
 e-mail: ict@cetecom.com

Accredited Testing Laboratory:
 The testing laboratory (area of testing) is accredited according to DIN EN ISO/IEC 17025 (2005) by the Deutsche Akkreditierungsstelle GmbH (DAkkS)
 The accreditation is valid for the scope of testing procedures as stated in the accreditation certificate with the registration number: D-PL-12076-01-01
 Area of Testing: Radio/Satellite Communications

Applicant

Sony Mobile Communications AB
 Nya Vattentornet
 22188 Lund / SWEDEN
 Phone: +46 46 19 30 00
 Fax: +46 1 08 00 24 41
 Contact: Fredrik Björk
 e-mail: Fredrik.Bjork@sonymobile.com
 Phone: +46 1 08 01 46 75
 Mobile: +46 70 32 40 14 0

Manufacturer

Sony Mobile Communications AB
 Nya Vattentornet
 22188 Lund / SWEDEN

Test standard/s

47 CFR Part 15	Title 47 of the Code of Federal Regulations; Chapter I Part 15 - Radio frequency devices
RSS - 210 Issue 8	Spectrum Management and Telecommunications - Radio Standards Specification Low-power Licence-exempt Radiocommunication Devices (All Frequency Bands): Category I Equipment

For further applied test standards please refer to section 3 of this test report.

Test Item

Kind of test item:	Tablet PC GPRS/EGPRS 850/900/1800/1900; UMTS HSPA FDDI/V/VIII; LTE FDD1/3/5/7/8/20; WLAN a/b/g/n; BT 3.1; RFID; FM Rx; A-GPS
Model name:	SGP321
FCC ID:	PY7TM-0030
IC:	4170B-TM0030
Frequency:	UNII bands: 5150 MHz to 5250 MHz; 5250 MHz to 5350 MHz and 5470 to 5725 MHz
Technology tested:	WLAN (OFDM / a – & n HT20 – mode; OFDM / n HT40 – mode)
Antenna:	Integrated antenna
Power Supply:	3.7 V DC by Li - Ion battery
Temperature Range:	-20°C to +55°C

This test report is electronically signed and valid without handwriting signature. For verification of the electronic signatures, the public keys can be requested at the testing laboratory.

Test report authorised:



Stefan Bös
 Senior Testing Manager

Test performed:



Marco Bertolino
 Testing Manager

1 Table of contents

1 Table of contents2

2 General information3

 2.1 Notes and disclaimer3

 2.2 Application details.....3

3 Test standard/s3

 3.1 Measurement guidance.....3

4 Test environment.....4

5 Test item4

 5.1 Additional information4

6 Test laboratories sub-contracted4

7 Summary of measurement results5

8 RF measurements6

 8.1 Description of test setup6

 8.1.1 Radiated measurements.....6

 8.1.2 Conducted measurements.....7

 8.2 Additional comments7

 8.3 RSP100 test report cover sheet / performance test data8

9 Measurement results.....10

 9.1 Output power verification (conducted)10

 9.2 Gain.....11

 9.3 Duty cycle.....17

 9.4 Maximum output power conducted and radiated19

 9.5 Power spectral density35

 9.6 Spectrum bandwidth – 26 dB bandwidth49

 9.7 Peak excursion measurements.....63

 9.8 Band edge compliance radiated77

 9.9 TX spurious emissions radiated83

 9.10 RX spurious emissions radiated129

 9.11 Spurious emissions radiated < 30 MHz133

 9.12 Spurious emissions conducted < 30 MHz135

10 Test equipment and ancillaries used for tests138

11 Observations139

Annex A Document history140

Annex B Further information.....140

Annex C Accreditation Certificate141

2 General information

2.1 Notes and disclaimer

The test results of this test report relate exclusively to the test item specified in this test report. CETECOM ICT Services GmbH does not assume responsibility for any conclusions and generalizations drawn from the test results with regard to other specimens or samples of the type of the equipment represented by the test item.

The test report may only be reproduced or published in full. Reproduction or publication of extracts from the report requires the prior written approval of CETECOM ICT Services GmbH.

The testing service provided by CETECOM ICT Services GmbH has been rendered under the current "General Terms and Conditions for CETECOM ICT Services GmbH".

CETECOM ICT Services GmbH will not be liable for any loss or damage resulting from false, inaccurate, inappropriate or incomplete product information provided by the customer.

Under no circumstances does the CETECOM ICT Services GmbH test report include any endorsement or warranty regarding the functionality, quality or performance of any other product or service provided.

Under no circumstances does the CETECOM ICT Services GmbH test report include or imply any product or service warranties from CETECOM ICT Services GmbH, including, without limitation, any implied warranties of merchantability, fitness for purpose, or non-infringement, all of which are expressly disclaimed by CETECOM ICT Services GmbH.

All rights and remedies regarding vendor's products and services for which CETECOM ICT Services GmbH has prepared this test report shall be provided by the party offering such products or services and not by CETECOM ICT Services GmbH.

In no case this test report can be considered as a Letter of Approval.

This test report is electronically signed and valid without handwritten signature. For verification of the electronic signatures, the public keys can be requested at the testing laboratory.

2.2 Application details

Date of receipt of order:	2013-01-30
Date of receipt of test item:	2013-04-01
Start of test:	2013-04-01
End of test:	2013-04-10
Person(s) present during the test:	-/-

3 Test standard/s

Test standard	Date	Test standard description
47 CFR Part 15	2012-10	Title 47 of the Code of Federal Regulations; Chapter I Part 15 - Radio frequency devices
RSS - 210 Issue 8	2010-12	Spectrum Management and Telecommunications - Radio Standards Specification Low-power Licence-exempt Radiocommunication Devices (All Frequency Bands): Category I Equipment

3.1 Measurement guidance

UNII: KDB 789033	2011-10	Guidelines for Compliance Testing of Unlicensed National Information Infrastructure (U-NII) Devices - Part 15, Subpart E
------------------	---------	--

4 Test environment

Temperature:	T_{nom}	+22 °C during room temperature tests
	T_{max}	+55 °C during high temperature tests
	T_{min}	-20 °C during low temperature tests
Relative humidity content:		41 %
Barometric pressure:		not relevant for this kind of testing
Power supply:	V_{nom}	3.7 V DC by Li - Ion battery
	V_{max}	4.1 V
	V_{min}	3.3 V

5 Test item

Kind of test item	:	Tablet PC GPRS/EGPRS 850/900/1800/1900; UMTS HSPA FDDI/V/VIII; LTE FDD1/3/5/7/8/20; WLAN a/b/g/n; BT 3.1; RFID; FM Rx; A-GPS
Type identification	:	SGP321
S/N serial number	:	Radiated units: CB5A1NY06R; CB5A1NY07J Conducted units: CB5A1NY07G; CB5A1NY070
HW hardware status	:	AP1
SW software status	:	10.1.1.A.1.11
Frequency band [MHz]	:	UNII bands: 5150 MHz to 5250 MHz; 5250 MHz to 5350 MHz; 5470 MHz to 5725 MHz (lowest channel 36 – 5180 MHz; highest channel 140 – 5700 MHz)
Type of radio transmission	:	OFDM
Use of frequency spectrum	:	
Type of modulation	:	QPSK, 16 – QAM, 64 – QAM
Number of channels	:	19
Antenna	:	Integrated antenna
Power supply	:	3.7 V DC by Li - Ion battery
Temperature range	:	-20°C to +55 °C

5.1 Additional information

Test setup - and EUT - photos are included in the following test reports:

External EUT photos: 1-5831/13-10-01_AnnexA
 Internal EUT photos: 1-5831/13-10-01_AnnexB
 Test setup: 1-5831/13-10-01_AnnexD

6 Test laboratories sub-contracted

None

7 Summary of measurement results

- No deviations from the technical specifications were ascertained
 There were deviations from the technical specifications ascertained

TC Identifier	Description	Verdict	Date	Remark
RF-Testing	CFR Part 15 RSS 210, Issue 8, Annex 9	Passed	2013-04-17	-/-

Test specification clause	Test case	Temperature conditions	Power source voltages	Pass	Fail	NA	NP	Remark
-/-	Output power verification (conducted)	Nominal	Nominal	<input type="checkbox"/>	<input type="checkbox"/>	<input type="checkbox"/>	<input type="checkbox"/>	No passed / fail criteria!
-/-	Gain	Nominal	Nominal	<input type="checkbox"/>	<input type="checkbox"/>	<input type="checkbox"/>	<input type="checkbox"/>	No passed / fail criteria!
U-NII Part 15	Duty cycle	Nominal	Nominal	<input type="checkbox"/>	<input type="checkbox"/>	<input type="checkbox"/>	<input type="checkbox"/>	No passed / fail criteria!
§15.407(a) RSS-210	Maximum output power (conducted & radiated)	Nominal	Nominal	<input checked="" type="checkbox"/>	<input type="checkbox"/>	<input type="checkbox"/>	<input type="checkbox"/>	complies
§15.407(a) RSS-210	Power spectral density	Nominal	Nominal	<input checked="" type="checkbox"/>	<input type="checkbox"/>	<input type="checkbox"/>	<input type="checkbox"/>	complies
§15.407(a) RSS-210	Spectrum bandwidth 26dB bandwidth	Nominal	Nominal	<input checked="" type="checkbox"/>	<input type="checkbox"/>	<input type="checkbox"/>	<input type="checkbox"/>	complies
§15.407(a) RSS-210	Peak excursion measurements	Nominal	Nominal	<input checked="" type="checkbox"/>	<input type="checkbox"/>	<input type="checkbox"/>	<input type="checkbox"/>	complies
§15.205 RSS-210	Band edge compliance radiated	Nominal	Nominal	<input checked="" type="checkbox"/>	<input type="checkbox"/>	<input type="checkbox"/>	<input type="checkbox"/>	complies
§15.407(b) RSS-210	TX spurious emissions radiated	Nominal	Nominal	<input checked="" type="checkbox"/>	<input type="checkbox"/>	<input type="checkbox"/>	<input type="checkbox"/>	complies
§15.109 RSS-Gen	RX spurious emissions radiated	Nominal	Nominal	<input checked="" type="checkbox"/>	<input type="checkbox"/>	<input type="checkbox"/>	<input type="checkbox"/>	complies
§15.209(a) RSS-Gen	Spurious emissions radiated < 30 MHz	Nominal	Nominal	<input checked="" type="checkbox"/>	<input type="checkbox"/>	<input type="checkbox"/>	<input type="checkbox"/>	complies
§15.107(a)	Spurious emissions conducted emissions < 30 MHz	Nominal	Nominal	<input checked="" type="checkbox"/>	<input type="checkbox"/>	<input type="checkbox"/>	<input type="checkbox"/>	complies

Note: NA = Not Applicable; NP = Not Performed

8 RF measurements

8.1 Description of test setup

8.1.1 Radiated measurements

The radiated measurements are performed in vertical and horizontal plane in the frequency range from 9 kHz to 25 GHz in semi-anechoic chambers. The EUT is positioned on a non-conductive support with a height of 0.80 m above a conductive ground plane that covers the whole chamber. These antennas can be moved over the height range between 1.0 m and 4.0 m in order to search for maximum field strength emitted from EUT. The measurement distances between EUT and receiving antennas are indicated in the test setups for the various frequency ranges. For each measurement, the EUT is rotated in all three axes until the maximum field strength is received. The wanted and unwanted emissions are received by spectrum analysers where the detector modes and resolution bandwidths over various frequency ranges are set according to requirement ANSI C63. Antennas are confirmed with ANSI C63.

Semi anechoic chamber

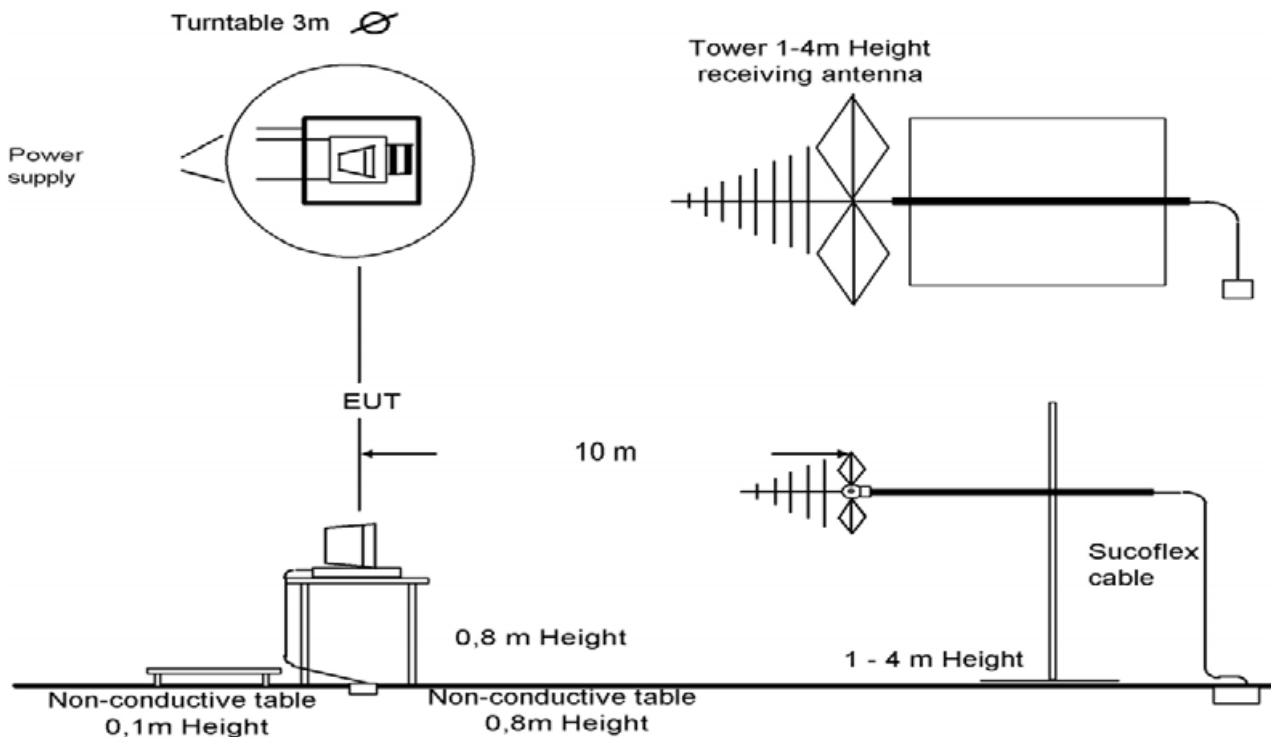

Picture 1: Diagram radiated measurements

9 kHz - 30 MHz:	active loop antenna
30 MHz – 1 GHz:	tri-log antenna
> 1 GHz:	horn antenna

The EUT is powered by an external power supply with nominal voltage

8.1.2 Conducted measurements

The EUT's RF signal is coupled out by the antenna connector which is supplied by the manufacturer. The signal is first 10dB attenuated before it is power divided (~6dB loss per branch). One of the signal paths is connected to the communication base Station (CMU200 or other), the other one is connected to the spectrum analyzer. The specific losses for both signal paths are first checked within a calibration. The measurement readings on the signalling unit/spectrum analyzer are corrected by the specific test set-up loss. The attenuator, power divider, signalling unit and the spectrum analyzer are impedance matched on 50 Ohm.

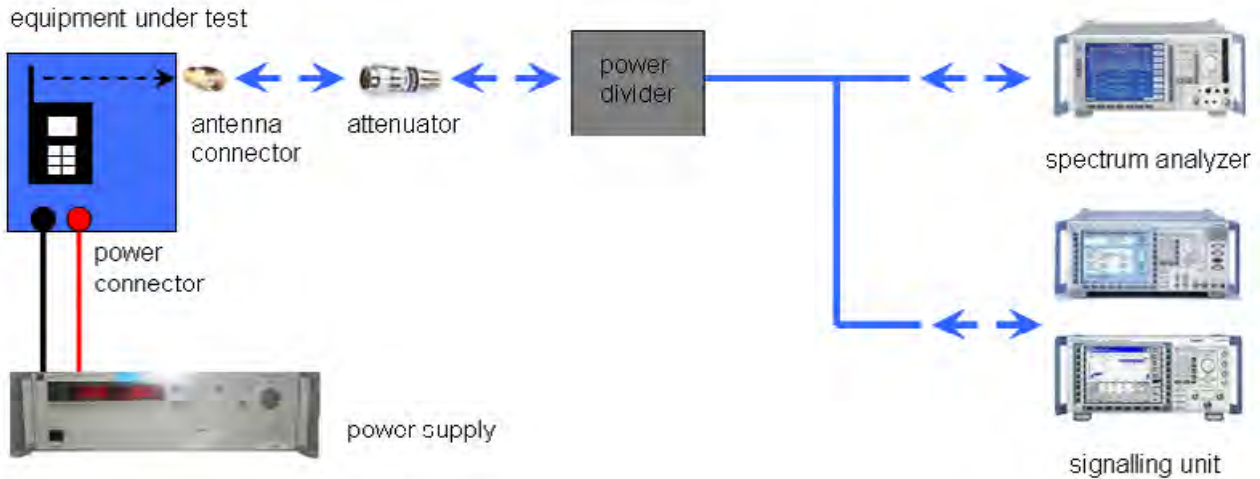

Picture 2: Diagram conducted measurements

8.2 Additional comments

Reference documents: None

Special test descriptions: None

Configuration descriptions: None

- Test mode:
- No test mode available.
 - Special software is used.
EUT is transmitting pseudo random data by itself

8.3 RSP100 test report cover sheet / performance test data

Test report number	:	1-5831/13-10-11-B			
Equipment model number:		SGP321			
Certification number	:	4170B-TM0030			
Manufacturer (complete address)	:	Sony Mobile Communications AB Nya Vattentornet 22188 Lund / SWEDEN			
Tested to radio standards Specification no.	:	RSS 210, Issue 8, Annex 9			
Open area test site IC No.:		IC 3462C-1			
Frequency range	:	UNII bands: 5150 MHz to 5250 MHz; 5250 MHz to 5350 MHz 5470 MHz to 5600 MHz; 5650 MHz to 5725 MHz			
RF-power [mW] (max.)	:	Conducted values:			
		Band	a	n HT20	n HT40
		5180 – 5240 MHz	7.23 mW	6.40 mW	
		5190 – 5230 MHz			7.44 mW
		5260 – 5320 MHz	6.52 mW	6.75 mW	
		5270 – 5310 MHz			6.85 mW
		5500 – 5700 MHz	6.11 mW	6.95 mW	
		5510 – 5670 MHz			7.43 mW
		Radiated values:			
		Band	a	n HT20	n HT40
		5180 – 5240 MHz	5.01 mW	4.50 mW	
		5190 – 5230 MHz			6.50 mW
		5260 – 5320 MHz	8.17 mW	8.02 mW	
		5270 – 5310 MHz			8.59 mW
5500 – 5700 MHz	5.94 mW	7.00 mW			
5510 – 5670 MHz			7.03 mW		
Occupied bandwidth (99%-BW) [kHz]	:	Band	a	n HT20	n HT40
		5180 – 5240 MHz	16.49 MHz	17.67 MHz	
		5190 – 5230 MHz			36.07 MHz
		5260 – 5320 MHz	16.49 MHz	17.67 MHz	
		5270 – 5310 MHz			36.07 MHz
		5500 – 5700 MHz	16.49 MHz	17.67 MHz	
Necessary bandwidth (calculated) [kHz]	:	Band	a	n HT20	n HT40
		5180 – 5240 MHz	16.88 MHz	16.88 MHz	
		5190 – 5230 MHz			33.75 MHz
		5260 – 5320 MHz	16.88 MHz	16.88 MHz	
		5270 – 5310 MHz			33.75 MHz
		5500 – 5700 MHz	16.88 MHz	16.88 MHz	
5510 – 5670 MHz			33.75 MHz		
Emission classification	:	(according TRC-43)	G7D		
Type of modulation	:	QPSK, 16 – QAM, 64 – QAM			
Antenna information	:	Integrated antenna			
Transmitter spurious [dB μ V/m @ 3m]	:	45 dB μ V/m @ 12 GHz (noise floor / peak)			

ATTESTATION:
DECLARATION OF COMPLIANCE:

I attest that the testing was performed or supervised by me; that the test measurements were made in accordance with the above-mentioned Industry Canada standard(s); and that the equipment identified in this application has been subjected to all the applicable test conditions specified in the Industry Canada standards and all of the requirements of the standard have been met.

Laboratory manager:

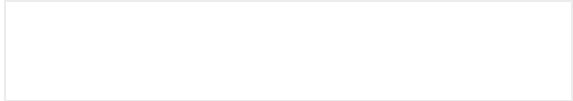
2013-04-17	Marco Bertolino	
Date	Name	Signature

9 Measurement results

9.1 Output power verification (conducted)

Description:

Measurement of the maximum output power conducted. This measurement is performed only at the middle channel in all modes and all data rates to determine the data rate per mode which results in the highest output power. This mode will be selected for all further measurements.

Measurement:

Measurement parameter	
Detector:	Peak
Sweep time:	5 s
Resolution bandwidth:	40 MHz
Video bandwidth:	40 MHz
Span:	Zero-Span
Trace-Mode:	Max Hold

Results:

OFDM / a – mode Data Rate [MBit/s]	Maximum Output Power Conducted [dBm]							
	6	9	12	18	24	36	48	54
Ch 48 - 5240 MHz	19.19	19.54	19.64	19.13	19.62	19.67	19.34	19.60
Measurement uncertainty	± 0.5 dB							

OFDM / n – mode HT 20 Data Rate [MBit/s]	Maximum Output Power Conducted [dBm]							
	MCS0	MCS1	MCS2	MCS3	MCS4	MCS5	MCS6	MCS7
Ch 48 - 5240 MHz	19.36	19.47	19.28	19.55	19.72	19.31	19.62	19.26
Measurement uncertainty	± 0.5 dB							

OFDM / n – mode HT40 Data Rate [MBit/s]	Maximum Output Power Conducted [dBm]							
	MCS0	MCS1	MCS2	MCS3	MCS4	MCS5	MCS6	MCS7
Ch 46 - 5230 MHz	18.10	19.18	19.52	20.09	18.98	19.00	19.32	18.42
Measurement uncertainty	± 0.5 dB							

Result: Selected data rate for all measurements:

OFDM / a – mode: 36 MBit/s
 OFDM / n – mode HT20: MCS4
 OFDM / n – mode HT40: MCS3

9.2 Gain

Description:

Measurement of the maximum output power conducted and radiated

Measurement:

Measurement parameter	
Detector:	Peak
Sweep time:	5s
Resolution bandwidth:	3 MHz
Video bandwidth:	≥ RBW
Span:	See complete signal!
Trace-Mode:	Max Hold

Limits:

Antenna Gain
Maximum 6 dBi

Result:

OFDM Band 5150 MHz to 5250 MHz Channel	Gain		
	Lowest 5180 MHz	-/-	Highest 5240 MHz
Radiated power for gain calculation	10.60	-/-	10.70
Conducted power for gain calculation	11.19	-/-	12.29
Gain	-0.59	-/-	-1.59
Measurement uncertainty	± 3 dB		

OFDM Band 5250 MHz to 5350 MHz Channel	Gain		
	Lowest 5260 MHz	-/-	Highest 5320 MHz
Radiated power for gain calculation	9.80	-/-	12.70
Conducted power for gain calculation	11.18	-/-	11.72
Gain	-1.38	-/-	+0.98
Measurement uncertainty	± 3 dB		

OFDM Band 5470 MHz to 5725 MHz Channel	Gain		
	Lowest 5500 MHz	Middle 5600 MHz	Highest 5700 MHz
Radiated power for gain calculation	11.20	11.60	11.30
Conducted power for gain calculation	12.09	11.57	11.54
Gain	-0.89	+0.03	-0.24
Measurement uncertainty	± 3 dB		

Result: Passed

Plots: conducted power for gain calculation

Plot 1: OFDM / a – mode, 5180 MHz

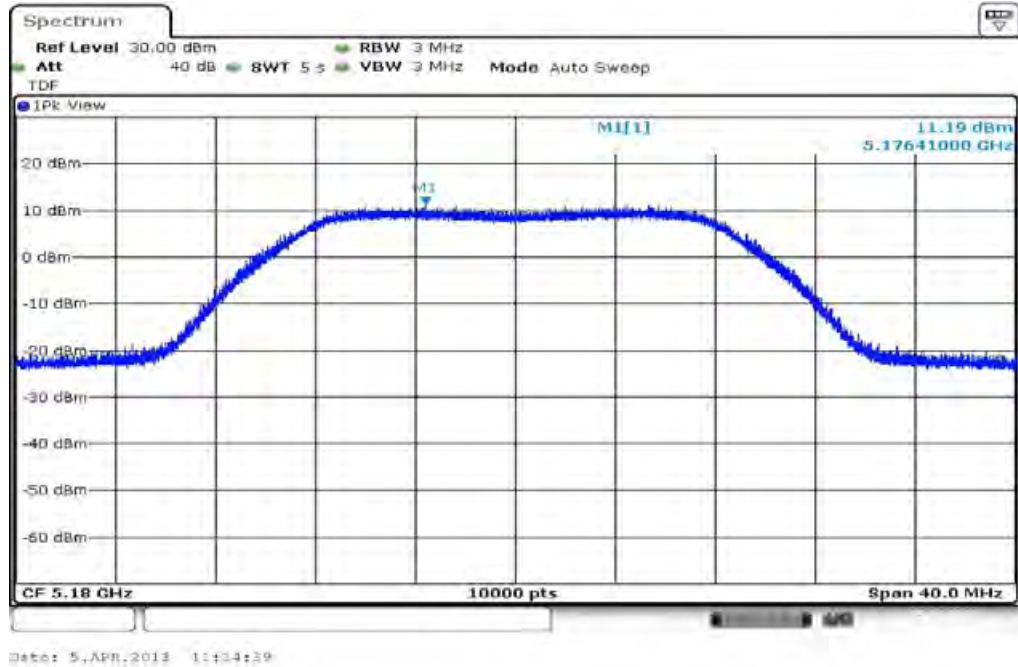

Plot 2: OFDM / a – mode, 5240 MHz



Plot 3: OFDM / a – mode, 5260 MHz

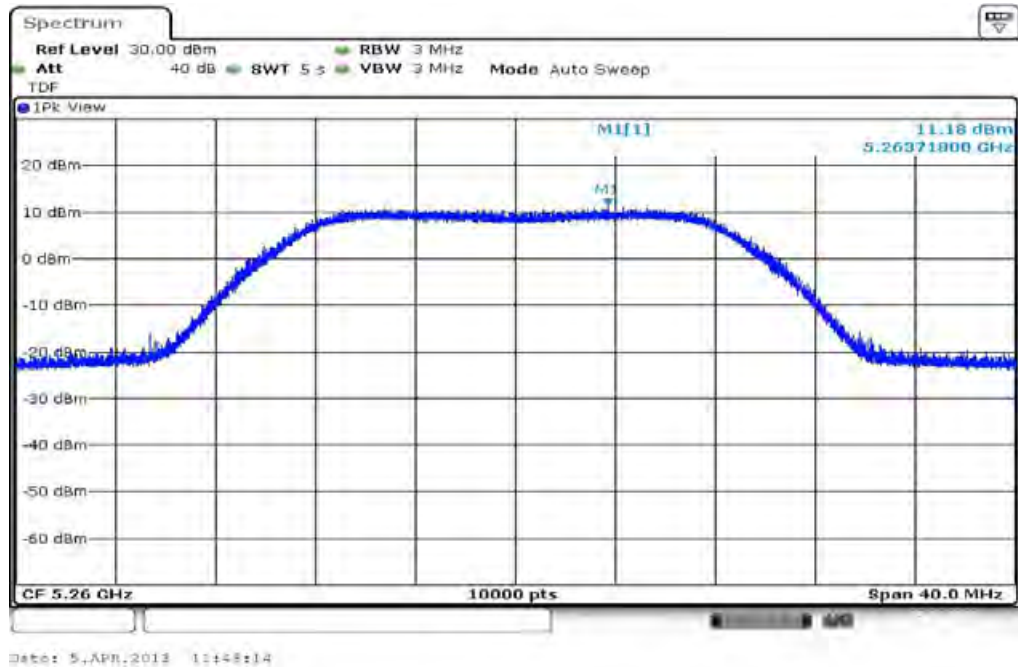

Plot 4: OFDM / a – mode, 5320 MHz

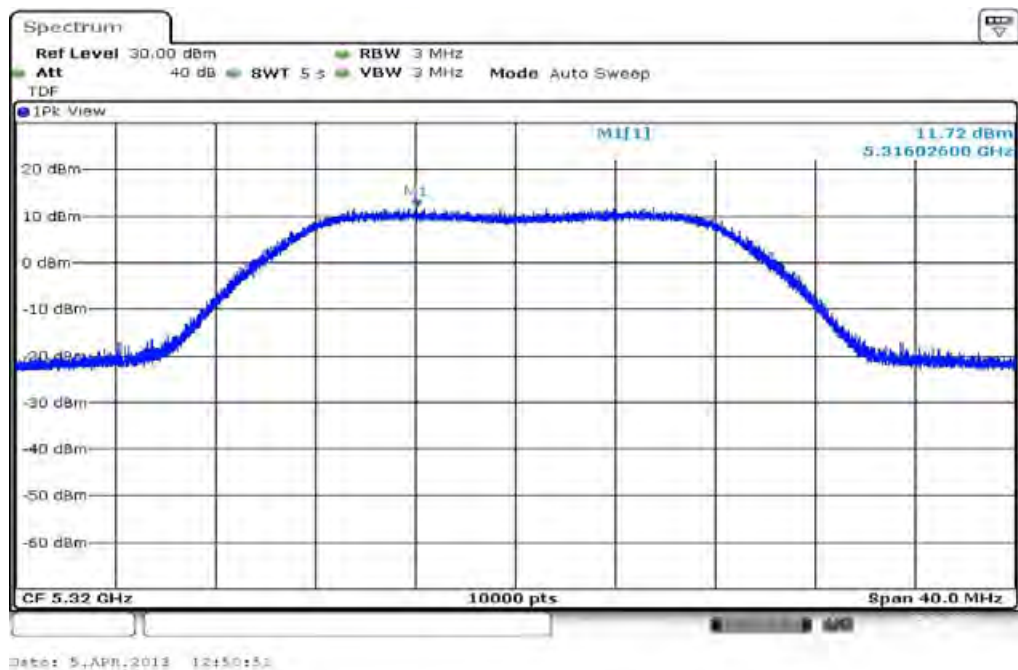

Plot 5: OFDM / a – mode, 5500 MHz

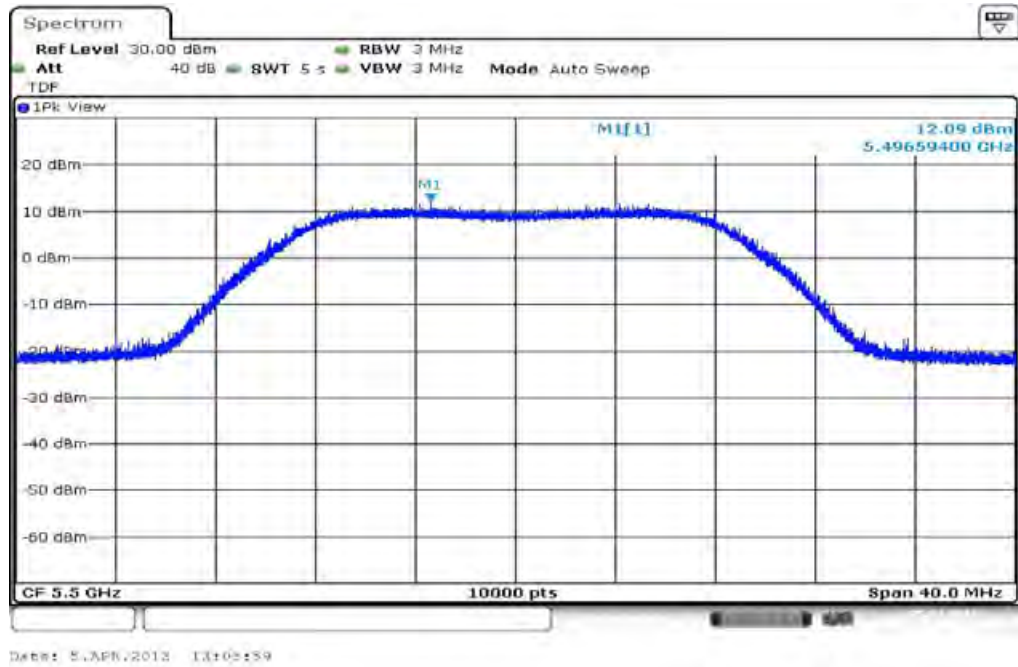

Plot 6: OFDM / a – mode, 5600 MHz

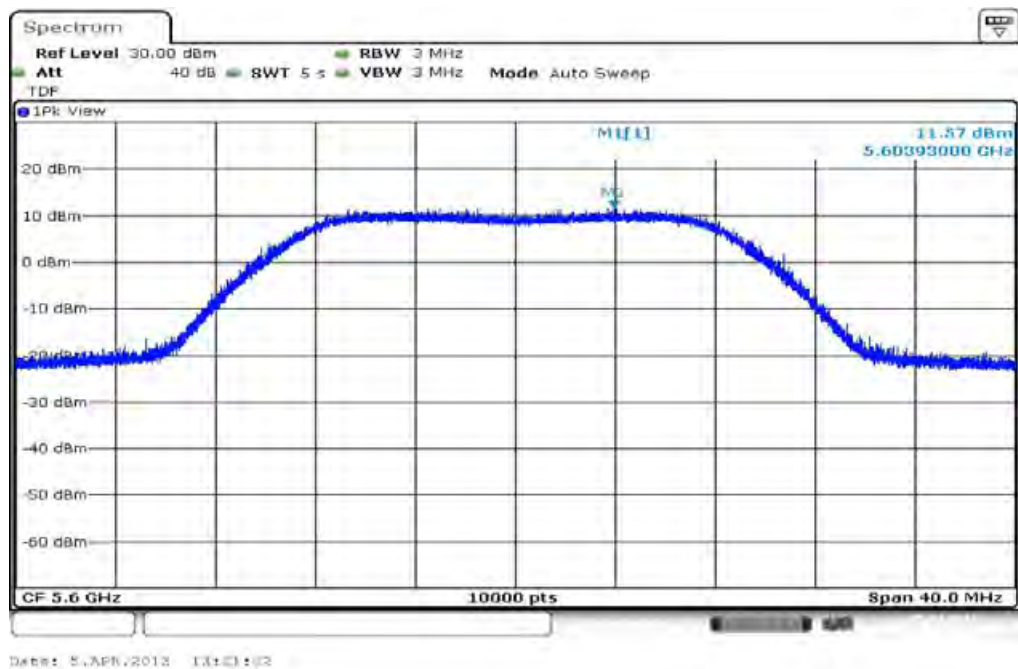

Plot 7: OFDM / a – mode, 5700 MHz

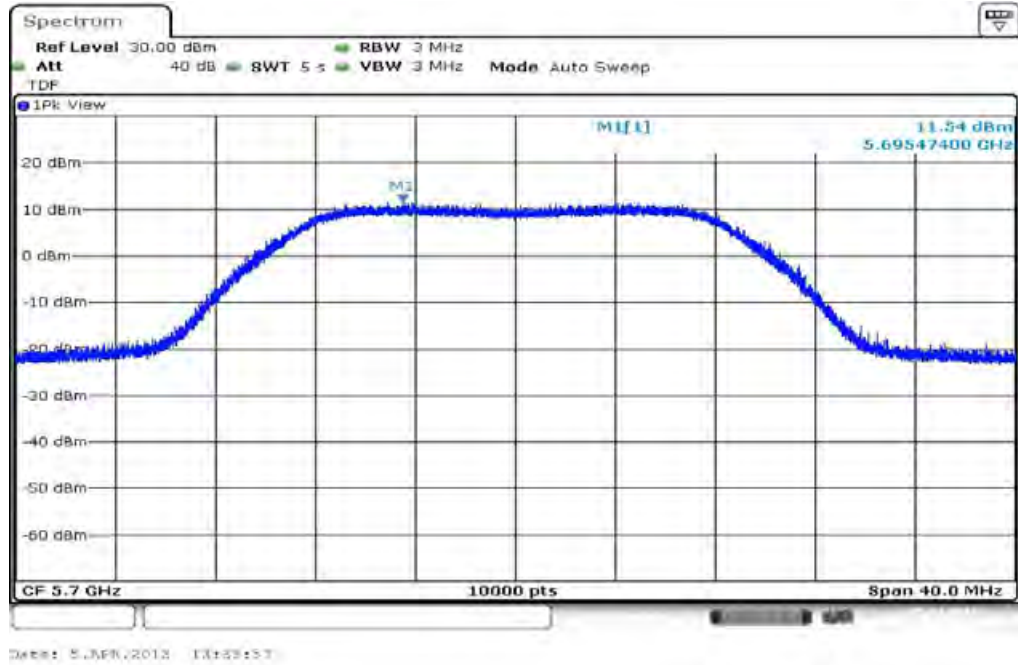

9.3 Duty cycle

Measurement:

Measurement parameter	
Detector:	Peak
Sweep time:	Auto
Resolution bandwidth:	10 MHz
Video bandwidth:	10 MHz
Span:	Zero
Trace-Mode:	Video trigger / view / single sweep

Results:

Duty cycle and correction factor:

OFDM / a – mode: 82.86 % duty cycle => 0.82 dB
 OFDM / n – mode HT20: 82.85 % duty cycle => 0.82 dB
 OFDM / n – mode HT40: 87.99 % duty cycle => 0.56 dB

Plots:

Plot 1: duty cycle of the transmitter – OFDM / a – mode

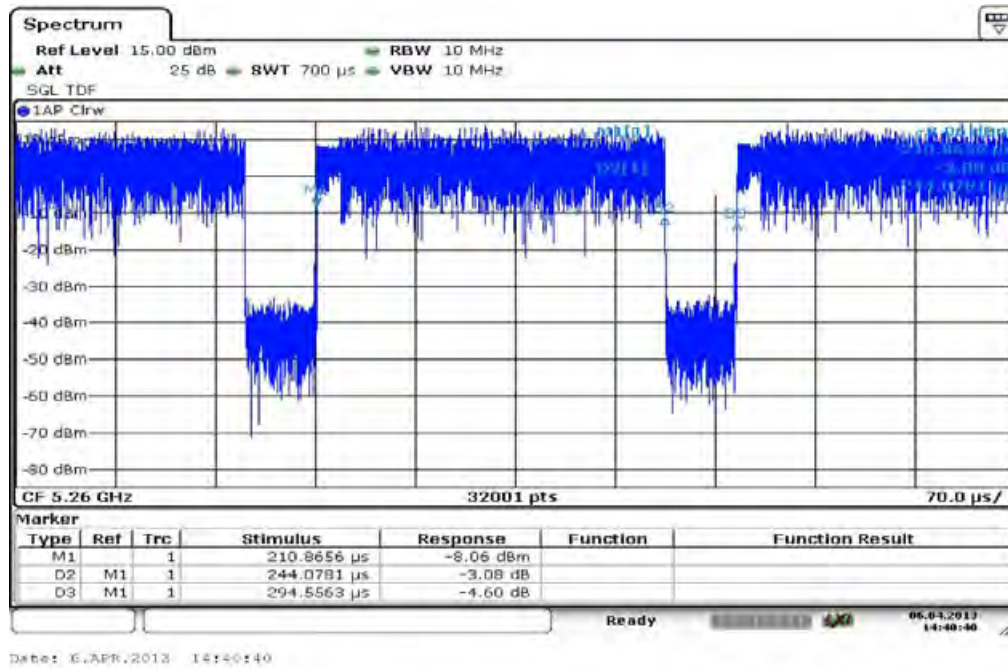

Plot 2: duty cycle of the transmitter – OFDM / n – mode HT20

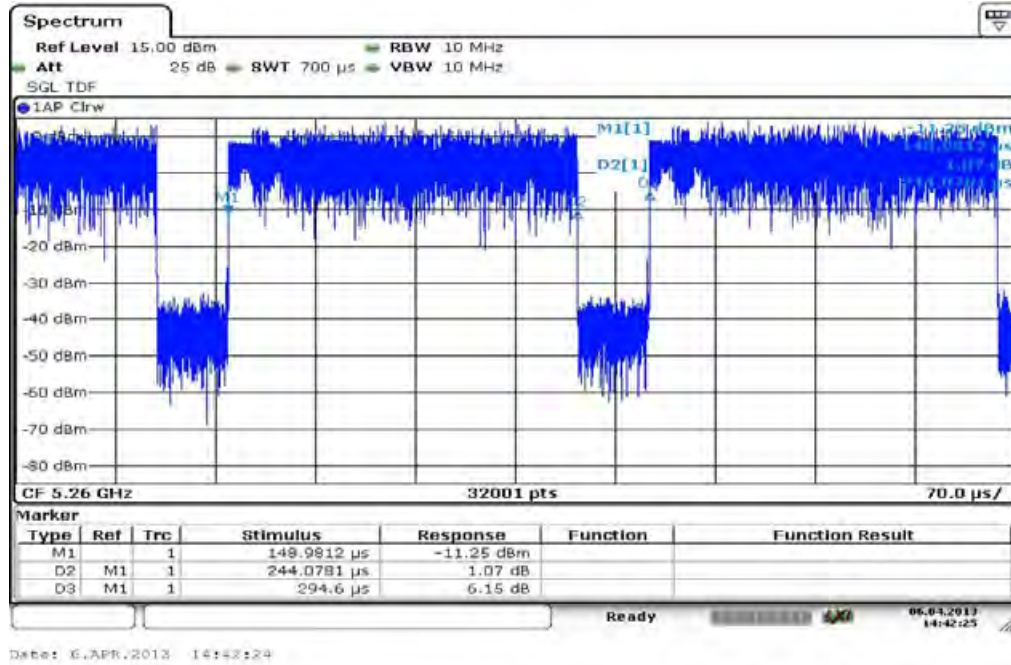

Plot 3: duty cycle of the transmitter – OFDM / n – mode HT40

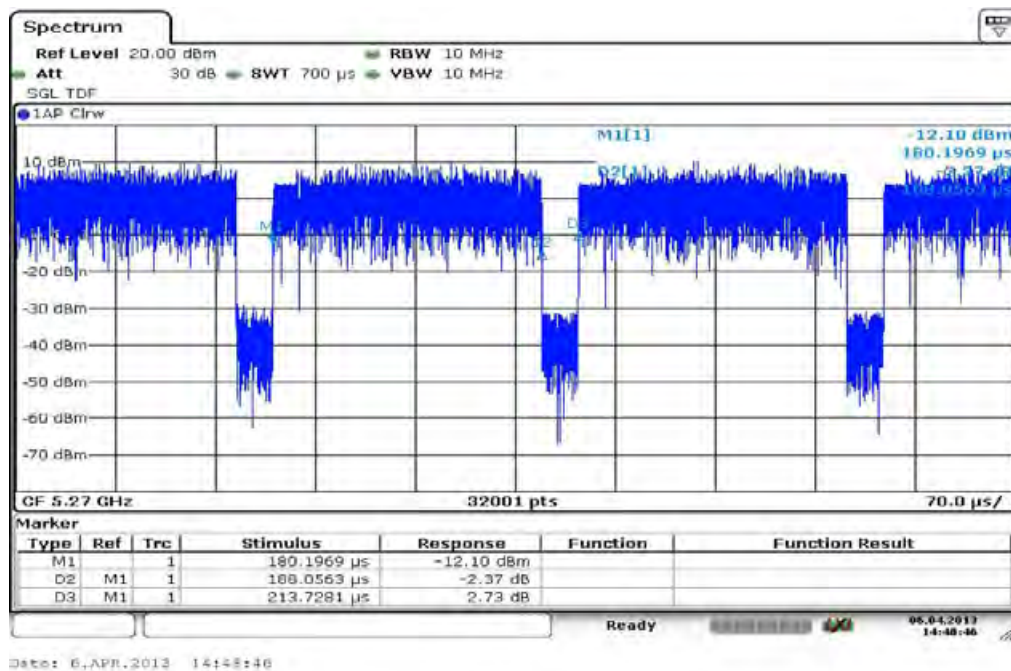

9.4 Maximum output power conducted and radiated

Description:

Measurement of the maximum output power conducted and radiated

Measurement:

Measurement parameter	
Detector:	RMS
Sweep time:	60s
Resolution bandwidth:	1 MHz
Video bandwidth:	≥ 3 MHz
Span:	> EBW
Trace-Mode:	Max hold
Analyzer function	Band power / channel power Interval > 26 dB EBW

Limits:

Radiated output power	Conducted output power
Conducted power + 6dBi antenna gain	The lesser one of 50mW or 4 dBm + 10 log Bandwidth 5.150-5.250 GHz 250mW or 11 dBm + 10 log Bandwidth 5.250-5.350 GHz 250mW or 11 dBm + 10 log Bandwidth 5.470-5.725 GHz 1W or 17 dBm + 10 log Bandwidth 5.725-5.825 GHz (where Bandwidth is the 26dB Bandwidth [MHz])

Result: OFDM / a – mode

OFDM / a – mode Channel	Maximum output power conducted [dBm]			
	Lowest 5180 MHz	Highest 5240 MHz	Lowest 5260 MHz	Highest 5320 MHz
+0.82 dB duty cycle correction	7.35	8.59	7.45	8.14
Channel	Lowest 5500 MHz	Middle 5600 MHz	Highest 5700 MHz	-/-
+0.82 dB duty cycle correction	7.71	7.71	7.86	-/-
Measurement uncertainty	± 1 dB			

Result: Passed

OFDM / a – mode Channel	Maximum output power radiated - EIRP [dBm]			
	Lowest 5180 MHz	Highest 5240 MHz	Lowest 5260 MHz	Highest 5320 MHz
+0.82 dB duty cycle correction	6.76	7.00	6.07	9.12
Channel	Lowest 5500 MHz	Middle 5600 MHz	Highest 5700 MHz	-/-
+0.82 dB duty cycle correction	6.82	7.74	7.62	-/-
Measurement uncertainty	± 3 dB			

Result: Passed

Result: OFDM / n – mode HT20

OFDM / n – mode HT20 Channel	Maximum output power conducted [dBm]			
	Lowest 5180 MHz	Highest 5240 MHz	Lowest 5260 MHz	Highest 5320 MHz
+0.82 dB duty cycle correction	7.12	8.06	8.29	8.06
Channel	Lowest 5500 MHz	Middle 5600 MHz	Highest 5700 MHz	-/-
+0.82 dB duty cycle correction	6.89	8.42	8.08	-/-
Measurement uncertainty	± 1 dB			

Result: Passed

OFDM / n – mode HT20 Channel	Maximum output power radiated - EIRP [dBm]			
	Lowest 5180 MHz	Highest 5240 MHz	Lowest 5260 MHz	Highest 5320 MHz
+0.82 dB duty cycle correction	6.53	6.47	6.91	9.04
Channel	Lowest 5500 MHz	Middle 5600 MHz	Highest 5700 MHz	-/-
+0.82 dB duty cycle correction	6.00	8.45	7.84	-/-
Measurement uncertainty	± 3 dB			

Result: Passed

Result: OFDM / n – mode HT40

OFDM / n – mode HT40 Channel	Maximum output power conducted [dBm]			
	Lowest 5190 MHz	Highest 5230 MHz	Lowest 5270 MHz	Highest 5310 MHz
+0.56 dB duty cycle correction	8.72	7.50	7.40	8.36
Channel	Lowest 5510 MHz	Middle 5590 MHz	Highest 5670 MHz	-/-
+0.56 dB duty cycle correction	8.35	8.15	8.71	-/-
Measurement uncertainty	± 1 dB			

Result: Passed

OFDM / n – mode HT40 Channel	Maximum output power radiated - EIRP [dBm]			
	Lowest 5190 MHz	Highest 5230 MHz	Lowest 5270 MHz	Highest 5310 MHz
+0.56 dB duty cycle correction	8.13	5.91	6.02	9.34
Channel	Lowest 5510 MHz	Middle 5590 MHz	Highest 5670 MHz	-/-
+0.56 dB duty cycle correction	7.46	8.18	8.47	-/-
Measurement uncertainty	± 3 dB			

Result: Passed

Plots: OFDM / a – mode

Plot 1: 5180 MHz

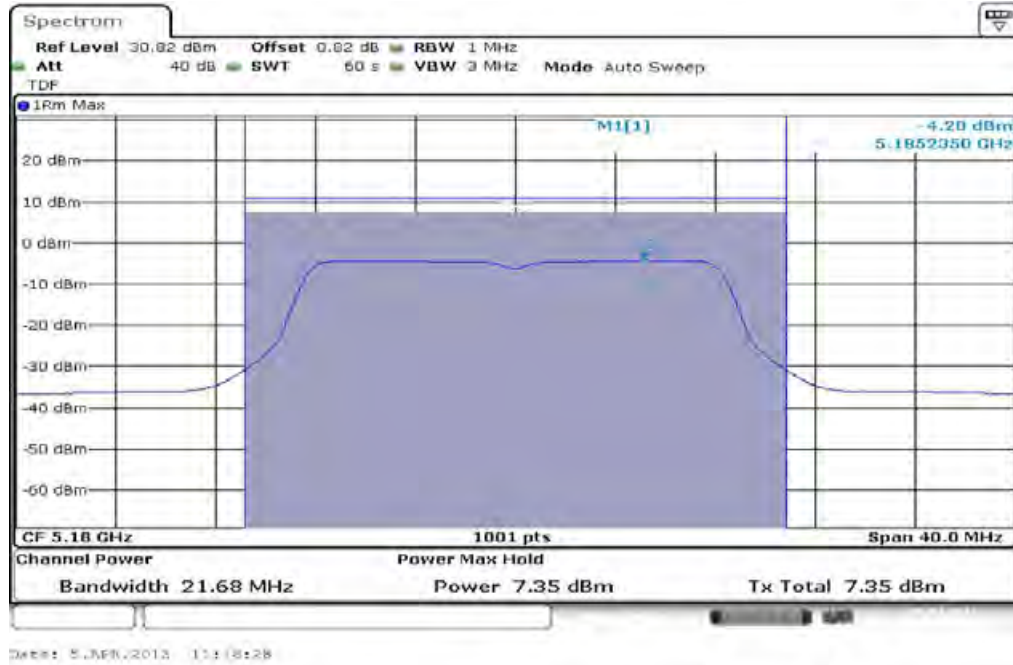

Plot 2: 5240 MHz

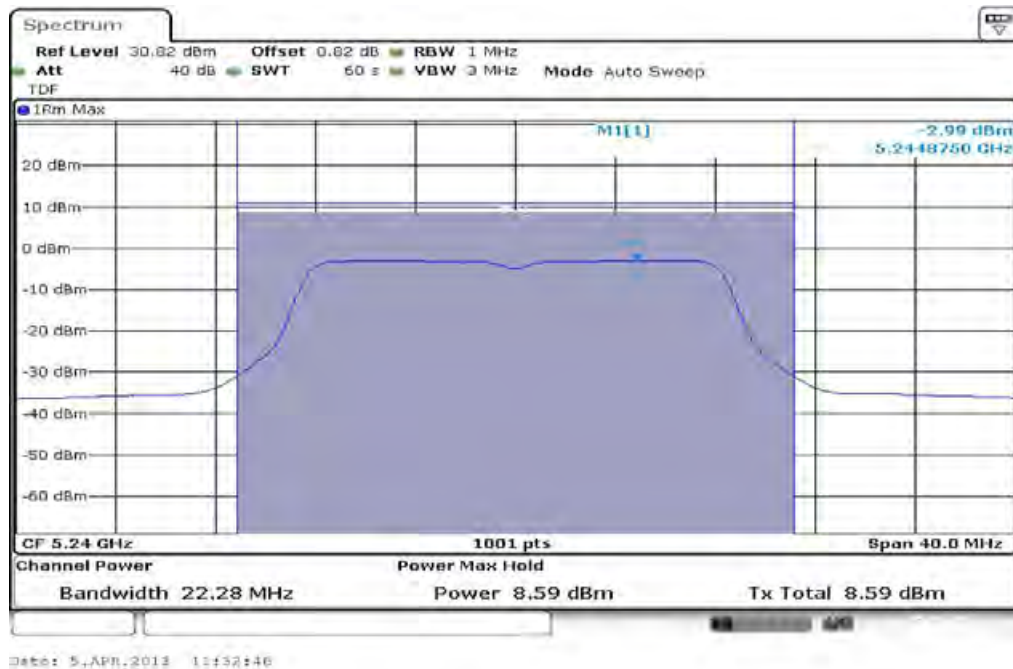

Plot 3: 5260 MHz

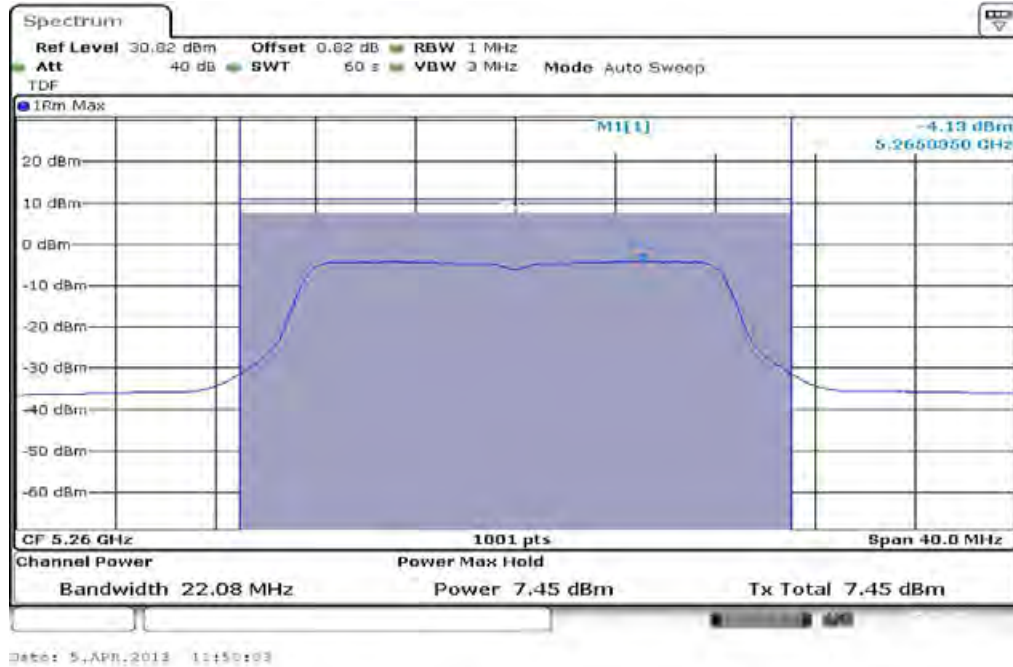

Plot 4: 5320 MHz

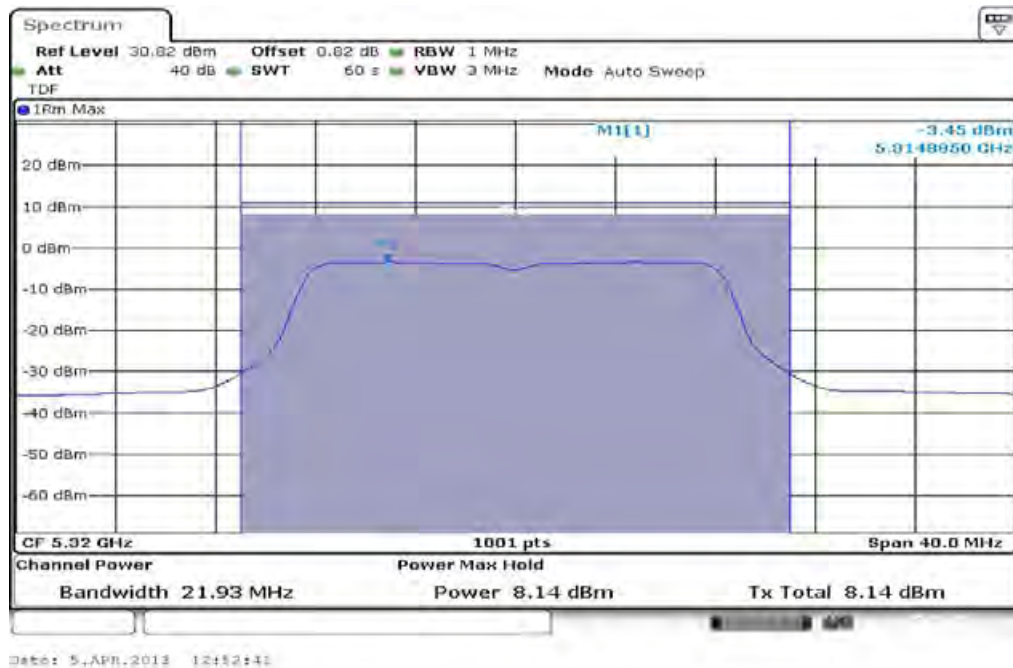

Plot 5: 5500 MHz

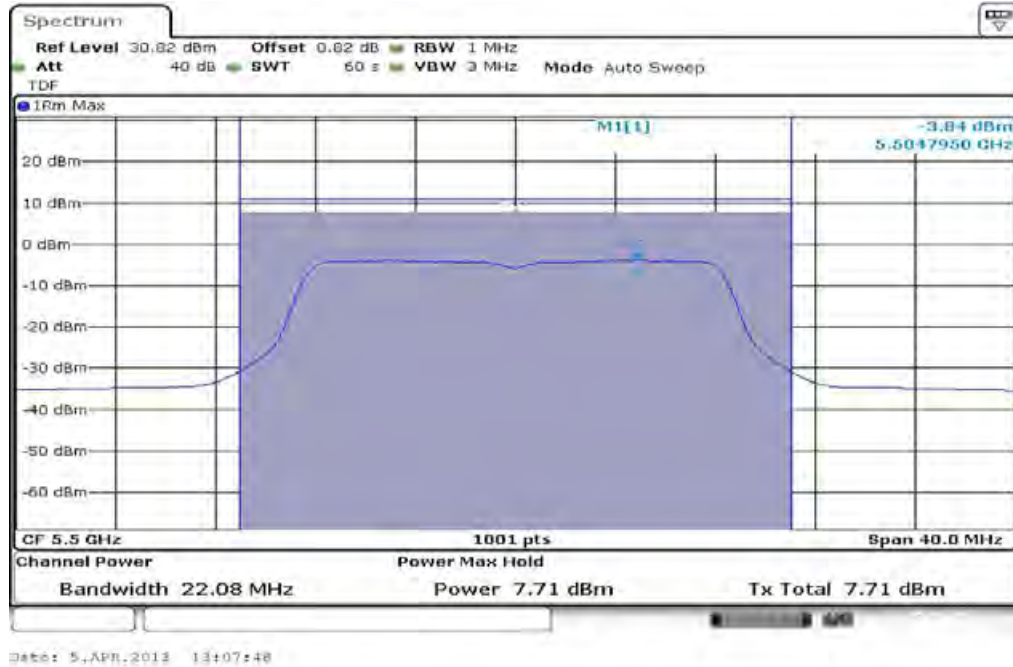

Plot 6: 5600 MHz

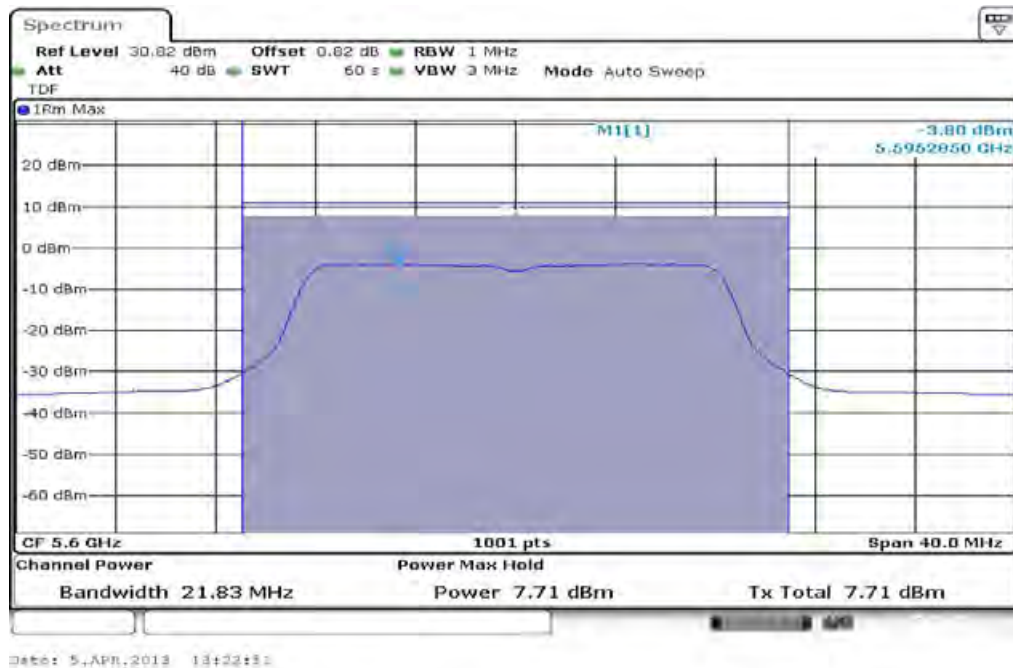

Plot 7: 5700 MHz

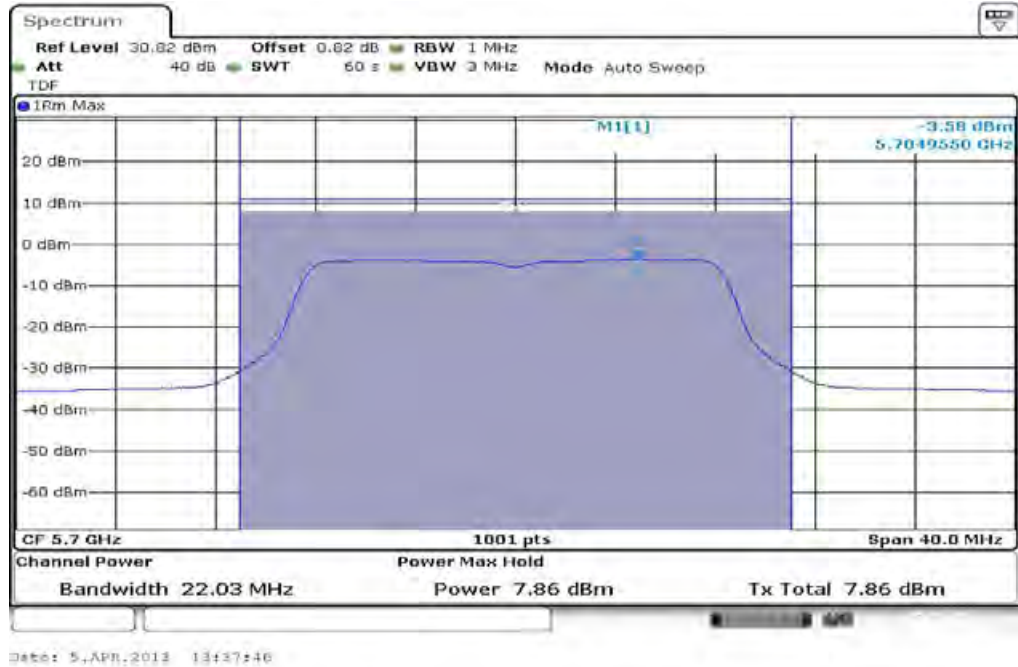

Plots: OFDM / n – mode HT20

Plot 1: 5180 MHz

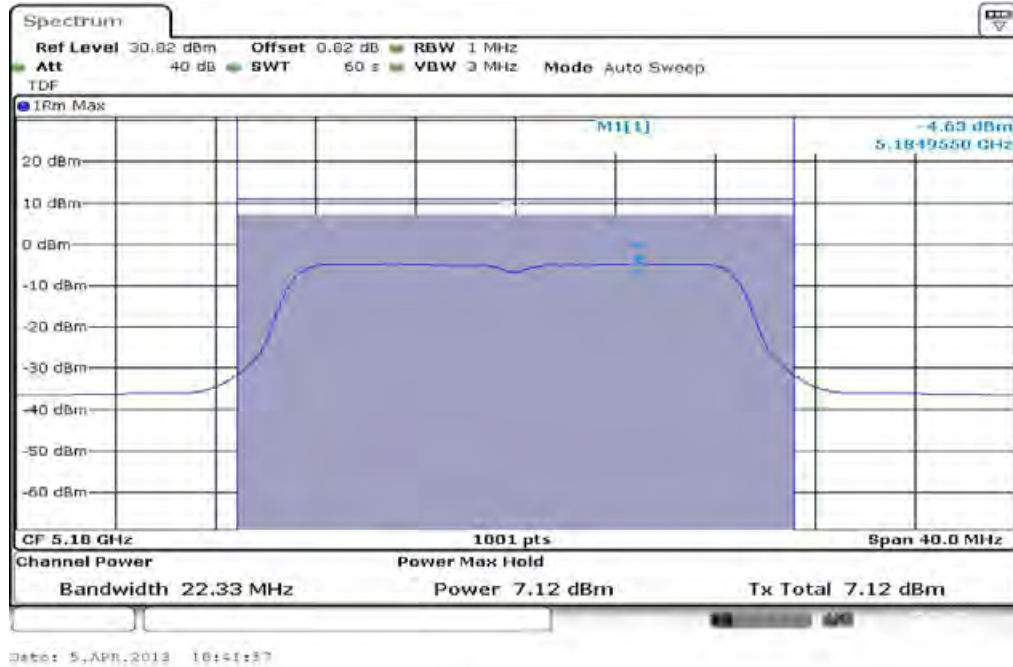

Plot 2: 5240 MHz

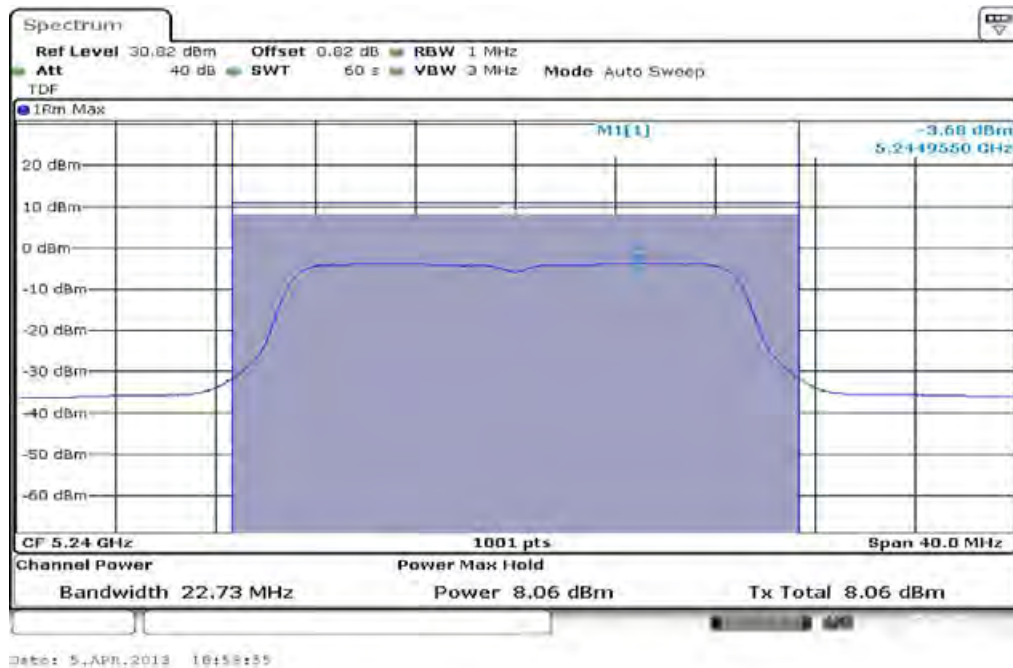

Plot 3: 5260 MHz

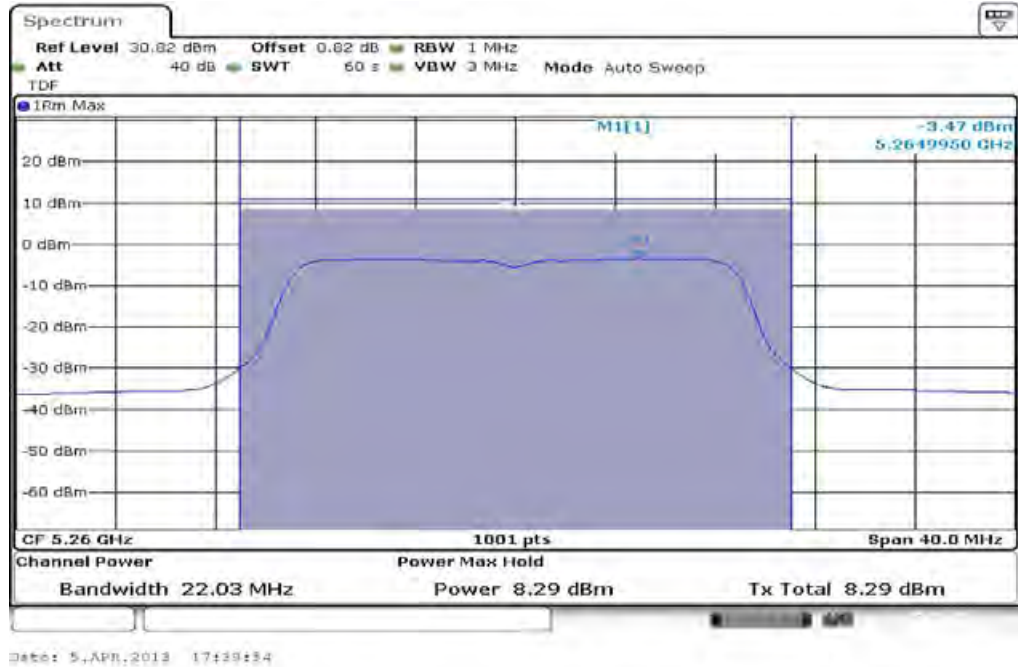

Plot 4: 5320 MHz

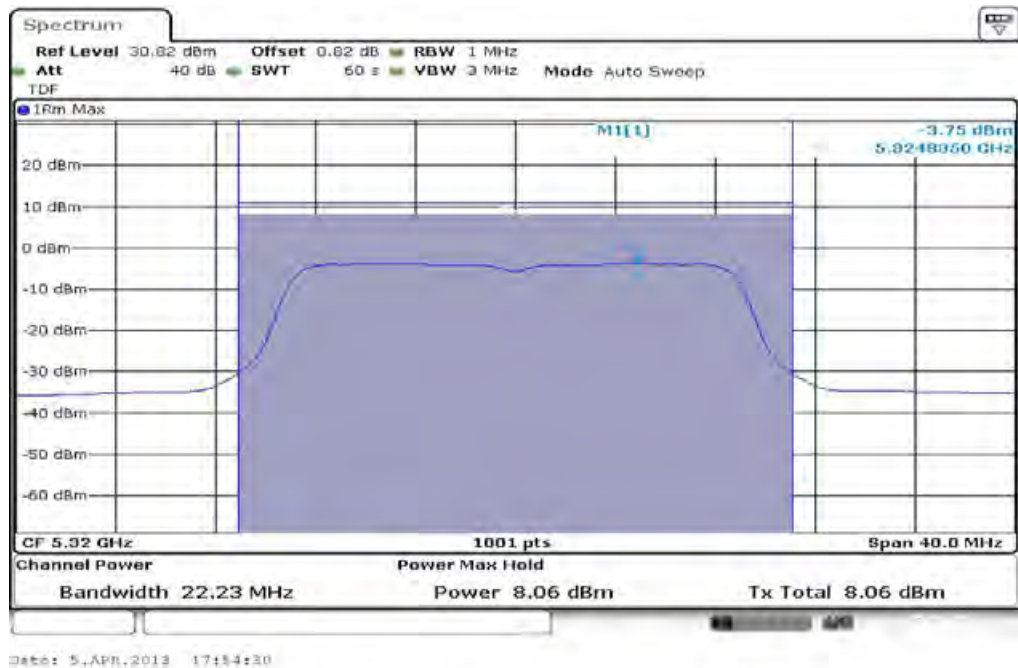

Plot 5: 5500 MHz

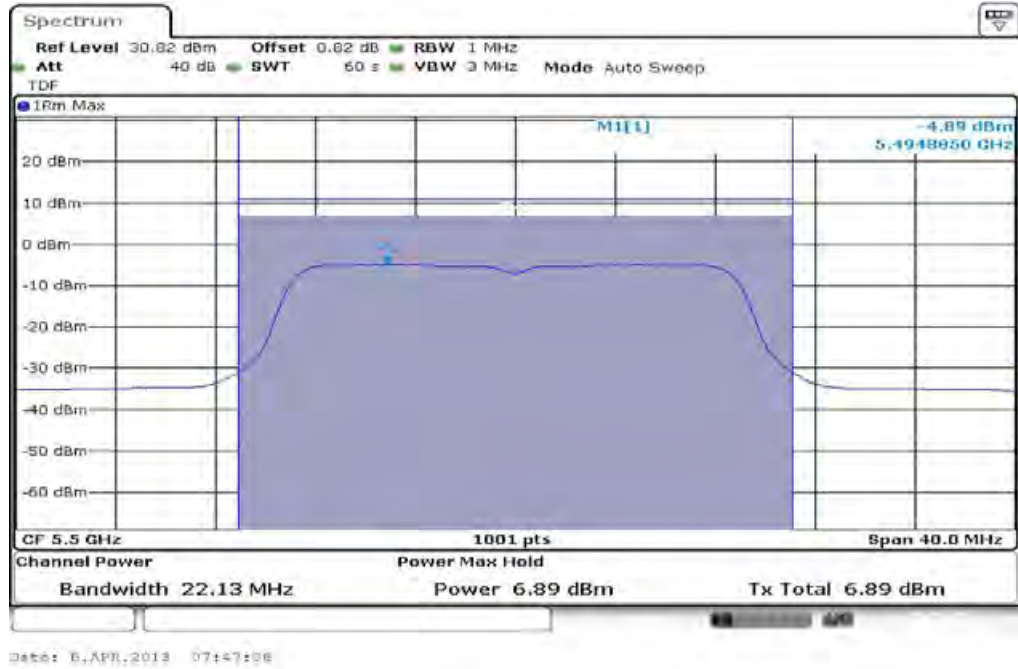

Plot 6: 5600 MHz

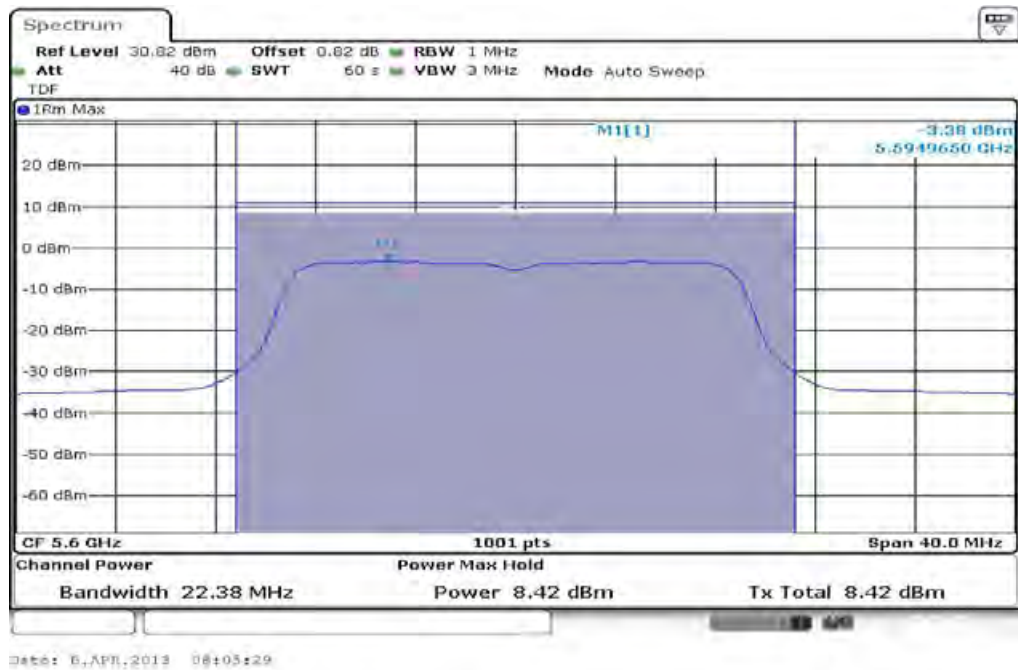

Plot 7: 5700 MHz

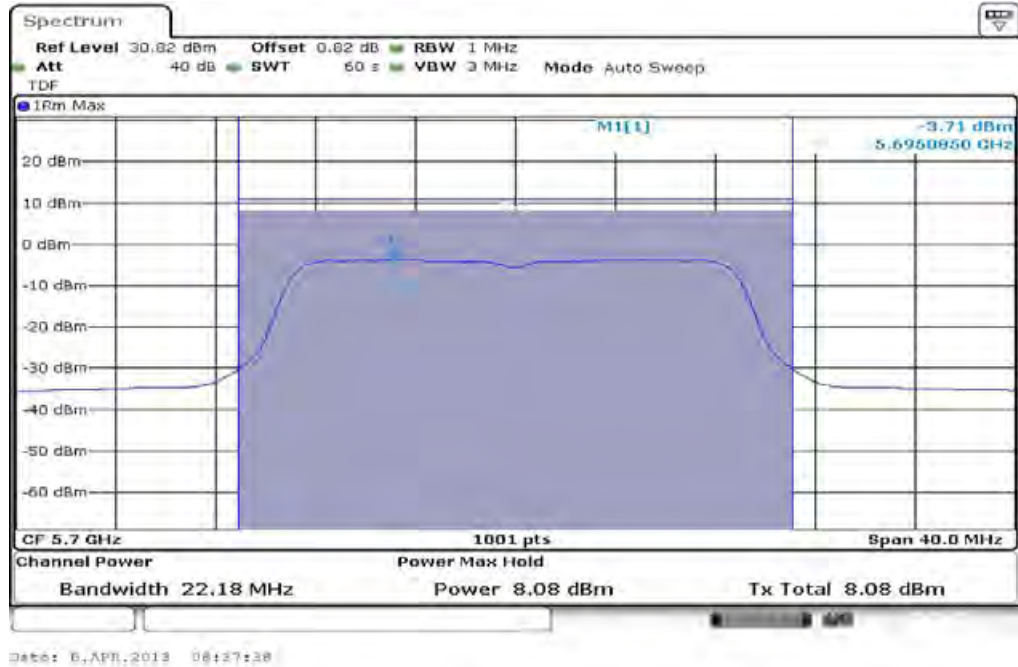

Plots: OFDM / n – mode HT40

Plot 1: 5190 MHz

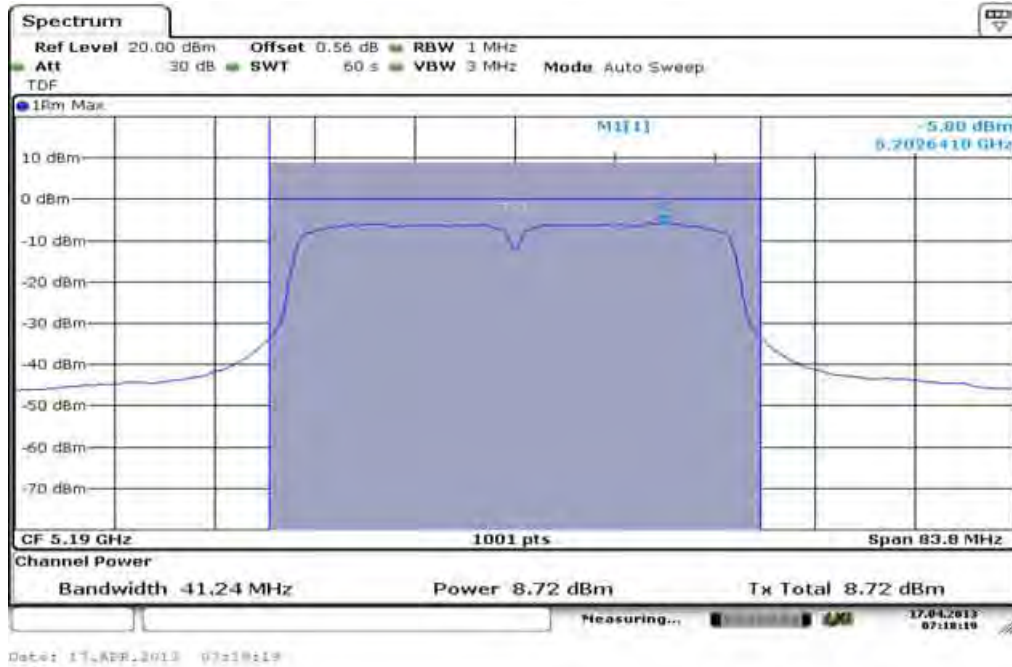

Plot 2: 5230 MHz

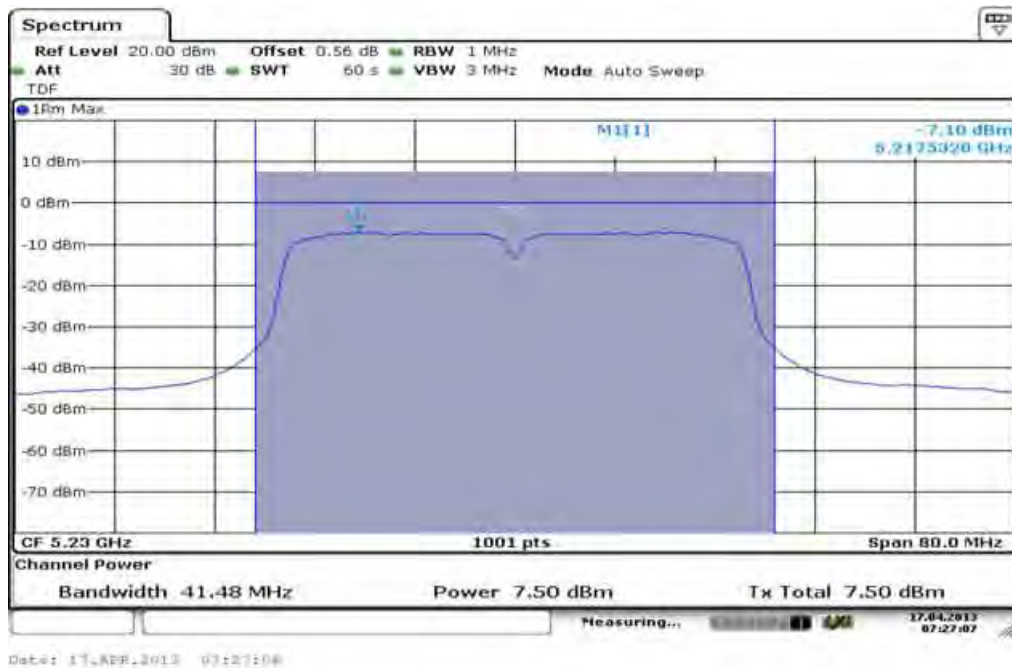

Plot 3: 5270 MHz

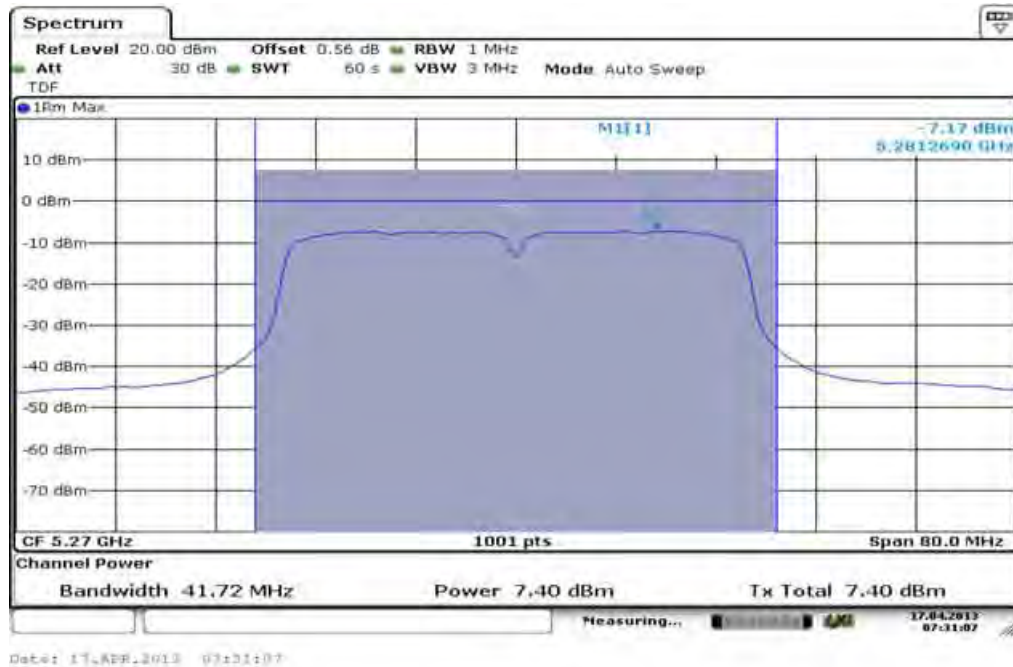

Plot 4: 5310 MHz

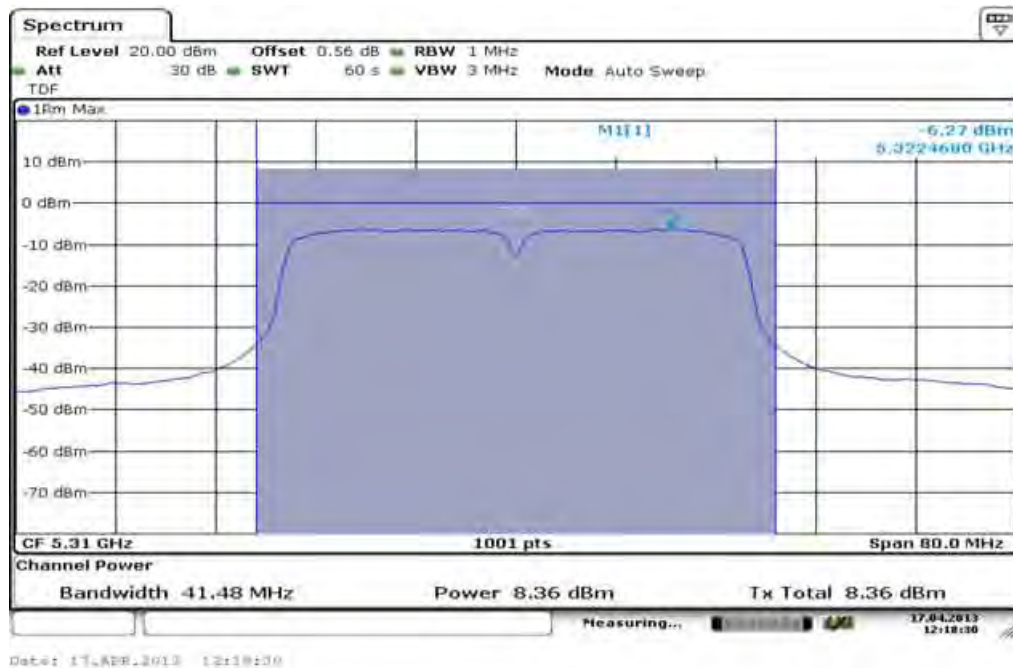

Plot 5: 5510 MHz

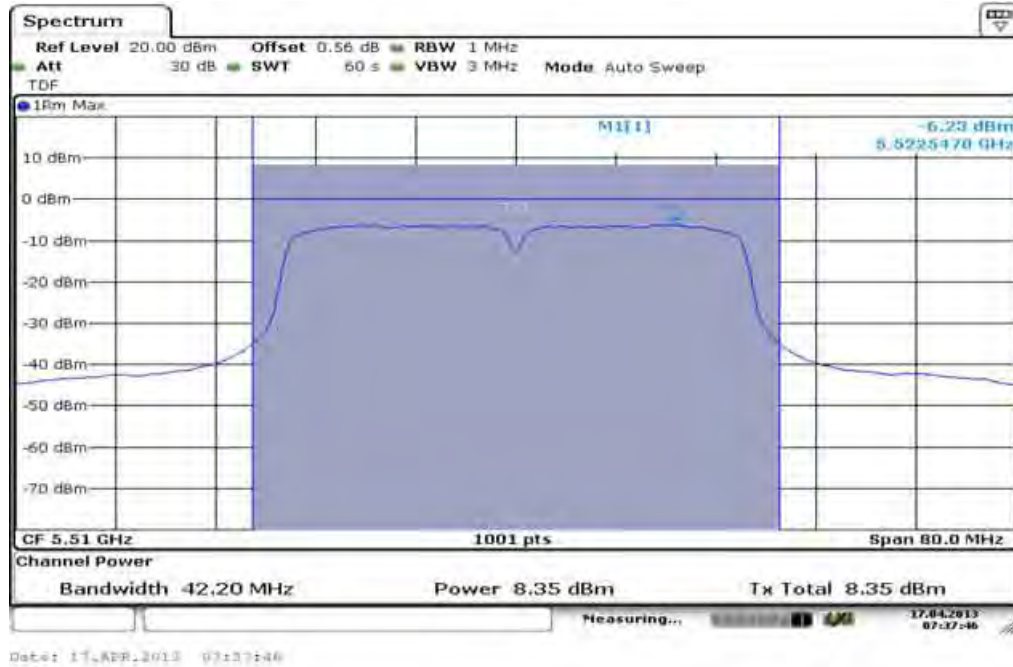

Plot 6: 5590 MHz

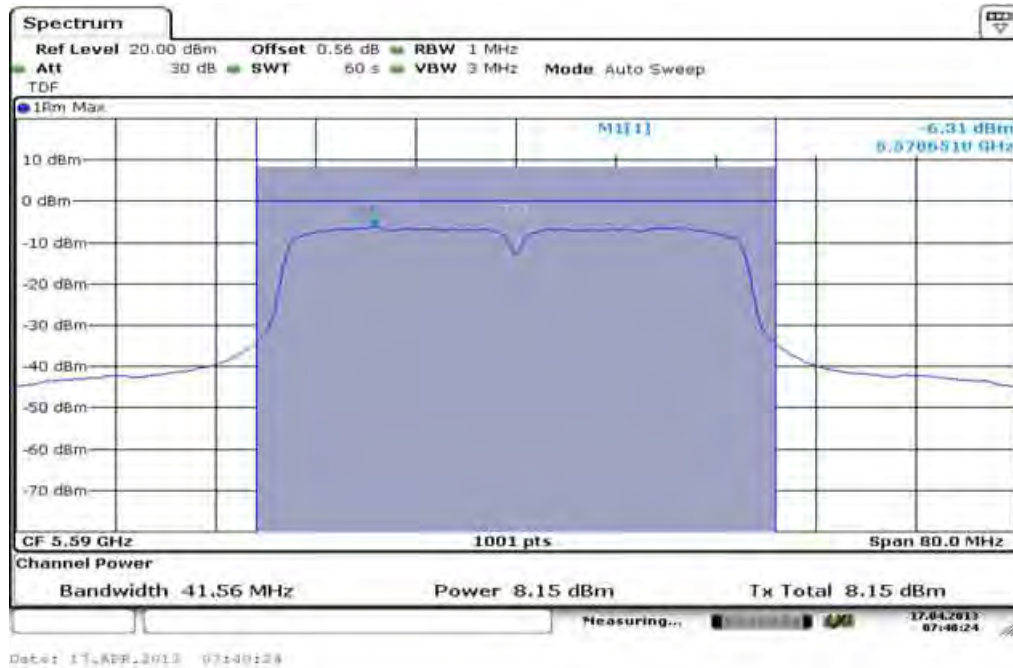

Plot 7: 5670 MHz

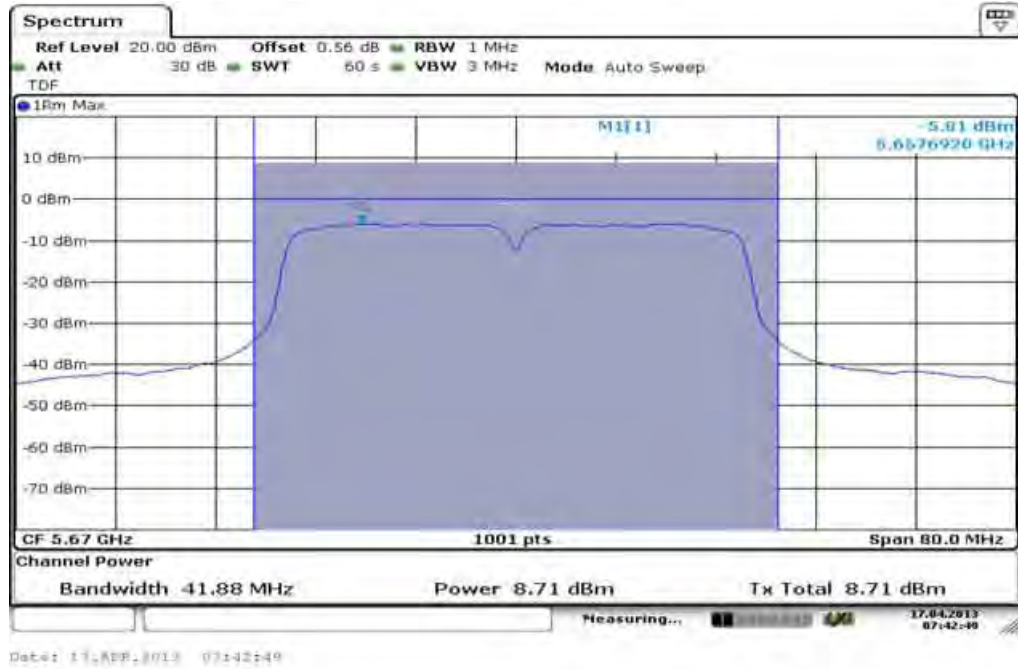

9.5 Power spectral density

Description:

Measurement of the power spectral density of a digital modulated system. The measurement is repeated at the lowest, middle and highest channel.

Measurement:

Measurement parameter	
Detector:	RMS
Sweep time:	60 s / 120 s
Resolution bandwidth:	1 MHz
Video bandwidth:	≥ 3 MHz
Span:	> EBW
Trace-Mode:	Max hold

Limits:

Power Spectral Density
power spectral density conducted ≤ 4 dBm in any 1 MHz band (band 5150 – 5250 MHz)
power spectral density conducted ≤ 11 dBm in any 1 MHz band (band 5250 – 5350 MHz)
power spectral density conducted ≤ 11 dBm in any 1 MHz band (band 5470 – 5725 MHz)
power spectral density conducted ≤ 17 dBm in any 1 MHz band (band 5725 – 5825 MHz)

Result: OFDM / a – mode

OFDM / a – mode Channel	Power Spectral density [dBm/MHz]			
	Lowest 5180 MHz	Highest 5240 MHz	Lowest 5260 MHz	Highest 5320 MHz
+0.82 dB duty cycle correction	-4.04	-2.79	-3.89	-3.32
Channel	Lowest 5500 MHz	Middle 5600 MHz	Highest 5700 MHz	-/-
+0.82 dB duty cycle correction	-3.67	-3.51	-3.43	-/-
Measurement uncertainty	± 1 dB			

Result: Passed

Result: OFDM / n – mode HT20

OFDM / n – mode HT20 Channel	Power Spectral density [dBm/MHz]			
	Lowest 5180 MHz	Highest 5240 MHz	Lowest 5260 MHz	Highest 5320 MHz
+0.82 dB duty cycle correction	-4.40	-3.57	-3.26	-3.51
Channel	Lowest 5500 MHz	Middle 5600 MHz	Highest 5700 MHz	-/-
+0.82 dB duty cycle correction	-4.66	-3.20	-3.39	-/-
Measurement uncertainty	± 1 dB			

Result: Passed

Result: OFDM / n – mode HT40

OFDM / n – mode HT40 Channel	Power Spectral density [dBm/MHz]			
	Lowest 5190 MHz	Highest 5230 MHz	Lowest 5270 MHz	Highest 5310 MHz
+0.56 dB duty cycle correction	-5.10	-6.29	-4.82	-6.34
Channel	Lowest 5510 MHz	Middle 5590 MHz	Highest 5670 MHz	-/-
+0.56 dB duty cycle correction	-3.43	-4.69	-5.74	-/-
Measurement uncertainty	± 1 dB			

Result: Passed

Plots: OFDM / a – mode

Plot 1: 5180 MHz



Plot 2: 5240 MHz



Plot 3: 5260 MHz



Plot 4: 5320 MHz



Plot 5: 5500 MHz

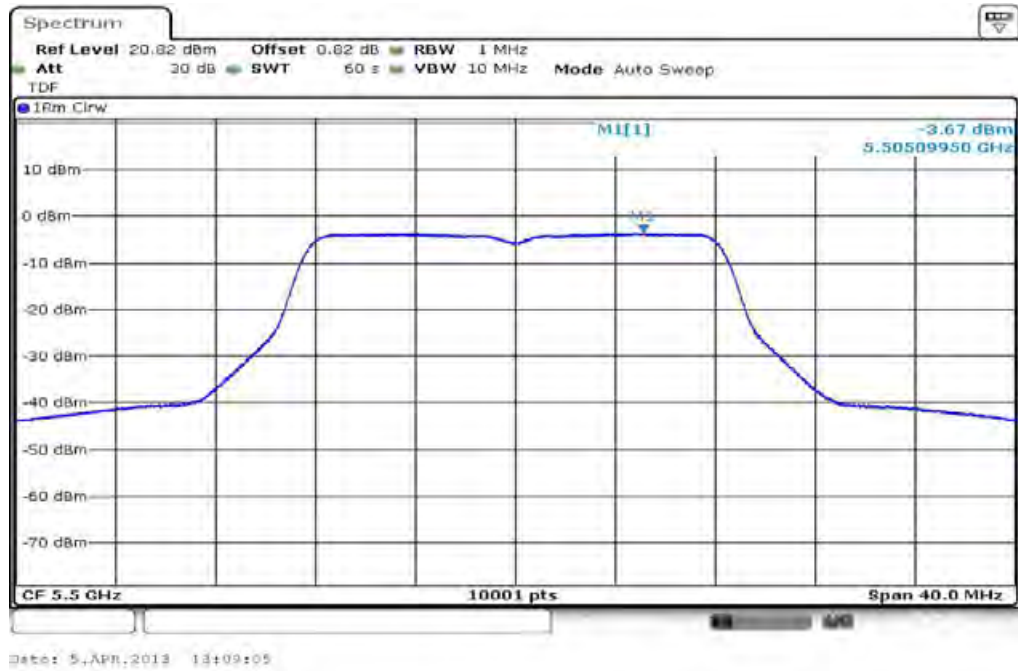

Plot 6: 5600 MHz

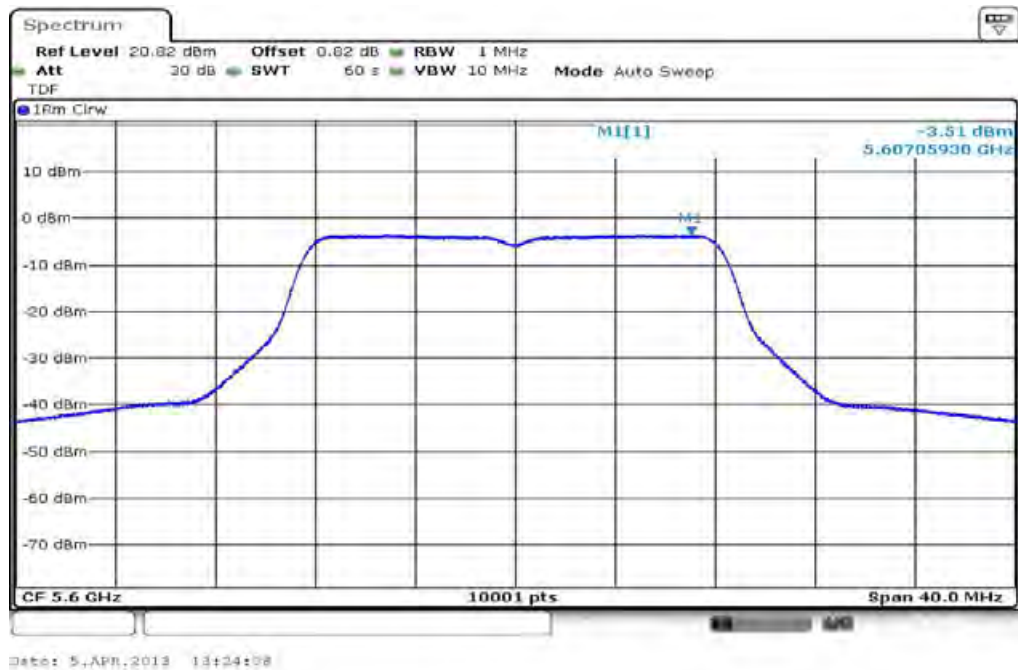

Plot 7: 5700 MHz



Date: 5, APR, 2013 13:29:03

Plots: OFDM / n – mode HT20

Plot 1: 5180 MHz



Plot 2: 5240 MHz



Plot 3: 5260 MHz



Plot 4: 5320 MHz

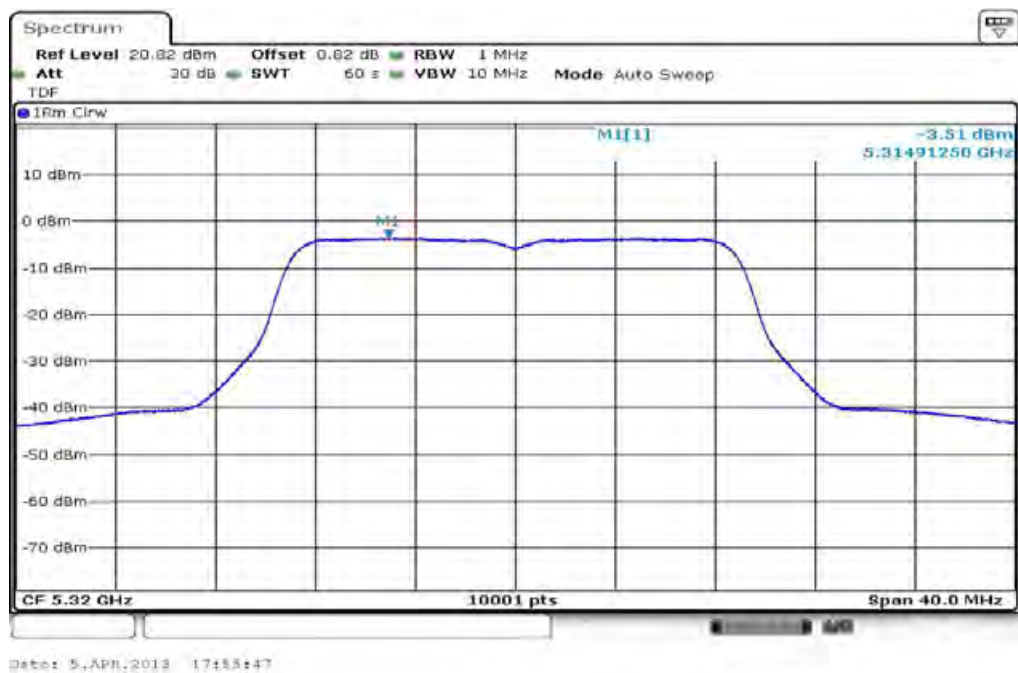

Plot 5: 5500 MHz



Plot 6: 5600 MHz

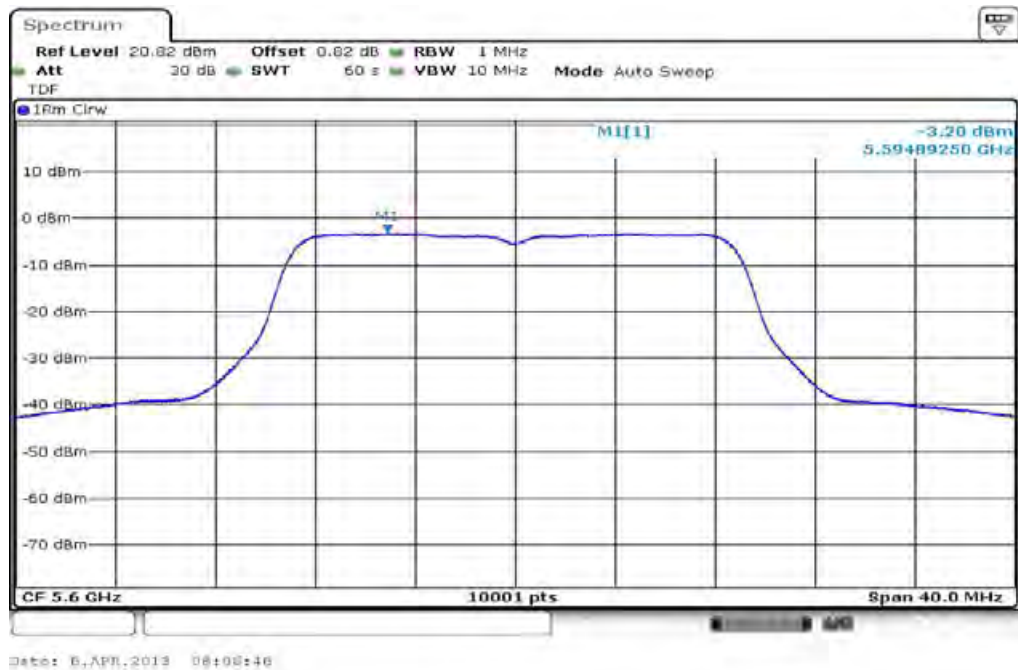

Plot 7: 5700 MHz



Plots: OFDM / n – mode HT40

Plot 1: 5190 MHz



Plot 2: 5230 MHz



Plot 3: 5270 MHz



Plot 4: 5310 MHz



Plot 5: 5510 MHz



Plot 6: 5590 MHz



Plot 7: 5670 MHz



9.6 Spectrum bandwidth – 26 dB bandwidth

Description:

Measurement of the 26 dB bandwidth of the modulated signal.

Measurement:

Measurement parameter	
Detector:	Peak
Sweep time:	Auto
Resolution bandwidth:	1% EBW
Video bandwidth:	≥ RBW
Span:	> complete signal!
Trace-Mode:	Max hold

Limits:

Spectrum Bandwidth – 26 dB Bandwidth
-/-

Result: OFDM / a – mode

OFDM / a – mode Channel	26 dB BANDWIDTH [MHz]			
	Lowest 5180 MHz	Highest 5240 MHz	Lowest 5260 MHz	Highest 5320 MHz
	21.68	22.28	22.08	21.93
Channel	Lowest 5500 MHz	Middle 5600 MHz	Highest 5700 MHz	-/-
	22.08	21.83	22.03	-/-
Measurement uncertainty	± 1 dB			

Result: Passed

Result: OFDM / n – mode HT20

OFDM / n – mode HT20 Channel	26 dB BANDWIDTH [MHz]			
	Lowest 5180 MHz	Highest 5240 MHz	Lowest 5260 MHz	Highest 5320 MHz
	22.33	22.73	22.03	22.23
Channel	Lowest 5500 MHz	Middle 5600 MHz	Highest 5700 MHz	-/-
	22.13	22.38	22.18	-/-
Measurement uncertainty	± 1 dB			

Result: Passed

Result: OFDM / n – mode HT40

OFDM / n – mode HT40 Channel	26 dB BANDWIDTH [MHz]			
	Lowest 5190 MHz	Highest 5230 MHz	Lowest 5270 MHz	Highest 5310 MHz
	41.24	41.48	41.72	41.48
Channel	Lowest 5510 MHz	Middle 5590 MHz	Highest 5670 MHz	-/-
	42.20	41.56	41.88	-/-
Measurement uncertainty	± 1 dB			

Result: Passed

Plots: OFDM / a – mode

Plot 1: 5180 MHz

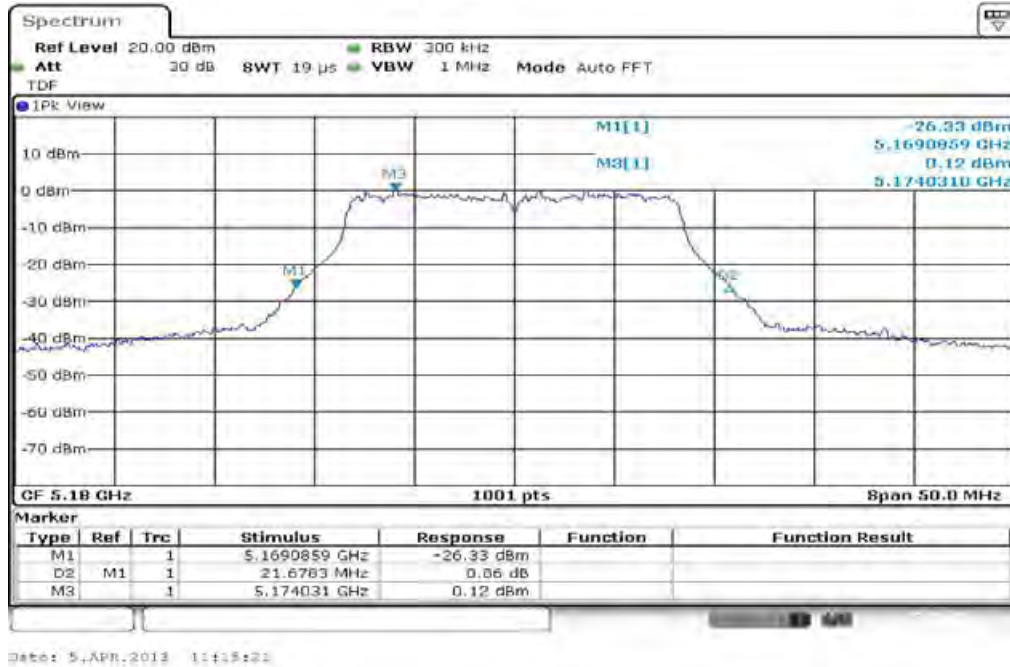

Plot 2: 5240 MHz

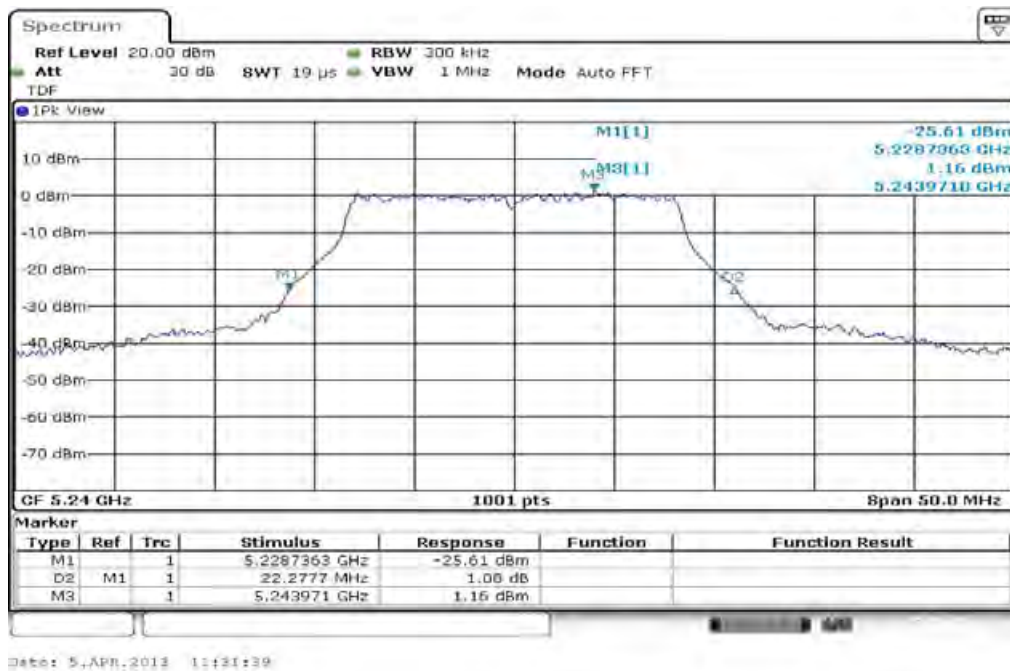

Plot 3: 5260 MHz

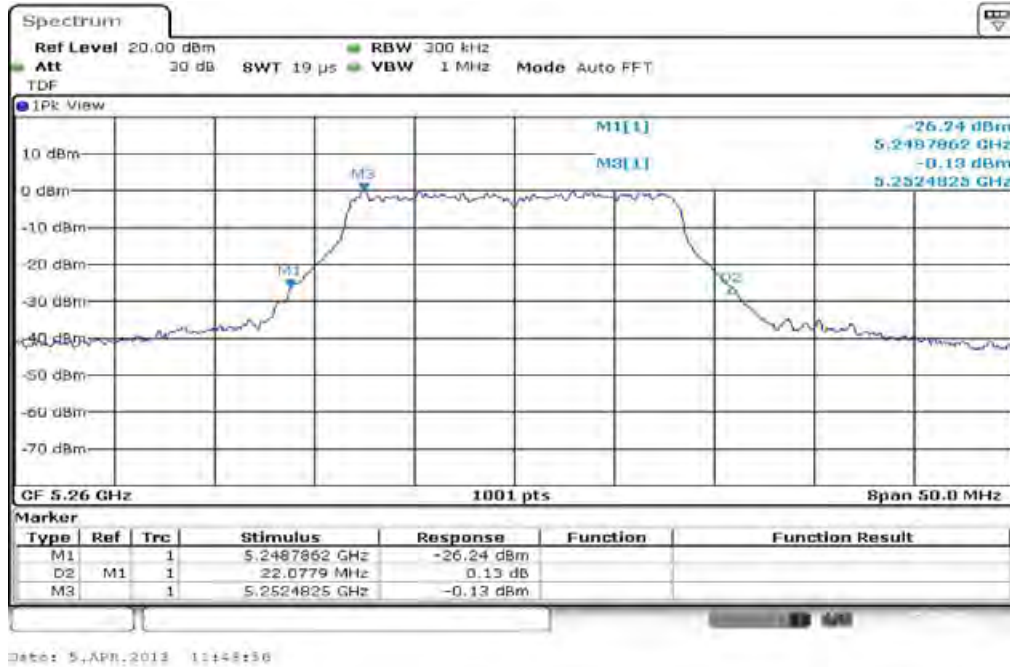

Plot 4: 5320 MHz

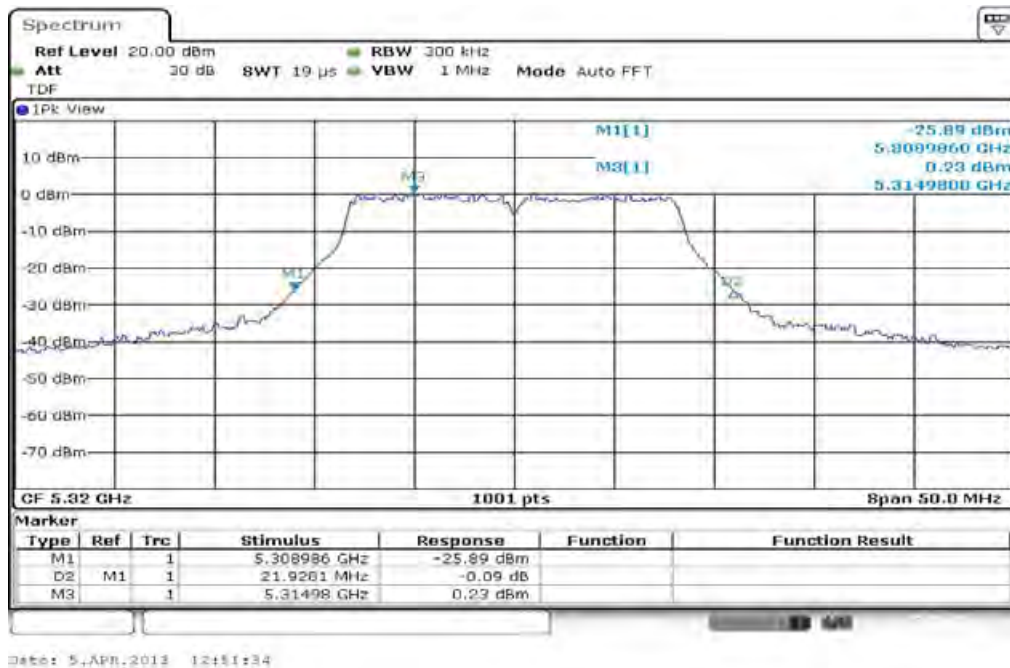

Plot 5: 5500 MHz

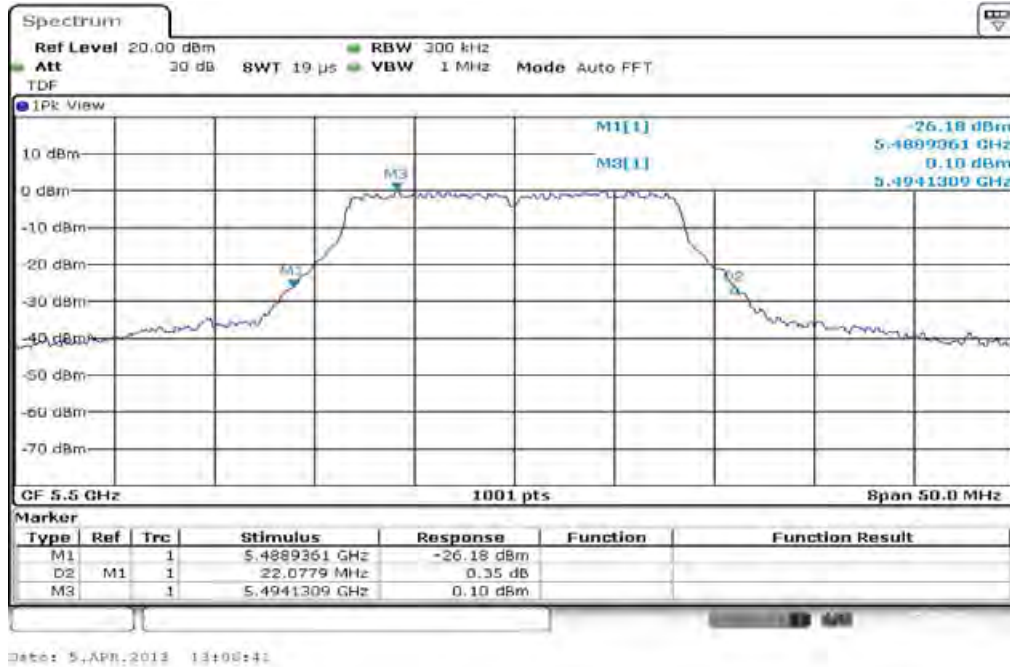

Plot 6: 5600 MHz



Plot 7: 5700 MHz

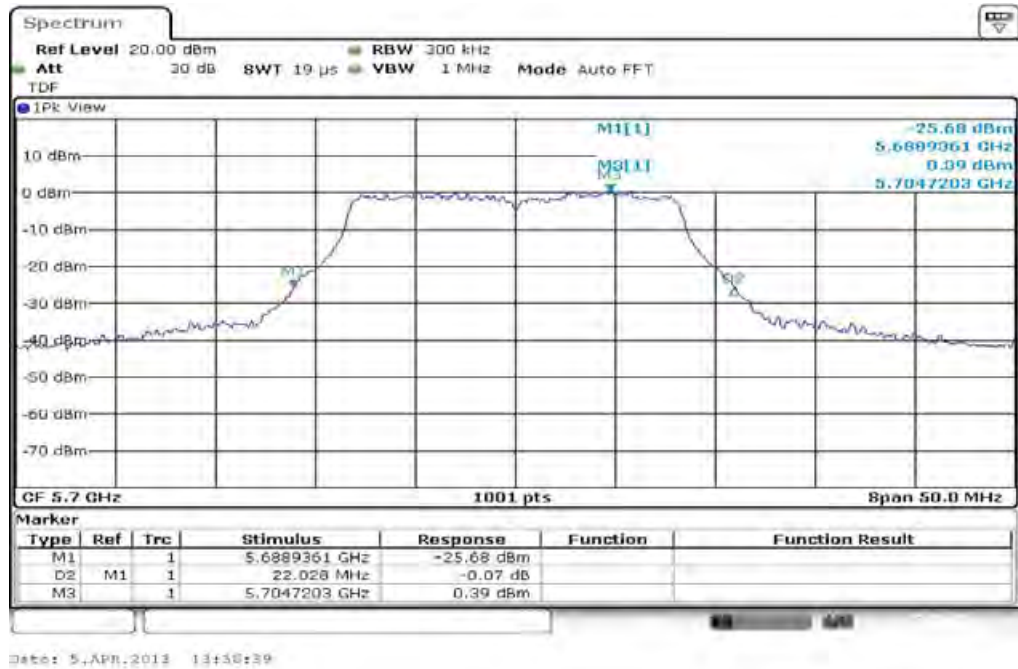

Plots: OFDM / n – mode HT20

Plot 1: 5180 MHz

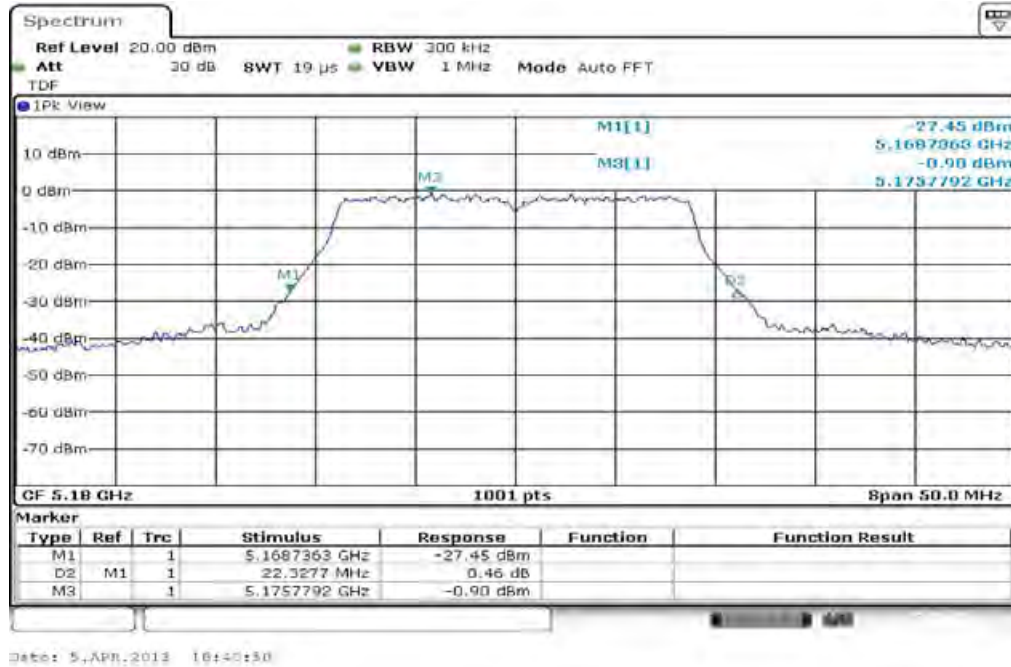

Plot 2: 5240 MHz

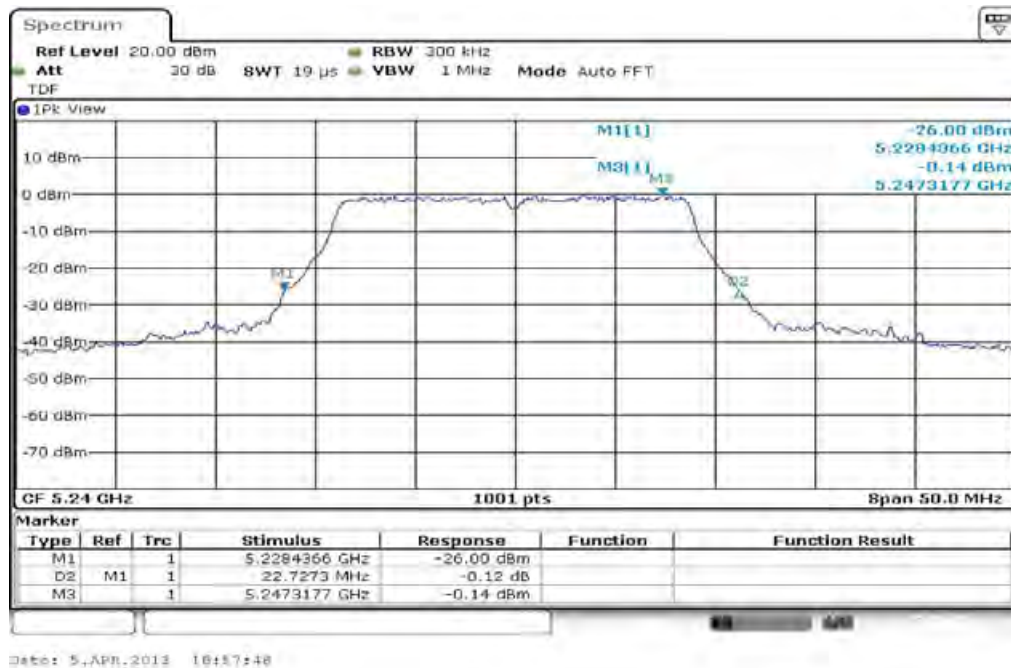

Plot 3: 5260 MHz

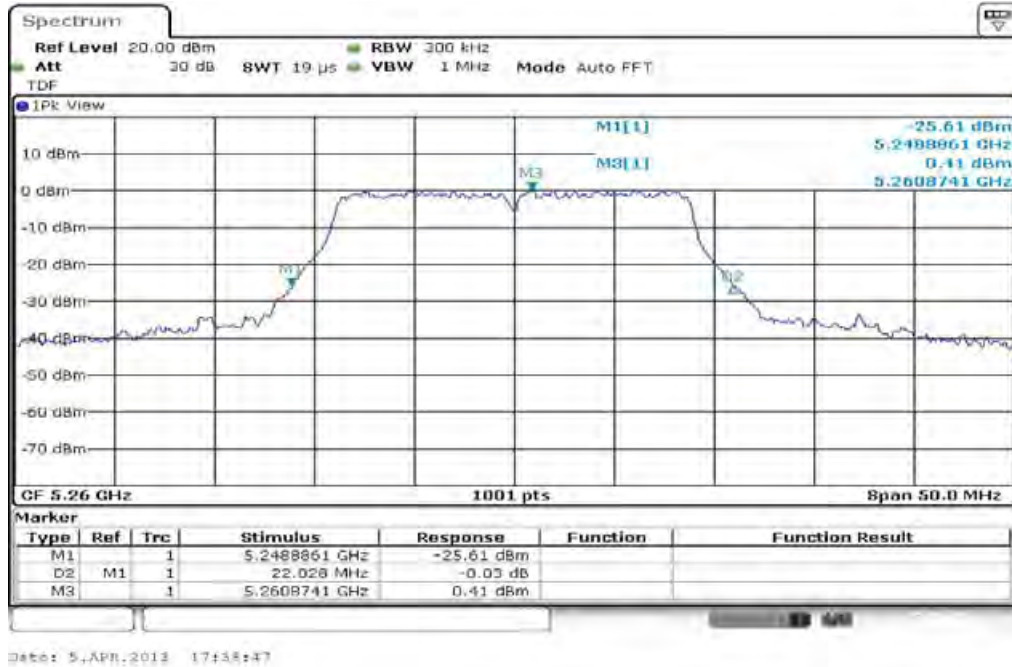

Plot 4: 5320 MHz

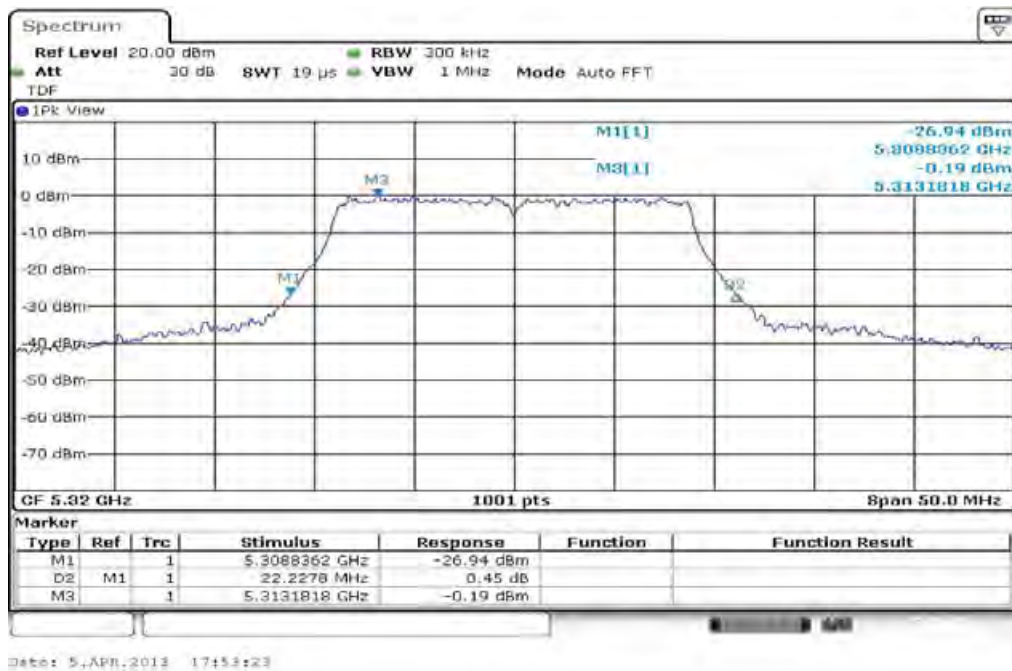

Plot 5: 5500 MHz

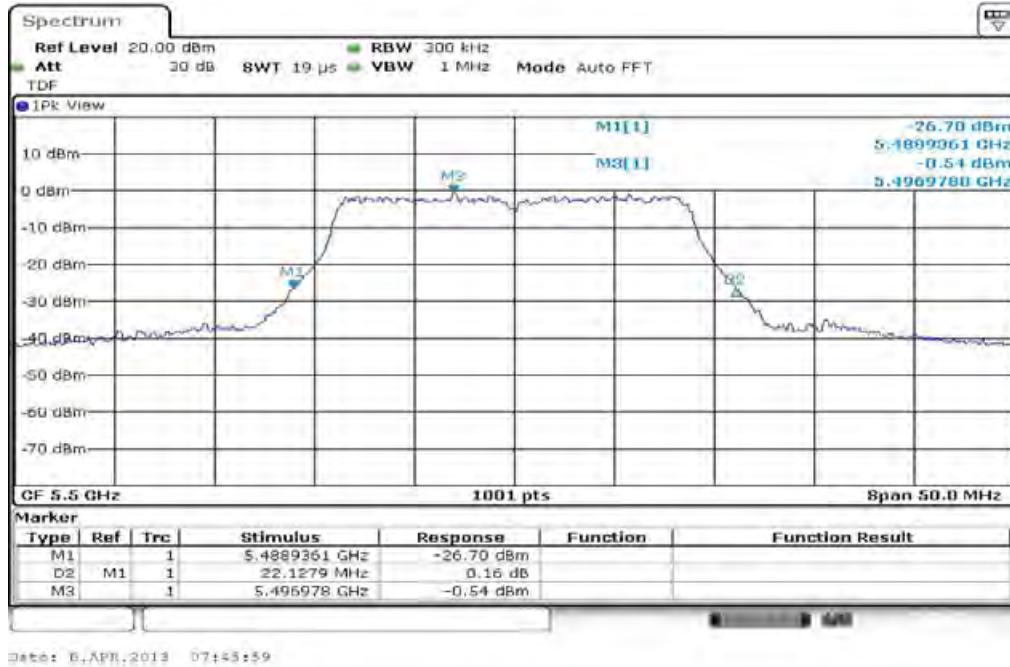

Plot 6: 5600 MHz

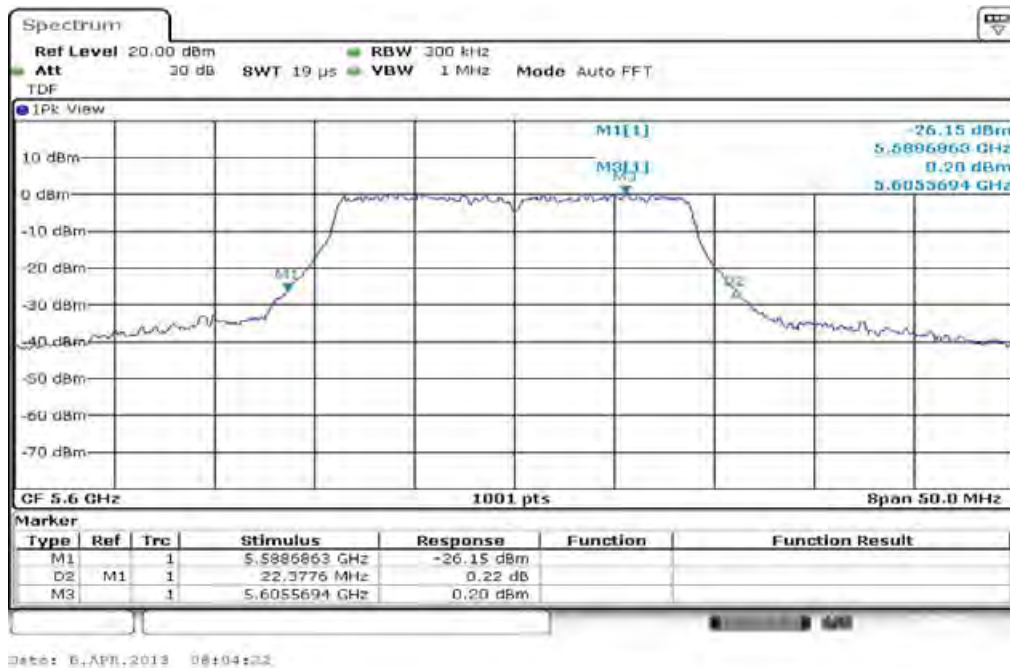

Plot 7: 5700 MHz



Plots: OFDM / n – mode HT40

Plot 1: 5190 MHz

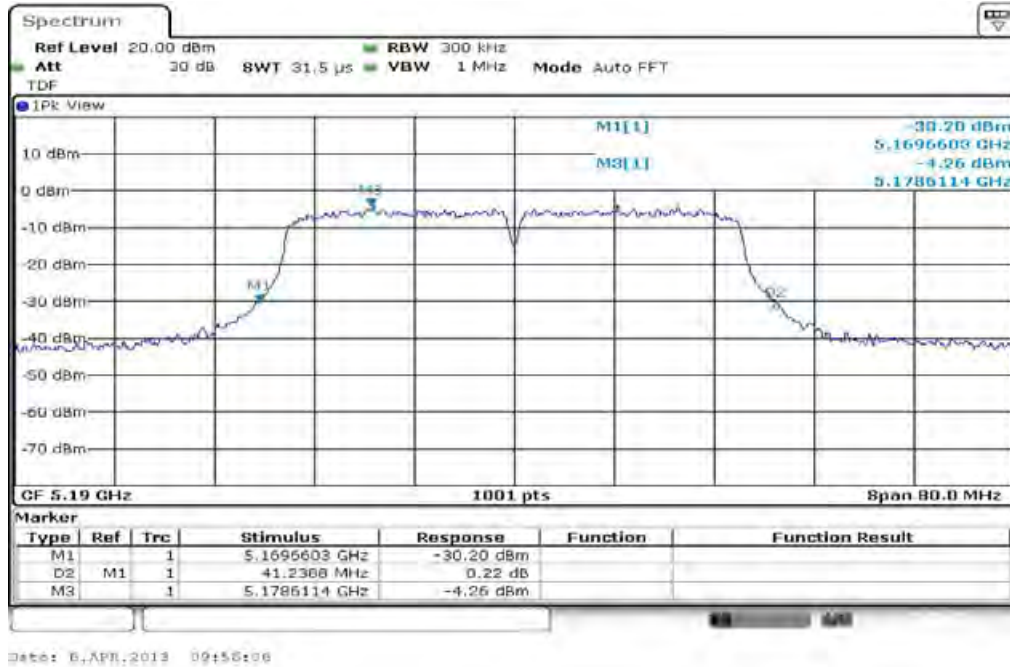

Plot 2: 5230 MHz

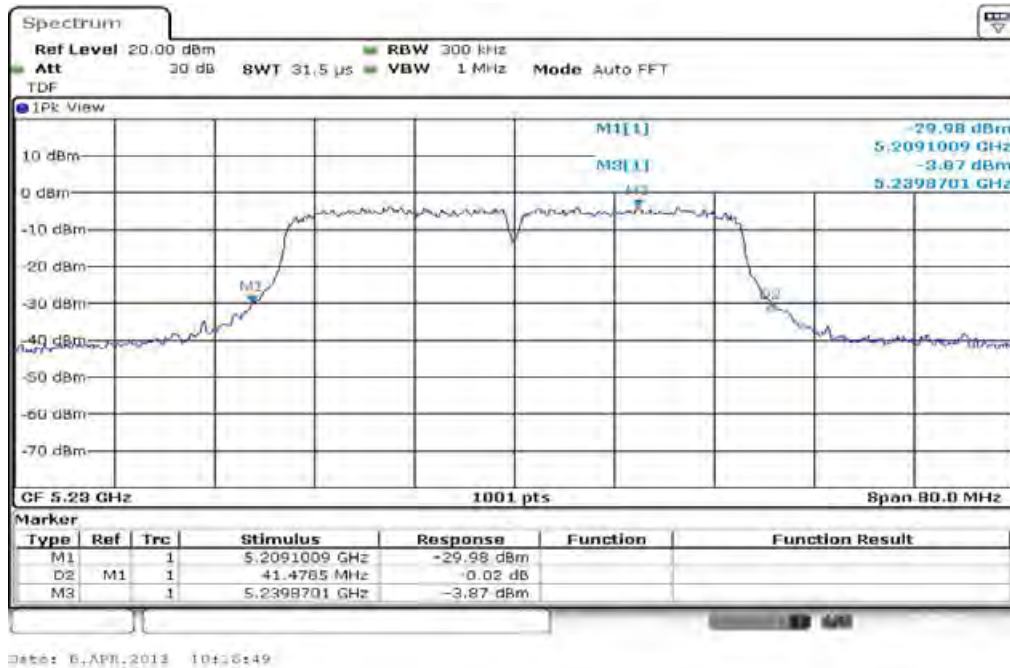

Plot 3: 5270 MHz



Plot 4: 5310 MHz



Plot 5: 5510 MHz



Plot 6: 5590 MHz

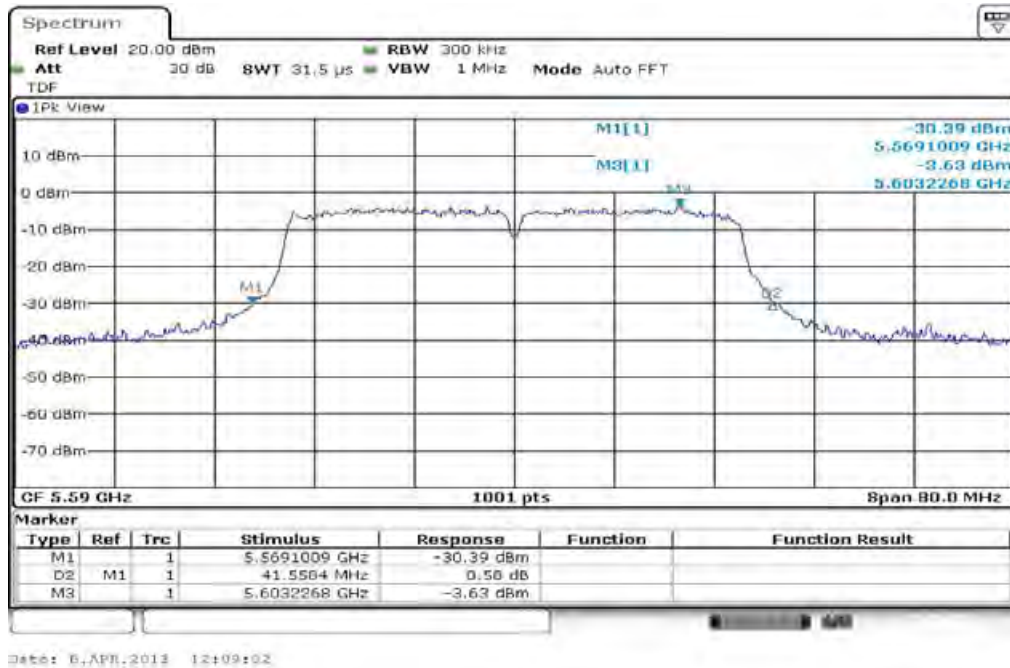

Plot 7: 5670 MHz



9.7 Peak excursion measurements

Description:

Peak to average value.

Measurement:

Measurement parameter	
Detector:	Peak
Sweep time:	60 s / 120 s
Resolution bandwidth:	1 MHz
Video bandwidth:	≥ 3 MHz
Span:	> Complete signal
Trace-Mode:	Max hold

Limits:

Peak excursion value
Does not exceed 13 dB.

Results:

Modulation OFDM / a – mode	Peak excursion value		
	Channel	5180 MHz	-/-
RMS	-4.04	-/-	-2.79
Peak	6.73	-/-	7.99
Peak excursion value	10.77	-/-	10.78
Channel	5260 MHz	-/-	5320 MHz
RMS	-3.89	-/-	-3.32
Peak	7.61	-/-	8.98
Peak excursion value	11.50	-/-	12.30
Channel	5500 MHz	5600 MHz	5700 MHz
RMS	-3.67	-3.51	-3.43
Peak	7.17	7.91	8.14
Peak excursion value	10.84	11.42	11.57
Measurement uncertainty	± 1 dB		

Result: Passed

Results:

Modulation OFDM / n – mode HT20	Peak excursion value		
	Channel	5180 MHz	5240 MHz
Channel	5180 MHz	-/-	5240 MHz
RMS	-4.40	-/-	-3.57
Peak	6.13	-/-	7.94
Peak excursion value	10.53	-/-	11.51
Channel	5260 MHz	-/-	5320 MHz
RMS	-3.26	-/-	-3.51
Peak	7.83	-/-	7.34
Peak excursion value	11.09	-/-	10.85
Channel	5500 MHz	5600 MHz	5700 MHz
RMS	-4.66	-3.20	-3.39
Peak	6.54	7.52	7.37
Peak excursion value	11.20	10.72	3.98
Measurement uncertainty	± 1 dB		

Result: Passed

Results:

Modulation OFDM / n – mode HT40	Peak excursion value		
	Channel	5190 MHz	5270 MHz
Channel	5190 MHz	5230 MHz	5270 MHz
RMS	-5.10	-6.29	-4.82
Peak	2.82	3.66	6.01
Peak excursion value	7.92	9.95	10.83
Channel	5310 MHz	5510 MHz	5590 MHz
RMS	-6.34	-3.43	-4.69
Peak	5.38	7.25	4.18
Peak excursion value	11.72	10.68	8.87
Channel	5670 MHz	-/-	-/-
RMS	-5.74	-/-	-/-
Peak	6.25	-/-	-/-
Peak excursion value	11.99	-/-	-/-
Measurement uncertainty	± 1 dB		

Result: Passed

Plots: OFDM / a – mode

Plot 1: 5180 MHz



Plot 2: 5240 MHz

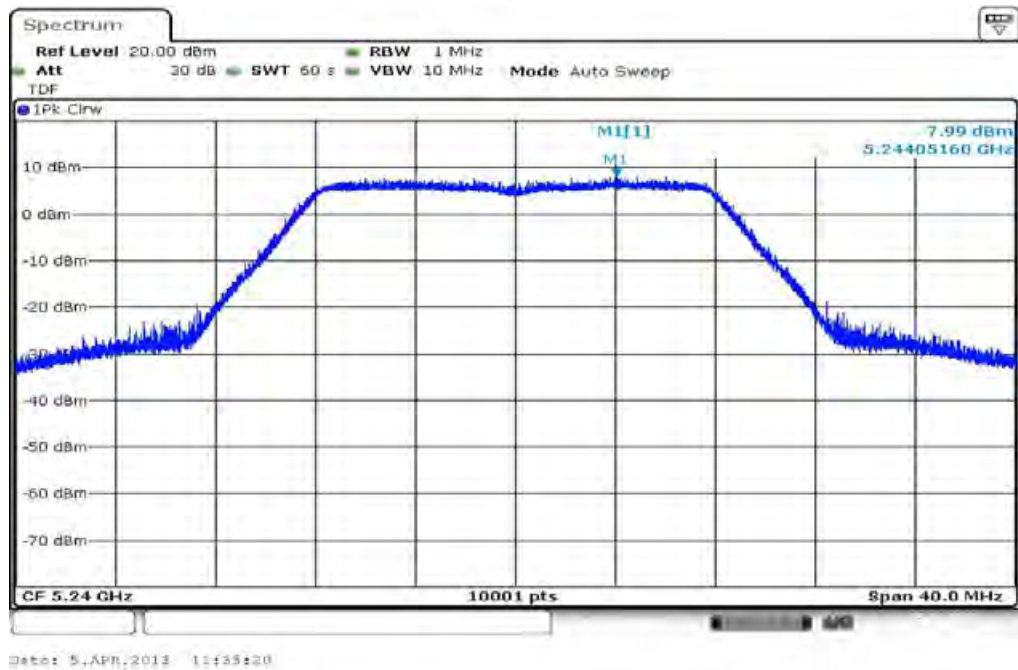

Plot 3: 5260 MHz

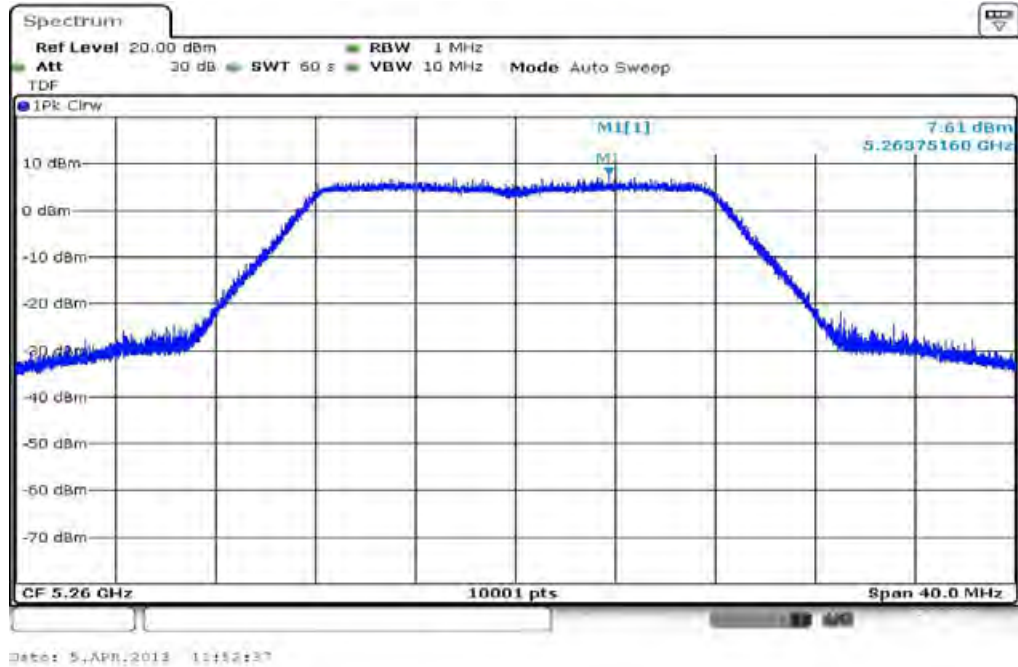

Plot 4: 5320 MHz

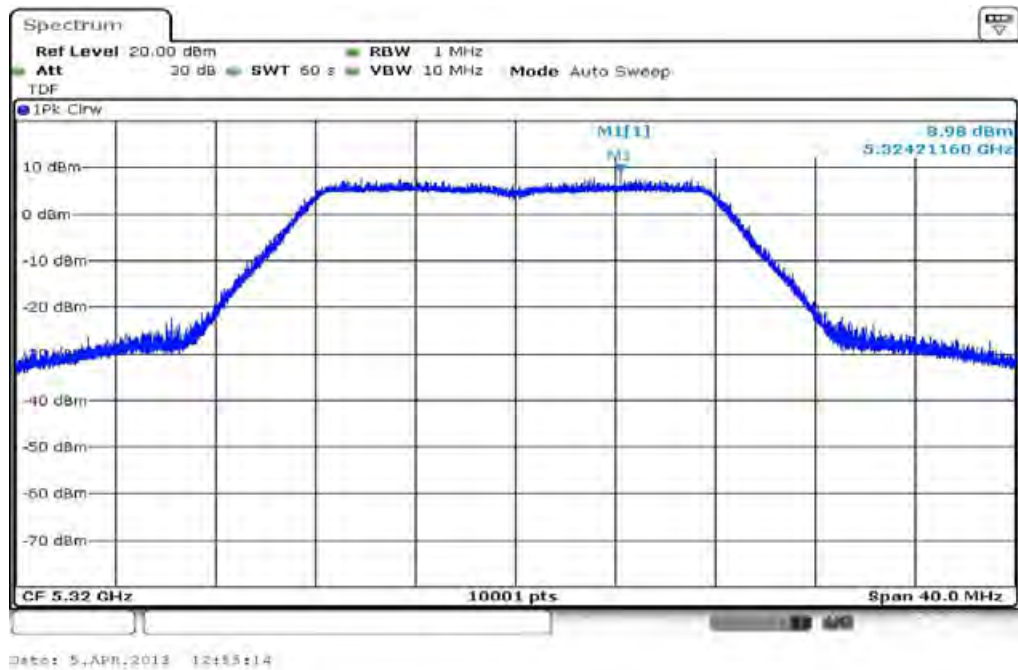

Plot 5: 5500 MHz

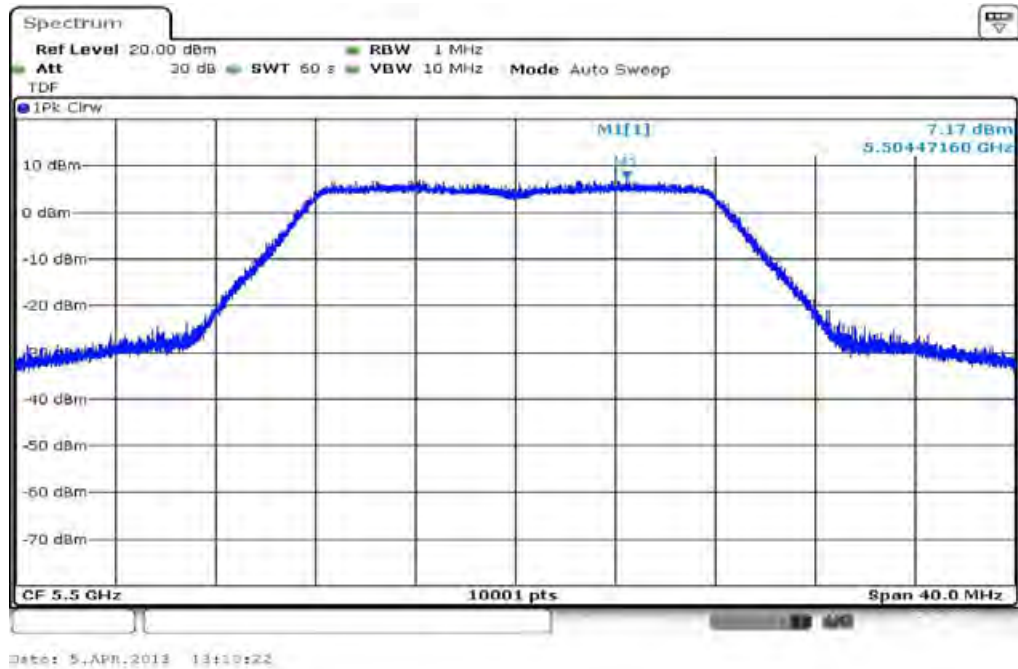

Plot 6: 5600 MHz



Plot 7: 5700 MHz

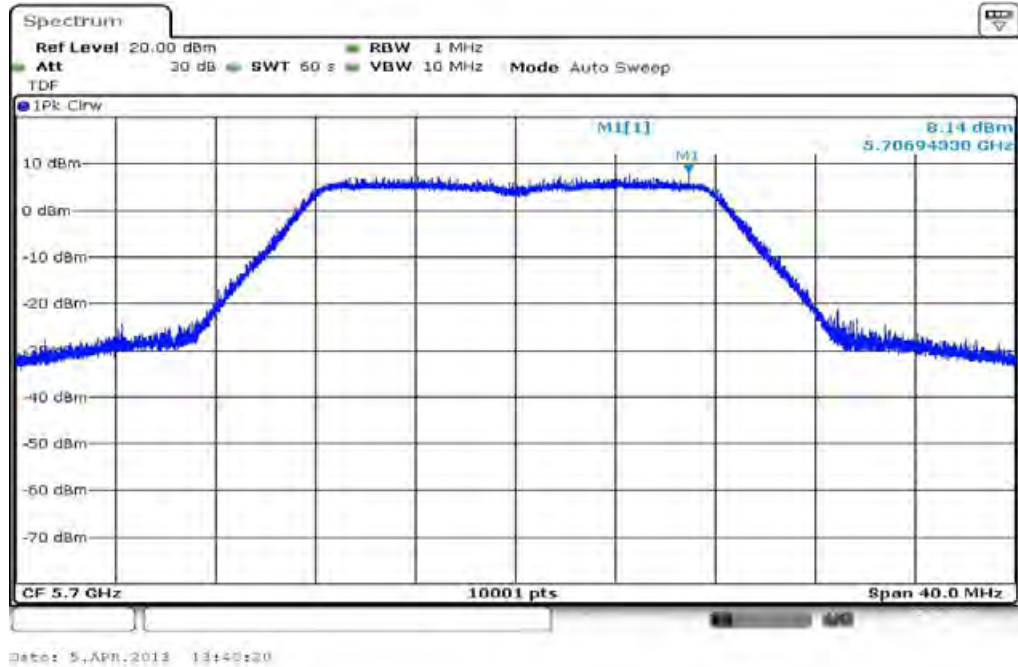

Plots: OFDM / n – mode HT20

Plot 1: 5180 MHz

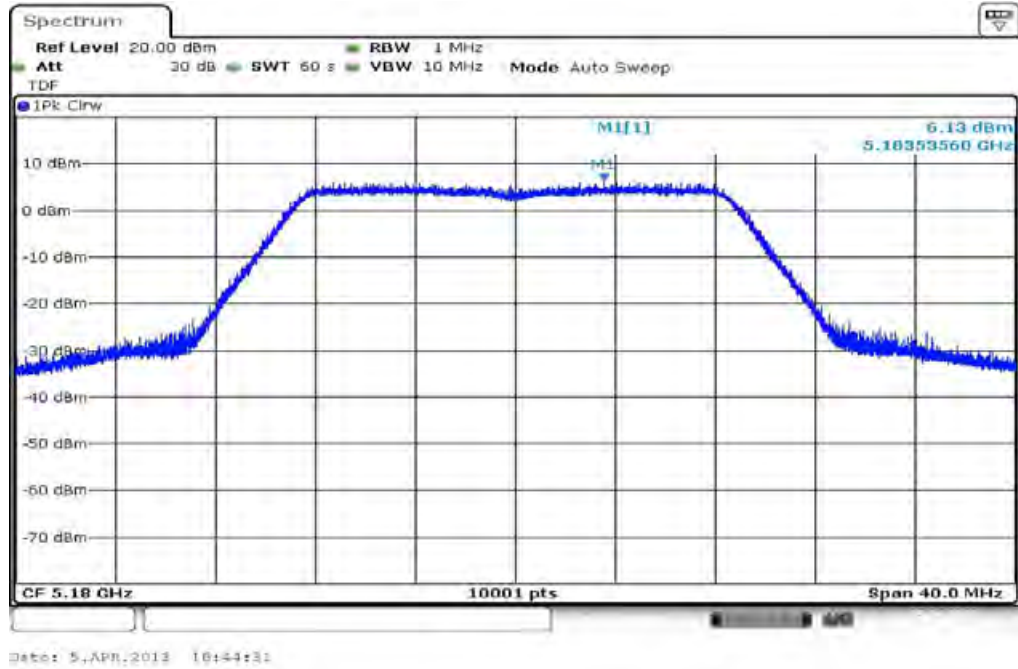

Plot 2: 5240 MHz

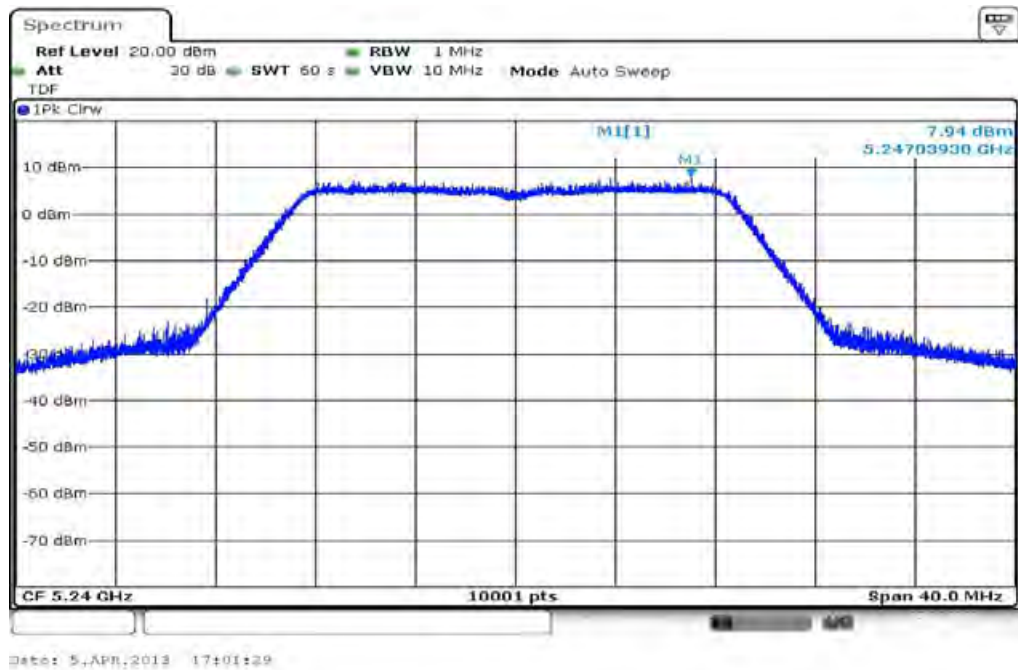

Plot 3: 5260 MHz

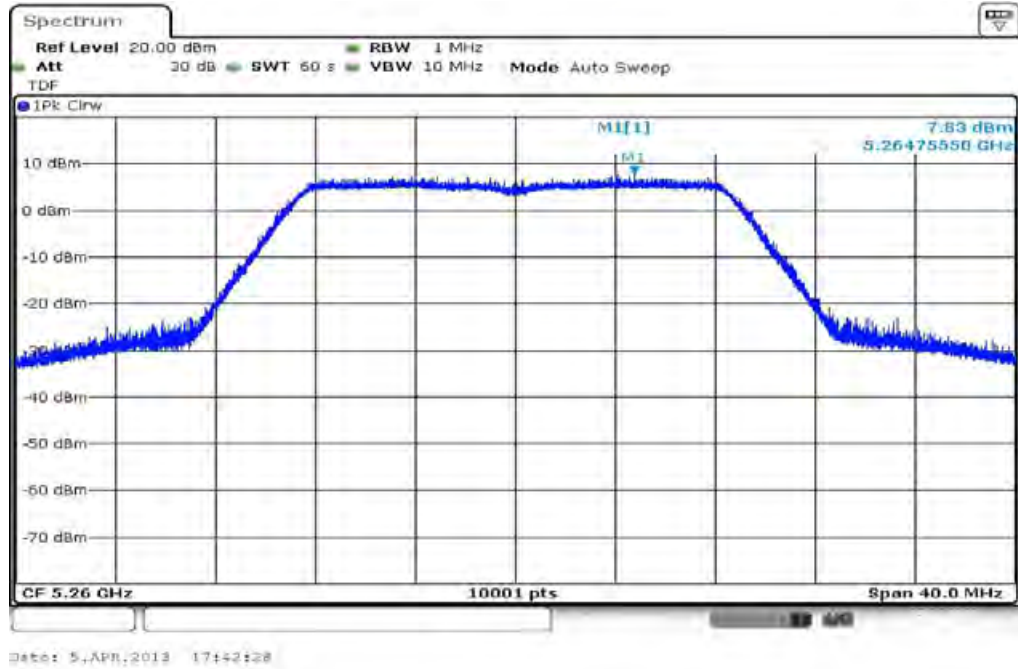

Plot 4: 5320 MHz

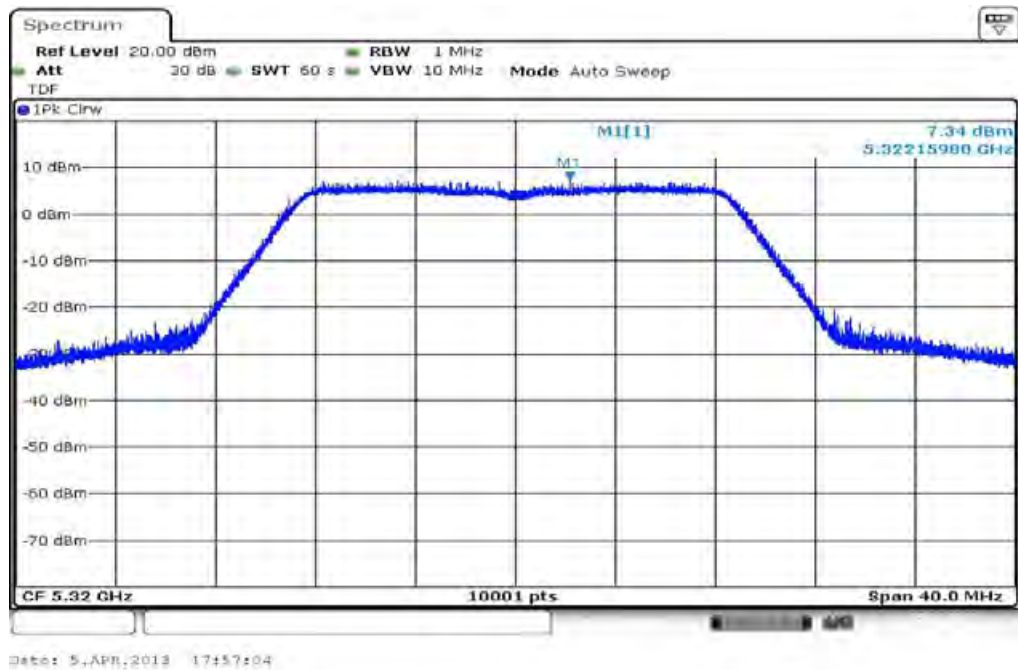

Plot 5: 5500 MHz

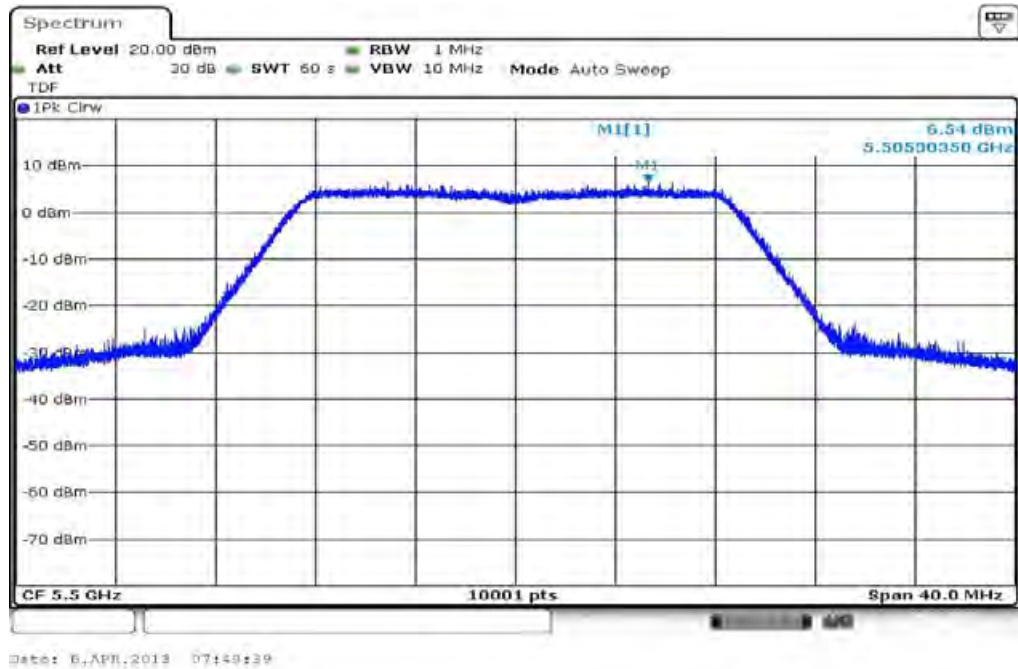

Plot 6: 5600 MHz

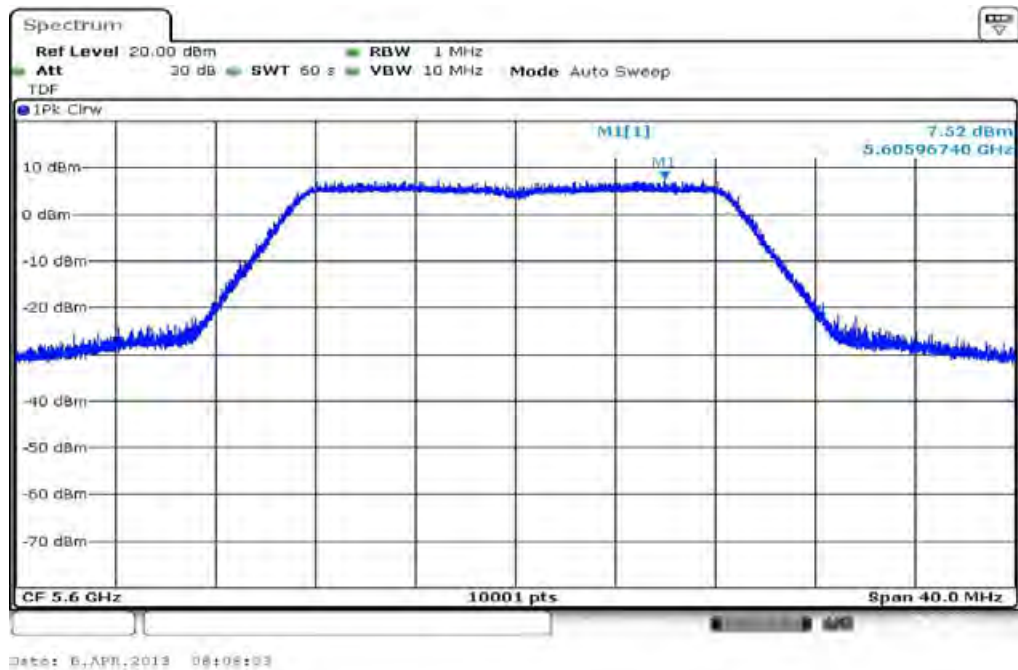

Plot 7: 5700 MHz

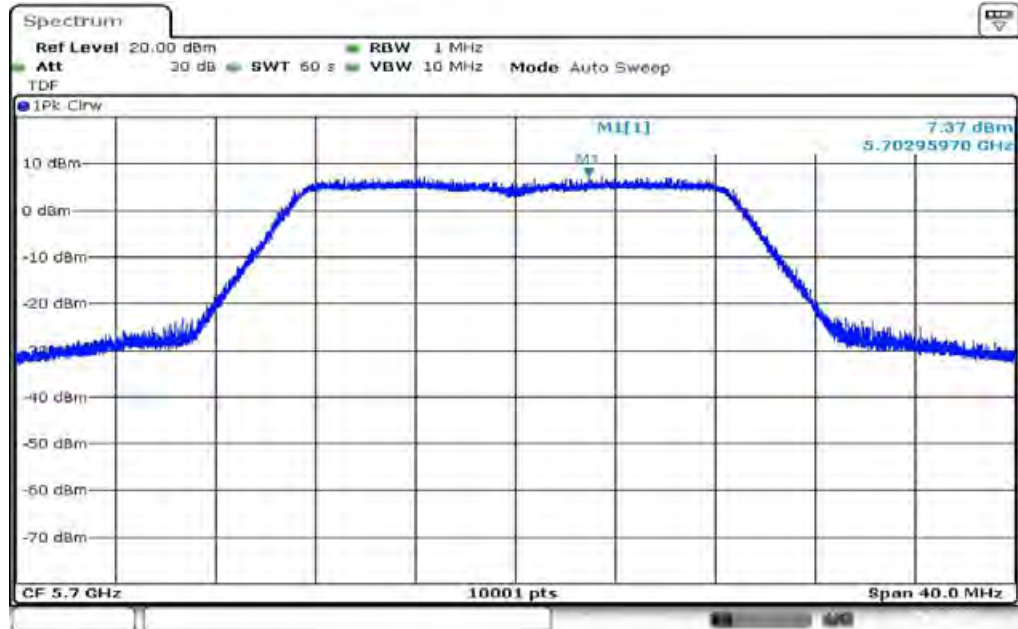

Plots: OFDM / n – mode HT40

Plot 1: 5190 MHz

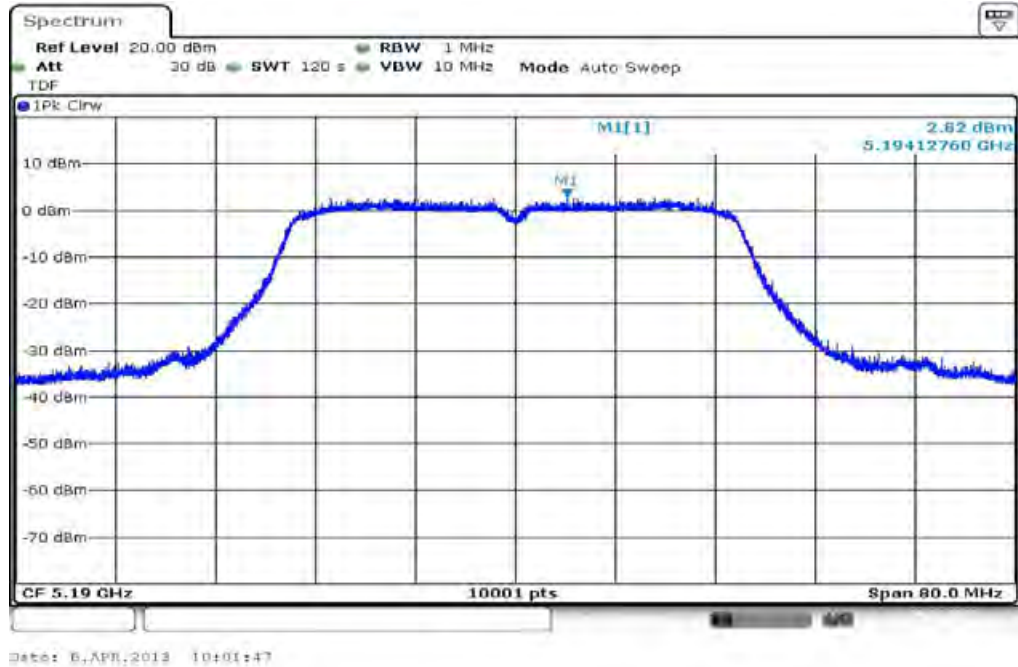

Plot 2: 5230 MHz

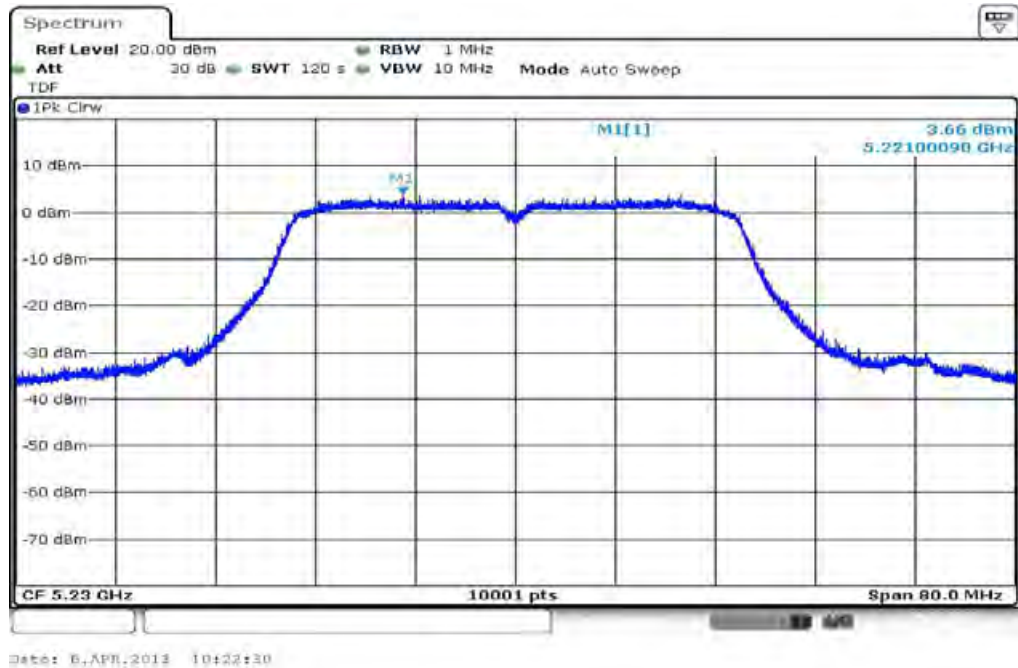

Plot 3: 5270 MHz

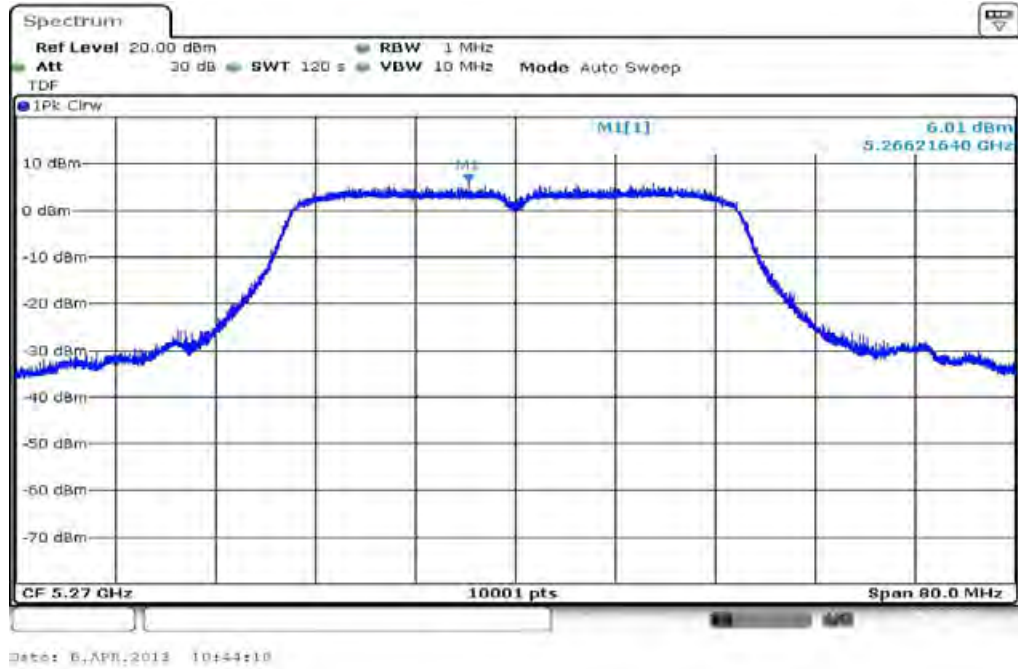

Plot 4: 5310 MHz



Plot 5: 5510 MHz



Plot 6: 5590 MHz

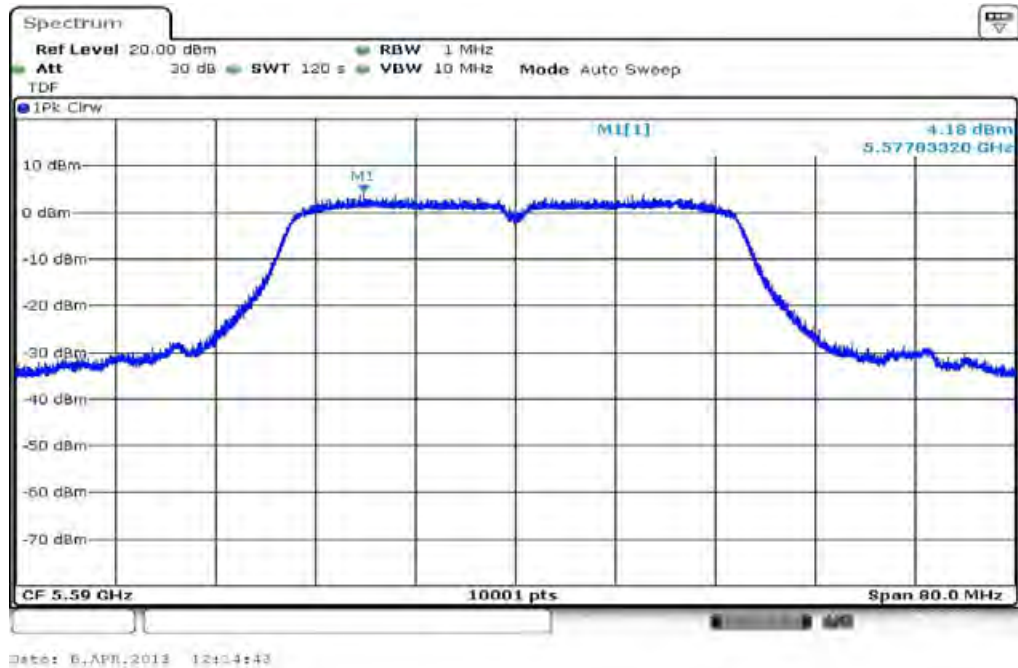

Plot 7: 5670 MHz

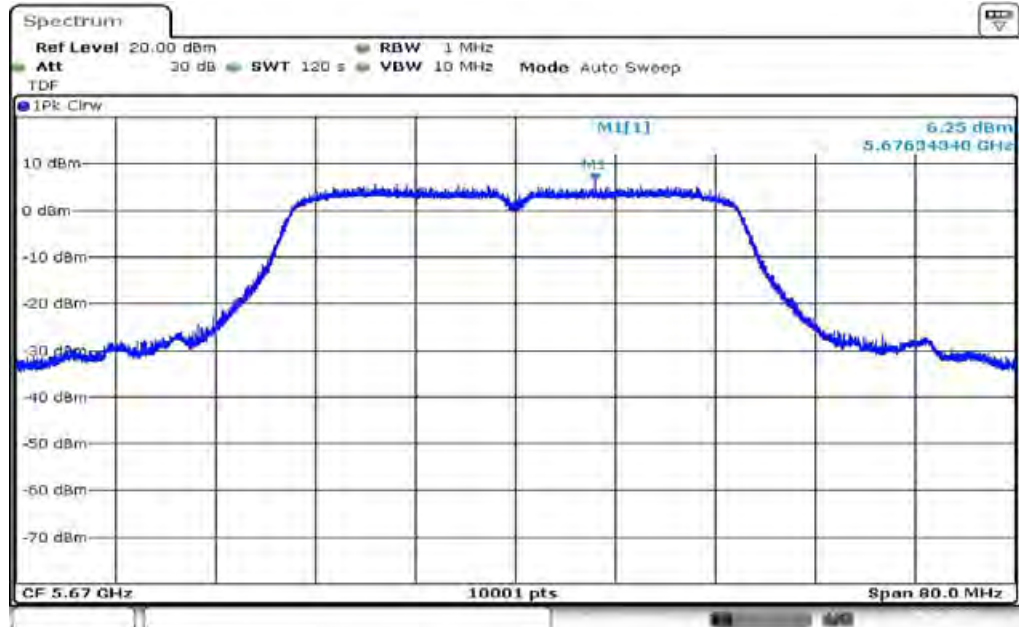

Date: 6, APR, 2013 13:43:33

9.8 Band edge compliance radiated

Description:

Measurement of the radiated band edge compliance. The EUT is turned in the position that results in the maximum level at the band edge. Then a sweep over the corresponding restricted band is performed. The EUT is set to the lowest channel for the lower restricted band and to the highest channel for the upper restricted band. Measurement distance is 3m.

Measurement:

Measurement parameter	
Detector:	Peak / RMS
Sweep time:	Auto
Resolution bandwidth:	1 MHz
Video bandwidth:	10 Hz / 1 MHz
Span:	See plots!
Trace-Mode:	Max Hold

Limits:

Band Edge Compliance Radiated
In any 100 kHz bandwidth outside the frequency band in which the spread spectrum or digitally modulated intentional radiator is operating, the radio frequency power that is produced by the intentional radiator shall be at least 20 dB below that in the 100 kHz bandwidth within the band that contains the highest level of the desired power, based on either an RF conducted or a radiated measurement. Attenuation below the general limits specified in Section 15.209(a) is not required. In addition, radiated emissions which fall in the restricted bands, as defined in Section 15.205(a), must also comply with the radiated emission limits specified in Section 15.209(a) (see Section 5.205(c)).
74 dB μ V/m PEAK 54 dB μ V/m AVG

Result:

Scenario	Band Edge Compliance Radiated [dB μ V/m]
band edge	< 74 dB μ V/m (AVG) < 54 dB μ V/m (PEAK)
Measurement uncertainty	\pm 3 dB

Plots:

Plot 1: lower band edge, vertical & horizontal polarization (a mode), channel 36

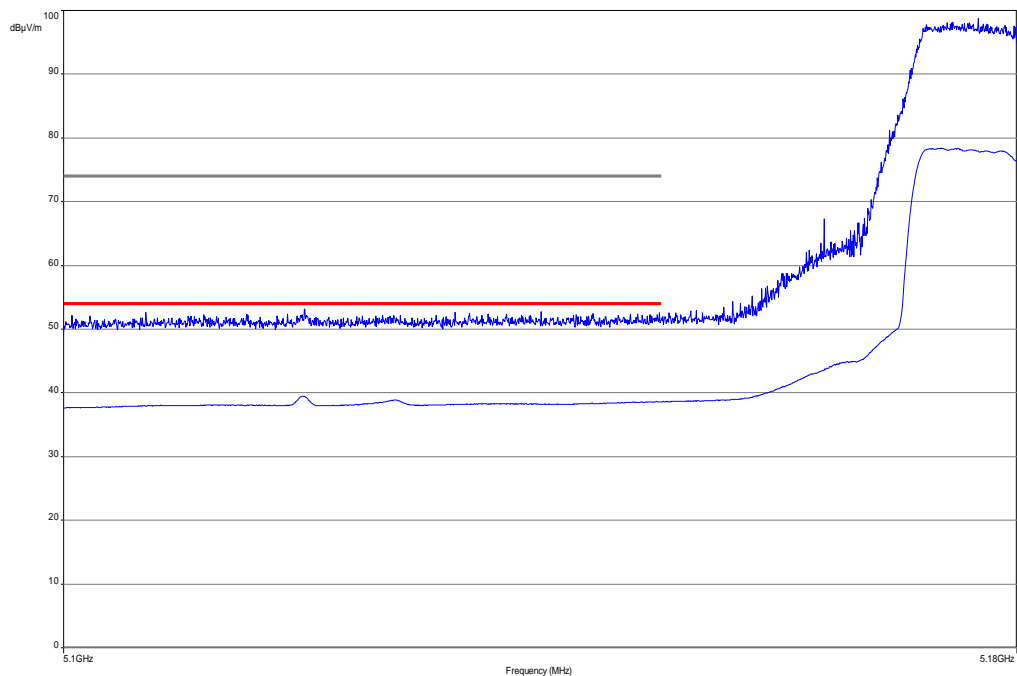

Plot 2: upper band edge, vertical & horizontal polarization (a mode), channel 64

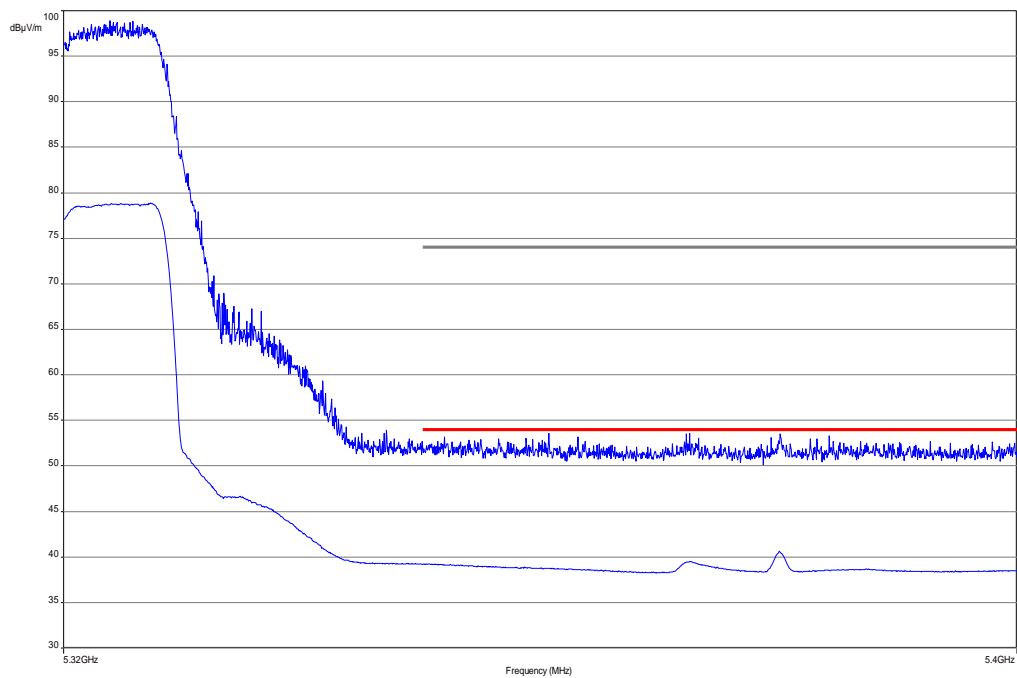

Plot 3: lower band edge, vertical & horizontal polarization (a mode), channel 100

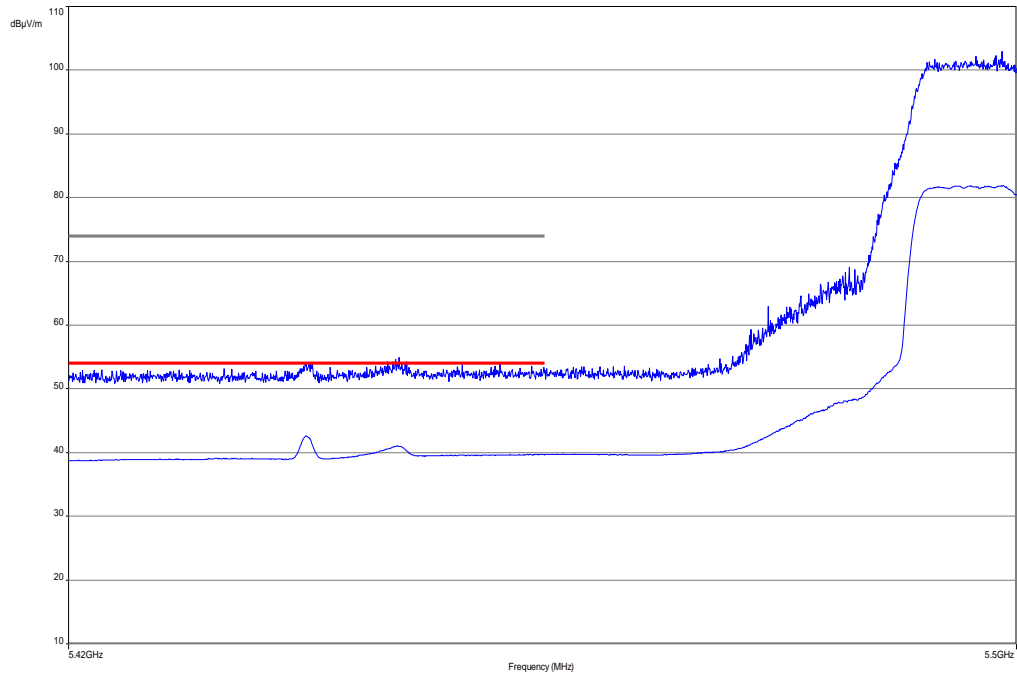

Plot 4: lower band edge, vertical & horizontal polarization (n HT 20 mode), channel 36

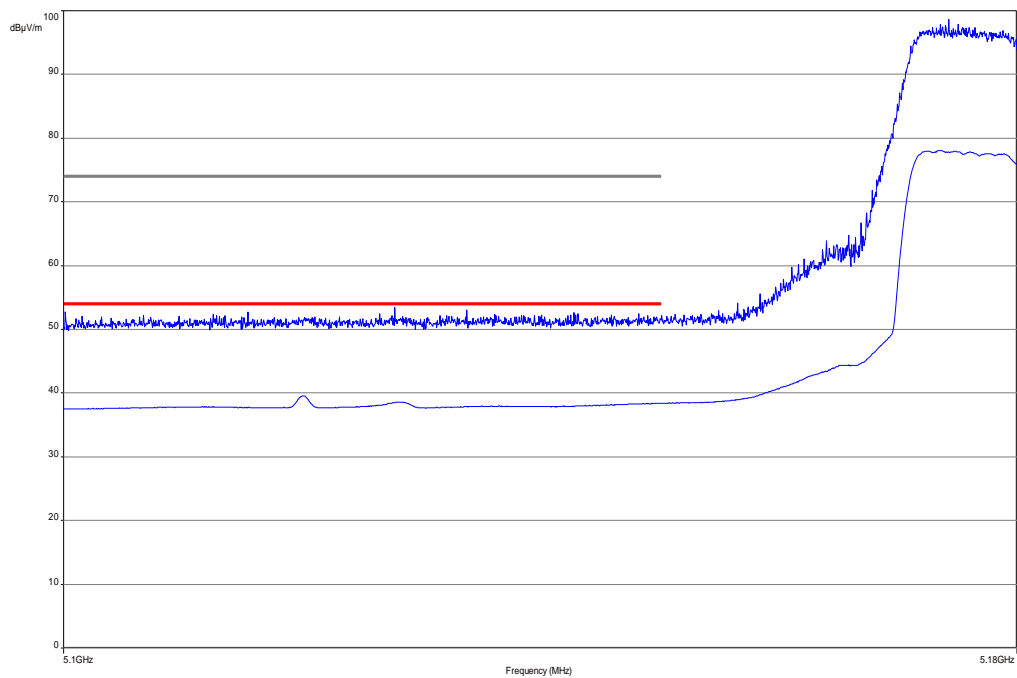

Plot 5: upper band edge, vertical & horizontal polarization (n HT 20 mode), channel 64

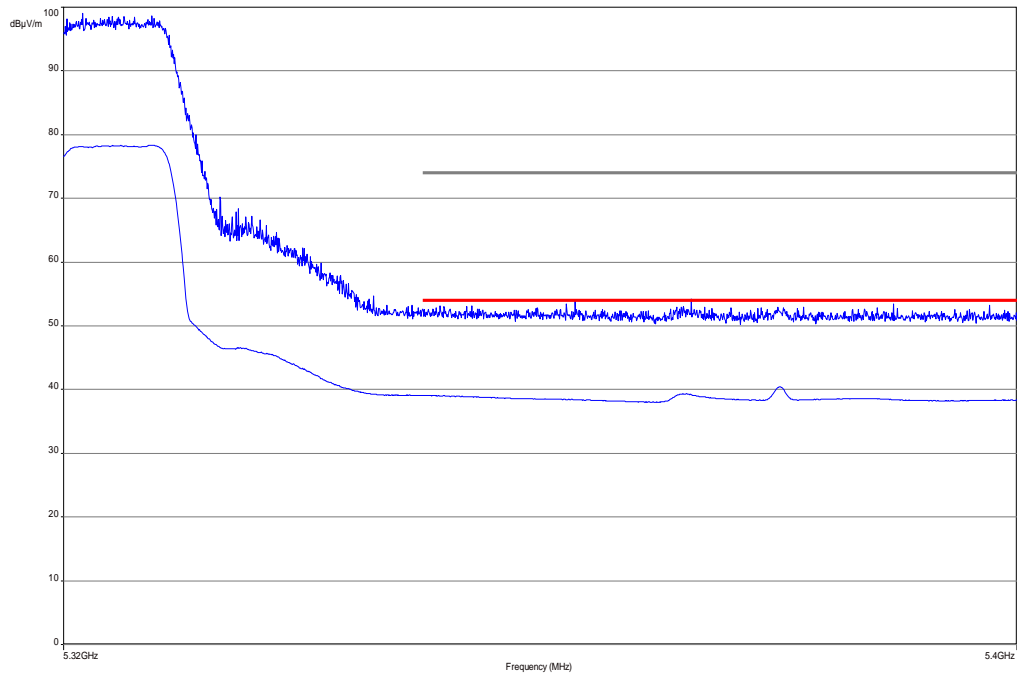

Plot 6: lower band edge, vertical & horizontal polarization (n HT 20 mode), channel 100

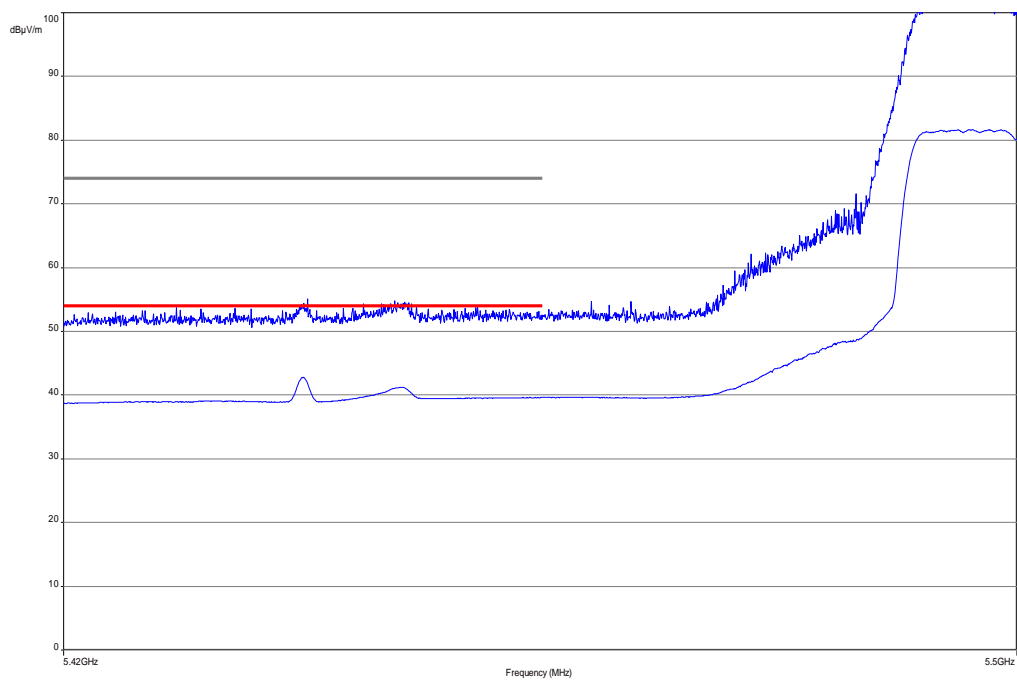

Plot 7: lower band edge, vertical & horizontal polarization (n HT 40 mode), channel 38

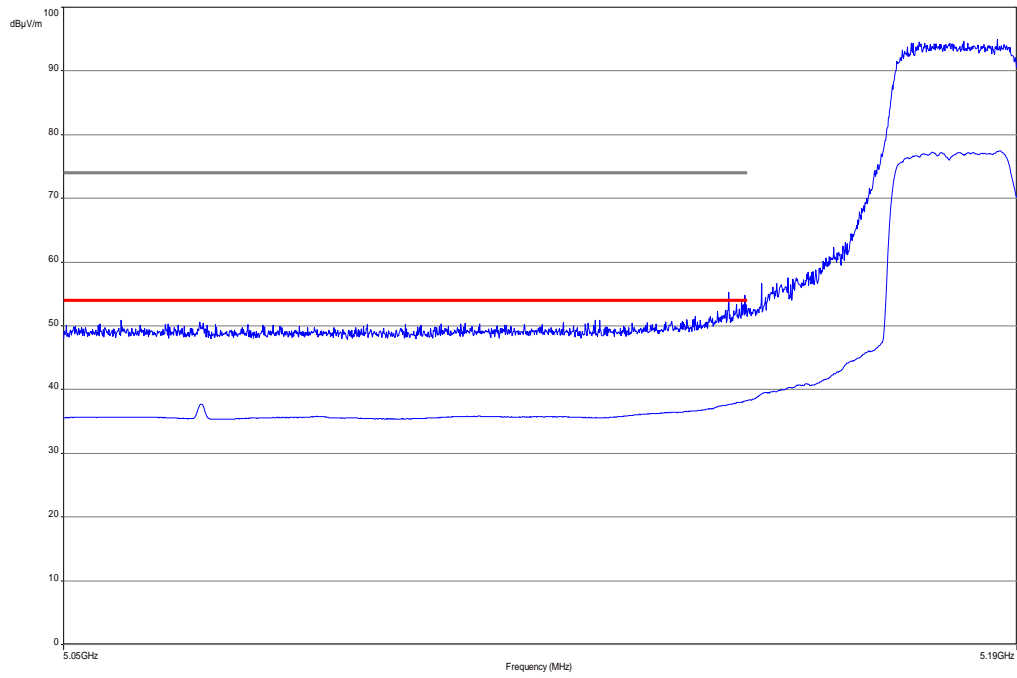

Plot 8: upper band edge, vertical & horizontal polarization (n HT 40 mode), channel 62

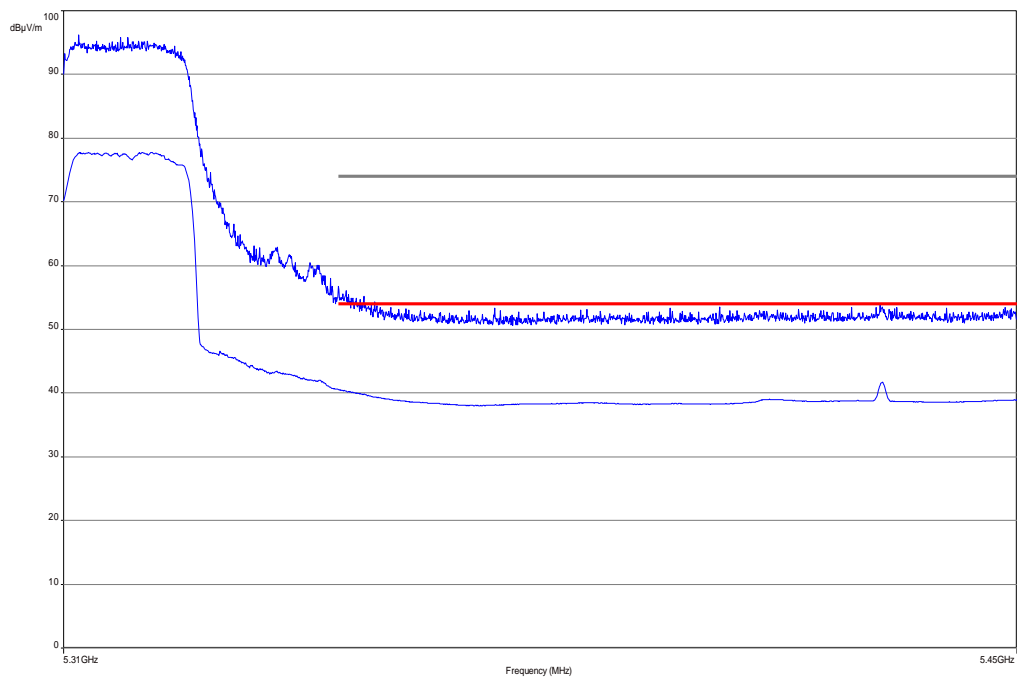

Plot 9: lower band edge, vertical & horizontal polarization (n HT 40 mode), channel 102

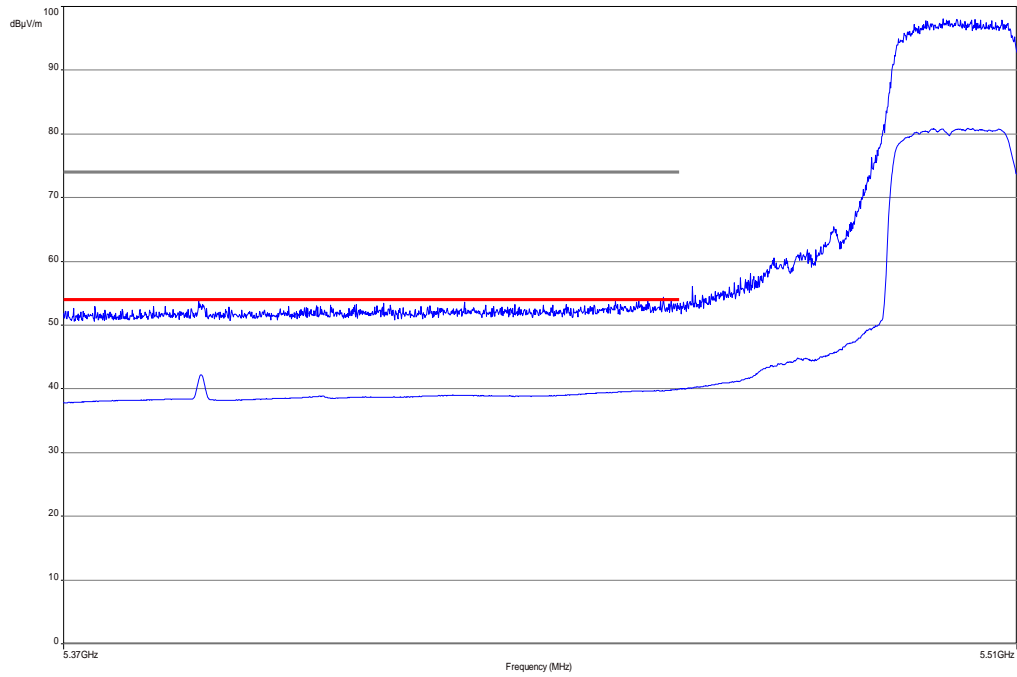

Result: Passed

9.9 TX spurious emissions radiated

Description:

Measurement of the radiated spurious emissions in transmit mode. The measurement is performed at lowest, middle and highest channel.

Measurement:

Measurement parameter	
Detector:	Quasi Peak below 1 GHz (alternative Peak) Peak above 1 GHz / RMS
Sweep time:	Auto
Resolution bandwidth:	F < 1 GHz: 100 kHz F > 1 GHz: 1 MHz
Video bandwidth:	F < 1 GHz: 100 kHz F > 1 GHz: ≥ 3 MHz /10 Hz
Span:	30 MHz to 40 GHz
Trace-Mode:	Max Hold / Average with 100 counts + 20 log (1 / X) for duty cycle lower than 100 %

Limits:

TX Spurious Emissions Radiated		
§15.209		
Frequency (MHz)	Field Strength (dBµV/m)	Measurement distance
30 - 88	30.0	10
88 – 216	33.5	10
216 – 960	36.0	10
Above 960	54.0	3
§15.407		
Outside the restricted bands!	-27 dBm / MHz	

Results: OFDM / a – mode

TX Spurious Emissions Radiated [dBµV/m] / dBm								
OFDM a – mode								
Lowest 5180 MHz			-/-			Highest 5240 MHz		
F [MHz]	Detector	Level [dBµV/m]	F [MHz]	Detector	Level [dBµV/m]	F [MHz]	Detector	Level [dBµV/m]
For emissions below 1 GHz, please take a look at the table below the 1 GHz plot.			-/-			For emissions below 1 GHz, please take a look at the table below the 1 GHz plot.		
No emissions detected between 1 GHz and 12.75 GHz.						No emissions detected between 1 GHz and 12.75 GHz.		
For emissions above 12.75 GHz, please take a look at the plots.						For emissions above 12.75 GHz, please take a look at the plots.		
Measurement uncertainty			± 3 dB					

TX Spurious Emissions Radiated [dBµV/m] / dBm								
OFDM a – mode								
Lowest 5260 MHz			-/-			Highest 5320 MHz		
F [MHz]	Detector	Level [dBµV/m]	F [MHz]	Detector	Level [dBµV/m]	F [MHz]	Detector	Level [dBµV/m]
For emissions below 1 GHz, please take a look at the table below the 1 GHz plot.			-/-			For emissions below 1 GHz, please take a look at the table below the 1 GHz plot.		
No emissions detected between 1 GHz and 12.75 GHz.						No emissions detected between 1 GHz and 12.75 GHz.		
For emissions above 12.75 GHz, please take a look at the plots.						For emissions above 12.75 GHz, please take a look at the plots.		
Measurement uncertainty			± 3 dB					

TX Spurious Emissions Radiated [dBµV/m] / dBm								
OFDM a – mode								
Lowest 5500 MHz			Middle 5600 MHz			Highest 5700 MHz		
F [MHz]	Detector	Level [dBµV/m]	F [MHz]	Detector	Level [dBµV/m]	F [MHz]	Detector	Level [dBµV/m]
For emissions below 1 GHz, please take a look at the table below the 1 GHz plot.			For emissions below 1 GHz, please take a look at the table below the 1 GHz plot.			For emissions below 1 GHz, please take a look at the table below the 1 GHz plot.		
No emissions detected between 1 GHz and 12.75 GHz.			No emissions detected between 1 GHz and 12.75 GHz.			No emissions detected between 1 GHz and 12.75 GHz.		
For emissions above 12.75 GHz, please take a look at the plots.			For emissions above 12.75 GHz, please take a look at the plots.			For emissions above 12.75 GHz, please take a look at the plots.		
Measurement uncertainty			± 3 dB					

Result: Passed

Results: OFDM / n – modeHT20

TX Spurious Emissions Radiated [dBµV/m] / dBm								
OFDM n – mode HT20								
Lowest 5180 MHz			-/-			Highest 5240 MHz		
F [MHz]	Detector	Level [dBµV/m]	F [MHz]	Detector	Level [dBµV/m]	F [MHz]	Detector	Level [dBµV/m]
For emissions below 1 GHz, please take a look at the table below the 1 GHz plot.			-/-			For emissions below 1 GHz, please take a look at the table below the 1 GHz plot.		
No emissions detected between 1 GHz and 12.75 GHz.						No emissions detected between 1 GHz and 12.75 GHz.		
For emissions above 12.75 GHz, please take a look at the plots.						For emissions above 12.75 GHz, please take a look at the plots.		
Measurement uncertainty			± 3 dB					

TX Spurious Emissions Radiated [dBµV/m] / dBm								
OFDM n – mode HT20								
Lowest 5260 MHz			-/-			Highest 5320 MHz		
F [MHz]	Detector	Level [dBµV/m]	F [MHz]	Detector	Level [dBµV/m]	F [MHz]	Detector	Level [dBµV/m]
For emissions below 1 GHz, please take a look at the table below the 1 GHz plot.			-/-			For emissions below 1 GHz, please take a look at the table below the 1 GHz plot.		
No emissions detected between 1 GHz and 12.75 GHz.						No emissions detected between 1 GHz and 12.75 GHz.		
For emissions above 12.75 GHz, please take a look at the plots.						For emissions above 12.75 GHz, please take a look at the plots.		
Measurement uncertainty			± 3 dB					

TX Spurious Emissions Radiated [dBµV/m] / dBm								
OFDM n – mode HT20								
Lowest 5500 MHz			Middle 5600 MHz			Highest 5700 MHz		
F [MHz]	Detector	Level [dBµV/m]	F [MHz]	Detector	Level [dBµV/m]	F [MHz]	Detector	Level [dBµV/m]
For emissions below 1 GHz, please take a look at the table below the 1 GHz plot.			For emissions below 1 GHz, please take a look at the table below the 1 GHz plot.			For emissions below 1 GHz, please take a look at the table below the 1 GHz plot.		
No emissions detected between 1 GHz and 12.75 GHz.			No emissions detected between 1 GHz and 12.75 GHz.			No emissions detected between 1 GHz and 12.75 GHz.		
For emissions above 12.75 GHz, please take a look at the plots.			For emissions above 12.75 GHz, please take a look at the plots.			For emissions above 12.75 GHz, please take a look at the plots.		
Measurement uncertainty			± 3 dB					

Result: Passed

Results: OFDM / n – modeHT40

TX Spurious Emissions Radiated [dBµV/m] / dBm								
OFDM n – mode HT40								
Lowest 5190 MHz			Highest 5230 MHz			Lowest 5270 MHz		
F [MHz]	Detector	Level [dBµV/m]	F [MHz]	Detector	Level [dBµV/m]	F [MHz]	Detector	Level [dBµV/m]
For emissions below 1 GHz, please take a look at the table below the 1 GHz plot.			For emissions below 1 GHz, please take a look at the table below the 1 GHz plot.			For emissions below 1 GHz, please take a look at the table below the 1 GHz plot.		
No emissions detected between 1 GHz and 12.75 GHz.			No emissions detected between 1 GHz and 12.75 GHz.			No emissions detected between 1 GHz and 12.75 GHz.		
For emissions above 12.75 GHz, please take a look at the plots.			For emissions above 12.75 GHz, please take a look at the plots.			For emissions above 12.75 GHz, please take a look at the plots.		
Measurement uncertainty			± 3 dB					

TX Spurious Emissions Radiated [dBµV/m] / dBm								
OFDM n – mode HT40								
Highest 5310 MHz			Lowest 5510 MHz			Middle 5590 MHz		
F [MHz]	Detector	Level [dBµV/m]	F [MHz]	Detector	Level [dBµV/m]	F [MHz]	Detector	Level [dBµV/m]
For emissions below 1 GHz, please take a look at the table below the 1 GHz plot.			For emissions below 1 GHz, please take a look at the table below the 1 GHz plot.			For emissions below 1 GHz, please take a look at the table below the 1 GHz plot.		
No emissions detected between 1 GHz and 12.75 GHz.			No emissions detected between 1 GHz and 12.75 GHz.			No emissions detected between 1 GHz and 12.75 GHz.		
For emissions above 12.75 GHz, please take a look at the plots.			For emissions above 12.75 GHz, please take a look at the plots.			For emissions above 12.75 GHz, please take a look at the plots.		
Measurement uncertainty			± 3 dB					

TX Spurious Emissions Radiated [dBµV/m] / dBm								
OFDM n – mode HT40								
Highest 5670 MHz			-/-			-/-		
F [MHz]	Detector	Level [dBµV/m]	F [MHz]	Detector	Level [dBµV/m]	F [MHz]	Detector	Level [dBµV/m]
For emissions below 1 GHz, please take a look at the table below the 1 GHz plot.								
No emissions detected between 1 GHz and 12.75 GHz.			-/-			-/-		
For emissions above 12.75 GHz, please take a look at the plots.								
Measurement uncertainty			± 3 dB					

Result: Passed

Note:

Results of the OFDM / a – mode and n HT40 – mode are added to show the behaviour of the EUT.

Plots: OFDM / a – mode

Plot 1: 30 MHz to 1 GHz, 5180 MHz, vertical & horizontal polarization

Common Information

EUT: TM-0030-BV
 Serial Number: CB5A1NY07J
 Test Description: FCC part 15 C class B @ 10 m
 Operating Conditions: wlan a-mode ch 36 + charging
 Operator Name: Wolsdorfer
 Comment: USB powered

Scan Setup: STAN_Fin [EMI radiated]

Hardware Setup: Electric Field (NOS)
 Receiver: [ESCI 3]
 Level Unit: dBµV/m

Subrange	Step Size	Detectors	IF BW	Meas. Time	Preamp
30 MHz - 2 GHz	60 kHz	QPK	120 kHz	1 s	20 dB

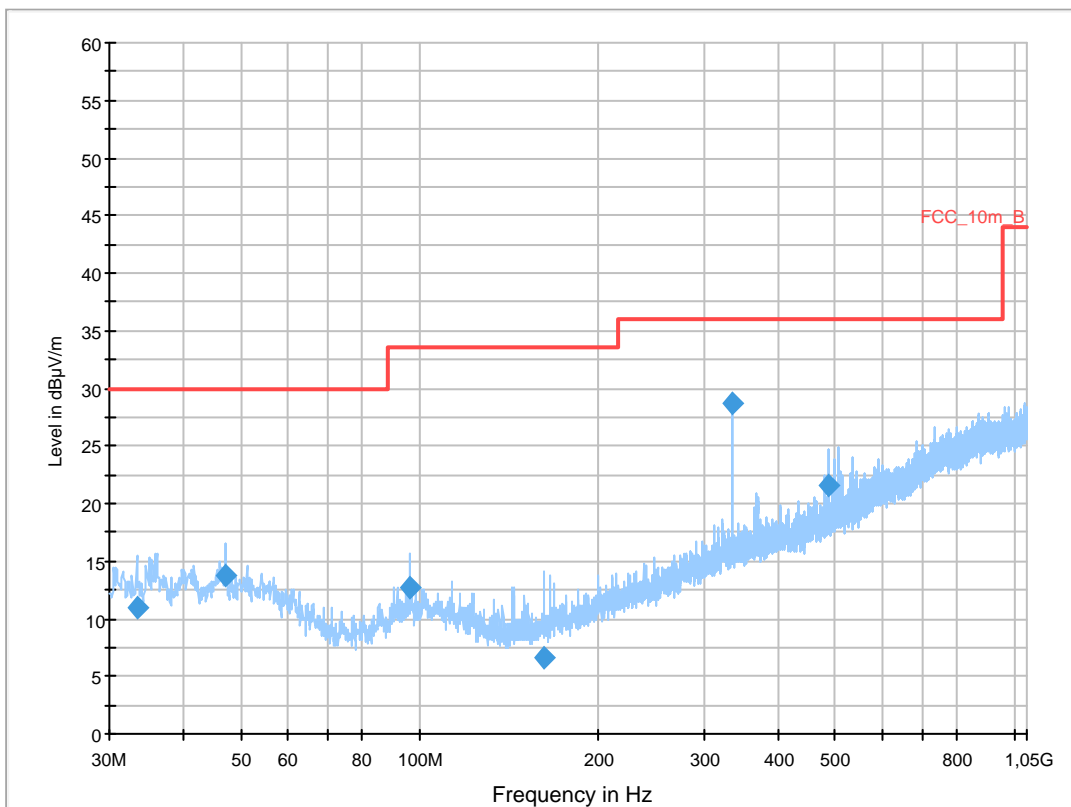

Final Result 1

Frequency (MHz)	QuasiPeak (dBµV/m)	Meas. Time (ms)	Bandwidth (kHz)	Height (cm)	Polarization	Azimuth (deg)	Corr. (dB)	Margin (dB)	Limit (dBµV/m)	Comment
33.360000	10.9	1000.0	120.000	155.0	V	246.0	12.9	19.1	30.0	
47.040000	13.8	1000.0	120.000	98.0	V	82.0	13.3	16.2	30.0	
96.000000	12.7	1000.0	120.000	120.0	V	75.0	11.4	20.8	33.5	
162.000000	6.6	1000.0	120.000	270.0	V	260.0	9.3	26.9	33.5	
336.000000	28.8	1000.0	120.000	104.0	V	27.0	15.6	7.2	36.0	
486.840000	21.6	1000.0	120.000	98.0	V	260.0	18.4	14.4	36.0	

Plot 2: 1 GHz to 12.75 GHz, 5180 MHz, vertical & horizontal polarization

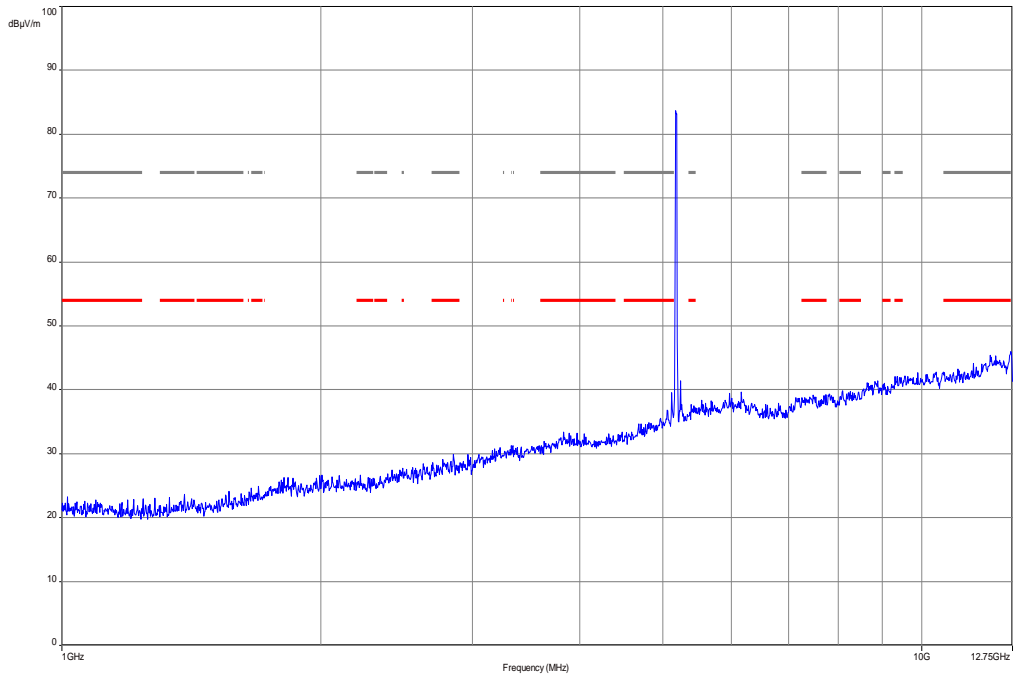

Plot 3: 12 GHz to 18 GHz, 5180 MHz, vertical & horizontal polarization

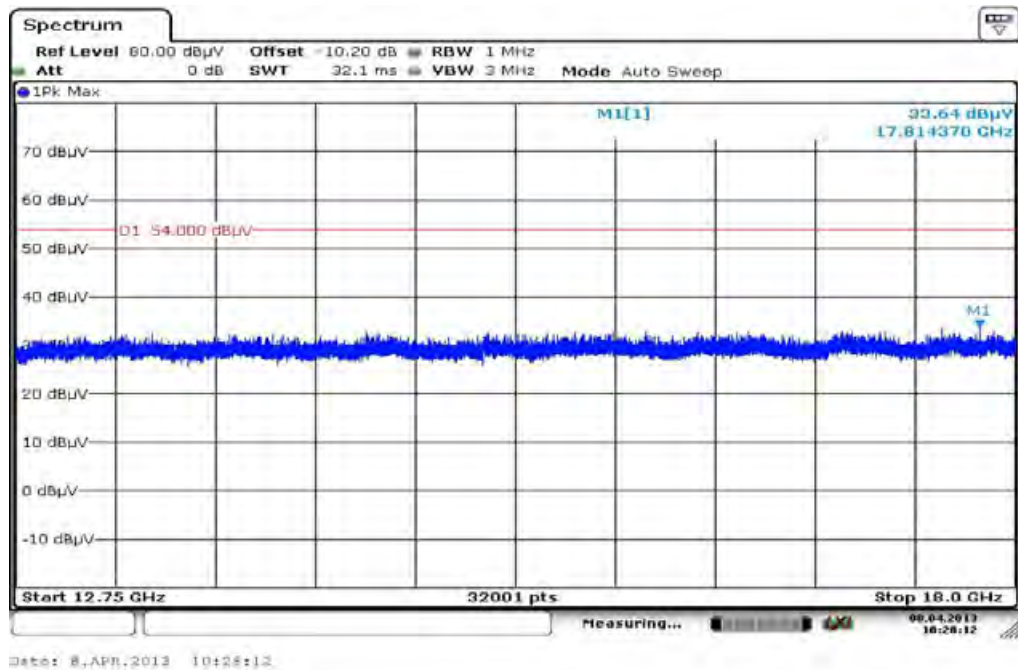

Plot 4: 18 GHz to 26 GHz, 5180 MHz, vertical & horizontal polarization

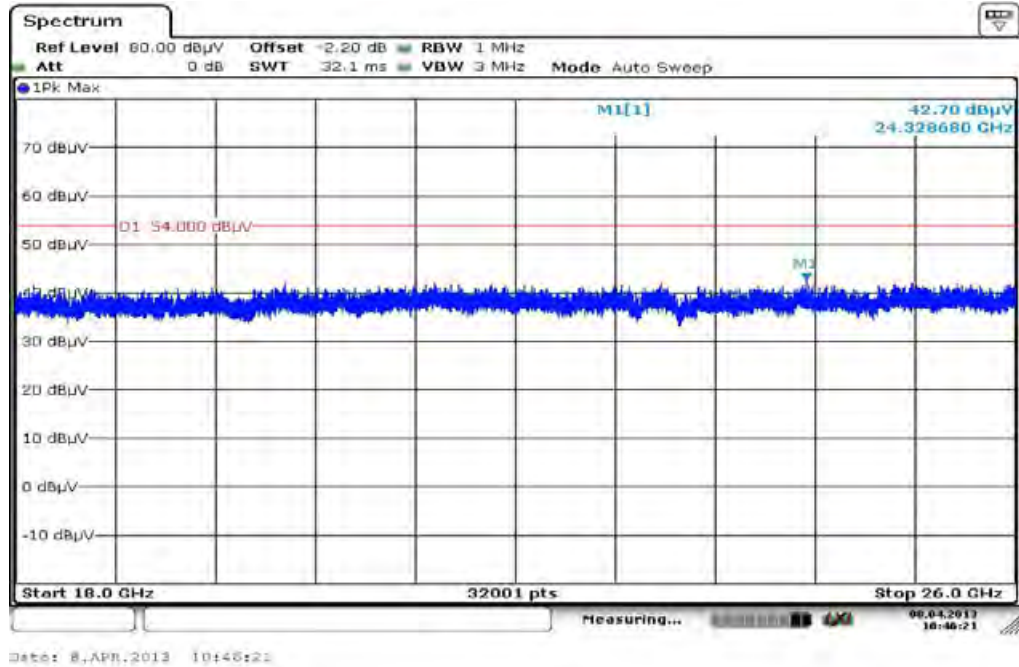

Plot 5: 26 GHz to 40 GHz, 5180 MHz, vertical & horizontal polarization

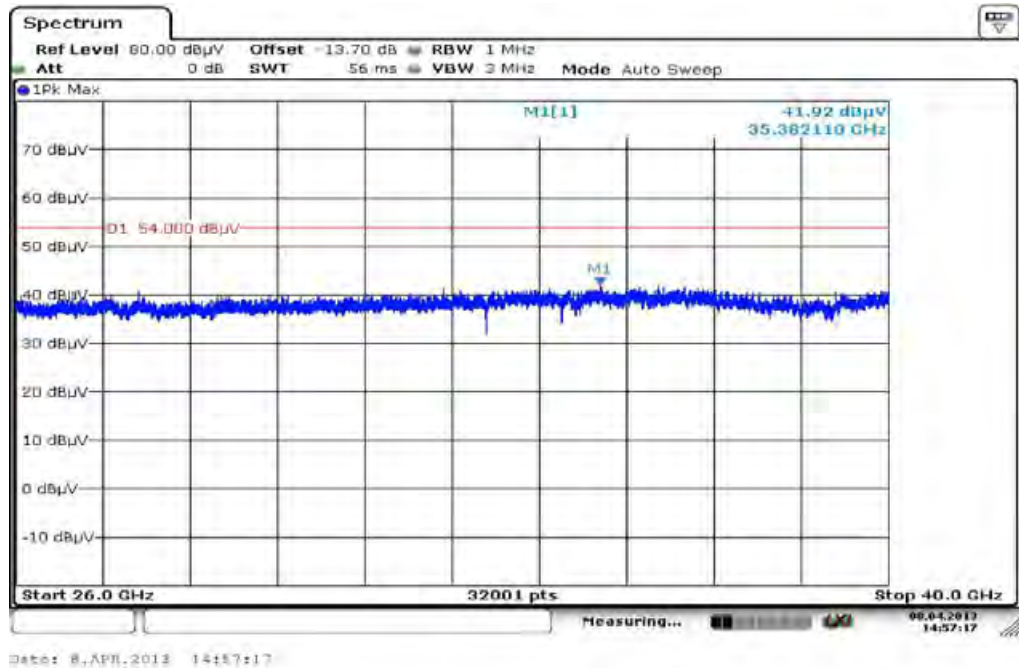

Plot 6: 30 MHz to 1 GHz, 5240 MHz, vertical & horizontal polarization

Common Information

EUT: TM-0030-BV
 Serial Number: CB5A1NY07J
 Test Description: FCC part 15 C class B @ 10 m
 Operating Conditions: wlan a-mode ch 48 + charging
 Operator Name: Wolsdorfer
 Comment: USB powered

Scan Setup: STAN_Fin [EMI radiated]

Hardware Setup: Electric Field (NOS)
 Receiver: [ESCI 3]
 Level Unit: dBµV/m

Subrange	Step Size	Detectors	IF BW	Meas. Time	Preamp
30 MHz - 2 GHz	60 kHz	QPK	120 kHz	1 s	20 dB

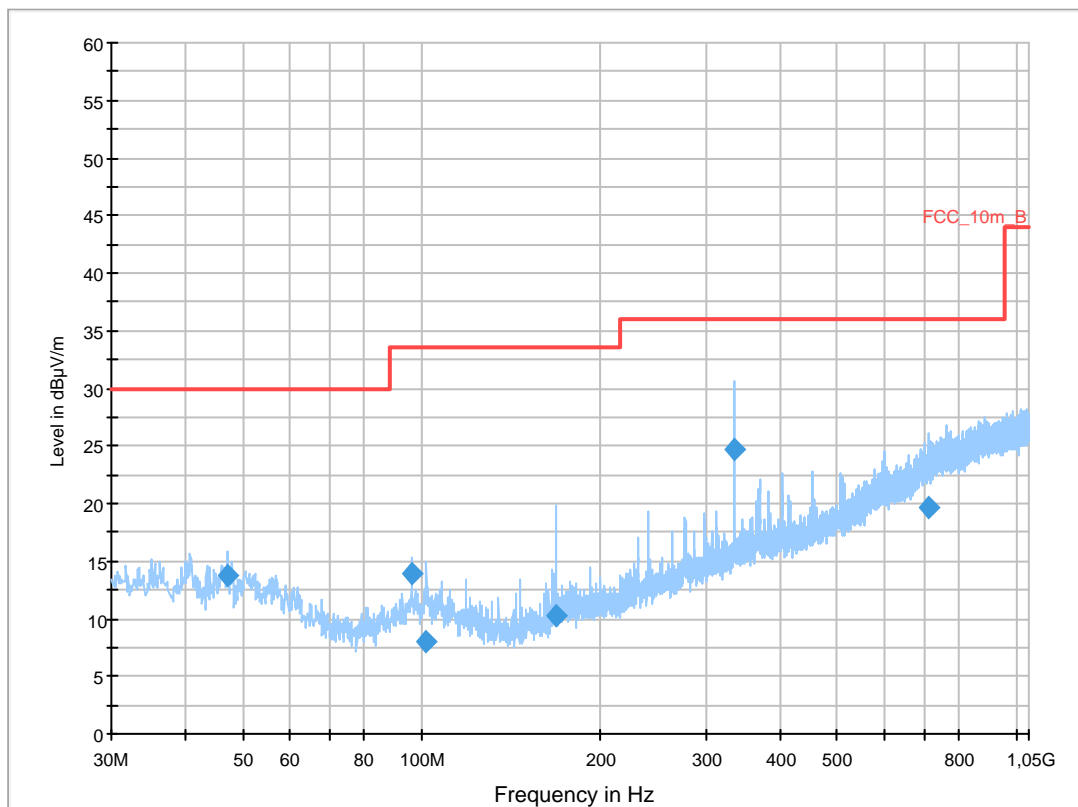

Final Result 1

Frequency (MHz)	QuasiPeak (dBµV/m)	Meas. Time (ms)	Bandwidth (kHz)	Height (cm)	Polarization	Azimuth (deg)	Corr. (dB)	Margin (dB)	Limit (dBµV/m)	Comment
47.040000	13.7	1000.0	120.000	98.0	V	111.0	13.3	16.3	30.0	
96.000000	13.9	1000.0	120.000	120.0	V	165.0	11.4	19.6	33.5	
101.880000	8.0	1000.0	120.000	270.0	V	56.0	11.7	25.5	33.5	
168.000000	10.3	1000.0	120.000	111.0	V	220.0	9.7	23.2	33.5	
336.000000	24.8	1000.0	120.000	111.0	V	31.0	15.6	11.2	36.0	
714.480000	19.6	1000.0	120.000	119.0	V	280.0	22.8	16.4	36.0	

Plot 7: 1 GHz to 12.75 GHz, 5240 MHz, vertical & horizontal polarization

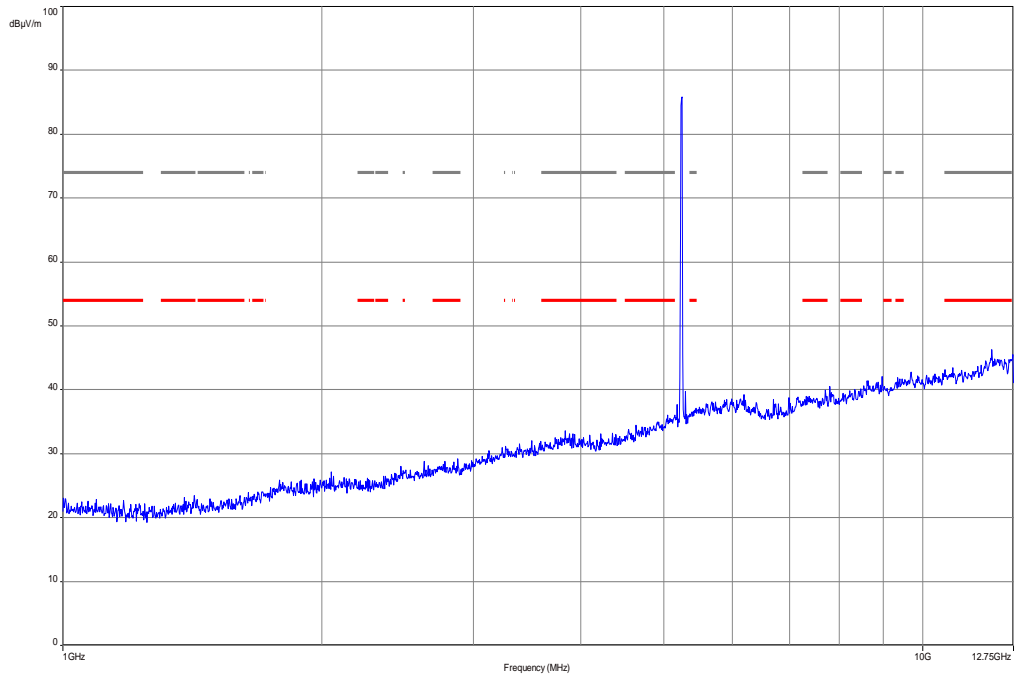

Plot 8: 12 GHz to 18 GHz, 5240 MHz, vertical & horizontal polarization

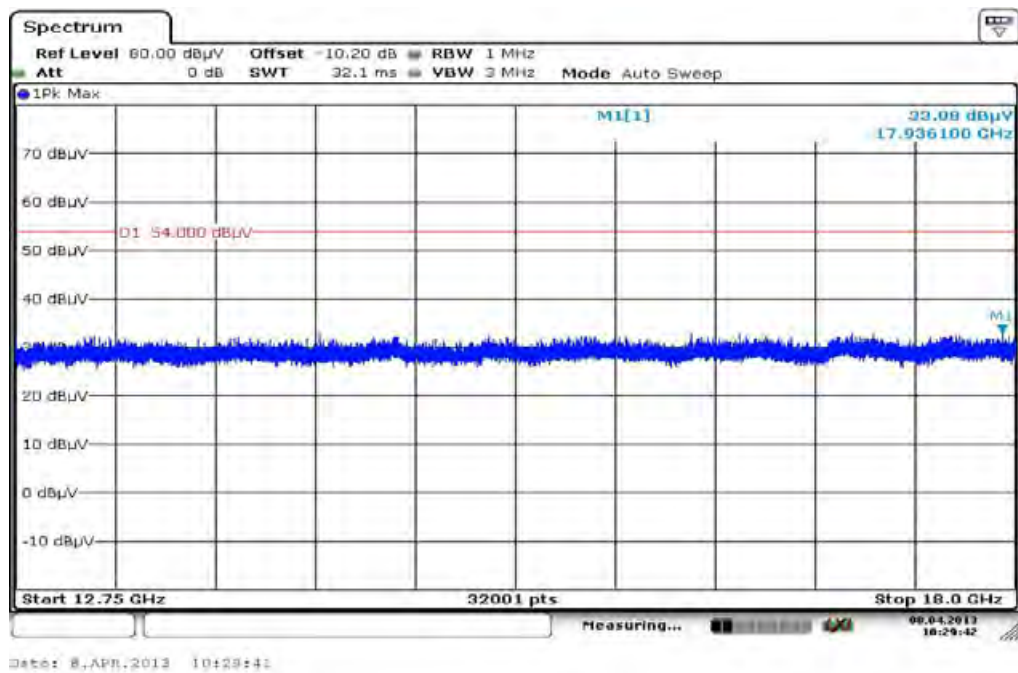

Plot 9: 18 GHz to 26 GHz, 5240 MHz, vertical & horizontal polarization

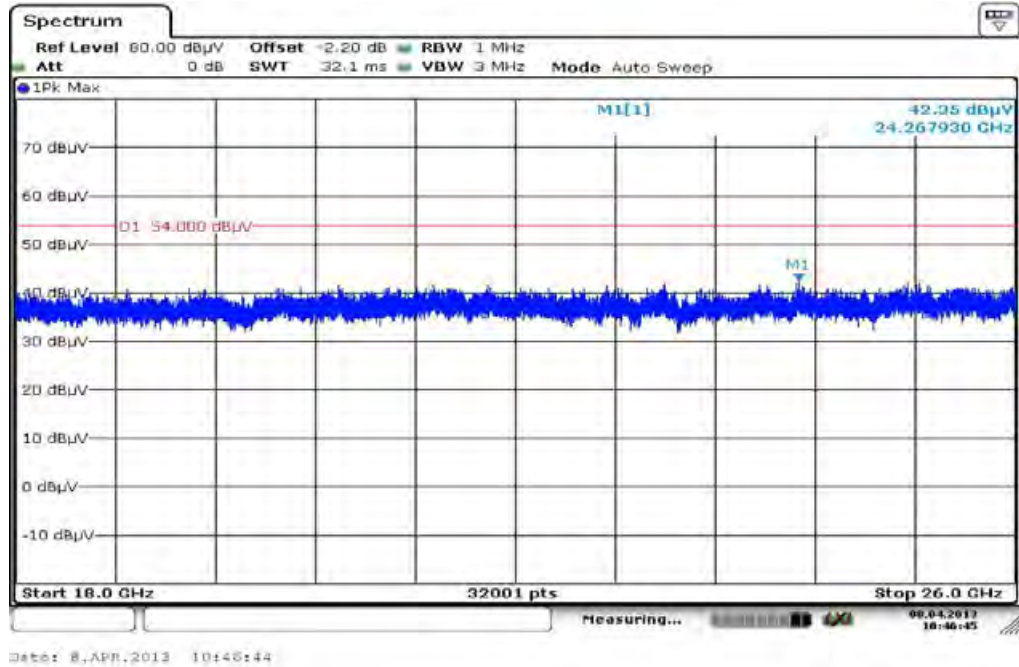

Plot 10: 26 GHz to 40 GHz, 5240 MHz, vertical & horizontal polarization

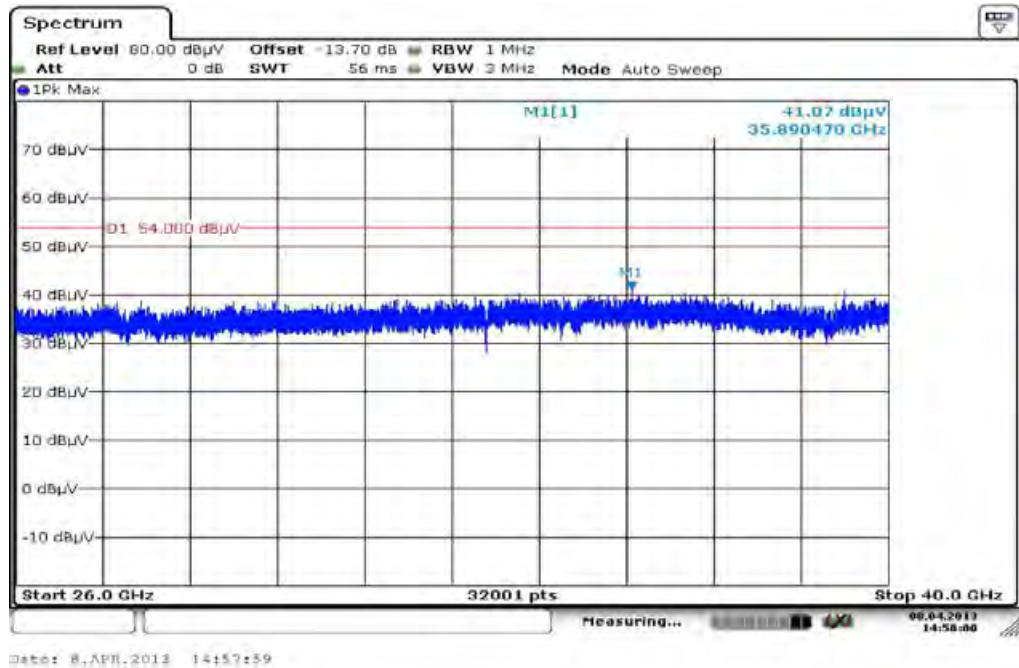

Plot 11: 30 MHz to 1 GHz, 5260 MHz, vertical & horizontal polarization

Common Information

EUT: TM-0030-BV
 Serial Number: CB5A1NY07J
 Test Description: FCC part 15 C class B @ 10 m
 Operating Conditions: wlan a-mode ch 52 + charging
 Operator Name: Wolsdorfer
 Comment: USB powered

Scan Setup: STAN_Fin [EMI radiated]

Hardware Setup: Electric Field (NOS)
 Receiver: [ESCI 3]
 Level Unit: dBµV/m

Subrange	Step Size	Detectors	IF BW	Meas. Time	Preamp
30 MHz - 2 GHz	60 kHz	QPK	120 kHz	1 s	20 dB

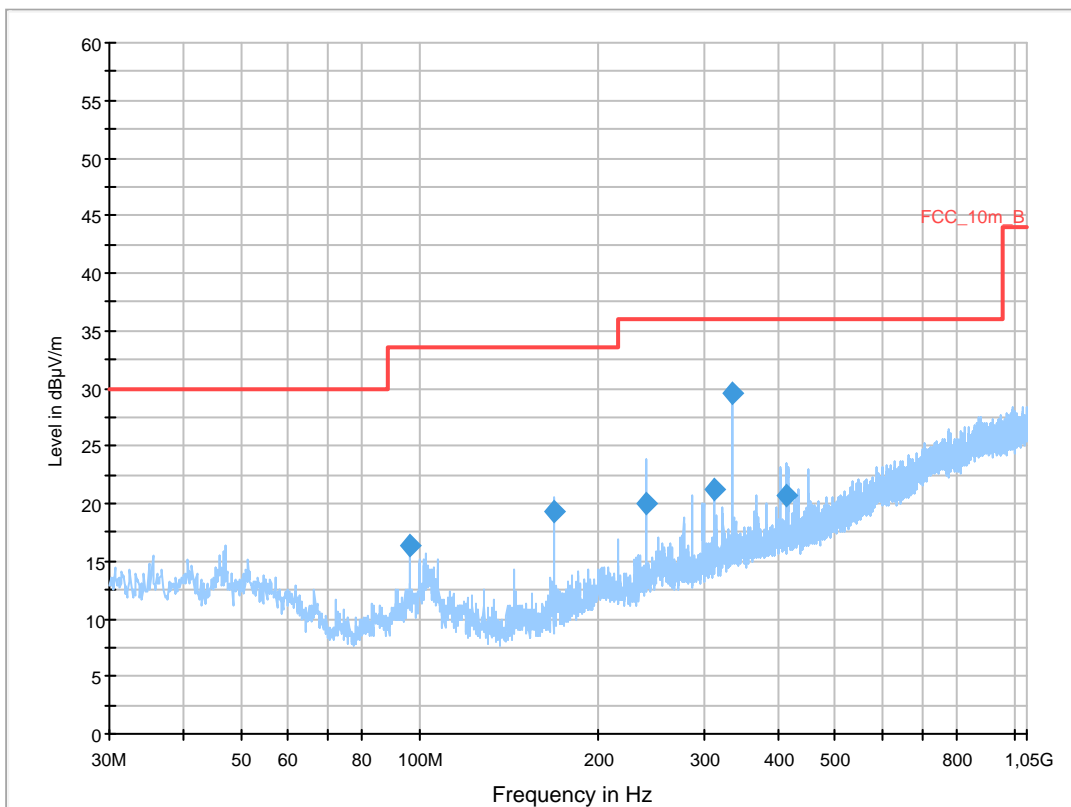

Final Result 1

Frequency (MHz)	QuasiPeak (dBµV/m)	Meas. Time (ms)	Bandwidth (kHz)	Height (cm)	Polarization	Azimuth (deg)	Corr. (dB)	Margin (dB)	Limit (dBµV/m)	Comment
96.000000	16.3	1000.0	120.000	121.0	V	221.0	11.4	17.2	33.5	
168.000000	19.3	1000.0	120.000	103.0	V	214.0	9.7	14.2	33.5	
240.000000	20.0	1000.0	120.000	98.0	V	64.0	13.0	16.0	36.0	
312.000000	21.3	1000.0	120.000	98.0	V	9.0	14.9	14.7	36.0	
336.000000	29.6	1000.0	120.000	111.0	V	327.0	15.6	6.4	36.0	
414.240000	20.7	1000.0	120.000	270.0	V	345.0	17.1	15.3	36.0	

Plot 12: 1 GHz to 12.75 GHz, 5260 MHz, vertical & horizontal polarization

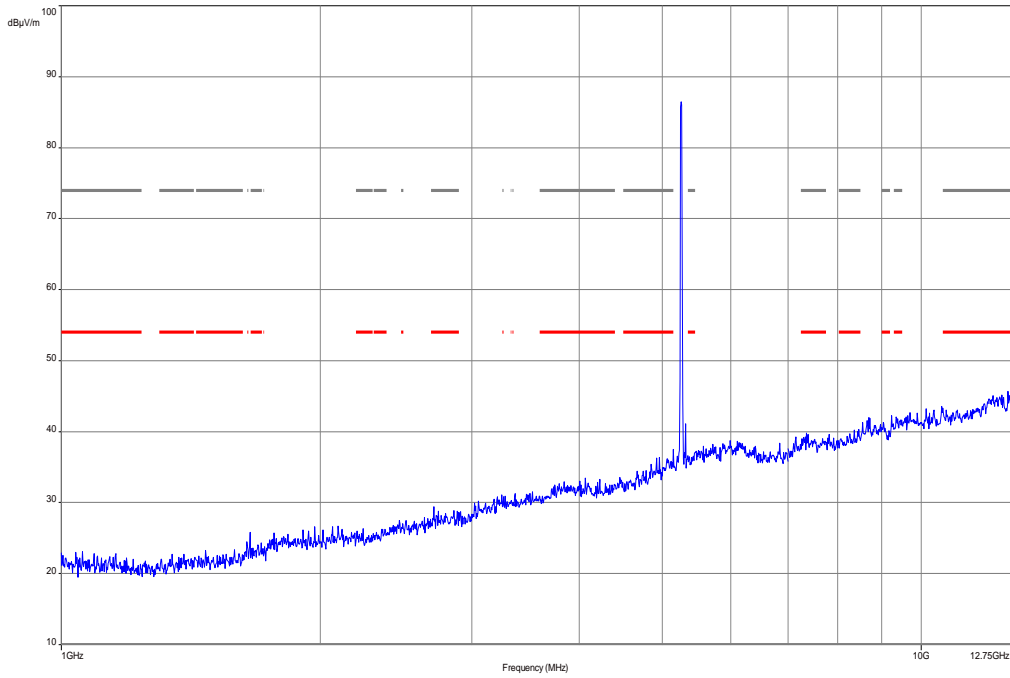

Plot 13: 12 GHz to 18 GHz, 5260 MHz, vertical & horizontal polarization

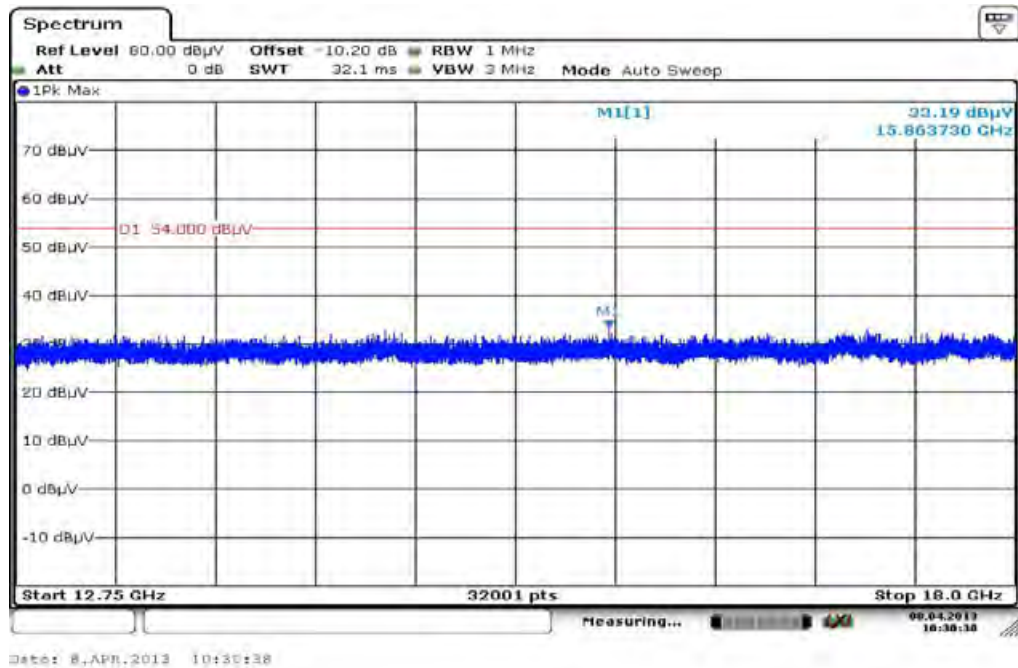

Plot 14: 18 GHz to 26 GHz, 5260 MHz, vertical & horizontal polarization

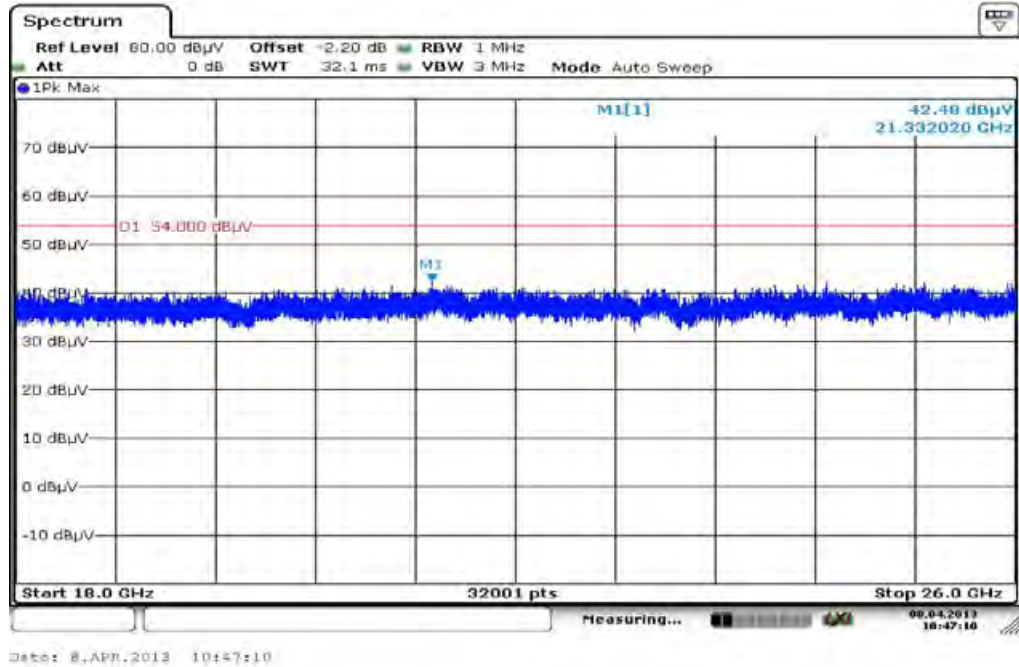

Plot 15: 26 GHz to 40 GHz, 5260 MHz, vertical & horizontal polarization

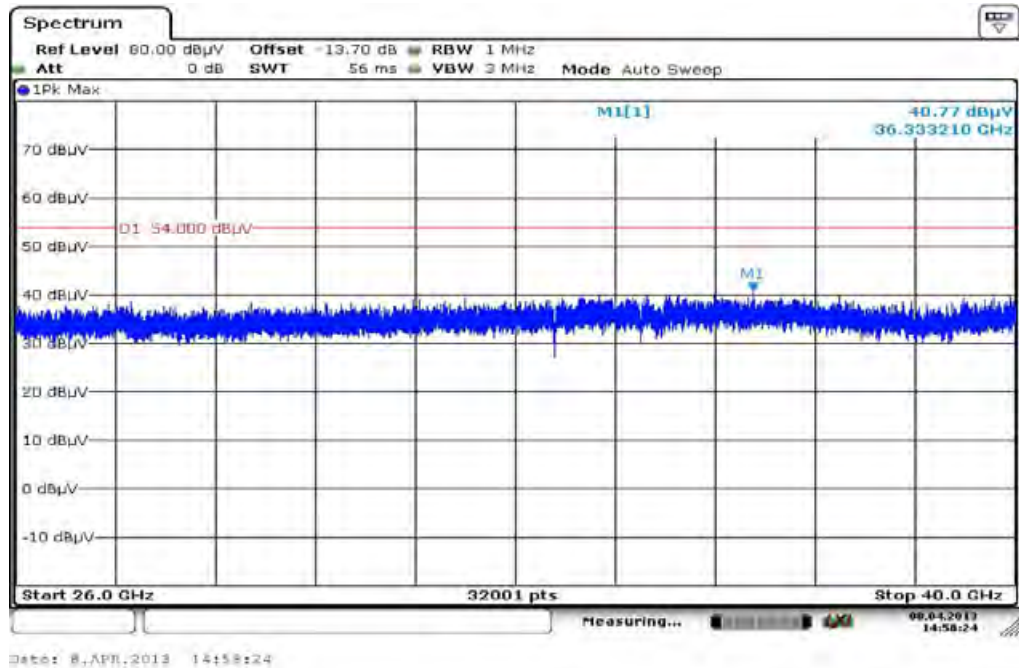

Plot 16: 30 MHz to 1 GHz, 5320 MHz, vertical & horizontal polarization

Common Information

EUT: TM-0030-BV
 Serial Number: CB5A1NY07J
 Test Description: FCC part 15 C class B @ 10 m
 Operating Conditions: wlan a-mode ch 64 + charging
 Operator Name: Wolsdorfer
 Comment: USB powered

Scan Setup: STAN_Fin [EMI radiated]

Hardware Setup: Electric Field (NOS)
 Receiver: [ESCI 3]
 Level Unit: dBµV/m

Subrange	Step Size	Detectors	IF BW	Meas. Time	Preamp
30 MHz - 2 GHz	60 kHz	QPK	120 kHz	1 s	20 dB

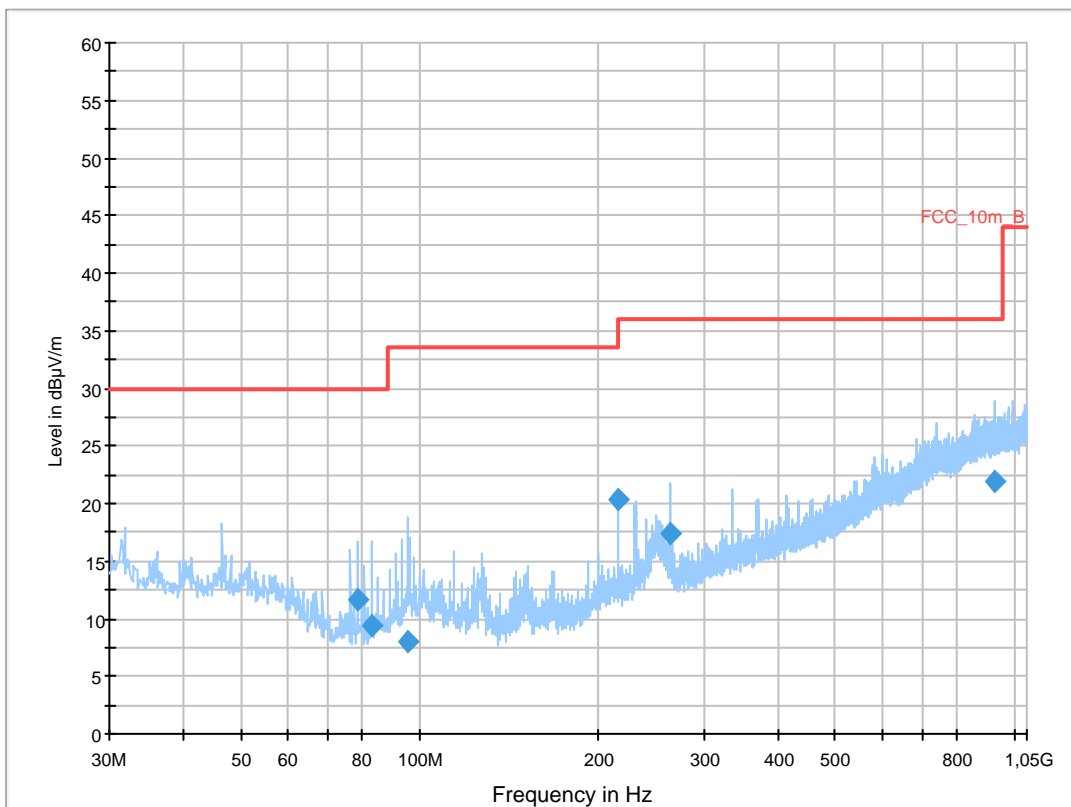

Final Result 1

Frequency (MHz)	QuasiPeak (dBµV/m)	Meas. Time (ms)	Bandwidth (kHz)	Height (cm)	Polarization	Azimuth (deg)	Corr. (dB)	Margin (dB)	Limit (dBµV/m)	Comment
78.600000	11.6	1000.0	120.000	98.0	V	0.0	9.1	18.4	30.0	
82.800000	9.4	1000.0	120.000	246.0	V	0.0	9.5	20.6	30.0	
95.520000	8.0	1000.0	120.000	105.0	V	0.0	11.3	25.5	33.5	
216.000000	20.3	1000.0	120.000	98.0	V	123.0	12.3	15.7	36.0	
264.000000	17.5	1000.0	120.000	104.0	V	109.0	13.7	18.5	36.0	
927.600000	21.9	1000.0	120.000	270.0	H	19.0	25.3	14.1	36.0	

Plot 17: 1 GHz to 12.75 GHz, 5320 MHz, vertical & horizontal polarization

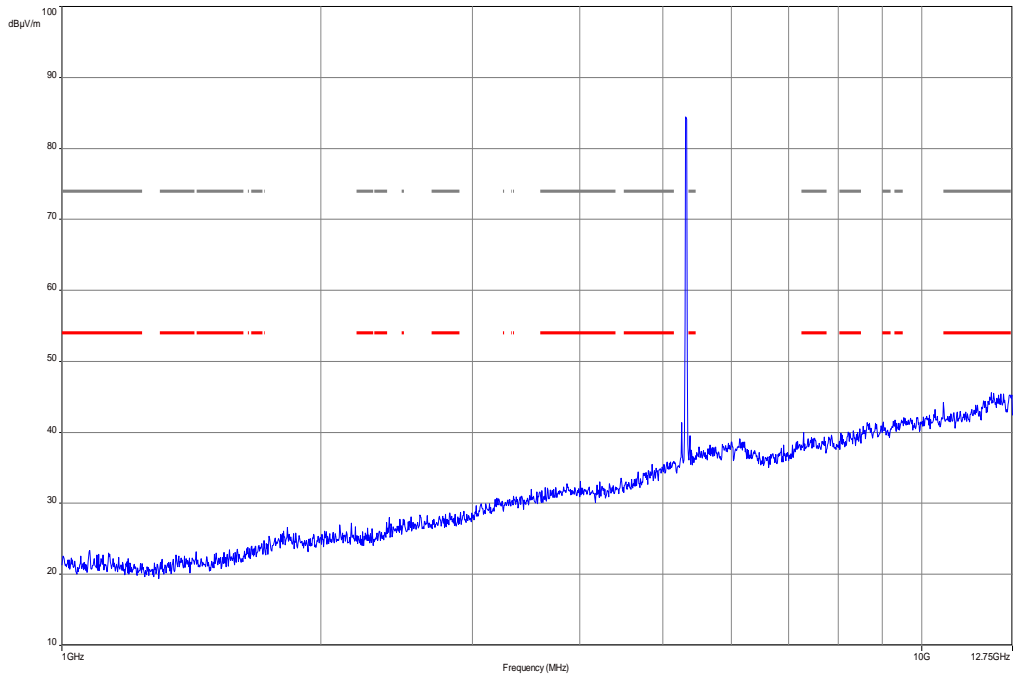

Plot 18: 12 GHz to 18 GHz, 5320 MHz, vertical & horizontal polarization

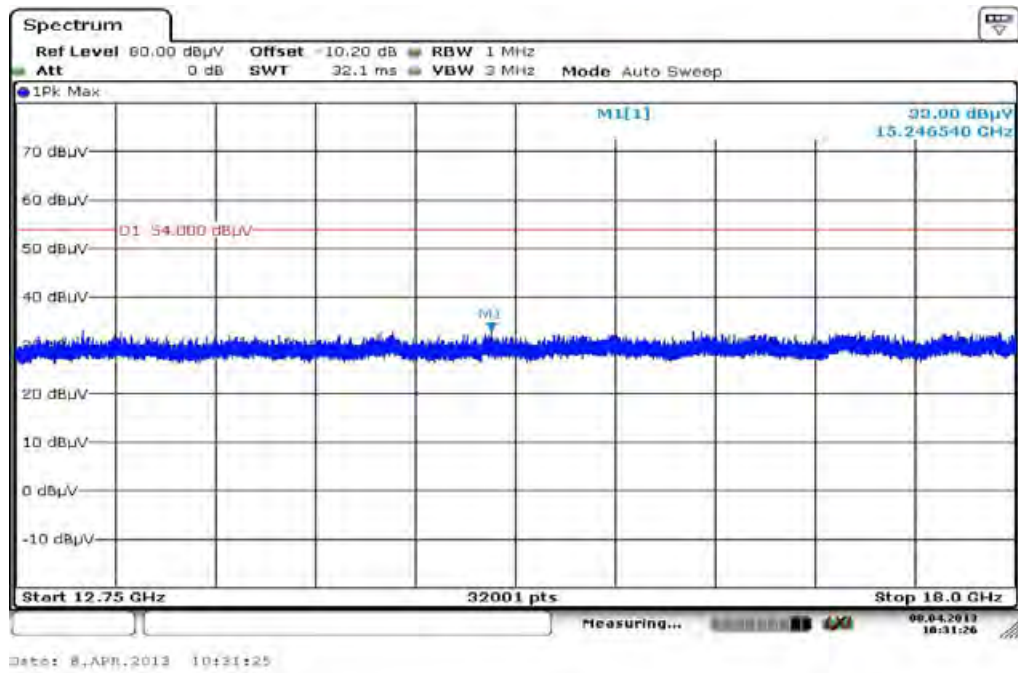

Plot 19: 18 GHz to 26 GHz, 5320 MHz, vertical & horizontal polarization

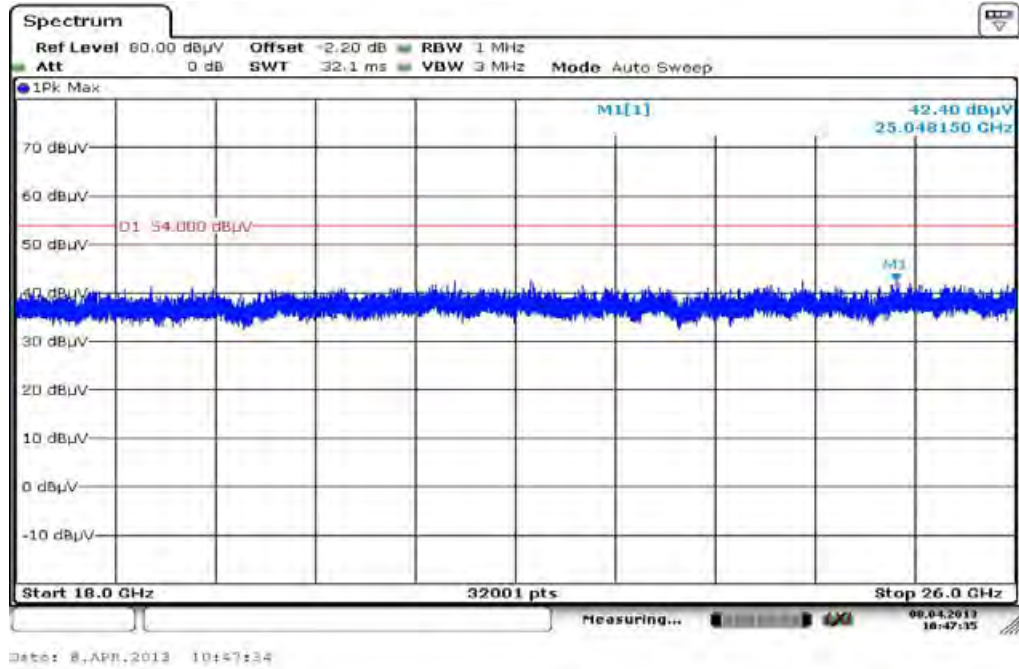

Plot 20: 26 GHz to 40 GHz, 5320 MHz, vertical & horizontal polarization

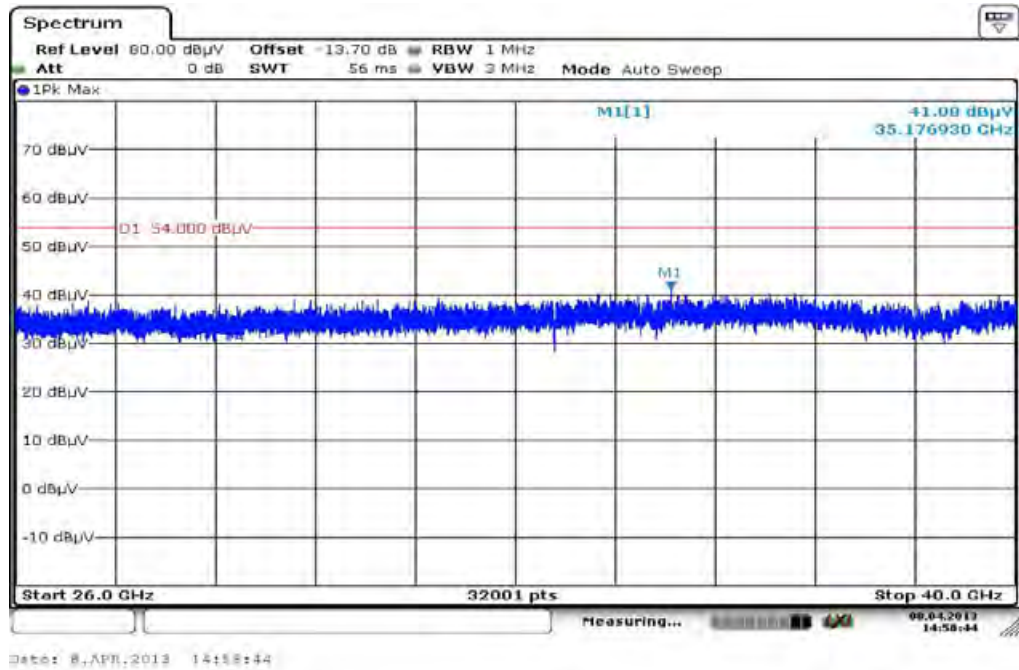

Plot 21: 30 MHz to 1 GHz, 5500 MHz, vertical & horizontal polarization

Common Information

EUT: TM-0030-BV
 Serial Number: CB5A1NY07J
 Test Description: FCC part 15 C class B @ 10 m
 Operating Conditions: wlan a-mode ch 100 + charging
 Operator Name: Wolsdorfer
 Comment: USB powered

Scan Setup: STAN_Fin [EMI radiated]

Hardware Setup: Electric Field (NOS)
 Receiver: [ESCI 3]
 Level Unit: dBµV/m

Subrange	Step Size	Detectors	IF BW	Meas. Time	Preamp
30 MHz - 2 GHz	60 kHz	QPK	120 kHz	1 s	20 dB

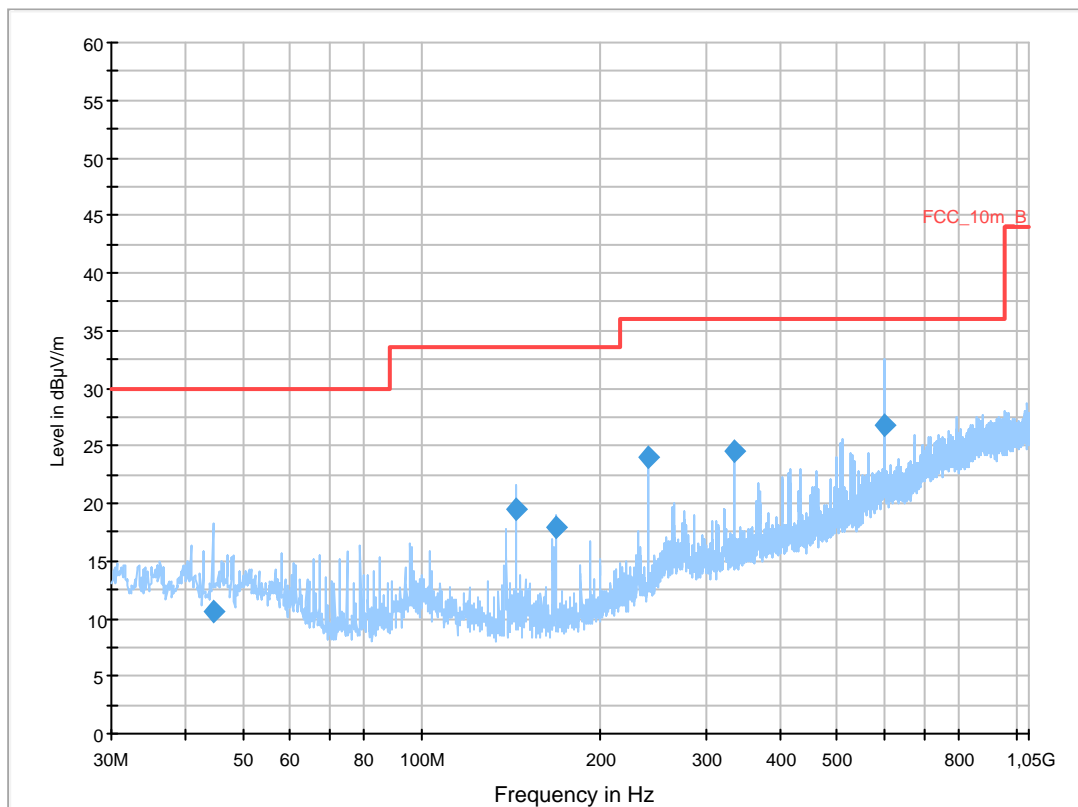

Final Result 1

Frequency (MHz)	QuasiPeak (dBµV/m)	Meas. Time (ms)	Bandwidth (kHz)	Height (cm)	Polarization	Azimuth (deg)	Corr. (dB)	Margin (dB)	Limit (dBµV/m)	Comment
44.400000	10.7	1000.0	120.000	270.0	V	150.0	13.3	19.3	30.0	
144.000000	19.5	1000.0	120.000	111.0	V	40.0	8.8	14.0	33.5	
168.000000	18.0	1000.0	120.000	132.0	V	81.0	9.7	15.5	33.5	
240.000000	24.0	1000.0	120.000	98.0	V	117.0	13.0	12.0	36.0	
336.000000	24.6	1000.0	120.000	121.0	V	319.0	15.6	11.4	36.0	
600.000000	26.9	1000.0	120.000	98.0	V	319.0	20.8	9.1	36.0	

Plot 22: 1 GHz to 12.75 GHz, 5500 MHz, vertical & horizontal polarization

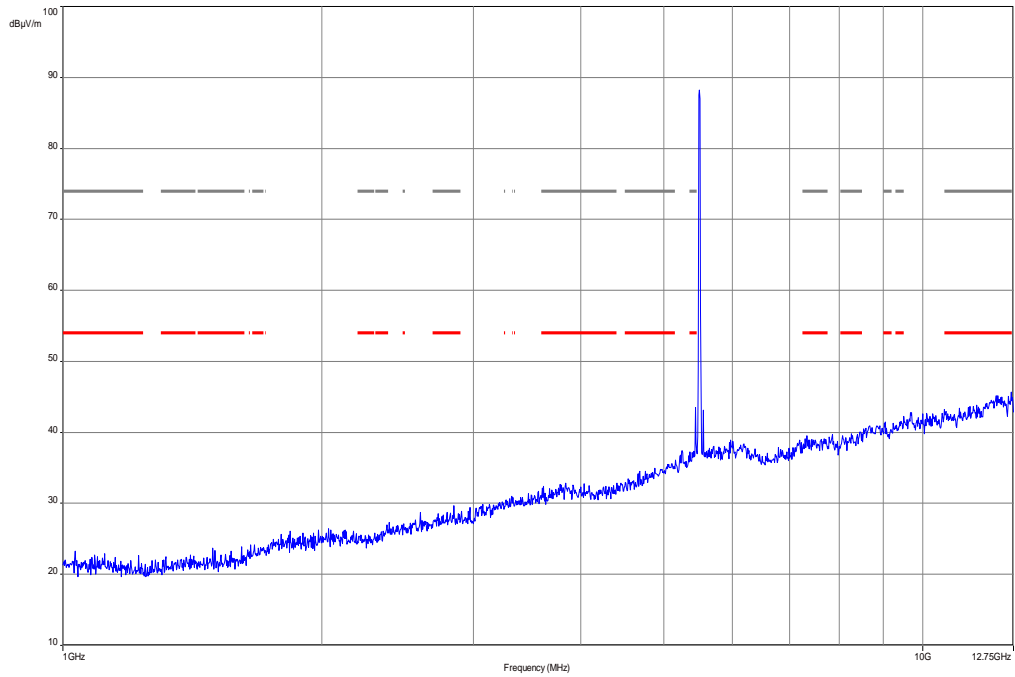

Plot 23: 12 GHz to 18 GHz, 5500 MHz, vertical & horizontal polarization

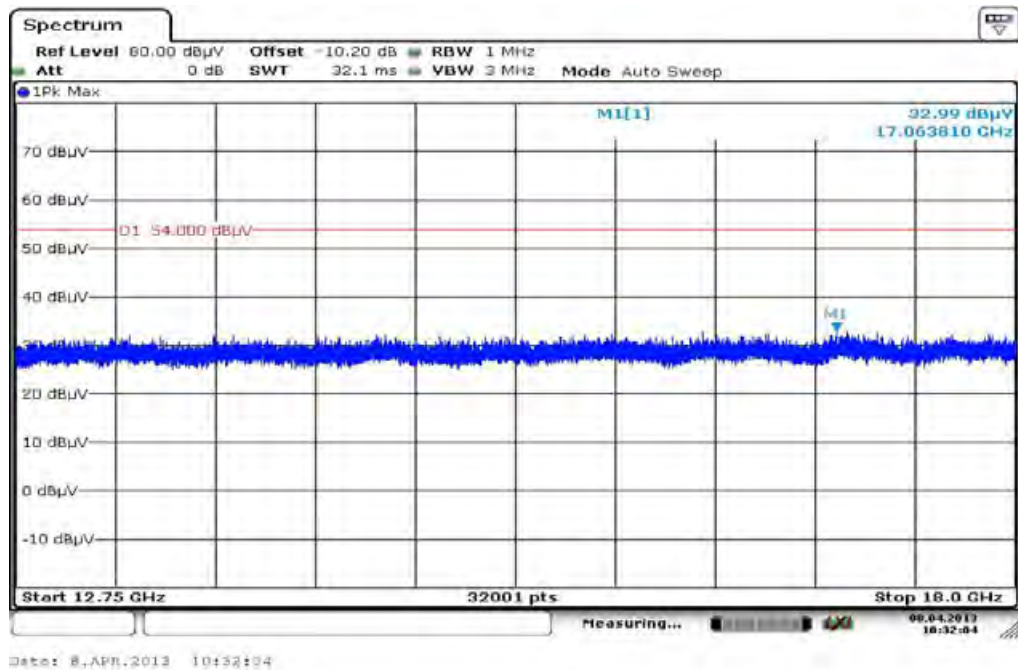

Plot 24: 18 GHz to 26 GHz, 5500 MHz, vertical & horizontal polarization

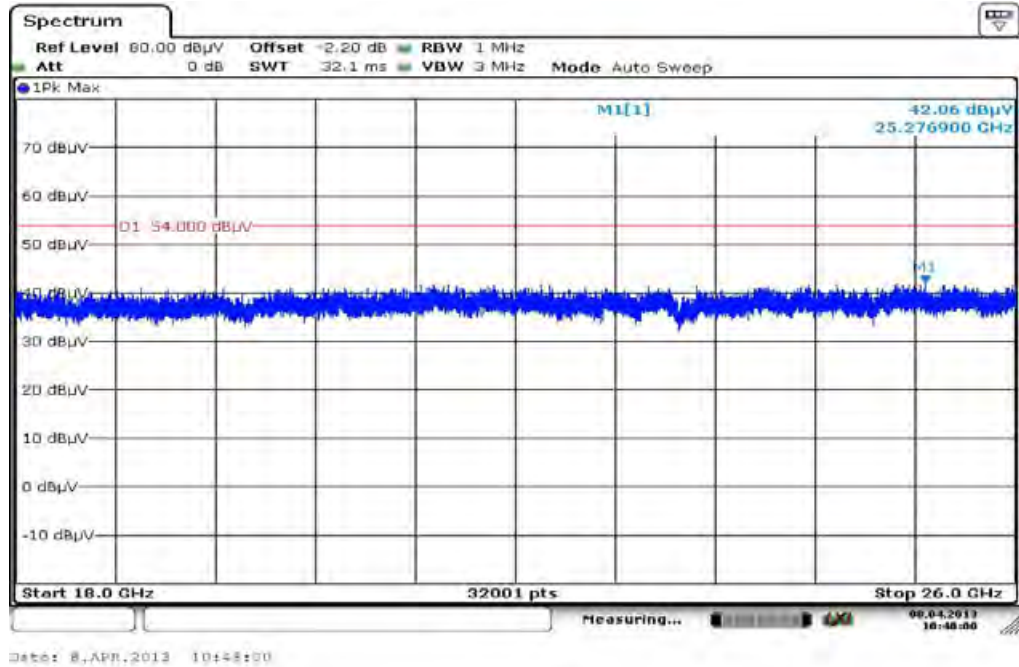

Plot 25: 26 GHz to 40 GHz, 5500 MHz, vertical & horizontal polarization

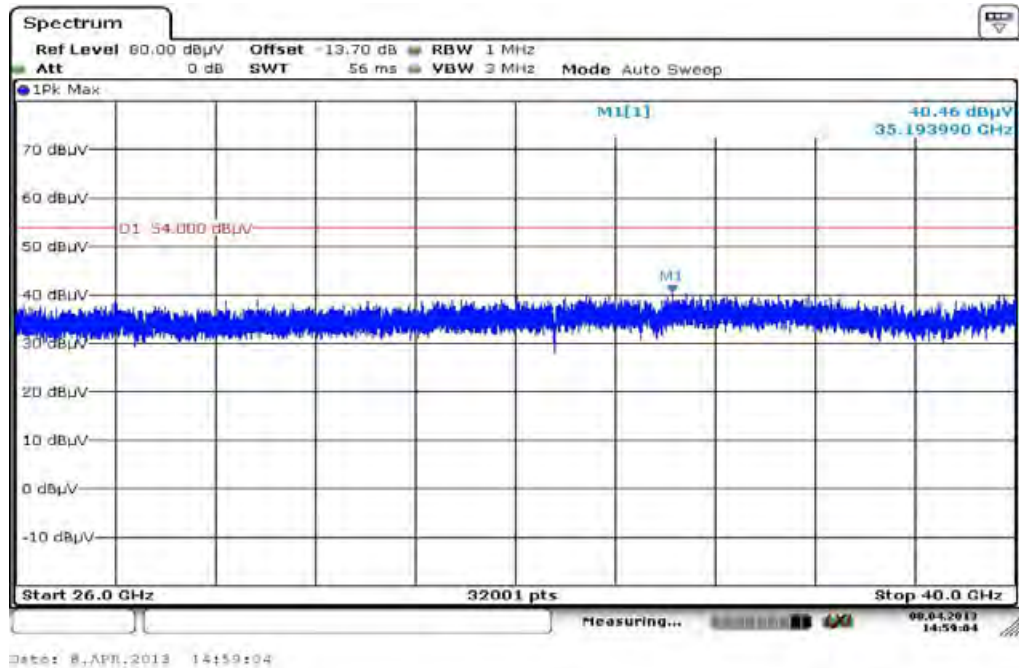

Plot 26: 30 MHz to 1 GHz, 5600 MHz, vertical & horizontal polarization

Common Information

EUT: TM-0030-BV
 Serial Number: CB5A1NY07J
 Test Description: FCC part 15 C class B @ 10 m
 Operating Conditions: wlan a-mode ch 120 + charging
 Operator Name: Wolsdorfer
 Comment: USB powered

Scan Setup: STAN_Fin [EMI radiated]

Hardware Setup: Electric Field (NOS)
 Receiver: [ESCI 3]
 Level Unit: dBµV/m

Subrange	Step Size	Detectors	IF BW	Meas. Time	Preamp
30 MHz - 2 GHz	60 kHz	QPK	120 kHz	1 s	20 dB

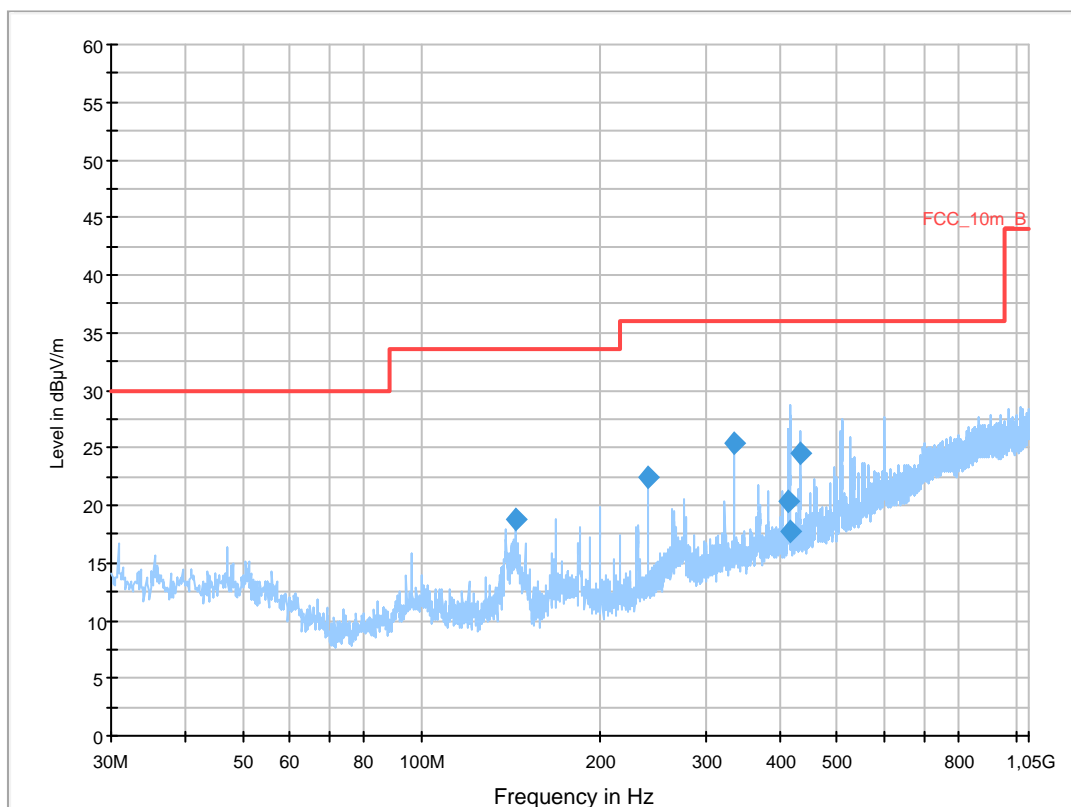

Final Result 1

Frequency (MHz)	QuasiPeak (dBµV/m)	Meas. Time (ms)	Bandwidth (kHz)	Height (cm)	Polarization	Azimuth (deg)	Corr. (dB)	Margin (dB)	Limit (dBµV/m)	Comment
144.000000	18.9	1000.0	120.000	270.0	V	323.0	8.8	14.6	33.5	
240.000000	22.4	1000.0	120.000	121.0	V	114.0	13.0	13.6	36.0	
336.000000	25.4	1000.0	120.000	258.0	V	235.0	15.6	10.6	36.0	
414.840000	20.3	1000.0	120.000	98.0	V	114.0	17.1	15.7	36.0	
415.560000	17.8	1000.0	120.000	270.0	V	53.0	17.1	18.2	36.0	
432.000000	24.6	1000.0	120.000	159.0	V	195.0	17.4	11.4	36.0	

Plot 27: 1 GHz to 12.75 GHz, 5600 MHz, vertical & horizontal polarization

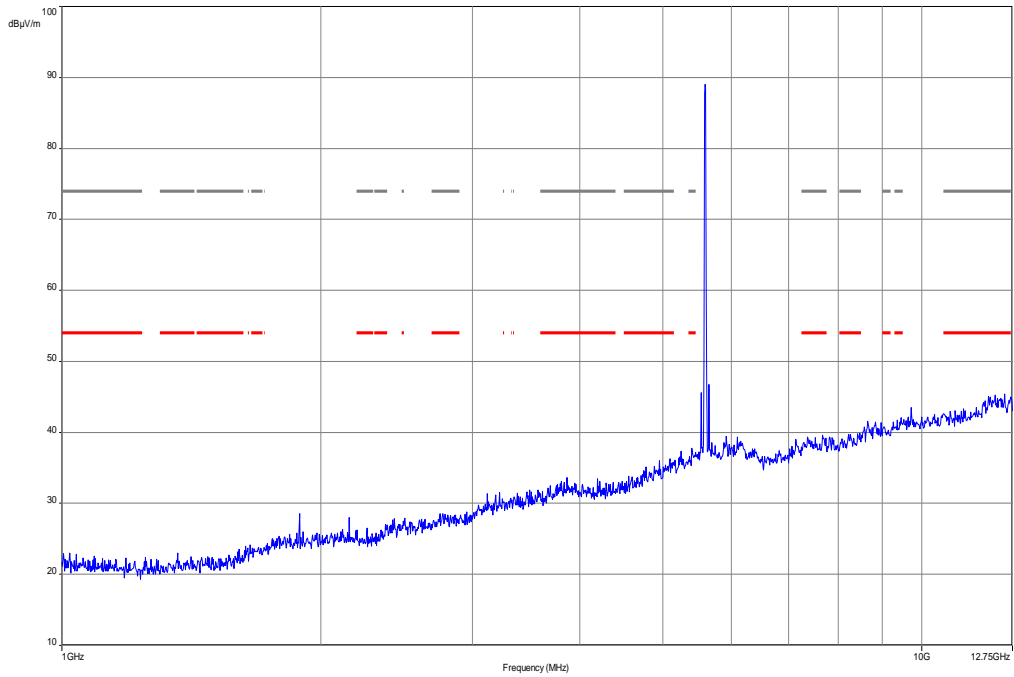

Plot 28: 12 GHz to 18 GHz, 5600 MHz, vertical & horizontal polarization

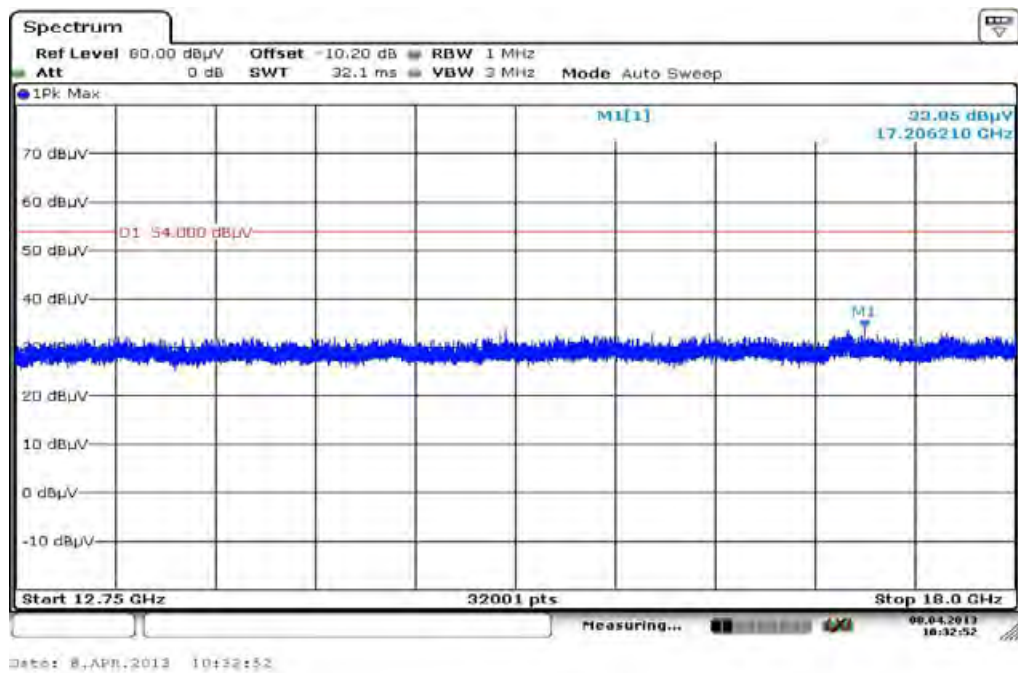

Plot 29: 18 GHz to 26 GHz, 5600 MHz, vertical & horizontal polarization

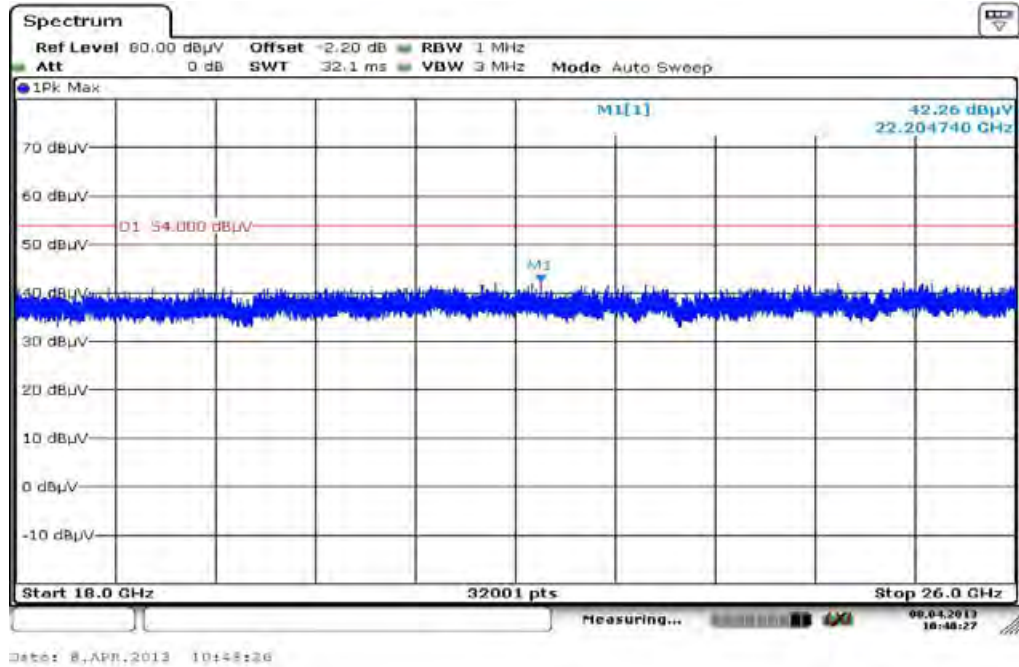

Plot 30: 26 GHz to 40 GHz, 5600 MHz, vertical & horizontal polarization

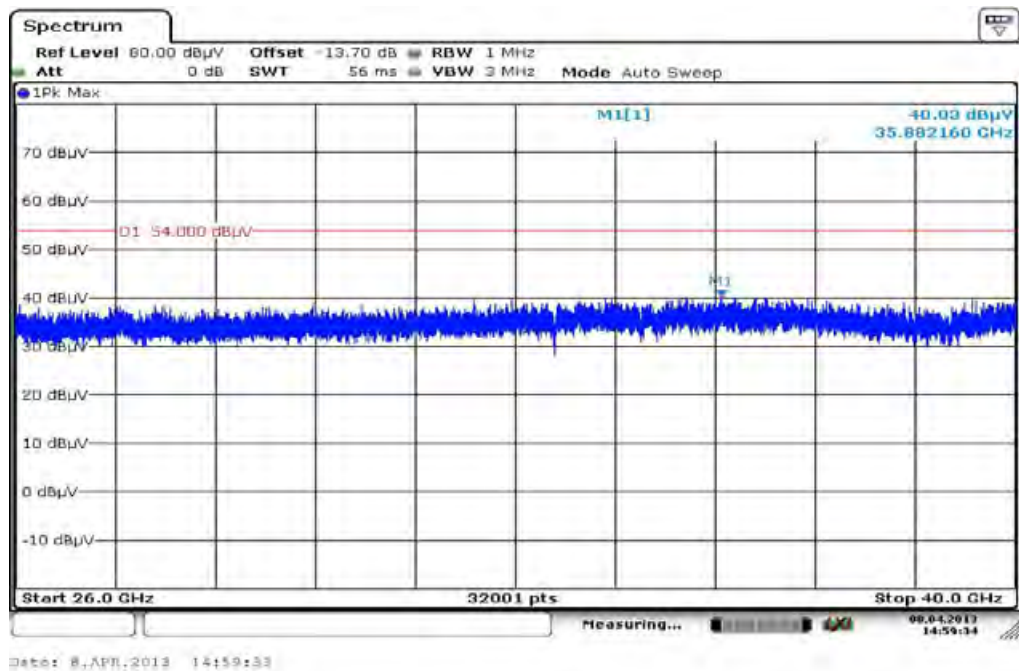

Plot 31: 30 MHz to 1 GHz, 5700 MHz, vertical & horizontal polarization

Common Information

EUT: TM-0030-BV
 Serial Number: CB5A1NY07J
 Test Description: FCC part 15 C class B @ 10 m
 Operating Conditions: wlan a-mode ch 140 + charging
 Operator Name: Wolsdorfer
 Comment: USB powered

Scan Setup: STAN_Fin [EMI radiated]

Hardware Setup: Electric Field (NOS)
 Receiver: [ESCI 3]
 Level Unit: dBµV/m

Subrange	Step Size	Detectors	IF BW	Meas. Time	Preamp
30 MHz - 2 GHz	60 kHz	QPK	120 kHz	1 s	20 dB

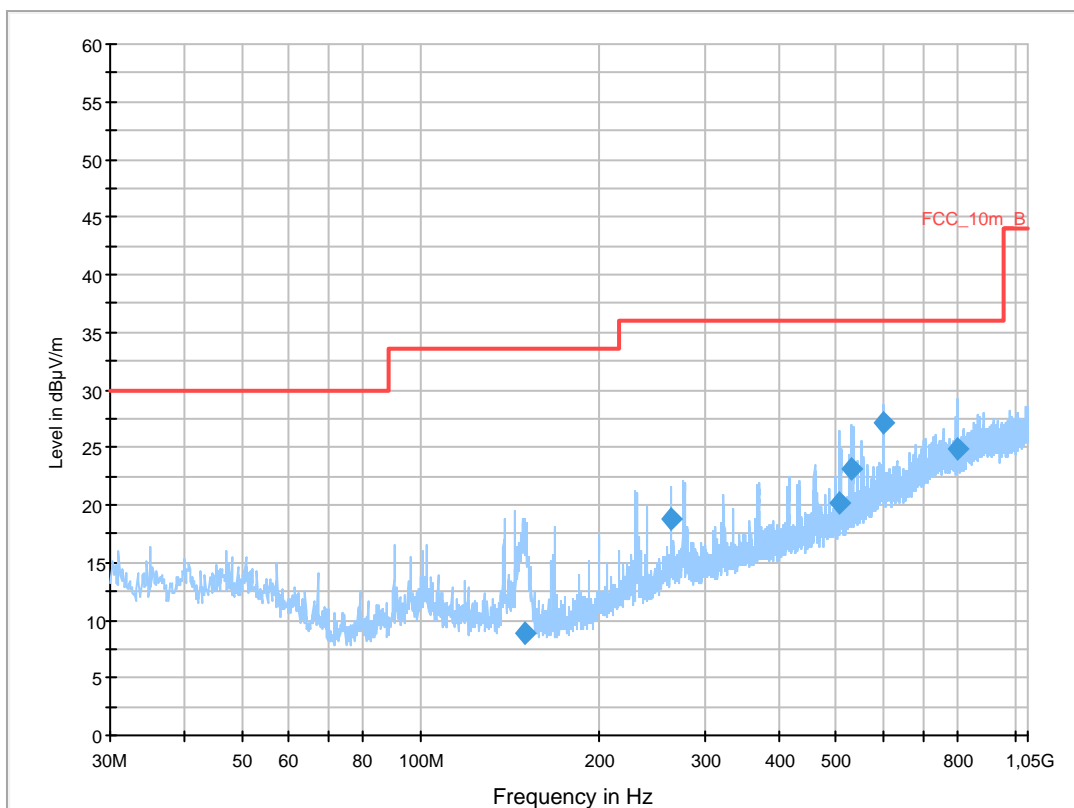

Final Result 1

Frequency (MHz)	QuasiPeak (dBµV/m)	Meas. Time (ms)	Bandwidth (kHz)	Height (cm)	Polarization	Azimuth (deg)	Corr. (dB)	Margin (dB)	Limit (dBµV/m)	Comment
149.760000	8.9	1000.0	120.000	270.0	V	34.0	8.9	24.6	33.5	
264.000000	18.8	1000.0	120.000	120.0	V	316.0	13.7	17.2	36.0	
507.960000	20.1	1000.0	120.000	157.0	V	155.0	18.8	15.9	36.0	
531.000000	23.2	1000.0	120.000	120.0	V	297.0	19.1	12.8	36.0	
600.000000	27.2	1000.0	120.000	98.0	V	0.0	20.8	8.8	36.0	
799.560000	24.9	1000.0	120.000	98.0	V	6.0	23.8	11.1	36.0	

Plot 32: 1 GHz to 12.75 GHz, 5700 MHz, vertical & horizontal polarization

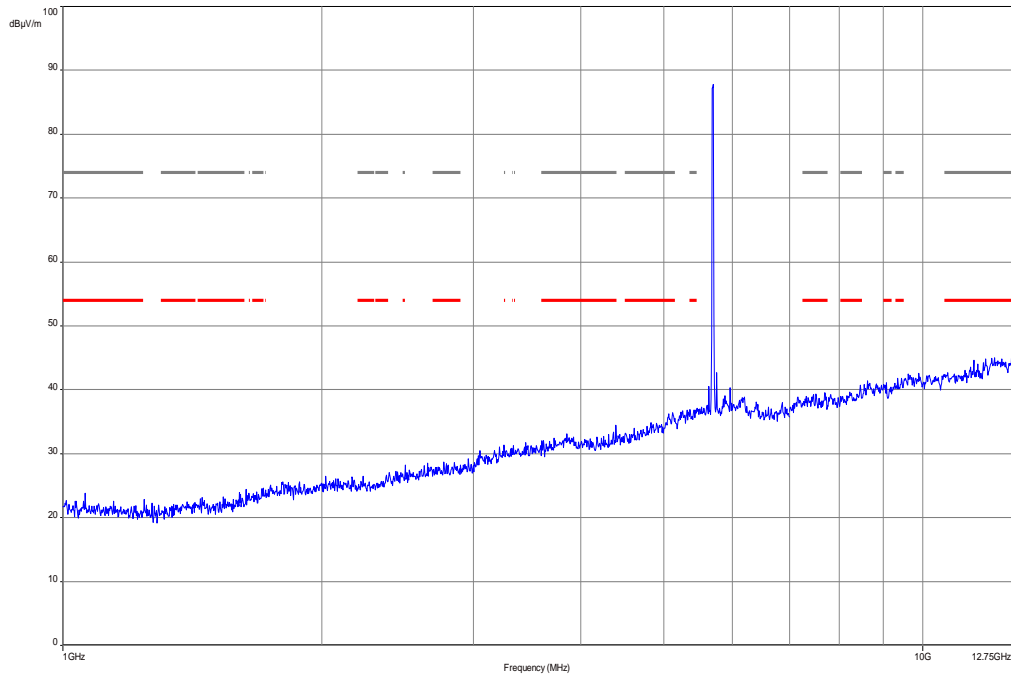

Plot 33: 12 GHz to 18 GHz, 5700 MHz, vertical & horizontal polarization

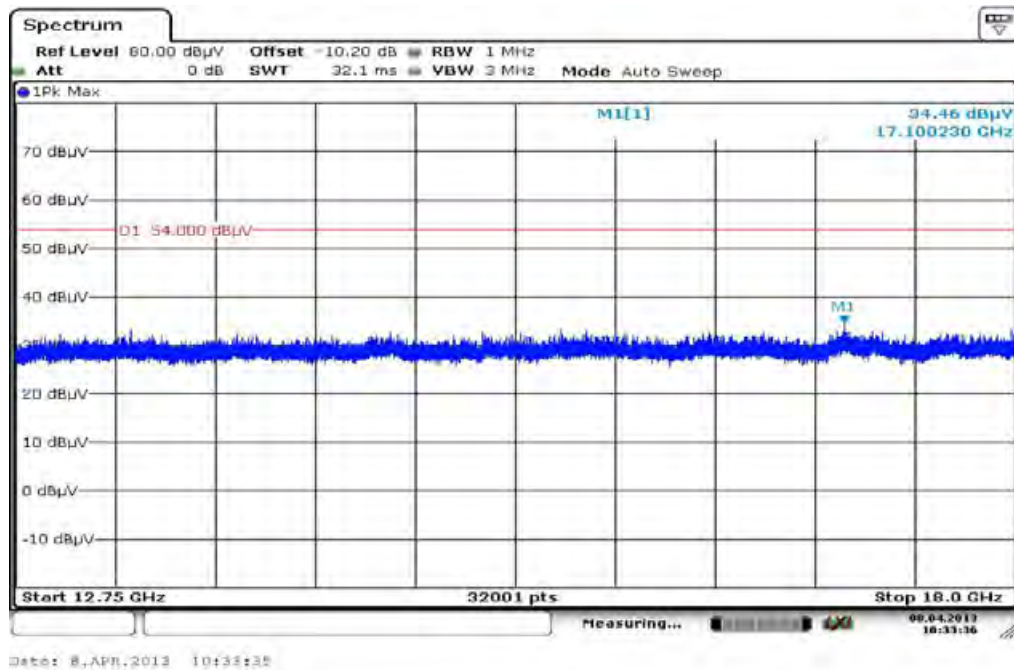

Plot 34: 18 GHz to 26 GHz, 5700 MHz, vertical & horizontal polarization

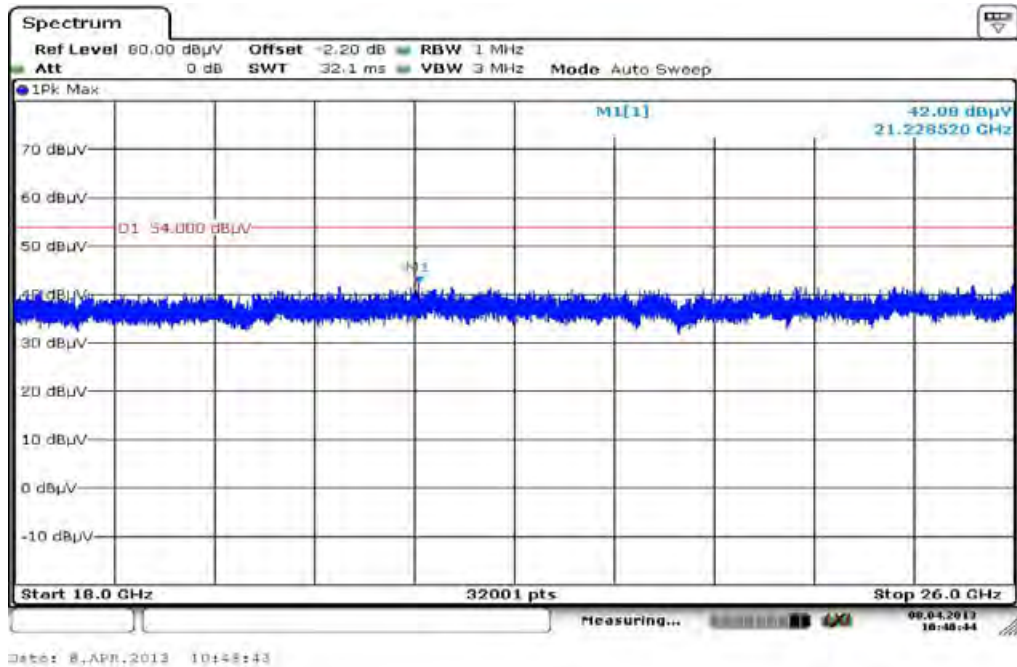

Plot 35: 26 GHz to 40 GHz, 5700 MHz, vertical & horizontal polarization

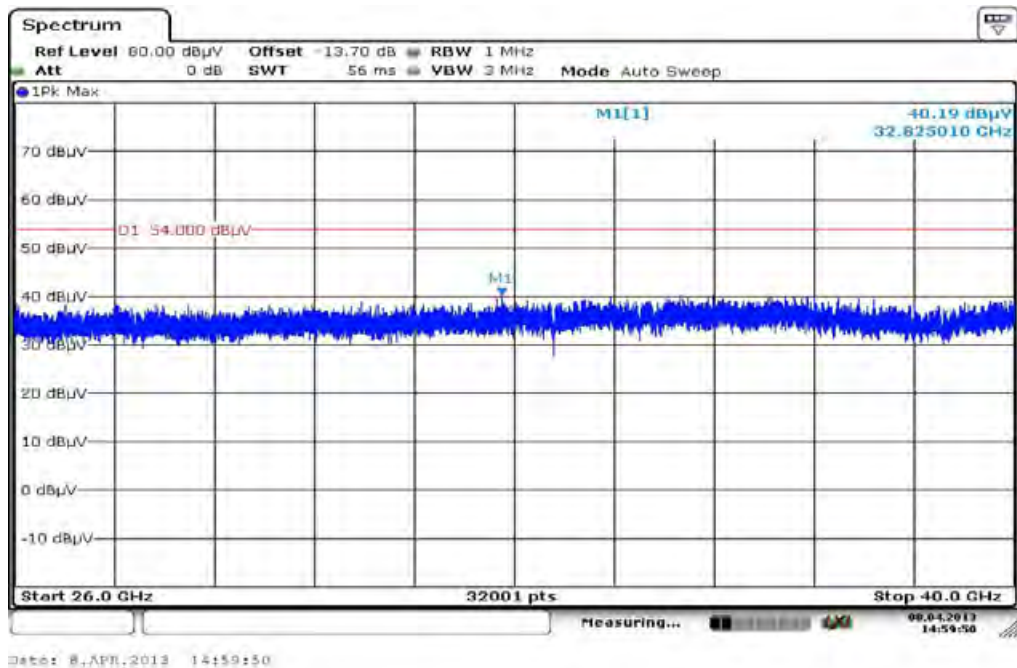

Plots: OFDM / n – mode HT40

Plot 1: 30 MHz to 1 GHz, 5190 MHz, vertical & horizontal polarization

Common Information

EUT: TM-0030-BV
 Serial Number: CB5A1NY07J
 Test Description: FCC part 15 C class B @ 10 m
 Operating Conditions: wlan n-mode HT40 ch 38 + charging
 Operator Name: Wolsdorfer
 Comment: USB powered

Scan Setup: STAN_Fin [EMI radiated]

Hardware Setup: Electric Field (NOS)
 Receiver: [ESCI 3]
 Level Unit: dBµV/m

Subrange	Step Size	Detectors	IF BW	Meas. Time	Preamp
30 MHz - 2 GHz	60 kHz	QPK	120 kHz	1 s	20 dB

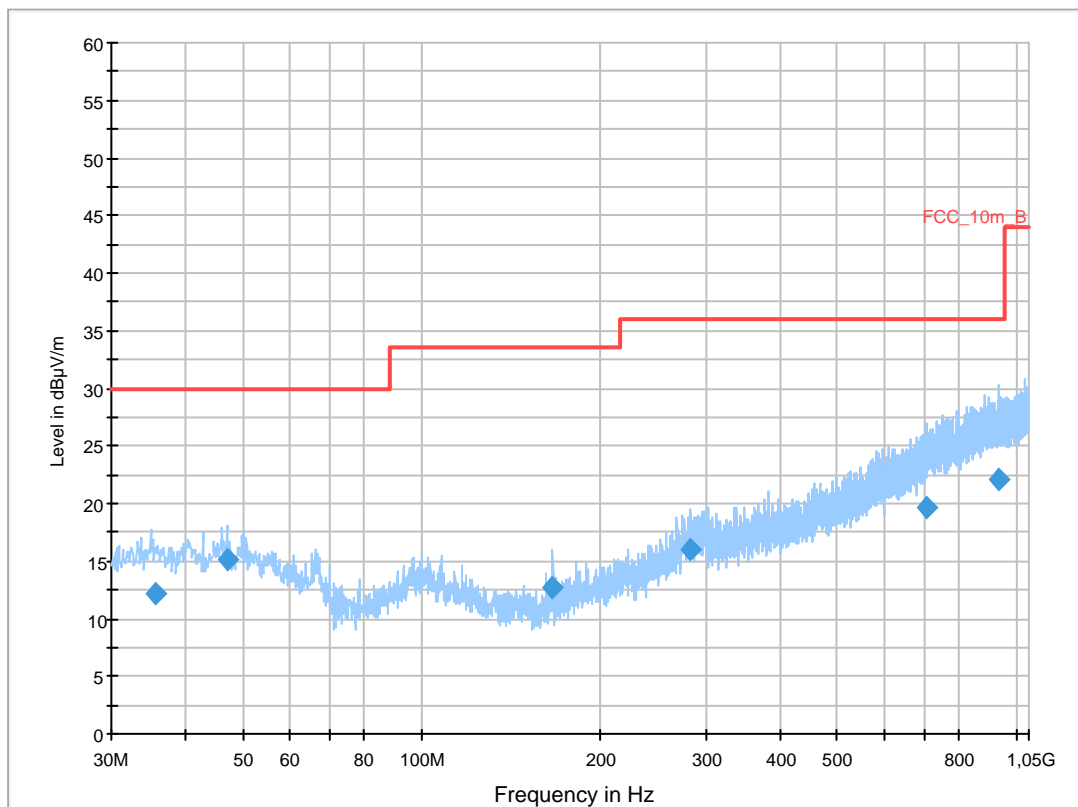

Final Result 1

Frequency (MHz)	QuasiPeak (dBµV/m)	Meas. Time (ms)	Bandwidth (kHz)	Height (cm)	Polarization	Azimuth (deg)	Corr. (dB)	Margin (dB)	Limit (dBµV/m)	Comment
35.498400	12.1	1000.0	120.000	144.0	V	190.0	13.1	17.9	30.0	
46.971450	15.2	1000.0	120.000	111.0	V	10.0	13.3	14.8	30.0	
166.056300	12.6	1000.0	120.000	170.0	V	81.0	9.6	20.9	33.5	
283.016400	15.9	1000.0	120.000	170.0	V	81.0	14.1	20.1	36.0	
704.947950	19.6	1000.0	120.000	98.0	H	10.0	22.6	16.4	36.0	
935.724450	22.1	1000.0	120.000	98.0	H	170.0	25.3	13.9	36.0	

Plot 2: 1 GHz to 12.75 GHz, 5190 MHz, vertical & horizontal polarization

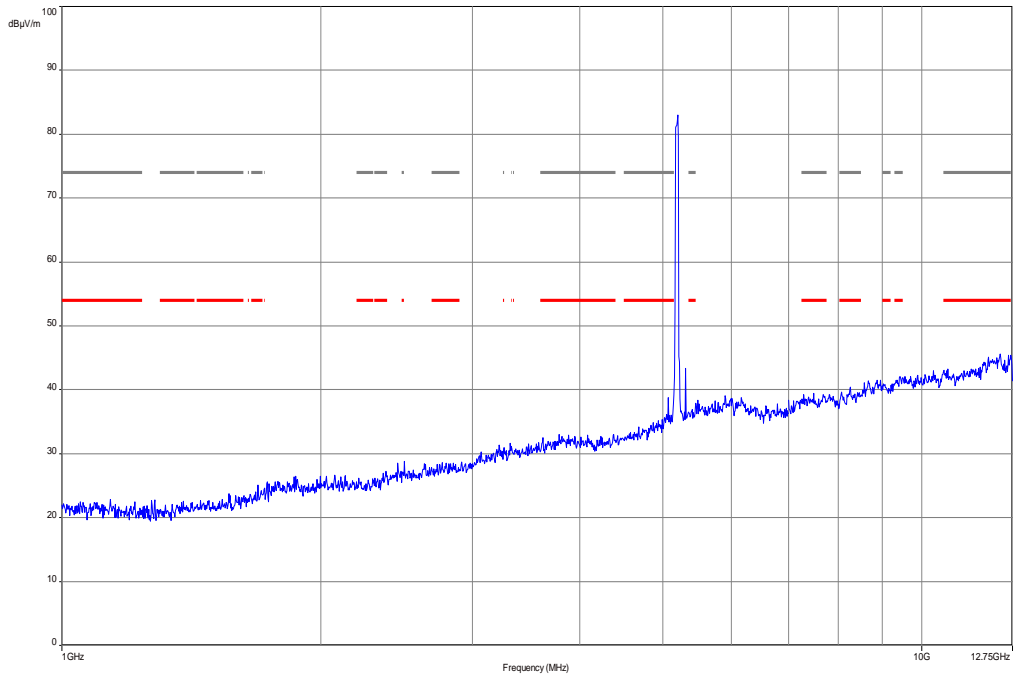

Plot 3: 12 GHz to 18 GHz, 5190 MHz, vertical & horizontal polarization

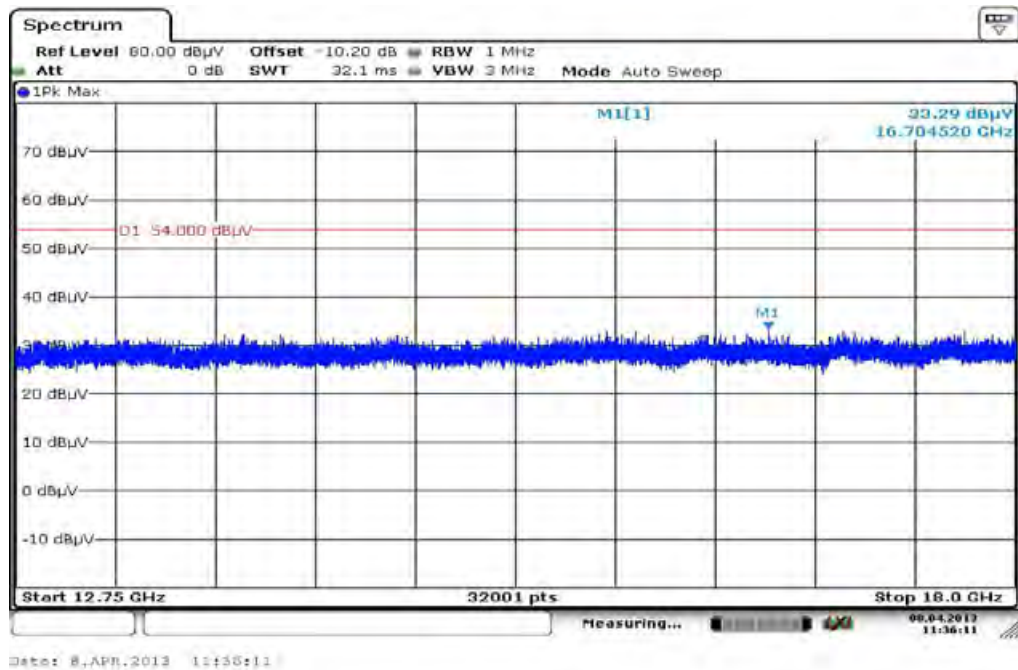

Plot 4: 18 GHz to 26 GHz, 5190 MHz, vertical & horizontal polarization

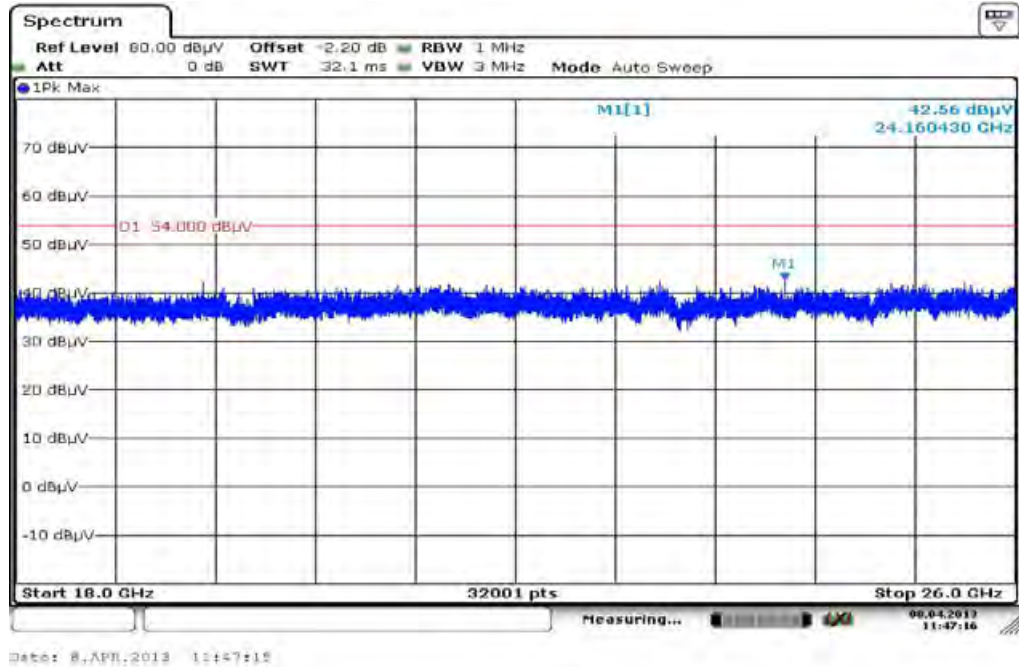

Plot 5: 26 GHz to 40 GHz, 5190 MHz, vertical & horizontal polarization

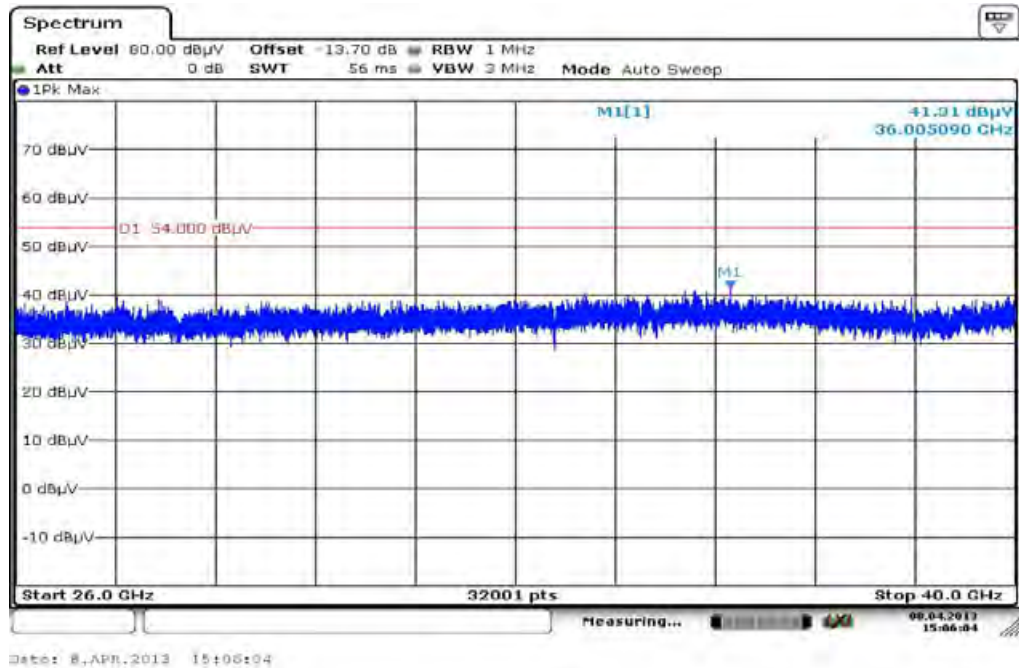

Plot 6: 30 MHz to 1 GHz, 5230 MHz, vertical & horizontal polarization

Common Information

EUT: TM-0030-BV
 Serial Number: CB5A1NY07J
 Test Description: FCC part 15 C class B @ 10 m
 Operating Conditions: wlan n-mode HT40 ch 46 + charging
 Operator Name: Wolsdorfer
 Comment: USB powered

Scan Setup: STAN_Fin [EMI radiated]

Hardware Setup: Electric Field (NOS)
 Level Unit: dBµV/m

Subrange	Step Size	Detectors	IF BW	Meas. Time	Preamp
30 MHz - 2 GHz	60 kHz	QPK	120 kHz	1 s	20 dB

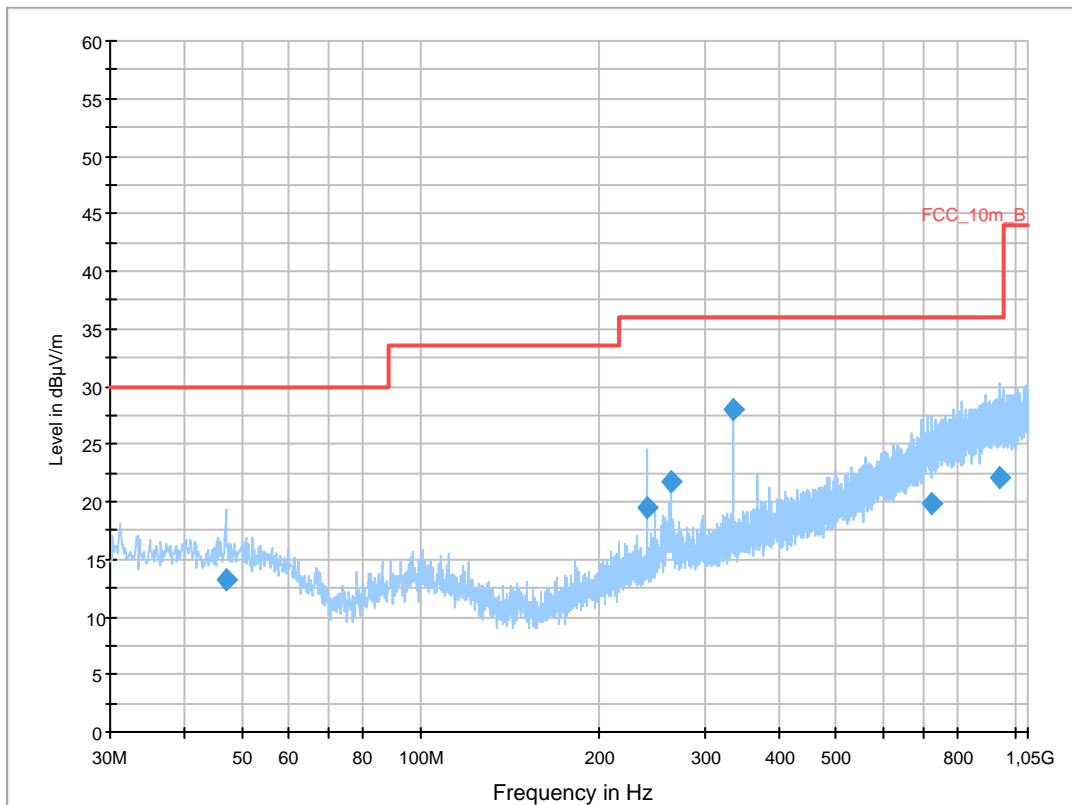

Final Result 1

Frequency (MHz)	QuasiPeak (dBµV/m)	Meas. Time (ms)	Bandwidth (kHz)	Height (cm)	Polarization	Azimuth (deg)	Corr. (dB)	Margin (dB)	Limit (dBµV/m)	Comment
47.052900	13.3	1000.0	120.000	115.0	V	280.0	13.3	16.7	30.0	
239.985600	19.5	1000.0	120.000	98.0	V	260.0	13.0	16.5	36.0	
263.983050	21.8	1000.0	120.000	170.0	V	260.0	13.7	14.2	36.0	
335.995050	28.0	1000.0	120.000	153.0	V	80.0	15.6	8.0	36.0	
721.461600	19.9	1000.0	120.000	170.0	H	87.0	23.0	16.1	36.0	
941.966700	22.1	1000.0	120.000	115.0	H	265.0	25.3	13.9	36.0	

Plot 7: 1 GHz to 12.75 GHz, 5230 MHz, vertical & horizontal polarization

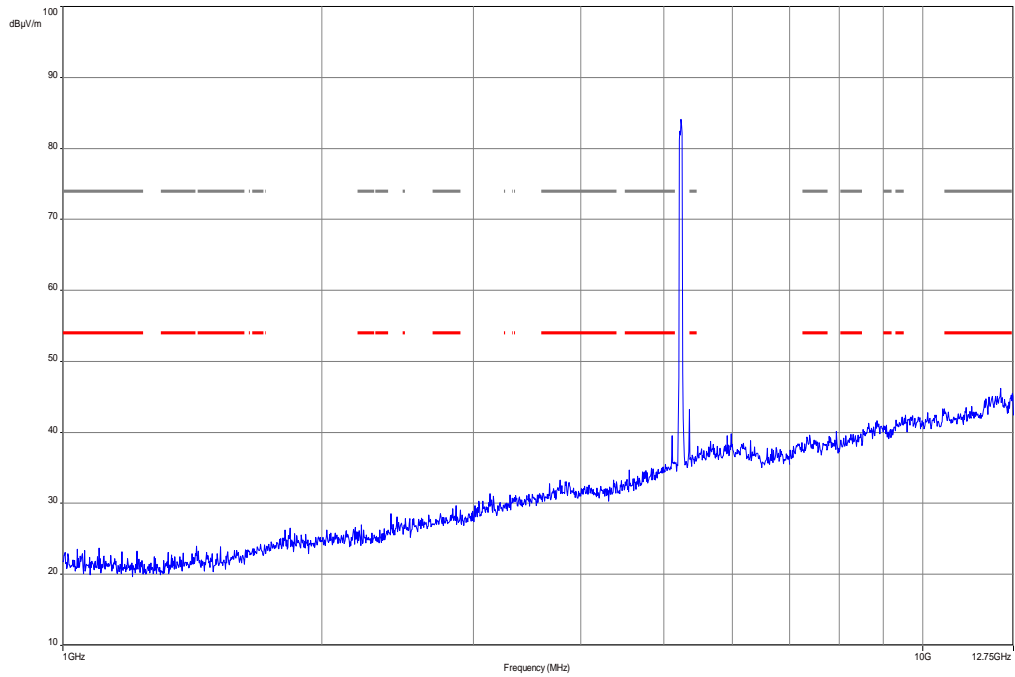

Plot 8: 12 GHz to 18 GHz, 5230 MHz, vertical & horizontal polarization

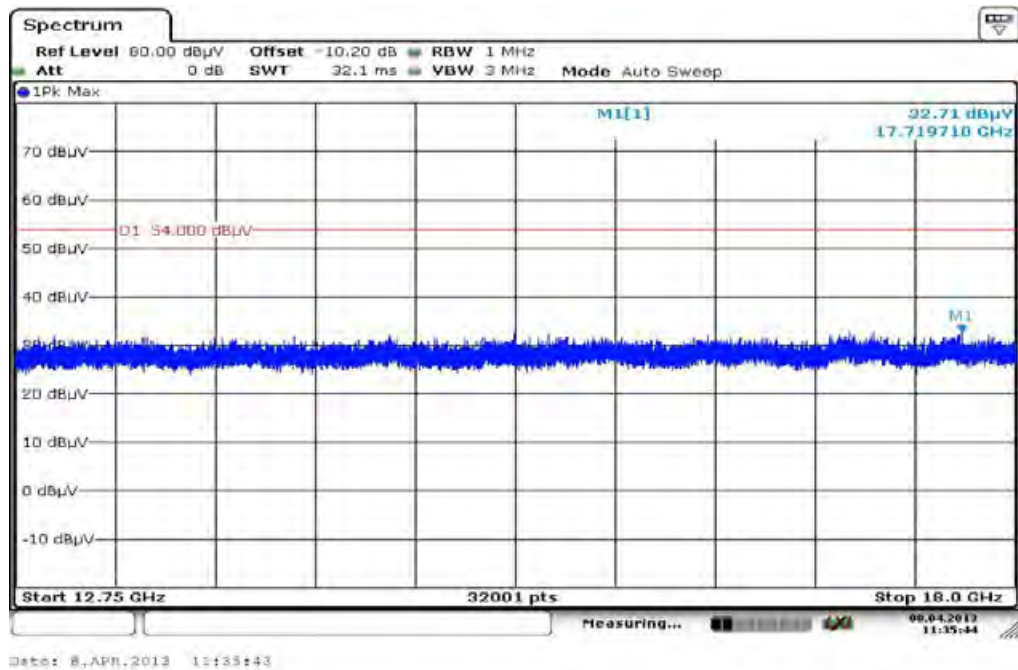

Plot 9: 18 GHz to 26 GHz, 5230 MHz, vertical & horizontal polarization

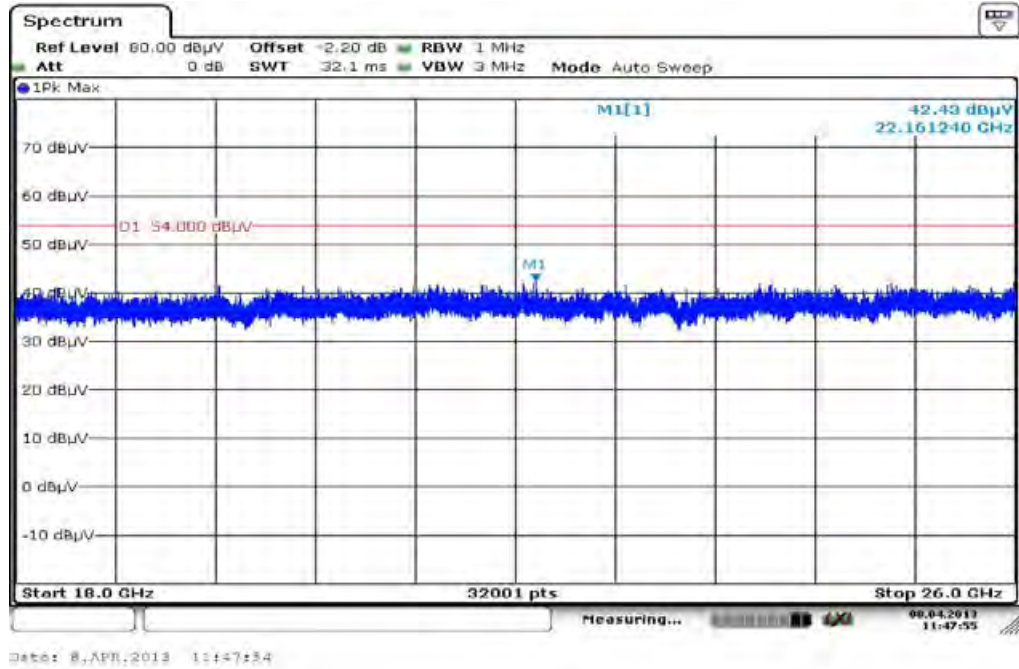

Plot 10: 26 GHz to 40 GHz, 5230 MHz, vertical & horizontal polarization

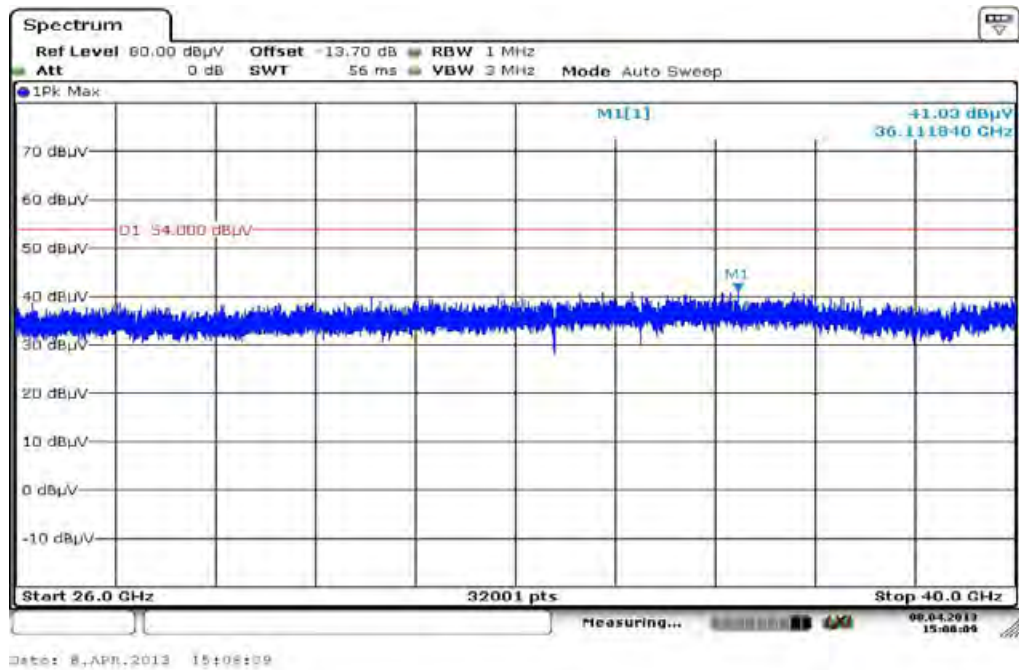

Plot 11: 30 MHz to 1 GHz, 5270 MHz, vertical & horizontal polarization

Common Information

EUT: TM-0030-BV
 Serial Number: CB5A1NY07J
 Test Description: FCC part 15 C class B @ 10 m
 Operating Conditions: wlan n-mode HT40 ch 54 + charging
 Operator Name: Wolsdorfer
 Comment: USB powered

Scan Setup: STAN_Fin [EMI radiated]

Hardware Setup: Electric Field (NOS)
 Receiver: [ESCI 3]
 Level Unit: dBµV/m

Subrange	Step Size	Detectors	IF BW	Meas. Time	Preamp
30 MHz - 2 GHz	60 kHz	QPK	120 kHz	1 s	20 dB

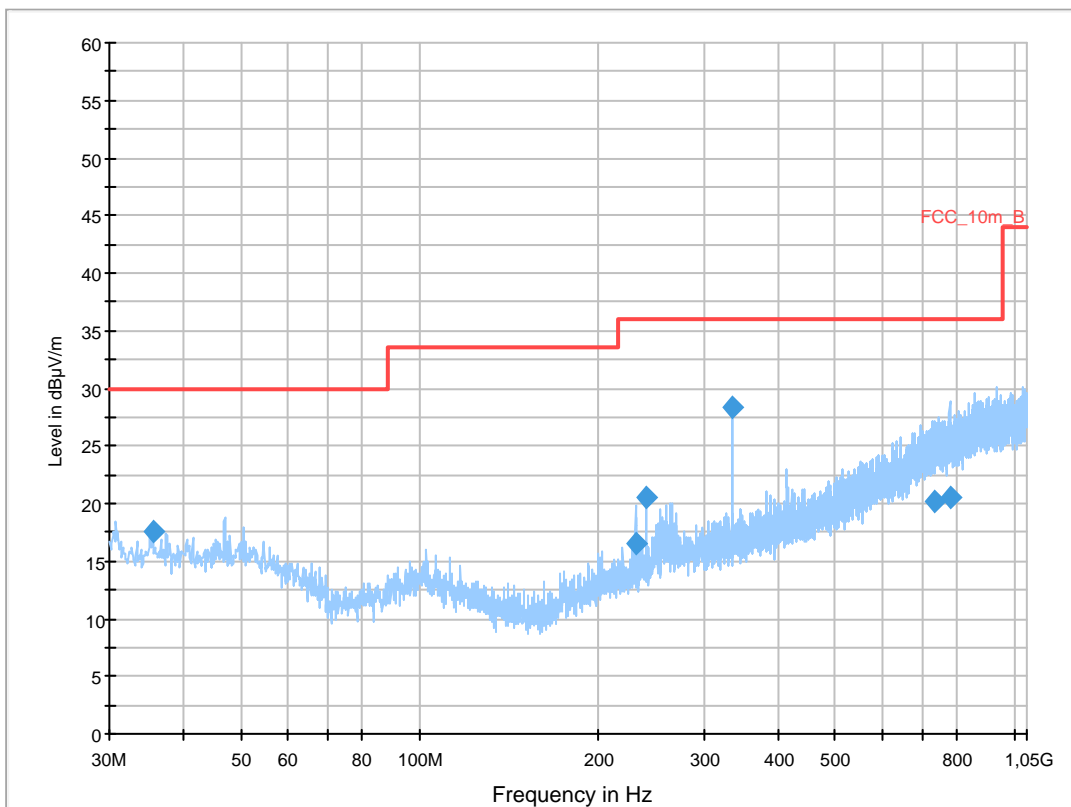

Final Result 1

Frequency (MHz)	QuasiPeak (dBµV/m)	Meas. Time (ms)	Bandwidth (kHz)	Height (cm)	Polarization	Azimuth (deg)	Corr. (dB)	Margin (dB)	Limit (dBµV/m)	Comment
35.507550	17.5	1000.0	120.000	170.0	V	182.0	13.1	12.5	30.0	
230.519700	16.6	1000.0	120.000	98.0	V	100.0	12.7	19.4	36.0	
239.999550	20.6	1000.0	120.000	170.0	V	85.0	13.0	15.4	36.0	
335.990400	28.3	1000.0	120.000	170.0	V	85.0	15.6	7.7	36.0	
732.072900	20.2	1000.0	120.000	170.0	V	182.0	23.2	15.8	36.0	
779.009850	20.6	1000.0	120.000	170.0	V	182.0	23.7	15.4	36.0	

Plot 12: 1 GHz to 12.75 GHz, 5270 MHz, vertical & horizontal polarization

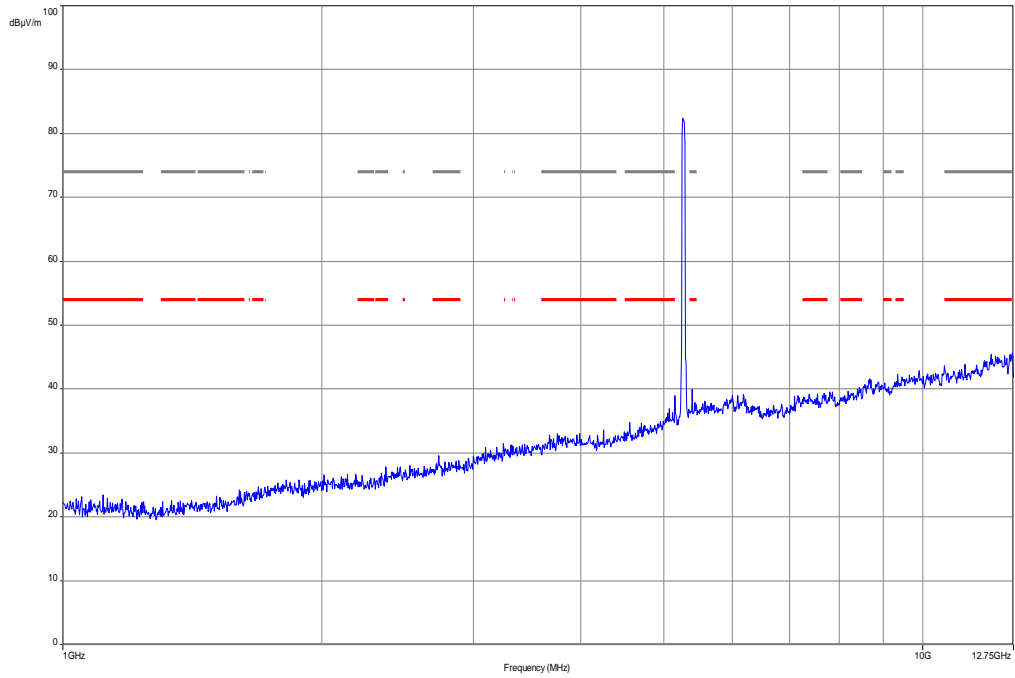

Plot 13: 12 GHz to 18 GHz, 5270 MHz, vertical & horizontal polarization

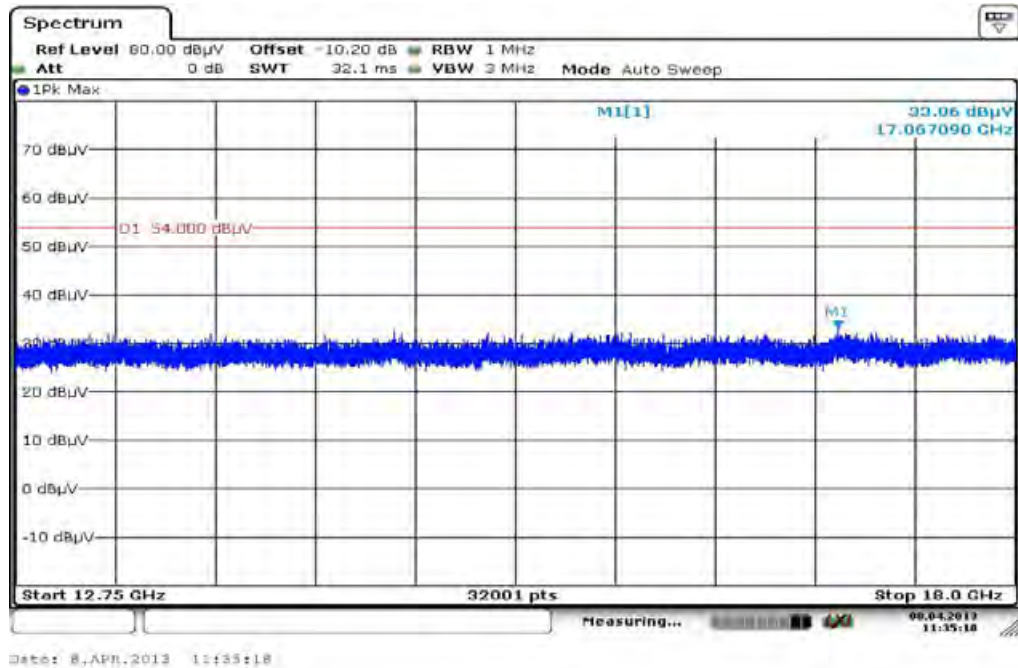

Plot 14: 18 GHz to 26 GHz, 5270 MHz, vertical & horizontal polarization

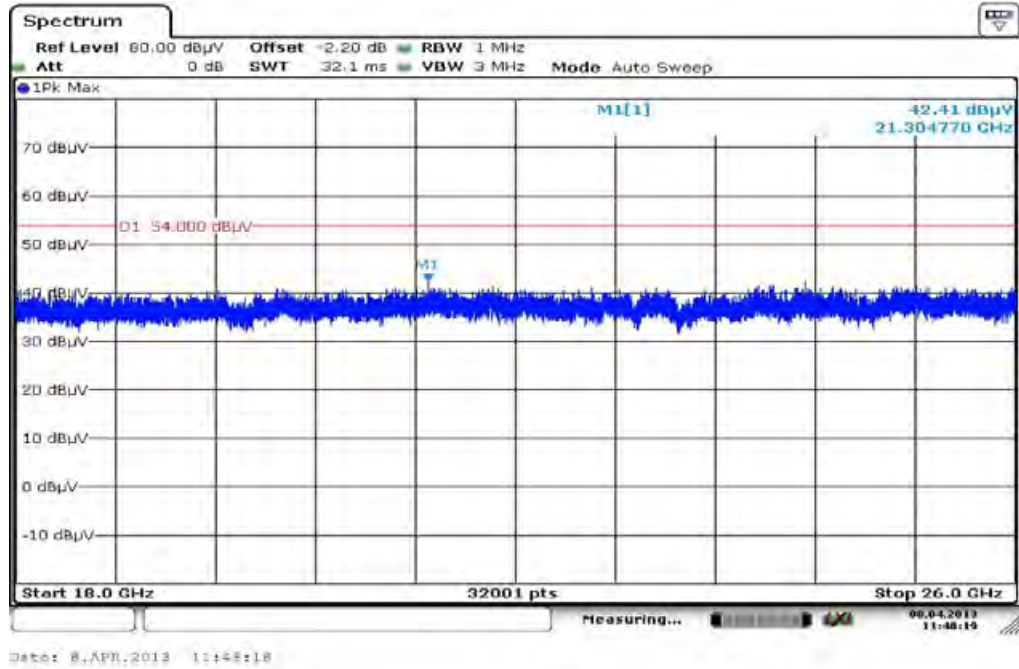

Plot 15: 26 GHz to 40 GHz, 5270 MHz, vertical & horizontal polarization

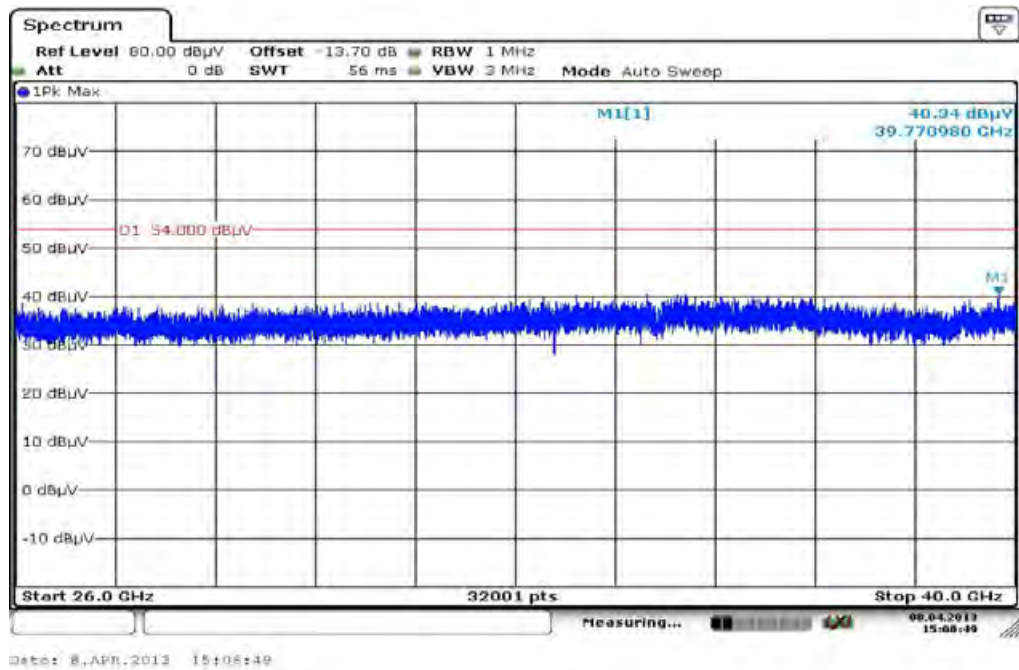

Plot 16: 30 MHz to 1 GHz, 5310 MHz, vertical & horizontal polarization

Common Information

EUT: TM-0030-BV
 Serial Number: CB5A1NY07J
 Test Description: FCC part 15 C class B @ 10 m
 Operating Conditions: wlan n-mode HT40 ch 62 + charging
 Operator Name: Wolsdorfer
 Comment: USB powered

Scan Setup: STAN_Fin [EMI radiated]

Hardware Setup: Electric Field (NOS)
 Receiver: [ESCI 3]
 Level Unit: dBµV/m

Subrange	Step Size	Detectors	IF BW	Meas. Time	Preamp
30 MHz - 2 GHz	60 kHz	QPK	120 kHz	1 s	20 dB

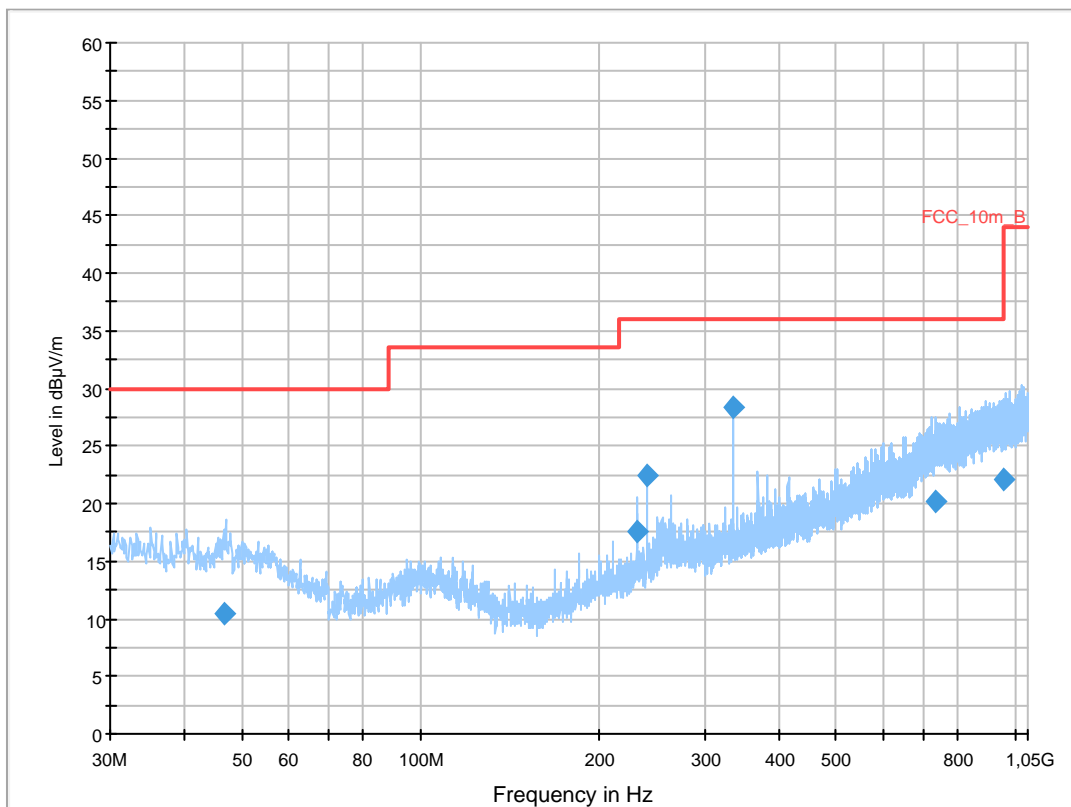

Final Result 1

Frequency (MHz)	QuasiPeak (dBµV/m)	Meas. Time (ms)	Bandwidth (kHz)	Height (cm)	Polarization	Azimuth (deg)	Corr. (dB)	Margin (dB)	Limit (dBµV/m)	Comment
46.703250	10.5	1000.0	120.000	154.0	V	270.0	13.3	19.5	30.0	
230.392800	17.6	1000.0	120.000	98.0	V	100.0	12.7	18.4	36.0	
240.009600	22.5	1000.0	120.000	121.0	V	81.0	13.0	13.5	36.0	
335.979000	28.4	1000.0	120.000	160.0	V	81.0	15.6	7.6	36.0	
734.222250	20.2	1000.0	120.000	120.0	V	10.0	23.3	15.8	36.0	
956.851800	22.1	1000.0	120.000	170.0	V	10.0	25.4	13.9	36.0	

Plot 17: 1 GHz to 12.75 GHz, 5310 MHz, vertical & horizontal polarization

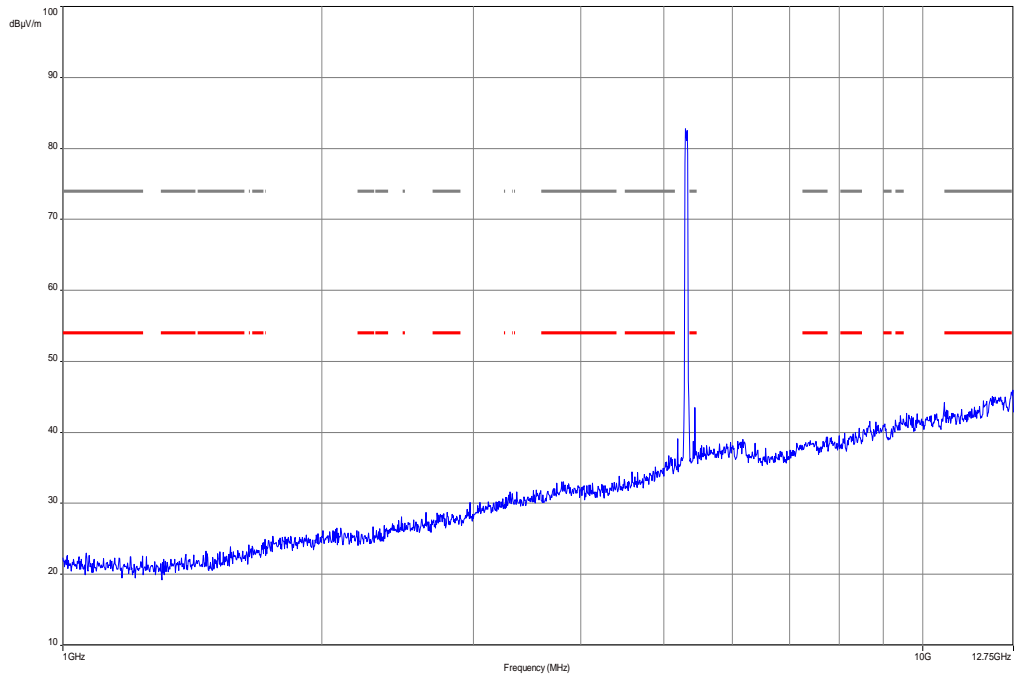

Plot 18: 12 GHz to 18 GHz, 5310 MHz, vertical & horizontal polarization

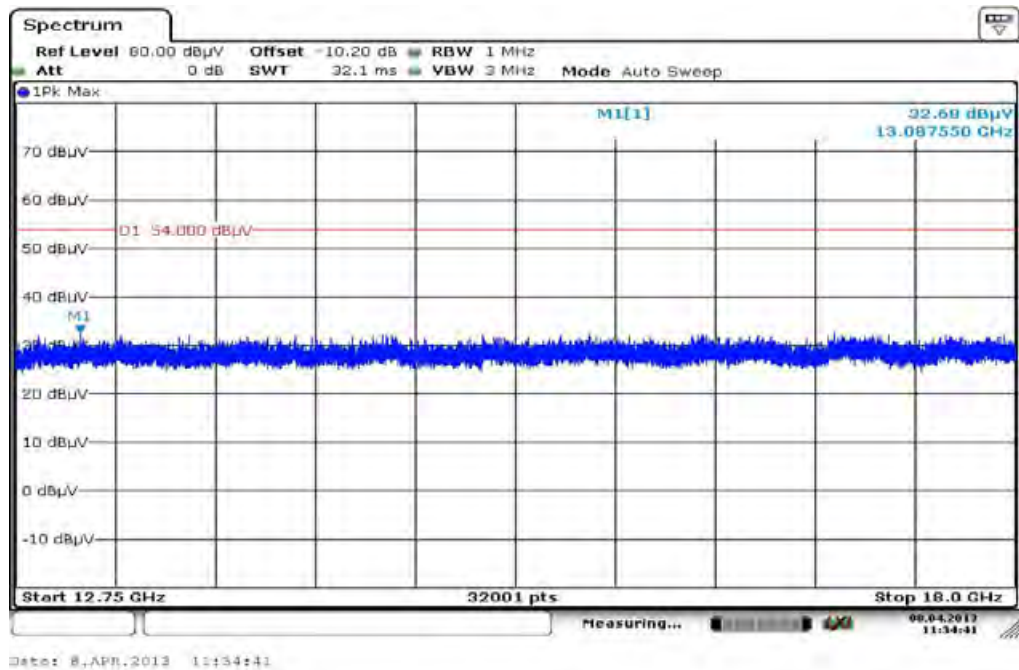

Plot 19: 18 GHz to 26 GHz, 5310 MHz, vertical & horizontal polarization

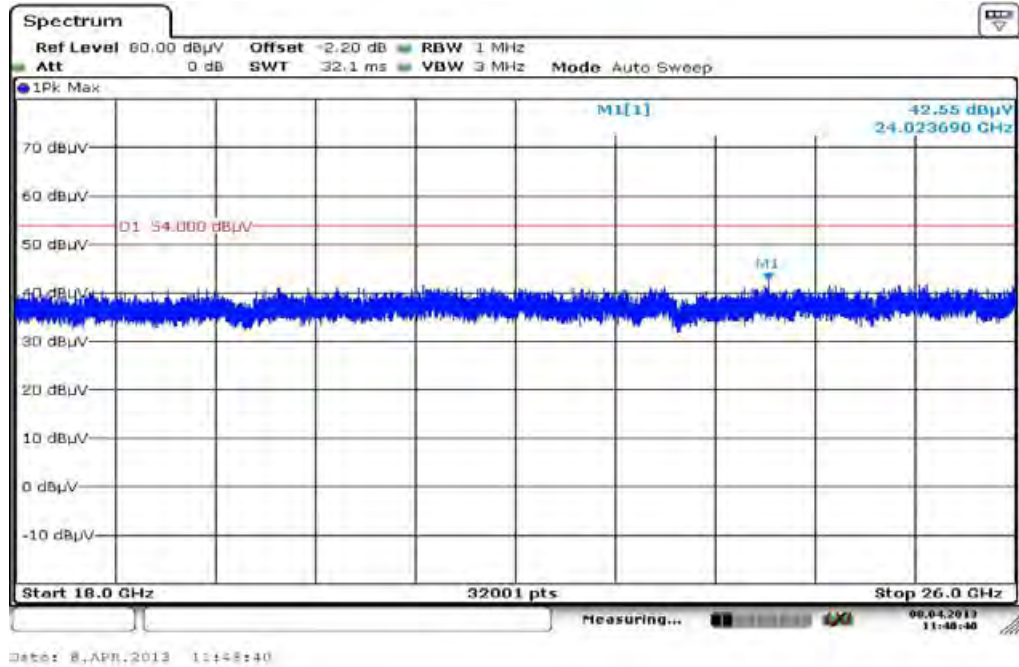

Plot 20: 26 GHz to 40 GHz, 5310 MHz, vertical & horizontal polarization

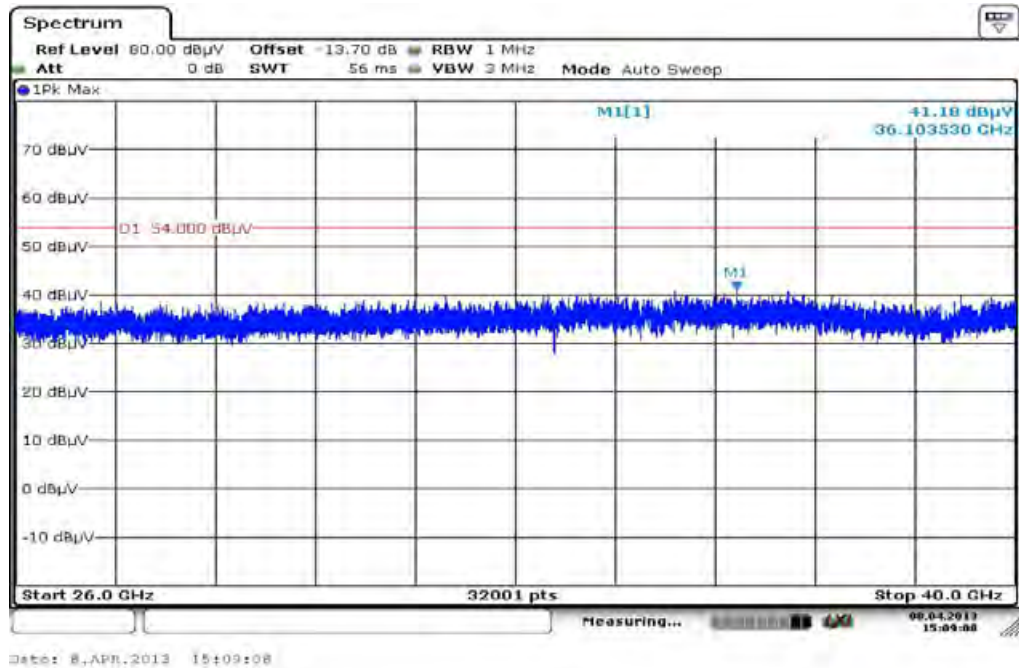

Plot 21: 30 MHz to 1 GHz, 5510 MHz, vertical & horizontal polarization

Common Information

EUT: TM-0030-BV
 Serial Number: CB5A1NY07J
 Test Description: FCC part 15 C class B @ 10 m
 Operating Conditions: wlan n-mode HT40 ch 102 + charging
 Operator Name: Wolsdorfer
 Comment: USB powered

Scan Setup: STAN_Fin [EMI radiated]

Hardware Setup: Electric Field (NOS)
 Receiver: [ESCI 3]
 Level Unit: dBµV/m

Subrange	Step Size	Detectors	IF BW	Meas. Time	Preamp
30 MHz - 2 GHz	60 kHz	QPK	120 kHz	1 s	20 dB

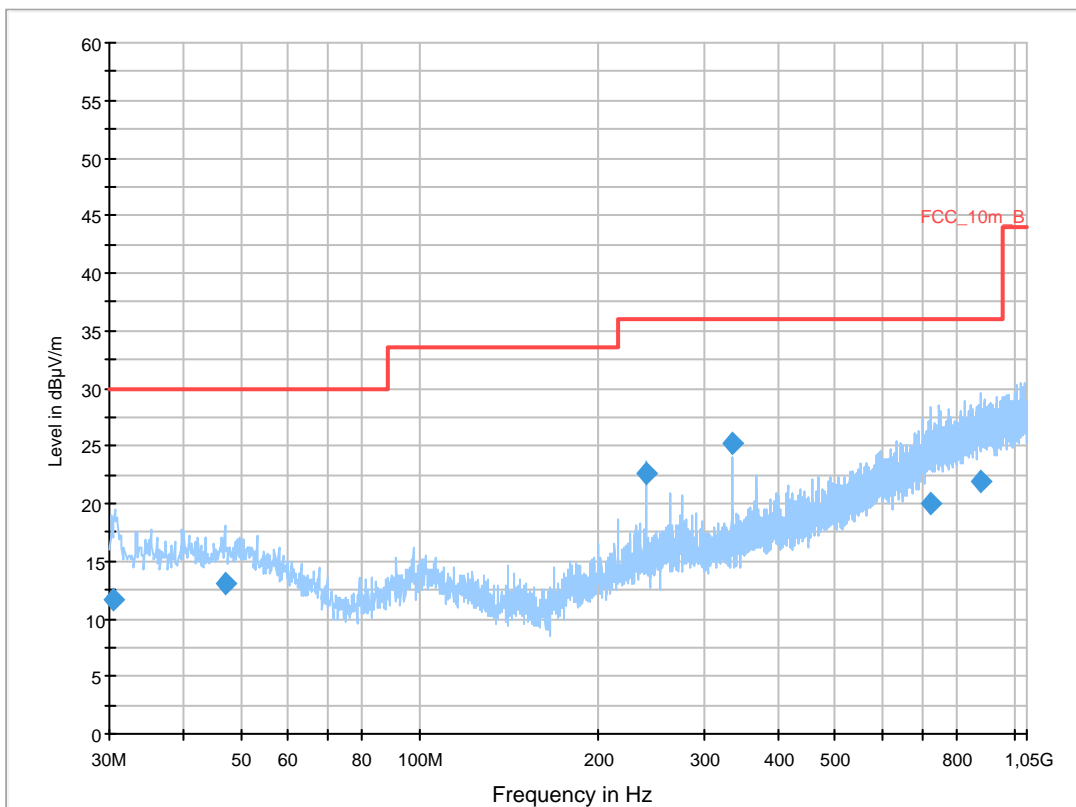

Final Result 1

Frequency (MHz)	QuasiPeak (dBµV/m)	Meas. Time (ms)	Bandwidth (kHz)	Height (cm)	Polarization	Azimuth (deg)	Corr. (dB)	Margin (dB)	Limit (dBµV/m)	Comment
30.513600	11.6	1000.0	120.000	152.0	V	280.0	12.6	18.4	30.0	
47.047650	13.0	1000.0	120.000	104.0	V	2.0	13.3	17.0	30.0	
240.008850	22.7	1000.0	120.000	98.0	V	260.0	13.0	13.3	36.0	
336.010650	25.2	1000.0	120.000	120.0	V	80.0	15.6	10.8	36.0	
722.583000	19.9	1000.0	120.000	170.0	H	170.0	23.0	16.1	36.0	
880.933650	21.9	1000.0	120.000	170.0	V	100.0	25.0	14.1	36.0	

Plot 22: 1 GHz to 12.75 GHz, 5510 MHz, vertical & horizontal polarization

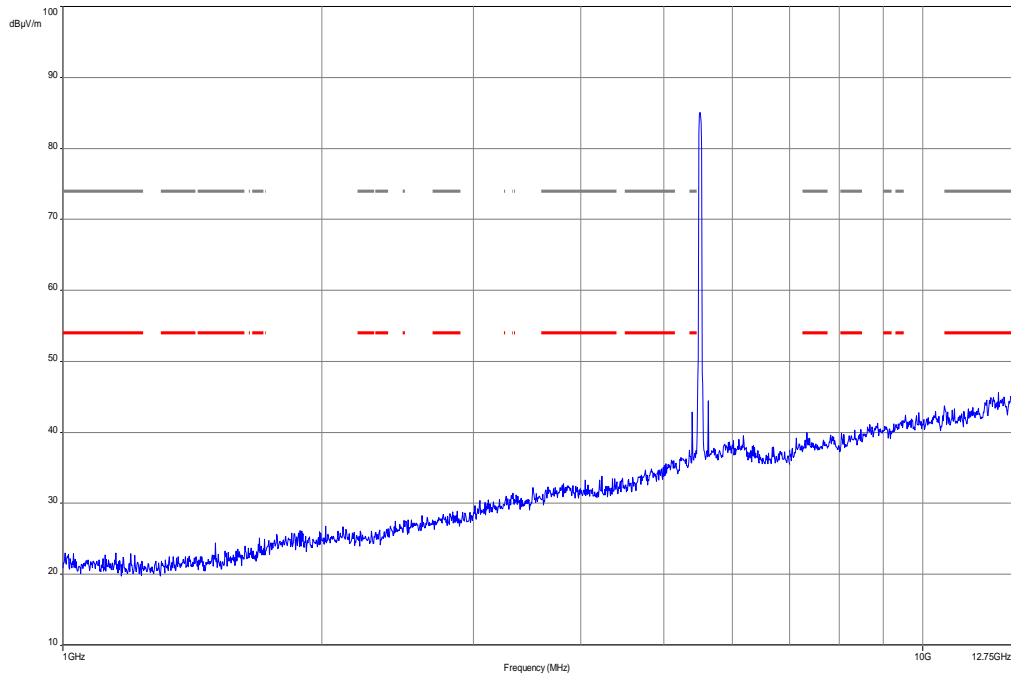

Plot 23: 12 GHz to 18 GHz, 5510 MHz, vertical & horizontal polarization

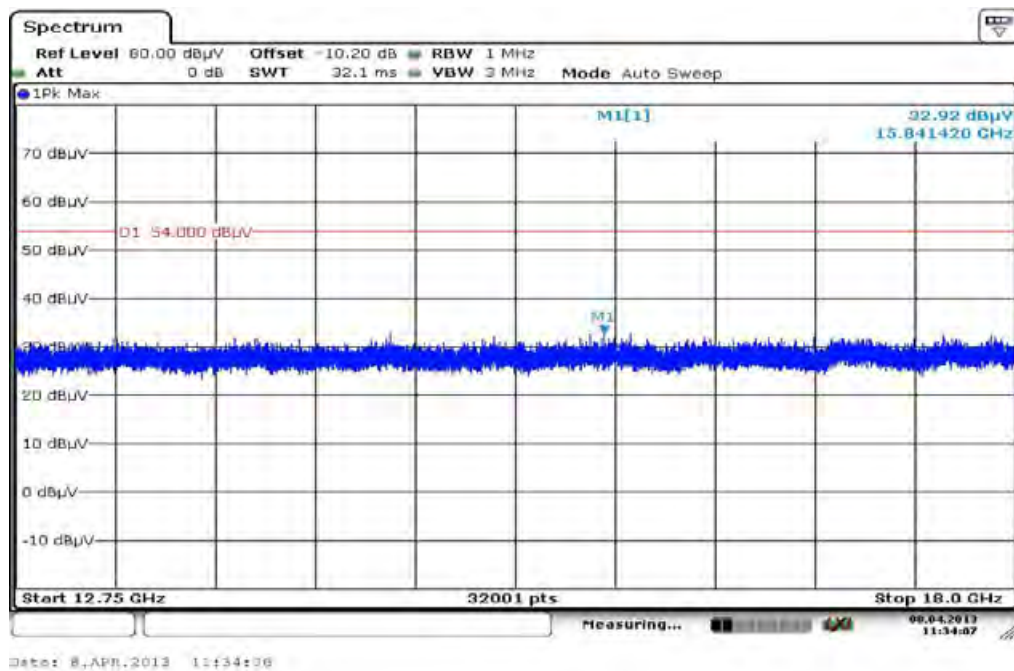

Plot 24: 18 GHz to 26 GHz, 5510 MHz, vertical & horizontal polarization

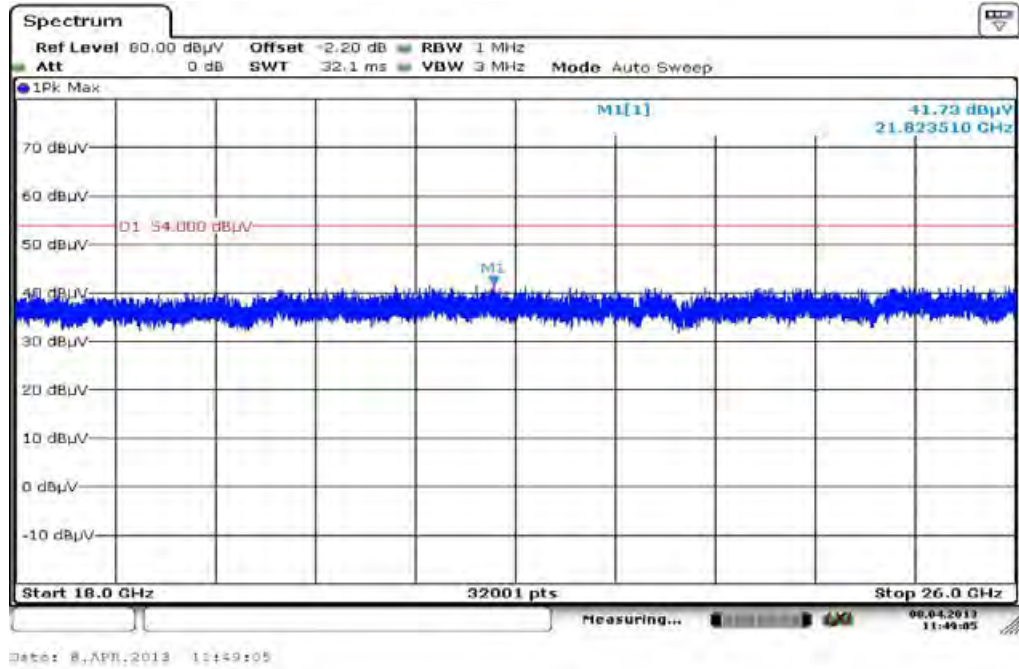

Plot 25: 26 GHz to 40 GHz, 5510 MHz, vertical & horizontal polarization

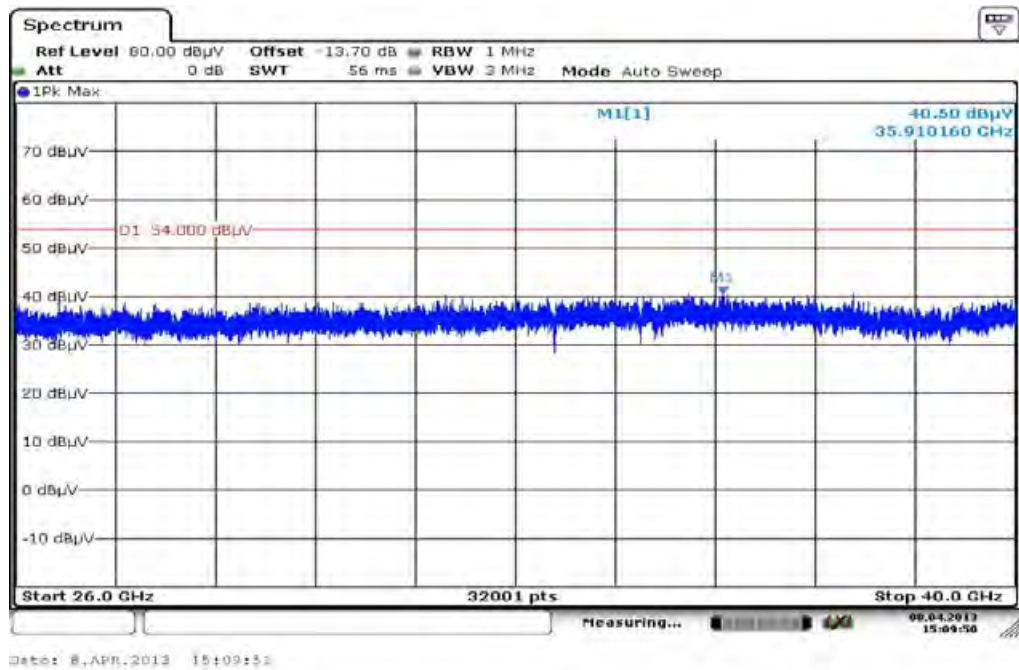

Plot 26: 30 MHz to 1 GHz, 5590 MHz, vertical & horizontal polarization

Common Information

EUT: TM-0030-BV
 Serial Number: CB5A1NY07J
 Test Description: FCC part 15 C class B @ 10 m
 Operating Conditions: wlan n-mode HT40 ch 118 + charging
 Operator Name: Wolsdorfer
 Comment: USB powered

Scan Setup: STAN_Fin [EMI radiated]

Hardware Setup: Electric Field (NOS)
 Receiver: [ESCI 3]
 Level Unit: dBµV/m

Subrange	Step Size	Detectors	IF BW	Meas. Time	Preamp
30 MHz - 2 GHz	60 kHz	QPK	120 kHz	1 s	20 dB

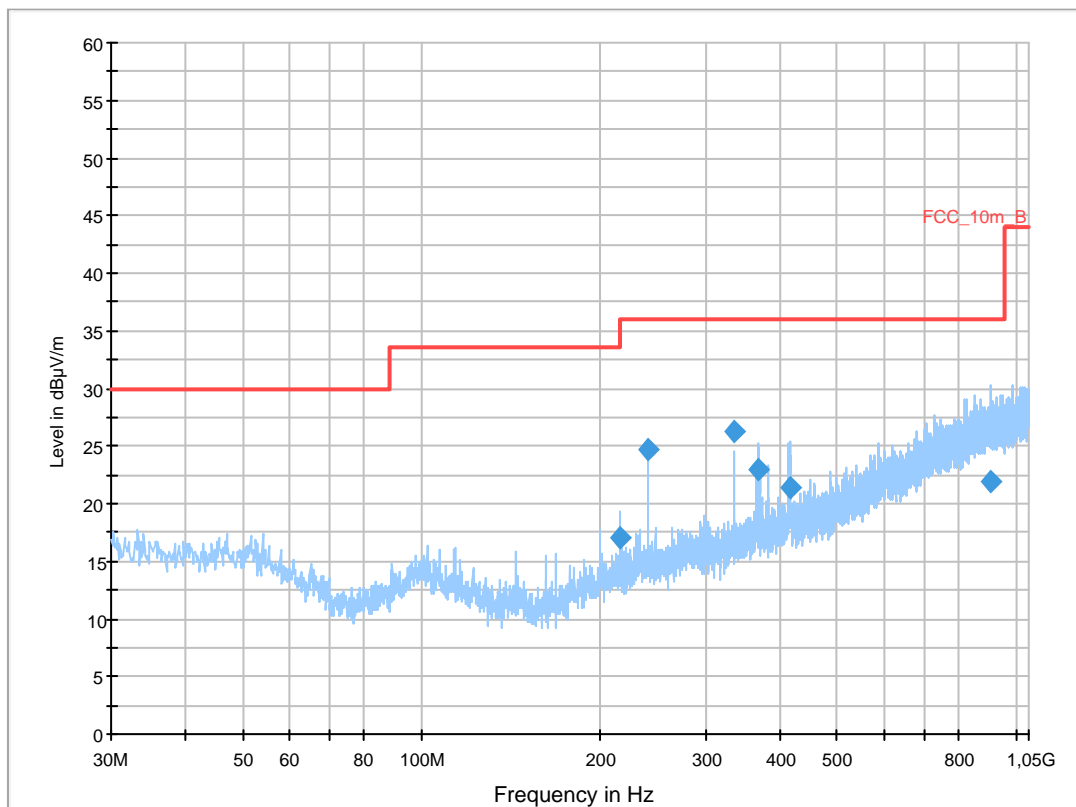

Final Result 1

Frequency (MHz)	QuasiPeak (dBµV/m)	Meas. Time (ms)	Bandwidth (kHz)	Height (cm)	Polarization	Azimuth (deg)	Corr. (dB)	Margin (dB)	Limit (dBµV/m)	Comment
215.990550	17.1	1000.0	120.000	120.0	V	-10.0	12.3	16.4	33.5	
239.998500	24.6	1000.0	120.000	98.0	V	261.0	13.0	11.4	36.0	
336.000750	26.2	1000.0	120.000	98.0	V	81.0	15.6	9.8	36.0	
368.302350	23.0	1000.0	120.000	112.0	V	86.0	16.4	13.0	36.0	
416.218200	21.5	1000.0	120.000	98.0	V	100.0	17.2	14.5	36.0	
909.466650	21.9	1000.0	120.000	170.0	H	280.0	25.2	14.1	36.0	

Plot 27: 1 GHz to 12.75 GHz, 5590 MHz, vertical & horizontal polarization

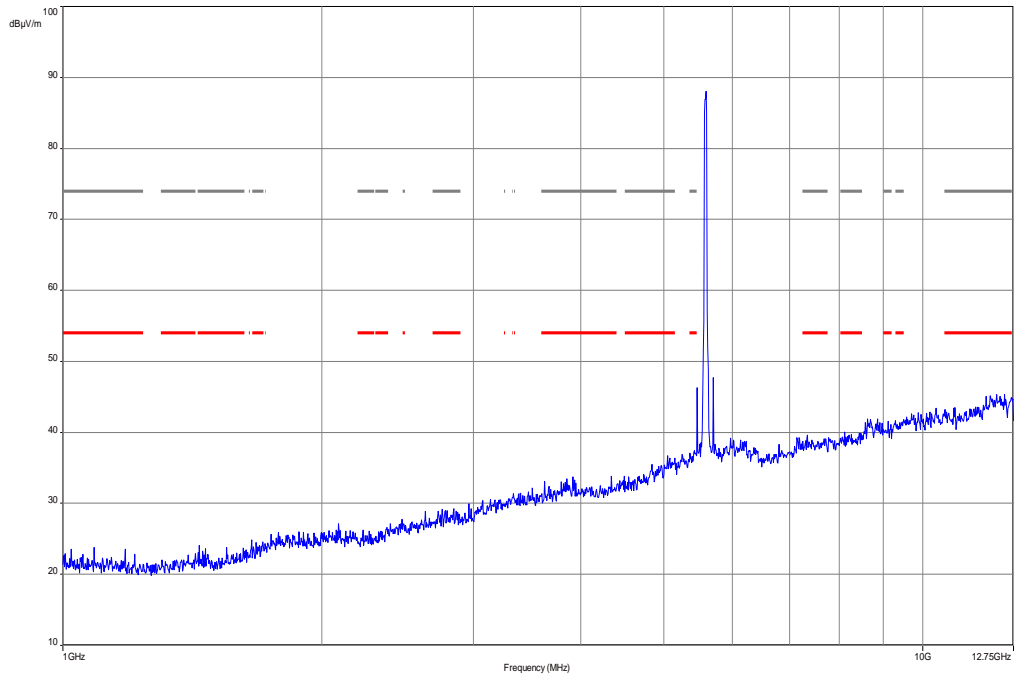

Plot 28: 12 GHz to 18 GHz, 5590 MHz, vertical & horizontal polarization

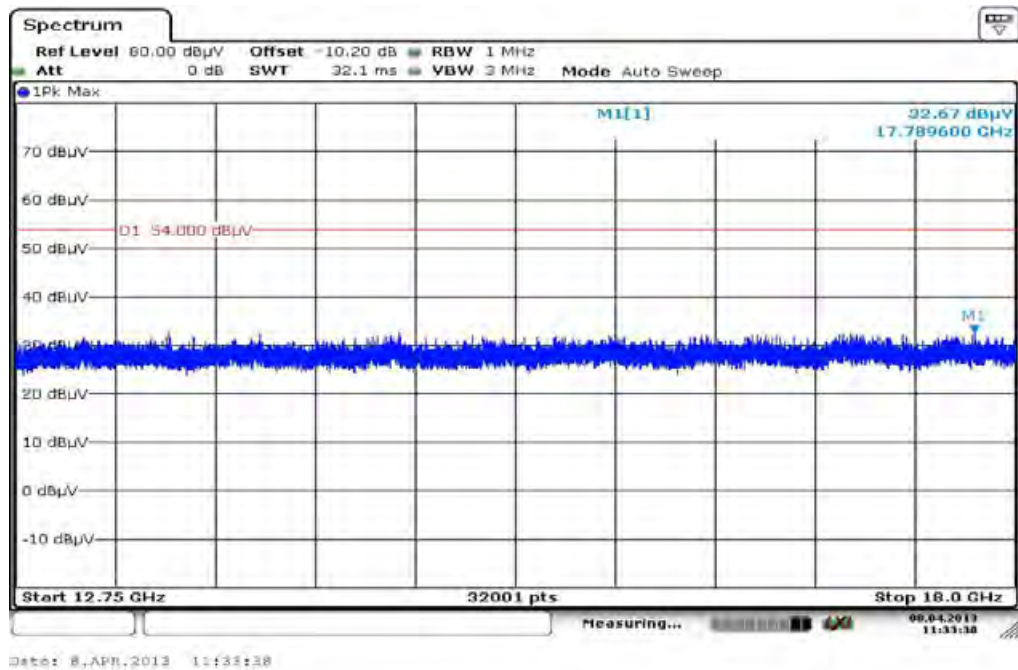

Plot 29: 18 GHz to 26 GHz, 5590 MHz, vertical & horizontal polarization

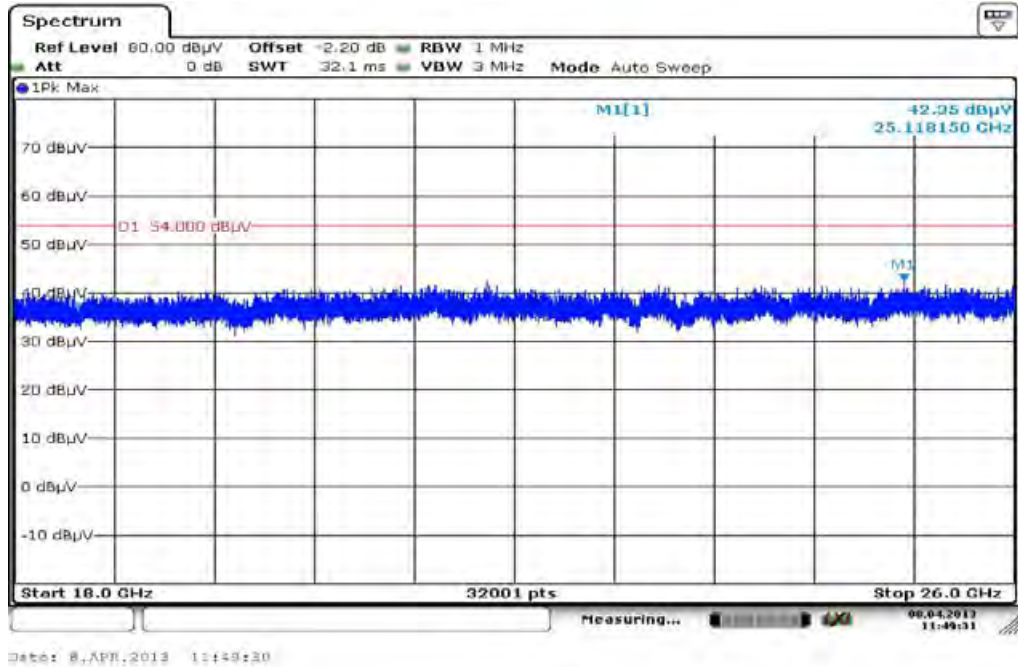

Plot 30: 26 GHz to 40 GHz, 5590 MHz, vertical & horizontal polarization

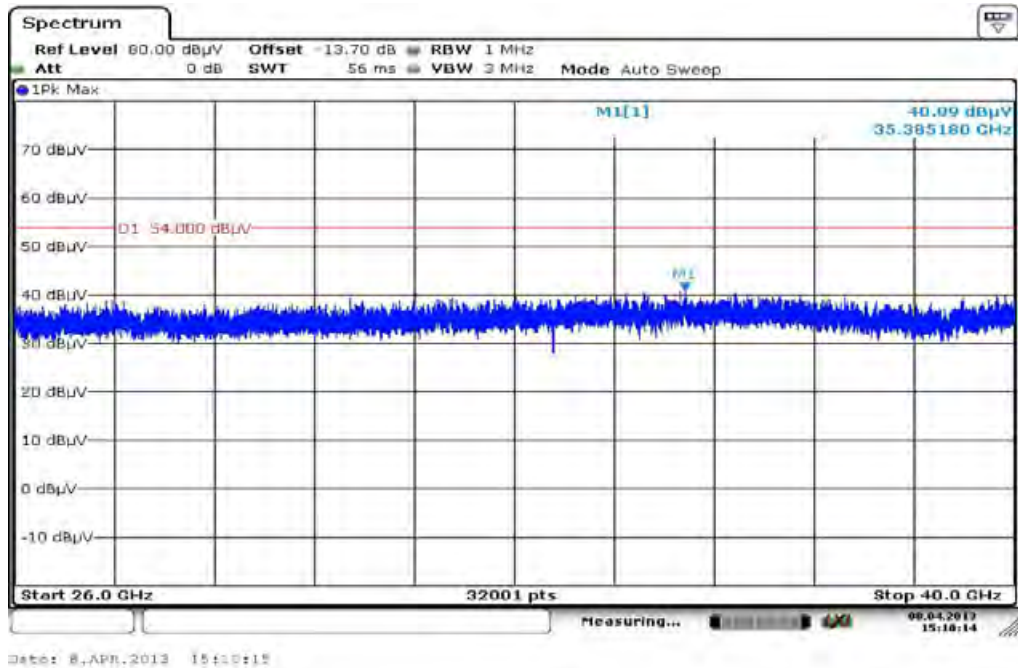

Plot 31: 30 MHz to 1 GHz, 5670 MHz, vertical & horizontal polarization

Common Information

EUT: TM-0030-BV
 Serial Number: CB5A1NY07J
 Test Description: FCC part 15 C class B @ 10 m
 Operating Conditions: wlan n-mode HT40 ch 134 + charging
 Operator Name: Wolsdorfer
 Comment: USB powered

Scan Setup: STAN_Fin [EMI radiated]

Hardware Setup: Electric Field (NOS)
 Receiver: [ESCI 3]
 Level Unit: dBµV/m

Subrange	Step Size	Detectors	IF BW	Meas. Time	Preamp
30 MHz - 2 GHz	60 kHz	QPK	120 kHz	1 s	20 dB

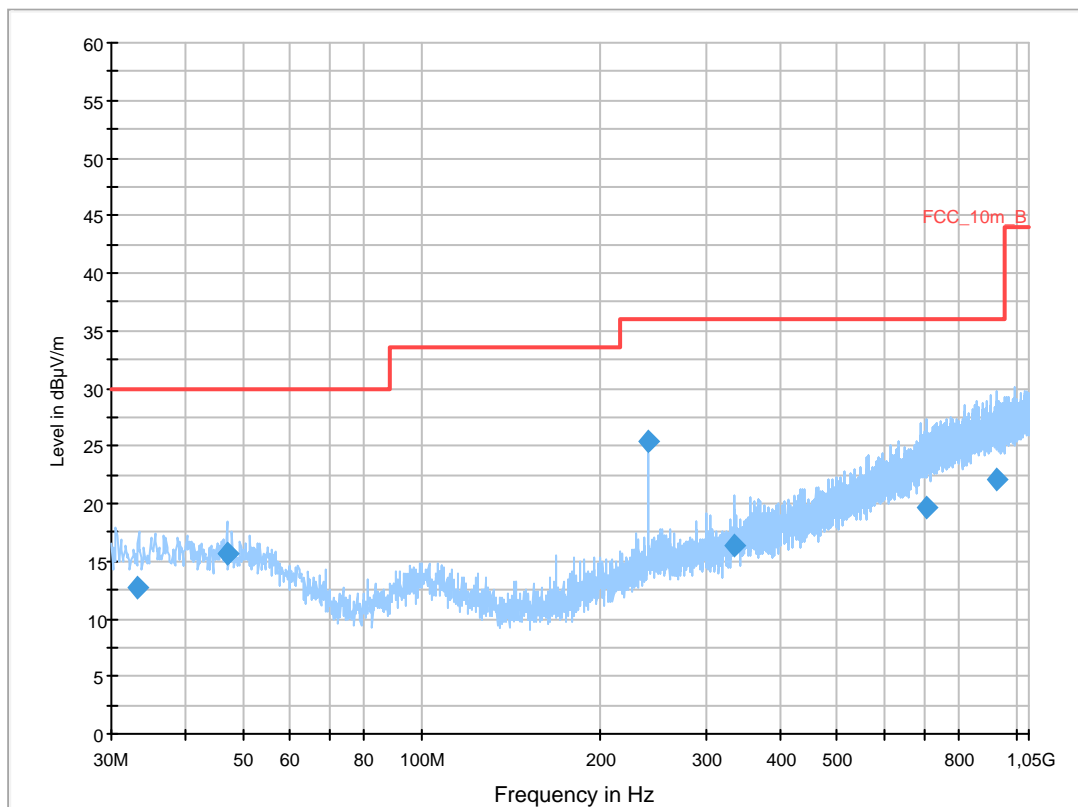

Final Result 1

Frequency (MHz)	QuasiPeak (dBµV/m)	Meas. Time (ms)	Bandwidth (kHz)	Height (cm)	Polarization	Azimuth (deg)	Corr. (dB)	Margin (dB)	Limit (dBµV/m)	Comment
33.312150	12.7	1000.0	120.000	132.0	V	190.0	12.9	17.3	30.0	
47.012100	15.6	1000.0	120.000	98.0	V	10.0	13.3	14.4	30.0	
47.012100	15.6	1000.0	120.000	98.0	V	10.0	13.3	14.4	30.0	
240.022200	25.4	1000.0	120.000	170.0	V	190.0	13.0	10.6	36.0	
335.976450	16.3	1000.0	120.000	170.0	V	273.0	15.6	19.7	36.0	
708.075150	19.6	1000.0	120.000	144.0	H	-10.0	22.7	16.4	36.0	
...

Plot 32: 1 GHz to 12.75 GHz, 5670 MHz, vertical & horizontal polarization

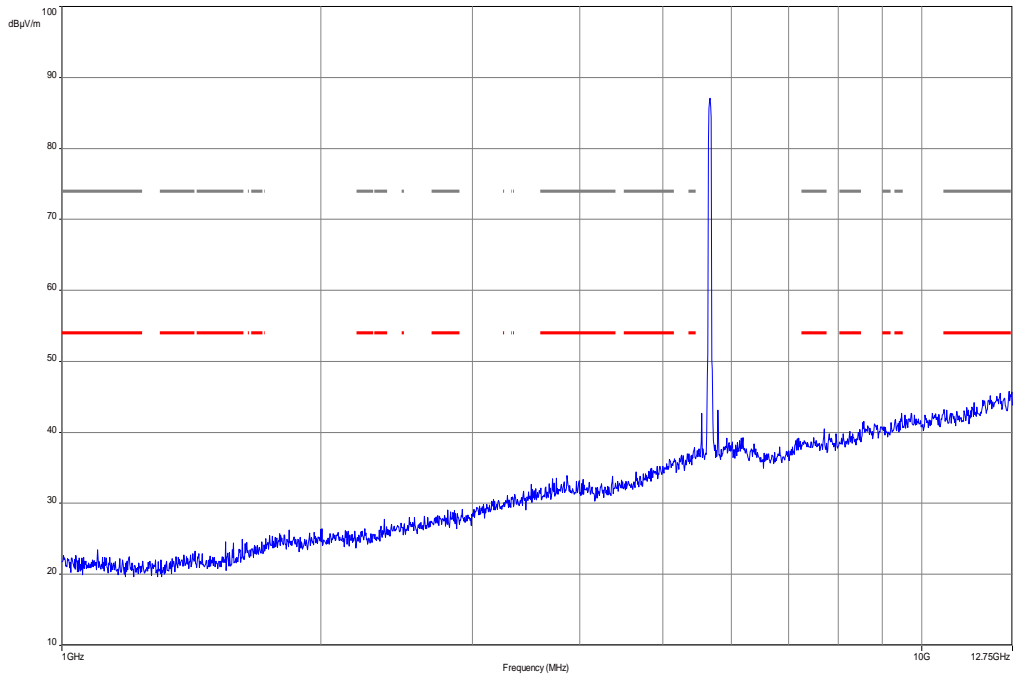

Plot 33: 12 GHz to 18 GHz, 5670 MHz, vertical & horizontal polarization

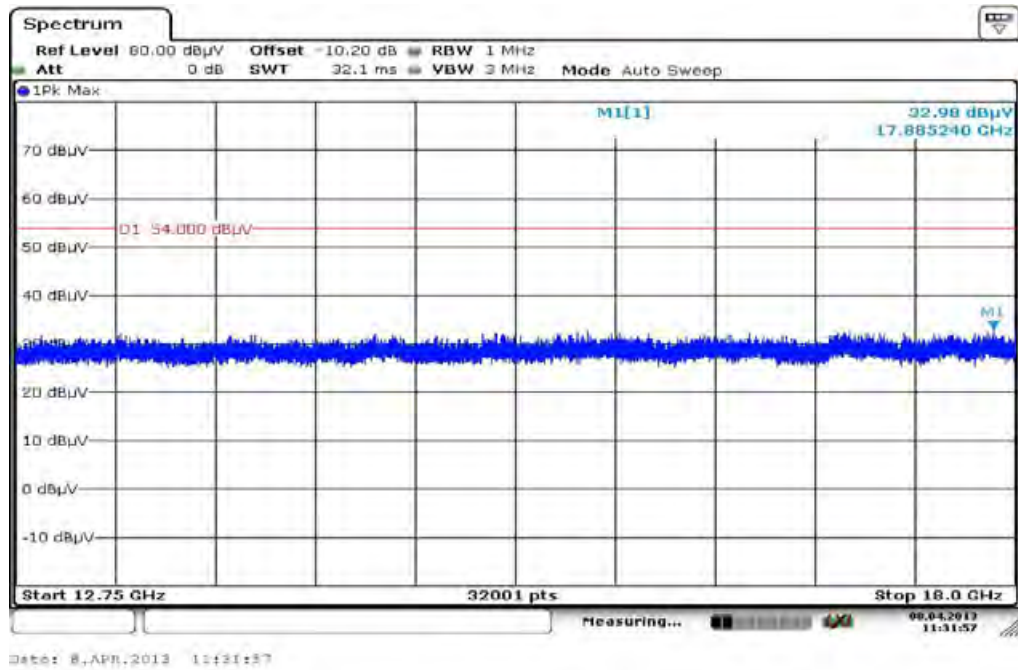

Plot 34: 18 GHz to 26 GHz, 5670 MHz, vertical & horizontal polarization

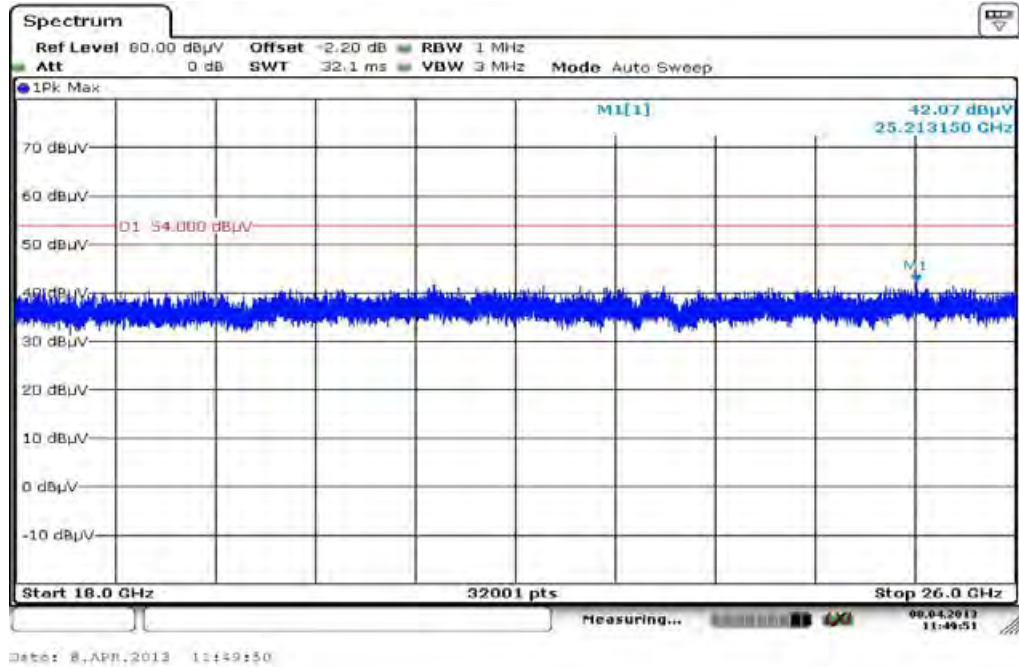

Plot 35: 26 GHz to 40 GHz, 5670 MHz, vertical & horizontal polarization

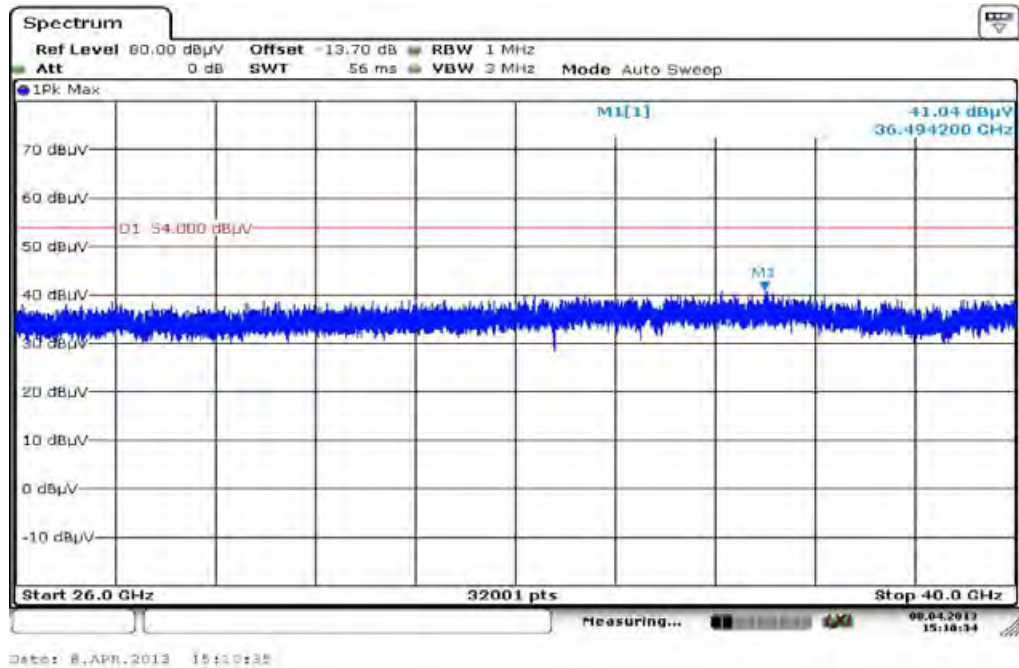

9.10 RX spurious emissions radiated

Description:

Measurement of the radiated spurious emissions in idle/receive mode.

Measurement:

Measurement parameter	
Detector:	Quasi Peak below 1 GHz (alternative Peak) Peak above 1 GHz / RMS
Sweep time:	Auto
Resolution bandwidth:	F < 1 GHz: 100 kHz F > 1 GHz: 1 MHz
Video bandwidth:	F < 1 GHz: 100 kHz F > 1 GHz: ≥ 3 MHz /10 Hz
Span:	30 MHz to 40 GHz
Trace-Mode:	Max Hold / Average with 100 counts + 20 log (1 / X) for duty cycle lower than 100 %

Limits:

RX Spurious Emissions Radiated		
Frequency (MHz)	Field Strength (dB μ V/m)	Measurement distance
30 - 88	30.0	10
88 – 216	33.5	10
216 – 960	36.0	10
Above 960	54.0	3

Results:

RX Spurious Emissions Radiated [dB μ V/m]		
F [MHz]	Detector	Level [dB μ V/m]
For emissions below 1 GHz, please take a look at the table below the 1 GHz plot.		
No emissions detected between 1 GHz and 12.75 GHz.		
For emissions above 12.75 GHz, please take a look at the plots.		
Measurement uncertainty	± 3 dB	

Result: Passed

Plots: RX / Idle – mode

Plot 1: 30 MHz to 1 GHz, vertical & horizontal polarization

Common Information

EUT: TM-0030-BV
 Serial Number: CB5A1NY07J
 Test Description: FCC part 15 B class B @ 5 m
 Operating Conditions: wlan idle+ charging
 Operator Name: Wolsdorfer
 Comment: USB powered

Scan Setup: STAN_Fin [EMI radiated]

Hardware Setup: Electric Field (NOS)
 Receiver: [ESCI 3]
 Level Unit: dBµV/m

Subrange	Step Size	Detectors	IF BW	Meas. Time	Preamp
30 MHz - 2 GHz	60 kHz	QPK	120 kHz	1 s	20 dB

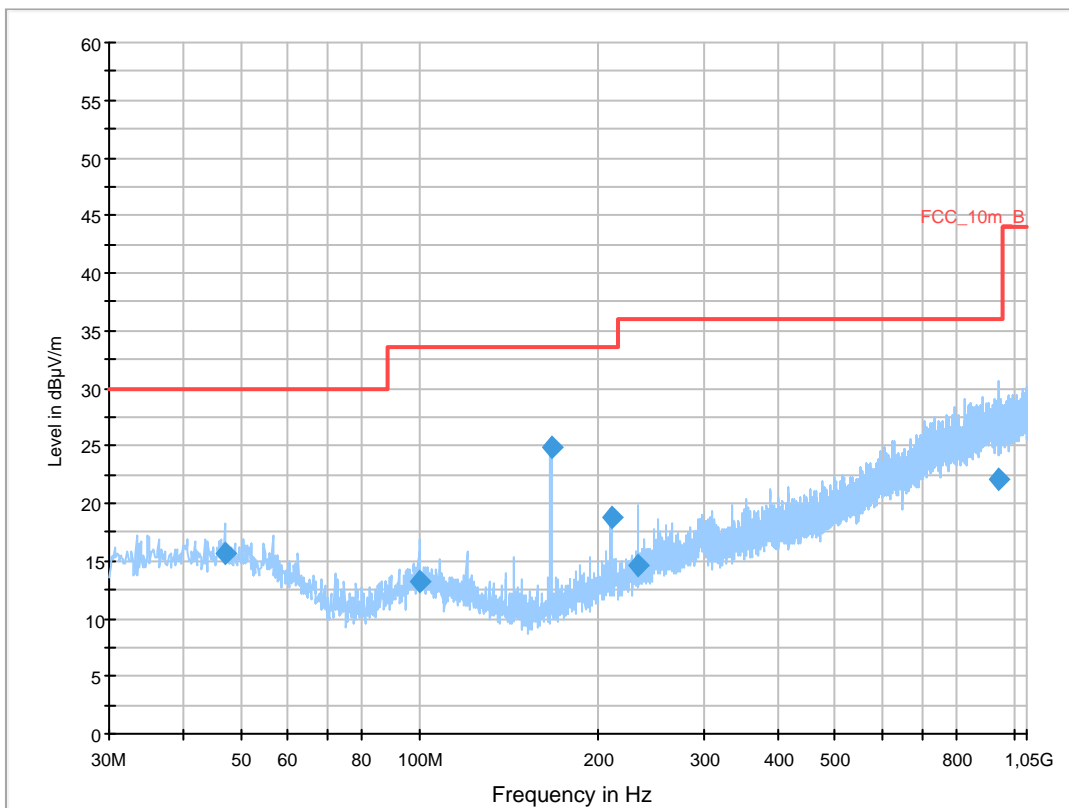

Final Result 1

Frequency (MHz)	QuasiPeak (dBµV/m)	Meas. Time (ms)	Bandwidth (kHz)	Height (cm)	Polarization	Azimuth (deg)	Corr. (dB)	Margin (dB)	Limit (dBµV/m)	Comment
46.979550	15.7	1000.0	120.000	98.0	V	261.0	13.3	14.3	30.0	
99.907950	13.3	1000.0	120.000	143.0	V	100.0	11.9	20.2	33.5	
166.572600	24.9	1000.0	120.000	98.0	V	100.0	9.6	8.6	33.5	
209.894250	18.9	1000.0	120.000	123.0	V	170.0	12.0	14.6	33.5	
232.934550	14.7	1000.0	120.000	120.0	V	10.0	12.8	21.3	36.0	
941.230500	22.1	1000.0	120.000	98.0	V	260.0	25.3	13.9	36.0	

Plot 2: 1 GHz to 12.75 GHz, vertical & horizontal polarization

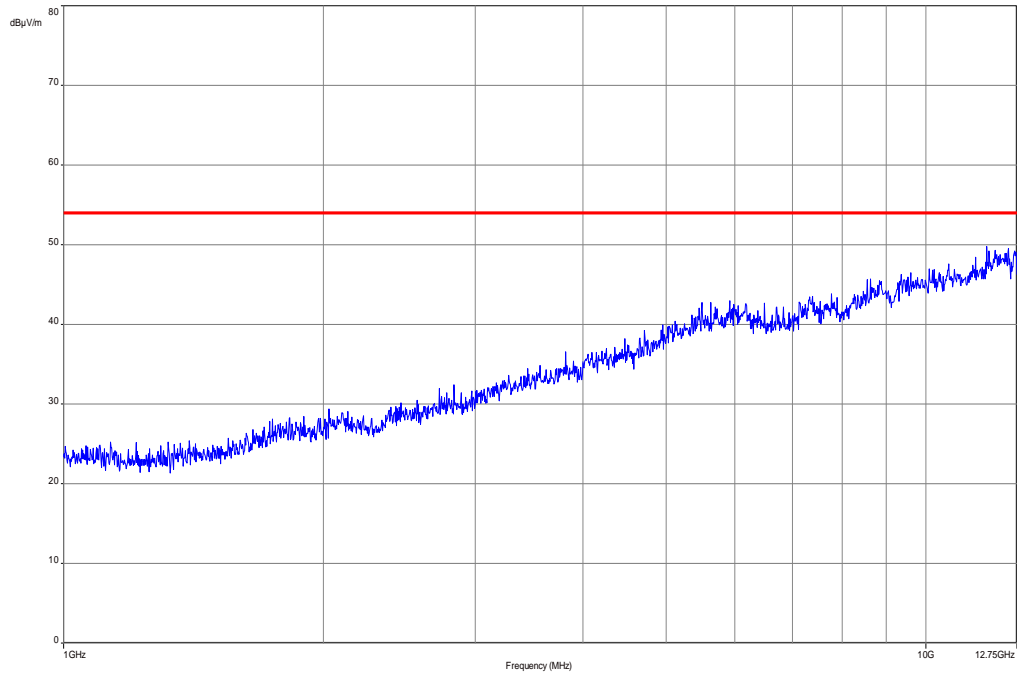

Plot 3: 12.75 GHz to 18 GHz, vertical & horizontal polarization

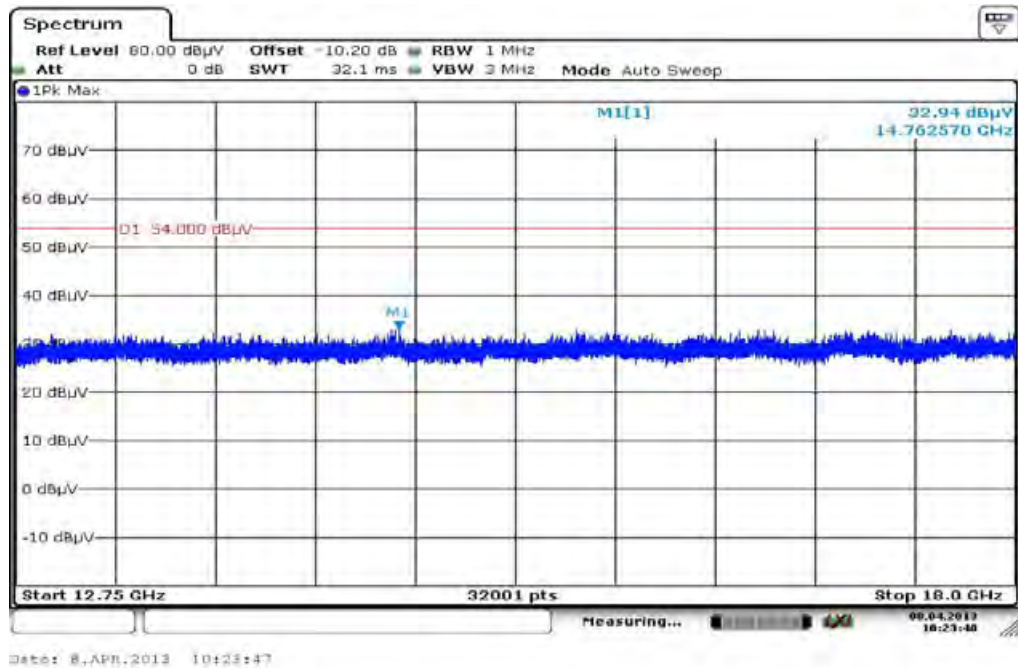

Plot 4: 18 GHz to 26 GHz, vertical & horizontal polarization

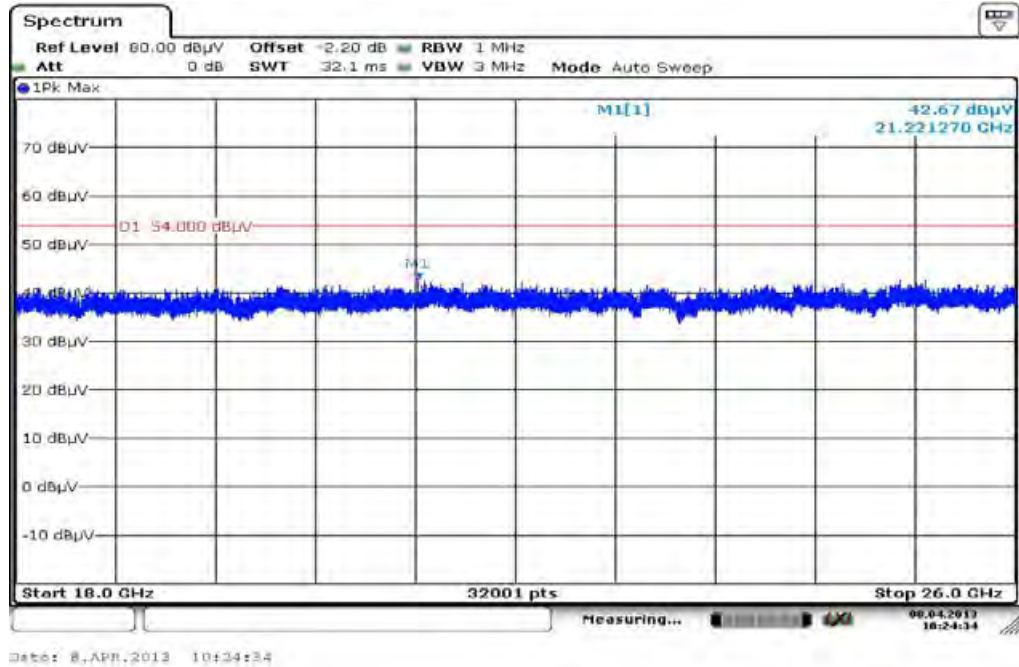

Plot 5: 26 GHz to 40 GHz, vertical & horizontal polarization

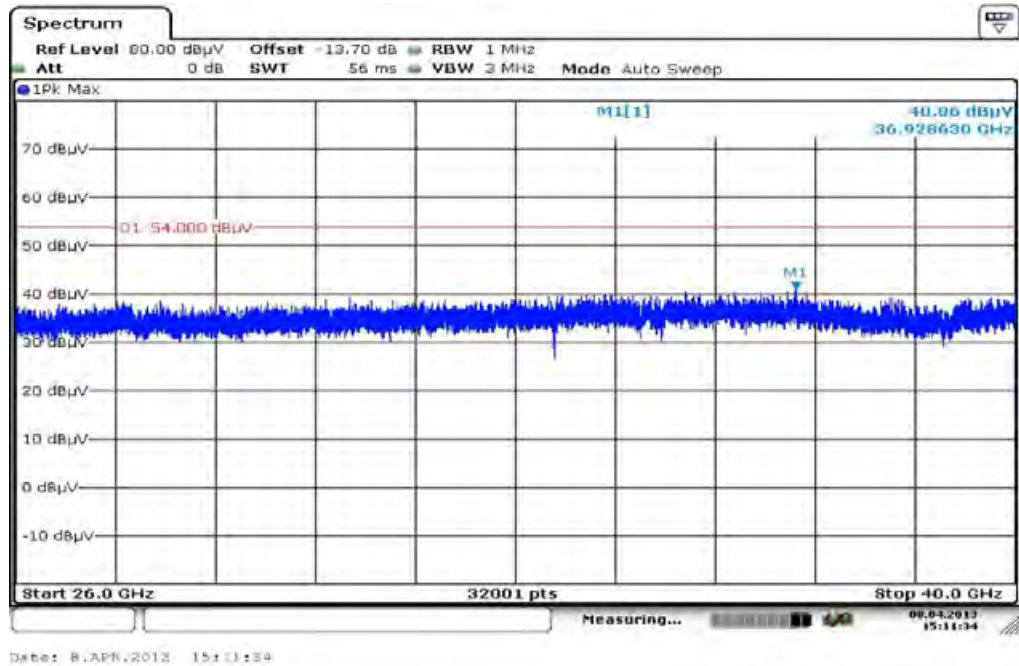

9.11 Spurious emissions radiated < 30 MHz

Description:

Measurement of the radiated spurious emissions in transmit mode and receive mode below 30 MHz. The EUT is set first to middle channel. This measurement is representative for all channels and modes. If critical peaks are found the lowest channel and the highest channel will be measured too. Then the EUT is set to receive or idle mode. The limits are recalculated to a measurement distance of 3 m with 40 dB/decade according CFR Part 2.

Measurement:

Measurement parameter	
Detector:	Peak / Quasi Peak
Sweep time:	Auto
Video bandwidth:	F < 150 kHz: 200 Hz F > 150 kHz: 9 kHz
Resolution bandwidth:	F < 150 kHz: 1 kHz F > 150 kHz: 100 kHz
Span:	9 kHz to 30 MHz
Trace-Mode:	Max Hold

Limits:

Spurious Emissions Radiated < 30 MHz		
Frequency (MHz)	Field Strength (dBµV/m)	Measurement distance
0.009 – 0.490	2400/F(kHz)	300
0.490 – 1.705	24000/F(kHz)	30
1.705 – 30.0	30	30

Results:

Spurious Emissions Radiated < 30 MHz [dBµV/m]		
F [MHz]	Detector	Level [dBµV/m]
No peaks found		
Measurement uncertainty	± 3 dB	

Result: Passed

Plots:

Plot 1: 9 kHz to 30 MHz, TX mode

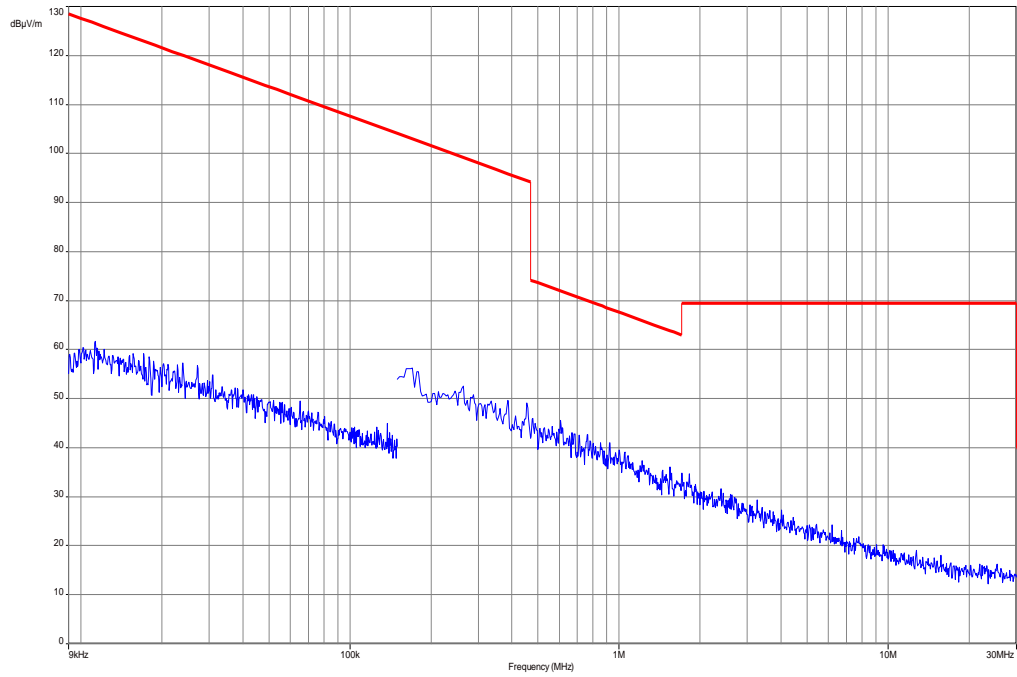

Plot 2: 9 kHz to 30 MHz, RX mode

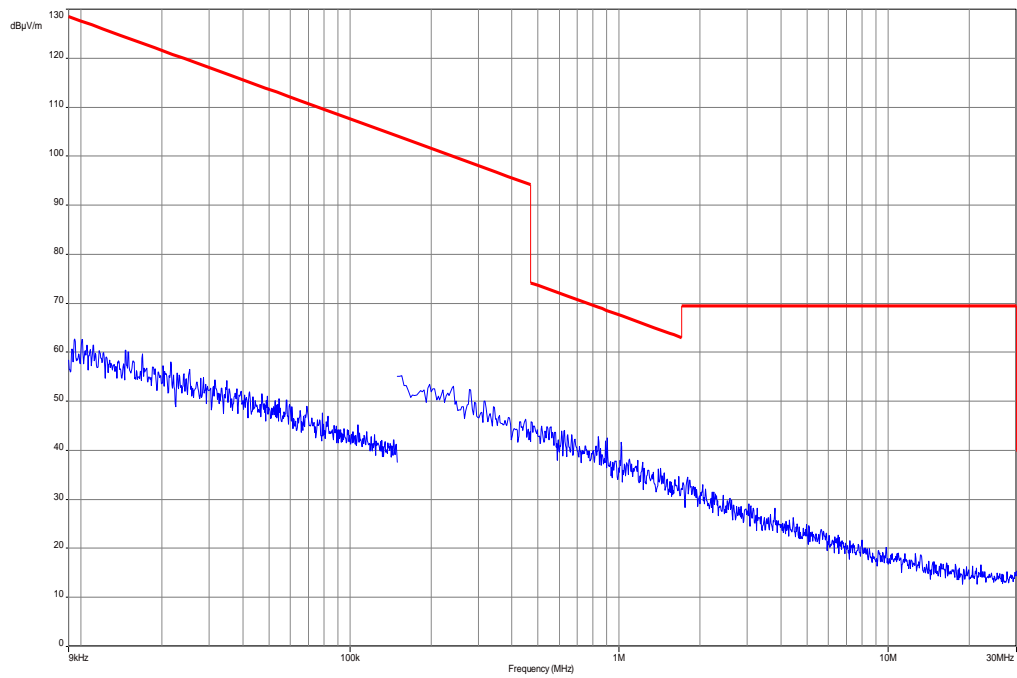

9.12 Spurious emissions conducted < 30 MHz

Description:

Measurement of the conducted spurious emissions in transmit mode below 30 MHz. The EUT is set to middle channel. If critical peaks are found the lowest channel and the highest channel will be measured too. Both power lines, phase and neutral line, are measured. Found peaks are remeasured with average and quasi peak detection to show compliance to the limits.

Measurement:

Measurement parameter	
Detector:	Peak - Quasi Peak / Average
Sweep time:	Auto
Video bandwidth:	F > 150 kHz: 9 kHz
Resolution bandwidth:	F > 150 kHz: 100 kHz
Span:	150 kHz to 30 MHz
Trace-Mode:	Max Hold

Limits:

Spurious Emissions Conducted < 30 MHz		
Frequency (MHz)	Quasi-Peak (dB μ V/m)	Average (dB μ V/m)
0.15 – 0.5	66 to 56*	56 to 46*
0.5 – 5	56	46
5 – 30.0	60	50

*Decreases with the logarithm of the frequency

Results:

Spurious Emissions Conducted < 30 MHz [dB μ V/m]		
F [MHz]	Detector	Level [dB μ V/m]
No peaks found		
Measurement uncertainty		
± 3 dB		

Result: Passed

Plots:

Plot 1: 150 kHz to 30 MHz / phase Line, TX mode

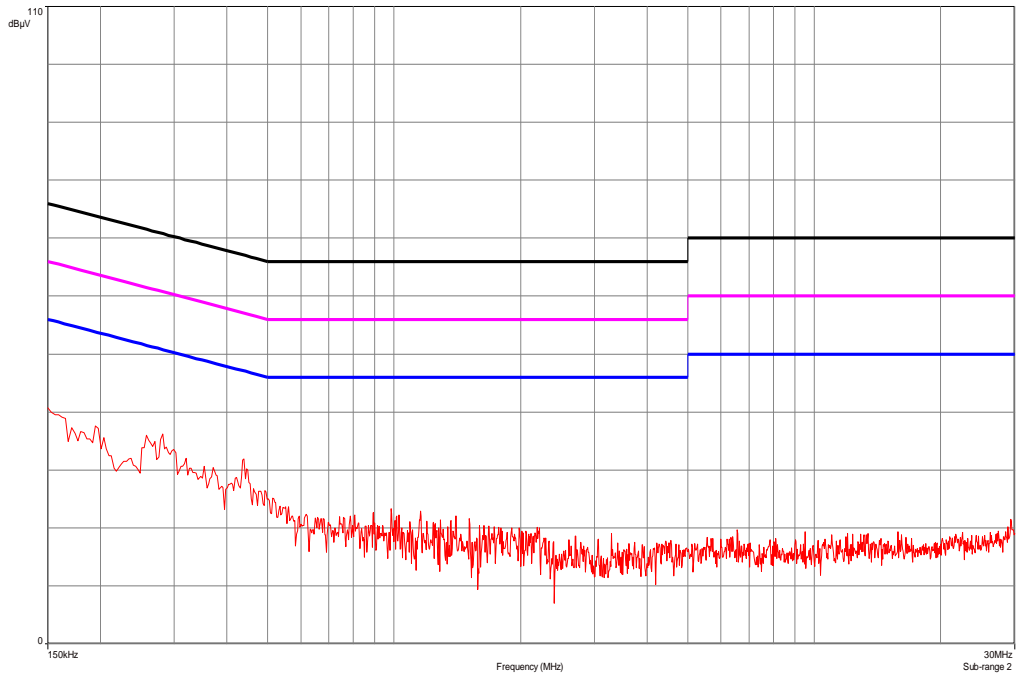

Plot 2: 150 kHz to 30 MHz / neutral Line, TX mode

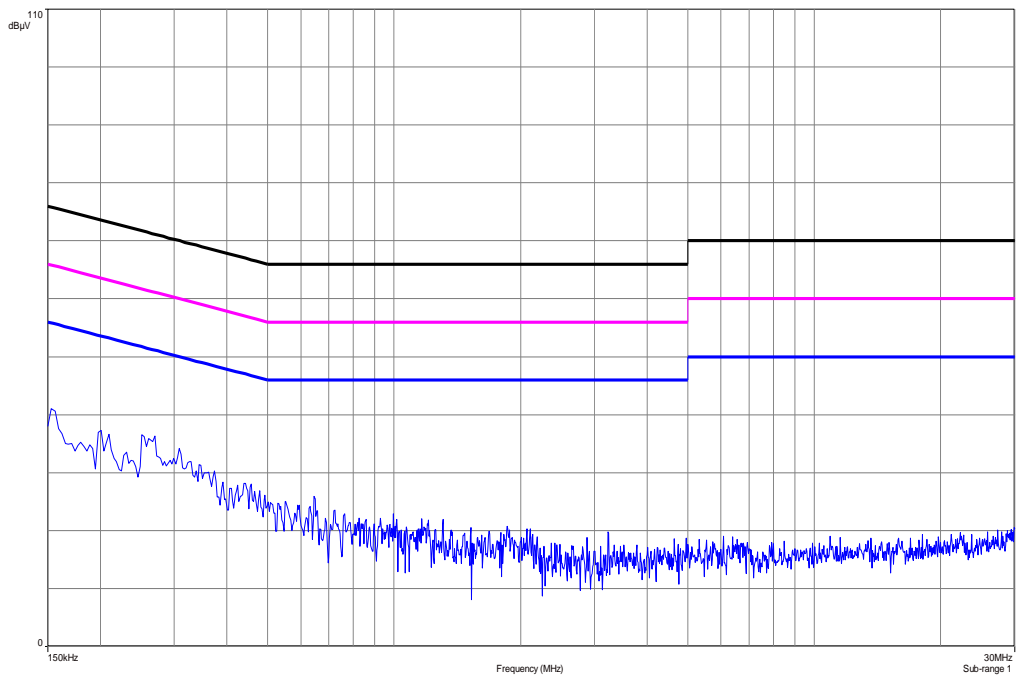

Plot 3: 150 kHz to 30 MHz / phase Line, RX mode

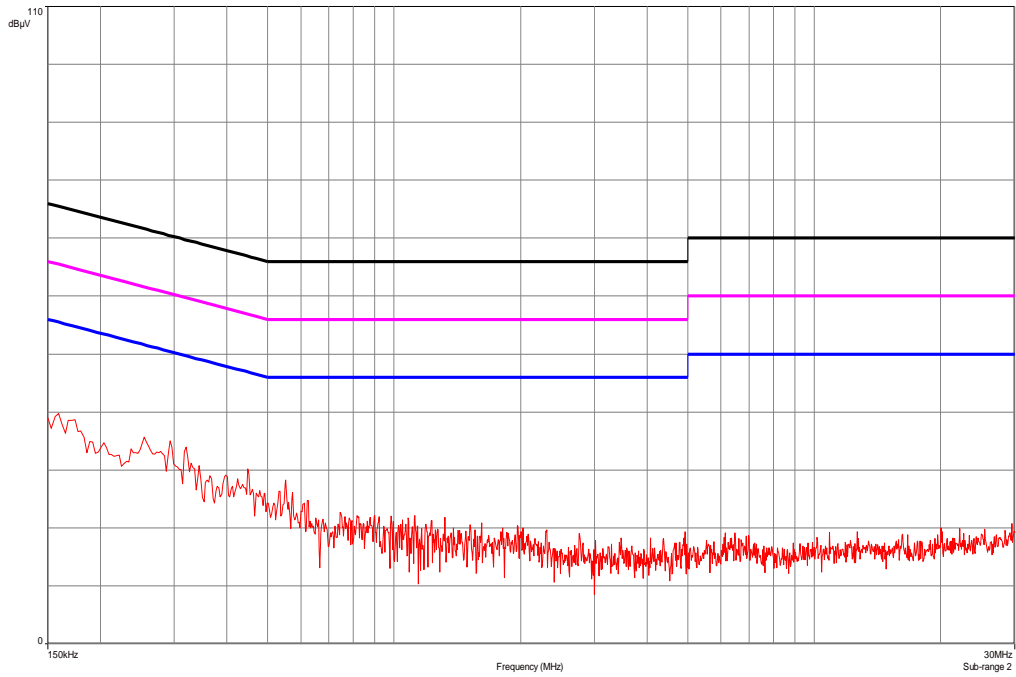

Plot 4: 150 kHz to 30 MHz / neutral Line, RX mode

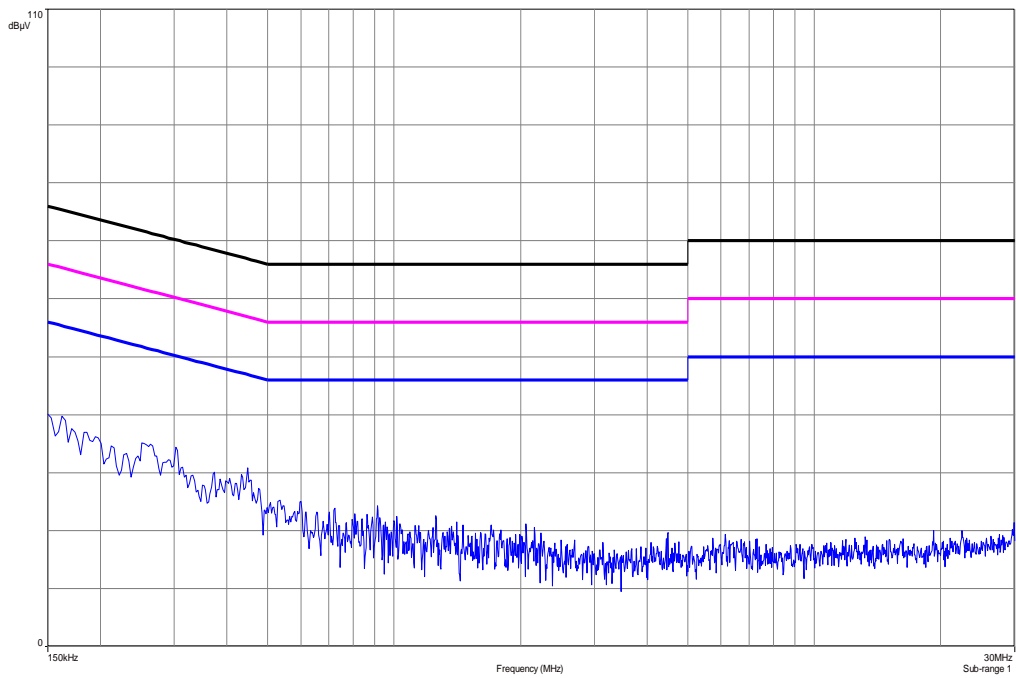

10 Test equipment and ancillaries used for tests

Typically, the calibrations of the test apparatus are commissioned to and performed by an accredited calibration laboratory. The calibration intervals are determined in accordance with the DIN EN ISO/IEC 17025. In addition to the external calibrations, the laboratory executes comparison measurements with other calibrated test systems or effective verifications. Weekly chamber inspections and range calibrations are performed. Where possible, rf-generating and signalling equipment as well as measuring receivers and analyzers are connected to an external high-precision 10 MHz reference (GPS-based or rubidium frequency standard).

In order to simplify the identification of the equipment used at some special tests, some items of test equipment and ancillaries can be provided with an identifier or number in the equipment list below (Labor/Item).

No.	Lab / Item	Equipment	Type	Manufact.	Serial No.	INV. No Cetecom	Kind of Calibration	Last Calibration	Next Calibration
1	45	Switch-Unit	3488A	HP Meßtechnik	2719A14505	300000368	g		
2	50	DC power supply, 60Vdc, 50A, 1200 W	6032A	HP Meßtechnik	2920A04466	300000580	ne		
3	n. a.	software	SPS_PHE 1.4f	Spitzberger & Spieß	B5981; 5D1081;B597 9	300000210	ne		
4	n. a.	EMI Test Receiver	ESCI 3	R&S	100083	300003312	k	09.01.2013	09.01.2014
5	n. a.	Analyzer- Reference- System (Harmonics and Flicker)	ARS 16/1	SPS	A3509 07/0 0205	300003314	k	14.07.2011	14.07.2013
6	n. a.	Amplifier	JS42- 00502650- 28-5A	MITEQ	1084532	300003379	ev		
7	n. a.	Antenna Tower	Model 2175	ETS- LINDGREN	64762	300003745	izw		
8	n. a.	Positioning Controller	Model 2090	ETS- LINDGREN	64672	300003746	izw		
9	n. a.	Turntable Interface-Box	Model 105637	ETS- LINDGREN	44583	300003747	izw		
10	n. a.	TRILOG Broadband Test-Antenna 30 MHz - 3 GHz	VULB9163	Schwarzbe ck	295	300003787	k	12.04.2012	12.04.2014
11	n. a.	Spectrum- Analyzer	FSU26	R&S	200809	300003874	k	16.01.2013	16.01.2014
12	n. a.	Double-Ridged Waveguide Horn Antenna 1-18.0GHz	3115	EMCO	8812-3088	300001032	vIKI!	11.05.2011	11.05.2013
13	n. a.	Active Loop Antenna	6502	EMCO	2210	300001015	ne		
14	n. a.	Anechoic chamber	FAC 3/5m	MWB / TDK	87400/02	300000996	ev		
15	n. a.	Switch / Control Unit	3488A	HP Meßtechnik	*	300000199	ne		
16	n. a.	Switch / Control Unit	3488A	HP Meßtechnik	2719A15013	300001156	ne		
17	9	Isolating Transformer	MPL IEC625 Bus Regeltrennt ravo	Erfi	91350	300001155	ne		
18	n. a.	Three-Way Power Splitter, 50 Ohm	11850C	HP Meßtechnik		300000997	ne		
19	n. a.	Amplifier	js42- 00502650- 28-5a	Parzich GMBH	928979	300003143	ne		
20	n. a.	Highpass Filter	WHKX7.0/1 8G-8SS	Wainwright	18	300003789	ne		
21	n. a.	TRILOG Broadband Test-Antenna 30 MHz - 3 GHz	VULB9163	Schwarzbe ck	371	300003854	vIKI!	14.10.2011	14.10.2014
22	n. a.	MXE EMI Receiver 20 Hz bis 26,5 GHz	N9038A	Agilent Technologi es	MY51210197	300004405	k	21.02.2013	21.02.2014
23	CR 79	Std. Gain Horn	V637	Narda	7911	300001751	ne		

		Antenna 26.5-40.0 GHz							
24	11b	Microwave System Amplifier, 0.5-26.5 GHz	83017A	HP Meßtechnik	00419	300002268	ev		
25	A025	Std. Gain Horn Antenna 12.4 to 18.0 GHz	639	Narda		300000786	ne		
26	A027	Std. Gain Horn Antenna 18.0 to 26.5 GHz	638	Narda		300000486	ne		
27	n. a.	Spectrum Analyzer 20 Hz - 50 GHz	FSU50	R&S	200012	300003443	Ve	09.10.2012	09.10.2014
28	n. a.	Broadband Low Noise Amplifier 18-50 GHz	CBL18503 070-XX	CERNEX	19338	300004273	ne		
29	n. a.	Signal Analyzer 40 GHz	FSV40	R&S	101042	300004517	k	22.10.2012	22.10.2013
30	n. a.	DC Power Supply 0 – 32V	1108-32	Heiden	001802	300001383	Ve	23.06.2010	23.06.2013
31	n. a.	DC power supply, 60Vdc, 50A, 1200 W	6032A	HP Meßtechnik	2920A04590	300001041	Ve	12.01.2012	12.01.2015

Agenda: Kind of Calibration

- | | | | |
|------|--|-----|--|
| k | calibration / calibrated | EK | limited calibration |
| ne | not required (k, ev, izw, zw not required) | zw | cyclical maintenance (external cyclical maintenance) |
| ev | periodic self verification | izw | internal cyclical maintenance |
| Ve | long-term stability recognized | g | blocked for accredited testing |
| vkI! | Attention: extended calibration interval | | |
| NK! | Attention: not calibrated | *) | next calibration ordered / currently in progress |

11 Observations

No observations exceeding those reported with the single test cases have been made.

Annex A Document history

Version	Applied changes	Date of release
1.0	Initial release	2013-04-10
A	Changed RSP100	2013-04-17
B	Changed power setting n HT40 channel 62	2013-04-17

Annex B Further information

Glossary

AVG	-	Average
DUT	-	Device under test
EMC	-	Electromagnetic Compatibility
EN	-	European Standard
EUT	-	Equipment under test
ETSI	-	European Telecommunications Standard Institute
FCC	-	Federal Communication Commission
FCC ID	-	Company Identifier at FCC
HW	-	Hardware
IC	-	Industry Canada
Inv. No.	-	Inventory number
N/A	-	Not applicable
PP	-	Positive peak
QP	-	Quasi peak
S/N	-	Serial number
SW	-	Software

Annex C Accreditation Certificate

Front side of certificate



Back side of certificate



Note:

The current certificate including annex is published on our website (see link below) or may be received from CETECOM ICT Services on request.

<http://www.cetecom.com/eu/de/cetecom-group/europa/deutschland-saarbruecken/akkreditierungen.html>