



SAR TEST REPORT

No. 2013SAR00184

For

Sony Mobile Communications (China) Co. Ltd

GSM/WCDMA/LTE mobile phone

Type number: PM-0764-BV

Marketing name: D5316

With

Hardware Version: AP1

Software Version: 19.0.B.0.228 (Main antenna)

s_atp_tianchi_us_1_0_14_6 (WLAN antenna)

FCC ID: PY7PM-0764

Issued Date: 2014-02-28



Note:

The test results in this test report relate only to the devices specified in this report. This report shall not be reproduced except in full without the written approval of TMC Beijing.

Test Laboratory:

TMC Beijing, Telecommunication Metrology Center of MIIT

No. 52, Huayuan Bei Road, Haidian District, Beijing, P. R. China 100191.

Tel:+86(0)10-62304633-2079, Fax:+86(0)10-62304633 Email:welcome@emcite.com. www.emcite.com

Revision Version

Report Number	Revision	Date	Memo
2013SAR00184	00	2014-02-28	Initial creation of test report

TABLE OF CONTENT

1 TEST LABORATORY	5
1.1 TESTING LOCATION	5
1.2 TESTING ENVIRONMENT.....	5
1.3 PROJECT DATA	5
1.4 SIGNATURE.....	5
2 STATEMENT OF COMPLIANCE	6
3 CLIENT INFORMATION	9
3.1 APPLICANT INFORMATION	9
3.2 MANUFACTURER INFORMATION	9
4 EQUIPMENT UNDER TEST (EUT) AND ANCILLARY EQUIPMENT (AE)	10
4.1 ABOUT EUT	10
4.2 INTERNAL IDENTIFICATION OF EUT USED DURING THE TEST	10
4.3 INTERNAL IDENTIFICATION OF AE USED DURING THE TEST	11
5 TEST METHODOLOGY	11
5.1 APPLICABLE LIMIT REGULATIONS	11
5.2 APPLICABLE MEASUREMENT STANDARDS.....	11
6 SPECIFIC ABSORPTION RATE (SAR).....	12
6.1 INTRODUCTION.....	12
6.2 SAR DEFINITION.....	12
7 TISSUE SIMULATING LIQUIDS	13
7.1 TARGETS FOR TISSUE SIMULATING LIQUID	13
7.2 DIELECTRIC PERFORMANCE	14
8 SYSTEM VERIFICATION	21
8.1 SYSTEM SETUP.....	21
8.2 SYSTEM VERIFICATION.....	22
9 MEASUREMENT PROCEDURES	23
9.1 TESTS TO BE PERFORMED	23
9.2 GENERAL MEASUREMENT PROCEDURE.....	24
9.3 WCDMA MEASUREMENT PROCEDURES FOR SAR	25
9.4 SAR MEASUREMENT FOR LTE.....	26
9.5 BLUETOOTH & WI-FI MEASUREMENT PROCEDURES FOR SAR	27
9.6 POWER DRIFT.....	28
10 AREA SCAN BASED 1-G SAR.....	28
10.1 REQUIREMENT OF KDB.....	28
10.2 FAST SAR ALGORITHMS	28
11 CONDUCTED OUTPUT POWER.....	29

11.1 MANUFACTURING TOLERANCE	29
11.2 HOTSPOT	33
11.3 GSM MEASUREMENT RESULT	41
11.4 WCDMA MEASUREMENT RESULT.....	42
11.5 LTE MEASUREMENT RESULT	43
11.6 WI-FI AND BT MEASUREMENT RESULT	51
12 SIMULTANEOUS TX SAR CONSIDERATIONS.....	55
12.1 INTRODUCTION.....	55
12.2 TRANSMIT ANTENNA SEPARATION DISTANCES	55
12.3 SAR MEASUREMENT POSITIONS	55
12.4 STANDALONE SAR TEST EXCLUSION CONSIDERATIONS	56
13 EVALUATION OF SIMULTANEOUS.....	57
14 SAR TEST RESULT	58
14.1 SAR RESULTS FOR FAST SAR.....	58
14.2 SAR RESULTS FOR STANDARD PROCEDURE.....	68
15 SAR MEASUREMENT VARIABILITY.....	73
16 MEASUREMENT UNCERTAINTY	74
17 MAIN TEST INSTRUMENTS.....	78
ANNEX A GRAPH RESULTS.....	79
ANNEX B SYSTEM VERIFICATION RESULTS	129
ANNEX C SAR MEASUREMENT SETUP	148
ANNEX D POSITION OF THE WIRELESS DEVICE IN RELATION TO THE PHANTOM	154
ANNEX E EQUIVALENT MEDIA RECIPES	157
ANNEX F SYSTEM VALIDATION	158
ANNEX G PROBE CALIBRATION CERTIFICATE.....	159
ANNEX H DIPOLE CALIBRATION CERTIFICATE	170

1 Test Laboratory

1.1 Testing Location

Company Name:	TMC Beijing, Telecommunication Metrology Center of MIIT
Address:	No 52, Huayuan beilu, Haidian District, Beijing, P.R.China
Postal Code:	100191
Telephone:	+86-10-62304633
Fax:	+86-10-62304793

1.2 Testing Environment

Temperature:	18°C~25 °C,
Relative humidity:	30%~ 70%
Ground system resistance:	< 0.5 Ω
Ambient noise & Reflection:	< 0.012 W/kg

1.3 Project Data

Project Leader:	Qi Dianyuan
Test Engineer:	Lin Xiaojun
Testing Start Date:	February 7, 2014
Testing End Date:	February 17, 2014

1.4 Signature



Lin Xiaojun
(Prepared this test report)

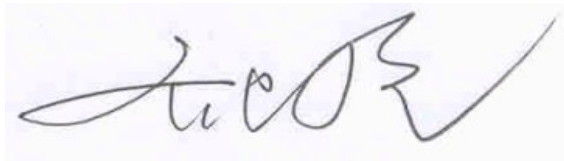

Qi Dianyuan
(Reviewed this test report)



Xiao Li
Deputy Director of the laboratory
(Approved this test report)

2 Statement of Compliance

The maximum results of SAR found during testing for Sony Mobile Communications (China) Co. Ltd GSM/WCDMA/LTE mobile phone PM-0764-BV / D5316 are as follows:

Table 2.1: Highest Reported SAR (1g)

Exposure Configuration	Technology Band	Highest Reported SAR 1g (W/Kg)	Equipment Class
Head (Separation Distance 0mm)	GSM 850	0.36	PCE
	PCS 1900	0.32	
	UMTS FDD 2	0.48	
	UMTS FDD 4	0.45	
	UMTS FDD 5	0.44	
	LTE Band 2	0.37	
	LTE Band 4	0.33	
	LTE Band 17	0.12	
	WLAN 2.4&5.8 GHz	0.49	DTS
	WLAN 5 GHz	0.19	UNII
Hotspot (Separation Distance 10mm)	GSM 850	0.58	PCE
	PCS 1900	0.51	
	UMTS FDD 2	0.63	
	UMTS FDD 4	0.79	
	UMTS FDD 5	0.74	
	LTE Band 2	0.58	
	LTE Band 4	0.66	
	LTE Band 17	0.20	
	WLAN 2.4&5.8 GHz	0.52	DTS
	WLAN 5 GHz	/	UNII
Body-worn (Data) (Separation Distance 15mm)	GSM 850	/	PCE
	PCS 1900	0.35	
	UMTS FDD 2	0.43	
	UMTS FDD 4	0.52	
	UMTS FDD 5	/	
	LTE Band 2	0.40	
	LTE Band 4	0.39	
	LTE Band 17	/	
	WLAN 2.4&5.8 GHz	0.31	DTS
	WLAN 5 GHz	0.54	UNII
Body-worn (Speech) (Separation Distance 15mm)	GSM 850	0.29	PCE
	PCS 1900	0.27	
	UMTS FDD 2	0.10	

	UMTS FDD 4	0.51	
	UMTS FDD 5	0.41	
	LTE Band 2	/	
	LTE Band 4	/	
	LTE Band 17	/	
	WLAN 2.4&5.8 GHz	/	DTS
	WLAN 5 GHz	/	UNII

The SAR values found for the Mobile Phone are below the maximum recommended levels of 1.6 W/Kg as averaged over any 1g tissue according to the ANSI C95.1-1999.

For body worn operation, this device has been tested and meets FCC RF exposure guidelines when used with any accessory that contains no metal and which provides a minimum separation distance of 10 mm for hotspot on and 15mm for hotspot off and speech between this device and the body of the user. Use of other accessories may not ensure compliance with FCC RF exposure guidelines.

The EUT battery must be fully charged and checked periodically during the test to ascertain uniform power output.

The measurement together with the test system set-up is described in annex C of this test report. A detailed description of the equipment under test can be found in chapter 4 of this test report. The highest reported SAR value is obtained at the case of **(Table 2.1)**, and the values are: **0.79 W/kg (1g)**.

Table 2.2: The sum of reported SAR values for main antenna and WiFi-2.4G

	Position	GSM/UMTS	WiFi-2.4G	Sum
Maximum reported SAR value for Head	Left hand, Touch cheek	0.48	0.49	0.97
Maximum reported SAR value for Body	Front 10mm	0.79	0.15	0.94
	Rear 10mm	0.74	0.52	1.26

Table 2.3: The sum of reported SAR values for main antenna, WiFi-5G and BT

	Position	GSM/UMTS	WiFi-5G	BT	Sum
Maximum reported SAR value for Head	Left hand, Touch cheek	0.48	0.19	0.37 ^[1]	1.04
Maximum reported SAR value for Body	Front 10mm	0.79	0.02	0.19 ^[1]	1.00
	Rear 10mm	0.74	0.16	0.19 ^[1]	1.09
	Front 15mm	0.43	0.54	0.12 ^[1]	1.09
	Rear 15mm	0.52	0.03	0.12 ^[1]	0.67

[1] - Estimated SAR for Bluetooth (see the table 13.3)

According to the above tables, the highest sum of reported SAR values is **1.26 W/kg (1g)**. The detail for simultaneous transmission consideration is described in chapter 13.

Because the display diagonal dimension is > 15.0cm, the phone is phablet. So it has to be estimated as follow:

According to the KDB648474 D04, when hotspot mode applies, 10-g extremity SAR is required only for the surfaces and edges with hotspot mode 1-g reported SAR > 1.2 W/kg.

Table 2.4: Highest Reported SAR (10g extremity)

Technology Band	Test Position	Conducted Power (dBm)	Max. tune-up Power (dBm)	Highest Measured SAR(1g) (W/kg)	Highest Reported SAR 1g (W/Kg)	Highest Reported SAR 10g extremity (W/Kg)
GSM 850	Rear	28.56	28.8	0.545	0.58	/
PCS 1900 (AP OFF)	Front	24.87	25.0	0.335	0.35	/
PCS 1900 (AP ON)	Front	28.72	31.0	0.474	0.80	/
UMTS FDD 2 (AP OFF)	Rear	22.26	22.3	0.426	0.43	/
UMTS FDD 2 (AP ON)	Front	19.95	22.3	0.581	1.00	/
UMTS FDD 4 (AP OFF)	Front	23.25	24.0	0.441	0.52	/
UMTS FDD 4 (AP ON)	Front	23.39	24.0	0.771	0.89	/
UMTS FDD 5	Rear	23.95	25.0	0.584	0.74	/
LTE Band 2 (AP OFF)	Bottom	22.19	22.3	0.393	0.40	/
LTE Band 2 (AP ON)	Rear	20.06	22.3	0.550	0.92	/
LTE Band 4 (AP OFF)	Front	23.37	24.0	0.339	0.39	/
LTE Band 4 (AP ON)	Front	21.99	24.0	0.468	0.74	/
LTE Band 17	Rear	23.38	24.0	0.172	0.20	/
WLAN 2.4GHz	Rear	19.90	20.0	0.508	0.52	/
WLAN 5GHz	Rear	15.40	16.0	0.468	0.54	/
WLAN 5.8GHZ (AP OFF)	Rear	15.52	16.0	0.277	0.31	/
WLAN 5.8GHZ (AP ON)	Rear	12.66	16.0	0.148	0.32	/

According to the above tables, the Highest Reported SAR for 10g extremity is not required.

3 Client Information

3.1 Applicant Information

Company Name:	Sony Mobile Communications (China) Co. Ltd
Address /Post:	Sony Mobile R&D Center, No. 16, Guangshun South Street, Chaoyang District
City:	Beijing
Postal Code:	100102
Country:	China
Contact Person:	Ma, Gang
Telephone:	+86-10-58656312
Fax:	+86-10-58659049

3.2 Manufacturer Information

Company Name:	Sony Mobile Communications AB
Address /Post:	Mobilvägen, 22188 Lund, Sweden
City:	Lund
Postal Code:	22188
Country:	Sweden
Contact Person:	Nilsson, Mikael
Telephone:	+46 703 227503
Fax:	+46 706 127385

4 Equipment Under Test (EUT) and Ancillary Equipment (AE)

4.1 About EUT

Description:	GSM/WCDMA/LTE mobile phone
Type name:	PM-0764-BV
Marketing name:	D5316
Operating mode(s):	GSM 850/900/1800/1900, WCDMA 850/1700/1900/2100 BT, Wi-Fi (2.4G&5G), LTE Band 2/4/17
Tested Tx Frequency:	825 – 848.8 MHz (GSM 850)
	1850.2 – 1910 MHz (GSM 1900)
	826.4–846.6 MHz (WCDMA850 Band V)
	1712.4 – 1752.6 MHz (WCDMA 1700 Band IV)
	1852.4–1907.6 MHz (WCDMA1900 Band II)
	1860 – 1900 MHz (LTE Band 2)
	1720 – 1745 MHz (LTE Band 4)
	709 – 711 MHz (LTE Band 17)
	2412 – 2462 MHz (Wi-Fi 2.4G)
5180 – 5825 MHz (Wi-Fi 5G)	
GPRS/EGPRS Multislot Class:	12
GPRS capability Class:	B
Test device Production information:	Production unit
Device type:	Portable device
Antenna type:	Integrated antenna
Accessories/Body-worn configurations:	Headset
Hotspot mode:	Support simultaneous transmission of hotspot and voice(or data)
Form factor:	165.2 mm × 83.8 mm

4.2 Internal Identification of EUT used during the test

EUT ID*	IMEI	HW	SW Version	Tested Band
EUT1	004402451868248	AP1	19.0.B.0.228	Main antenna
EUT2	004402451868271	AP1	19.0.B.0.228	Main antenna
EUT3	004402451868073	AP1	19.0.B.0.228	Hotspot
EUT4	004402451868057	AP1	19.0.B.0.228	Hotspot
EUT5	004402451868602	AP1	s_atp_tianchi_us_1_0_14_6	WLAN
EUT6	004402451868552	AP1	s_atp_tianchi_us_1_0_14_6	WLAN

*EUT ID: is used to identify the test sample in the lab internally.

Note: There are different software version between the SAR sample and the WLAN sample. Because the SAR sample is controlled to work by Digital Radio Communication tester, the WLAN sample is controlled to work by the terminal software installed on the PC.

4.3 Internal Identification of AE used during the test

AE ID*	Description	Model	SN	Manufacturer
AE1	Battery	Mari	/	LGC
AE2	Headset	MH410c	/	Foster

*AE ID: is used to identify the test sample in the lab internally.

5 TEST METHODOLOGY

5.1 Applicable Limit Regulations

ANSI C95.1–1999: IEEE Standard for Safety Levels with Respect to Human Exposure to Radio Frequency Electromagnetic Fields, 3 kHz to 300 GHz.

It specifies the maximum exposure limit of **1.6 W/kg** as averaged over any 1 gram of tissue for portable devices being used within 20 cm of the user in the uncontrolled environment.

5.2 Applicable Measurement Standards

IEEE 1528–2003: Recommended Practice for Determining the Peak Spatial-Average Specific Absorption Rate (SAR) in the Human Body Due to Wireless Communications Devices: Experimental Techniques.

KDB447498 D01: General RF Exposure Guidance v05r01: Mobile and Portable Devices RF Exposure Procedures and Equipment Authorization Policies.

KDB648474 D04 Handset SAR v01r01: SAR Evaluation Considerations for Wireless Handsets.

KDB941225 D01 SAR test for 3G devices v02: SAR Measurement Procedures for 3G Devices

KDB941225 D05 SAR for LTE Devices v02r02: SAR Evaluation Considerations for LTE Devices

KDB941225 D06 Hotspot Mode SAR v01r01: SAR Evaluation Procedures for Portable Devices with Wireless Router Capabilities

KDB248227: SAR measurement procedures for 802.112abg transmitters

KDB 865664 D01 SAR measurement 100 MHz to 6 GHz v01r01: SAR Measurement Requirements for 100 MHz to 6 GHz

KDB 865664 D02 RF Exposure Reporting v01r01: RF Exposure Compliance Reporting and Documentation Considerations

6 Specific Absorption Rate (SAR)

6.1 Introduction

SAR is related to the rate at which energy is absorbed per unit mass in an object exposed to a radio field. The SAR distribution in a biological body is complicated and is usually carried out by experimental techniques or numerical modeling. The standard recommends limits for two tiers of groups, occupational/controlled and general population/uncontrolled, based on a person's awareness and ability to exercise control over his or her exposure. In general, occupational/controlled exposure limits are higher than the limits for general population/uncontrolled.

6.2 SAR Definition

The SAR definition is the time derivative (rate) of the incremental energy (dW) absorbed by (dissipated in) an incremental mass (dm) contained in a volume element (dv) of a given density (ρ). The equation description is as below:

$$SAR = \frac{d}{dt} \left(\frac{dW}{dm} \right) = \frac{d}{dt} \left(\frac{dW}{\rho dv} \right)$$

SAR is expressed in units of Watts per kilogram (W/kg)

SAR measurement can be either related to the temperature elevation in tissue by

$$SAR = c \left(\frac{\delta T}{\delta t} \right)$$

Where: C is the specific heat capacity, δT is the temperature rise and δt is the exposure duration, or related to the electrical field in the tissue by

$$SAR = \frac{\sigma |E|^2}{\rho}$$

Where: σ is the conductivity of the tissue, ρ is the mass density of tissue and E is the RMS electrical field strength.

However for evaluating SAR of low power transmitter, electrical field measurement is typically applied.

7 Tissue Simulating Liquids

7.1 Targets for tissue simulating liquid

Table 7.1: Targets for tissue simulating liquid

Frequency(MHz)	Liquid Type	Conductivity(σ)	$\pm 5\%$ Range	Permittivity(ϵ)	$\pm 5\%$ Range
750	Head	0.89	0.85~0.93	41.94	39.8~44.0
750	Body	0.96	0.91~1.01	55.5	52.7~58.3
835	Head	0.90	0.86~0.95	41.5	39.4~43.6
835	Body	0.97	0.92~1.02	55.2	52.4~58.0
1750	Head	1.37	1.30~1.44	40.08	38.1~42.1
1750	Body	1.49	1.42~1.56	53.4	50.7~56.1
1900	Head	1.40	1.33~1.47	40.0	38.0~42.0
1900	Body	1.52	1.44~1.60	53.3	50.6~56.0
2450	Head	1.80	1.71~1.89	39.2	37.2~41.2
2450	Body	1.95	1.85~2.05	52.7	50.1~55.3
5200	Head	4.66	4.43~4.89	35.99	34.19~37.79
5200	Body	5.30	5.04~5.56	49.0	46.6~51.4
5300	Head	4.76	4.52~5.00	35.87	34.08~37.66
5300	Body	5.42	5.15~5.69	48.9	46.46~51.34
5600	Head	5.07	4.82~5.32	35.53	33.75~37.31
5600	Body	5.77	5.48~6.06	48.5	46.08~50.92
5800	Head	5.27	5.01~5.53	35.3	33.5~37.1
5800	Body	6.00	5.70~6.30	48.2	45.8~50.6

7.2 Dielectric Performance

Table 7.2: Dielectric Performance of Tissue Simulating Liquid

Measurement Date (yyyy-mm-dd)	Type	Frequency	Permittivity ϵ	Drift (%)	Conductivity σ (S/m)	Drift (%)
2014-2-10	Head	750 MHz	41.49	-1.07	0.883	-0.79
	Body	750 MHz	56.28	1.41	0.984	2.50
2014-2-7	Head	835 MHz	40.94	-1.35	0.924	2.67
	Body	835 MHz	56.37	2.12	0.973	0.31
2014-2-8	Head	1750 MHz	39.61	-1.17	1.389	1.39
	Body	1750 MHz	53.97	1.07	1.505	1.01
2014-2-9	Head	1900 MHz	39.57	-1.08	1.412	0.86
	Body	1900 MHz	52.08	-2.29	1.496	-1.58
2014-2-11	Head	2450 MHz	39.78	1.48	1.845	2.50
	Body	2450 MHz	53.36	1.25	1.975	1.28
2014-2-16	Head	5200 MHz	36.46	1.31	4.619	-0.88
	Body	5200 MHz	48.71	-0.59	5.182	-2.23
2014-2-16	Head	5300 MHz	36.24	1.03	4.75	-0.21
	Body	5300 MHz	48.49	-0.84	5.337	-1.53
2014-2-16	Head	5600 MHz	35.6	0.20	5.152	1.62
	Body	5600 MHz	47.84	-1.36	5.813	0.75
2014-2-16	Head	5800 MHz	35.16	-0.40	5.415	2.75
	Body	5800 MHz	47.4	-1.66	6.142	2.37

Note: The liquid temperature is 22.0°C

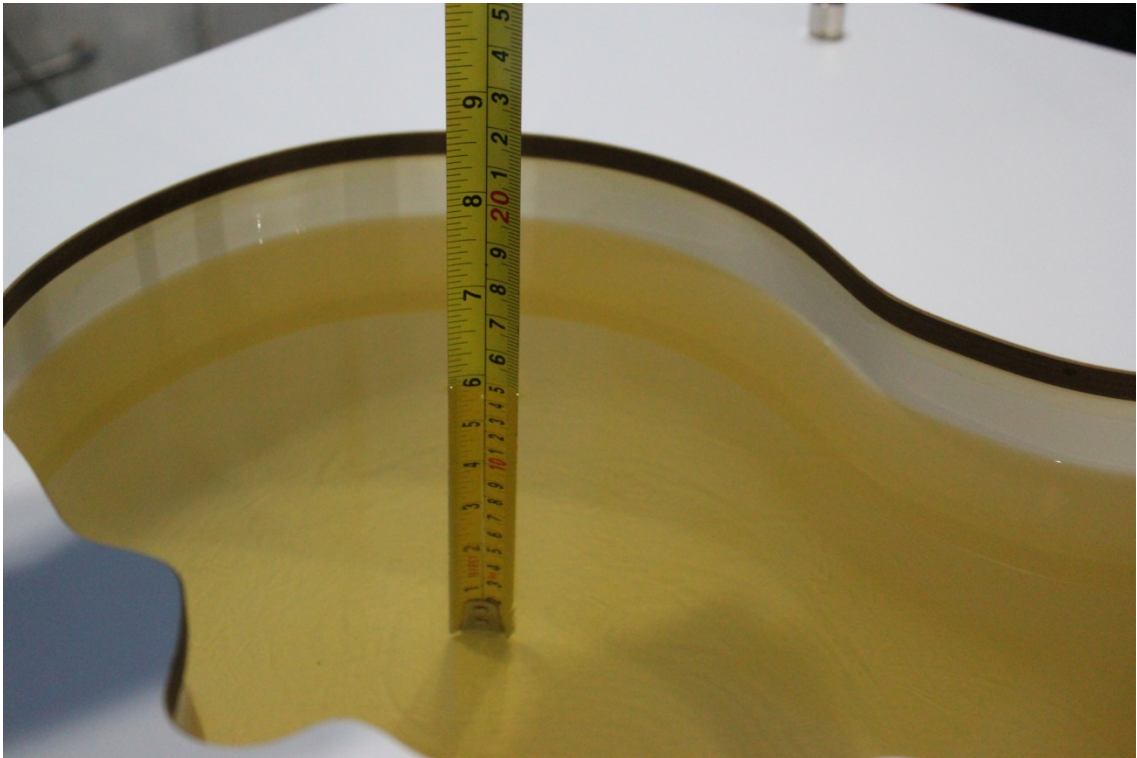

Picture 7-1: Liquid depth in the Head Phantom (750 MHz)



Picture 7-2: Liquid depth in the Flat Phantom (750 MHz)

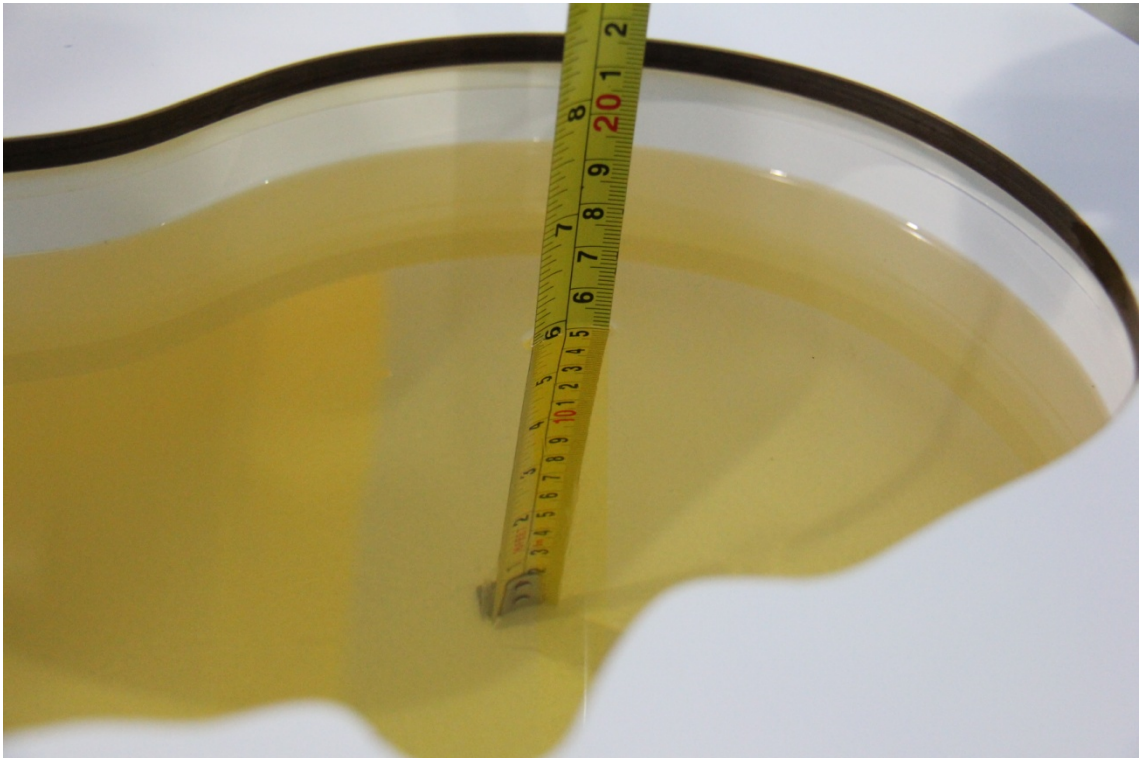

Picture 7-3 Liquid depth in the Head Phantom (835 MHz)



Picture 7-4 Liquid depth in the Flat Phantom (835 MHz)

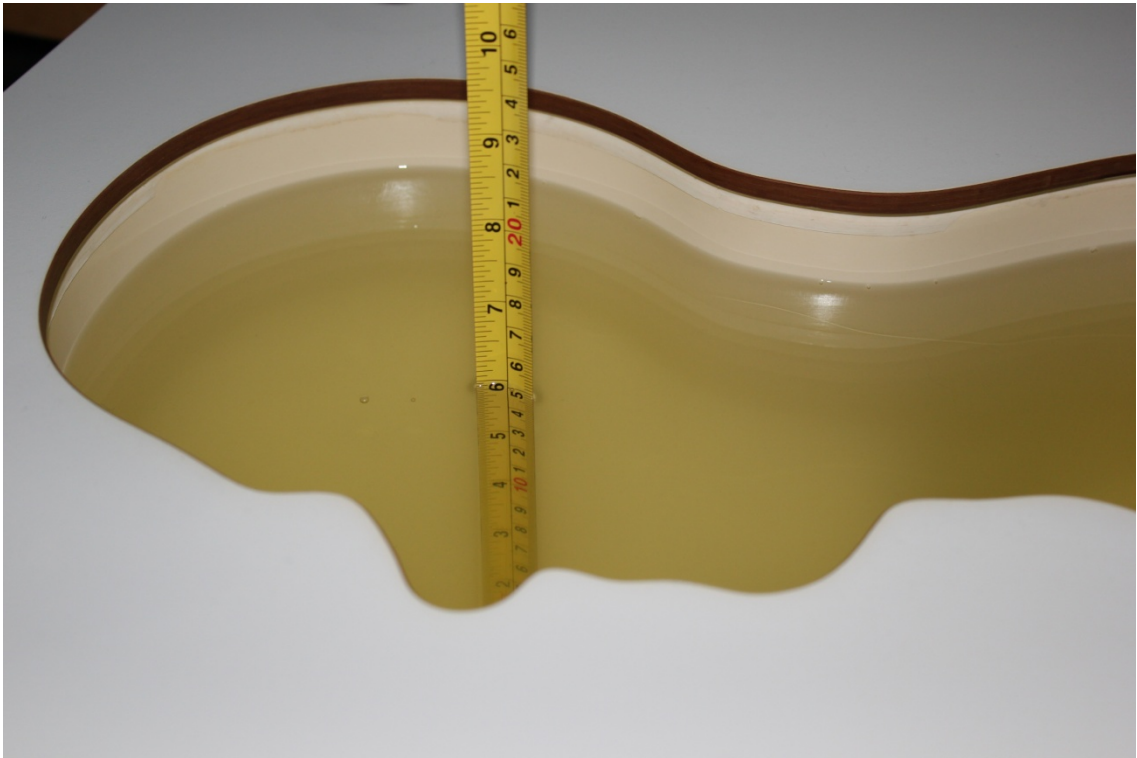

Picture 7-5 Liquid depth in the Head Phantom (1750 MHz)

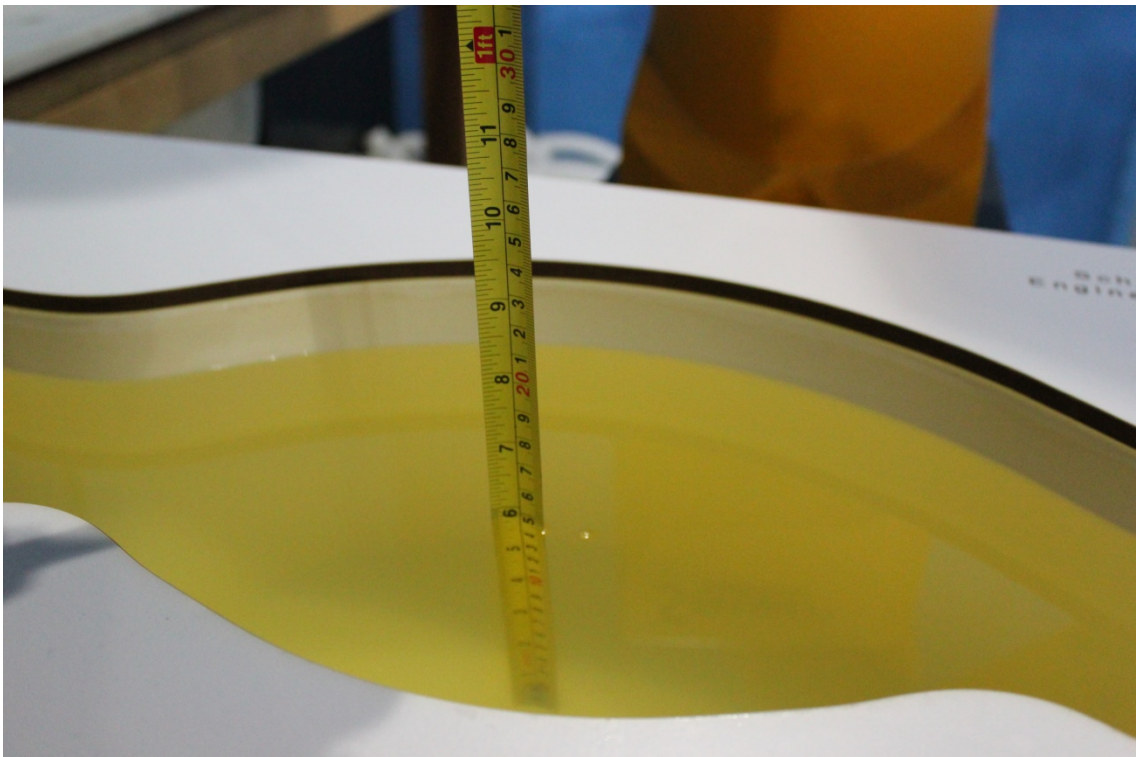

Picture 7-6 Liquid depth in the Flat Phantom (1750MHz)

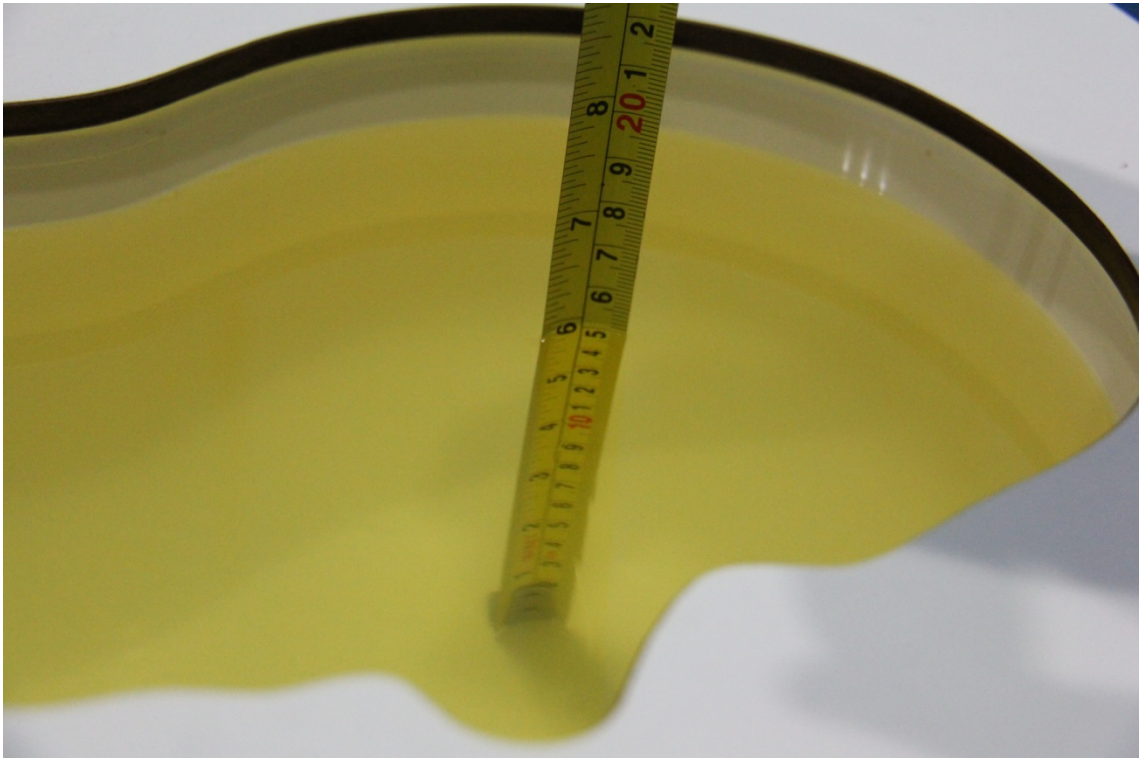

Picture 7-7 Liquid depth in the Head Phantom (1900 MHz)

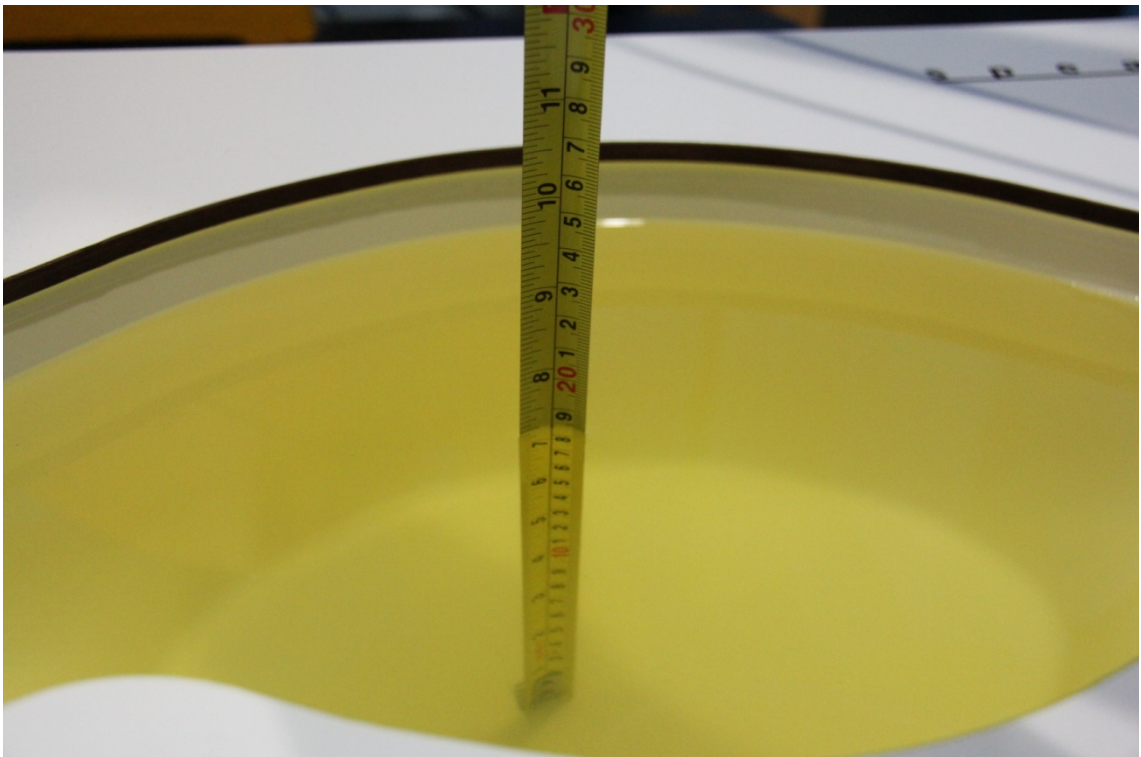

Picture 7-8 Liquid depth in the Flat Phantom (1900MHz)

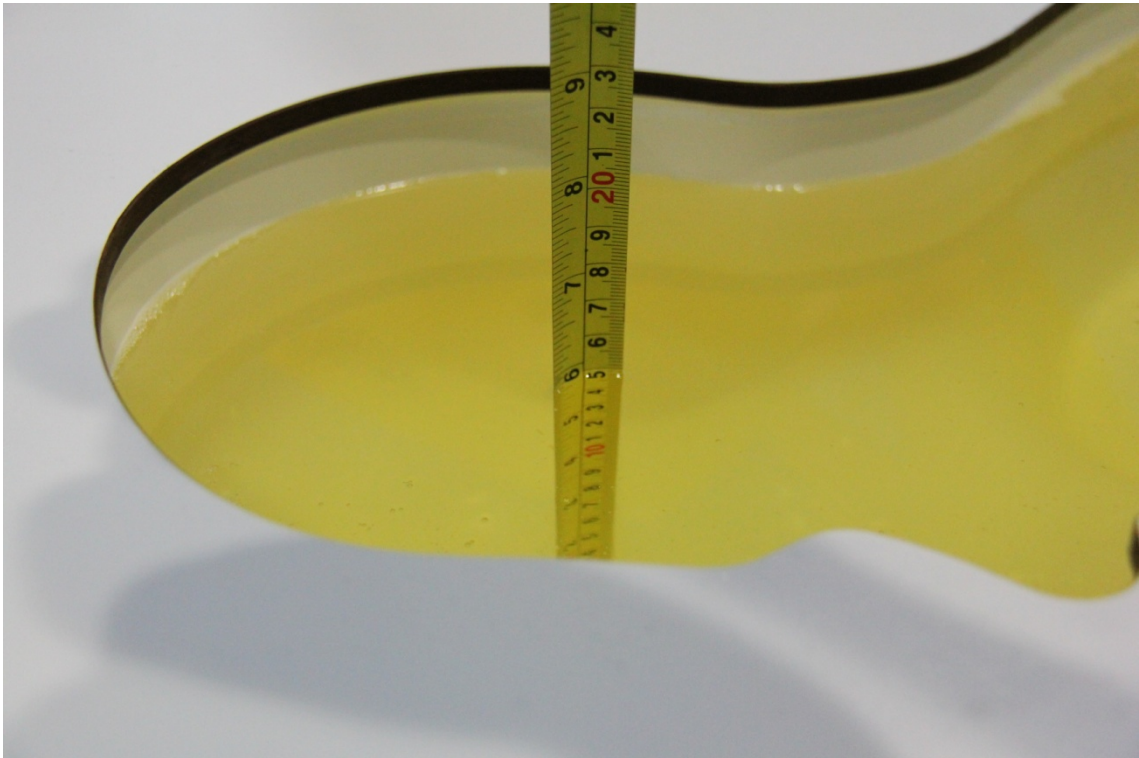

Picture 7-9 Liquid depth in the Head Phantom (2450MHz)

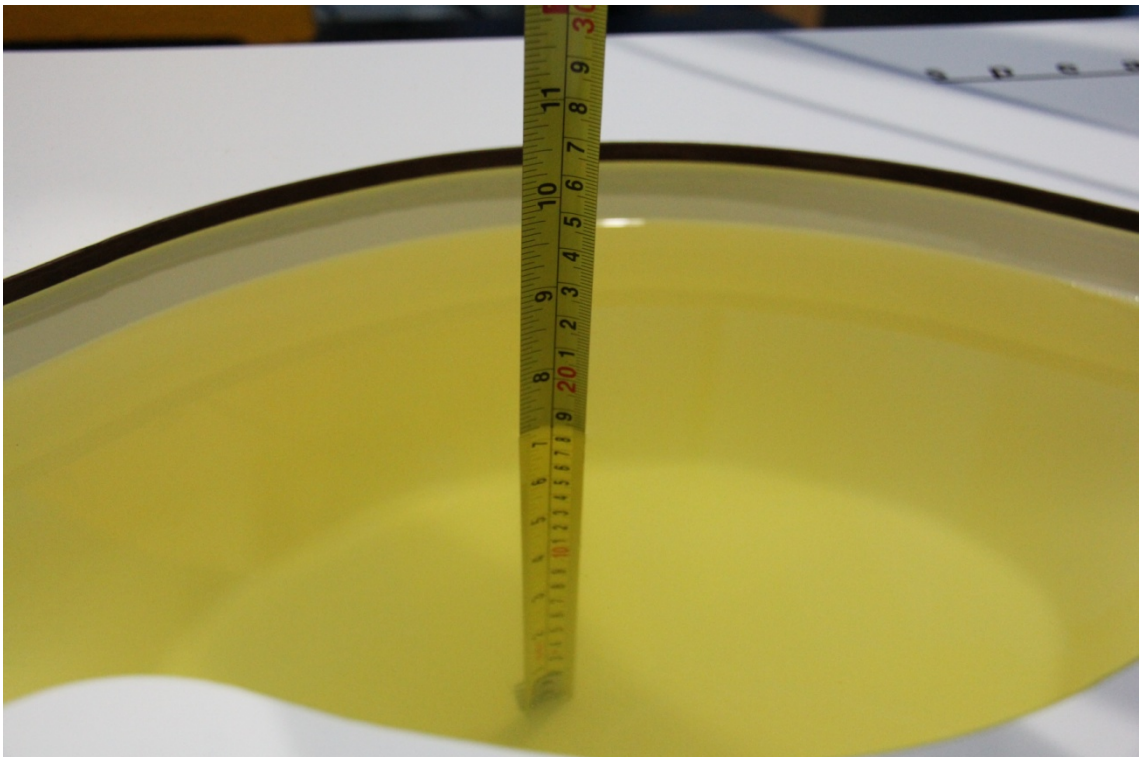

Picture 7-10 Liquid depth in the Flat Phantom (2450MHz)

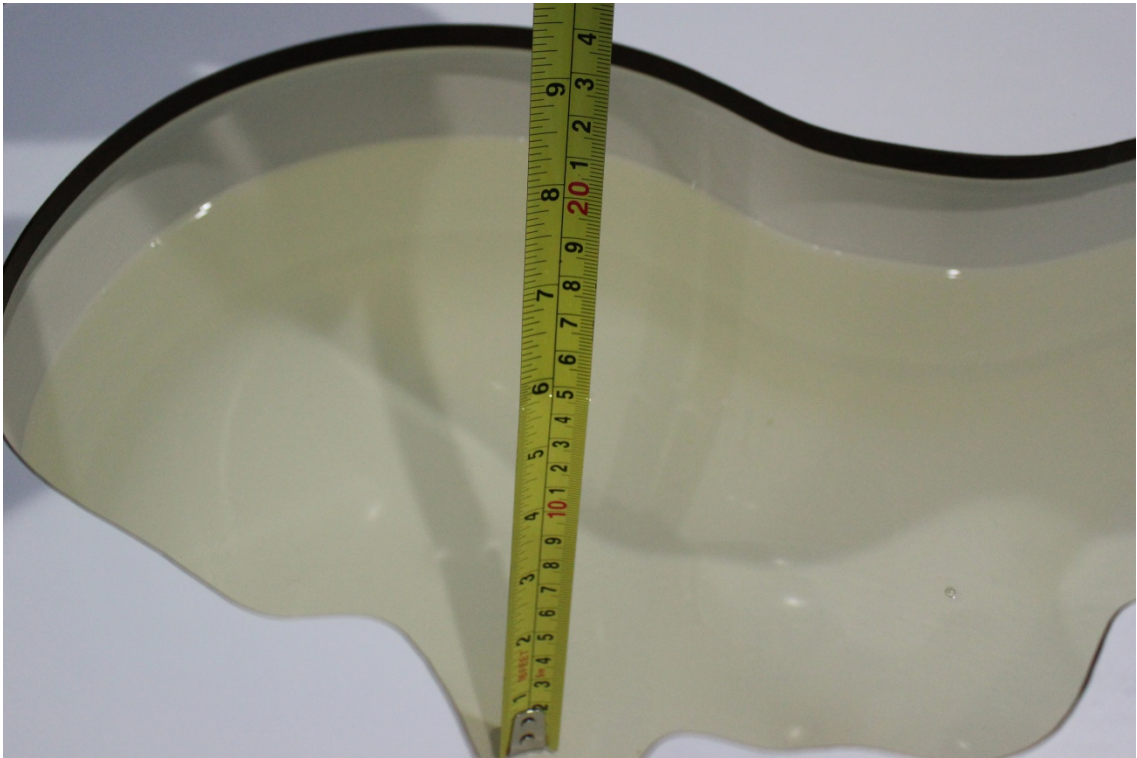

Picture 7-11 Liquid depth in the Head Phantom (5GHz)

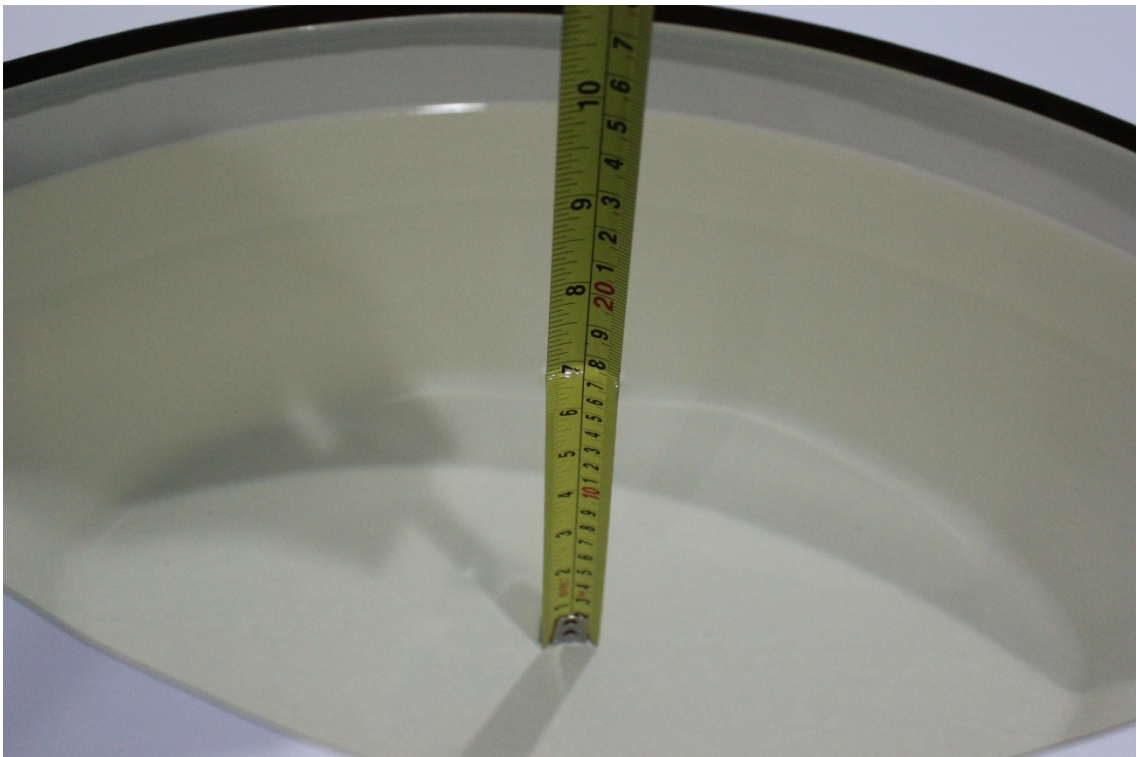

Picture 7-12 Liquid depth in the Flat Phantom (5GHz)

8 System verification

8.1 System Setup

In the simplified setup for system evaluation, the DUT is replaced by a calibrated dipole and the power source is replaced by a continuous wave that comes from a signal generator. The calibrated dipole must be placed beneath the flat phantom section of the SAM twin phantom with the correct distance holder. The distance holder should touch the phantom surface with a light pressure at the reference marking and be oriented parallel to the long side of the phantom. The equipment setup is shown below:

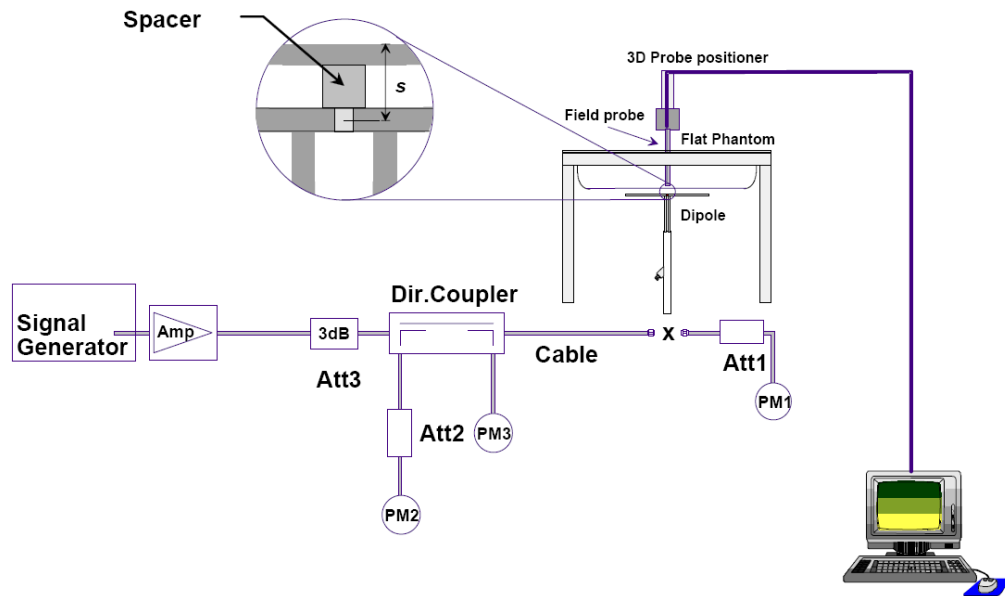

Picture 8.1 System Setup for System Evaluation

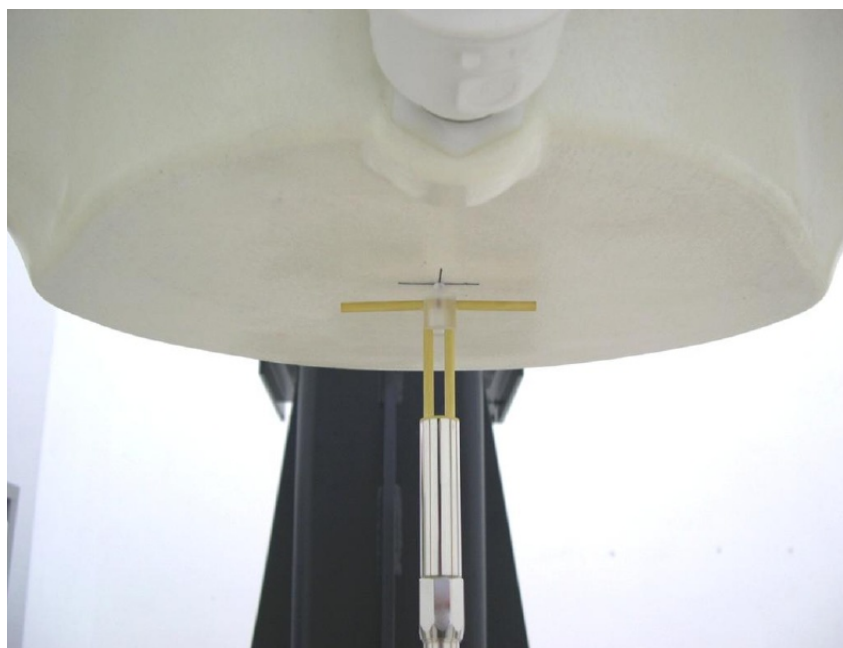

Picture 8.2 Photo of Dipole Setup

8.2 System Verification

SAR system verification is required to confirm measurement accuracy, according to the tissue dielectric media, probe calibration points and other system operating parameters required for measuring the SAR of a test device. The system verification must be performed for each frequency band and within the valid range of each probe calibration point required for testing the device.

The system verification results are required that the area scan estimated 1-g SAR is within 3% of the zoom scan 1-g SAR. The details are presented in annex B.

Table 8.1: System Verification of Head

Measurement Date (yyyy-mm-dd)	Frequency	Target value (W/kg)		Measured value (W/kg)		Deviation	
		10 g Average	1 g Average	10 g Average	1 g Average	10 g Average	1 g Average
2014-2-10	750 MHz	5.56	8.52	5.68	8.72	2.16%	2.35%
2014-2-7	835 MHz	6.16	9.44	6.12	9.36	-0.65%	-0.85%
2014-2-8	1750 MHz	19.6	36.9	20.08	37.72	2.45%	2.22%
2014-2-9	1900 MHz	21.3	40.4	20.96	39.76	-1.60%	-1.58%
2014-2-11	2450 MHz	24.9	53.4	24.68	52.40	-0.88%	-1.87%
2014-2-16	5200 MHz	22.8	79.7	23.40	81.60	2.63%	2.38%
2014-2-16	5300 MHz	23.5	82.1	23.10	81.20	-1.70%	-1.10%
2014-2-17	5600 MHz	23.5	82.8	23.80	84.80	1.28%	2.42%
2014-2-17	5800 MHz	22.2	78.2	22.60	79.40	1.80%	1.53%

Table 8.2: System Verification of Body

Measurement Date (yyyy-mm-dd)	Frequency	Target value (W/kg)		Measured value (W/kg)		Deviation	
		10 g Average	1 g Average	10 g Average	1 g Average	10 g Average	1 g Average
2014-2-10	750 MHz	5.75	8.75	5.60	8.48	-2.61%	-3.09%
2014-2-7	835 MHz	6.20	9.40	6.36	9.68	2.58%	2.98%
2014-2-8	1750 MHz	20.6	38.2	20.32	37.56	-1.36%	-1.68%
2014-2-9	1900 MHz	21.9	41.3	21.40	40.40	-2.28%	-2.18%
2014-2-11	2450 MHz	23.4	50.4	23.80	51.20	1.71%	1.59%
2014-2-16	5200 MHz	21.0	74.9	20.70	73.30	-1.43%	-2.14%
2014-2-16	5300 MHz	21.4	76.1	20.90	74.30	-2.34%	-2.37%
2014-2-17	5600 MHz	22.1	79.9	21.70	78.20	-1.81%	-2.13%
2014-2-17	5800 MHz	20.5	74.5	20.10	74.00	-1.95%	-0.67%

9 Measurement Procedures

9.1 Tests to be performed

In order to determine the highest value of the peak spatial-average SAR of a handset, all device positions, configurations and operational modes shall be tested for each frequency band according to steps 1 to 3 below. A flowchart of the test process is shown in picture 9.1.

Step 1: The tests described in 9.2 shall be performed at the channel that is closest to the centre of the transmit frequency band (f_c) for:

- a) all device positions (cheek and tilt, for both left and right sides of the SAM phantom, as described in annex D),
- b) all configurations for each device position in a), e.g., antenna extended and retracted, and
- c) all operational modes, e.g., analogue and digital, for each device position in a) and configuration in b) in each frequency band.

If more than three frequencies need to be tested according to 11.1 (i.e., $N_c > 3$), then all frequencies, configurations and modes shall be tested for all of the above test conditions.

Step 2: For the condition providing highest peak spatial-average SAR determined in Step 1, perform all tests described in 9.2 at all other test frequencies, i.e., lowest and highest frequencies. In addition, for all other conditions (device position, configuration and operational mode) where the peak spatial-average SAR value determined in Step 1 is within 3 dB of the applicable SAR limit, it is recommended that all other test frequencies shall be tested as well.

Step 3: Examine all data to determine the highest value of the peak spatial-average SAR found in Steps 1 to 2.

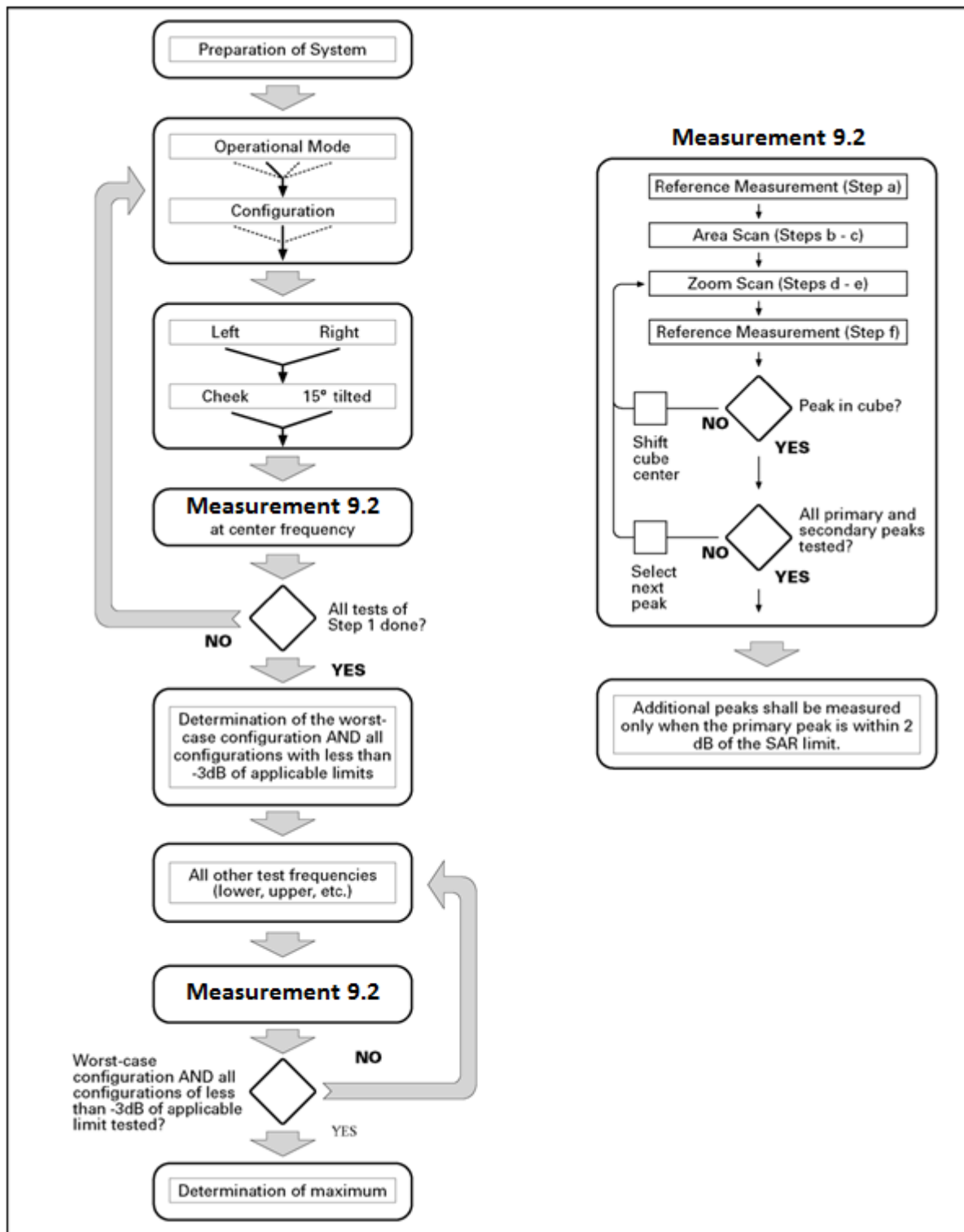

Picture 9.1 Block diagram of the tests to be performed

9.2 General Measurement Procedure

The area and zoom scan resolutions specified in the table below must be applied to the SAR measurements and fully documented in SAR reports to qualify for TCB approval. Probe boundary effect error compensation is required for measurements with the probe tip closer than half a probe

tip diameter to the phantom surface. Both the probe tip diameter and sensor offset distance must satisfy measurement protocols; to ensure probe boundary effect errors are minimized and the higher fields closest to the phantom surface can be correctly measured and extrapolated to the phantom surface for computing 1-g SAR. Tolerances of the post-processing algorithms must be verified by the test laboratory for the scan resolutions used in the SAR measurements, according to the reference distribution functions specified in IEEE Std 1528-2003. The results should be documented as part of the system validation records and may be requested to support test results when all the measurement parameters in the following table are not satisfied.

		≤ 3 GHz	> 3 GHz
Maximum distance from closest measurement point (geometric center of probe sensors) to phantom surface		5 ± 1 mm	$\frac{1}{2} \cdot \delta \cdot \ln(2) \pm 0.5$ mm
Maximum probe angle from probe axis to phantom surface normal at the measurement location		$30^\circ \pm 1^\circ$	$20^\circ \pm 1^\circ$
Maximum area scan spatial resolution: Δx_{Area} , Δy_{Area}		≤ 2 GHz: ≤ 15 mm 2 – 3 GHz: ≤ 12 mm	3 – 4 GHz: ≤ 12 mm 4 – 6 GHz: ≤ 10 mm
		When the x or y dimension of the test device, in the measurement plane orientation, is smaller than the above, the measurement resolution must be \leq the corresponding x or y dimension of the test device with at least one measurement point on the test device.	
Maximum zoom scan spatial resolution: Δx_{Zoom} , Δy_{Zoom}		≤ 2 GHz: ≤ 8 mm 2 – 3 GHz: ≤ 5 mm*	3 – 4 GHz: ≤ 5 mm* 4 – 6 GHz: ≤ 4 mm*
Maximum zoom scan spatial resolution, normal to phantom surface	uniform grid: $\Delta z_{Zoom}(n)$	≤ 5 mm	3 – 4 GHz: ≤ 4 mm 4 – 5 GHz: ≤ 3 mm 5 – 6 GHz: ≤ 2 mm
	graded grid $\Delta z_{Zoom}(1)$: between 1 st two points closest to phantom surface	≤ 4 mm	3 – 4 GHz: ≤ 3 mm 4 – 5 GHz: ≤ 2.5 mm 5 – 6 GHz: ≤ 2 mm
	$\Delta z_{Zoom}(n>1)$: between subsequent points	$\leq 1.5 \cdot \Delta z_{Zoom}(n-1)$	
Minimum zoom scan volume	x, y, z	≥ 30 mm	3 – 4 GHz: ≥ 28 mm 4 – 5 GHz: ≥ 25 mm 5 – 6 GHz: ≥ 22 mm
Note: δ is the penetration depth of a plane-wave at normal incidence to the tissue medium; see draft standard IEEE P1528-2011 for details. * When zoom scan is required and the <i>reported</i> SAR from the area scan based 1-g SAR estimation procedures of KDB 447498 is ≤ 1.4 W/kg, ≤ 8 mm, ≤ 7 mm and ≤ 5 mm zoom scan resolution may be applied, respectively, for 2 GHz to 3 GHz, 3 GHz to 4 GHz and 4 GHz to 6 GHz.			

9.3 WCDMA Measurement Procedures for SAR

The following procedures are applicable to WCDMA handsets operating under 3GPP Release99, Release 5 and Release 6. The default test configuration is to measure SAR with an established radio link between the DUT and a communication test set using a 12.2kbps RMC (reference measurement channel) configured in Test Loop Mode 1. SAR is selectively confirmed for other

physical channel configurations (DPCCH & DPDCH_n), HSDPA and HSPA (HSUPA/HSDPA) modes according to output power, exposure conditions and device operating capabilities. Both uplink and downlink should be configured with the same RMC or AMR, when required. SAR for Release 5 HSDPA and Release 6 HSPA are measured using the applicable FRC (fixed reference channel) and E-DCH reference channel configurations. Maximum output power is verified according to applicable versions of 3GPP TS 34.121 and SAR must be measured according to these maximum output conditions. When Maximum Power Reduction (MPR) is not implemented according to Cubic Metric (CM) requirements for Release 6 HSPA, the following procedures do not apply.

For Release 5 HSDPA Data Devices:

Sub-test	β_c	β_d	β_d (SF)	β_c / β_d	β_{hs}	CM/dB
1	2/15	15/15	64	2/15	4/15	0.0
2	12/15	15/15	64	12/15	24/25	1.0
3	15/15	8/15	64	15/8	30/15	1.5
4	15/15	4/15	64	15/4	30/15	1.5

For Release 6 HSPA Data Devices

Sub-test	β_c	β_d	β_d (SF)	β_c / β_d	β_{hs}	β_{ec}	β_{ed}	β_{ed} (SF)	β_{ed} (codes)	CM (dB)	MPR (dB)	AG Index	E-TFCI
1	11/15	15/15	64	11/15	22/15	209/225	1039/225	4	1	1.5	0.5	20	75
2	6/15	15/15	64	6/15	12/15	12/15	12/15	4	1	2.0	1.0	12	67
3	15/15	9/15	64	15/9	30/15	30/15	$\beta_{ed1}:47/15$ $\beta_{ed2}:47/15$	4	2	2.0	1.0	15	92
4	2/15	15/15	64	2/15	4/15	4/15	56/75	4	1	1.5	0.5	17	71
5	15/15	15/15	64	15/15	24/15	30/15	134/15	4	1	1.5	0.5	21	81

Rel.8 DC-HSDPA (Cat 24)

SAR test exclusion for Rel.8 DC-HSDPA must satisfy the SAR test exclusion requirements of Rel.5 HSDPA. SAR test exclusion for DC-HSDPA devices is determined by power measurements according to the H-Set 12, Fixed Reference Channel (FRC) configuration in Table C.8.1.12 of 3GPP TS 34.121-1. A primary and a secondary serving HS-DSCH Cell are required to perform the power measurement and for the results to qualify for SAR test exclusion.

9.4 SAR Measurement for LTE

SAR tests for LTE are performed with a base station simulator, Rohde & Schwarz CMW500. Closed loop power control was used so the UE transmits with maximum output power during SAR testing. All powers were measured with the CMW 500.

It is performed for conducted power and SAR based on the KDB941225 D05.

SAR is evaluated separately according to the following procedures for the different test positions in each exposure condition – head, body, body-worn accessories and other use conditions. The procedures in the following subsections are applied separately to test each LTE frequency band.

1) QPSK with 1 RB allocation

Start with the largest channel bandwidth and measure SAR for QPSK with 1 RB allocation, using the RB offset and required test channel combination with the highest maximum output power among RB offsets at the upper edge, middle and lower edge of each required test channel. When the reported SAR is ≤ 0.8 W/kg, testing of the remaining RB offset configurations and required test channels is not required for 1 RB allocation; otherwise, SAR is required for the remaining required test channels and only for the RB offset configuration with the highest output power for that channel. When the reported SAR of a required test channel is > 1.45 W/kg, SAR is required for all three RB offset configurations for that required test channel.

2) QPSK with 50% RB allocation

The procedures required for 1 RB allocation in 1) are applied to measure the SAR for QPSK with 50% RB allocation.

3) QPSK with 100% RB allocation

For QPSK with 100% RB allocation, SAR is not required when the highest maximum output power for 100 % RB allocation is less than the highest maximum output power in 50% and 1 RB allocations and the highest reported SAR for 1 RB and 50% RB allocation in 1) and 2) are ≤ 0.8 W/kg. Otherwise, SAR is measured for the highest output power channel; and if the reported SAR is > 1.45 W/kg, the remaining required test channels must also be tested.

9.5 Bluetooth & Wi-Fi Measurement Procedures for SAR

Normal network operating configurations are not suitable for measuring the SAR of 802.11 transmitters in general. Unpredictable fluctuations in network traffic and antenna diversity conditions can introduce undesirable variations in SAR results. The SAR for these devices should be measured using chipset based test mode software to ensure that the results are consistent and reliable.

Chipset based test mode software is hardware dependent and generally varies among manufacturers. The device operating parameters established in a test mode for SAR measurements must be identical to those programmed in production units, including output power levels, amplifier gain settings and other RF performance tuning parameters. The test frequencies should correspond to actual channel frequencies defined for domestic use. SAR for devices with switched diversity should be measured with only one antenna transmitting at a time during each SAR measurement, according to a fixed modulation and data rate. The same data pattern should be used for all measurements.

In order to testing the conducted power of WLAN, the DUT is controlled to transmit WLAN TX as maximum power by the terminal software installed on the PC. The procedure how to control is presented as below:

1. Connect DUT and PC via the USB cable and check the port is opened.
2. Input the command "WLPU" to power on WLAN.
3. Input the command "WTFD" to firmware download.
4. Input the WBTX command to start transmit (i.e., WBTX=1,0,1,1500,25,0,12).
5. Input the command "WIDL" to stop transmit.
6. Input the command "WLPD" to power off WLAN.

9.6 Power Drift

To control the output power stability during the SAR test, DASY4 system calculates the power drift by measuring the E-field at the same location at the beginning and at the end of the measurement for each test position. These drift values can be found in Table 14.2 to Table 14.54 labeled as: (Power Drift [dB]). This ensures that the power drift during one measurement is within 5%.

10 Area Scan Based 1-g SAR

10.1 Requirement of KDB

According to the KDB447498 D01 v05, when the implementation is based the specific polynomial fit algorithm as presented at the 29th Bioelectromagnetics Society meeting (2007) and the estimated 1-g SAR is ≤ 1.2 W/kg, a zoom scan measurement is not required provided it is also not needed for any other purpose; for example, if the peak SAR location required for simultaneous transmission SAR test exclusion can be determined accurately by the SAR system or manually to discriminate between distinctive peaks and scattered noisy SAR distributions from area scans.

There must not be any warning or alert messages due to various measurement concerns identified by the SAR system; for example, noise in measurements, peaks too close to scan boundary, peaks are too sharp, spatial resolution and uncertainty issues etc. The SAR system verification must also demonstrate that the area scan estimated 1-g SAR is within 3% of the zoom scan 1-g SAR (See Annex B). When all the SAR results for each exposure condition in a frequency band and wireless mode are based on estimated 1-g SAR, the 1-g SAR for the highest SAR configuration must be determined by a zoom scan.

10.2 Fast SAR Algorithms

The approach is based on the area scan measurement applying a frequency dependent attenuation parameter. This attenuation parameter was empirically determined by analyzing a large number of phones. The MOTOROLA FAST SAR was developed and validated by the MOTOROLA Research Group in Ft. Lauderdale.

In the initial study, an approximation algorithm based on Linear fit was developed. The accuracy of the algorithm has been demonstrated across a broad frequency range (136-2450 MHz) and for both 1- and 10-g averaged SAR using a sample of 264 SAR measurements from 55 wireless handsets. For the sample size studied, the root-mean-squared errors of the algorithm are 1.2% and 5.8% for 1- and 10-g averaged SAR, respectively. The paper describing the algorithm in detail is expected to be published in August 2004 within the Special Issue of Transactions on MTT.

In the second step, the same research group optimized the fitting algorithm to an Polynomial fit whereby the frequency validity was extended to cover the range 30-6000MHz. Details of this study can be found in the BEMS 2007 Proceedings.

Both algorithms are implemented in DASY software.

11 Conducted Output Power

When WLAN Hotspot mode is activated (AP ON), in all operating modes, the conducted output power will be reduced for PCS1900, WCDMA1700/1900, LTE Band2/4 and WLAN-5G(high band). When WLAN Hotspot mode is deactivated (AP OFF), the RF output power level return to their normal RF power level.

11.1 Manufacturing tolerance

When the hotspot mode is ON:

Table 11.1: GPRS/EGPRS 1900

PCS 1900 GPRS/EGPRS (GMSK)				
Channel		810	661	512
1 Txslot	Target (dBm)	28	28	28
	Tune-up (dBm)	29	29	29
2 Txslots	Target (dBm)	25	25	25
	Tune-up (dBm)	26	26	26
3 Txslots	Target (dBm)	23	23	23
	Tune-up (dBm)	24	24	24
4 Txslots	Target (dBm)	22	22	22
	Tune-up (dBm)	23	23	23

Table 11.2: WCDMA

WCDMA 1700 CS			
Channel	Channel 1513	Channel 1412	Channel 1312
Target (dBm)	22.5	22.5	22.5
Tune-up (dBm)	23.5	23.5	23.5
WCDMA 1900 CS			
Channel	Channel 9538	Channel 9400	Channel 9262
Target (dBm)	19.5	19.5	19.5
Tune-up (dBm)	20.3	20.3	20.3

Table 11.3: LTE

Mode	Target (dBm)	Tune-up (dBm)
LTE Band 2	19.5	20.3
LTE Band 4	22.5	23.5

Note: When the hotspot mode is ON, MPR settings doesn't work.

Table 11.4: WLAN-5G

Mode	Target (dBm)	Tune-up (dBm)
802.11a	12	13
802.11n (MCS0~MCS4)	12	13
802.11n (MCS5~MCS6)	11.5	12.5
802.11n (MCS7)	11.5	12

When the hotspot mode is OFF:

Table 11.5: GSM Speech

GSM 850			
Channel	Channel 251	Channel 190	Channel 128
Target (dBm)	32.3	32.3	32.3
Tune-up (dBm)	33.3	33.3	33.3
GSM 1900			
Channel	Channel 810	Channel 661	Channel 512
Target (dBm)	30	30	30
Tune-up (dBm)	31	31	31

Table 11.6: GPRS and EGPRS

GSM 850 GPRS (GMSK)				
Channel		251	190	128
1 Txslot	Target (dBm)	32.3	32.3	32.3
	Tune-up (dBm)	33.3	33.3	33.3
2 Txslots	Target (dBm)	29.5	29.5	29.5
	Tune-up (dBm)	30.3	30.3	30.3
3 Txslots	Target (dBm)	28	28	28
	Tune-up (dBm)	28.8	28.8	28.8
4 Txslots	Target (dBm)	26.5	26.5	26.5
	Tune-up (dBm)	27.3	27.3	27.3
GSM 850 EGPRS (GMSK)				
Channel		251	190	128
1 Txslot	Target (dBm)	32.3	32.3	32.3
	Tune-up (dBm)	33.3	33.3	33.3
2 Txslots	Target (dBm)	29.5	29.5	29.5
	Tune-up (dBm)	30.3	30.3	30.3
3 Txslots	Target (dBm)	28	28	28
	Tune-up (dBm)	28.8	28.8	28.8
4 Txslots	Target (dBm)	26.5	26.5	26.5
	Tune-up (dBm)	27.3	27.3	27.3
GSM 1900 GPRS (GMSK)				
Channel		810	661	512
1 Txslot	Target (dBm)	30	30	30
	Tune-up (dBm)	31	31	31
2 Txslots	Target (dBm)	27	27	27
	Tune-up (dBm)	28	28	28
3 Txslots	Target (dBm)	25.5	25.5	25.5
	Tune-up (dBm)	26.5	26.5	26.5
4 Txslots	Target (dBm)	24	24	24
	Tune-up (dBm)	25	25	25

GSM 1900 EGPRS (GMSK)				
Channel		810	661	512
1 Txslot	Target (dBm)	30	30	30
	Tune-up (dBm)	31	31	31
2 Txslots	Target (dBm)	27	27	27
	Tune-up (dBm)	28	28	28
3 Txslots	Target (dBm)	25.5	25.5	25.5
	Tune-up (dBm)	26.5	26.5	26.5
4 Txslots	Target (dBm)	24	24	24
	Tune-up (dBm)	25	25	25

Table 11.7: WCDMA

WCDMA 850 CS				
Channel	Channel 4233	Channel 4182	Channel 4132	
Target (dBm)	24	24	24	
Tune-up (dBm)	25	25	25	
HSUPA (sub-test 1/5)				
Channel	Channel 4233	Channel 4182	Channel 4132	
Target (dBm)	23	23	23	
Tune-up (dBm)	24	24	24	
HSUPA (sub-test 2/3/4)				
Channel	Channel 4233	Channel 4182	Channel 4132	
Target (dBm)	22	22	22	
Tune-up (dBm)	23	23	23	
DC-HSDPA (sub-test 1/2/3/4)				
Channel	Channel 4233	Channel 4182	Channel 4132	
Target (dBm)	22	22	22	
Tune-up (dBm)	23	23	23	
WCDMA 1700 CS				
Channel	Channel 1513	Channel 1412	Channel 1312	
Target (dBm)	23	23	23	
Tune-up (dBm)	24	24	24	
HSUPA (sub-test 1/5)				
Channel	Channel 1513	Channel 1412	Channel 1312	
Target (dBm)	23.5	23.5	23.5	
Tune-up (dBm)	24.5	24.5	24.5	
HSUPA (sub-test 2/3/4)				
Channel	Channel 1513	Channel 1412	Channel 1312	
Target (dBm)	22	22	22	
Tune-up (dBm)	23	23	23	

DC-HSDPA (sub-test 1/2/3/4)			
Channel	Channel 1513	Channel 1412	Channel 1312
Target (dBm)	22	22	22
Tune-up (dBm)	23	23	23
WCDMA 1900 CS			
Channel	Channel 9538	Channel 9400	Channel 9262
Target (dBm)	21.5	21.5	21.5
Tune-up (dBm)	22.3	22.3	22.3
HSUPA (sub-test 1/5)			
Channel	Channel 9538	Channel 9400	Channel 9262
Target (dBm)	21.5	21.5	21.5
Tune-up (dBm)	22.3	22.3	22.3
HSUPA (sub-test 2/3/4)			
Channel	Channel 9538	Channel 9400	Channel 9262
Target (dBm)	20.8	20.8	20.8
Tune-up (dBm)	21.3	21.3	21.3
DC-HSDPA (sub-test 1/2/3/4)			
Channel	Channel 9538	Channel 9400	Channel 9262
Target (dBm)	20.8	20.8	20.8
Tune-up (dBm)	21.3	21.3	21.3

Table 11.8: LTE

Mode	Target (dBm)	Tune-up (dBm)
LTE Band 2	21.5	22.3
LTE Band 4	23	24
LTE Band 17	23	24

LTE MPR will follow up 3GPP setting as below:

Modulation	Channel bandwidth / Transmission bandwidth (NRB)						MPR (dB)
	1.4MHz	3.0MHz	5MHz	10MHz	15MHz	20MHz	
QPSK	≤ 5	≤ 4	≤ 8	≤ 12	≤ 16	≤ 18	0
QPSK	> 5	> 4	> 8	> 12	> 16	> 18	1
16 QAM	≤ 5	≤ 4	≤ 8	≤ 12	≤ 16	≤ 18	1
16 QAM	> 5	> 4	> 8	> 12	> 16	> 18	2

Table 11.9: Bluetooth

Bluetooth			
Channel	Channel 0	Channel 39	Channel 78
Target (dBm)	8	8	8
Tune-up (dBm)	9.5	9.5	9.5

Table 11.10: WLAN

Band	Mode	target (dBm)	Tune-up (dBm)
2.4G	802.11b	19	20
	802.11g (6Mbps~36Mbps)	17	18
	802.11g (48Mbps)	15	17
	802.11g (54Mbps)	14	16
	802.11n (MCS0~MCS4)	17	18
	802.11n (MCS5~MCS6)	14.5	16.5
	802.11n (MCS7)	13	15
5G	802.11a	15	16
	802.11n 20M (MCS0~MCS4)	15	16
	802.11n 20M (MCS5~MCS6)	14.5	15.5
	802.11n 20M (MCS7)	14.5	15
	802.11n 40M (MCS0~MCS4)	15	16
	802.11n 40M (MCS5~MCS6)	14	15.5
	802.11n 40M (MCS7)	13	15
	802.11ac 20M (MCS0~MCS4)	15	16
	802.11ac 20M (MCS5~MCS6)	14.5	15.5
	802.11ac 20M (MCS7)	14.5	15
	802.11ac 20M (MCS8)	12	13
	802.11ac 40M (MCS0~MCS4)	15	16
	802.11ac 40M (MCS5~MCS6)	14	15.5
	802.11ac 40M (MCS7)	13	15
	802.11ac 40M (MCS8)	12	13
	802.11ac 40M (MCS9)	12	12.5
	802.11ac 80M (MCS0~MCS4)	13	14
	802.11ac 80M (MCS5~MCS6)	12.5	13.5
	802.11ac 80M (MCS7)	12.5	13.5
	802.11ac 80M (MCS8)	12	13
802.11ac 80M (MCS9)	12	12.5	

11.2 Hotspot

There is power reduction for PCS1900, WCDMA1700/1900, LTE Band2/4 and WLAN-5G(high band). The power reduction is enabled when the user enables hotspot mode via the manufacturer software. The tables below show the measured powers with hotspot.

Table 11.11: The conducted power measurement results for GPRS and EGPRS

PCS1900 GPRS (GMSK)	Measured Power (dBm)			calculation	Averaged Power (dBm)		
	810	661	512		810	661	512
1 Txslot	28.72	28.70	28.78	-9.03dB	19.69	19.67	19.75
2 Txslots	25.68	25.64	25.62	-6.02dB	19.66	19.62	19.60
3Txslots	23.51	23.50	23.49	-4.26dB	19.25	19.24	19.23
4 Txslots	22.41	22.48	22.42	-3.01dB	19.40	19.47	19.41

PCS1900 EGPRS (GMSK)	Measured Power (dBm)			calculation	Averaged Power (dBm)		
	810	661	512		810	661	512
1 Txslot	28.71	28.71	28.72	-9.03dB	19.68	19.68	19.69
2 Txslots	25.69	25.67	25.63	-6.02dB	19.67	19.65	19.61
3Txslots	23.55	23.51	23.50	-4.26dB	19.29	19.25	19.24
4 Txslots	22.42	22.44	22.36	-3.01dB	19.41	19.43	19.35

NOTES:

1) Division Factors

To average the power, the division factor is as follows:

1TX-slot = 1 transmit time slot out of 8 time slots=> conducted power divided by (8/1) => -9.03dB

2TX-slots = 2 transmit time slots out of 8 time slots=> conducted power divided by (8/2) => -6.02dB

3TX-slots = 3 transmit time slots out of 8 time slots=> conducted power divided by (8/3) => -4.26dB

4TX-slots = 4 transmit time slots out of 8 time slots=> conducted power divided by (8/4) => -3.01dB

According to the conducted power as above, the body measurements are performed with 1Txslots for GPRS and EGPRS.

Note: According to the KDB941225 D03, “when SAR tests for EDGE or EGPRS mode is necessary, GMSK modulation should be used”.

Table 11.12: The conducted Power for WCDMA

Item	band	FDDIV result		
	ARFCN	1513 (1752.6MHz)	1412 (1732.4MHz)	1312 (1712.4MHz)
WCDMA	\	23.34	23.39	23.26
Item	band	FDDII result		
	ARFCN	9538 (1907.6MHz)	9400 (1880MHz)	9262 (1852.4MHz)
WCDMA	\	19.95	20.09	20.00

Table 11.13: The conducted Power for LTE

Band 2							
Bandwidth (MHz)	RB allocation	Frequency (MHz)	Max. Target Power (dBm)	QPSK		16QAM	
	RB offset (Start RB)			Actual output power (dBm)	MPR	Actual output power (dBm)	MPR
1.4 MHz	1RB High (5)	1909.3	20.3	19.37	0	19.65	0
		1880	20.3	19.65	0	19.59	0
		1850.7	20.3	19.40	0	19.44	0
	1RB Middle (3)	1909.3	20.3	19.29	0	19.61	0
		1880	20.3	19.59	0	19.57	0
		1850.7	20.3	19.29	0	19.44	0
	1RB Low (0)	1909.3	20.3	19.34	0	19.63	0
		1880	20.3	19.64	0	19.58	0
		1850.7	20.3	19.39	0	19.43	0

	3RB High (3)	1909.3	20.3	19.42	0	19.41	0	
		1880	20.3	19.52	0	19.49	0	
		1850.7	20.3	19.41	0	19.24	0	
	3RB Middle (1)	1909.3	20.3	19.37	0	19.38	0	
		1880	20.3	19.54	0	19.47	0	
		1850.7	20.3	19.42	0	19.20	0	
	3RB Low (0)	1909.3	20.3	19.36	0	19.41	0	
		1880	20.3	19.51	0	19.49	0	
		1850.7	20.3	19.39	0	19.24	0	
	6RB (0)	1909.3	20.3	19.41	0	19.29	0	
		1880	20.3	19.53	0	19.62	0	
		1850.7	20.3	19.35	0	19.45	0	
3 MHz	1RB High (14)	1908.5	20.3	19.37	0	19.47	0	
		1880	20.3	19.65	0	19.63	0	
		1851.5	20.3	19.35	0	19.36	0	
	1RB Middle (7)	1908.5	20.3	19.25	0	19.40	0	
		1880	20.3	19.63	0	19.57	0	
		1851.5	20.3	19.30	0	19.31	0	
	1RB Low (0)	1908.5	20.3	19.27	0	19.36	0	
		1880	20.3	19.68	0	19.61	0	
		1851.5	20.3	19.38	0	19.40	0	
	8RB High (7)	1908.5	20.3	19.40	0	19.34	0	
		1880	20.3	19.58	0	19.47	0	
		1851.5	20.3	19.40	0	19.37	0	
	8RB Middle (4)	1908.5	20.3	19.42	0	19.29	0	
		1880	20.3	19.55	0	19.43	0	
		1851.5	20.3	19.38	0	19.39	0	
	8RB Low (0)	1908.5	20.3	19.34	0	19.28	0	
		1880	20.3	19.56	0	19.44	0	
		1851.5	20.3	19.40	0	19.38	0	
	15RB (0)	1908.5	20.3	19.34	0	19.39	0	
		1880	20.3	19.54	0	19.50	0	
		1851.5	20.3	19.41	0	19.29	0	
	5 MHz	1RB High (24)	1907.5	20.3	19.42	0	19.54	0
			1880	20.3	19.58	0	19.07	0
			1852.5	20.3	19.30	0	19.48	0
1RB Middle (12)		1907.5	20.3	19.31	0	19.38	0	
		1880	20.3	19.50	0	19.04	0	
		1852.5	20.3	19.26	0	19.44	0	
1RB Low (0)		1907.5	20.3	19.45	0	19.54	0	
		1880	20.3	19.59	0	19.13	0	
		1852.5	20.3	19.34	0	19.45	0	

	12RB High (13)	1907.5	20.3	19.38	0	19.34	0	
		1880	20.3	19.53	0	19.70	0	
		1852.5	20.3	19.39	0	19.37	0	
	12RB Middle (6)	1907.5	20.3	19.30	0	19.27	0	
		1880	20.3	19.54	0	19.71	0	
		1852.5	20.3	19.35	0	19.36	0	
	12RB Low (0)	1907.5	20.3	19.36	0	19.30	0	
		1880	20.3	19.52	0	19.69	0	
		1852.5	20.3	19.40	0	19.31	0	
	25RB (0)	1907.5	20.3	19.31	0	19.35	0	
		1880	20.3	19.53	0	19.58	0	
		1852.5	20.3	19.35	0	19.44	0	
10 MHz	1RB High (49)	1905	20.3	19.47	0	19.48	0	
		1880	20.3	19.54	0	19.52	0	
		1855	20.3	19.29	0	19.46	0	
	1RB Middle (24)	1905	20.3	19.42	0	19.43	0	
		1880	20.3	19.41	0	19.40	0	
		1855	20.3	19.26	0	19.45	0	
	1RB Low (0)	1905	20.3	19.47	0	19.46	0	
		1880	20.3	19.50	0	19.48	0	
		1855	20.3	19.32	0	19.49	0	
	25RB High (25)	1905	20.3	19.32	0	19.27	0	
		1880	20.3	19.56	0	19.52	0	
		1855	20.3	19.44	0	19.47	0	
	25RB Middle (12)	1905	20.3	19.42	0	19.37	0	
		1880	20.3	19.52	0	19.53	0	
		1855	20.3	19.40	0	19.42	0	
	25RB Low (0)	1905	20.3	19.46	0	19.44	0	
		1880	20.3	19.53	0	19.51	0	
		1855	20.3	19.39	0	19.38	0	
	50RB (0)	1905	20.3	19.45	0	19.39	0	
		1880	20.3	19.53	0	19.56	0	
		1855	20.3	19.42	0	19.43	0	
	15 MHz	1RB High (74)	1902.5	20.3	19.26	0	19.28	0
			1880	20.3	19.56	0	19.51	0
			1857.5	20.3	19.30	0	19.10	0
1RB Middle (37)		1902.5	20.3	19.33	0	19.27	0	
		1880	20.3	19.59	0	19.55	0	
		1857.5	20.3	19.31	0	19.14	0	
1RB Low (0)		1902.5	20.3	19.27	0	19.22	0	
		1880	20.3	19.61	0	19.56	0	
		1857.5	20.3	19.40	0	19.27	0	

	36RB High (38)	1902.5	20.3	19.45	0	19.41	0	
		1880	20.3	19.55	0	19.57	0	
		1857.5	20.3	19.32	0	19.29	0	
	36RB Middle (19)	1902.5	20.3	19.44	0	19.43	0	
		1880	20.3	19.54	0	19.56	0	
		1857.5	20.3	19.43	0	19.40	0	
	36RB Low (0)	1902.5	20.3	19.42	0	19.41	0	
		1880	20.3	19.50	0	19.51	0	
		1857.5	20.3	19.42	0	19.37	0	
	75RB (0)	1902.5	20.3	19.42	0	19.41	0	
		1880	20.3	19.54	0	19.49	0	
		1857.5	20.3	19.41	0	19.40	0	
20 MHz	1RB High (99)	1900	20.3	19.96	0	19.92	0	
		1880	20.3	19.82	0	19.90	0	
		1860	20.3	19.92	0	19.93	0	
	1RB Middle (50)	1900	20.3	19.99	0	19.98	0	
		1880	20.3	19.99	0	19.97	0	
		1860	20.3	20.06	0	20.03	0	
	1RB Low (0)	1900	20.3	20.00	0	19.93	0	
		1880	20.3	19.90	0	19.92	0	
		1860	20.3	19.93	0	19.94	0	
	50RB High (50)	1900	20.3	19.93	0	19.97	0	
		1880	20.3	19.98	0	20.01	0	
		1860	20.3	19.95	0	19.96	0	
	50RB Middle (25)	1900	20.3	20.03	0	19.99	0	
		1880	20.3	20.02	0	19.98	0	
		1860	20.3	20.01	0	20.01	0	
	50RB Low (0)	1900	20.3	20.00	0	20.00	0	
		1880	20.3	20.01	0	19.97	0	
		1860	20.3	20.00	0	19.98	0	
	100RB (0)	1900	20.3	19.96	0	19.96	0	
		1880	20.3	20.03	0	20.01	0	
		1860	20.3	19.94	0	19.97	0	
	Band 4							
	Bandwidth (MHz)	RB allocation	Frequency (MHz)	Max. Target Power (dBm)	QPSK		16QAM	
		RB offset (Start RB)			Actual output power (dBm)	MPR	Actual output power (dBm)	MPR
1.4 MHz	1RB High (5)	1754.3	23.5	23.31	0	23.22	0	
		1732.5	23.5	23.15	0	23.06	0	
		1710.7	23.5	23.12	0	23.18	0	

	1RB Middle (3)	1754.3	23.5	23.24	0	23.24	0
		1732.5	23.5	23.09	0	23.03	0
		1710.7	23.5	23.06	0	23.16	0
	1RB Low (0)	1754.3	23.5	23.30	0	23.07	0
		1732.5	23.5	23.13	0	23.04	0
		1710.7	23.5	23.08	0	23.18	0
	3RB High (3)	1754.3	23.5	23.36	0	23.04	0
		1732.5	23.5	23.05	0	22.96	0
		1710.7	23.5	23.15	0	22.99	0
	3RB Middle (1)	1754.3	23.5	23.31	0	23.01	0
		1732.5	23.5	23.04	0	22.95	0
		1710.7	23.5	23.11	0	22.98	0
	3RB Low (0)	1754.3	23.5	23.32	0	23.03	0
		1732.5	23.5	23.08	0	22.94	0
		1710.7	23.5	23.12	0	23.02	0
	6RB (0)	1754.3	23.5	22.34	0	22.18	0
		1732.5	23.5	22.09	0	21.60	0
		1710.7	23.5	22.10	0	22.01	0
3 MHz	1RB High (14)	1753.5	23.5	23.27	0	23.27	0
		1732.5	23.5	22.95	0	22.81	0
		1711.5	23.5	23.03	0	22.98	0
	1RB Middle (7)	1753.5	23.5	23.27	0	23.23	0
		1732.5	23.5	22.94	0	22.86	0
		1711.5	23.5	22.97	0	22.95	0
	1RB Low (0)	1753.5	23.5	23.28	0	23.33	0
		1732.5	23.5	23.07	0	23.01	0
		1711.5	23.5	23.05	0	22.97	0
	8RB High (7)	1753.5	23.5	22.26	0	22.10	0
		1732.5	23.5	22.05	0	21.88	0
		1711.5	23.5	22.09	0	21.85	0
	8RB Middle (4)	1753.5	23.5	22.25	0	22.09	0
		1732.5	23.5	22.08	0	21.84	0
		1711.5	23.5	22.03	0	21.83	0
	8RB Low (0)	1753.5	23.5	22.36	0	22.19	0
		1732.5	23.5	22.10	0	21.82	0
		1711.5	23.5	22.07	0	21.87	0
15RB (0)	1753.5	23.5	22.31	0	22.15	0	
	1732.5	23.5	22.09	0	21.86	0	
	1711.5	23.5	22.06	0	21.89	0	
5 MHz	1RB High (24)	1752.5	23.5	23.22	0	23.43	0
		1732.5	23.5	22.91	0	22.84	0
		1712.5	23.5	23.25	0	22.65	0

	1RB Middle (12)	1752.5	23.5	23.27	0	23.40	0	
		1732.5	23.5	22.98	0	22.96	0	
		1712.5	23.5	23.07	0	22.55	0	
	1RB Low (0)	1752.5	23.5	23.28	0	23.33	0	
		1732.5	23.5	23.10	0	23.03	0	
		1712.5	23.5	23.09	0	22.58	0	
	12RB High (13)	1752.5	23.5	22.30	0	22.26	0	
		1732.5	23.5	22.00	0	21.81	0	
		1712.5	23.5	22.07	0	21.87	0	
	12RB Middle (6)	1752.5	23.5	22.29	0	22.37	0	
		1732.5	23.5	22.06	0	21.88	0	
		1712.5	23.5	22.08	0	21.89	0	
	12RB Low (0)	1752.5	23.5	22.37	0	22.36	0	
		1732.5	23.5	22.16	0	22.00	0	
		1712.5	23.5	22.03	0	21.90	0	
	25RB (0)	1752.5	23.5	22.34	0	22.22	0	
		1732.5	23.5	22.07	0	21.97	0	
		1712.5	23.5	22.03	0	22.04	0	
	10 MHz	1RB High (49)	1750	23.5	23.19	0	23.23	0
			1732.5	23.5	22.90	0	22.84	0
			1715	23.5	22.98	0	22.95	0
		1RB Middle (24)	1750	23.5	23.25	0	23.30	0
			1732.5	23.5	22.95	0	22.87	0
			1715	23.5	23.06	0	23.10	0
		1RB Low (0)	1750	23.5	23.26	0	23.26	0
			1732.5	23.5	23.05	0	23.01	0
			1715	23.5	22.99	0	23.01	0
25RB High (25)		1750	23.5	22.37	0	22.14	0	
		1732.5	23.5	21.98	0	21.83	0	
		1715	23.5	22.18	0	22.10	0	
25RB Middle (12)		1750	23.5	22.41	0	22.20	0	
		1732.5	23.5	22.10	0	21.88	0	
		1715	23.5	22.12	0	22.04	0	
25RB Low (0)		1750	23.5	22.39	0	22.27	0	
		1732.5	23.5	22.17	0	21.98	0	
		1715	23.5	22.16	0	21.97	0	
50RB (0)		1750	23.5	22.23	0	22.29	0	
		1732.5	23.5	22.08	0	21.91	0	
		1715	23.5	22.14	0	22.09	0	
15 MHz		1RB High (74)	1747.5	23.5	23.13	0	23.05	0
			1732.5	23.5	23.06	0	22.91	0
			1717.5	23.5	22.98	0	22.92	0

	1RB Middle (37)	1747.5	23.5	23.16	0	23.17	0	
		1732.5	23.5	23.03	0	22.79	0	
		1717.5	23.5	23.17	0	23.10	0	
	1RB Low (0)	1747.5	23.5	23.15	0	23.02	0	
		1732.5	23.5	23.01	0	22.74	0	
		1717.5	23.5	23.04	0	23.05	0	
	36RB High (38)	1747.5	23.5	22.46	0	22.31	0	
		1732.5	23.5	22.03	0	21.80	0	
		1717.5	23.5	22.11	0	21.98	0	
	36RB Middle (19)	1747.5	23.5	22.40	0	22.29	0	
		1732.5	23.5	22.09	0	21.86	0	
		1717.5	23.5	22.17	0	22.05	0	
	36RB Low (0)	1747.5	23.5	22.36	0	22.28	0	
		1732.5	23.5	22.20	0	22.00	0	
		1717.5	23.5	22.18	0	22.10	0	
	75RB (0)	1747.5	23.5	22.42	0	22.29	0	
		1732.5	23.5	22.12	0	22.00	0	
		1717.5	23.5	22.14	0	21.98	0	
	20 MHz	1RB High (99)	1745	23.5	22.99	0	23.24	0
			1732.5	23.5	22.97	0	22.89	0
			1720	23.5	23.04	0	22.98	0
		1RB Middle (50)	1745	23.5	22.94	0	22.86	0
			1732.5	23.5	22.94	0	22.84	0
			1720	23.5	22.87	0	22.81	0
		1RB Low (0)	1745	23.5	22.96	0	22.86	0
			1732.5	23.5	22.93	0	22.85	0
			1720	23.5	22.98	0	22.93	0
50RB High (50)		1745	23.5	21.99	0	21.87	0	
		1732.5	23.5	21.87	0	21.82	0	
		1720	23.5	21.86	0	21.84	0	
50RB Middle (25)		1745	23.5	21.92	0	21.88	0	
		1732.5	23.5	21.91	0	21.88	0	
		1720	23.5	21.86	0	21.86	0	
50RB Low (0)		1745	23.5	21.89	0	21.81	0	
		1732.5	23.5	21.89	0	21.90	0	
		1720	23.5	21.96	0	21.91	0	
100RB (0)		1745	23.5	21.96	0	21.85	0	
		1732.5	23.5	21.85	0	21.88	0	
		1720	23.5	21.84	0	21.77	0	

Table 11.14: WLAN-5G

802.11a (dBm)

Channel\data rate	6Mbps	9Mbps	12Mbps	18Mbps	24Mbps	36Mbps	48Mbps	54Mbps
149(5745 MHz)	12.30	12.82	12.60	11.31	11.29	11.14	11.39	11.17
153(5765 MHz)	12.16	11.80	11.53	11.17	11.76	11.09	11.31	11.02
157(5785 MHz)	12.66	12.35	12.14	11.72	11.41	11.50	11.00	11.13
161(5805 MHz)	12.11	11.78	11.65	11.23	11.61	11.02	11.53	11.24
165(5825 MHz)	12.46	12.15	12.01	11.58	11.21	11.29	11.82	11.67

802.11n (dBm) – 20M (5G)

Channel\data rate	MCS0	MCS1	MCS2	MCS3	MCS4	MCS5	MCS6	MCS7
149(5745 MHz)	11.91	11.52	11.98	11.64	11.04	10.65	10.77	10.59
153(5765 MHz)	12.14	11.71	11.31	11.81	11.26	11.11	10.88	10.27
157(5785 MHz)	12.12	11.71	11.23	11.66	11.18	10.98	10.84	10.22
161(5805 MHz)	11.71	11.28	11.62	11.16	11.04	10.68	10.67	10.46
165(5825 MHz)	12.44	12.03	11.58	11.17	11.40	10.94	10.66	10.40

802.11n (dBm) – 40M (5G)

Channel\data rate	MCS0	MCS1	MCS2	MCS3	MCS4	MCS5	MCS6	MCS7
151(5755 MHz)	11.99	11.13	11.41	11.65	11.27	10.81	10.66	10.01
159(5795 MHz)	11.31	11.45	11.29	11.12	11.43	10.96	10.8	10.47

11.3 GSM Measurement result

During the process of testing, the EUT was controlled via Agilent Digital Radio Communication tester (E5515C) to ensure the maximum power transmission and proper modulation. This result contains conducted output power for the EUT. In all cases, the measured peak output power should be greater and within 5% than EMI measurement.

Table 11.15: The conducted power measurement results for GSM850/1900

GSM 850MHz	Conducted Power (dBm)		
	Channel 251(848.8MHz)	Channel 190(836.6MHz)	Channel 128(824.2MHz)
	33.26	33.27	33.30
GSM 1900MHz	Conducted Power (dBm)		
	Channel 810(1909.8MHz)	Channel 661(1880MHz)	Channel 512(1850.2MHz)
	30.61	30.71	30.69

Table 11.16: The conducted power measurement results for GPRS and EGPRS

GSM 850 GPRS (GMSK)	Measured Power (dBm)			calculation	Averaged Power (dBm)		
	251	190	128		251	190	128
1 Txslot	32.79	32.86	32.91	-9.03dB	23.76	23.83	23.88
2 Txslots	30.26	30.24	30.01	-6.02dB	24.24	24.22	23.99
3Txslots	28.56	28.53	28.58	-4.26dB	24.30	24.27	24.32
4 Txslots	27.22	27.13	27.10	-3.01dB	24.21	24.12	24.09

GSM 850 EGPRS (GMSK)	Measured Power (dBm)			calculation	Averaged Power (dBm)		
	251	190	128		251	190	128
1 Txslot	32.79	32.80	32.90	-9.03dB	23.76	23.77	23.87
2 Txslots	30.05	30.20	30.04	-6.02dB	24.03	24.18	24.02
3Txslots	28.59	28.49	28.55	-4.26dB	24.33	24.23	24.29
4 Txslots	27.23	27.16	27.10	-3.01dB	24.22	24.15	24.09
PCS1900 GPRS (GMSK)	Measured Power (dBm)			calculation	Averaged Power (dBm)		
	810	661	512		810	661	512
1 Txslot	30.71	30.81	30.82	-9.03dB	21.68	21.78	21.79
2 Txslots	27.82	27.81	27.85	-6.02dB	21.80	21.79	21.83
3Txslots	25.84	25.91	25.84	-4.26dB	21.58	21.65	21.58
4 Txslots	24.87	24.86	24.90	-3.01dB	21.86	21.85	21.89
PCS1900 EGPRS (GMSK)	Measured Power (dBm)			calculation	Averaged Power (dBm)		
	810	661	512		810	661	512
1 Txslot	30.66	30.82	30.81	-9.03dB	21.63	21.79	21.78
2 Txslots	27.79	27.79	27.86	-6.02dB	21.77	21.77	21.84
3Txslots	25.83	25.92	25.82	-4.26dB	21.57	21.66	21.56
4 Txslots	24.84	24.89	24.86	-3.01dB	21.83	21.88	21.85

NOTES:

1) Division Factors

To average the power, the division factor is as follows:

1TX-slot = 1 transmit time slot out of 8 time slots=> conducted power divided by (8/1) => -9.03dB

2TX-slots = 2 transmit time slots out of 8 time slots=> conducted power divided by (8/2) => -6.02dB

3TX-slots = 3 transmit time slots out of 8 time slots=> conducted power divided by (8/3) => -4.26dB

4TX-slots = 4 transmit time slots out of 8 time slots=> conducted power divided by (8/4) => -3.01dB

According to the conducted power as above, the body measurements are performed with 3Txslots for GSM850 and 4Txslots for PCS1900.

Note: According to the KDB941225 D03, “when SAR tests for EDGE or EGPRS mode is necessary, GMSK modulation should be used”.

11.4 WCDMA Measurement result

Table 11.17: The conducted Power for WCDMA

Item	band	FDDV result		
	ARFCN	4233 (846.6MHz)	4182 (836.4MHz)	4132 (826.4MHz)
WCDMA	\	23.95	23.96	23.94
HSUPA	1	22.12	21.82	22.11
	2	21.20	21.01	20.60
	3	21.29	20.41	20.54
	4	21.74	21.66	21.69
	5	22.16	22.11	22.21

DC-HSDPA	1	22.63	22.60	22.59
	2	22.60	22.57	22.62
	3	22.66	22.62	22.57
	4	22.62	22.63	22.64
Item	band	FDDIV result		
	ARFCN	1513 (1752.6MHz)	1412 (1732.4MHz)	1312 (1712.4MHz)
WCDMA	\	23.32	23.25	23.28
HSUPA	1	22.05	22.37	22.18
	2	21.17	21.47	21.33
	3	21.18	21.45	20.68
	4	21.74	21.98	21.85
	5	22.24	22.48	22.36
DC-HSDPA	1	23.19	23.13	23.21
	2	23.25	23.17	23.17
	3	23.18	23.17	23.20
	4	23.18	23.10	23.23
Item	band	FDDII result		
	ARFCN	9538 (1907.6MHz)	9400 (1880MHz)	9262 (1852.4MHz)
WCDMA	\	22.26	22.24	22.13
HSUPA	1	19.90	20.07	20.17
	2	18.89	19.16	19.22
	3	18.16	18.28	18.61
	4	19.60	19.61	19.67
	5	20.00	20.14	20.26
DC-HSDPA	1	21.25	21.15	21.19
	2	21.13	21.15	21.17
	3	21.20	21.14	21.16
	4	21.19	21.13	21.13

Note: HSUPA&DC-HSDPA body SAR for WCDMA850/1700/1900 are not required, because maximum average output power of each RF channel with HSUPA&DC-HSDPA active is not 1/4 dB higher than that measured without HSUPA&DC-HSDPA and the maximum SAR for WCDMA850/1700/1900 are not above 75% of the SAR limit.

11.5 LTE Measurement result

Table 11.18: The conducted Power for LTE

Band 2							
Bandwidth (MHz)	RB allocation	Frequency (MHz)	Max. Target Power (dBm)	QPSK		16QAM	
	RB offset (Start RB)			Actual output power (dBm)	MPR	Actual output power (dBm)	MPR
1.4 MHz	1RB High (5)	1909.3	22.3	22.12	0	21.25	1
		1880	22.3	22.19	0	21.19	1
		1850.7	22.3	22.04	0	21.11	1

	1RB Middle (3)	1909.3	22.3	22.03	0	21.27	1	
		1880	22.3	22.10	0	21.21	1	
		1850.7	22.3	22.03	0	21.08	1	
	1RB Low (0)	1909.3	22.3	22.11	0	21.24	1	
		1880	22.3	22.17	0	21.17	1	
		1850.7	22.3	22.01	0	21.10	1	
	3RB High (3)	1909.3	22.3	22.25	0	21.13	1	
		1880	22.3	22.29	0	21.05	1	
		1850.7	22.3	22.04	0	21.07	1	
	3RB Middle (1)	1909.3	22.3	22.17	0	21.12	1	
		1880	22.3	22.18	0	21.05	1	
		1850.7	22.3	22.08	0	21.07	1	
	3RB Low (0)	1909.3	22.3	22.23	0	21.16	1	
		1880	22.3	22.23	0	21.06	1	
		1850.7	22.3	22.03	0	21.09	1	
	6RB (0)	1909.3	22.3	21.18	1	20.29	2	
		1880	22.3	21.26	1	20.26	2	
		1850.7	22.3	21.17	1	20.21	2	
	3 MHz	1RB High (14)	1908.5	22.3	22.14	0	21.15	1
			1880	22.3	22.12	0	21.21	1
			1851.5	22.3	22.04	0	21.08	1
		1RB Middle (7)	1908.5	22.3	22.12	0	21.06	1
			1880	22.3	22.08	0	21.17	1
			1851.5	22.3	22.03	0	21.04	1
		1RB Low (0)	1908.5	22.3	22.06	0	21.06	0
			1880	22.3	22.15	0	21.24	1
			1851.5	22.3	22.03	0	21.09	1
8RB High (7)		1908.5	22.3	21.06	1	20.00	2	
		1880	22.3	21.13	1	20.09	2	
		1851.5	22.3	21.01	1	20.03	2	
8RB Middle (4)		1908.5	22.3	21.02	1	19.95	2	
		1880	22.3	21.12	1	20.11	2	
		1851.5	22.3	21.05	1	20.04	2	
8RB Low (0)		1908.5	22.3	21.01	1	19.90	2	
		1880	22.3	21.10	1	20.10	2	
		1851.5	22.3	21.00	1	20.02	2	
15RB (0)		1908.5	22.3	21.05	1	20.02	2	
		1880	22.3	21.12	1	20.12	2	
		1851.5	22.3	21.04	1	20.06	2	

5 MHz	1RB High (24)	1907.5	22.3	21.57	0	20.67	1
		1880	22.3	21.53	0	20.24	1
		1852.5	22.3	21.56	0	20.77	1
	1RB Middle (12)	1907.5	22.3	21.56	0	20.59	1
		1880	22.3	21.72	0	20.24	1
		1852.5	22.3	21.44	0	20.67	1
	1RB Low (0)	1907.5	22.3	21.70	0	20.70	1
		1880	22.3	21.75	0	20.27	1
		1852.5	22.3	21.47	0	20.73	1
	12RB High (13)	1907.5	22.3	20.71	1	19.82	2
		1880	22.3	20.15	1	19.26	2
		1852.5	22.3	20.12	1	19.25	2
	12RB Middle (6)	1907.5	22.3	20.75	1	19.69	2
		1880	22.3	20.36	1	19.29	2
		1852.5	22.3	20.18	1	19.66	2
	12RB Low (0)	1907.5	22.3	20.98	1	19.04	2
		1880	22.3	20.06	1	19.18	2
		1852.5	22.3	20.22	1	19.65	2
	25RB (0)	1907.5	22.3	20.46	1	19.56	2
		1880	22.3	20.51	1	19.57	2
		1852.5	22.3	20.40	1	19.41	2
10 MHz	1RB High (49)	1905	22.3	21.58	0	20.67	1
		1880	22.3	21.69	0	20.76	1
		1855	22.3	21.51	0	20.59	1
	1RB Middle (24)	1905	22.3	21.54	0	20.66	1
		1880	22.3	21.72	0	20.68	1
		1855	22.3	21.46	0	20.47	1
	1RB Low (0)	1905	22.3	21.57	0	20.67	1
		1880	22.3	21.68	0	20.72	1
		1855	22.3	21.39	0	20.46	1
	25RB High (25)	1905	22.3	20.53	1	19.60	2
		1880	22.3	20.66	1	19.71	2
		1855	22.3	20.63	1	19.66	2
	25RB Middle (12)	1905	22.3	20.59	1	19.74	2
		1880	22.3	20.68	1	19.72	2
		1855	22.3	20.57	1	19.59	2
	25RB Low (0)	1905	22.3	20.61	1	19.74	2
		1880	22.3	20.66	1	19.72	2
		1855	22.3	20.52	1	19.59	2
	50RB (0)	1905	22.3	20.59	1	19.67	2
		1880	22.3	20.67	1	19.75	2
		1855	22.3	20.60	1	19.65	2

15 MHz	1RB High (74)	1902.5	22.3	21.59	0	20.52	1
		1880	22.3	21.63	0	20.42	1
		1857.5	22.3	21.61	0	20.61	1
	1RB Middle (37)	1902.5	22.3	21.63	0	20.55	1
		1880	22.3	21.67	0	20.46	1
		1857.5	22.3	21.62	0	20.65	1
	1RB Low (0)	1902.5	22.3	21.65	0	20.62	1
		1880	22.3	21.68	0	20.47	1
		1857.5	22.3	21.56	0	20.59	1
	36RB High (38)	1902.5	22.3	20.58	1	19.64	2
		1880	22.3	20.68	1	19.74	2
		1857.5	22.3	20.73	1	19.77	2
	36RB Middle (19)	1902.5	22.3	20.64	1	19.68	2
		1880	22.3	20.66	1	19.73	2
		1857.5	22.3	20.67	1	19.72	2
	36RB Low (0)	1902.5	22.3	20.56	1	19.63	2
		1880	22.3	20.71	1	19.75	2
		1857.5	22.3	20.63	1	19.67	2
	75RB (0)	1902.5	22.3	20.57	1	19.65	2
		1880	22.3	20.55	1	19.63	2
		1857.5	22.3	20.60	1	19.49	2
20 MHz	1RB High (99)	1900	22.3	22.00	0	21.07	1
		1880	22.3	22.05	0	21.06	1
		1860	22.3	22.08	0	21.06	1
	1RB Middle (50)	1900	22.3	21.96	0	21.05	1
		1880	22.3	22.19	0	21.14	1
		1860	22.3	22.18	0	21.20	1
	1RB Low (0)	1900	22.3	22.13	0	21.23	1
		1880	22.3	22.15	0	21.14	1
		1860	22.3	22.08	0	21.12	1
	50RB High (50)	1900	22.3	20.98	1	20.09	2
		1880	22.3	21.10	1	20.19	2
		1860	22.3	21.05	1	20.12	2
	50RB Middle (25)	1900	22.3	21.08	1	20.14	2
		1880	22.3	21.17	1	20.20	2
		1860	22.3	21.16	1	20.13	2
	50RB Low (0)	1900	22.3	21.09	1	20.28	2
		1880	22.3	21.09	1	20.19	2
		1860	22.3	21.14	1	20.24	2
	100RB (0)	1900	22.3	21.03	1	20.19	2
		1880	22.3	21.14	1	20.25	2
		1860	22.3	21.07	1	20.21	2

Band 4								
Bandwidth (MHz)	RB allocation RB offset (Start RB)	Frequency (MHz)	Max. Target Power (dBm)	QPSK		16QAM		
				Actual output power (dBm)	MPR	Actual output power (dBm)	MPR	
1.4 MHz	1RB High (5)	1754.3	24	23.44	0	22.54	1	
		1732.5	24	23.20	0	22.35	1	
		1710.7	24	23.18	0	22.22	1	
	1RB Middle (3)	1754.3	24	23.40	0	22.46	1	
		1732.5	24	23.13	0	22.37	1	
		1710.7	24	23.14	0	22.24	1	
	1RB Low (0)	1754.3	24	23.57	0	22.50	1	
		1732.5	24	23.16	0	22.39	1	
		1710.7	24	23.21	0	22.27	1	
	3RB High (3)	1754.3	24	23.46	0	22.52	1	
		1732.5	24	23.18	0	22.06	1	
		1710.7	24	23.22	0	22.09	1	
	3RB Middle (1)	1754.3	24	23.43	0	22.53	1	
		1732.5	24	23.10	0	22.01	1	
		1710.7	24	23.16	0	22.11	1	
	3RB Low (0)	1754.3	24	23.59	0	22.63	1	
		1732.5	24	23.17	0	22.04	1	
		1710.7	24	23.21	0	22.19	1	
	6RB (0)	1754.3	24	22.46	1	21.51	2	
		1732.5	24	22.23	1	21.06	2	
		1710.7	24	22.26	1	21.23	2	
	3 MHz	1RB High (14)	1753.5	24	23.59	0	22.58	1
			1732.5	24	23.05	0	22.16	1
			1711.5	24	23.29	0	22.37	1
		1RB Middle (7)	1753.5	24	23.54	0	22.61	1
			1732.5	24	23.03	0	22.19	1
			1711.5	24	23.23	0	22.34	1
1RB Low (0)		1753.5	24	23.61	0	22.76	1	
		1732.5	24	23.09	0	22.18	1	
		1711.5	24	23.17	0	22.27	1	
8RB High (7)		1753.5	24	22.60	1	21.50	2	
		1732.5	24	22.19	1	21.14	2	
		1711.5	24	22.28	1	21.19	2	
8RB Middle (4)		1753.5	24	22.55	1	21.45	2	
		1732.5	24	22.15	1	21.13	2	
		1711.5	24	22.30	1	21.12	2	
8RB Low (0)		1753.5	24	22.56	1	21.47	2	
		1732.5	24	22.14	1	21.12	2	
		1711.5	24	22.16	1	21.02	2	

	15RB (0)	1753.5	24	22.52	1	21.42	2	
		1732.5	24	22.20	1	21.08	2	
		1711.5	24	22.25	1	21.26	2	
5 MHz	1RB High (24)	1752.5	24	23.49	0	22.13	1	
		1732.5	24	23.09	0	22.36	1	
		1712.5	24	23.23	0	22.41	1	
	1RB Middle (12)	1752.5	24	23.60	0	22.26	1	
		1732.5	24	23.04	0	22.33	1	
		1712.5	24	23.09	0	22.27	1	
	1RB Low (0)	1752.5	24	23.61	0	22.21	1	
		1732.5	24	23.08	0	22.35	1	
		1712.5	24	23.08	0	22.21	1	
	12RB High (13)	1752.5	24	22.56	1	21.51	2	
		1732.5	24	22.12	1	21.10	2	
		1712.5	24	22.26	1	21.42	2	
	12RB Middle (6)	1752.5	24	22.67	1	21.58	2	
		1732.5	24	22.10	1	21.07	2	
		1712.5	24	22.22	1	21.34	2	
	12RB Low (0)	1752.5	24	22.63	1	21.57	2	
		1732.5	24	22.14	1	21.09	2	
		1712.5	24	22.17	1	21.33	2	
	25RB (0)	1752.5	24	22.69	1	21.62	2	
		1732.5	24	22.18	1	21.16	2	
		1712.5	24	22.30	1	21.34	2	
	10 MHz	1RB High (49)	1750	24	23.35	0	22.48	1
			1732.5	24	23.13	0	22.28	1
			1715	24	23.12	0	22.16	1
1RB Middle (24)		1750	24	23.49	0	22.60	1	
		1732.5	24	23.11	0	22.17	1	
		1715	24	23.23	0	22.30	1	
1RB Low (0)		1750	24	23.44	0	22.64	1	
		1732.5	24	23.06	0	22.16	1	
		1715	24	23.04	0	22.12	1	
25RB High (25)		1750	24	22.61	1	21.58	2	
		1732.5	24	22.14	1	21.13	2	
		1715	24	22.36	1	21.29	2	
25RB Middle (12)		1750	24	22.55	1	21.55	2	
		1732.5	24	22.17	1	21.07	2	
		1715	24	22.37	1	21.30	2	
25RB Low (0)		1750	24	22.56	1	21.54	2	
		1732.5	24	22.13	1	21.08	2	
		1715	24	22.29	1	21.23	2	

	50RB (0)	1750	24	22.57	1	21.59	2	
		1732.5	24	22.12	1	21.14	2	
		1715	24	22.37	1	21.34	2	
15 MHz	1RB High (74)	1747.5	24	23.55	0	22.53	1	
		1732.5	24	23.18	0	22.31	1	
		1717.5	24	23.02	0	21.87	1	
	1RB Middle (37)	1747.5	24	23.61	0	22.55	1	
		1732.5	24	23.03	0	22.08	1	
		1717.5	24	23.30	0	22.16	1	
	1RB Low (0)	1747.5	24	23.43	0	22.44	1	
		1732.5	24	23.01	0	22.05	1	
		1717.5	24	23.20	0	21.99	1	
	36RB High (38)	1747.5	24	22.66	1	21.49	2	
		1732.5	24	22.18	1	21.11	2	
		1717.5	24	22.28	1	21.25	2	
	36RB Middle (19)	1747.5	24	22.58	1	21.52	2	
		1732.5	24	22.19	1	21.12	2	
		1717.5	24	22.36	1	21.38	2	
	36RB Low (0)	1747.5	24	22.54	1	21.51	2	
		1732.5	24	22.20	1	21.10	2	
		1717.5	24	22.37	1	21.40	2	
	75RB (0)	1747.5	24	22.63	1	21.48	2	
		1732.5	24	22.20	1	21.15	2	
		1717.5	24	22.32	1	21.26	2	
	20 MHz	1RB High (99)	1745	24	23.37	0	22.46	1
			1732.5	24	23.32	0	22.29	1
			1720	24	23.25	0	22.28	1
		1RB Middle (50)	1745	24	23.26	0	22.34	1
			1732.5	24	23.33	0	22.38	1
			1720	24	23.28	0	22.32	1
1RB Low (0)		1745	24	23.26	0	22.35	1	
		1732.5	24	23.19	0	22.24	1	
		1720	24	23.22	0	22.20	1	
50RB High (50)		1745	24	22.27	1	21.29	2	
		1732.5	24	22.26	1	21.33	2	
		1720	24	22.30	1	21.32	2	
50RB Middle (25)		1745	24	22.32	1	21.31	2	
		1732.5	24	22.32	1	21.33	2	
		1720	24	22.31	1	21.30	2	
50RB Low (0)		1745	24	22.30	1	21.31	2	
		1732.5	24	22.33	1	21.33	2	
		1720	24	22.29	1	21.34	2	

	100RB (0)	1745	24	22.28	1	21.25	2	
		1732.5	24	22.25	1	21.27	2	
		1720	24	22.26	1	21.29	2	
Band 17								
Bandwidth (MHz)	RB allocation	Frequency (MHz)	Max. Target Power (dBm)	QPSK		16QAM		
	RB offset (Start RB)			Actual output power (dBm)	MPR	Actual output power (dBm)	MPR	
5 MHz	1RB High (24)	713.5	24	23.33	0	22.49	1	
		710	24	23.30	0	22.47	1	
		706.5	24	23.29	0	22.41	1	
	1RB Middle (12)	713.5	24	23.29	0	22.45	1	
		710	24	23.27	0	22.38	1	
		706.5	24	23.28	0	22.41	1	
	1RB Low (0)	713.5	24	23.23	0	22.40	1	
		710	24	23.25	0	22.38	1	
		706.5	24	23.27	0	22.35	1	
	12RB High (13)	713.5	24	22.37	1	21.37	2	
		710	24	22.35	1	21.31	2	
		706.5	24	22.34	1	21.34	2	
	12RB Middle (6)	713.5	24	22.31	1	21.37	2	
		710	24	22.36	1	21.38	2	
		706.5	24	22.37	1	21.35	2	
	12RB Low (0)	713.5	24	22.31	1	21.37	2	
		710	24	22.34	1	21.36	2	
		706.5	24	22.38	1	21.35	2	
	25RB (0)	713.5	24	22.36	1	21.40	2	
		710	24	22.34	1	21.44	2	
		706.5	24	22.37	1	21.42	2	
	10 MHz	1RB High (49)	711	24	23.33	0	22.37	1
			710	24	23.31	0	22.34	1
			709	24	23.34	0	22.31	1
1RB Middle (24)		711	24	23.24	0	22.29	1	
		710	24	23.30	0	22.31	1	
		709	24	23.33	0	22.32	1	
1RB Low (0)		711	24	23.25	0	22.33	1	
		710	24	23.31	0	22.38	1	
		709	24	23.38	0	22.36	1	
25RB High (25)		711	24	22.36	1	21.35	2	
		710	24	22.36	1	21.33	2	
		709	24	22.37	1	21.38	2	

	25RB Middle (12)	711	24	22.37	1	21.36	2
		710	24	22.34	1	21.35	2
		709	24	22.34	1	21.32	2
	25RB Low (0)	711	24	22.34	1	21.37	2
		710	24	22.39	1	21.37	2
		709	24	22.36	1	21.34	2
	50RB (0)	711	24	22.31	1	21.36	2
		710	24	22.37	1	21.38	2
		709	24	22.36	1	21.33	2

11.6 Wi-Fi and BT Measurement result

The output power of BT antenna is as following:

Mode	Conducted Power (dBm)		
	Channel 0 (2402MHz)	Channel 39 (2441MHz)	Channel 78 (2480MHz)
GFSK	9.34	8.91	9.47

The average conducted power for Wi-Fi is as following:

802.11b (dBm)

Channel\data rate	1Mbps	2Mbps	5.5Mbps	11Mbps
1	19.64	19.50	19.28	18.59
6	19.90	19.87	19.81	19.05
11	19.65	19.46	19.27	18.54

802.11g (dBm)

Channel\data rate	6Mbps	9Mbps	12Mbps	18Mbps	24Mbps	36Mbps	48Mbps	54Mbps
1	17.54	17.28	17.03	16.61	16.19	16.00	15.31	14.13
6	17.99	17.73	17.50	16.96	16.54	16.11	15.54	14.12
11	17.28	16.98	16.73	16.31	16.41	16.32	15.22	14.00

802.11n (dBm) - HT20 (2.4G)

Channel\data rate	MCS0	MCS1	MCS2	MCS3	MCS4	MCS5	MCS6	MCS7
1	17.52	17.01	16.61	16.16	16.00	14.90	14.70	14.03
6	18.00	17.56	17.10	16.61	16.02	15.05	14.87	13.50
11	17.26	16.79	16.37	16.45	16.42	14.83	14.62	13.92

802.11a (dBm)

Channel\data rate	6Mbps	9Mbps	12Mbps	18Mbps	24Mbps	36Mbps	48Mbps	54Mbps
36(5180 MHz)	15.01	14.78	14.56	14.14	14.35	14.28	14.37	14.21
40(5200 MHz)	15.18	14.92	14.73	14.23	14.30	14.09	14.12	14.47
44(5220 MHz)	15.21	14.98	14.67	14.68	14.20	14.30	14.27	14.11
48(5240 MHz)	15.36	15.15	14.94	14.51	14.08	14.35	14.42	14.24
52(5260 MHz)	15.40	15.12	14.85	14.42	14.05	14.26	14.32	14.13
56(5280 MHz)	15.33	15.05	14.78	14.71	14.91	14.35	14.33	14.14
60(5300 MHz)	15.08	14.86	14.64	14.16	14.29	14.38	14.38	14.18
64(5320 MHz)	14.91	14.64	14.45	14.02	14.06	14.16	14.15	14.44

100(5500 MHz)	15.35	15.10	14.83	14.47	14.04	14.30	14.35	14.12
104(5520 MHz)	15.46	15.19	14.98	14.52	14.10	14.51	14.01	14.32
108(5540 MHz)	15.82	15.54	15.32	14.95	14.51	15.12	14.58	14.30
112(5560 MHz)	15.30	15.05	14.82	14.38	14.01	14.61	14.09	14.38
116(5580 MHz)	15.51	15.23	15.01	14.62	14.20	14.42	14.00	14.29
120(5600 MHz)	15.48	15.22	15.00	14.54	14.11	14.75	14.17	14.01
124(5620 MHz)	14.92	14.67	14.43	14.02	14.86	14.25	14.26	14.51
128(5640 MHz)	15.62	15.33	15.04	14.67	14.30	14.76	14.17	14.38
132(5660 MHz)	15.47	15.26	15.03	14.63	14.15	14.62	14.01	14.23
136(5680 MHz)	15.40	15.10	14.91	14.45	14.07	14.50	14.36	14.17
140(5700 MHz)	14.92	14.67	14.42	14.04	14.65	14.04	14.01	14.13
149(5745 MHz)	15.37	15.14	14.93	14.49	14.02	14.49	14.29	14.11
153(5765 MHz)	15.21	14.95	14.70	14.23	14.87	14.25	14.16	14.01
157(5785 MHz)	15.52	15.28	15.03	14.61	14.18	14.48	14.00	14.12
161(5805 MHz)	15.43	15.16	14.92	14.54	14.08	14.44	14.17	14.00
165(5825 MHz)	15.35	15.11	14.86	14.41	14.08	14.22	14.03	14.29

802.11n (dBm) – 20M (5G)

Channel\data rate	MCS0	MCS1	MCS2	MCS3	MCS4	MCS5	MCS6	MCS7
36(5180 MHz)	14.58	14.08	14.03	14.01	14.00	13.83	13.65	13.48
40(5200 MHz)	14.86	14.39	14.32	14.25	14.10	13.60	14.01	13.74
44(5220 MHz)	14.90	14.38	14.00	14.01	14.39	13.88	13.63	13.42
48(5240 MHz)	15.06	14.52	14.12	14.12	14.40	13.86	13.65	13.46
52(5260 MHz)	15.02	14.54	14.09	14.37	14.34	13.87	13.60	13.44
56(5280 MHz)	15.01	14.50	14.11	14.09	14.48	13.96	13.75	13.47
60(5300 MHz)	14.40	14.28	14.21	14.43	14.42	14.00	13.84	13.54
64(5320 MHz)	14.59	14.13	14.04	14.11	14.22	13.63	14.12	13.30
100(5500 MHz)	15.01	14.50	14.12	14.46	14.35	13.87	13.61	13.42
104(5520 MHz)	15.10	14.59	14.18	14.48	14.00	14.03	13.86	13.00
108(5540 MHz)	15.44	14.95	14.54	14.17	14.59	13.51	13.97	13.01
112(5560 MHz)	14.96	14.45	14.10	14.61	14.02	13.50	13.97	13.09
116(5580 MHz)	15.49	15.03	14.62	14.23	14.55	14.02	13.87	13.05
120(5600 MHz)	15.08	14.53	14.14	14.78	14.22	13.69	13.50	13.27
124(5620 MHz)	14.93	14.45	14.01	14.87	14.33	13.82	13.63	13.42
128(5640 MHz)	14.95	14.47	14.04	14.92	14.29	13.83	13.63	13.34
132(5660 MHz)	14.83	14.30	14.00	14.74	14.20	13.64	13.50	13.27
136(5680 MHz)	14.80	14.23	14.43	14.62	14.03	13.58	13.87	13.65
140(5700 MHz)	14.99	14.48	14.00	14.66	14.13	14.08	13.87	13.66
149(5745 MHz)	14.81	14.39	14.01	14.64	14.05	13.51	13.86	13.59
153(5765 MHz)	15.27	14.72	14.26	14.80	14.39	13.81	13.57	13.39
157(5785 MHz)	15.01	14.59	14.10	14.70	14.12	13.69	13.51	13.21
161(5805 MHz)	14.91	14.38	14.01	14.63	14.00	13.91	13.74	13.08
165(5825 MHz)	15.43	14.93	14.55	14.10	14.24	13.82	13.91	13.35

802.11n (dBm) – 40M (5G)

Channel/data rate	MCS0	MCS1	MCS2	MCS3	MCS4	MCS5	MCS6	MCS7
38(5190 MHz)	14.25	14.11	14.51	14.09	14.44	13.92	13.73	13.03
46(5230 MHz)	14.37	14.33	14.28	14.51	14.26	13.81	13.55	13.34
54(5270 MHz)	14.49	14.37	14.43	14.59	14.36	13.83	13.63	13.37
62(5310 MHz)	14.58	14.26	14.33	14.34	14.11	13.67	13.51	13.31
102(5510 MHz)	14.31	14.24	14.55	14.01	14.44	13.92	13.73	13.51
110(5550 MHz)	14.76	14.01	14.16	14.41	14.18	13.68	13.89	13.22
118(5590 MHz)	14.91	14.12	14.44	14.54	14.34	13.86	13.63	13.45
126(5630 MHz)	14.21	14.59	14.58	14.05	14.37	13.81	13.57	13.37
134(5670 MHz)	14.27	14.64	14.05	14.55	14.25	13.74	13.57	13.32
151(5755 MHz)	14.37	14.14	14.13	14.13	14.09	13.58	13.96	13.22
159(5795 MHz)	14.08	14.39	14.21	14.17	14.33	13.84	13.61	13.31

802.11ac (dBm) – 20M (5G)

Channel/data rate	MCS0	MCS1	MCS2	MCS3	MCS4	MCS5	MCS6	MCS7	MCS8
36(5180 MHz)	14.58	14.08	14.03	14.01	14.00	13.83	13.65	13.48	11.67
40(5200 MHz)	14.86	14.39	14.32	14.25	14.10	13.60	14.01	13.74	11.81
44(5220 MHz)	14.90	14.38	14.00	14.01	14.39	13.88	13.63	13.42	11.38
48(5240 MHz)	15.06	14.52	14.12	14.12	14.40	13.86	13.65	13.46	11.81
52(5260 MHz)	15.02	14.54	14.09	14.37	14.34	13.87	13.60	13.44	11.33
56(5280 MHz)	15.01	14.50	14.11	14.09	14.48	13.96	13.75	13.47	11.06
60(5300 MHz)	14.40	14.28	14.21	14.43	14.42	14.00	13.84	13.54	11.33
64(5320 MHz)	14.59	14.13	14.04	14.11	14.22	13.63	14.12	13.30	11.22
100(5500 MHz)	15.01	14.50	14.12	14.46	14.35	13.87	13.61	13.42	11.05
104(5520 MHz)	15.10	14.59	14.18	14.48	14.00	14.03	13.86	13.00	11.35
108(5540 MHz)	15.44	14.95	14.54	14.17	14.59	13.51	13.97	13.01	11.93
112(5560 MHz)	14.96	14.45	14.10	14.61	14.02	13.50	13.97	13.09	11.59
116(5580 MHz)	15.49	15.03	14.62	14.23	14.55	14.02	13.87	13.05	11.89
120(5600 MHz)	15.08	14.53	14.14	14.78	14.22	13.69	13.50	13.27	11.20
124(5620 MHz)	14.93	14.45	14.01	14.87	14.33	13.82	13.63	13.42	11.46
128(5640 MHz)	14.95	14.47	14.04	14.92	14.29	13.83	13.63	13.34	11.85
132(5660 MHz)	14.83	14.30	14.00	14.74	14.20	13.64	13.50	13.27	11.19
136(5680 MHz)	14.80	14.23	14.43	14.62	14.03	13.58	13.87	13.65	11.97
140(5700 MHz)	14.99	14.48	14.00	14.66	14.13	14.08	13.87	13.66	11.99
149(5745 MHz)	14.81	14.39	14.01	14.64	14.05	13.51	13.86	13.59	11.68
153(5765 MHz)	15.27	14.72	14.26	14.80	14.39	13.81	13.57	13.39	11.73
157(5785 MHz)	15.01	14.59	14.10	14.70	14.12	13.69	13.51	13.21	11.94
161(5805 MHz)	14.91	14.38	14.01	14.63	14.00	13.91	13.74	13.08	11.74
165(5825 MHz)	15.43	14.93	14.55	14.10	14.24	13.82	13.91	13.35	11.73

802.11ac (dBm) – 40M (5G)

Channel\data rate	MCS0	MCS1	MCS2	MCS3	MCS4	MCS5	MCS6	MCS7	MCS8	MCS9
38(5190 MHz)	14.25	14.11	14.51	14.09	14.44	13.92	13.73	13.03	11.83	10.76
46(5230 MHz)	14.37	14.33	14.28	14.51	14.26	13.81	13.55	13.34	11.75	10.87
54(5270 MHz)	14.49	14.37	14.43	14.59	14.36	13.83	13.63	13.37	11.98	10.94
62(5310 MHz)	14.58	14.26	14.33	14.34	14.11	13.67	13.51	13.31	11.31	10.69
102(5510 MHz)	14.31	14.24	14.55	14.01	14.44	13.92	13.73	13.51	11.71	10.52
110(5550 MHz)	14.76	14.01	14.16	14.41	14.18	13.68	13.89	13.22	11.34	10.72
118(5590 MHz)	14.91	14.12	14.44	14.54	14.34	13.86	13.63	13.45	12.04	11.02
126(5630 MHz)	14.21	14.59	14.58	14.05	14.37	13.81	13.57	13.37	12.02	10.98
134(5670 MHz)	14.27	14.64	14.05	14.55	14.25	13.74	13.57	13.32	11.45	10.93
151(5755 MHz)	14.37	14.14	14.13	14.13	14.09	13.58	13.96	13.22	11.38	10.75
159(5795 MHz)	14.08	14.39	14.21	14.17	14.33	13.84	13.61	13.31	11.73	10.57

802.11ac (dBm) – 80M (5G)

Channel\data rate	MCS0	MCS1	MCS2	MCS3	MCS4	MCS5	MCS6	MCS7	MCS8	MCS9
42(5210 MHz)	13.09	12.65	12.33	12.05	12.28	12.77	12.61	12.57	11.96	11.15
58(5290 MHz)	13.19	12.64	12.35	12.08	12.23	12.76	12.62	12.49	11.86	11.75
106(5530 MHz)	13.36	12.86	12.55	12.31	12.00	11.88	11.65	11.74	11.05	10.88
122(5610 MHz)	13.23	12.65	12.34	12.08	12.76	12.67	12.45	12.52	11.90	11.64
155(5775 MHz)	13.67	13.14	12.87	12.57	12.19	12.08	11.98	11.93	11.09	10.53

12 Simultaneous TX SAR Considerations

12.1 Introduction

The following procedures adopted from “FCC SAR Considerations for Cell Phones with Multiple Transmitters” are applicable to handsets with built-in unlicensed transmitters such as 802.11 a/b/g and Bluetooth devices which may simultaneously transmit with the licensed transmitter.

For this device, the BT and Wi-Fi can transmit simultaneous with other transmitters.

Especially, GSM/UMTS/LTE, WLAN-5G and BT can transmit simultaneous.

12.2 Transmit Antenna Separation Distances

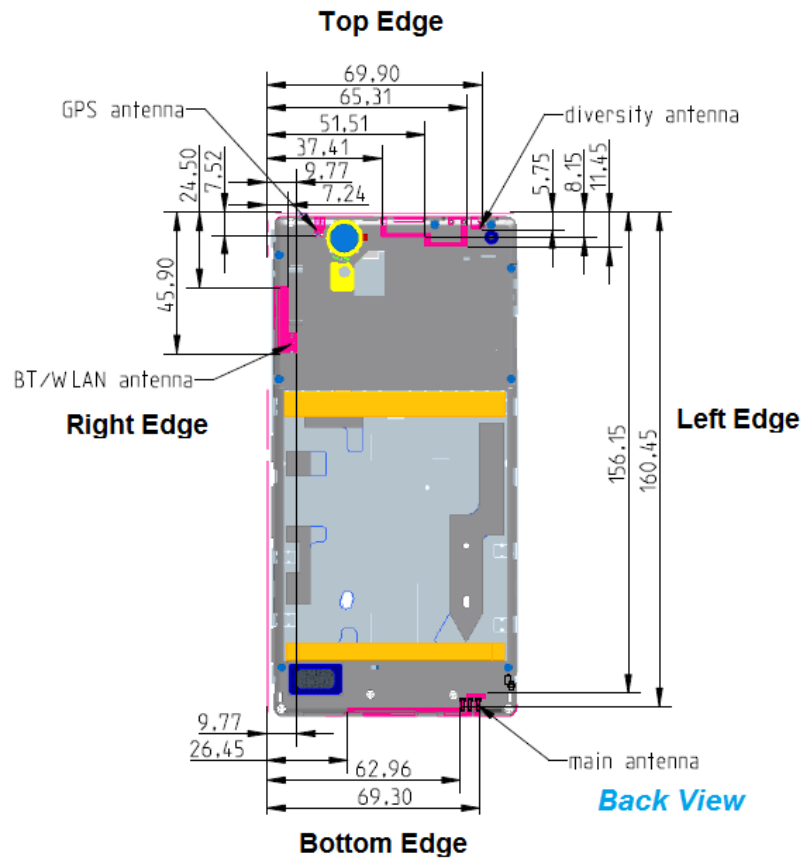

Picture 12.1 Antenna Locations

12.3 SAR Measurement Positions

According to the KDB941225 D06 Hot Spot SAR v01, the edges with less than 2.5 cm distance to the antennas need to be tested for SAR.

SAR measurement positions						
Mode	Front	Rear	Left edge	Right edge	Top edge	Bottom edge
Main antenna	Yes	Yes	Yes	No	No	Yes
WLAN	Yes	Yes	No	Yes	Yes	No

12.4 Standalone SAR Test Exclusion Considerations

Standalone 1-g head or body SAR evaluation by measurement or numerical simulation is not required when the corresponding SAR Exclusion Threshold condition, listed below, is satisfied. The 1-g SAR test exclusion threshold for 100 MHz to 6 GHz at test separation distances ≤ 50 mm are determined by:

$[(\text{max. power of channel, including tune-up tolerance, mW}) / (\text{min. test separation distance, mm})] \cdot [\sqrt{f(\text{GHz})}] \leq 3.0$ for 1-g SAR, where

- $f(\text{GHz})$ is the RF channel transmit frequency in GHz
- Power and distance are rounded to the nearest mW and mm before calculation
- The result is rounded to one decimal place for comparison

Table 12.1: Standalone SAR test exclusion considerations

Band/Mode	F(GHz)	Position	SAR test exclusion threshold (mW)	RF output power		SAR test exclusion
				dBm	mW	
Bluetooth	2.441	Head	9.60	9.47	8.85	Yes
		Body	19.20	9.47	8.85	Yes
2.4GHz WLAN 802.11 b	2.45	Head	9.58	19.90	97.72	No
		Body	19.17	19.90	97.72	No
WLAN 5GHz	5.2	Head	6.58	15.36	34.36	No
		Body	13.16	15.36	34.36	No
	5.3	Head	6.52	15.40	34.67	No
		Body	13.03	15.40	34.67	No
	5.6	Head	6.34	15.82	38.19	No
		Body	12.68	15.82	38.19	No
	5.8	Head	6.23	15.52	35.65	No
		Body	12.46	15.52	35.65	No