



Inter**Lab**[®]

FCC Measurement/Technical Report on

Bluetooth transceiver

Bluetooth Car Kit

HCB-108 / DEA-0002007

Report Reference: MDE_SE_0809_FCCa

Test Laboratory:

7 layers AG
Borsigstrasse 11
40880 Ratingen
Germany
email: info@7Layers.de



Note:

The following test results relate only to the devices specified in this document. This report shall not be reproduced in parts without the written approval of the testing laboratory.

7 layers AG
Borsigstrasse 11
40880 Ratingen, Germany
Phone: +49 (0) 2102 749 0
Fax: +49 (0) 2102 749 350
www.7Layers.com

*Aufsichtsratsvorsitzender •
Chairman of the Supervisory Board:
Markus Becker
Vorstand • Board:
Dr. Hans-Jürgen Meckelburg
René Schildknecht*

*Registergericht • registered in:
Düsseldorf, HRB 44096
USt-IdNr • VAT Nr:
DE 203159652
TAX No. 147/5869/0385*



Table of Contents

0 Summary	3
0.1 Technical Report Summary	3
0.2 Measurement Summary	4
1 Administrative Data	7
1.1 Testing Laboratory	7
1.2 Project Data	7
1.3 Applicant Data	7
1.4 Manufacturer Data	7
2 Product labelling	8
2.1 FCC ID label	8
2.2 Location of the label on the EUT	8
3 Test object Data	9
3.1 General EUT Description	9
3.2 EUT Main components	10
3.3 Ancillary Equipment	10
3.4 EUT Setups	10
3.5 Operating Modes	11
4 Test Results	12
4.1 Conducted emissions (AC power line)	12
4.2 Occupied bandwidth	14
4.3 Peak power output	17
4.4 Spurious RF conducted emissions	20
4.5 Spurious radiated emissions	24
4.6 Band edge compliance	30
4.7 Dwell time	34
4.8 Channel separation	36
4.9 Number of hopping frequencies	38
5 Test Equipment	39
6 Photo Report	42
7 Setup Drawings	47
8 Annex measurement plots	48
8.1 AC Mains conducted	48
8.2 Occupied bandwidth	49
8.3 Peak power output	58
8.4 Band edge compliance conducted and Spurious RF conducted emissions	67
8.5 Band edge compliance radiated	91
8.6 Radiated emissions (f<30MHz)	94
8.7 Spurious radiated emissions (f>30MHz)	96
8.8 Dwell time	105
8.9 Channel separation	114
8.10 Number of hopping frequencies	117



0 Summary

0.1 Technical Report Summary

Type of Authorization

Certification for an Intentional Radiator (Frequency Hopping Spread Spectrum).

Applicable FCC Rules

Prepared in accordance with the requirements of FCC Rules and Regulations as listed in 47 CFR Ch.1 Parts 2 (10-1-07 Edition) and 15 (10-1-07 Edition). The following subparts are applicable to the results in this test report.

Part 2, Subpart J - Equipment Authorization Procedures, Certification

Part 15, Subpart C – Intentional Radiators

§ 15.201 Equipment authorization requirement

§ 15.207 Conducted limits

§ 15.209 Radiated emission limits; general requirements

§ 15.247 Operation within the bands 902-928 MHz, 2400-2483.5 MHz and 5725-5850 MHz

Note:

The tests were selected and performed with reference to the FCC Public Notice DA 00-705, released March 30, 2000

Instead of applying ANSI C63.4-1992 which is referenced in the FCC Public Note, the newer ANSI C63.4-2003 is applied.

Summary Test Results:

The EUT complied with all performed tests as listed in chapter 0.2 Measurement Summary.



0.2 Measurement Summary

FCC Part 15, Subpart C § 15.207

Conducted emissions (AC power line)			2003
The measurement was performed according to ANSI C63.4			
OP-Mode	Setup	Port	Final Result
op-mode 5	Setup_c01	AC Port (power line)	passed

FCC Part 15, Subpart C § 15.247 (a) (1)

Occupied bandwidth			10-1-07
The measurement was performed according to FCC § 15.31			
OP-Mode	Setup	Port	Final Result
op-mode 1	Setup_b01	Temp ant.connector	passed
op-mode 2	Setup_b01	Temp ant.connector	passed
op-mode 3	Setup_b01	Temp ant.connector	passed
op-mode 6	Setup_b01	Temp ant.connector	passed
op-mode 7	Setup_b01	Temp ant.connector	passed
op-mode 8	Setup_b01	Temp ant.connector	passed
op-mode 10	Setup_b01	Temp ant.connector	passed
op-mode 11	Setup_b01	Temp ant.connector	passed
op-mode 12	Setup_b01	Temp ant.connector	passed

FCC Part 15, Subpart C § 15.247 (b) (1)

Peak power output			10-1-07
The measurement was performed according to FCC § 15.31			
OP-Mode	Setup	Port	Final Result
op-mode 1	Setup_b01	Temp ant.connector	passed
op-mode 2	Setup_b01	Temp ant.connector	passed
op-mode 3	Setup_b01	Temp ant.connector	passed
op-mode 6	Setup_b01	Temp ant.connector	passed
op-mode 7	Setup_b01	Temp ant.connector	passed
op-mode 8	Setup_b01	Temp ant.connector	passed
op-mode 10	Setup_b01	Temp ant.connector	passed
op-mode 11	Setup_b01	Temp ant.connector	passed
op-mode 12	Setup_b01	Temp ant.connector	passed

FCC Part 15, Subpart C § 15.247 (d)

Spurious RF conducted emissions			10-1-07
The measurement was performed according to FCC § 15.31			
OP-Mode	Setup	Port	Final Result
op-mode 1	Setup_b01	Temp ant.connector	passed
op-mode 2	Setup_b01	Temp ant.connector	passed
op-mode 3	Setup_b01	Temp ant.connector	passed
op-mode 6	Setup_b01	Temp ant.connector	passed
op-mode 7	Setup_b01	Temp ant.connector	passed
op-mode 8	Setup_b01	Temp ant.connector	passed
op-mode 10	Setup_b01	Temp ant.connector	passed
op-mode 11	Setup_b01	Temp ant.connector	passed
op-mode 12	Setup_b01	Temp ant.connector	passed



FCC Part 15, Subpart C

§ 15.247 (d), § 15.35 (b), § 15.209

Spurious radiated emissions

The measurement was performed according to ANSI C63.4

2003

OP-Mode	Setup	Port	Final Result
op-mode 1	Setup_a01	Enclosure	passed
op-mode 2	Setup_a01	Enclosure	passed
op-mode 3	Setup_a01	Enclosure	passed
op-mode 6	Setup_a01	Enclosure	passed
op-mode 7	Setup_a01	Enclosure	passed
op-mode 8	Setup_a01	Enclosure	passed
op-mode 10	Setup_a01	Enclosure	passed
op-mode 11	Setup_a01	Enclosure	passed
op-mode 12	Setup_a01	Enclosure	passed

FCC Part 15, Subpart C

§ 15.247 (d)

Band edge compliance

The measurement was performed according to FCC § 15.31
(10-1-07) / ANSI C63.4 (2003)

10-1-07 / 2003

OP-Mode	Setup	Port	Final Result
op-mode 1	Setup_b01	Temp ant.connector	passed
op-mode 3	Setup_b01	Temp ant.connector	passed
op-mode 3	Setup_a01	Enclosure	passed
op-mode 6	Setup_b01	Temp ant.connector	passed
op-mode 8	Setup_b01	Temp ant.connector	passed
op-mode 8	Setup_a01	Enclosure	passed
op-mode 10	Setup_b01	Temp ant.connector	passed
op-mode 12	Setup_b01	Temp ant.connector	passed
op-mode 12	Setup_a01	Enclosure	passed

FCC Part 15, Subpart C

§ 15.247 (a) (1) (iii)

Dwell time

The measurement was performed according to FCC § 15.31

10-1-07

OP-Mode	Setup	Port	Final Result
op-mode 2	Setup_b01	Temp ant.connector	passed
op-mode 7	Setup_b01	Temp ant.connector	passed
op-mode 11	Setup_b01	Temp ant.connector	passed

FCC Part 15, Subpart C

§ 15.247 (a) (1)

Channel separation

The measurement was performed according to FCC § 15.31

10-1-07

OP-Mode	Setup	Port	Final Result
op-mode 4	Setup_b01	Temp ant.connector	passed
op-mode 9	Setup_b01	Temp ant.connector	passed
op-mode 13	Setup_b01	Temp ant.connector	passed

FCC Part 15, Subpart C

§ 15.247 (a) (iii)

Number of hopping frequencies

The measurement was performed according to FCC § 15.31

10-1-07

OP-Mode	Setup	Port	Final Result
op-mode 4	Setup_b01	Temp ant.connector	passed



7 layers AG, Borsigstr. 11
40880 Ratingen, Germany
Phone +49 (0)2102 749 0

Responsible for
Accreditation Scope:



Responsible
for Test Report:





1 Administrative Data

1.1 Testing Laboratory

Company Name: 7 Layers AG
Address Borsigstr. 11
40880 Ratingen
Germany

This facility has been fully described in a report submitted to the FCC and accepted under the registration number 96716 .

The test facility is also accredited by the following accreditation organisation:
- Deutscher Akkreditierungs Rat DAR-Registration no. DAT-P-192/99-01

Responsible for Accreditation Scope: Dipl.-Ing. Bernhard Retka
Dipl.-Ing. Robert Machulec
Dipl.-Ing. Thomas Hoell
Dipl.-Ing. Andreas Petz

Report Template Version: 2008-08-06

1.2 Project Data

Responsible for testing and report: Dipl.-Ing. Robert Machulec
Date of Test(s): 2008-07-28 to 2008-08-13
Date of Report: 2008-08-27

1.3 Applicant Data

Company Name: Sony Ericsson Mobile Communication AB
Address: Torshamnsgatan 27
SE-164 94 Kista
Sweden
Contact Person: Mr. Lennart Skoglund

1.4 Manufacturer Data

Company Name: Sony Ericsson Mobile Communication AB
Address: Nya Vattentornet
SE-221 88 Lund
Sweden
Contact Person: Mr. Peter Lindeborg



2 Product labelling

2.1 FCC ID label

At the time of the report there was no FCC label available.

2.2 Location of the label on the EUT

see above

3 Test object Data

3.1 General EUT Description

Equipment under Test	Bluetooth transceiver
Type Designation:	HCB-108 / DEA-0002007
Kind of Device: (optional)	Bluetooth Car Kit
Voltage Type:	AC / DC (car charger) / DC (internal battery)
Voltage level:	115 V / 12 V / 3.7 V
Modulation Type:	GFSK, 8DPSK, $\pi/4$ DQPSK
FCC ID:	PY7DEA-2007

General product description:

Bluetooth is a short-range radio link intended to be a cable replacement between portable and/or fixed electronic devices.

Bluetooth operates in the unlicensed ISM Band at 2.4 GHz. In the US a band of 83.5 MHz width is available. In this band, the Bluetooth technology defines 79 RF channels spaced 1 MHz (2402 - 2480 MHz). The actual RF channel is chosen from a pseudo-random hopping sequence through the 79 channels. A channel is occupied for a defined amount of time slots, with a nominal slot length of 625 μ s. The maximum dwell time on one channel is defined by the packet type and is 0.625 ms for DH1 packets, 1.875 ms for DH3 and 3.125 ms for DH5. The nominal hop rate is 1600 hops/s for DH1, 1600/3 for DH3 and 1600/5 for DH5. All frequencies are equally used. The maximum nominal average time of occupancy is 0.4 s within a period of 79*0.4 seconds.

The basic data rate of 1 Mbps uses GFSK modulation and the enhanced data rate uses PSK modulation. For the enhanced data rate of 3 Mbps 8DPSK modulation and of 2 Mbps $\pi/4$ DQPSK modulation is used.

Specific product description for the EUT:

The EUT is a handsfree which uses Bluetooth technology to be connected to e.g. a mobile phone. The EUT is automatically switched off during charging.

The EUT provides the following ports:

Ports

Temp antenna connector
Enclosure
AC Port (AC charger)
DC Port (DC power input)
DC Port (car charger)

The main components of the EUT are listed and described in Chapter 3.2



3.2 EUT Main components

Type, S/N, Short Descriptions etc. used in this Test Report

Short Description	Equipment under Test	Type Designation	Serial No.	HW Status	SW Status	Date of Receipt
EUT A (Code: 13210b01)	Bluetooth transceiver	HCB-108 / DEA- 0002007	0029	AP1.2	BHC892_RC _20080718- 01-7657	2008-07-28
Remark: EUT A is equipped with an integral antenna (gain= -2 dBi).						
EUT B (Code: 13210c01)	Bluetooth transceiver	HCB-108 / DEA- 0002007	0010	AP1.2	BHC892_RC _20080718- 01-7657	2008-07-28
Remark: EUT B is equipped with a temporary antenna connector.						

NOTE: The short description is used to simplify the identification of the EUT in this test report.

3.3 Ancillary Equipment

For the purposes of this test report, ancillary equipment is defined as equipment which is used in conjunction with the EUT to provide operational and control features to the EUT. It is necessary to configure the system in a typical fashion, as a customer would normally use it. But nevertheless Ancillary Equipment can influence the test results.

Short Description	Equipment under Test	Type Designation	Serial no.	HW Status	SW Status	FCC ID
AE 1	Battery	BST-38 / CBA- 0002008	566860SWM ANM 08W17	-	-	-
AE2	AC Travel Charger	CST-60 / CAA- 0002002-BV	458B 06W03	R3A	-	

3.4 EUT Setups

This chapter describes the combination of EUTs and ancillary equipment used for testing.

Setup No.	Combination of EUT's	Description
Setup_a01	EUT A + AE 1	setup for radiated measurements
Setup_b01	EUT B	setup for conducted measurements
Setup_c01	EUT A + AE 2	setup for radiated measurements



3.5 Operating Modes

This chapter describes the operating modes of the EUTs used for testing.

Op. Mode	Description of Operating Modes	Remarks
op-mode 1	The EUT transmits on 2402 MHz	Loopback mode, basic data rate 1 Mbps
op-mode 2	The EUT transmits on 2441 MHz	Loopback mode, basic data rate 1 Mbps
op-mode 3	The EUT transmits on 2480 MHz	Loopback mode, basic data rate 1 Mbps
op-mode 4	The EUT is in Hopping mode	The EUT is hopping on 79 channels, basic data rate 1 Mbps
op-mode 5	Tx standby, RX on	EUT is powered and charging the internal battery. BT scan mode
op-mode 6	The EUT transmits on 2402 MHz	Loopback mode, enhanced data rate 3 Mbps
op-mode 7	The EUT transmits on 2441 MHz	Loopback mode, enhanced data rate 3 Mbps
op-mode 8	The EUT transmits on 2480 MHz	Loopback mode, enhanced data rate 3 Mbps
op-mode 9	The EUT is in Hopping mode	The EUT is hopping on 79 channels, enhanced data rate 3 Mbps
op-mode 10	The EUT transmits on 2402 MHz	Loopback mode, enhanced data rate, 2 Mbps
op-mode 11	The EUT transmits on 2441 MHz	Loopback mode, enhanced data rate, 2 Mbps
op-mode 12	The EUT transmits on 2480 MHz	Loopback mode, enhanced data rate, 2 Mbps
op-mode 13	The EUT is in Hopping mode	The EUT is hopping on 79 channels, enhanced data rate 2 Mbps



4 Test Results

4.1 Conducted emissions (AC power line)

Standard FCC Part 15, 10-1-07
Subpart C

The test was performed according to: ANSI C 63.4, 2003

4.1.1 Test Description

The test set-up was made in accordance to the general provisions of ANSI C 63.4-2003. The Equipment Under Test (EUT) was setup in a shielded room to perform the conducted emissions measurements in a typical installation configuration. The EUT was powered from 50 μ H || 50 Ohm Line Impedance Stabilization Network (LISN). The LISN's unused connections were terminated with 50 Ohm loads.

The measurement procedure consists of two steps. It is implemented into the EMI test software ES-K1 from R&S.

Step 1: Preliminary scan

Intention of this step is, to determine the conducted EMI-profile of the EUT.

EMI receiver settings:

- Detector: Peak - Maxhold
- Frequency range: 150 kHz – 30 MHz
- Frequency steps: 5 kHz
- IF-Bandwidth: 9 kHz
- Measuring time / Frequency step: 20 ms
- Measurement on phase + neutral lines of the power cords

On basis of this preliminary scan the highest amplitudes and the corresponding frequencies relative to the limit are identified. Emissions above the limit and emissions which are in the 10 dB range below the limit are considered.

Step 2: Final measurement

Intention of this step is, to determine the highest emissions with the settings defined in the test specification for the frequencies identified in step 1.

EMI receiver settings:

- Detector: Quasi-Peak
- IF - Bandwidth: 9 kHz
- Measuring time: 1 s / frequency

At each frequency determined in step 1, four measurements are performed in the following combinations:

- 1) Neutral lead - reference ground (PE grounded)
- 2) Phase lead - reference ground (PE grounded)
- 3) Neutral lead - reference ground (PE floating)
- 4) Phase lead - reference ground (PE floating)

The highest value is reported.



4.1.2 Test Requirements / Limits

FCC Part 15, Subpart C, §15.207

Frequency Range (MHz)	QP Limit (dBµV)	AV Limit (dBµV)
0.15 – 0.5	66 to 56	56 to 46
0.5 – 5	56	46
5 – 30	60	50

Used conversion factor: Limit (dBµV) = 20 log (Limit (µV)/1µV).

4.1.3 Test Protocol

Temperature: 25 °C
 Air Pressure: 1019 hPa
 Humidity: 56 %

Op. Mode	Setup	Port
op-mode 5	Setup_c01	AC Port (power line)

Power line	Frequency MHz	Measured value dBµV	Delta to limit dBµV	Remarks
N	0.24	47.50	14.6	-

Remark: Please see annex for the measurement plot.

4.1.4 Test result: Conducted emissions (AC power line)

FCC Part 15, Subpart C	Op. Mode	Result
	op-mode 5	passed



4.2 Occupied bandwidth

Standard FCC Part 15, 10-1-07
Subpart C

The test was performed according to: FCC §15.31, 10-1-07

4.2.1 Test Description

The Equipment Under Test (EUT) was setup to perform the occupied bandwidth measurements.

The reference level is the level of the highest amplitude signal observed from the transmitter at either the fundamental frequency or first-order modulation products in all typical modes of operation, including the unmodulated carrier, even if atypical.

The results recorded were measured with the modulation which produces the worst-case (widest) occupied bandwidth. The resolution bandwidth for measuring the reference level and the occupied bandwidth was 30 kHz.

The EUT was connected to the spectrum analyzer via a short coax cable.

4.2.2 Test Requirements / Limits

FCC Part 15, Subpart C, §15.247 (a) (1)

Frequency hopping systems shall have hopping channel carrier frequencies separated by a minimum of 25 kHz or the 20 dB bandwidth of the hopping channel, whichever is greater. Alternatively, frequency hopping systems operating in the 2400–2483.5 MHz band may have hopping channel carrier frequencies that are separated by 25 kHz or two-thirds of the 20 dB bandwidth of the hopping channel, whichever is greater, provided the systems operate with an output power no greater than 125 mW. The system shall hop to channel frequencies that are selected at the system hopping rate from a pseudo randomly ordered list of hopping frequencies. Each frequency must be used equally on the average by each transmitter. The system receivers shall have input bandwidths that match the hopping channel bandwidths of their corresponding transmitters and shall shift frequencies in synchronization with the transmitted signals.

Implication by the test laboratory:

Since the Bluetooth technology defines a fixed channel separation of 1 MHz this design parameter defines the maximum allowed occupied bandwidth depending on the EUT's output power:

1. Under the provision that the system's operates with an output power no greater than 125 mW (21.0 dBm):
Implicit Limit: Max. 20 dB BW = $1.0 \text{ MHz} / 2/3 = 1.5 \text{ MHz}$
2. If the system's output power exceeds 125 mW (21.0 dBm):
Implicit Limit: Max. 20 dB BW = 1.0 MHz

Used conversion factor: Output power (dBm) = $10 \log (\text{Output power (W)} / 1\text{mW})$

The measured output power of the system is below 125 mW (21.0 dBm).

For the results, please refer to the related chapter of this report.

Therefore the limit is determined as 1.5 MHz.

4.2.3 Test Protocol

Temperature: 28 °C
 Air Pressure: 1019 hPa
 Humidity: 52 %

Op. Mode	Setup	Port
op-mode 1	Setup_b01	Temp ant.connector

20 dB bandwidth MHz	Remarks
0.932	-

Remark: Please see annex for the measurement plot.

Op. Mode	Setup	Port
op-mode 2	Setup_b01	Temp ant.connector

20 dB bandwidth MHz	Remarks
0.938	-

Remark: Please see annex for the measurement plot.

Op. Mode	Setup	Port
op-mode 3	Setup_b01	Temp ant.connector

20 dB bandwidth MHz	Remarks
0.944	-

Remark: Please see annex for the measurement plot.

Op. Mode	Setup	Port
op-mode 6	Setup_b01	Temp ant.connector

20 dB bandwidth MHz	Remarks
1.300	-

Remark: Please see annex for the measurement plot.

Op. Mode	Setup	Port
op-mode 7	Setup_b01	Temp ant.connector

20 dB bandwidth MHz	Remarks
1.300	-

Remark: Please see annex for the measurement plot.



Op. Mode	Setup	Port
op-mode 8	Setup_b01	Temp ant.connector

20 dB bandwidth MHz	Remarks
1.294	-

Remark: Please see annex for the measurement plot.

Op. Mode	Setup	Port
op-mode 10	Setup_b01	Temp ant.connector

20 dB bandwidth MHz	Remarks
1.270	-

Remark: Please see annex for the measurement plot.

Op. Mode	Setup	Port
op-mode 11	Setup_b01	Temp ant.connector

20 dB bandwidth MHz	Remarks
1.294	-

Remark: Please see annex for the measurement plot.

Op. Mode	Setup	Port
op-mode 12	Setup_b01	Temp ant.connector

20 dB bandwidth MHz	Remarks
1.276	-

Remark: Please see annex for the measurement plot.

4.2.4 Test result: Occupied bandwidth

FCC Part 15, Subpart C	Op. Mode	Result
	op-mode 1	passed
	op-mode 2	passed
	op-mode 3	passed
	op-mode 6	passed
	op-mode 7	passed
	op-mode 8	passed
	op-mode 10	passed
	op-mode 11	passed
	op-mode 12	passed



4.3 Peak power output

Standard FCC Part 15, 10-1-07
 Subpart C

The test was performed according to: FCC §15.31, 10-1-07

4.3.1 Test Description

The Equipment Under Test (EUT) was set up to perform the output power measurements. The results recorded were measured with the modulation which produces the worst-case (highest) output power.

The resolution bandwidth for measuring the output power was 3 MHz.

The reference level of the spectrum analyzer was set higher than the output power of the EUT.

The EUT was connected to the spectrum analyzer via a short coax cable with a known loss.

4.3.2 Test Requirements / Limits

FCC Part 15, Subpart C, §15.247 (b) (1)

(b) The maximum peak conducted output power of the intentional radiator shall not exceed the following:

(1) For frequency hopping systems operating in the 2400-2483.5 MHz band employing at least 75 hopping channels, and all frequency hopping systems in the 5725-5850 MHz band: 1 watt.

Used conversion factor: Limit (dBm) = 10 log (Limit (W)/1mW)

==> Maximum Output Power: 30 dBm

4.3.3 Test Protocol

Temperature: 28 °C
 Air Pressure: 1019 hPa
 Humidity: 52 %

Op. Mode	Setup	Port
op-mode 1	Setup_b01	Temp.ant.connector

Output power dBm	Remarks
0.17	The EIRP including antenna gain (-2 dBi) is -1.83 dBm

Remark: Please see annex for the measurement plot.

Op. Mode	Setup	Port
op-mode 2	Setup_b01	Temp.ant.connector

Output power dBm	Remarks
0.09	The EIRP including antenna gain (-2 dBi) is -1.91 dBm

Remark: Please see annex for the measurement plot.

Op. Mode	Setup	Port
op-mode 3	Setup_b01	Temp.ant.connector

Output power dBm	Remarks
-0.26	The EIRP including antenna gain (-2 dBi) is -2.26 dBm

Remark: Please see annex for the measurement plot.

Op. Mode	Setup	Port
op-mode 6	Setup_b01	Temp.ant.connector

Output power dBm	Remarks
0.97	The EIRP including antenna gain (-2 dBi) is -1.03 dBm

Remark: Please see annex for the measurement plot.

Op. Mode	Setup	Port
op-mode 7	Setup_b01	Temp.ant.connector

Output power dBm	Remarks
0.97	The EIRP including antenna gain (-2 dBi) is -1.03 dBm

Remark: Please see annex for the measurement plot.

Op. Mode	Setup	Port
op-mode 8	Setup_b01	Temp.ant.connector

Output power dBm	Remarks
0.44	The EIRP including antenna gain (-2 dBi) is -1.56 dBm

Remark: Please see annex for the measurement plot.



Op. Mode	Setup	Port
op-mode 10	Setup_b01	Temp.ant.connector

Output power dBm	Remarks
0.89	The EIRP including antenna gain (-2 dBi) is -1.11 dBm

Remark: Please see annex for the measurement plot.

Op. Mode	Setup	Port
op-mode 11	Setup_b01	Temp.ant.connector

Output power dBm	Remarks
0.82	The EIRP including antenna gain (-2 dBi) is -1.18 dBm

Remark: Please see annex for the measurement plot.

Op. Mode	Setup	Port
op-mode 12	Setup_b01	Temp.ant.connector

Output power dBm	Remarks
0.31	The EIRP including antenna gain (-2 dBi) is -1.69 dBm

Remark: Please see annex for the measurement plot.

4.3.4 Test result: Peak power output

FCC Part 15, Subpart C	Op. Mode	Result
	op-mode 1	passed
	op-mode 2	passed
	op-mode 3	passed
	op-mode 6	passed
	op-mode 7	passed
	op-mode 8	passed
	op-mode 10	passed
	op-mode 11	passed
	op-mode 12	passed



4.4 Spurious RF conducted emissions

Standard FCC Part 15, 10-1-07
Subpart C

The test was performed according to: FCC §15.31, 10-1-07

4.4.1 Test Description

The Equipment Under Test (EUT) was set up to perform the spurious emissions measurements.

The EUT was connected to spectrum analyzer via a short coax cable with a known loss.

Analyzer settings:

- Detector: Peak-Maxhold
- Frequency range: 30 – 25000 MHz
- Resolution Bandwidth (RBW): 100 kHz
- Video Bandwidth (VBW): 300 kHz
- Sweep Time: 330 s

The reference value for the measurement of the spurious RF conducted emissions is determined during the test “band edge compliance” (cf. chapter 4.6). This value is used to calculate the 20 dBc limit.

4.4.2 Test Requirements / Limits

FCC Part 15, Subpart C, §15.247 (c)

In any 100 kHz bandwidth outside the frequency band in which the spread spectrum intentional radiator is operating, the radio frequency power that is produced by the intentional radiator shall be at least 20 dB below that in the 100 kHz bandwidth within the band that contains the highest level of the desired power.

4.4.3 Test Protocol

Temperature: 28 °C
 Air Pressure: 1019 hPa
 Humidity: 52 %

Op. Mode	Setup	Port
op-mode 1	Setup_b01	Temp ant.connector

Frequency MHz	Corrected measurement value dBm	Reference value dBm	Limit dBm	Delta to limit dB
4784	-52.76	-0.45	-20.45	32.31
9588	-58.68	-0.45	-20.45	38.23

Remark: No (further) spurious emissions in the range 20 dB below the limit found. Please see annex for the measurement plot.

Op. Mode	Setup	Port
op-mode 2	Setup_b01	Temp ant.connector

Frequency MHz	Corrected measurement value dBm	Reference value dBm	Limit dBm	Delta to limit dB
3233	-59.50	-0.44	-20.44	39.05
4884	-57.28	-0.44	-20.44	36.83
9738	-57.71	-0.44	-20.44	37.26

Remark: No (further) spurious emissions in the range 20 dB below the limit found. Please see annex for the measurement plot.

Op. Mode	Setup	Port
op-mode 3	Setup_b01	Temp ant.connector

Frequency MHz	Corrected measurement value dBm	Reference value dBm	Limit dBm	Delta to limit dB
3283	-57.94	-0.85	-20.85	37.49
4934	-59.91	-0.85	-20.85	39.46
9938	-55.20	-0.85	-20.85	34.75

Remark: No (further) spurious emissions in the range 20 dB below the limit found. Please see annex for the measurement plot.

Op. Mode	Setup	Port
op-mode 6	Setup_b01	Temp ant.connector

Frequency MHz	Corrected measurement value dBm	Reference value dBm	Limit dBm	Delta to limit dB
3183	-58.28	-0.42	-20.42	37.86
4784	-56.77	-0.42	-20.42	36.35

Remark: No (further) spurious emissions in the range 20 dB below the limit found. Please see annex for the measurement plot.

Op. Mode	Setup	Port
op-mode 7	Setup_b01	Temp ant.connector

Frequency MHz	Corrected measurement value dBm	Reference value dBm	Limit dBm	Delta to limit dB
3233	-58.19	-0.53	-20.53	37.77
4884	-61.05	-0.53	-20.53	40.63

Remark: No (further) spurious emissions in the range 20 dB below the limit found. Please see annex for the measurement plot.

Op. Mode	Setup	Port
op-mode 8	Setup_b01	Temp ant.connector

Frequency MHz	Corrected measurement value dBm	Reference value dBm	Limit dBm	Delta to limit dB
3283	-56.92	-1.04	-21.04	36.50
9938	-62.01	-1.04	-21.04	41.59

Remark: No (further) spurious emissions in the range 20 dB below the limit found. Please see annex for the measurement plot.



Op. Mode	Setup	Port
op-mode 10	Setup_b01	Temp ant.connector

Frequency MHz	Corrected measurement value dBm	Reference value dBm	Limit dBm	Delta to limit dB
3183	-58.90	-0.45	-20.45	38.45
4784	-57.18	-0.45	-20.45	36.73

Remark: No (further) spurious emissions in the range 20 dB below the limit found. Please see annex for the measurement plot.

Op. Mode	Setup	Port
op-mode 11	Setup_b01	Temp ant.connector

Frequency MHz	Corrected measurement value dBm	Reference value dBm	Limit dBm	Delta to limit dB
3233	-58.63	-0.57	-20.57	38.06
4884	-61.22	-0.57	-20.57	40.65

Remark: No (further) spurious emissions in the range 20 dB below the limit found. Please see annex for the measurement plot.

Op. Mode	Setup	Port
op-mode 12	Setup_b01	Temp ant.connector

Frequency MHz	Corrected measurement value dBm	Reference value dBm	Limit dBm	Delta to limit dB
3283	-56.65	-1.03	-21.03	35.62
9938	-60.84	-1.03	-21.03	39.81

Remark: No (further) spurious emissions in the range 20 dB below the limit found. Please see annex for the measurement plot.

4.4.4 Test result: Spurious RF conducted emissions

FCC Part 15, Subpart C	Op. Mode	Result
	op-mode 1	passed
	op-mode 2	passed
	op-mode 3	passed
	op-mode 6	passed
	op-mode 7	passed
	op-mode 8	passed
	op-mode 10	passed
	op-mode 11	passed
	op-mode 12	passed

4.5 Spurious radiated emissions

Standard FCC Part 15, 10-1-07
Subpart C

The test was performed according to: ANSI C 63.4, 2003

4.5.1 Test Description

The test set-up was made in accordance to the general provisions of ANSI C 63.4-2003. The Equipment Under Test (EUT) was set up on a non-conductive table 1.0 x 2.0 m in the semi-anechoic chamber. The test was performed at the distance of 3 m between the EUT and the receiving antenna.

The radiated emissions measurements were made in a typical installation configuration. The measurement procedure is implemented into the EMI test software ES-K1 from R&S.

1. Measurement up to 30 MHz

The test set-up was made in accordance to the general provisions of ANSI C 63.4-2003. The Equipment Under Test (EUT) was set up on a non-conductive table in the anechoic chamber.

The radiated emissions measurements were made in a typical installation configuration. The measurement procedure is implemented into the EMI test software ES-K1 from R&S. The Loop antenna HFH2-Z2 is used.

Step 1: pre measurement

- Anechoic chamber
- Antenna distance: 10m
- Detector: Peak-Maxhold
- Frequency range: 0.009 - 0.15 and 0.15 – 30 MHz
- Frequency steps: 0.1 kHz and 5 kHz
- IF-Bandwidth: 0.2 kHz and 10 kHz
- Measuring time / Frequency step: 100 ms

Intention of this step is, to determine the radiated EMI-profile of the EUT. Afterwards the relevant emissions for the final measurement are identified.

Step 2: final measurement

For the relevant emissions determined in step 1, an additional measurement with the following settings will be performed. Intention of this step is to find the maximum emission level.

- Open area test side
- Antenna distance: according to the Standard
- Detector: Quasi-Peak
- Frequency range: 0.009 – 30 MHz
- Frequency steps: measurement at frequencies detected in step 1
- IF-Bandwidth: 200 Hz - 10 kHz
- Measuring time / Frequency step: 100 ms

2. Measurement above 30 MHz and up to 1 GHz

Step 1: Preliminary scan

Preliminary test to identify the highest amplitudes relative to the limit.

Settings for step 1:

- Detector: Peak-Maxhold
- Frequency range: 30 – 1000 MHz
- Frequency steps: 60 kHz
- IF-Bandwidth: 120 kHz

- Measuring time / Frequency step: 100 μ s (BT Timing 1.25 ms)
- Turntable angle range: -180 to 180°
- Turntable step size: 90°
- Height variation range: 1 – 3m
- Height variation step size: 2m
- Polarisation: Horizontal + Vertical

Intention of this step is, to determine the radiated EMI-profile of the EUT. Afterwards the relevant emissions for the final measurement are identified.

Step 2: second measurement

For the relevant emissions determined in step 1, an additional measurement with the following settings will be performed. Intention of this step is, to find out the approximate turntable angle and antenna height for each frequency.

- Detector: Peak – Maxhold
- Measured frequencies: in step 1 determined frequencies
- IF – Bandwidth: 120 kHz
- Measuring time: 100 ms
- Turntable angle range: -180 to 180°
- Turntable step size: 45°
- Height variation range: 1 – 4m
- Height variation step size: 0.5m
- Polarisation: horizontal + vertical

After this step the EMI test system has determined the following values for each frequency (of step 1):

- Frequency
- Azimuth value (of turntable)
- Antenna height

The last two values have now the following accuracy:

- Azimuth value (of turntable): 45°
- Antenna height: 0.5m

Step 3: final measurement

In this step the accuracy of the turntable azimuth and antenna height will be improved. This is necessary to find out the maximum value of every frequency.

For each frequency, which was determined the turntable azimuth and antenna height will be adjusted. The turntable azimuth will be slowly varied by $\pm 22.5^\circ$ around this value. During this action the value of emission is continuously measured. The turntable azimuth at the highest emission will be recorded and adjusted. In this position the antenna height is also slowly varied by ± 25 cm around the antenna height determined. During this action the value of emission is also continuously measured. The antenna height of the highest emission will also be recorded and adjusted.

- Detector: Peak – Maxhold
- Measured frequencies: in step 1 determined frequencies
- IF – Bandwidth: 120 kHz
- Measuring time: 100ms
- Turntable angle range: -22.5° to $+ 22.5^\circ$ around the determined value
- Height variation range: -0.25m to $+ 0.25$ m around the determined value

Step 4: final measurement with QP detector

With the settings determined in step 3, the final measurement will be performed:

EMI receiver settings for step 4:

- Detector: Quasi-Peak (< 1 GHz)
- Measured frequencies: in step 1 determined frequencies
- IF – Bandwidth: 120 kHz
- Measuring time: 1 s



3. Measurement above 1 GHz

The following modifications apply to the measurement procedure for the frequency range above 1 GHz:

The measurement distance was reduced to 1m. The results were extrapolated by the extrapolation factor of 20 dB/decade (inverse linear distance for field strength measurements, inverse linear-distance squared for the power reference level measurements). Due to the fact that in this frequency range a double ridged wave guided horn antenna (up to 18 GHz) and a horn antenna (18-25 GHz) are used, the steps 2-4 are omitted. Step 1 was performed with one height of the receiving antenna only.

EMI receiver settings:

- Detector: Peak, Average
- RBW = VBW = 1000 kHz

After the measurement a plot will be generated which contains a diagram with the results of the preliminary scan and a chart with the frequencies and values of the results of the final measurement.

4.5.2 Test Requirements / Limits

FCC Part 15, Subpart C, §15.247 (d)

... In addition, radiated emissions which fall in the restricted bands, as defined in Section 15.205(a), must also comply with the radiated emission limits specified in Section 15.209(a) (see Section 15.205(c)).

FCC Part 15, Subpart C, §15.209, Radiated Emission Limits

Frequency in MHz	Limit (µV/m)	Measurement distance (m)	Limit(dBµV/m @10m)
0.009 – 0.49	2400/F(kHz)	300	Limit (dBµV/m)+30dB
0.49 – 1.705	24000/F(kHz)	30	Limit (dBµV/m)+10dB
1.705 - 30	30	30	Limit (dBµV/m)+10dB

Frequency in MHz	Limit (µV/m)	Measurement distance (m)	Limit (dBµV/m)
30 - 88	100	3	40.0
88 - 216	150	3	43.5
216 - 960	200	3	46.0
above 960	500	3	54.0

§15.35(b)

..., there is also a limit on the radio frequency emissions, as measured using instrumentation with a peak detector function, corresponding to 20 dB above the maximum permitted average limit....

Used conversion factor: Limit (dBµV/m) = 20 log (Limit (µV/m)/1µV/m)

4.5.3 Test Protocol

Temperature: 28 °C
 Air Pressure: 1017 hPa
 Humidity: 57 %

4.5.3.1 Measurement up to 30 MHz

Op. Mode	Setup	Port
op-mode 1	Setup_a01	Enclosure

Polarisation	Frequency MHz	Corrected value dBµV/m			Limit dBµV/m	Limit dBµV/m	Limit dBµV/m	Delta to limit dB	Delta to limit dB
		QP	Peak	AV	QP	Peak	AV	QP/Peak	AV
0°	-	-	-	-	-	-	-	-	-
90°	-	-	-	-	-	-	-	-	-

Remark: No spurious emissions in the range 20 dB below the limit found therefore step 2 was not performed.
 The peak at 99.4 kHz is emission from loop antenna power supply.

4.5.3.2 Measurement above 30 MHz

Op. Mode	Setup	Port
op-mode 1	Setup_a01	Enclosure

Polarisation	Frequency MHz	Corrected value dBµV/m			Limit dBµV/m	Limit dBµV/m	Limit dBµV/m	Delta to limit dB	Delta to limit dB
		QP	Peak	AV	QP	Peak	AV	QP/Peak	AV
Vertical + horizontal	1603		44.61	34.54		74	54	29.39	19.46
	4802		51.80	40.06		74	54	22.20	13.94

Remark: No (further) spurious emissions in the range 20 dB below the limit found.
 The measurement was performed from 30 MHz up to 25 GHz (10th harmonic).

Op. Mode	Setup	Port
op-mode 2	Setup_a01	Enclosure

Polarisation	Frequency MHz	Corrected value dBµV/m			Limit dBµV/m	Limit dBµV/m	Limit dBµV/m	Delta to limit dB	Delta to limit dB
		QP	Peak	AV	QP	Peak	AV	QP/Peak	AV
Vertical + horizontal	1603		44.90	33.21		74	54	29.10	20.79
	4882		50.88	39.04		74	54	23.12	14.96

Remark: No (further) spurious emissions in the range 20 dB below the limit found.
 The measurement was performed from 30 MHz up to 25 GHz (10th harmonic).

Op. Mode **Setup** **Port**
 op-mode 3 Setup_a01 Enclosure

Polarisation	Frequency MHz	Corrected value dB μ V/m			Limit dB μ V/m	Limit dB μ V/m	Limit dB μ V/m	Delta to limit dB	Delta to limit dB
		QP	Peak	AV	QP	Peak	AV	QP/Peak	AV
Vertical + horizontal	1603		44.75	33.29		74	54	29.25	20.71
	4960		51.79	40.15		74	54	22.21	13.85

Remark: No (further) spurious emissions in the range 20 dB below the limit found.
 The measurement was performed from 30 MHz up to 25 GHz (10th harmonic).

Op. Mode **Setup** **Port**
 op-mode 6 Setup_a01 Enclosure

Polarisation	Frequency MHz	Corrected value dB μ V/m			Limit dB μ V/m	Limit dB μ V/m	Limit dB μ V/m	Delta to limit dB	Delta to limit dB
		QP	Peak	AV	QP	Peak	AV	QP/Peak	AV
Vertical + horizontal	1610		45.58	35.10		74	54	28.42	18.90
	4804		47.63	34.06		74	54	26.37	19.94

Remark: No (further) spurious emissions in the range 20 dB below the limit found.
 The measurement was performed from 1 GHz up to 18 GHz because no relevant spurious emissions were found outside this frequency range in op-mode 1, 2 and 3.

Op. Mode **Setup** **Port**
 op-mode 7 Setup_a01 Enclosure

Polarisation	Frequency MHz	Corrected value dB μ V/m			Limit dB μ V/m	Limit dB μ V/m	Limit dB μ V/m	Delta to limit dB	Delta to limit dB
		QP	Peak	AV	QP	Peak	AV	QP/Peak	AV
Vertical + horizontal	1566		45.13	31.24		74	54	28.87	22.76
	4882		48.11	34.90		74	54	25.89	19.10

Remark: No (further) spurious emissions in the range 20 dB below the limit found.
 The measurement was performed from 1 GHz up to 18 GHz because no relevant spurious emissions were found outside this frequency range in op-mode 1, 2 and 3.

Op. Mode **Setup** **Port**
 op-mode 8 Setup_a01 Enclosure

Polarisation	Frequency MHz	Corrected value dB μ V/m			Limit dB μ V/m	Limit dB μ V/m	Limit dB μ V/m	Delta to limit dB	Delta to limit dB
		QP	Peak	AV	QP	Peak	AV	QP/Peak	AV
Vertical + horizontal	1603		44.63	34.41		74	54	29.37	19.59
	4960		48.90	35.80		74	54	25.10	18.20

Remark: No (further) spurious emissions in the range 20 dB below the limit found.
 The measurement was performed from 1 GHz up to 18 GHz because no relevant spurious emissions were found outside this frequency range in op-mode 1, 2 and 3.

Op. Mode **Setup** **Port**
op-mode 10 Setup_a01 Enclosure

Polarisation	Frequency MHz	Corrected value dBµV/m			Limit dBµV/m	Limit dBµV/m	Limit dBµV/m	Delta to limit dB	Delta to limit dB
		QP	Peak	AV	QP	Peak	AV	QP/Peak	AV
Vertical + horizontal	1601		45.30	34.66		74	54	28.70	19.34
	4804		47.75	33.80		74	54	26.25	20.20

Remark: No (further) spurious emissions in the range 20 dB below the limit found.
The measurement was performed from 1 GHz up to 18 GHz because no relevant spurious emissions were found outside this frequency range in op-mode 1, 2 and 3.

Op. Mode **Setup** **Port**
op-mode 11 Setup_a01 Enclosure

Polarisation	Frequency MHz	Corrected value dBµV/m			Limit dBµV/m	Limit dBµV/m	Limit dBµV/m	Delta to limit dB	Delta to limit dB
		QP	Peak	AV	QP	Peak	AV	QP/Peak	AV
Vertical + horizontal	2880		51.22	36.39		74	54	22.78	17.61
	4882		47.86	35.00		74	54	26.14	19.00

Remark: No (further) spurious emissions in the range 20 dB below the limit found.
The measurement was performed from 1 GHz up to 18 GHz because no relevant spurious emissions were found outside this frequency range in op-mode 1, 2 and 3.

Op. Mode **Setup** **Port**
op-mode 12 Setup_a01 Enclosure

Polarisation	Frequency MHz	Corrected value dBµV/m			Limit dBµV/m	Limit dBµV/m	Limit dBµV/m	Delta to limit dB	Delta to limit dB
		QP	Peak	AV	QP	Peak	AV	QP/Peak	AV
Vertical + horizontal	1603		46.34	34.41		74	54	27.66	19.59
	4960		49.04	33.95		74	54	24.96	20.05

Remark: No (further) spurious emissions in the range 20 dB below the limit found.
The measurement was performed from 1 GHz up to 18 GHz because no relevant spurious emissions were found outside this frequency range in op-mode 1, 2 and 3.

4.5.4 Test result: Spurious radiated emissions

FCC Part 15, Subpart C	Op. Mode	Result
	op-mode 1	passed
	op-mode 2	passed
	op-mode 3	passed
	op-mode 6	passed
	op-mode 7	passed
	op-mode 8	passed
	op-mode 10	passed
	op-mode 11	passed
	op-mode 12	passed

4.6 Band edge compliance

Standard FCC Part 15, 10-1-07
Subpart C

The test was performed according to: ANSI C 63.4, 2003
FCC §15.31, 10-1-07

4.6.1 Test Description

The procedure to show compliance with the band edge requirement is divided into two measurements: 1. Show compliance of the lower band edge by a conducted measurement and 2. show compliance of the higher band edge by a radiated and conducted measurement.

For the first measurement the EUT is set to transmit on the lowest channel (2402 MHz). The lower band edge is 2400 MHz.

Analyzer settings:

- Detector: Peak
- RBW= 100 kHz
- VBW= 300 kHz

For the second measurement the EUT is set to transmit on the highest channel (2480 MHz). The higher band edge is 2483.5 MHz.

Analyzer settings for conducted measurement:

- Detector: Peak
- RBW= 100 kHz
- VBW= 300 kHz

Analyzer settings for radiated measurement:

- Detector: Peak, Average
- RBW = VBW = 100 kHz

For the third measurement the EUT is set to transmit in hopping mode. The lower band edge is 2400 MHz. The higher band edge is 2483.5 MHz.

Analyzer settings for conducted measurement:

- Detector: Peak
- RBW= 100 kHz
- VBW= 300 kHz

4.6.2 Test Requirements / Limits

FCC Part 15.247 (d)

"In any 100 kHz bandwidth outside the frequency band in which the spread spectrum or digitally modulated intentional radiator is operating, the radio frequency power that is produced by the intentional radiator shall be at least 20 dB below that in the 100 kHz bandwidth within the band that contains the highest level of the desired power, based on either an RF conducted or a radiated measurement, provided the transmitter demonstrates compliance with the peak conducted power limits.

...

Attenuation below the general limits specified in Section 15.209(a) is not required. In addition, radiated emissions which fall in the restricted bands, as defined in Section 15.205(a), must also comply with the radiated emission limits specified in Section 15.209(a) (see Section 15.205(c))."

For the measurement of the **lower band edge** the RF power at the band edge shall be "at least 20 dB below that in the 100 kHz bandwidth within the band that contains the highest level of the desired power..."

For the measurement of the **higher band edge** the limit is "specified in Section 15.209(a)".

4.6.3 Test Protocol

4.6.3.1 Lower band edge

Conducted measurement

Temperature: 28 °C
 Air Pressure: 1019 hPa
 Humidity: 52 %

Op. Mode	Setup	Port
op-mode 1	Setup_b01	Temp ant.connector

Frequency MHz	Measured value dBm	Reference value dBm	Limit dBm	Delta to limit dB
2400.00	-40.44	-0.45	-20.45	19.99

Remark: Please see annex for the measurement plot.

Op. Mode	Setup	Port
op-mode 6	Setup_b01	Temp ant.connector

Frequency MHz	Measured value dBm	Reference value dBm	Limit dBm	Delta to limit dB
2400.00	-46.31	-0.42	-20.42	25.89

Remark: Please see annex for the measurement plot.

Op. Mode	Setup	Port
op-mode 10	Setup_b01	Temp ant.connector

Frequency MHz	Measured value dBm	Reference value dBm	Limit dBm	Delta to limit dB
2400.00	-46.46	-0.45	-20.45	26.01

Remark: Please see annex for the measurement plot.

Op. Mode	Setup	Port
op-mode 4	Setup_b01	Temp ant.connector

Frequency MHz	Measured value dBm	Reference value dBm	Limit dBm	Delta to limit dB
2400.00	-38.99	-0.33	-20.33	18.66

Remark: Please see annex for the measurement plot.

Op. Mode	Setup	Port
op-mode 9	Setup_b01	Temp ant.connector

Frequency MHz	Measured value dBm	Reference value dBm	Limit dBm	Delta to limit dB
2400.00	-44.90	-0.41	-20.41	24.49

Remark: Please see annex for the measurement plot.

Op. Mode	Setup	Port
op-mode 13	Setup_b01	Temp ant.connector

Frequency MHz	Measured value dBm	Reference value dBm	Limit dBm	Delta to limit dB
2400.00	-47.09	-0.42	-20.42	26.67

Remark: Please see annex for the measurement plot.

4.6.3.2 Higher band edge

Conducted measurement

Temperature: 28 °C
 Air Pressure: 1019 hPa
 Humidity: 52 %

Op. Mode	Setup	Port
op-mode 3	Setup_b01	Temp ant.connector

Frequency MHz	Measured value dBm	Reference value dBm	Limit dBm	Delta to limit dB
2483.50	-59.50	-0.85	-20.85	38.65

Remark: Please see annex for the measurement plot.

Op. Mode	Setup	Port
op-mode 8	Setup_b01	Temp ant.connector

Frequency MHz	Measured value dBm	Reference value dBm	Limit dBm	Delta to limit dB
2483.50	-54.80	-1.04	-21.04	33.76

Remark: Please see annex for the measurement plot.

Op. Mode	Setup	Port
op-mode 12	Setup_b01	Temp ant.connector

Frequency MHz	Measured value dBm	Reference value dBm	Limit dBm	Delta to limit dB
2483.50	-54.87	-1.03	-21.03	33.84

Remark: Please see annex for the measurement plot.

Op. Mode	Setup	Port
op-mode 4	Setup_b01	Temp ant.connector

Frequency MHz	Measured value dBm	Reference value dBm	Limit dBm	Delta to limit dB
2483.50	-61.31	-0.86	-20.86	40.21

Remark: Please see annex for the measurement plot.

Op. Mode	Setup	Port
op-mode 9	Setup_b01	Temp ant.connector

Frequency MHz	Measured value dBm	Reference value dBm	Limit dBm	Delta to limit dB
2483.50	-54.93	-1.10	-21.10	33.83

Remark: Please see annex for the measurement plot.

Op. Mode	Setup	Port
op-mode 13	Setup_b01	Temp ant.connector

Frequency MHz	Measured value dBm	Reference value dBm	Limit dBm	Delta to limit dB
2483.50	-55.75	-1.11	-21.11	34.64

Remark: Please see annex for the measurement plot.

Radiated measurement

Temperature: 28 °C
 Air Pressure: 1017 hPa
 Humidity: 57 %

Op. Mode	Setup	Port
op-mode 3	Setup_a01	Enclosure

Frequency MHz	Polarisation	Corrected value dBµV/m		Limit Peak dBµV/m	Limit AV dBµV/m	Delta to Peak limit/dB	Delta to AV limit dB
		Peak	AV				
2483.50	Vertical + horizontal	47.19	34.90	74.00	54.00	26.81	19.10

Remark: Please see annex for the measurement plot.

Op. Mode	Setup	Port
op-mode 8	Setup_a01	Enclosure

Frequency MHz	Polarisation	Corrected value dBµV/m		Limit Peak dBµV/m	Limit AV dBµV/m	Delta to Peak limit/dB	Delta to AV limit dB
		Peak	AV				
2483.50	Vertical + horizontal	47.58	35.30	74.00	54.00	26.42	18.70

Remark: Please see annex for the measurement plot.

Op. Mode	Setup	Port
op-mode 12	Setup_a01	Enclosure

Frequency MHz	Polarisation	Corrected value dBµV/m		Limit Peak dBµV/m	Limit AV dBµV/m	Delta to Peak limit/dB	Delta to AV limit dB
		Peak	AV				
2483.50	Vertical + horizontal	47.31	35.29	74.00	54.00	26.69	18.71

Remark: Please see annex for the measurement plot.

4.6.4 Test result: Band edge compliance

FCC Part 15, Subpart C	Op. Mode	Result
	op-mode 1	passed
	op-mode 3	passed
	op-mode 6	passed
	op-mode 8	passed
	op-mode 10	passed
	op-mode 12	passed



4.7 Dwell time

Standard FCC Part 15, 10-1-07
Subpart C

The test was performed according to: FCC §15.31, 10-1-07

4.7.1 Test Description

The Equipment Under Test (EUT) was set up to perform the dwell time measurements. The EUT was connected to the spectrum analyzer via a short coax cable. The time slot length is measured for three different packet length which are available in the Bluetooth technology. Those are DH1, DH3 and DH5 packets. The dwell time is calculated by:

Dwell time = time slot length * hop rate / number of hopping channels * 31.6 s

with:

- hop rate=1600 * 1/s for DH1 packets = 1600 s⁻¹
- hop rate=1600/3 * 1/s for DH3 packets = 533.33 s⁻¹
- hop rate=1600/5 * 1/s for DH5 packets = 320 s⁻¹
- number of hopping channels = 79
- 31.6 s = 0.4 seconds multiplied by the number of hopping channels = 0.4 s * 79

The following shortcuts are used for the different packet types:

- Basic data rate, 1 Mbps: DH1, DH3, DH5
- Enhanced data rate, 3 Mbps: 3-DH1, 3-DH3, 3-DH5
- Enhanced data rate, 2 Mbps: 2-DH1, 2-DH3, 2-DH5

4.7.2 Test Requirements / Limits

FCC Part 15, Subpart C, §15.247 (a) (1) (iii)

Frequency hopping systems in the 2400-2483.5 MHz band shall use at least 15 channels. The average time of occupancy on any channel shall not be greater than 0.4 seconds within a period of 0.4 seconds multiplied by the number of hopping channels employed.

Since the Bluetooth technology uses 79 channels this period is calculated to be 31.6 seconds.



4.7.3 Test Protocol

Temperature: 28 °C
 Air Pressure: 1019 hPa
 Humidity: 52 %

Op. Mode	Setup	Port
op-mode 2	Setup_b01	Temp ant.connector

Packet type	Time slot length ms	Dwell time	Dwell time ms
DH1	0.421	time slot length * 1600 /79 * 31.6	269
DH3	1.683	time slot length * 1600/3 /79 * 31.6	359
DH5	2.926	time slot length * 1600/5 /79 * 31.6	375

Remark: Please see annex for the measurement plots.

Op. Mode	Setup	Port
op-mode 7	Setup_b01	Temp ant.connector

Packet type	Time slot length ms	Dwell time	Dwell time ms
3-DH1	0.421	time slot length * 1600 /79 * 31.6	269
3-DH3	1.683	time slot length * 1600/3 /79 * 31.6	359
3-DH5	2.946	time slot length * 1600/5 /79 * 31.6	377

Remark: Please see annex for the measurement plots.

Op. Mode	Setup	Port
op-mode 11	Setup_b01	Temp ant.connector

Packet type	Time slot length ms	Dwell time	Dwell time ms
2-DH1	0.421	time slot length * 1600 /79 * 31.6	269
2-DH3	1.683	time slot length * 1600/3 /79 * 31.6	359
2-DH5	2.926	time slot length * 1600/5 /79 * 31.6	375

Remark: Please see annex for the measurement plots.

4.7.4 Test result: Dwell time

FCC Part 15, Subpart C	Op. Mode	Result
	op-mode 2 DH1	passed
	op-mode 2 DH3	passed
	op-mode 2 DH5	passed
	op-mode 7 3-DH1	passed
	op-mode 7 3-DH3	passed
	op-mode 7 3-DH5	passed
	op-mode 11 2-DH1	passed
	op-mode 11 2-DH3	passed
	op-mode 11 2-DH5	passed



4.8 Channel separation

Standard FCC Part 15, 10-1-07
Subpart C

The test was performed according to: FCC §15.31, 10-1-07

4.8.1 Test Description

The Equipment Under Test (EUT) was set up to perform the channel separation measurements.

The EUT was connected to spectrum analyzer via a short coax cable.

Analyzer settings:

- Detector: Peak-Maxhold
- Span: 3 MHz
- Centre Frequency: 2441 MHz
- Resolution Bandwidth (RBW): 30 kHz
- Video Bandwidth (VBW): 100 kHz
- Sweep Time: Coupled

4.8.2 Test Requirements / Limits

FCC Part 15, Subpart C, §15.247 (a) (1)

Frequency hopping systems shall have hopping channel carrier frequencies separated by a minimum of 25 kHz or the 20 dB bandwidth of the hopping channel, whichever is greater. Alternatively, frequency hopping systems operating in the 2400–2483.5 MHz band may have hopping channel carrier frequencies that are separated by 25 kHz or two-thirds of the 20 dB bandwidth of the hopping channel, whichever is greater, provided the systems operate with an output power no greater than 125 mW. The system shall hop to channel frequencies that are selected at the system hopping rate from a pseudo randomly ordered list of hopping frequencies. Each frequency must be used equally on the average by each transmitter. The system receivers shall have input bandwidths that match the hopping channel bandwidths of their corresponding transmitters and shall shift frequencies in synchronization with the transmitted signals.



4.8.3 Test Protocol

Temperature: 28 °C
 Air Pressure: 1019 hPa
 Humidity: 52 %

Op. Mode	Setup	Port
op-mode 4	Setup_b01	Temp ant.connector

Channel separation MHz	Remarks
1.000	-

Remark: Please see annex for the measurement plot.

Op. Mode	Setup	Port
op-mode 9	Setup_b01	Temp ant.connector

Channel separation MHz	Remarks
1.000	-

Remark: Please see annex for the measurement plot.

Op. Mode	Setup	Port
op-mode 13	Setup_b01	Temp ant.connector

Channel separation MHz	Remarks
1.000	-

Remark: Please see annex for the measurement plot.

4.8.4 Test result: Channel separation

FCC Part 15, Subpart C	Op. Mode	Result
	op-mode 4	passed
	op-mode 9	passed
	op-mode 13	passed

4.9 Number of hopping frequencies

Standard FCC Part 15, 10-1-07
Subpart C

The test was performed according to: FCC §15.31, 10-1-07

4.9.1 Test Description

The Equipment Under Test (EUT) was set up to perform the number of hopping frequencies measurement.

The EUT was connected to spectrum analyzer via a short coax cable.

Analyzer settings:

- Detector: Peak-Maxhold
- Start frequency: 2402 MHz
- Stop frequency: 2483.5 MHz
- Resolution Bandwidth (RBW): 30 kHz
- Video Bandwidth (VBW): 30 kHz
- Sweep Time: Coupled

4.9.2 Test Requirements / Limits

FCC Part 15, Subpart C, §15.247 (a) (iii)

Frequency hopping systems in the 2400-2483.5 MHz band shall use at least 15 channels.

4.9.3 Test Protocol

Temperature: 28 °C
Air Pressure: 1019 hPa
Humidity: 52 %

Op. Mode	Setup	Port
op-mode 4	Setup_b01	Temp ant.connector

Number of hopping channels	Remarks
79	-

Remark: Please see annex for the measurement plot.

4.9.4 Test result: Number of hopping frequencies

FCC Part 15, Subpart C	Op. Mode	Result
	op-mode 4	passed

5 Test Equipment

EUT Digital Signalling System

Equipment	Type	Serial No.	Manufacturer	Cal data	Next cal
Digital Radio Communication Tester	CMD 55	831050/020	Rohde & Schwarz	01.12.05	01.12.08
Signalling Unit for Bluetooth	PTW60	100004	Rohde & Schwarz	-	-
Universal Radio Communication Tester	CMU200	102366	Rohde & Schwarz	22.09.07	22.09.09

EMI Test System

Equipment	Type	Serial No.	Manufacturer	Cal data	Next cal
Comparison Noise Emitter	CNE III	99/016	York	-	-
EMI Analyzer	ESI 26	830482/004	Rohde & Schwarz	06.12.07	06.12.09
Signal Generator	SMR 20	846834/008	Rohde & Schwarz	05.12.07	05.12.09
AC Power Source	6404	64040000B04	Croma ATE INC.	01.06.08	N/A the parameters will be checked before testing

EMI Radiated Auxiliary Equipment

Equipment	Type	Serial No.	Manufacturer	Cal data	Next cal
Antenna mast 4m	MA 240	240/492	HD GmbH H. Deisel	-	-
Biconical dipole	VUBA 9117	9117108	Schwarzbeck	02.07.03	06.10.08
Broadband Amplifier 18MHz-26GHz	JS4-18002600-32	849785	Miteq	06.02.08	06.10.08
Broadband Amplifier 30MHz-18GHz	JS4-00101800-35	896037	Miteq	06.02.08	06.10.08
Broadband Amplifier 45MHz-27GHz	JS4-00102600-42	619368	Miteq	06.02.08	06.10.08
Cable "ESI to EMI Antenna"	EcoFlex10	W18.01-2 W38.01-2	Kabel Kusch	06.02.08	06.10.08
Cable "ESI to Horn Antenna"	UFB311A UFB293C	W18.02-2 W38.02-2	Rosenberger-Microcoax	06.02.08	06.10.08
Double-ridged horn	HF 906	357357/002	Rohde & Schwarz	12.05.06	06.10.08
Double-ridged horn	HF 906	357357/001	Rohde & Schwarz	20.01.04	N/A – spare antenna
High Pass Filter	5HC3500/12750-1.2-KK	200035008	Trilithic	06.02.08	06.10.08
High Pass Filter	5HC2700/12750-1.5-KK	9942012	Trilithic	06.02.08	06.10.08
High Pass Filter	4HC1600/12750-1.5-KK	9942011	Trilithic	06.02.08	06.10.08
Log.-per. Antenna	HL 562 UltraLog	830547/003	Rohde & Schwarz	17.05.06	17.05.09
Loop Antenna	HFH2-Z2	829324/006	Rohde & Schwarz	19.08.02	N/A – only used for pre-testing
Pyramidal Horn Antenna 26.5 GHz	Model 3160-09	9910-1184	EMCO	06.02.08	06.10.08

EMI Conducted Auxiliary Equipment

Equipment	Type	Serial No.	Manufacturer	Cal data	Next cal
Cable "LISN to ESI"	RG214	W18.03+W48.03	Huber+Suhner	06.02.08	06.10.08
Two-Line V-Network	ESH 3-Z5	828304/029	Rohde & Schwarz	01.11.05	01.11.08
Two-Line V-Network	ESH 3-Z5	829996/002	Rohde & Schwarz	-	-

Auxiliary Test Equipment – calibration not applicable; spare equipment

Equipment	Type	Serial No.	Manufacturer	Cal data	Next cal
Broadband Resist. Power Divider N	1506A / 93459	LM390	Weinschel	-	-
Broadband Resist. Power Divider SMA	1515 / 93459	LN673	Weinschel	-	-
Digital Multimeter 01	Voltcraft M-3860M	IJ096055	Conrad	-	-
Digital Multimeter 02	Voltcraft M-3860M	IJ095955	Conrad	-	-
Digital Oscilloscope	TDS 784C	B021311	Tektronix	-	-
Fibre optic link Satellite	FO RS232 Link	181-018	Pontis	-	-
Fibre optic link Transceiver	FO RS232 Link	182-018	Pontis	-	-
I/Q Modulation Generator	AMIQ-B1	832085/018	Rohde & Schwarz	-	-
Notch Filter ultra stable	WRCA800 /960-6E	24	Wainwright	-	-
Spectrum Analyzer 9 kHz to 3 GHz	FSP3	838164/004	Rohde & Schwarz	-	-
Temperature Chamber	VT 4002	58566002150010	Vötsch	-	-
Temperature Chamber	KWP 120/70	59226012190010	Weiss	-	-
ThermoHygro Datalogger 03	Opus10 THI (8152.00)	7482	Lufft Mess- und Regeltechnik GmbH	-	-

Anechoic Chamber – calibration not applicable

Equipment	Type	Serial No.	Manufacturer	Cal data	Next cal
Air Compressor (pneumatic)			Atlas Copco	-	-
Controller	CO 2000	CO2000/328/12470406/L	Innco innovative constructions GmbH	-	-
EMC Camera	CE-CAM/1		CE-SYS	-	-
EMC Camera for observation of EUT	CCD-400E	0005033	Mitsubishi	-	-
Filter ISDN	B84312-C110-E1		Siemens & Matsushita	-	-
Filter telephone systems / modem	B84312-C40-B1		Siemens & Matsushita	-	-
Filter Universal 1A	B84312-C30-H3		Siemens & Matsushita	-	-
Fully/Semi AE Chamber	10.58x6.3 8x6		Frankonia	-	-
Turntable	DS 420S	420/573/99	HD GmbH, H.Deisel	-	-
Valve Control Unit (pneum.)	VE 615P	615/348/99	HD GmbH, H.Deisel	-	-



7 layers Bluetooth Full RF Test Solution

Bluetooth RF Conformance Test System TS8960

Equipment	Type	Serial No.	Manufacturer	Cal data	Next cal
Power Meter 832025/059	NRVD	832025/059	Rohde & Schwarz	17.06.08	15.06.09
Power Sensor A 832279/013	NRV-Z1	832279/013	Rohde & Schwarz	18.06.08	17.06.09
Power Sensor B 832279/015	NRV-Z1	832279/015	Rohde & Schwarz	18.06.08	17.06.09
Power Supply	E3632A	MY40003776	Agilent	-	-
Power Supply	PS-2403D	-	Conrad	-	-
Rubidium Frequency Normal	MFS	002	Efratom	18.06.08	17.06.09
Signal Analyzer FSIQ26 832695/007	FSIQ26	832695/007	Rohde & Schwarz	23.08.07	23.08.09
Signal Generator 833680/003	SMP 03	833680/003	Rohde & Schwarz	04.07.06	04.07.09
Signal Generator A 834344/002	SMIQ03B	834344/002	Rohde & Schwarz	04.07.06	04.07.09
Signal Generator B 832870/017	SMIQ03B	832870/017	Rohde & Schwarz	24.05.07	24.05.10
Signal Switching and Conditioning Unit	SSCU	338826/005	Rohde & Schwarz	-	-
Signalling Unit PTW60 838312/014	PTW60 for TS8960	838312/014	Rohde & Schwarz	-	-
System Controller 829323/008	PSM12	829323/008	Rohde & Schwarz	-	-

6 Photo Report



Photo 1: Test setup for radiated measurements (Enclosure, below 1 GHz)

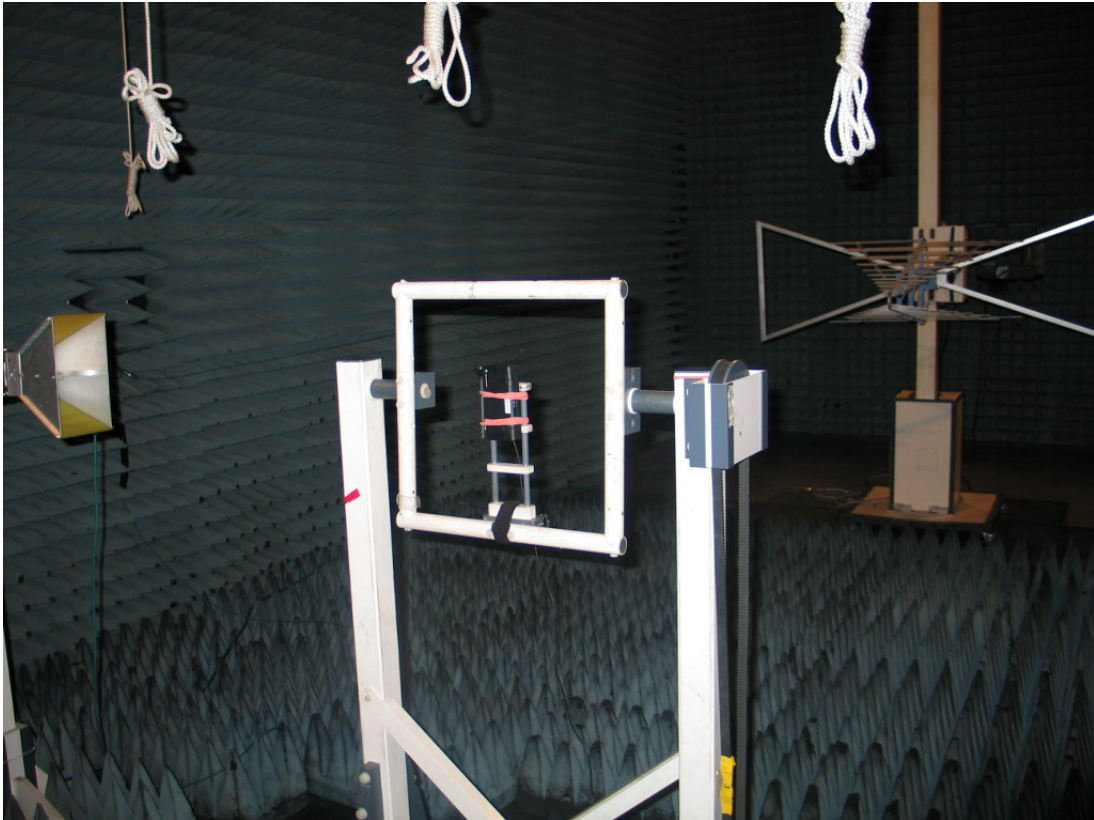

Photo 2: Test setup for radiated measurements (Enclosure, above 1 GHz)



Photo 3: Test setup for conducted measurements (AC Port (power line))



Photo 4: EUT (top side)



Photo 5: EUT (side view showing DC power input port)



Photo 6: EUT (bottom side, battery cover removed)



Photo 7: EUT (case opened, bottom side)



Photo 8: EUT (case opened, top side of PCB)

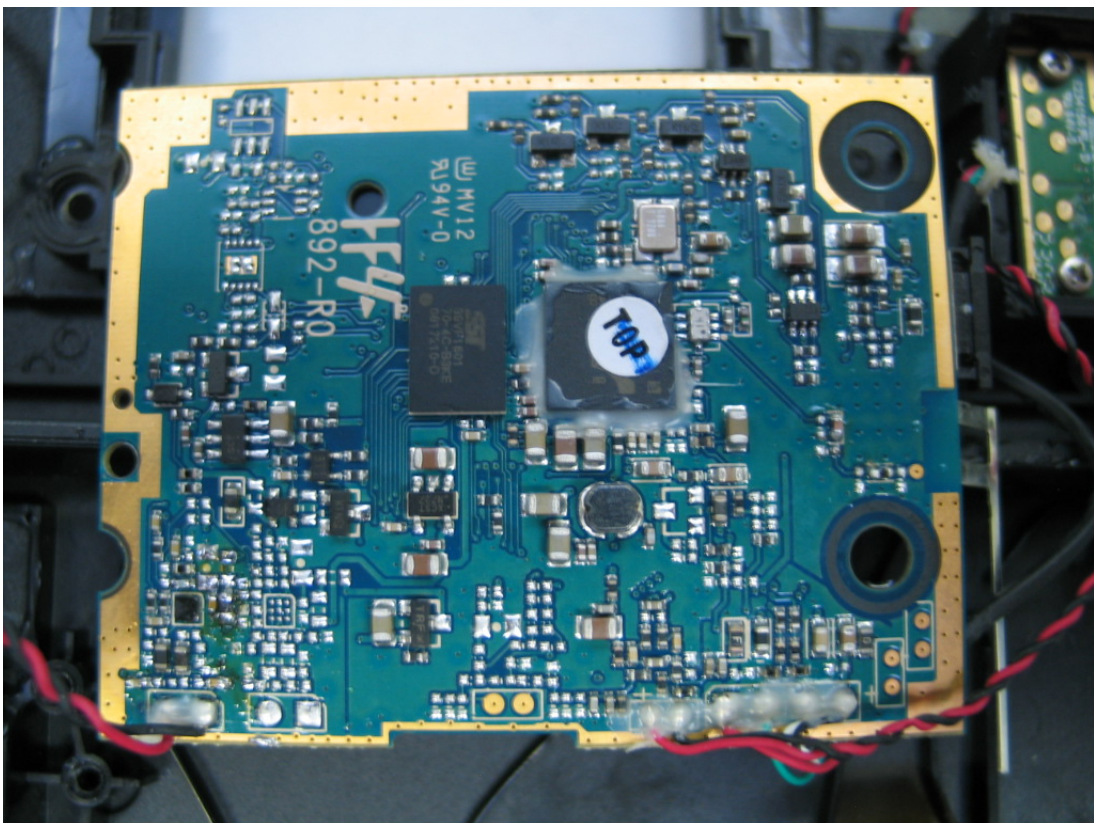
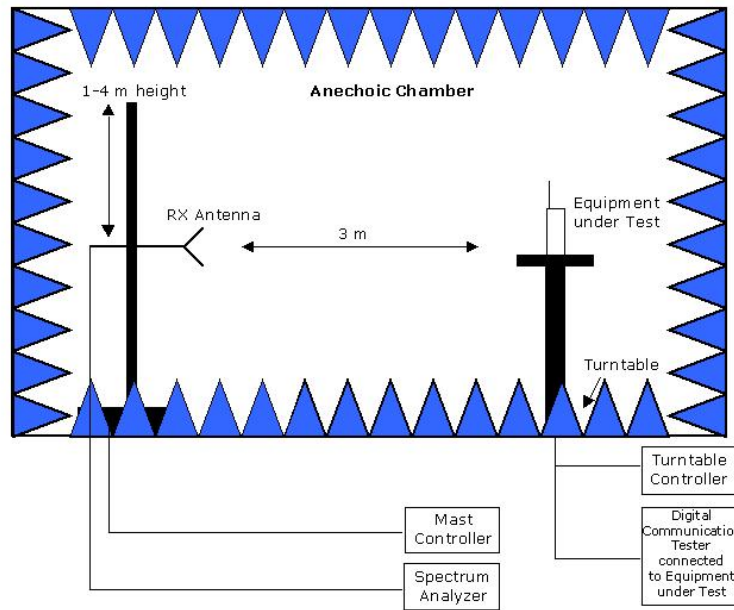

Photo 8: EUT (top side of PCB, detail view)

7 Setup Drawings



Remark: Depending on the frequency range suitable antenna types, attenuators or preamplifiers are used.

Drawing 1: Setup in the Anechoic chamber. For measurements below 1 GHz the ground was replaced by a conducting ground plane.

8 Annex measurement plots

8.1 AC Mains conducted

Op. Mode

op-mode 5

Short Description: FCC Voltage

Start Frequency	Stop Frequency	Step Width	Detector	Meas. Time	IF Bandw.	Transducer
150.0 kHz	30.0 MHz	5.0 kHz	MaxPeak Average	20.0 ms	9 kHz	ESH3-Z5

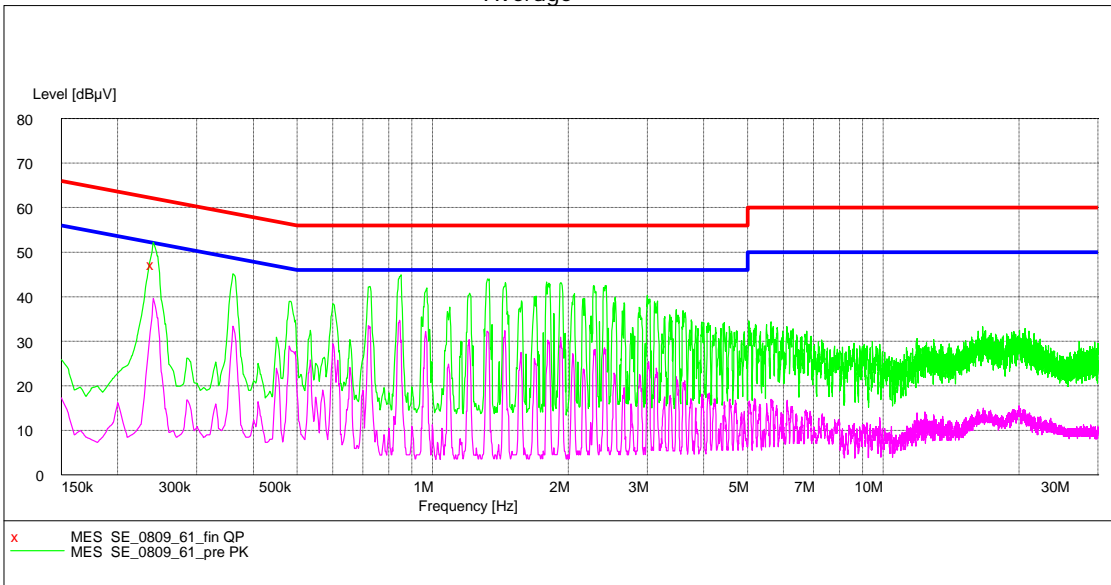



8.2 Occupied bandwidth

8.2.1 Occupied bandwidth operating mode 1

Op. Mode

op-mode 1

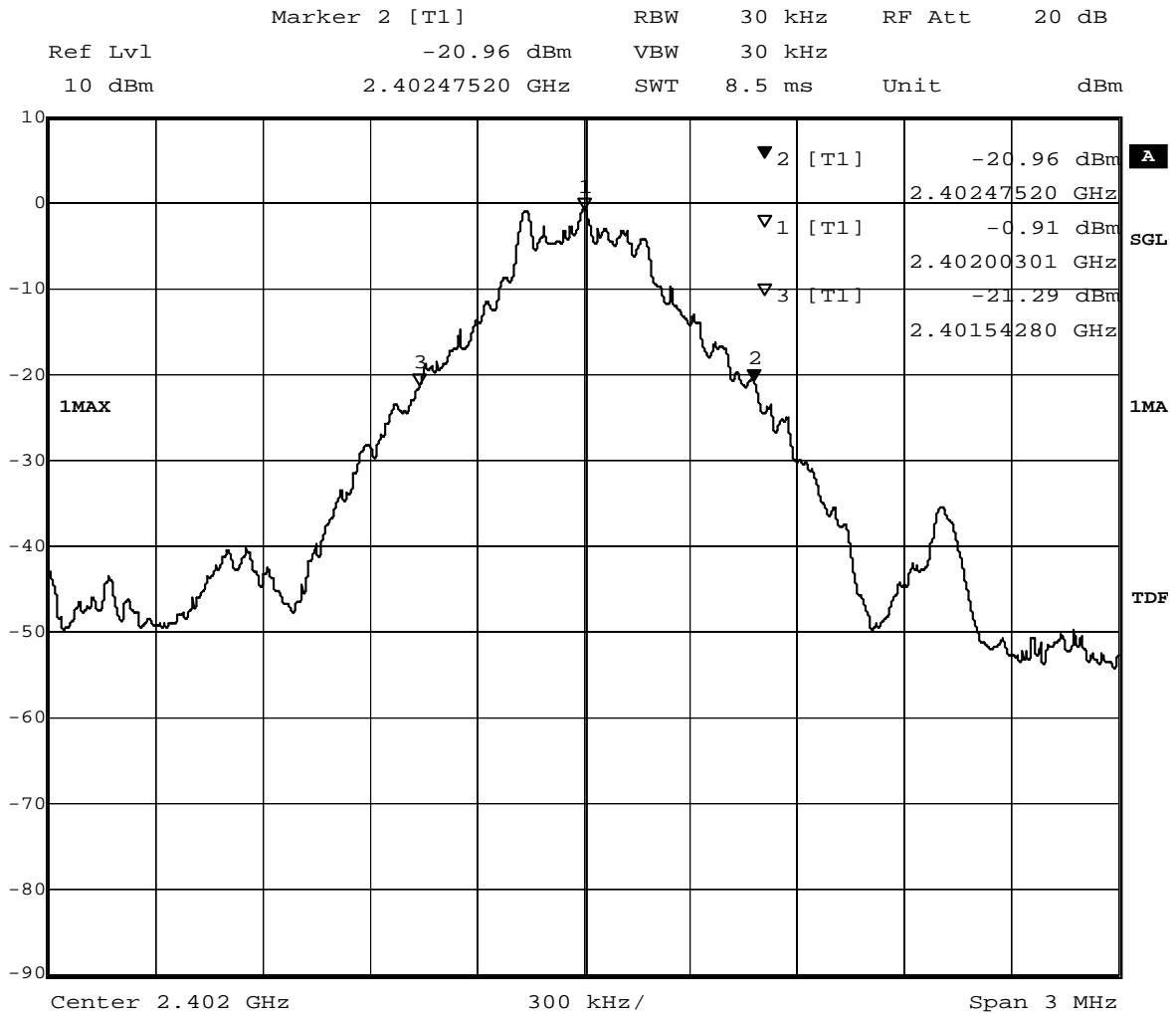

Title: 20dB Bandwidth

Comment A: CH B: 2402 MHz; 20dB bandwidth (kHz):932.4

Date: 30.JUL.2008 08:32:13



8.2.2 Occupied bandwidth operating mode 2

Op. Mode

op-mode 2

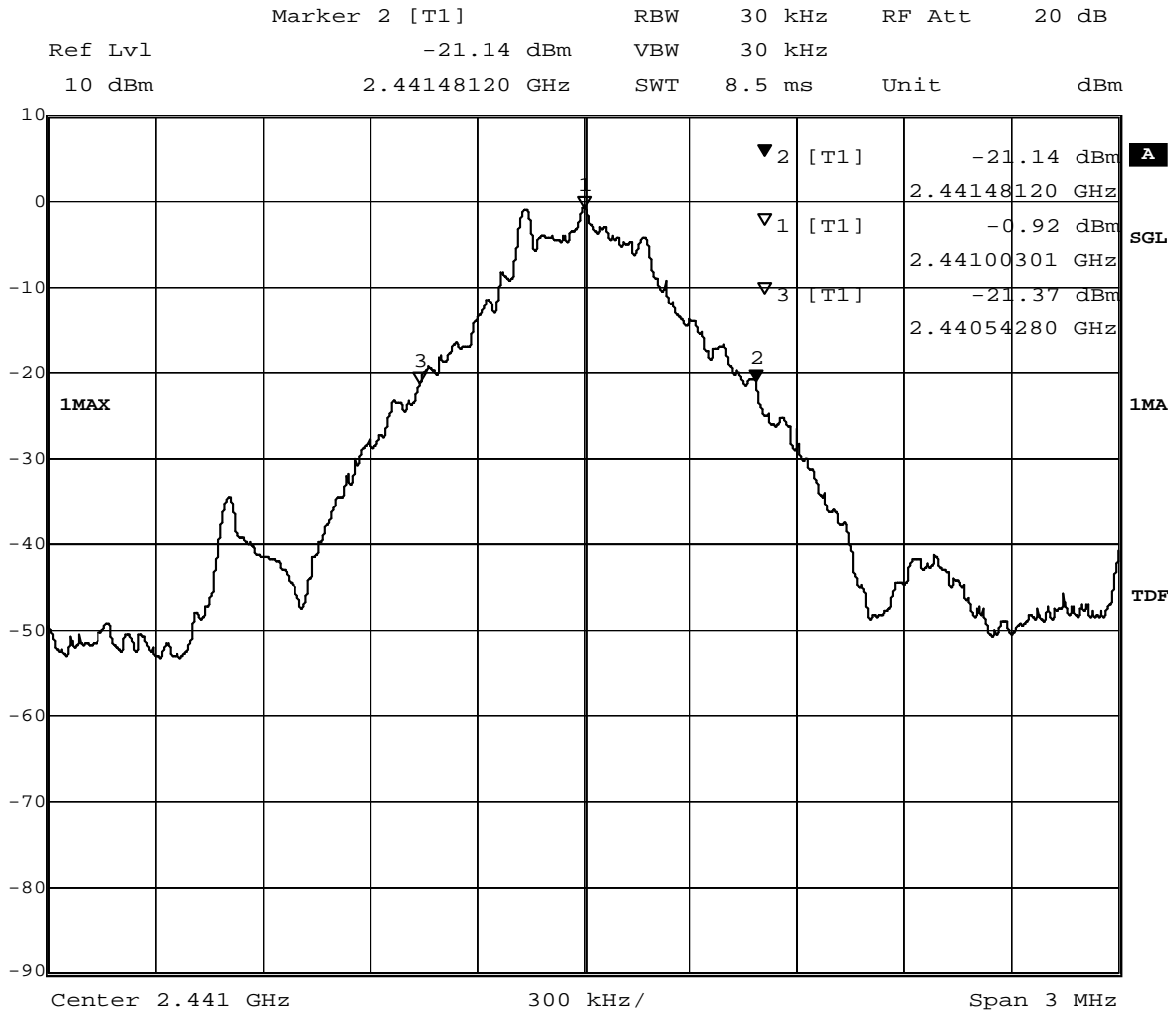

Title: 20dB Bandwidth
 Comment A: CH M: 2441 MHz; 20dB bandwidth (kHz):938.4
 Date: 30.JUL.2008 09:29:39



8.2.3 Occupied bandwidth operating mode 3

Op. Mode

op-mode 3

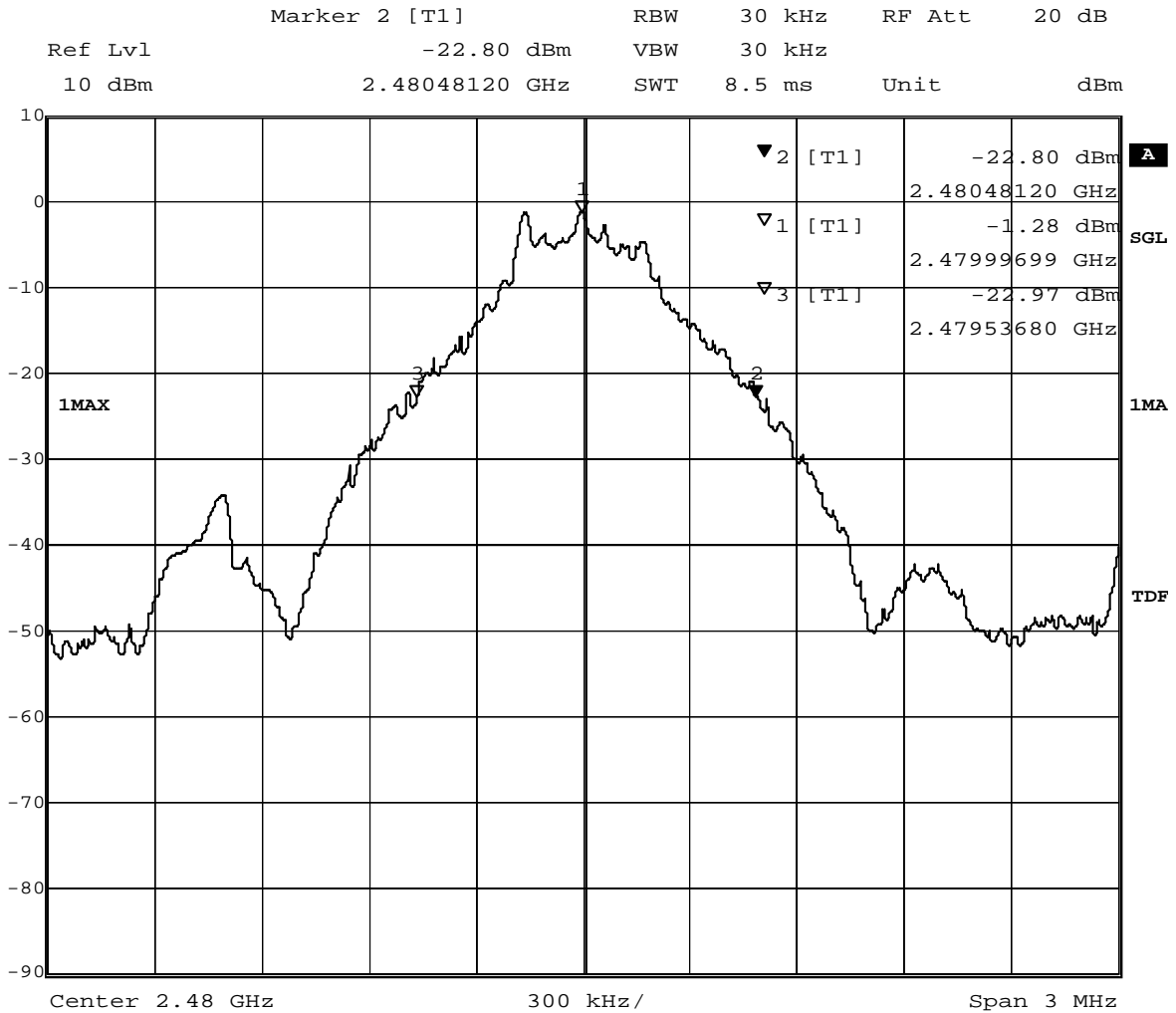

Title: 20dB Bandwidth
 Comment A: CH T: 2480 MHz; 20dB bandwidth (kHz):944.4
 Date: 30.JUL.2008 10:19:06



8.2.4 Occupied bandwidth operating mode 6

Op. Mode

op-mode 6

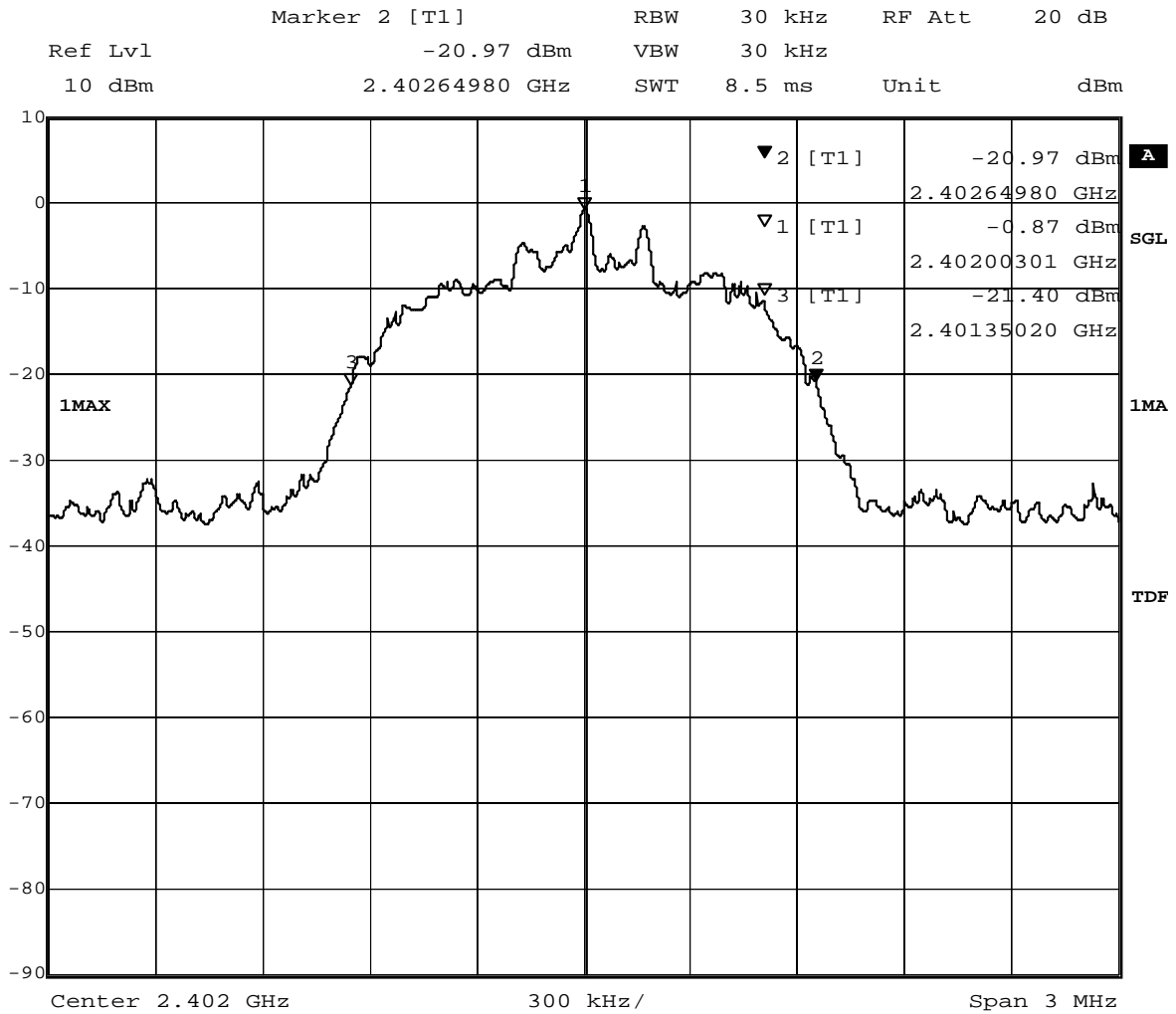

Title: 20dB Bandwidth
 Comment A: CH B: 2402 MHz; 20dB bandwidth (kHz):1299.6
 Date: 30.JUL.2008 09:11:23



8.2.5 Occupied bandwidth operating mode 7

Op. Mode

op-mode 7

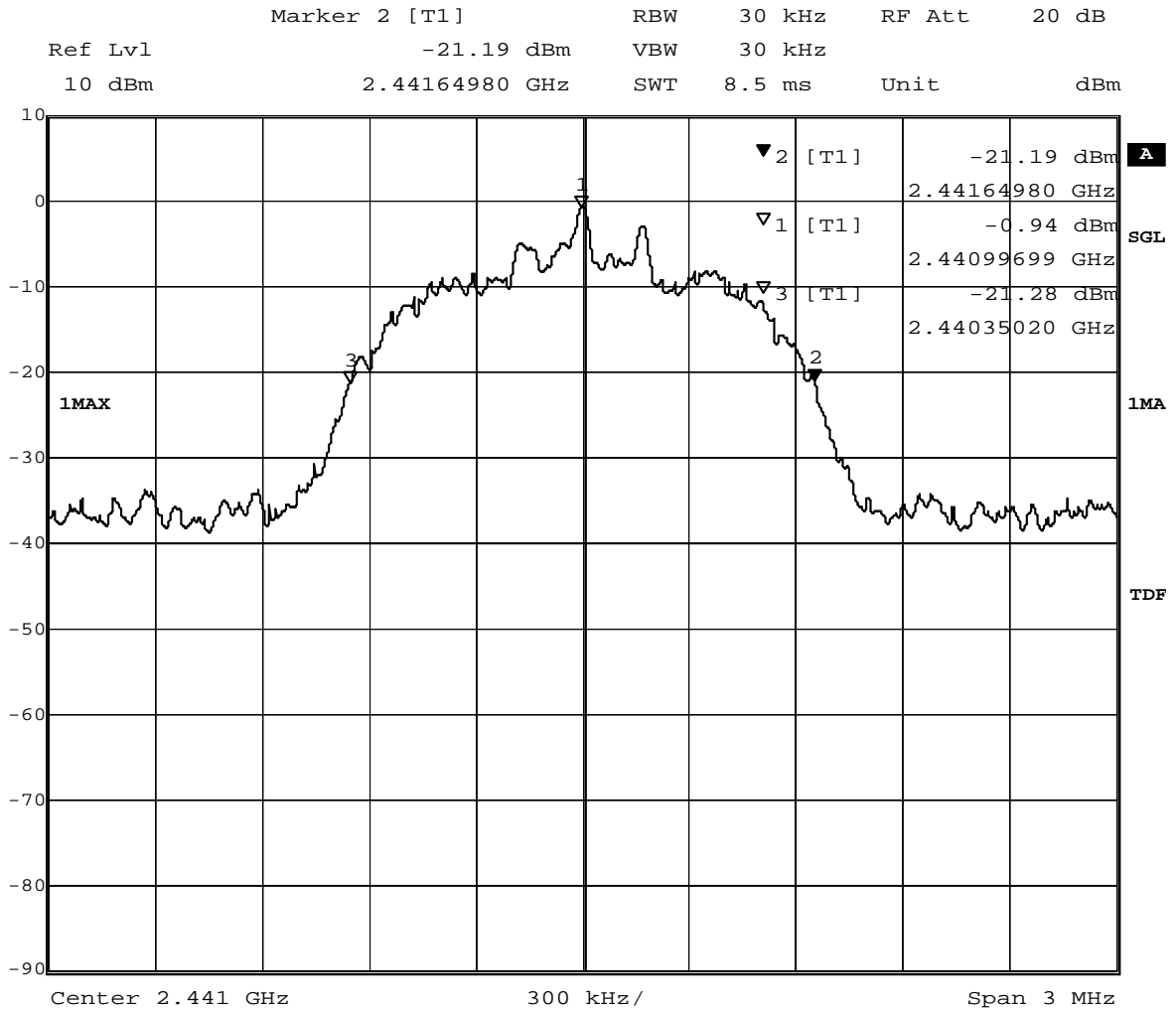

Title: 20dB Bandwidth
 Comment A: CH M: 2441 MHz; 20dB bandwidth (kHz):1299.6
 Date: 30.JUL.2008 10:02:22



8.2.6 Occupied bandwidth operating mode 8

Op. Mode

op-mode 8

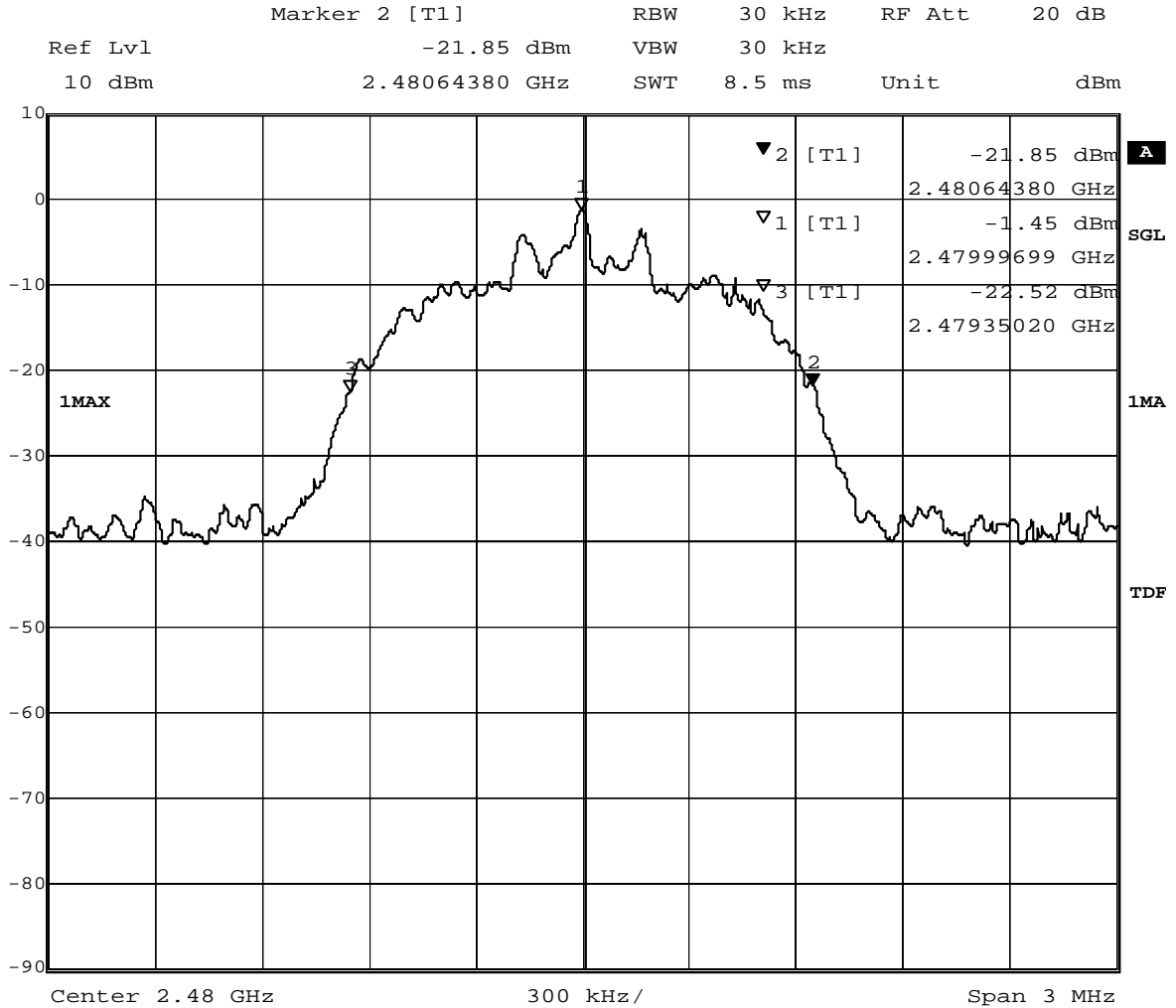

Title: 20dB Bandwidth
 Comment A: CH T: 2480 MHz; 20dB bandwidth (kHz):1293.6
 Date: 30.JUL.2008 10:53:21



8.2.7 Occupied bandwidth operating mode 10

Op. Mode

op-mode 10

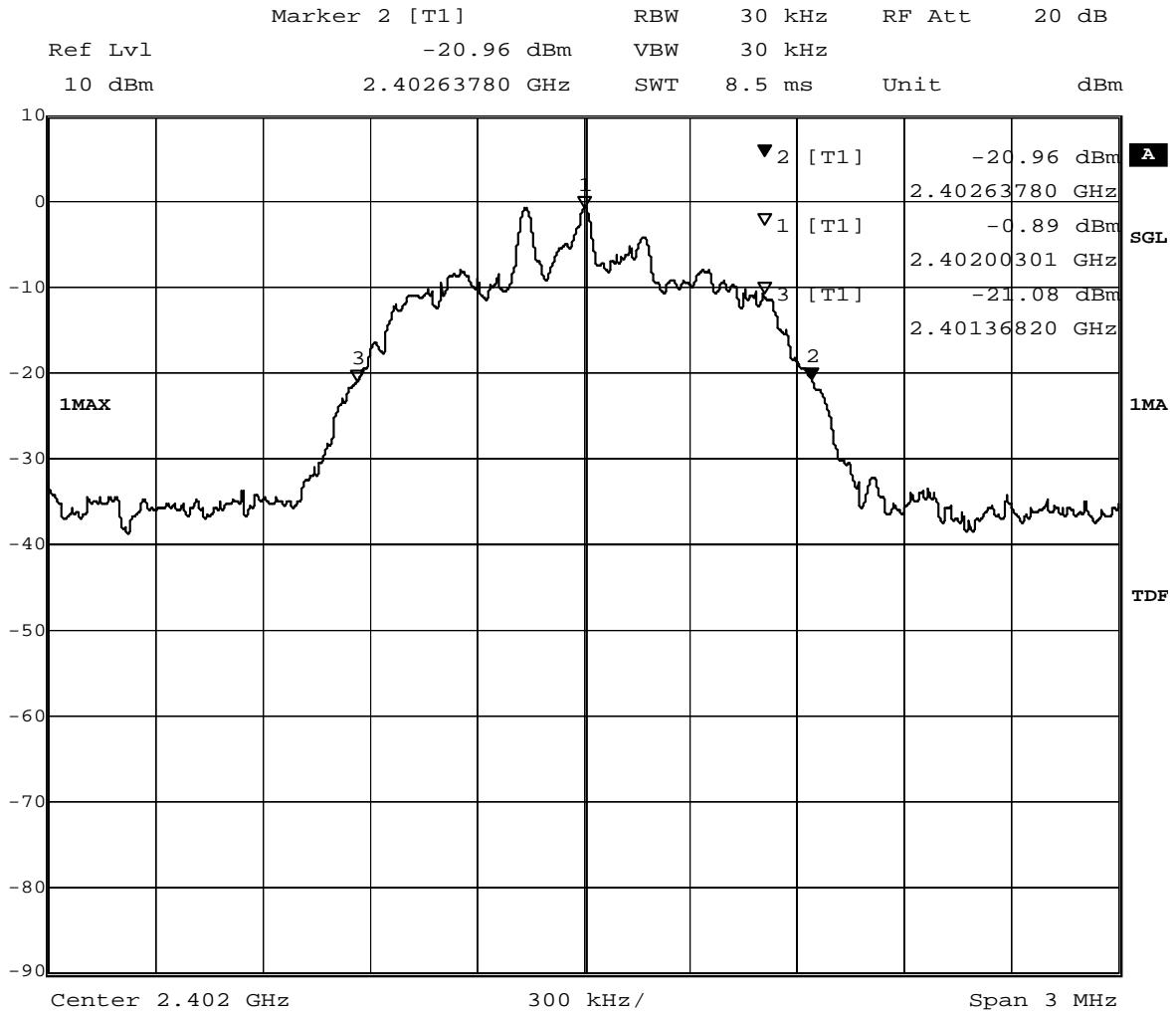

Title: 20dB Bandwidth
 Comment A: CH B: 2402 MHz; 20dB bandwidth (kHz):1269.6
 Date: 30.JUL.2008 08:53:01



8.2.8 Occupied bandwidth operating mode 11

Op. Mode

op-mode 11

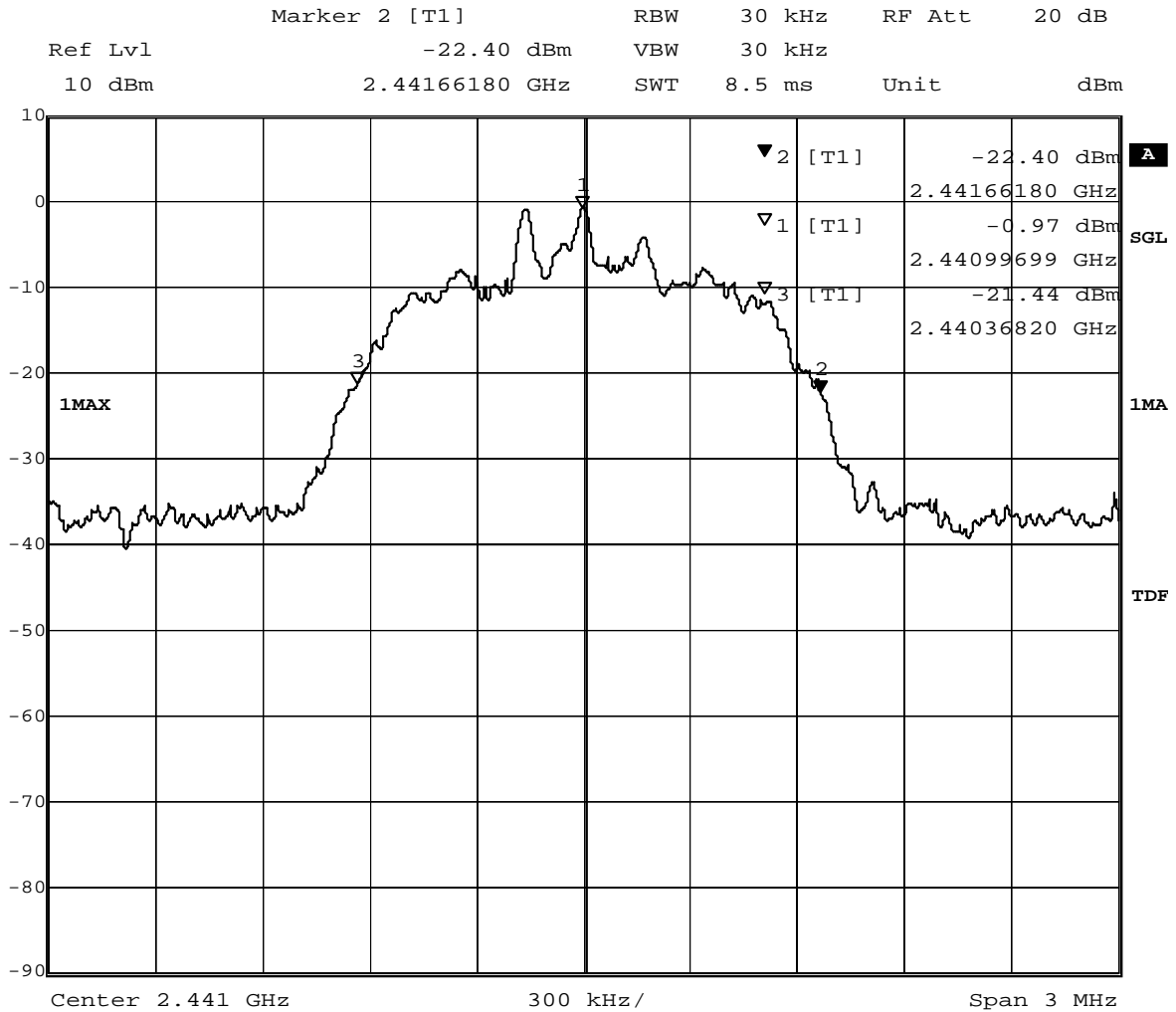

Title: 20dB Bandwidth
 Comment A: CH M: 2441 MHz; 20dB bandwidth (kHz):1293.6
 Date: 30.JUL.2008 09:46:05



8.2.9 Occupied bandwidth operating mode 12

Op. Mode

op-mode 12

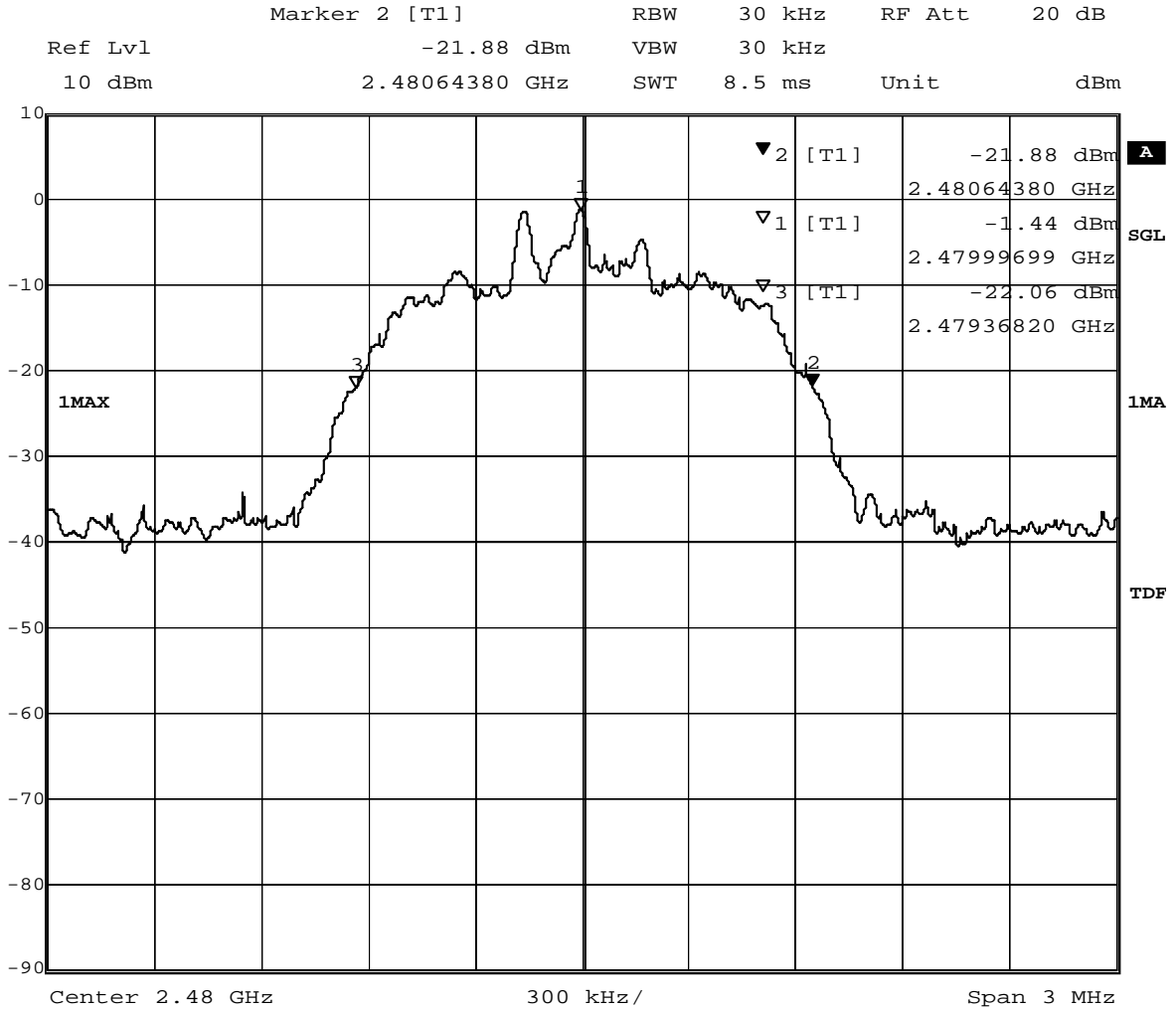

Title: 20dB Bandwidth
 Comment A: CH T: 2480 MHz; 20dB bandwidth (kHz):1275.6
 Date: 30.JUL.2008 10:35:51



8.3 Peak power output

8.3.1 Peak power output operating mode 1

Op. Mode

op-mode 1

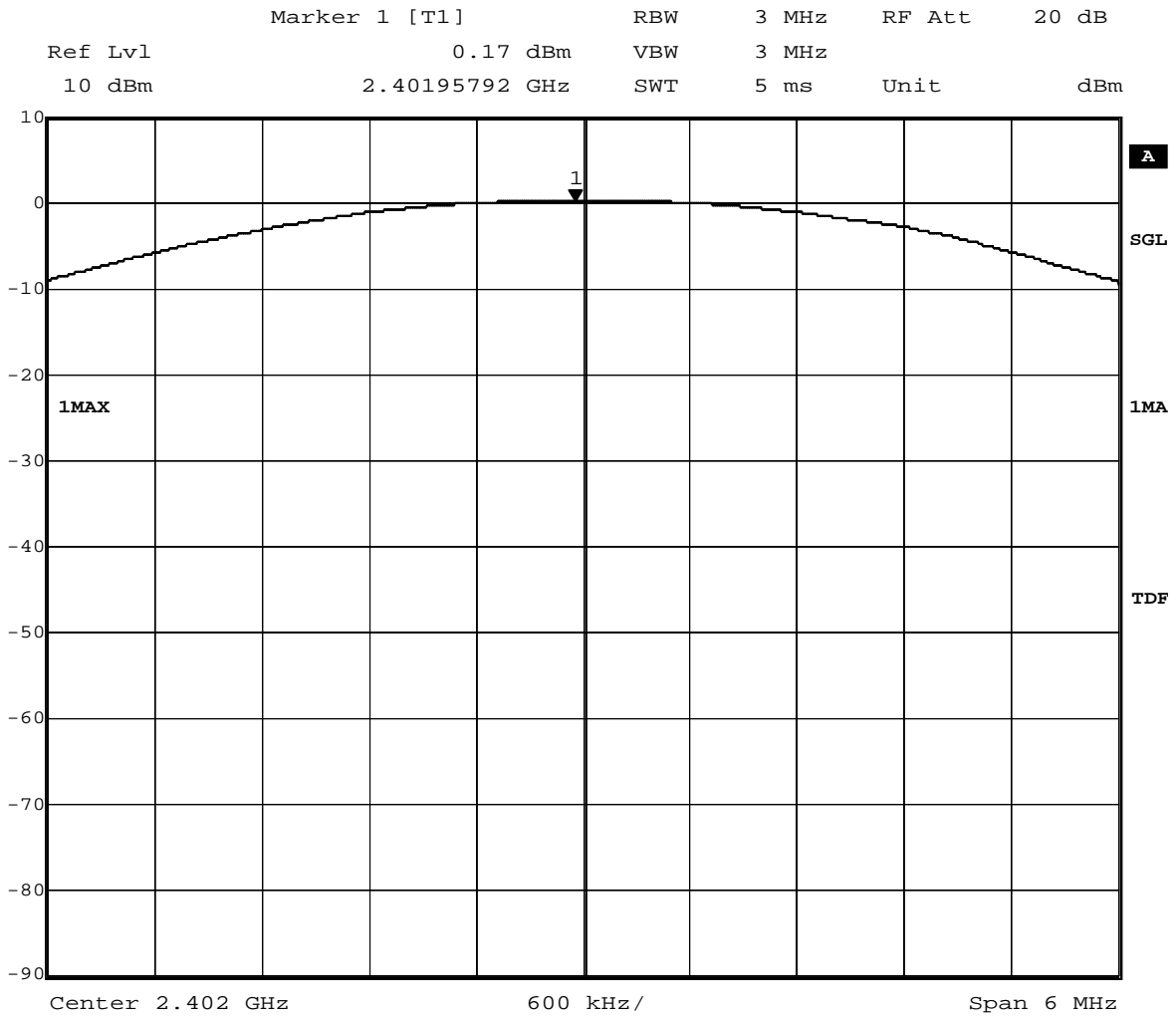

Title: Peak outputpower Power
Comment A: CH B: 2402 MHz
Date: 30.JUL.2008 08:32:39



8.3.2 Peak power output operating mode 2

Op. Mode

op-mode 2

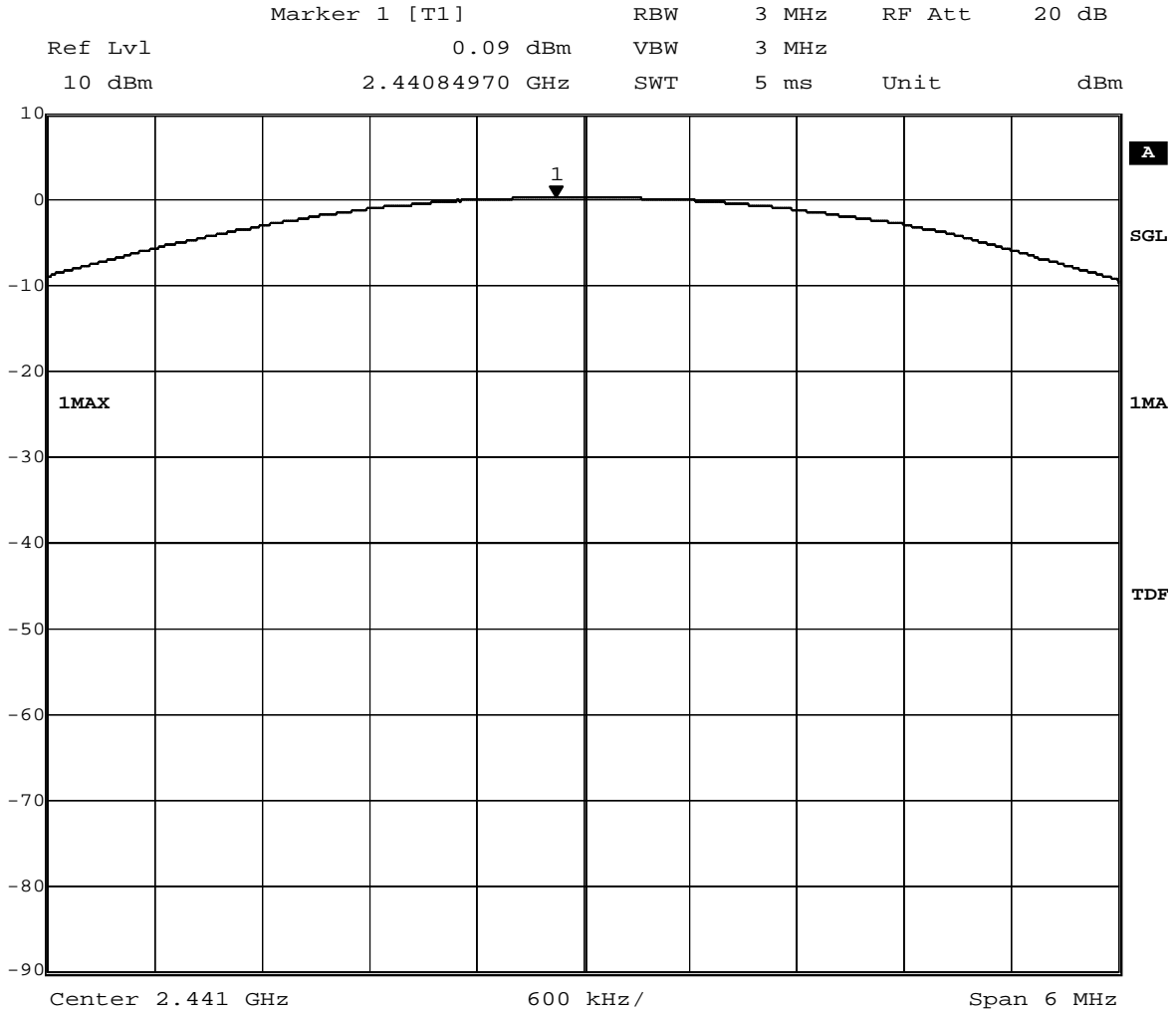

Title: Peak outputpower Power
Comment A: CH M: 2441 MHz
Date: 30.JUL.2008 09:30:07



8.3.3 Peak power output operating mode 3

Op. Mode

op-mode 3

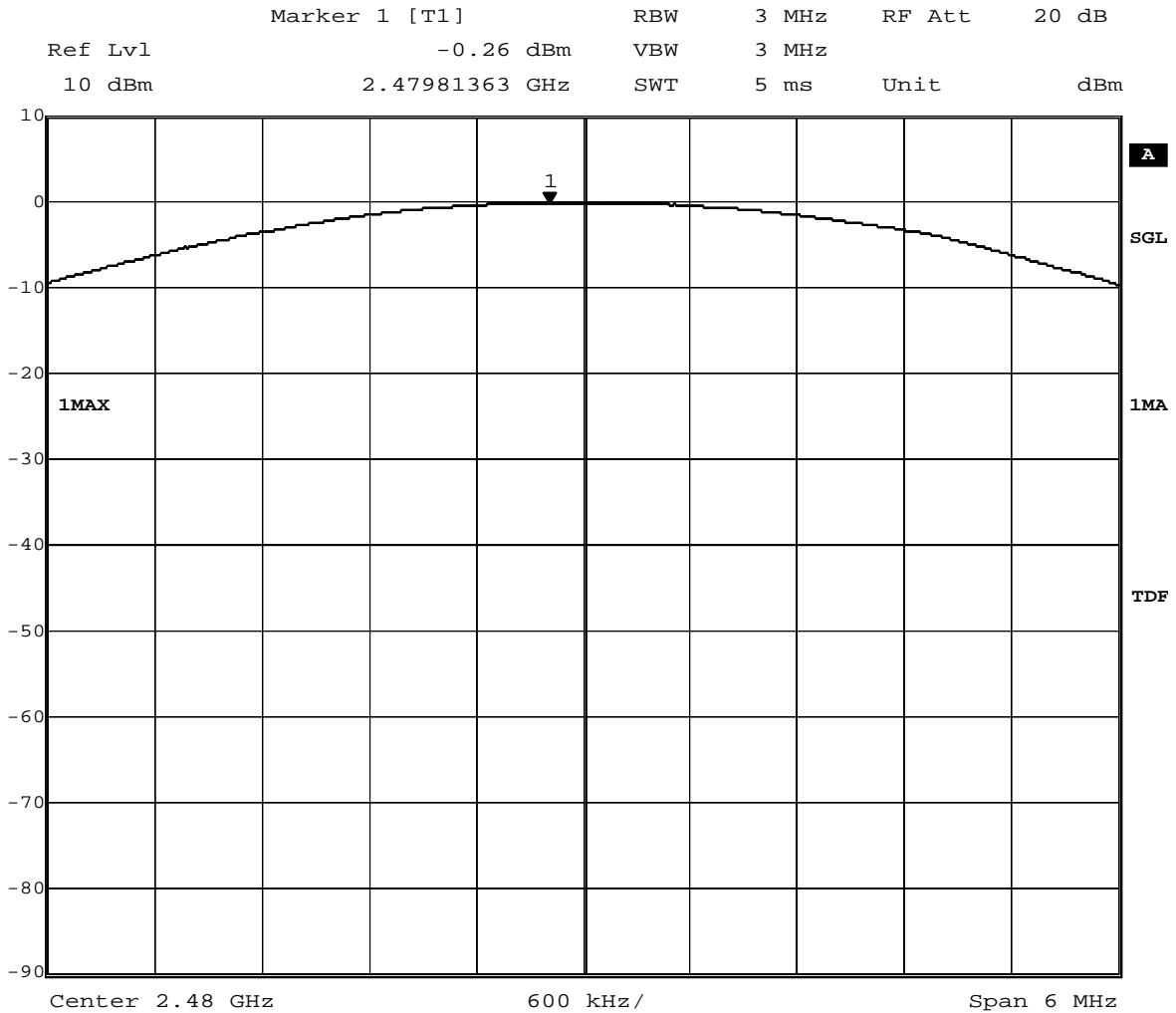

Title: Peak outputpower Power
Comment A: CH T: 2480 MHz
Date: 30.JUL.2008 10:19:32



8.3.4 Peak power output operating mode 6

Op. Mode

op-mode 6

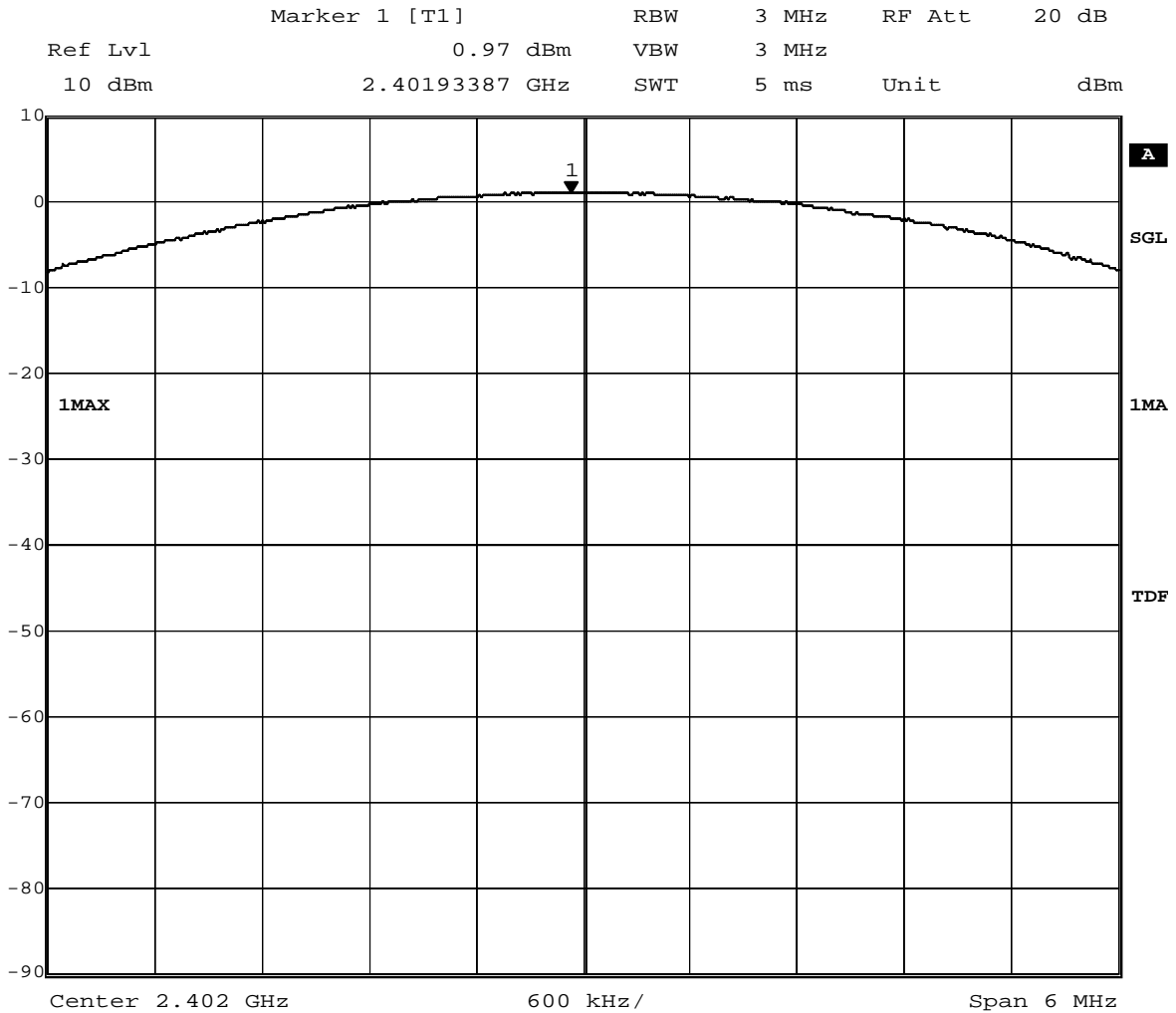

Title: Peak outputpower Power
Comment A: CH B: 2402 MHz
Date: 30.JUL.2008 09:11:51



8.3.5 Peak power output operating mode 7

Op. Mode

op-mode 7

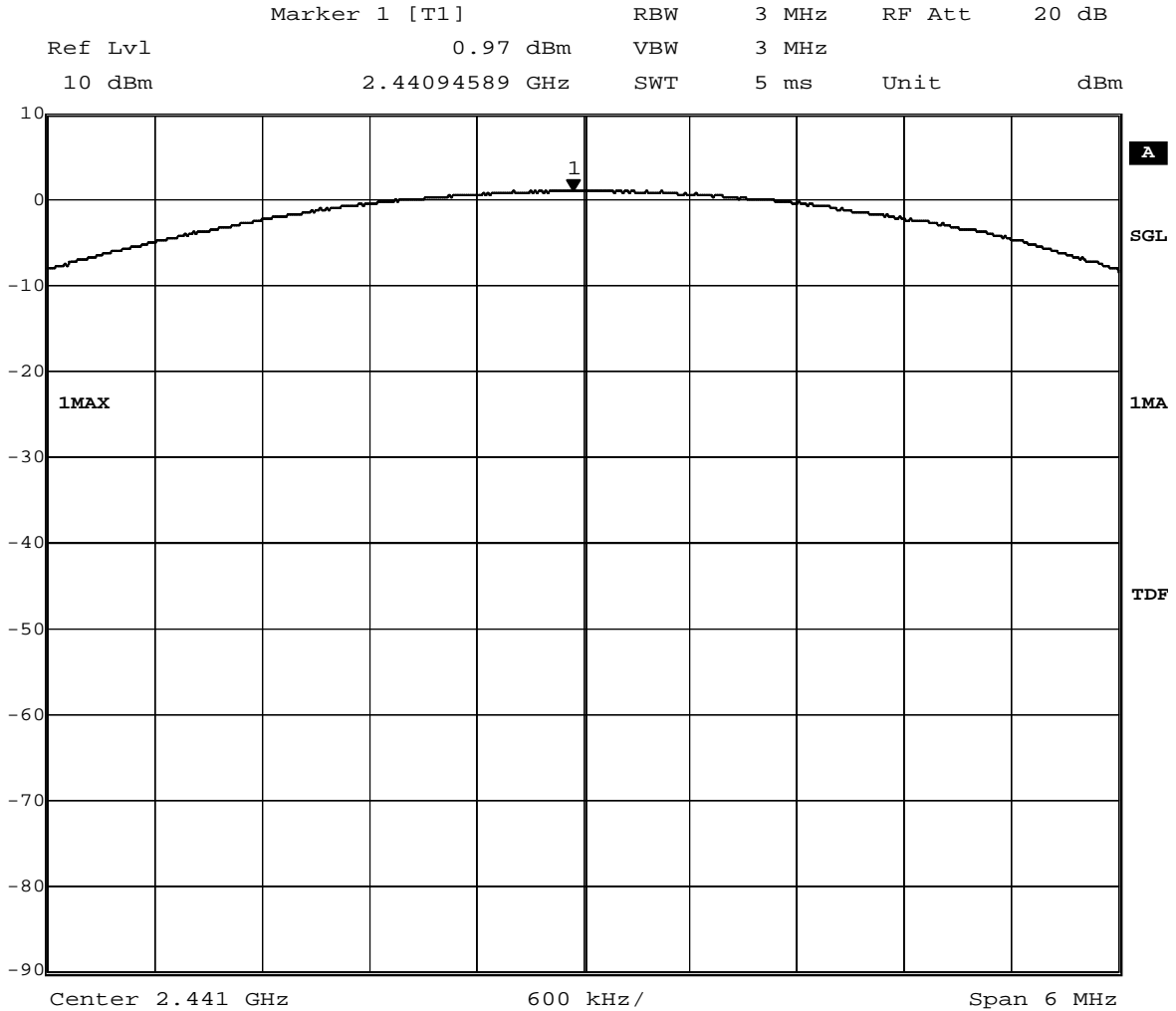

Title: Peak outputpower Power
Comment A: CH M: 2441 MHz
Date: 30.JUL.2008 10:02:48



8.3.6 Peak power output operating mode 8

Op. Mode

op-mode 8

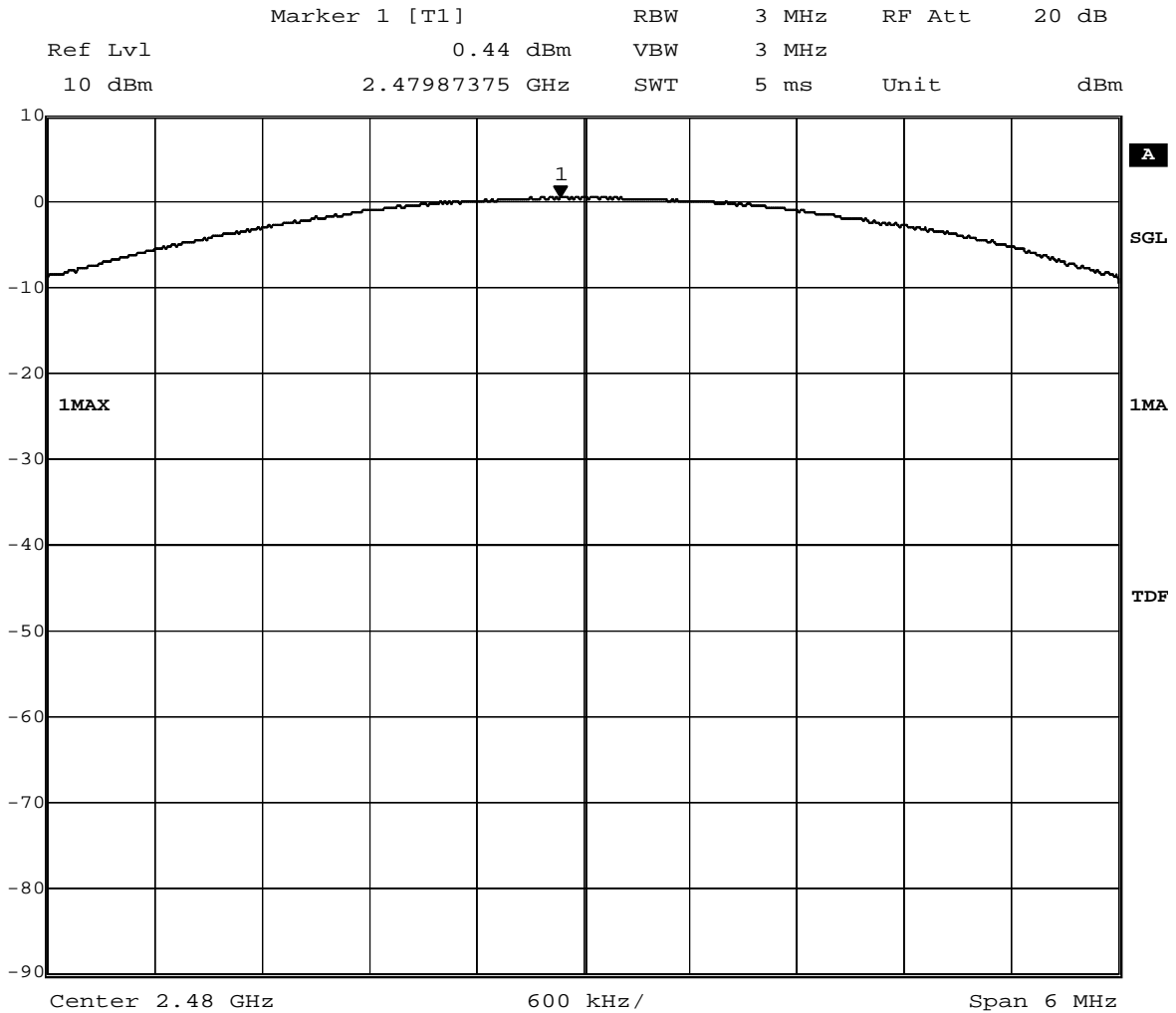

Title: Peak outputpower Power
Comment A: CH T: 2480 MHz
Date: 30.JUL.2008 10:53:47



8.3.7 Peak power output operating mode 10

Op. Mode

op-mode 10

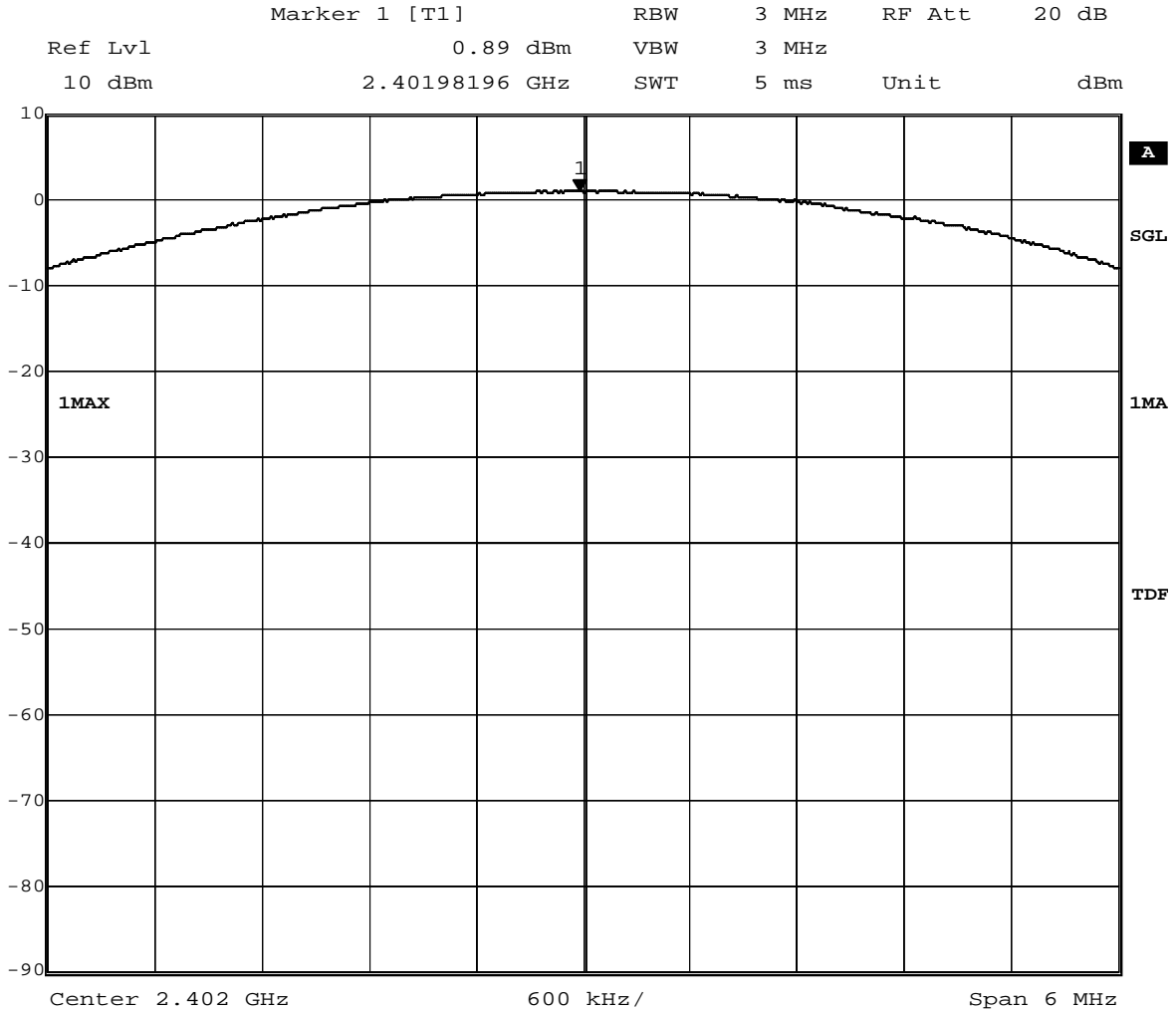

Title: Peak outputpower Power
Comment A: CH B: 2402 MHz
Date: 30.JUL.2008 08:53:27



8.3.8 Peak power output operating mode 11

Op. Mode

op-mode 11

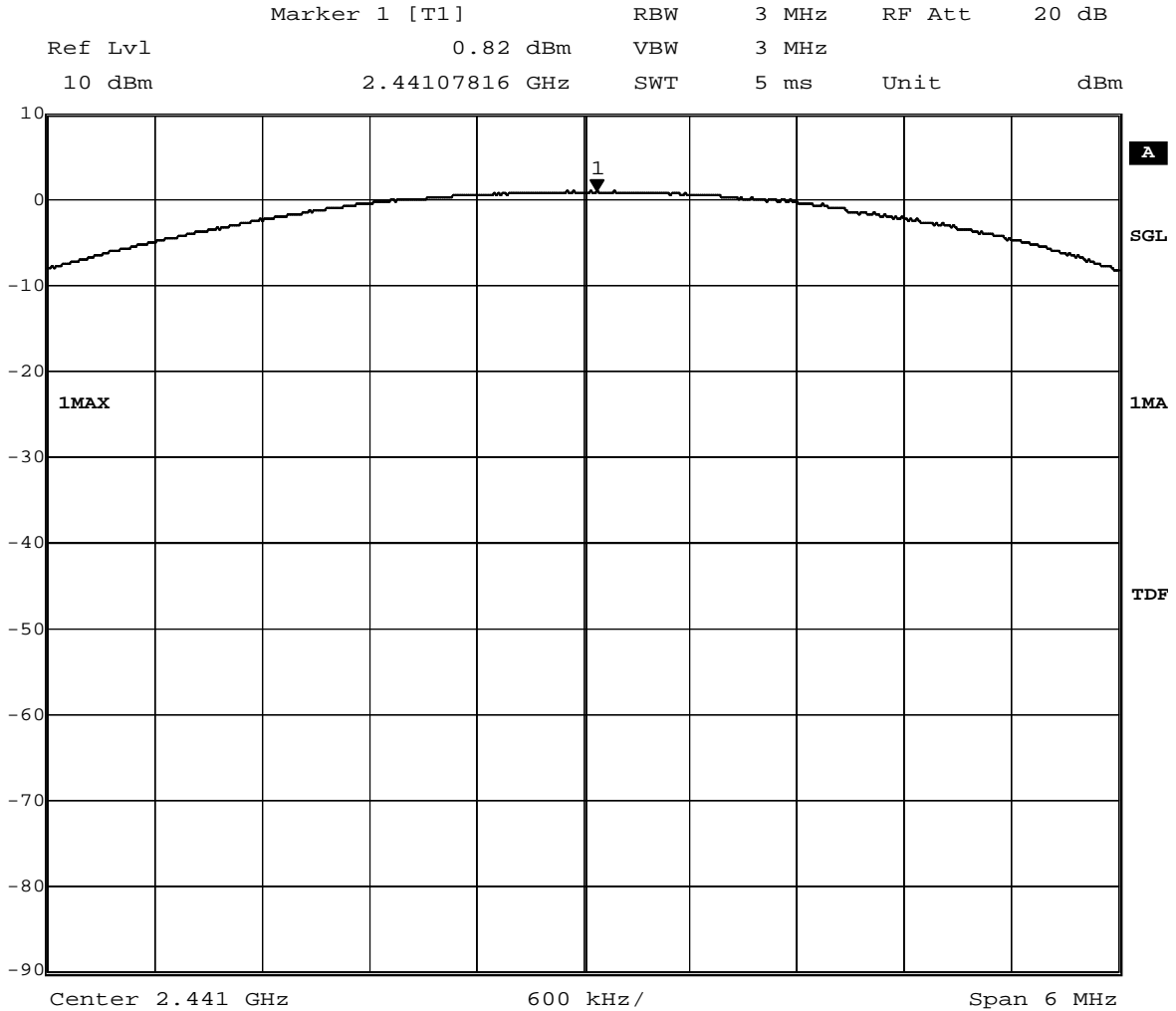

Title: Peak outputpower Power
Comment A: CH M: 2441 MHz
Date: 30.JUL.2008 09:46:32



8.3.9 Peak power output operating mode 12

Op. Mode

op-mode 12

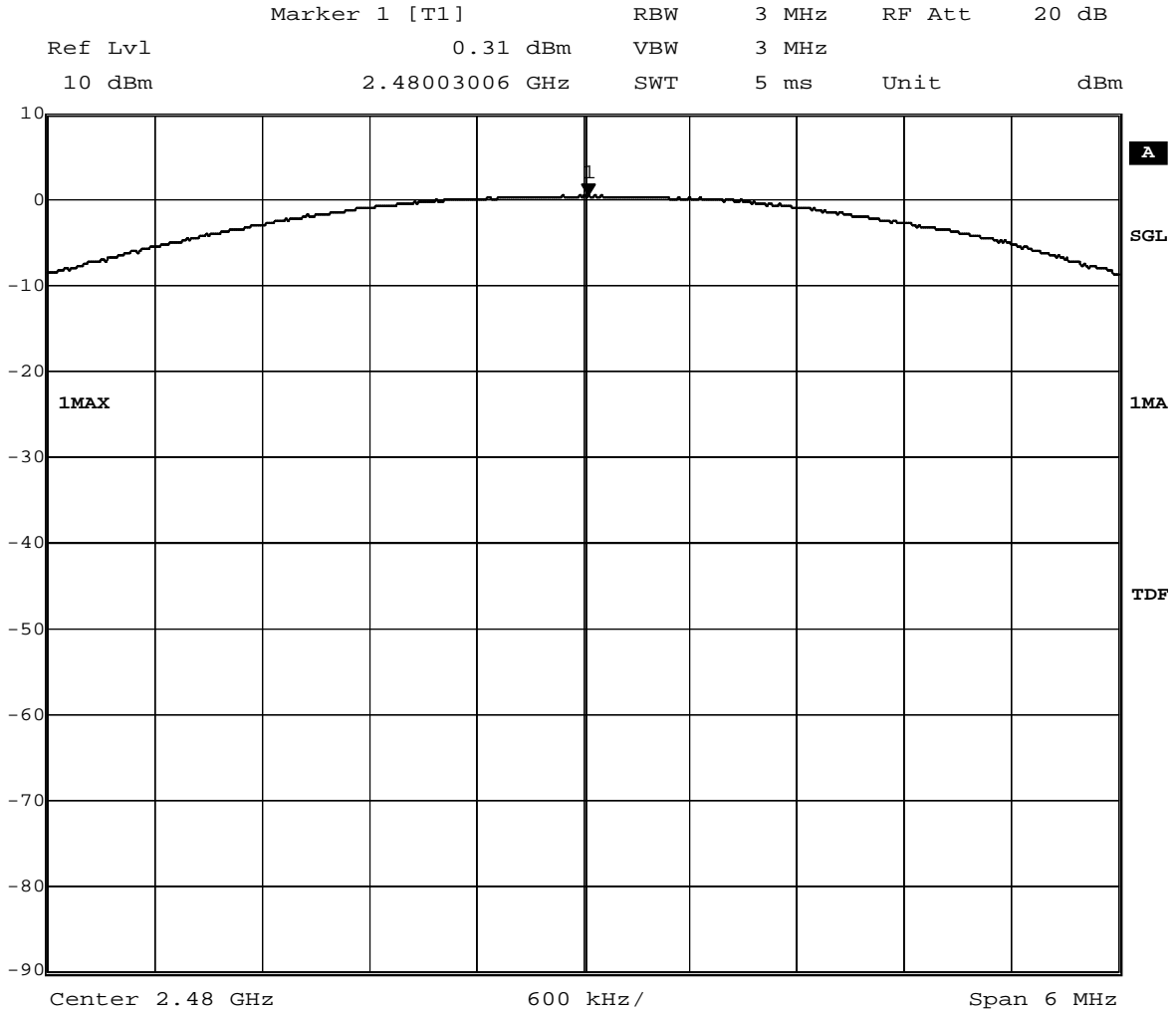

Title: Peak outputpower Power
Comment A: CH T: 2480 MHz
Date: 30.JUL.2008 10:36:16

8.4 Band edge compliance conducted and Spurious RF conducted emissions

8.4.1 Band edge compliance conducted operating mode 1

Op. Mode

op-mode 1

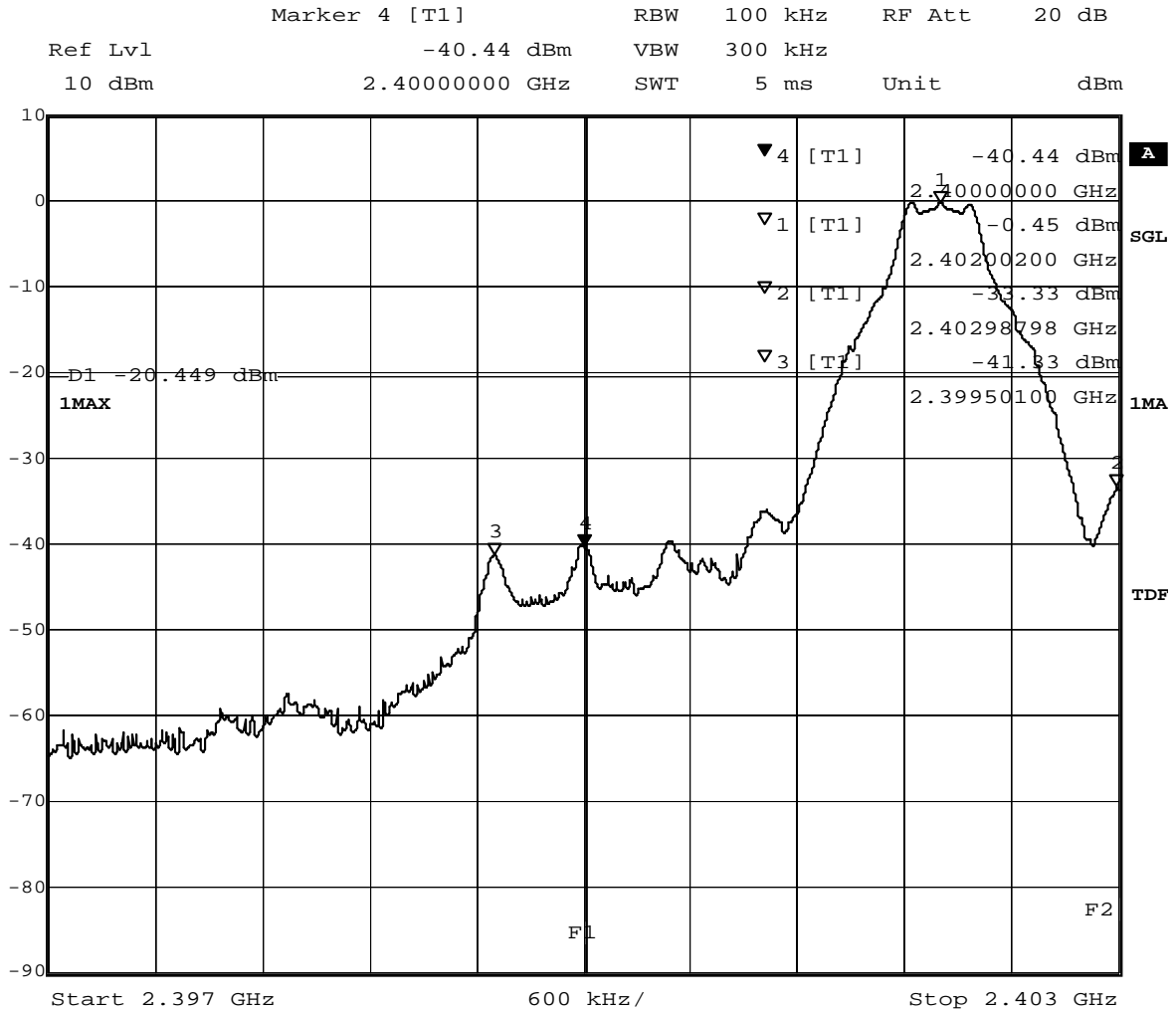

Title: Band Edge Compliance
 Comment A: CH B: 2402 MHz
 Date: 30.JUL.2008 08:17:12

(determination of reference value for spurious emissions measurement)



8.4.2 Spurious RF conducted emissions operating mode 1

Op. Mode

op-mode 1

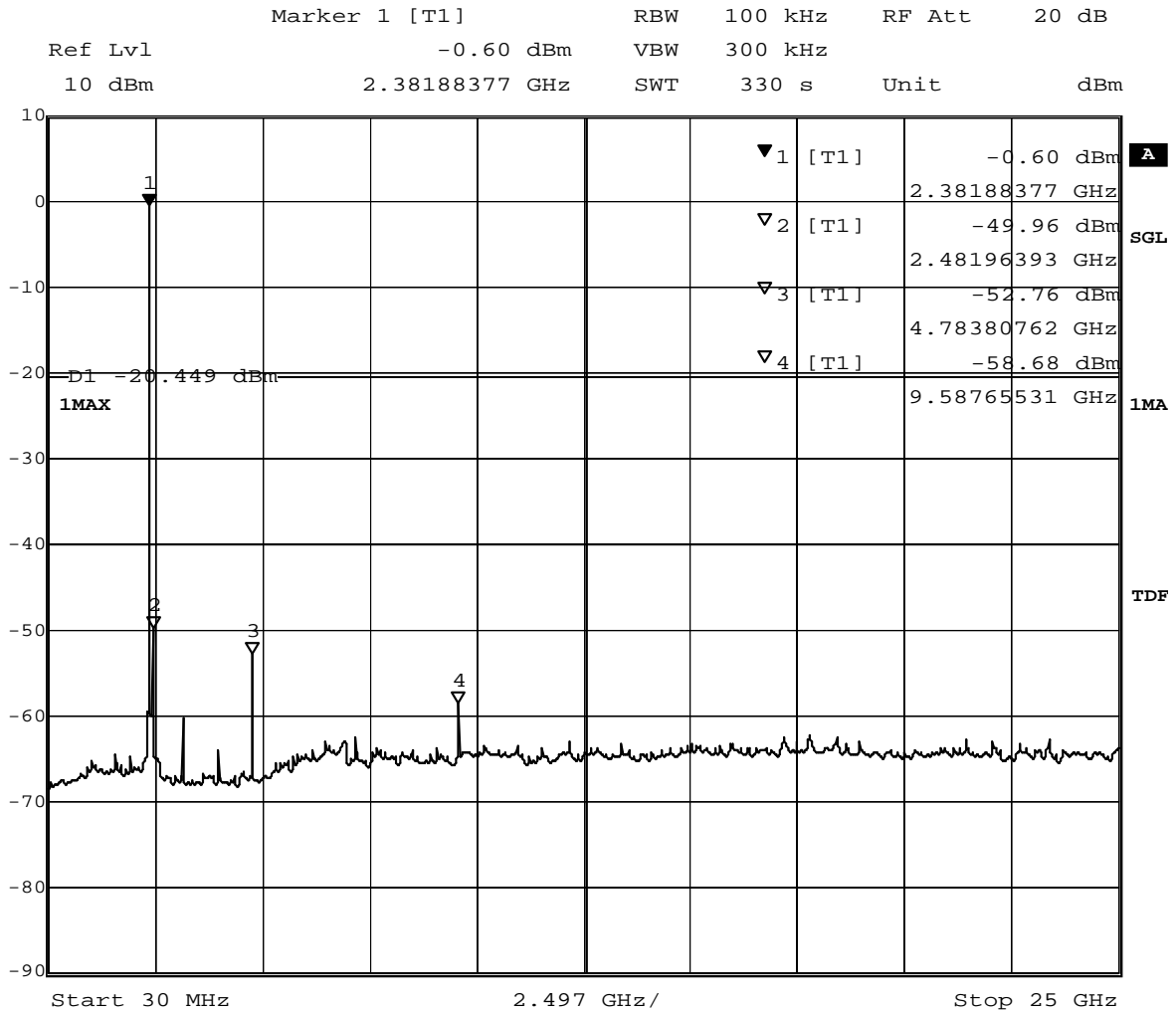

Title: spurious emissions
 Comment A: CH B: 2402 MHz
 Date: 30.JUL.2008 08:28:50

(spurious emissions measurement)

8.4.3 Spurious RF conducted emissions operating mode 2

Op. Mode

op-mode 2

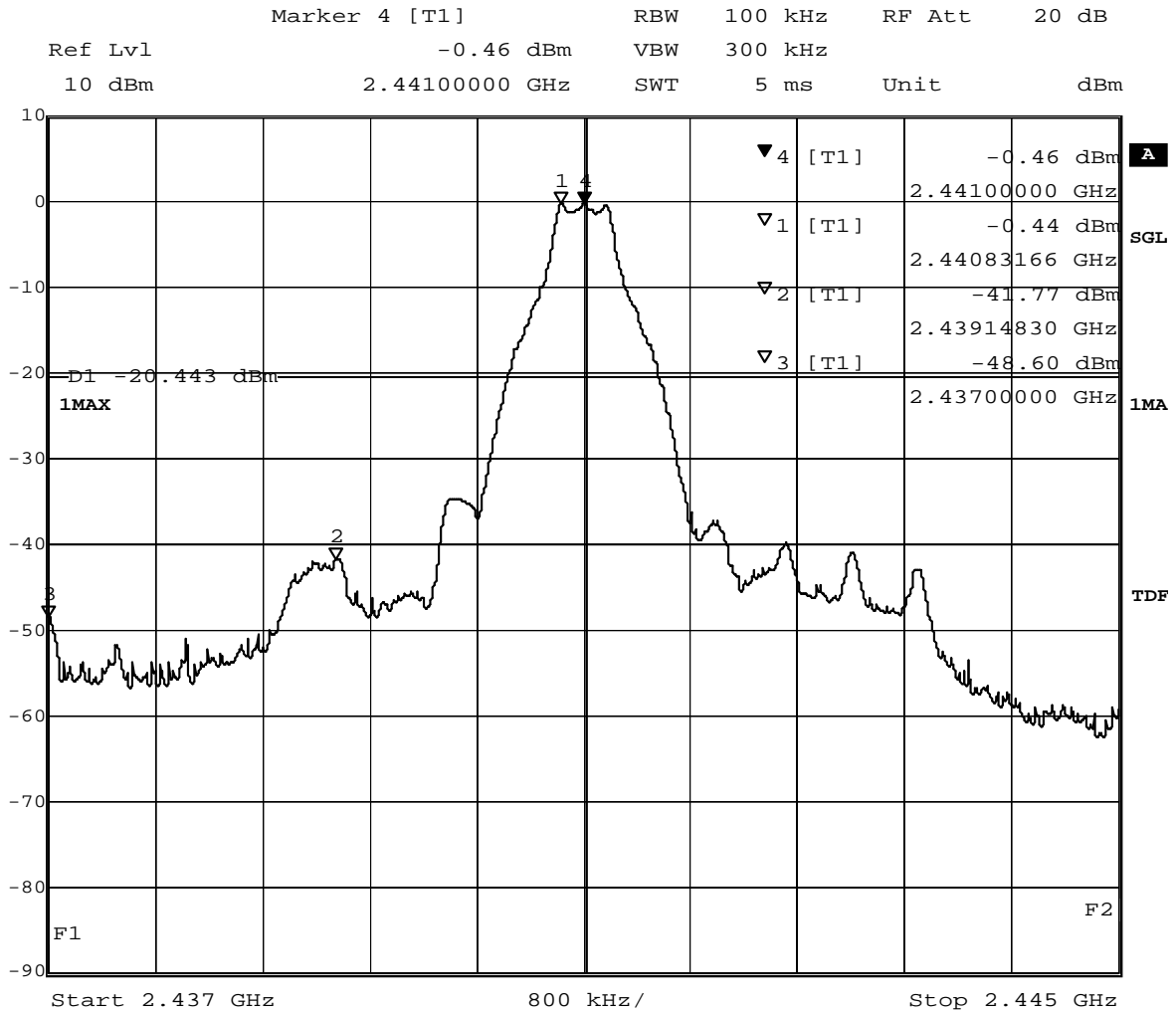

Title: Band Edge Compliance
 Comment A: CH M: 2441 MHz
 Date: 30.JUL.2008 09:14:47

(determination of reference value for spurious emissions measurement)

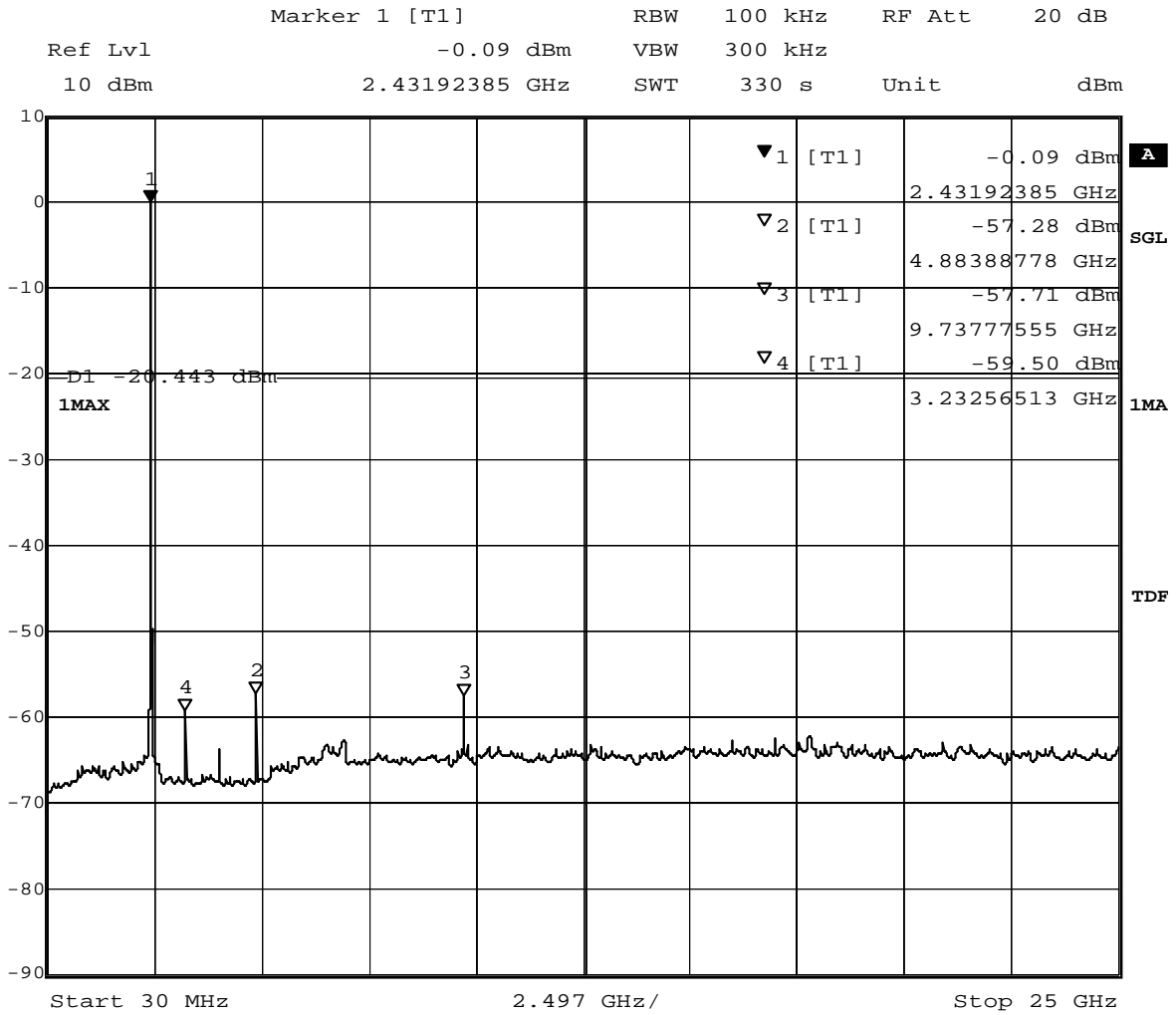

Title: spurious emissions
 Comment A: CH M: 2441 MHz
 Date: 30.JUL.2008 09:26:25

(spurious emissions measurement)

8.4.4 Band edge compliance conducted operating mode 3

Op. Mode

op-mode 3

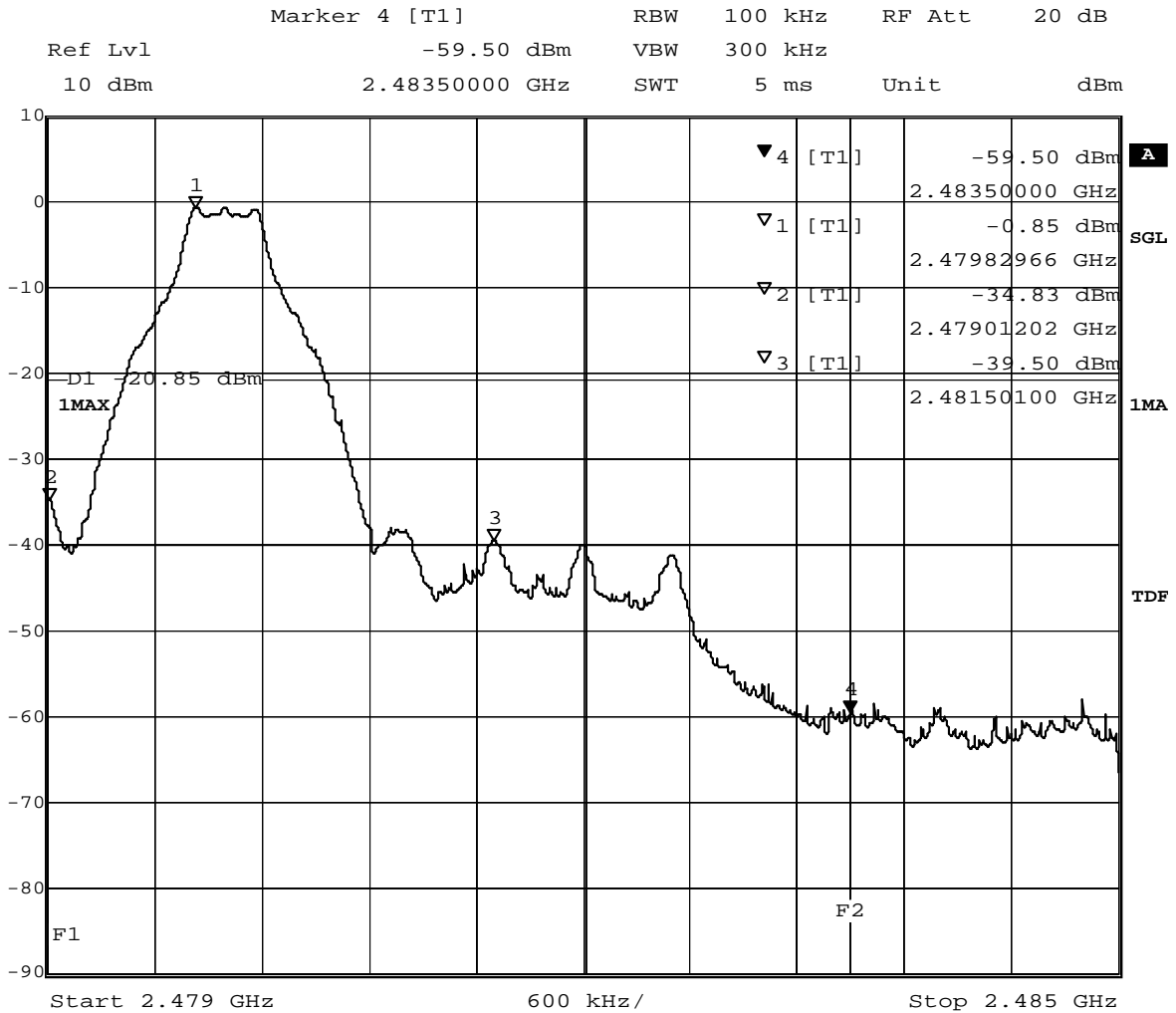

Title: Band Edge Compliance
 Comment A: CH T: 2480 MHz
 Date: 30.JUL.2008 10:04:11

(determination of reference value for spurious emissions measurement)



8.4.5 Spurious RF conducted emissions operating mode 3

Op. Mode

op-mode 3

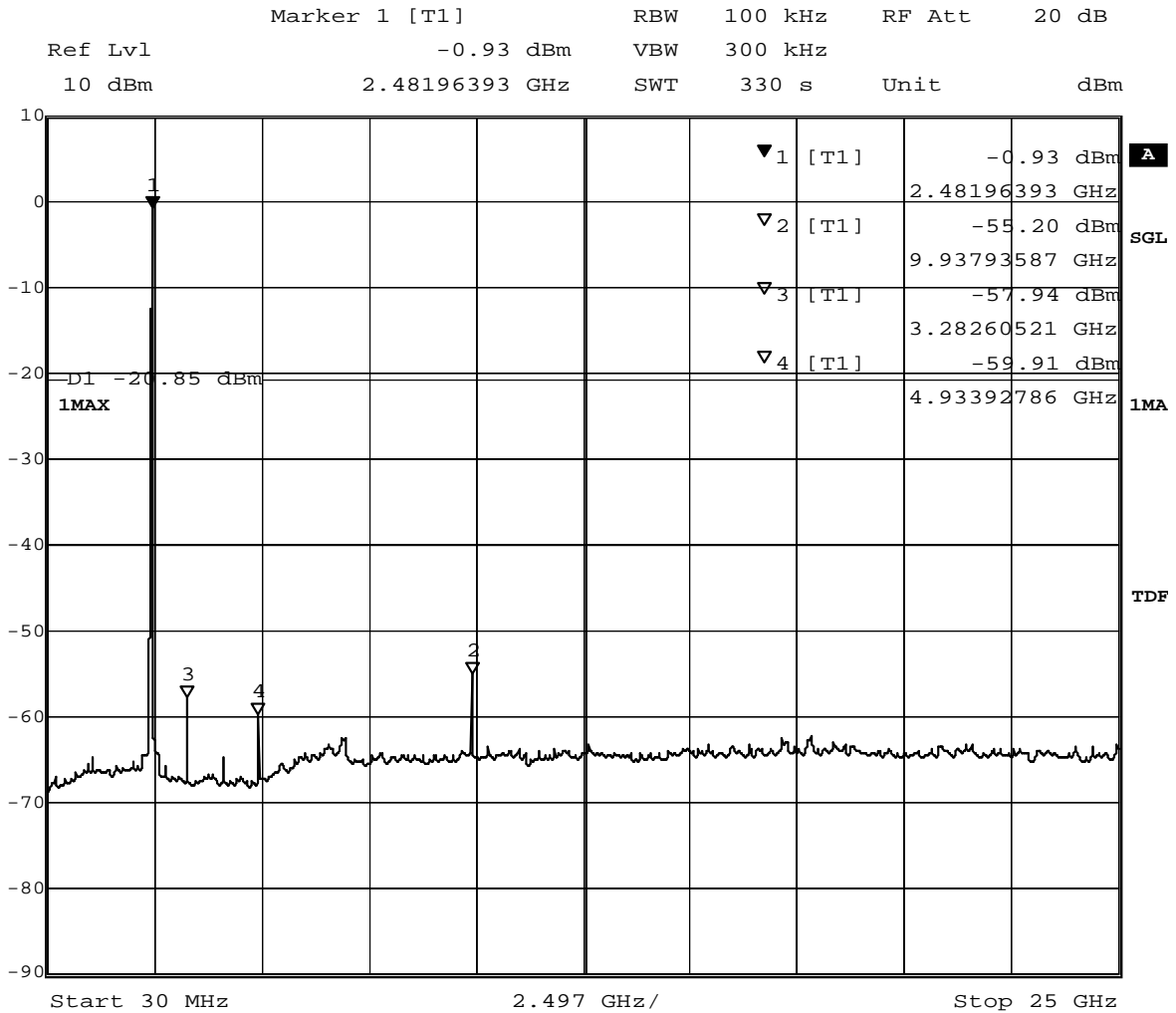

Title: spurious emissions
 Comment A: CH T: 2480 MHz
 Date: 30.JUL.2008 10:15:48

(spurious emissions measurement)



8.4.6 Band edge compliance conducted operating mode 4

Op. Mode

op-mode 4

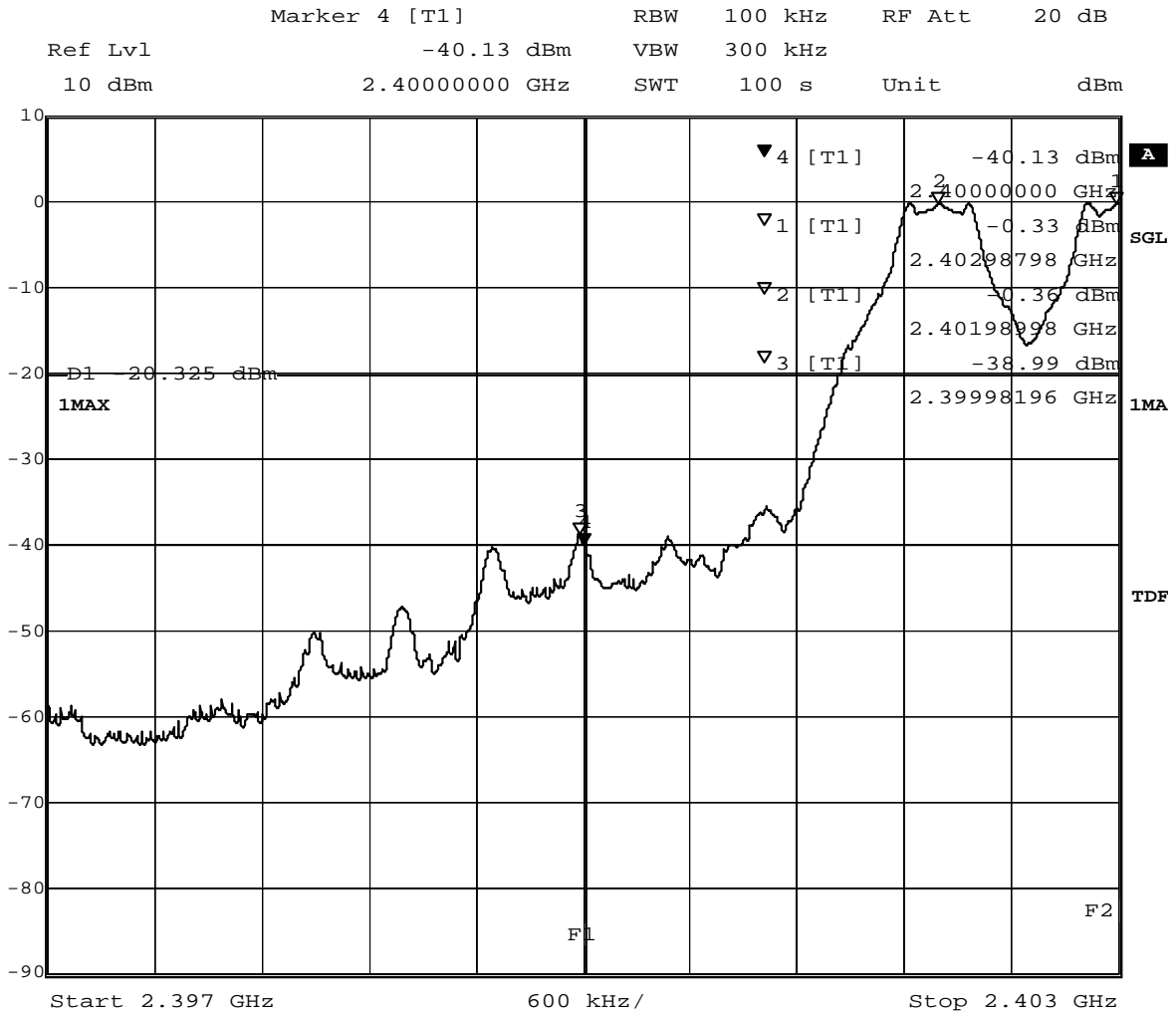

Title: Band Edge Compliance
 Comment A: CH B: 2402 MHz
 Date: 30.JUL.2008 11:20:45

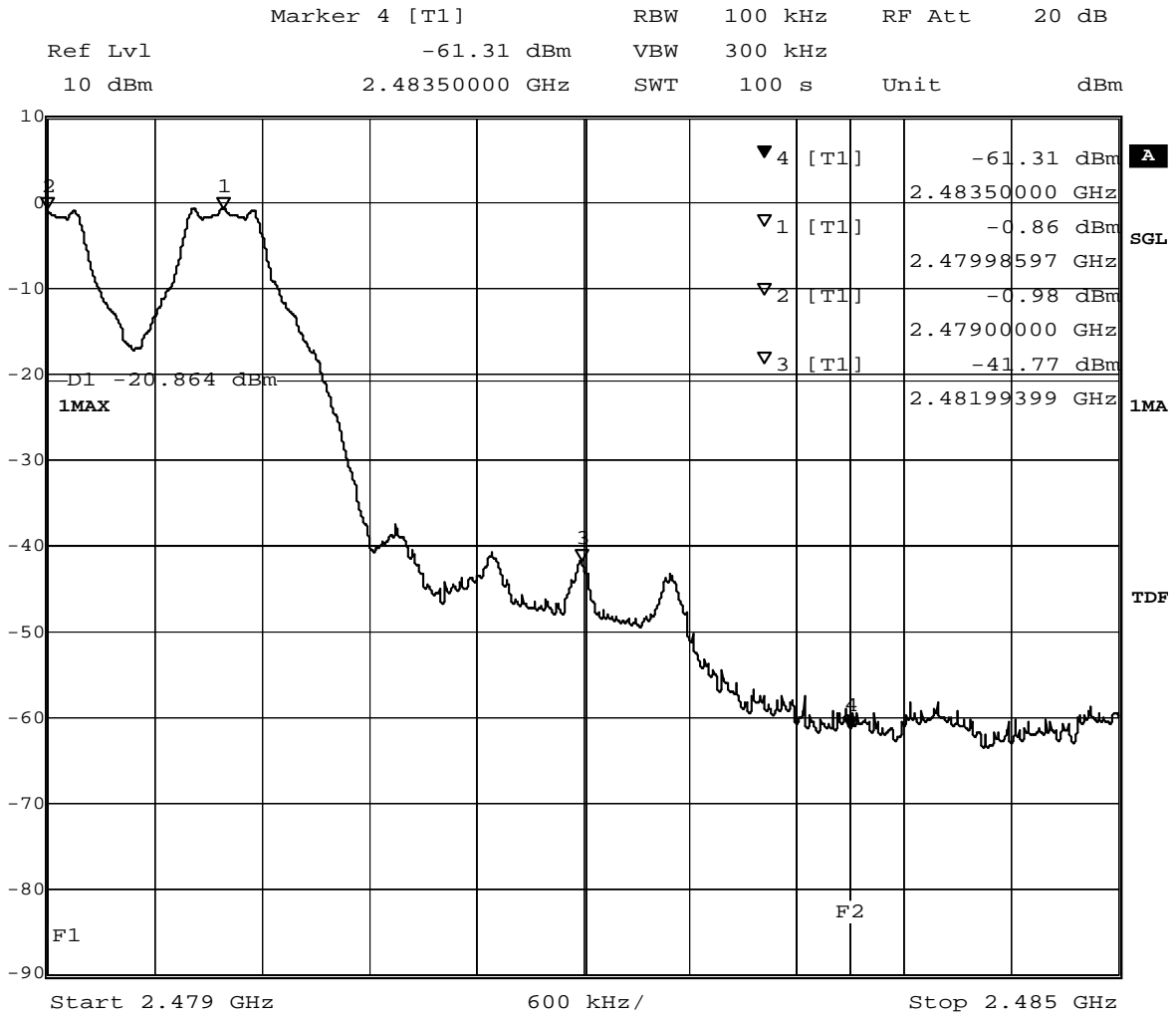

Title: Band Edge Compliance
 Comment A: CH T: 2480 MHz
 Date: 30.JUL.2008 11:25:43



8.4.7 Band edge compliance conducted operating mode 6

Op. Mode

op-mode 6

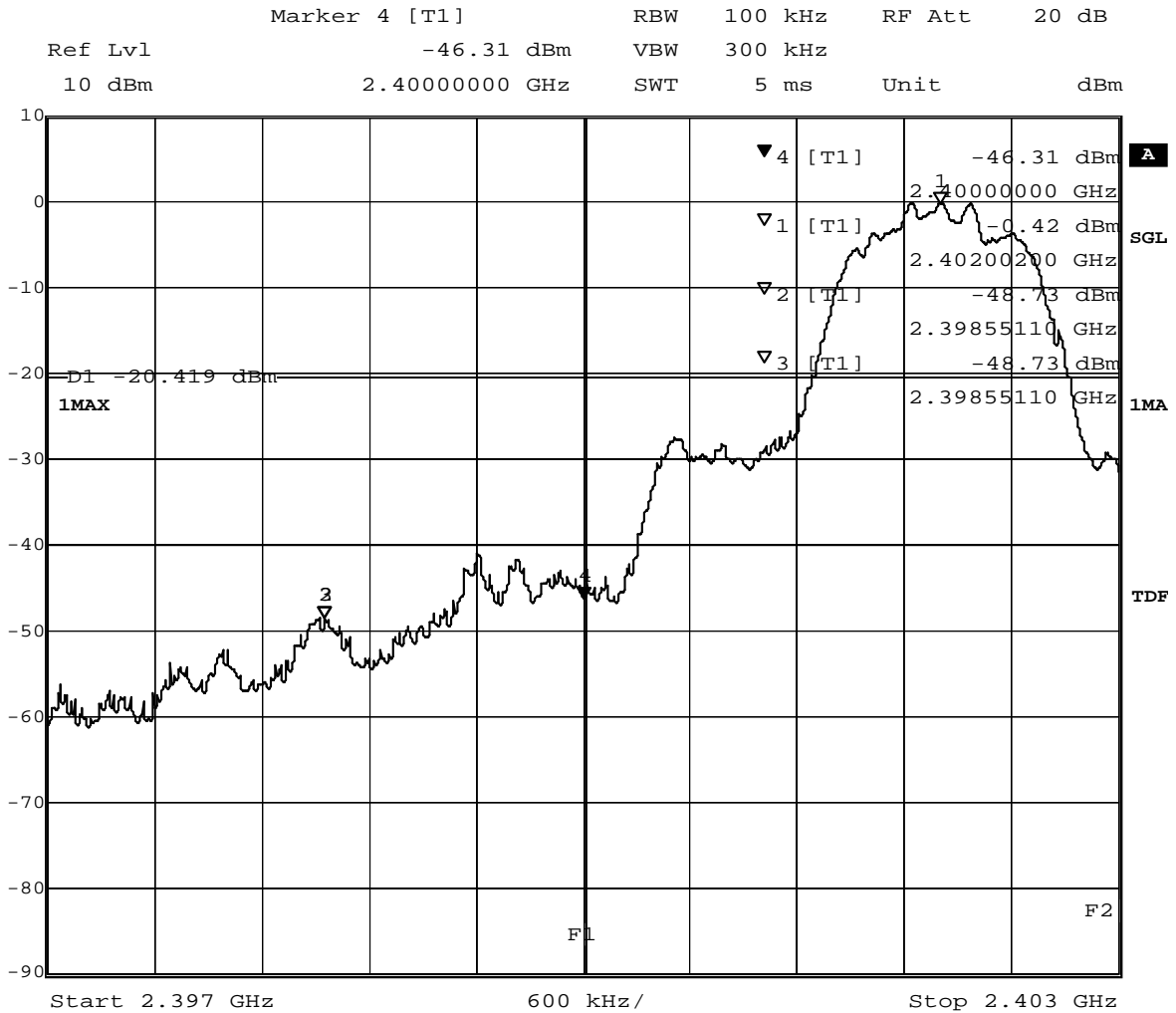

Title: Band Edge Compliance
 Comment A: CH B: 2402 MHz
 Date: 30.JUL.2008 08:56:44

(determination of reference value for spurious emissions measurement)



8.4.8 Spurious RF conducted emissions operating mode 6

Op. Mode

op-mode 6

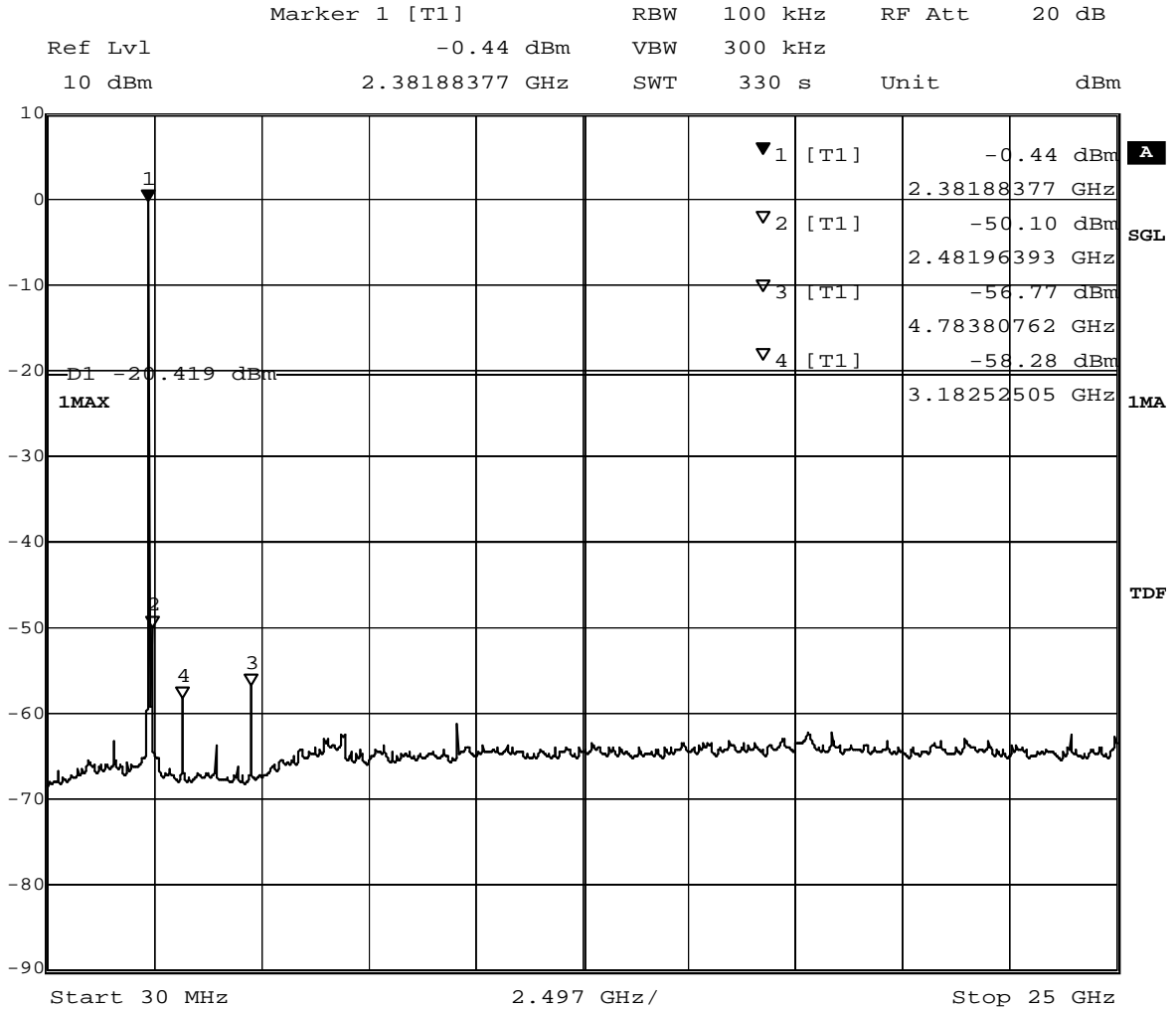

Title: spurious emissions
 Comment A: CH B: 2402 MHz
 Date: 30.JUL.2008 09:08:21

(spurious emissions measurement)

8.4.9 Spurious RF conducted emissions operating mode 7

Op. Mode

op-mode 7

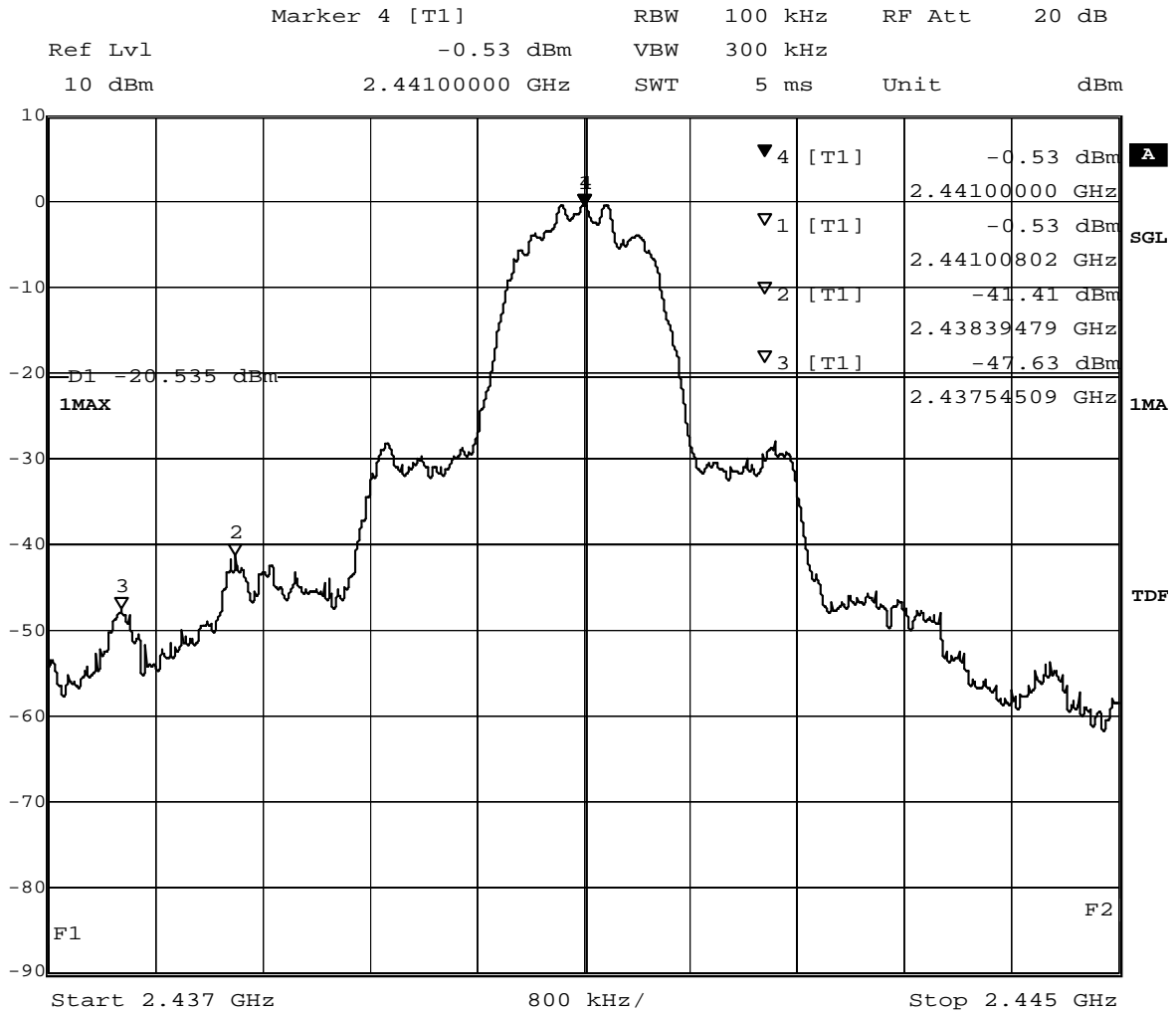

Title: Band Edge Compliance
 Comment A: CH M: 2441 MHz
 Date: 30.JUL.2008 09:47:51

(determination of reference value for spurious emissions measurement)

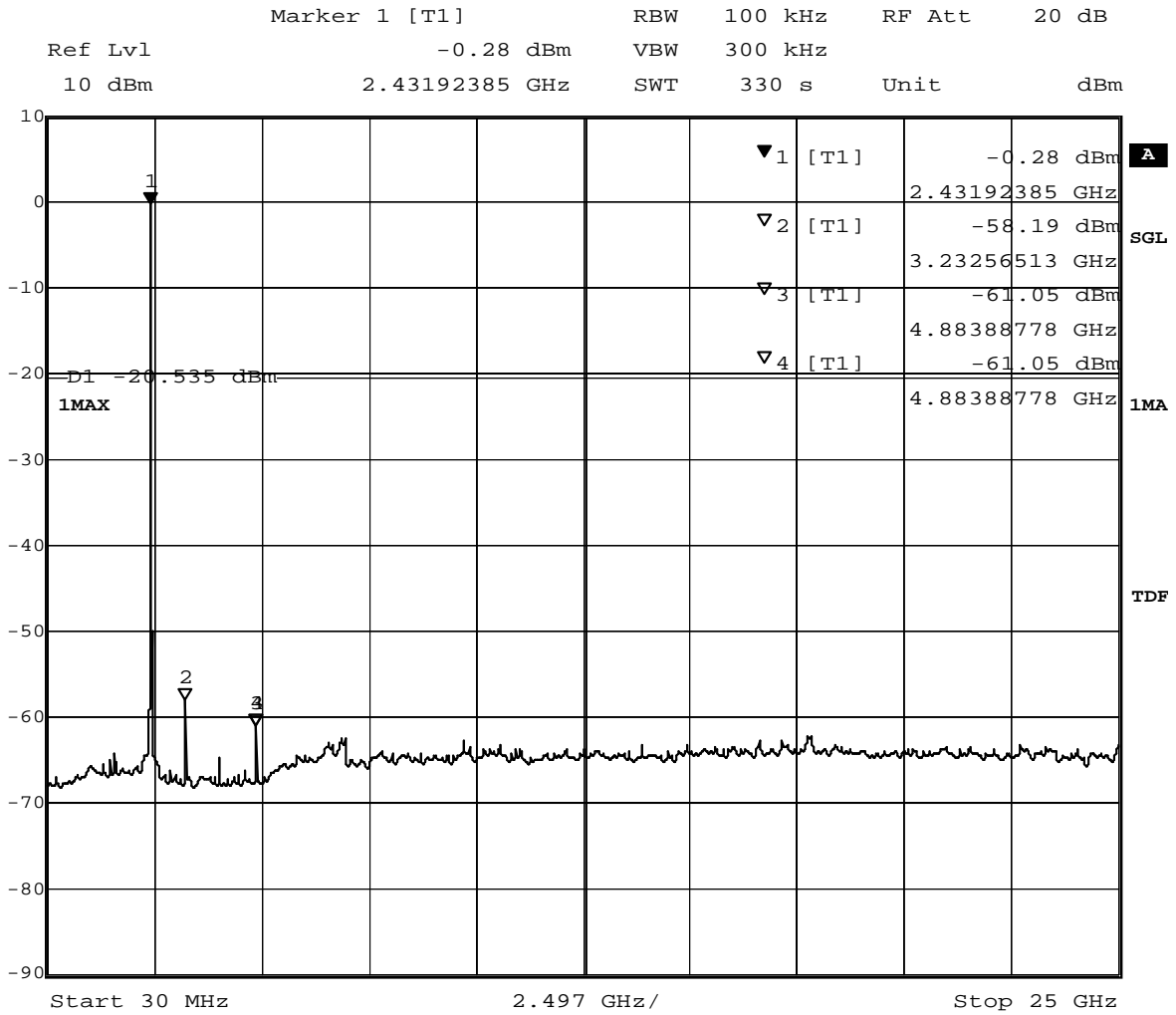

Title: spurious emissions
Comment A: CH M: 2441 MHz
Date: 30.JUL.2008 09:59:28

(spurious emissions measurement)

8.4.10 Band edge compliance conducted operating mode 8

Op. Mode

op-mode 8

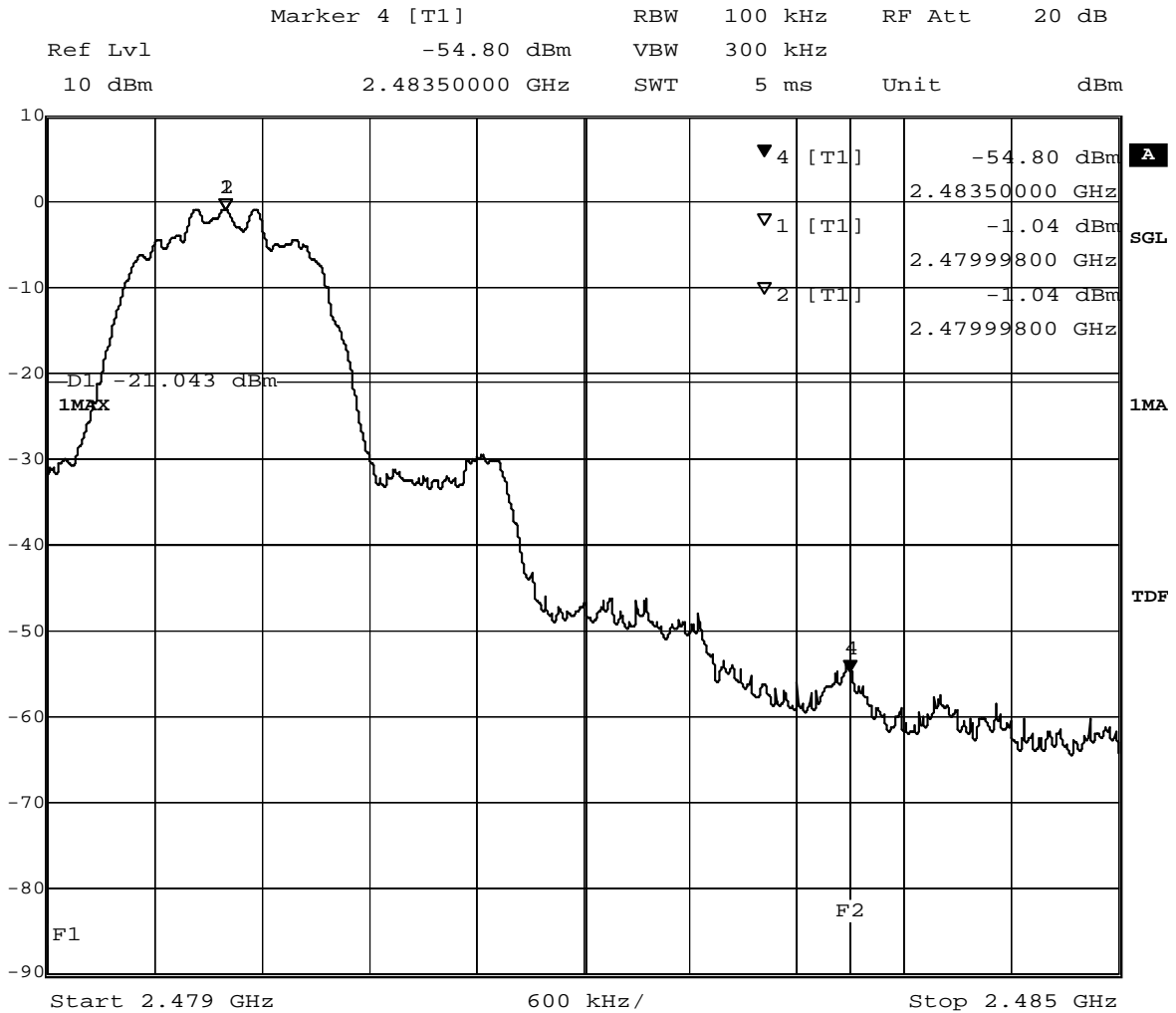

Title: Band Edge Compliance
 Comment A: CH T: 2480 MHz
 Date: 30.JUL.2008 10:38:45

(determination of reference value for spurious emissions measurement)



8.4.11 Spurious RF conducted emissions operating mode 8

Op. Mode

op-mode 8

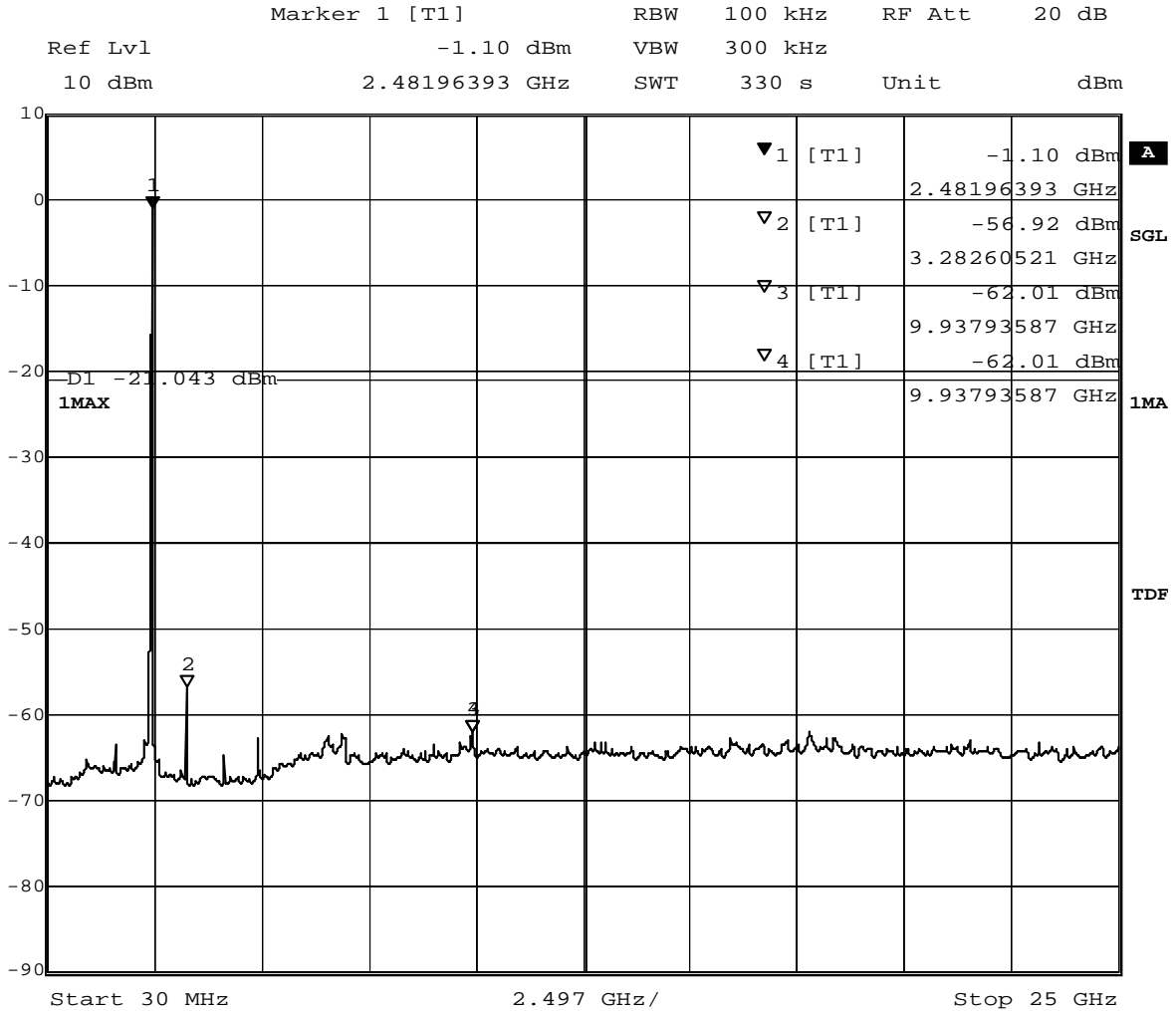

Title: spurious emissions
Comment A: CH T: 2480 MHz
Date: 30.JUL.2008 10:50:23

(spurious emissions measurement)



8.4.12 Band edge compliance conducted operating mode 9

Op. Mode

op-mode 9

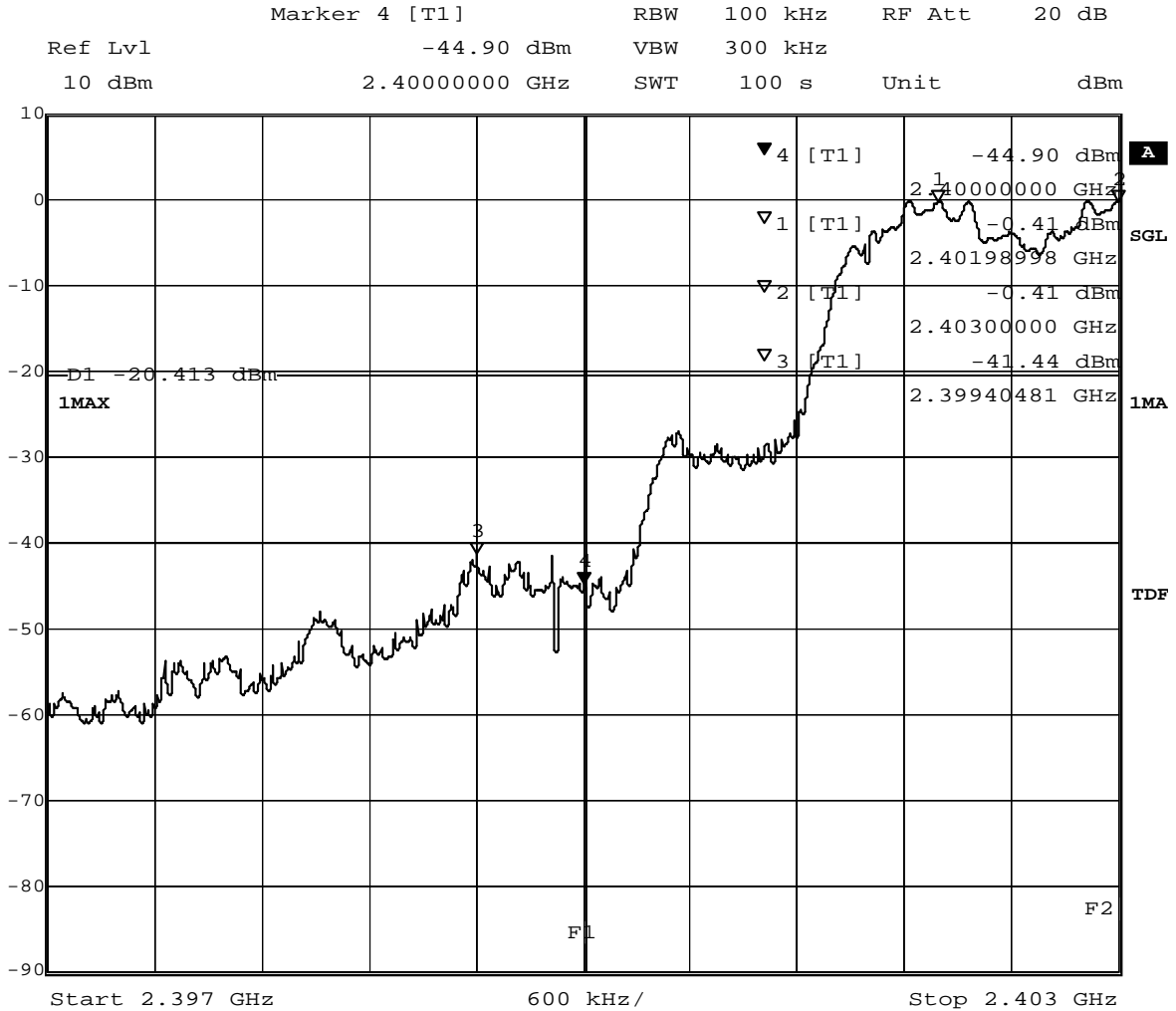

Title: Band Edge Compliance
 Comment A: CH B: 2402 MHz
 Date: 30.JUL.2008 12:12:51

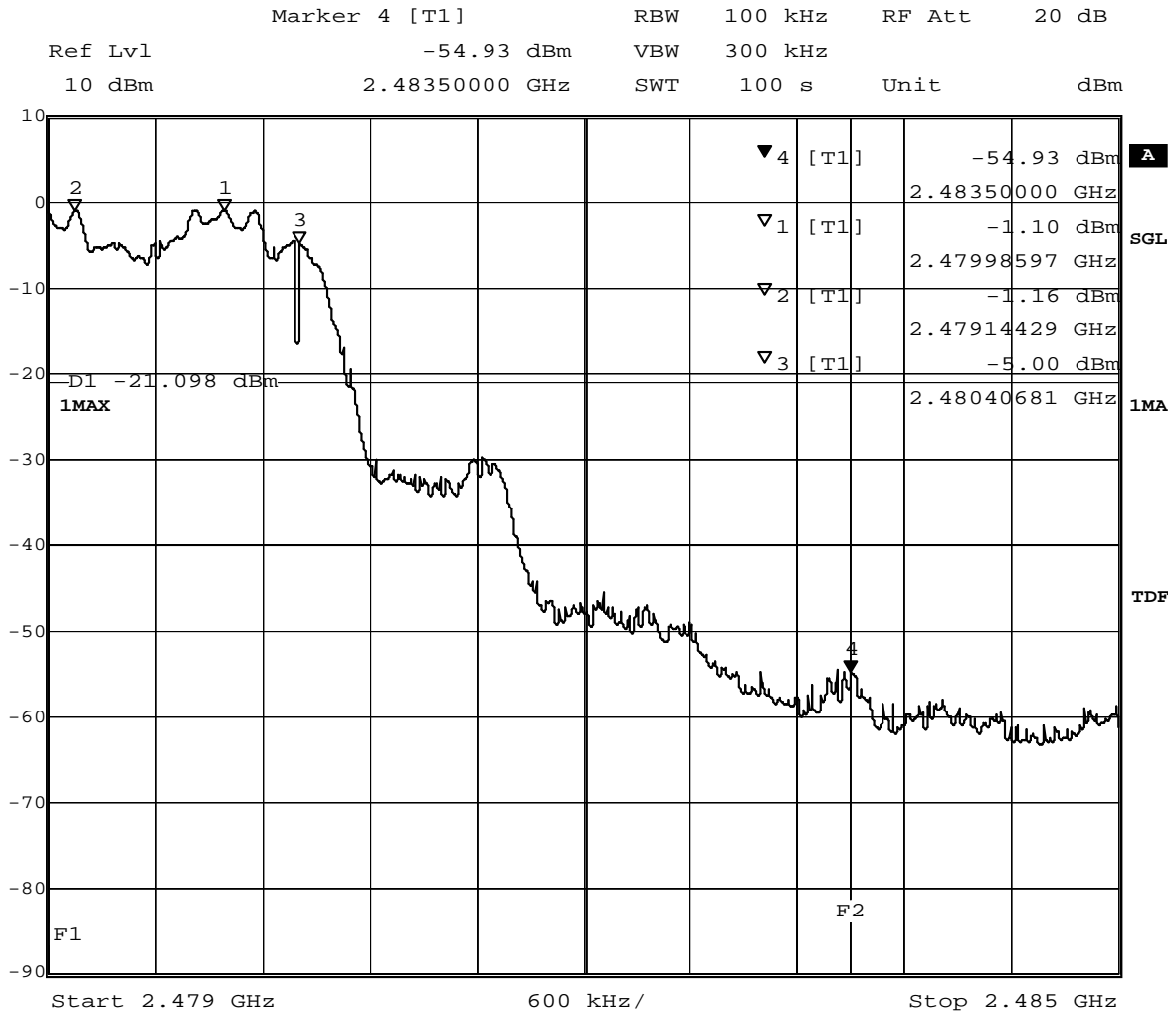

Title: Band Edge Compliance
 Comment A: CH T: 2480 MHz
 Date: 30.JUL.2008 12:20:17



8.4.13 Band edge compliance conducted operating mode 10

Op. Mode

op-mode 10

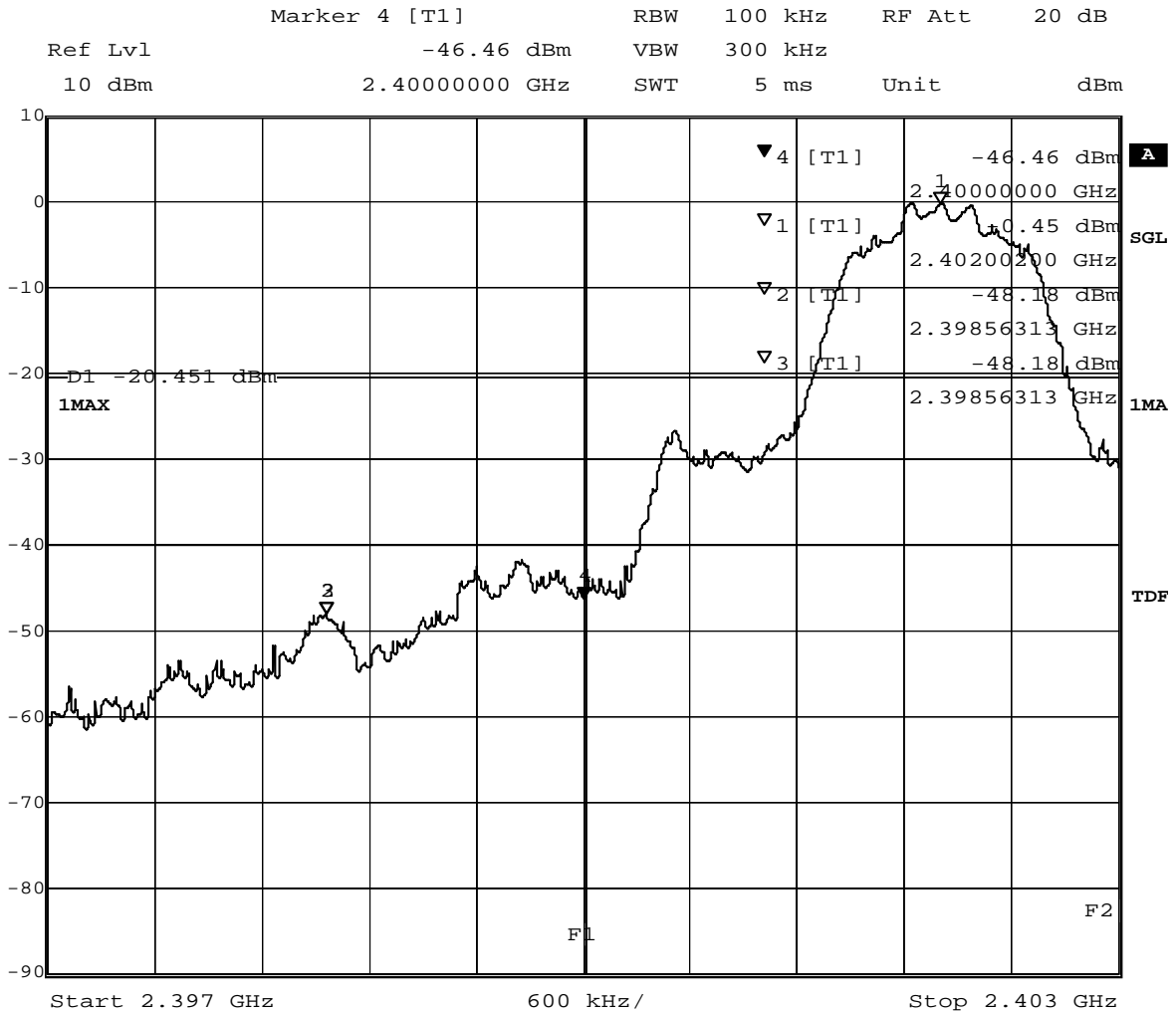

Title: Band Edge Compliance
 Comment A: CH B: 2402 MHz
 Date: 30.JUL.2008 08:38:19

(determination of reference value for spurious emissions measurement)



8.4.14 Spurious RF conducted emissions operating mode 10

Op. Mode

op-mode 10

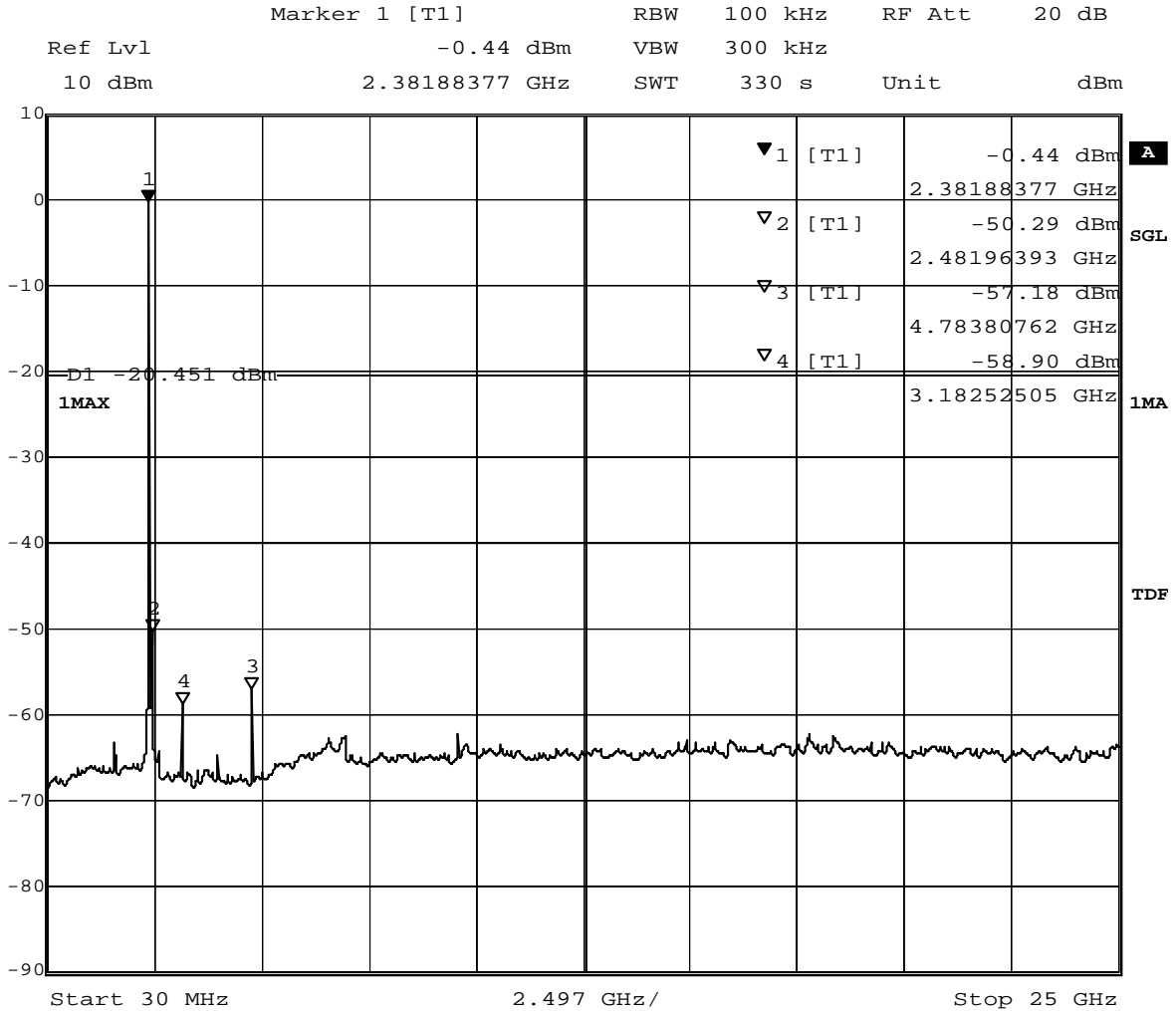

Title: spurious emissions
 Comment A: CH B: 2402 MHz
 Date: 30.JUL.2008 08:49:56

(spurious emissions measurement)



8.4.15 Band edge compliance conducted operating mode 11

Op. Mode

op-mode 11

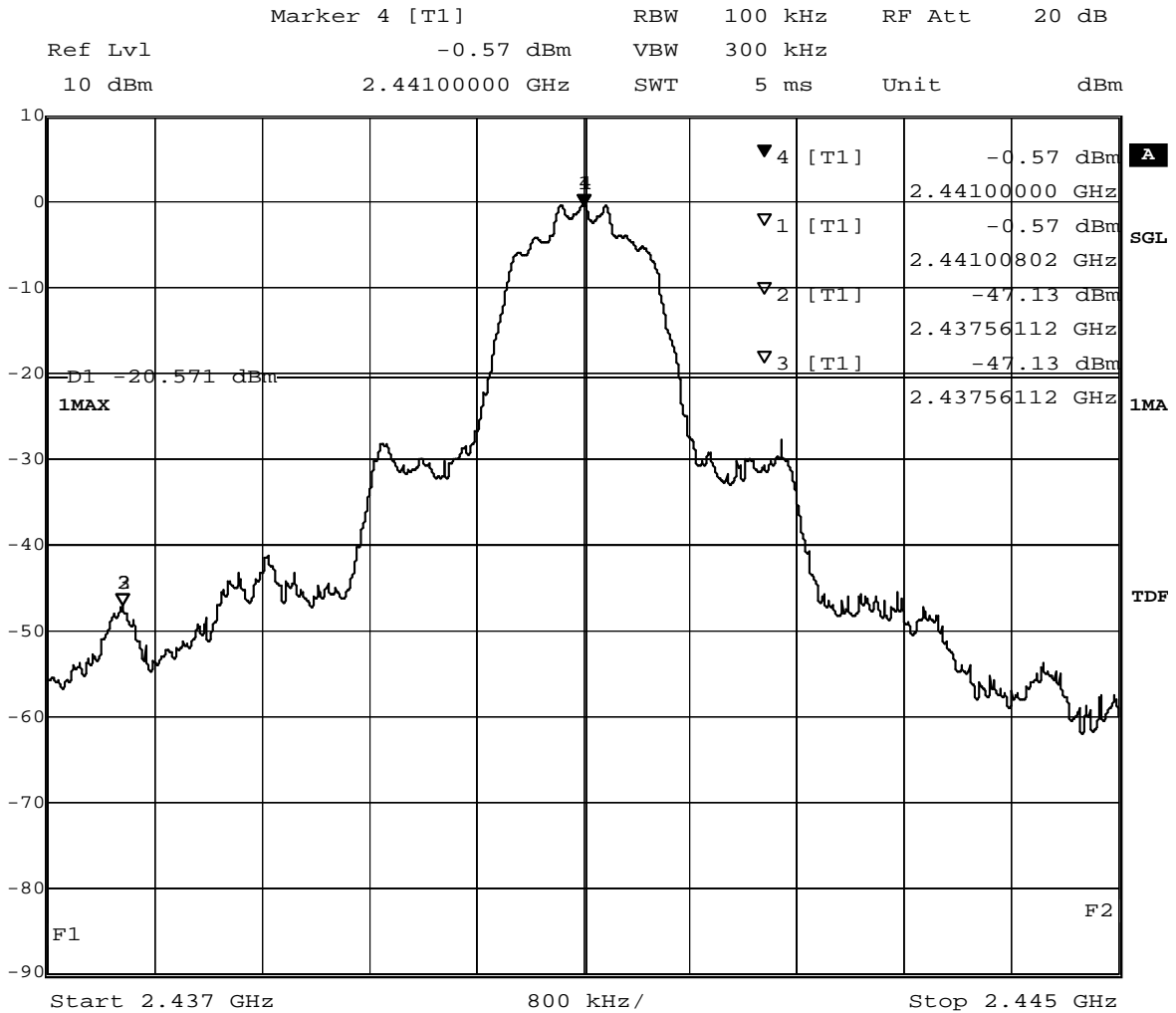

Title: Band Edge Compliance
 Comment A: CH M: 2441 MHz
 Date: 30.JUL.2008 09:31:33

(determination of reference value for spurious emissions measurement)

8.4.17 Band edge compliance conducted operating mode 12

Op. Mode

op-mode 12

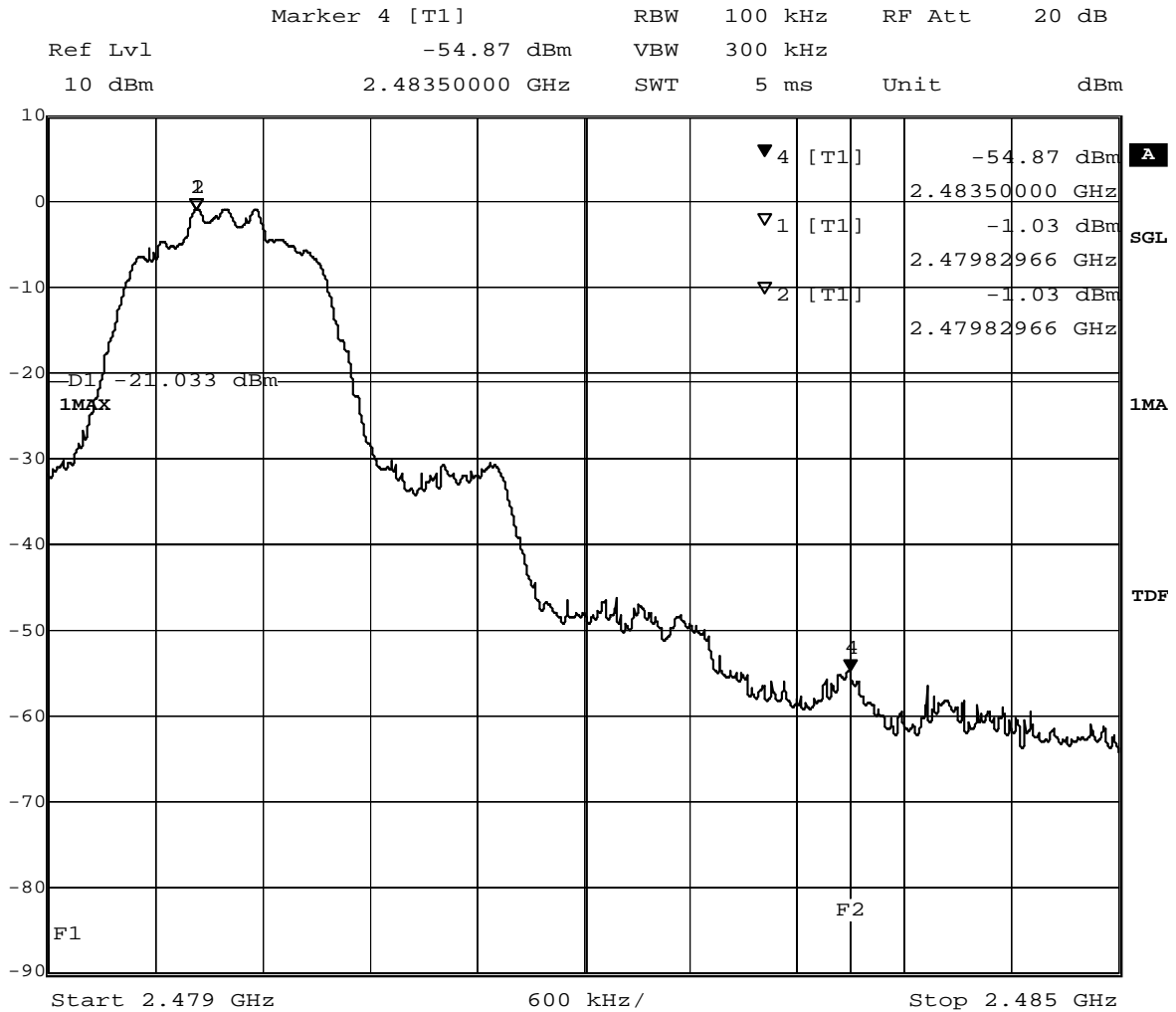

Title: Band Edge Compliance
 Comment A: CH T: 2480 MHz
 Date: 30.JUL.2008 10:21:14

(determination of reference value for spurious emissions measurement)



8.4.18 Spurious RF conducted emissions operating mode 12

Op. Mode

op-mode 12

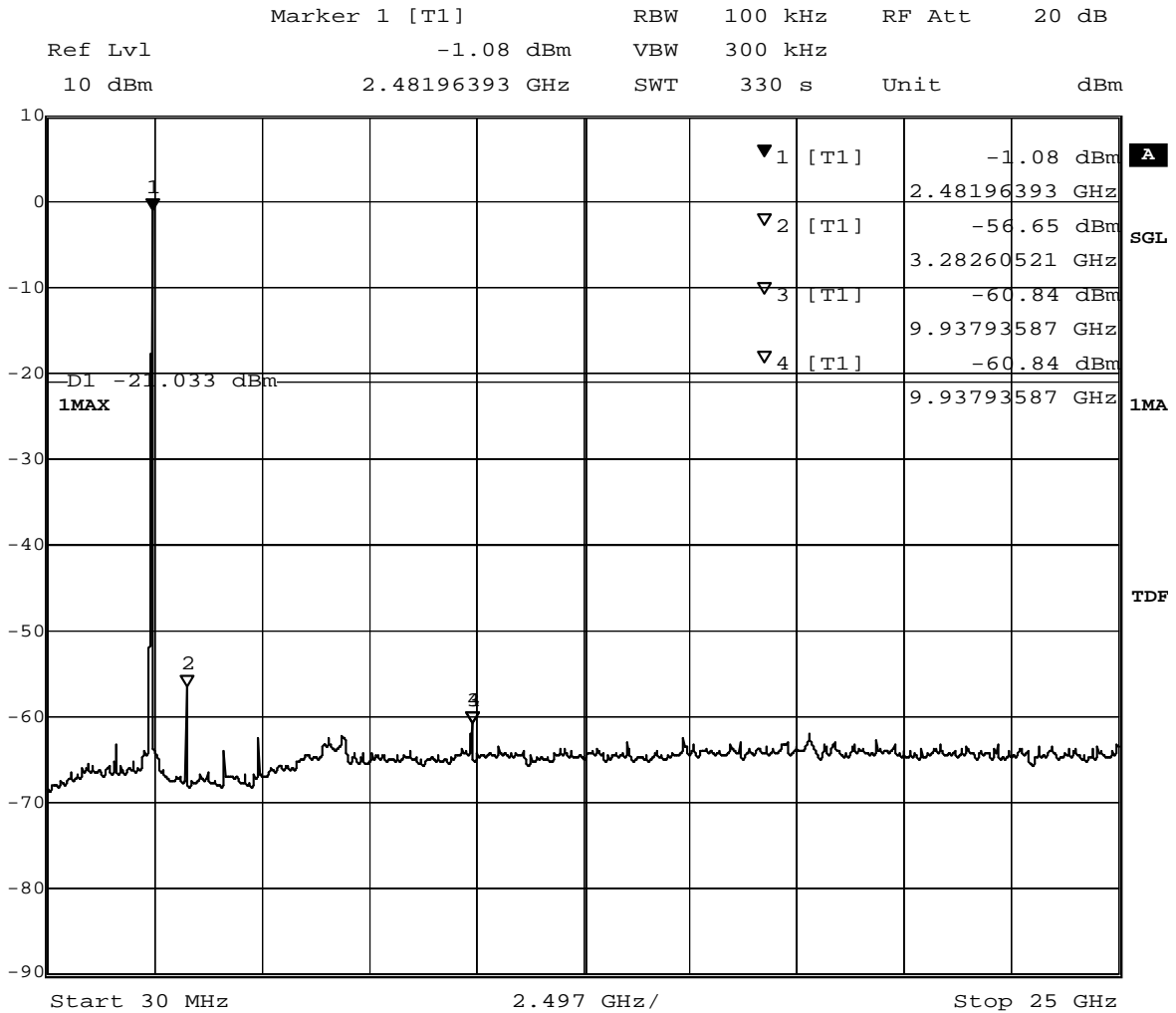

Title: spurious emissions
 Comment A: CH T: 2480 MHz
 Date: 30.JUL.2008 10:32:51

(spurious emissions measurement)



8.4.19 Band edge compliance conducted operating mode 13

Op. Mode

op-mode 13

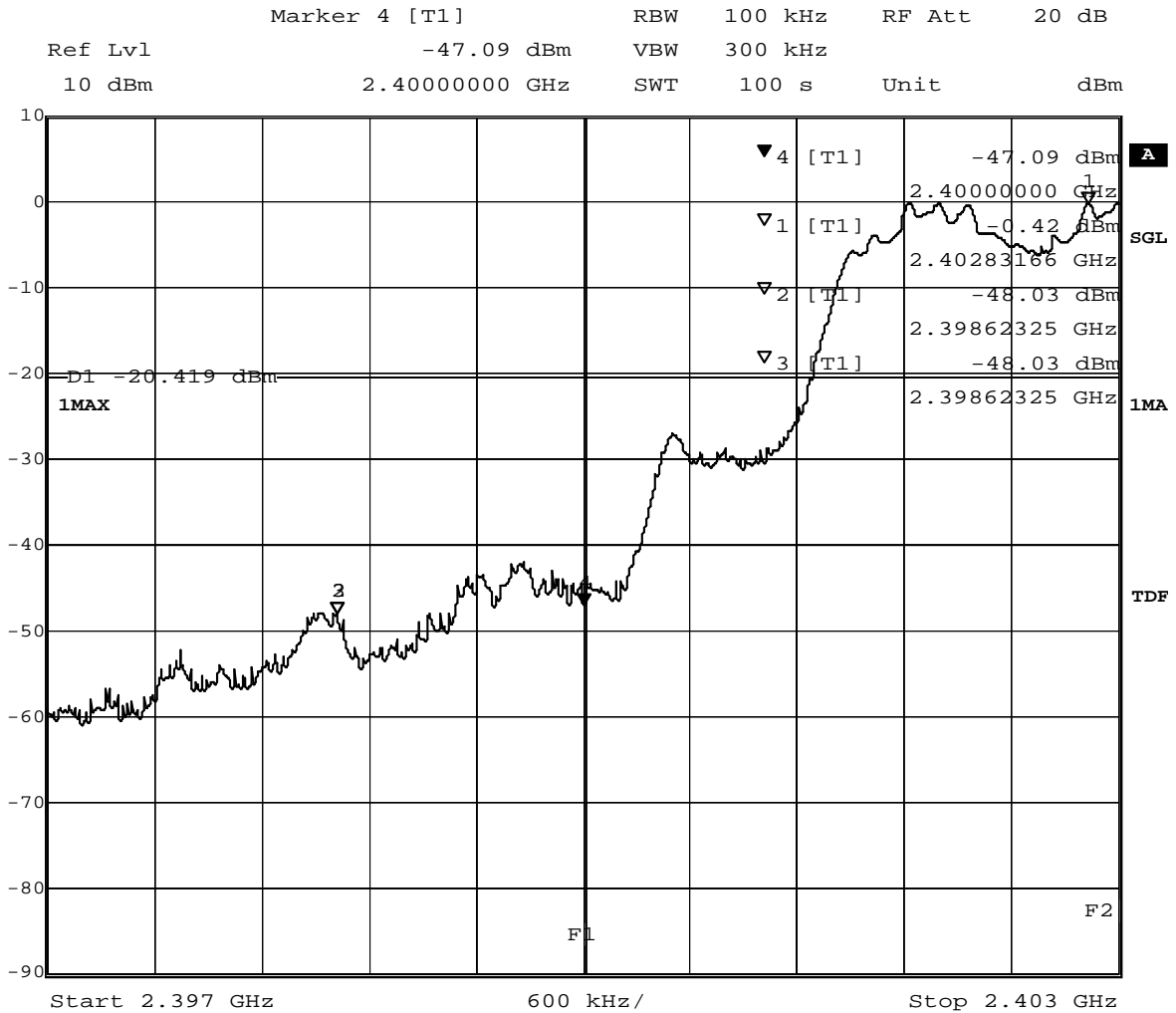

Title: Band Edge Compliance
 Comment A: CH B: 2402 MHz
 Date: 30.JUL.2008 11:39:26

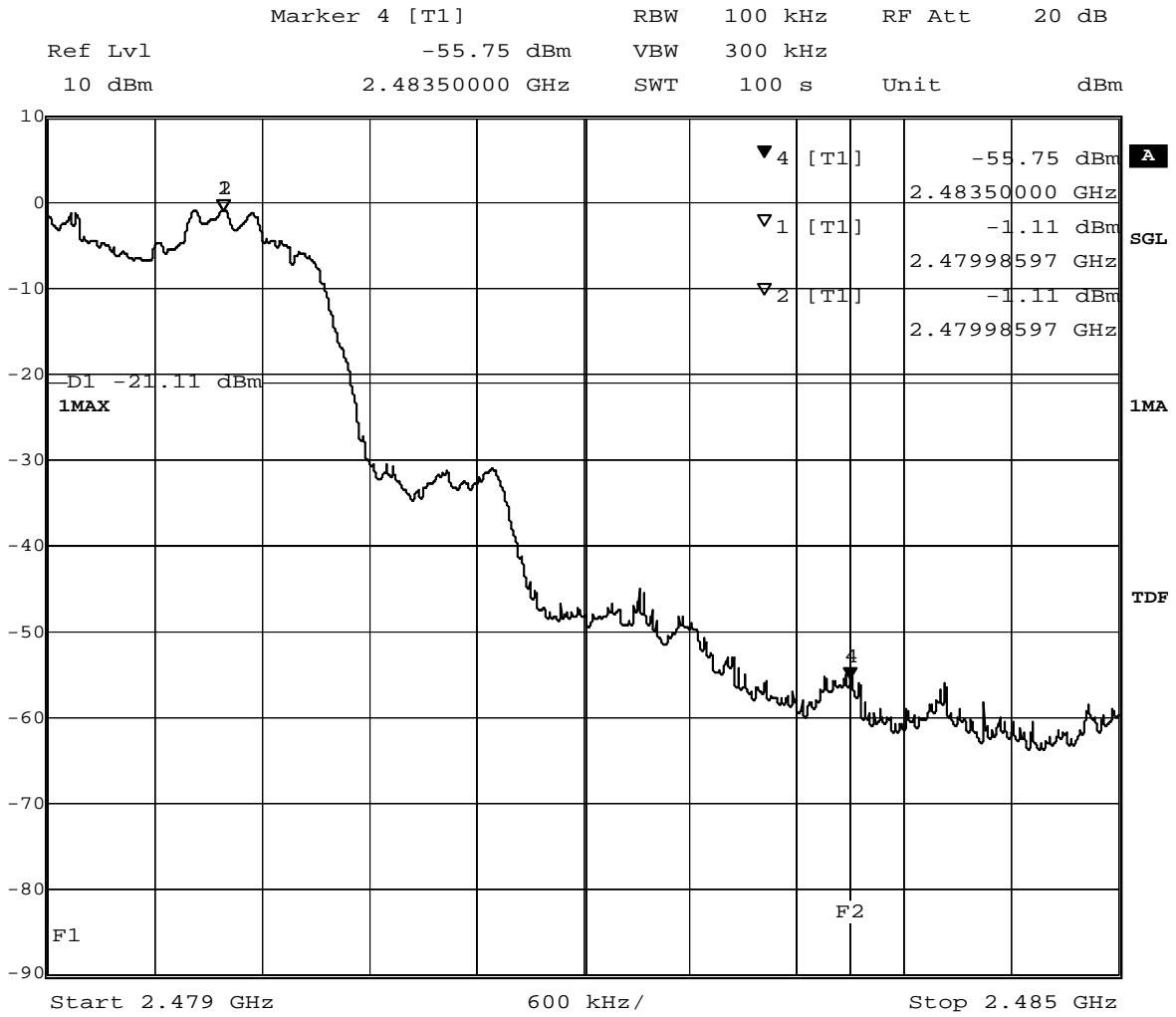

Title: Band Edge Compliance
 Comment A: CH T: 2480 MHz
 Date: 30.JUL.2008 11:43:46

8.5 Band edge compliance radiated

8.5.1 Band edge compliance radiated operating mode 3

Op. Mode

op-mode 3

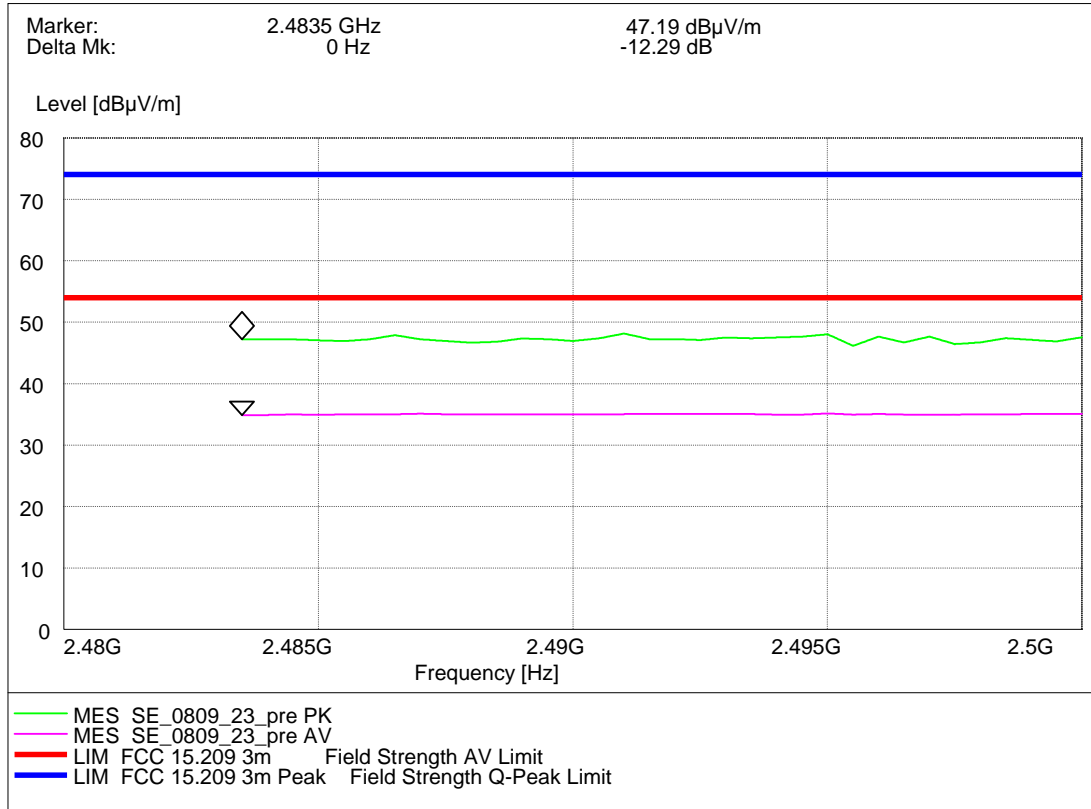

Radiated measurement (higher band edge)

8.5.2 Band edge compliance radiated operating mode 8

Op. Mode

op-mode 8

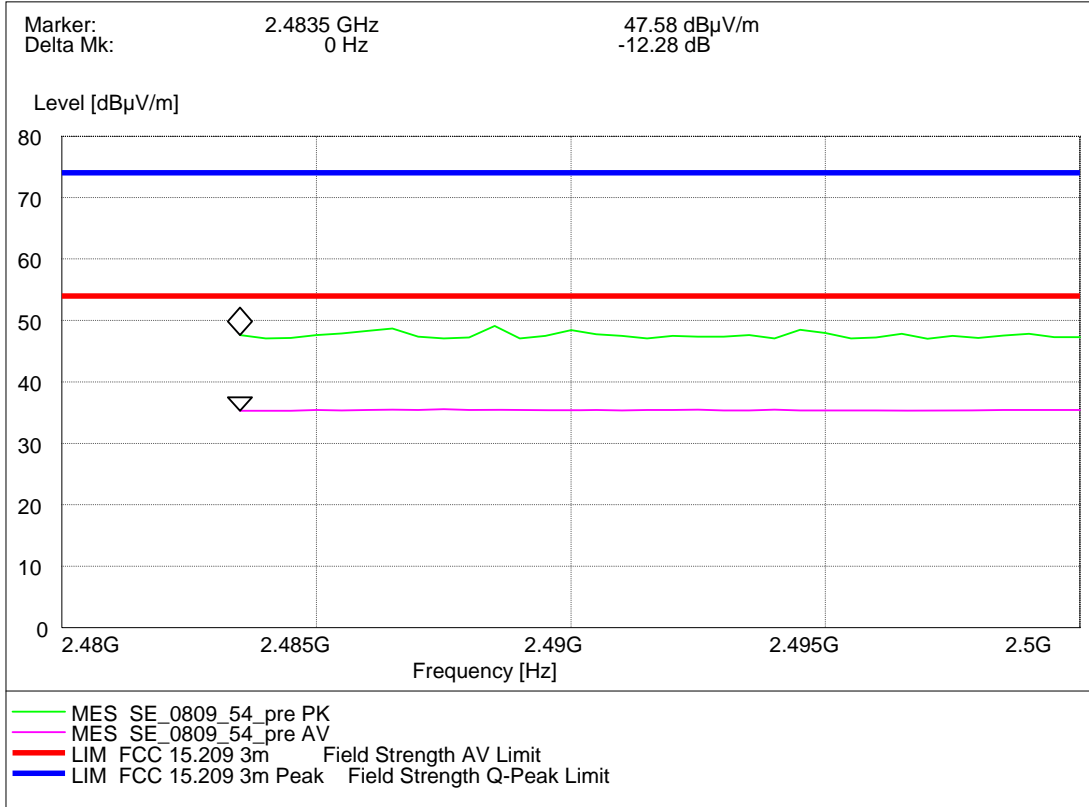

Radiated measurement (higher band edge)

8.5.3 Band edge compliance radiated operating mode 12

Op. Mode

op-mode 12

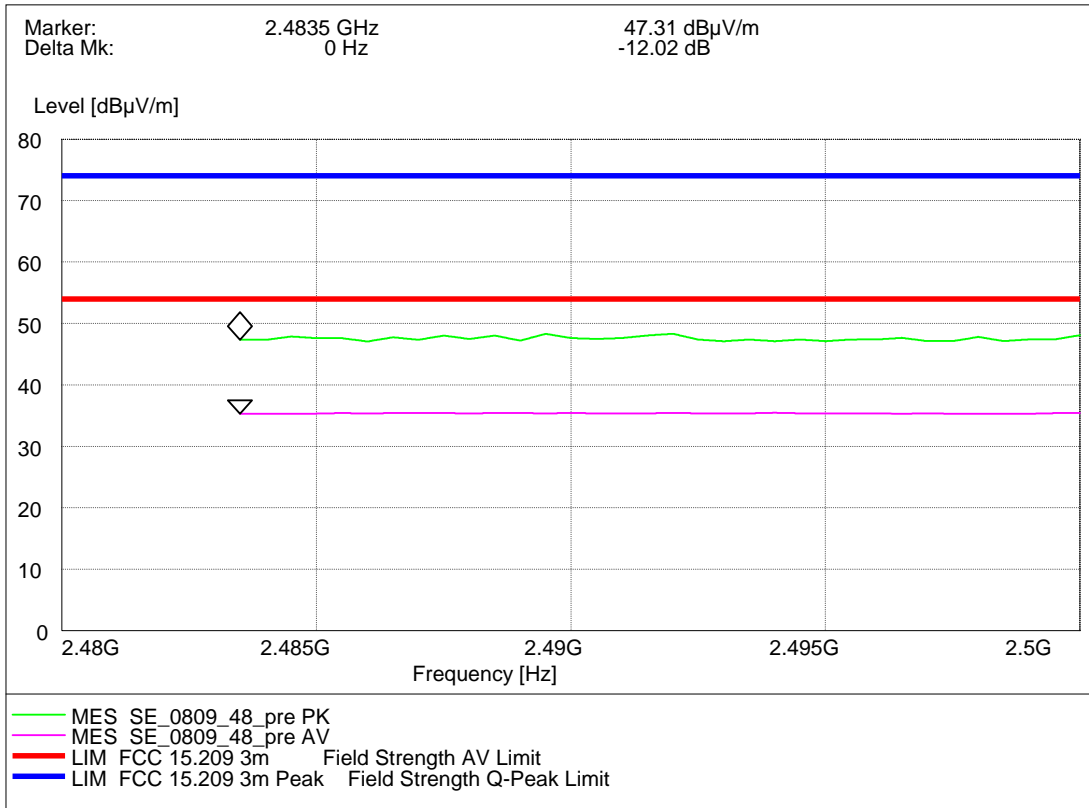

Radiated measurement (higher band edge)

8.6 Radiated emissions (f<30MHz)

Op. Mode

op-mode 1

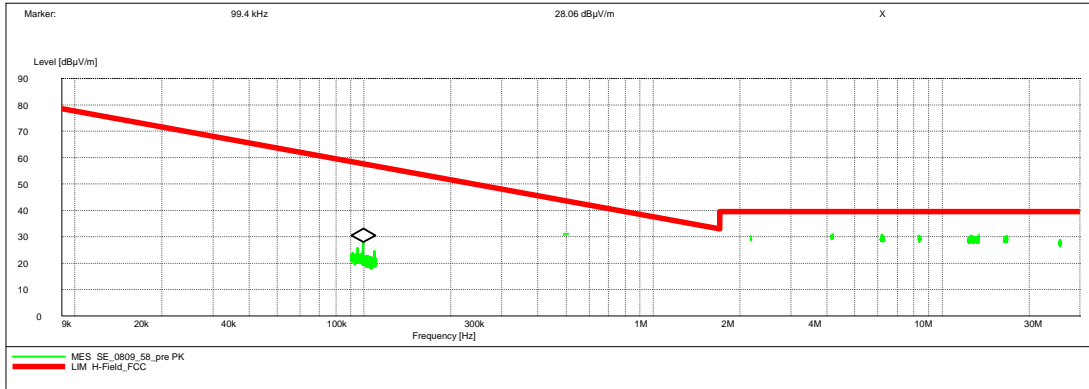

Antenna position 90°
EUT position front side

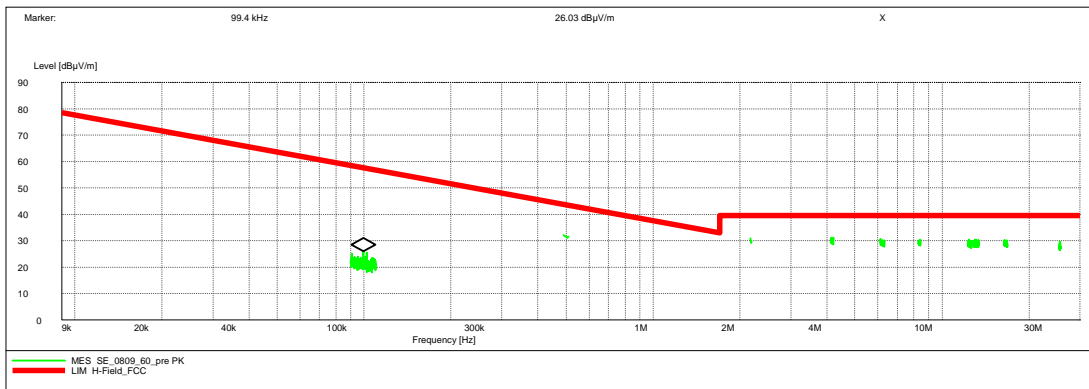

Antenna position 90°
EUT position right side

Op. Mode

op-mode 1

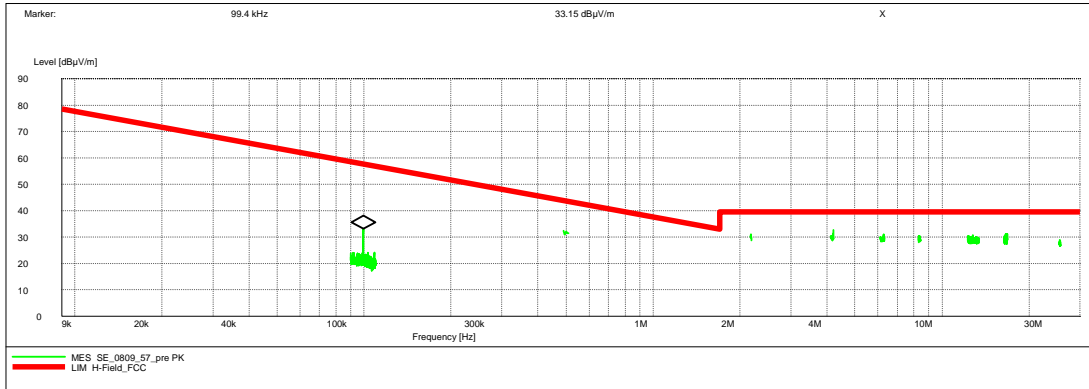

Antenna position 0°
EUT position front side

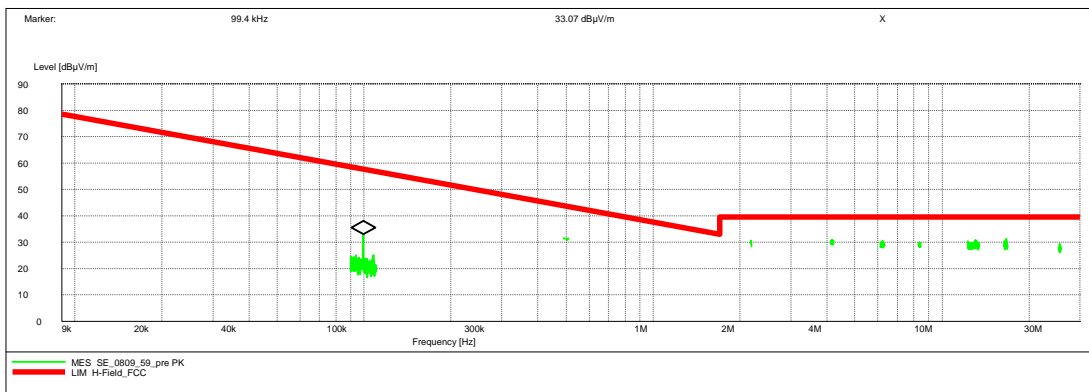

Antenna position 0°
EUT position right side

8.7 Spurious radiated emissions (f > 30MHz)

Op. Mode

op-mode 1

EUT: DEA-0002007 (13210b01) / 2008-07-29
 Manufacturer: Sony-Ericsson
 Operating Condition: TX on 2402 MHz, max. power, 1-DH1
 Test Site: 7 layers Ratingen
 Operator: Groe
 Test Specification: FCC 15.247 (15.35b, 15.209)
 Comment: vertical + horizontal antenna polarization

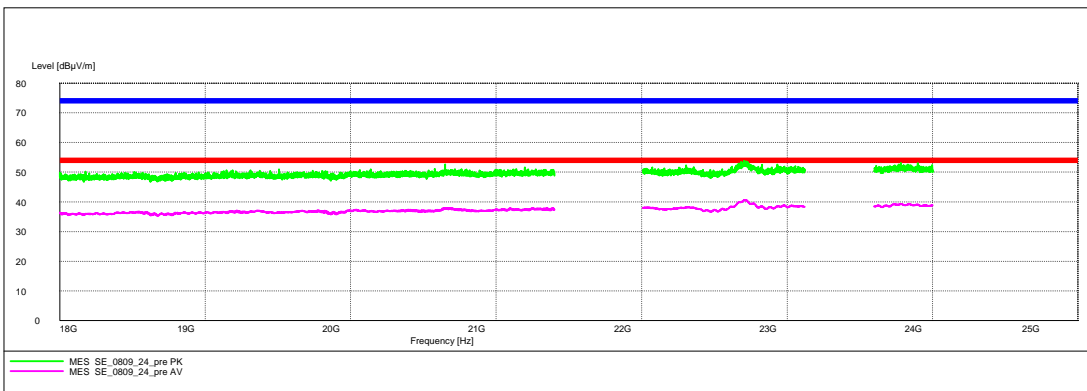
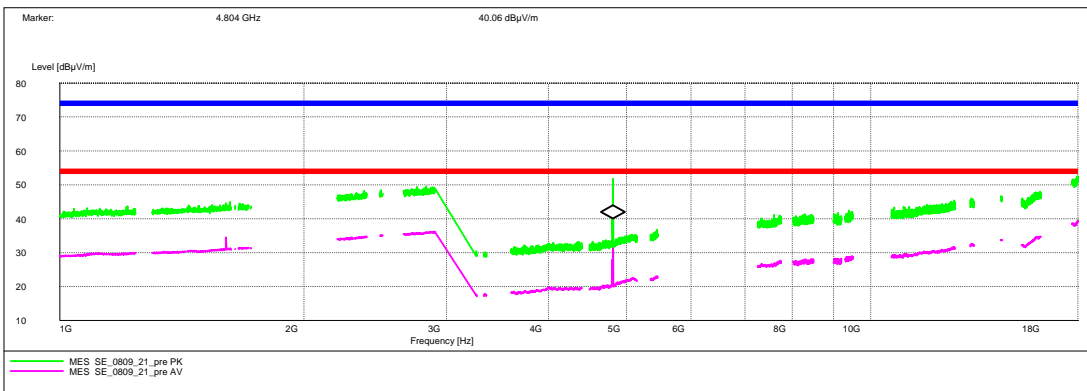
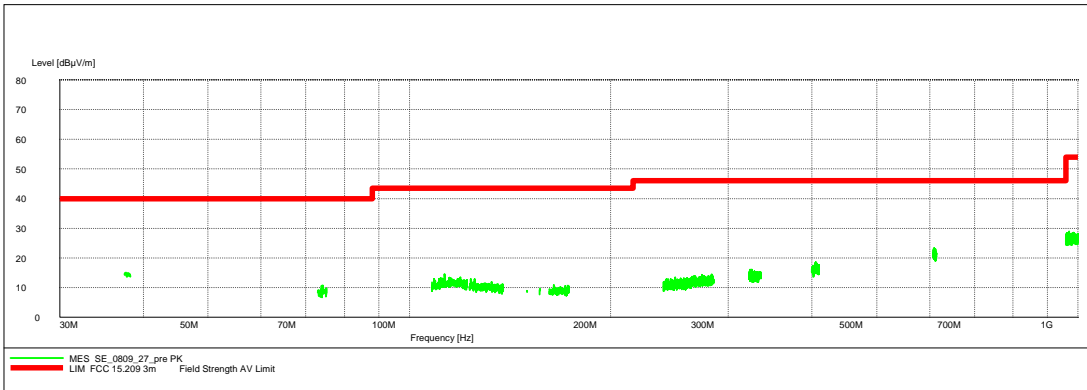

Op. Mode

op-mode 2

EUT: DEA-0002007 (13210b01) / 2008-07-29
 Manufacturer: Sony-Ericsson
 Operating Condition: TX on 2441 MHz, max. power, 1-DH1
 Test Site: 7 layers Ratingen
 Operator: Groe
 Test Specification: FCC 15.247 (15.35b, 15.209)
 Comment: vertical + horizontal antenna polarization

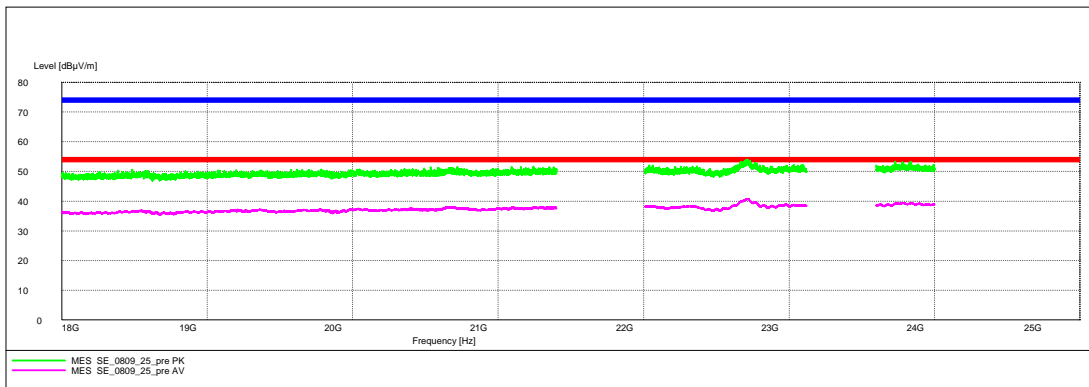
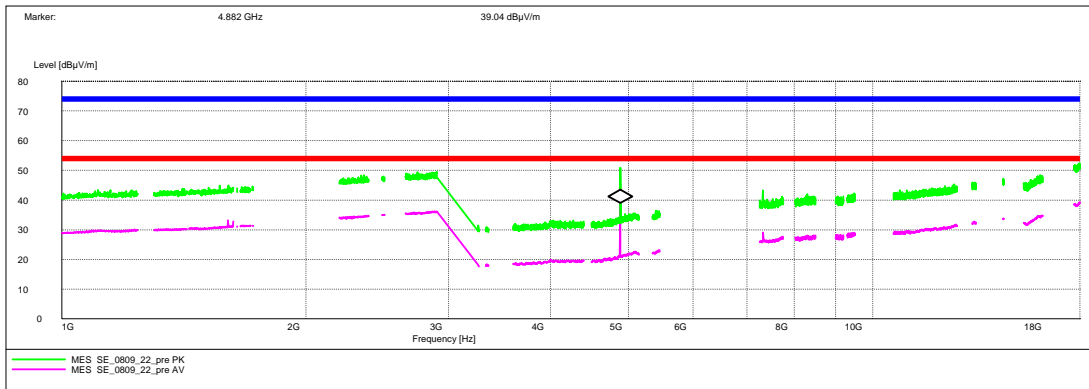
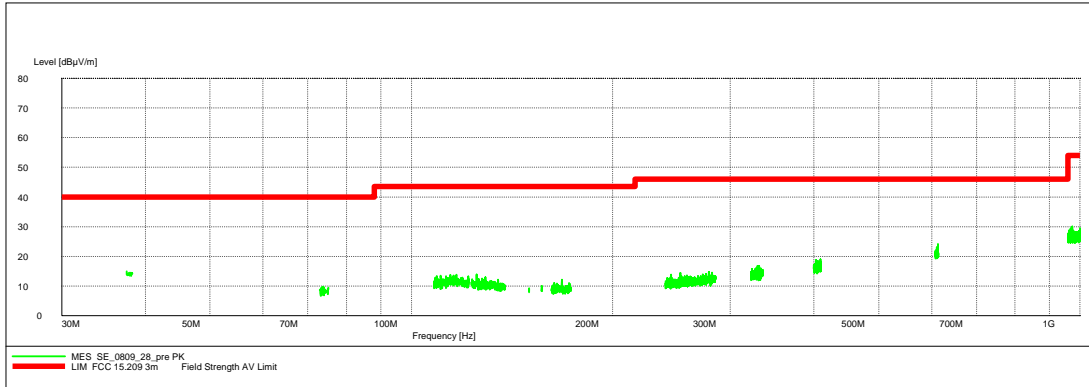

Op. Mode

op-mode 3

EUT: DEA-0002007 (13210b01) / 2008-07-29
 Manufacturer: Sony-Ericsson
 Operating Condition: TX on 2480 MHz, max. power, 1-DH1
 Test Site: 7 layers Ratingen
 Operator: Groe
 Test Specification: FCC 15.247 (15.35b, 15.209)
 Comment: vertical + horizontal antenna polarization

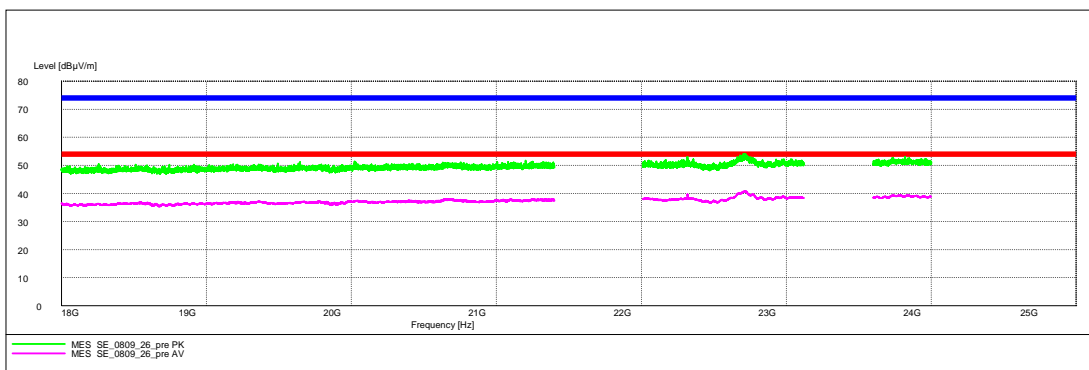
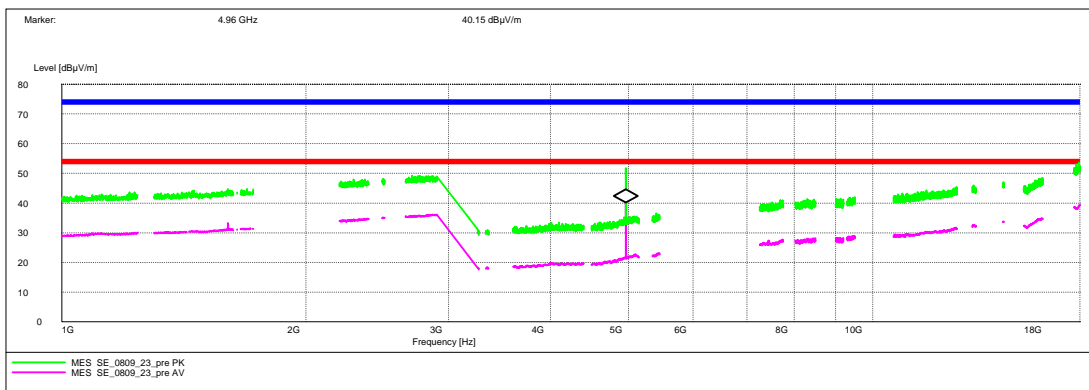
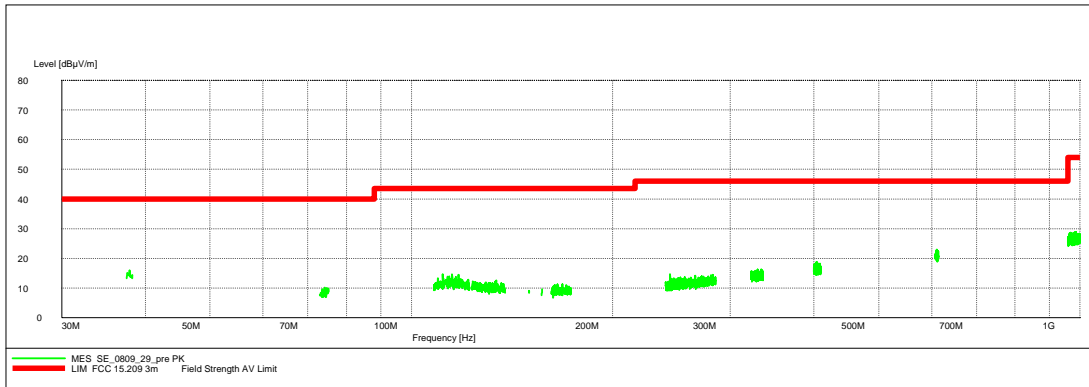



Op. Mode

op-mode 6

EUT: DEA-0002007 (13210b01) / 2008-07-29
Manufacturer: Sony Ericsson
Operating Condition: TX on 2402 MHz,; max. power, 3-DH1
Test Site: 7 layers Ratingen
Operator: Suna
Test Specification: FCC 15.247 (15.35b, 15.209)
Comment: vertical + horizontal antenna polarization

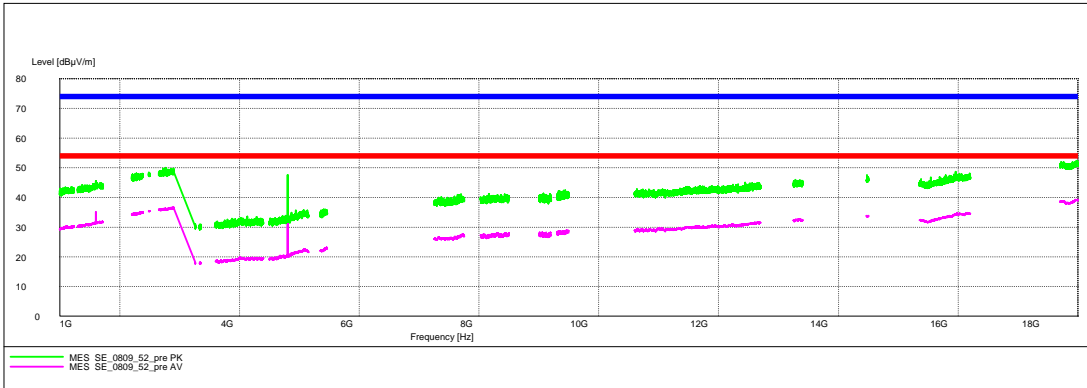

Op. Mode

op-mode 7

EUT: DEA-0002007 (13210b01) / 2008-07-29
Manufacturer: Sony Ericsson
Operating Condition: TX on 2441 MHz, max. power, 3-DH1
Test Site: 7 layers Ratingen
Operator: Suna
Test Specification: FCC 15.247 (15.35b, 15.209)
Comment: vertical + horizontal antenna polarisation

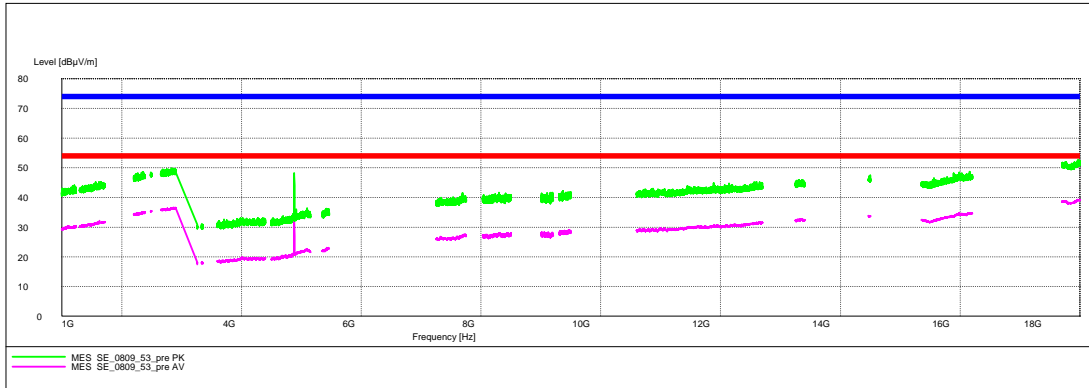

Op. Mode

op-mode 8

EUT: DEA-0002007 (13210b01) / 2008-07-29
Manufacturer: Sony Ericsson
Operating Condition: TX on 2480 MHz, max. power, 3-DH1, BAT2
Test Site: 7 layers Ratingen
Operator: Suna
Test Specification: FCC 15.247 (15.35b, 15.209)
Comment: vertical + horizontal antenna polarisation

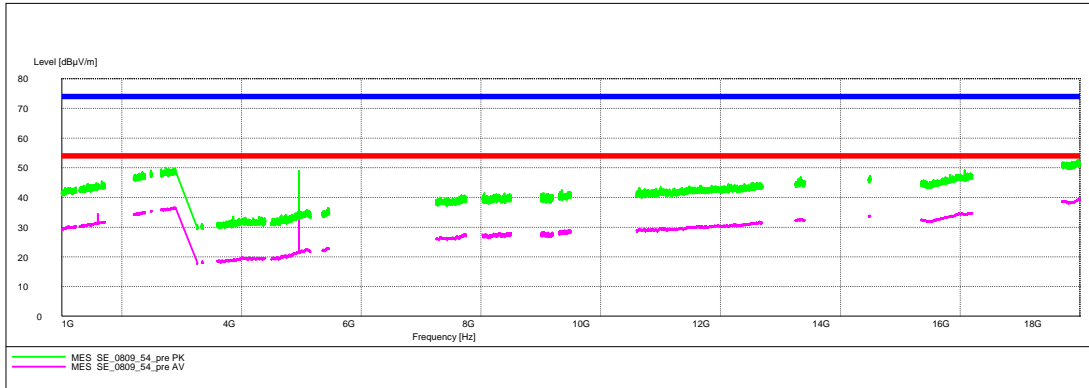

Op. Mode

op-mode 10

EUT: DEA-0002007 (13210b01) / 2008-07-29
Manufacturer: Sony Ericsson
Operating Condition: TX on 2402 MHz, 2-DH1, max power
Test Site: 7 layers Ratingen
Operator: Sli
Test Specification: FCC 15.247 (15.35b, 15.209)
Comment: vertical + horizontal antenna polarisation

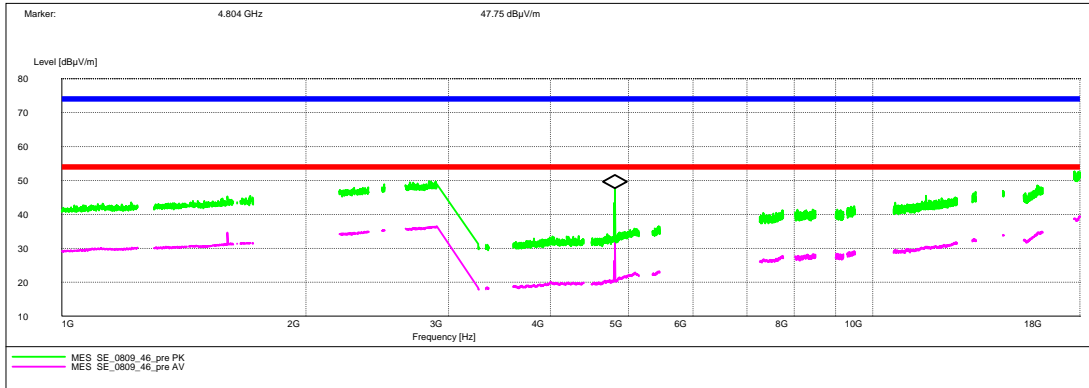

Op. Mode

op-mode 11

EUT: DEA-0002007 (13210b01) / 2008-07-29
Manufacturer: Sony Ericsson
Operating Condition: TX on 2441 MHz, 2-DH1, max power
Test Site: 7 layers Ratingen
Operator: Sli
Test Specification: FCC 15.247 (15.35b, 15.209)
Comment: vertical + horizontal antenna polarisation

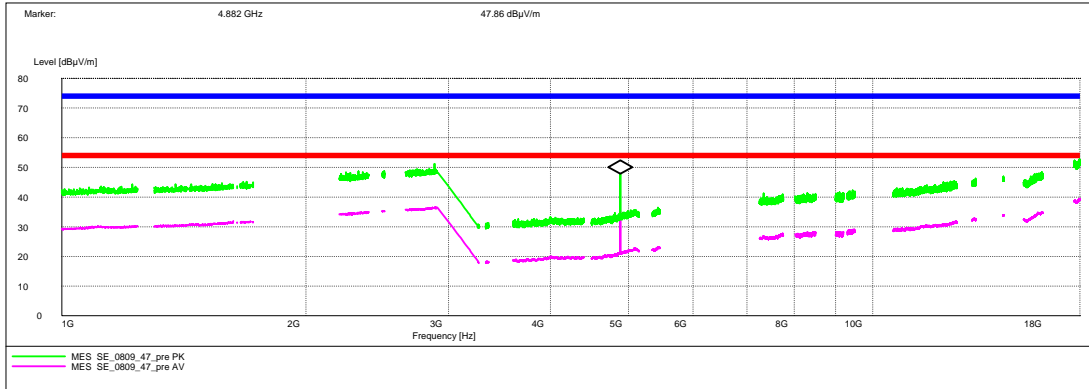

Op. Mode

op-mode 12

EUT: DEA-0002007 (13210b01) / 2008-07-29
Manufacturer: Sony Ericsson
Operating Condition: TX on 2480 MHz, 2-DH1, max power
Test Site: 7 layers Ratingen
Operator: Suna
Test Specification: FCC 15.247 (15.35b, 15.209)
Comment: vertical + horizontal antenna polarisation

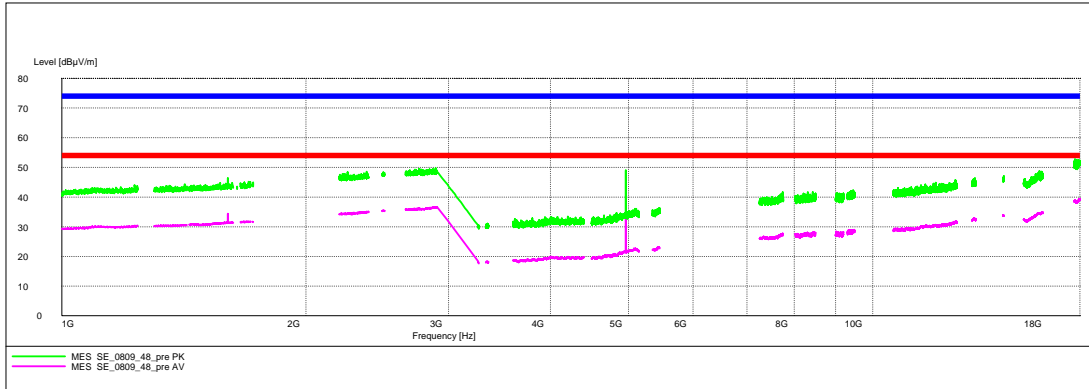



8.8 Dwell time

8.8.1 Dwell time operating mode 2 (DH1)

Op. Mode

op-mode 2 Time slot measurement of a DH1 packet

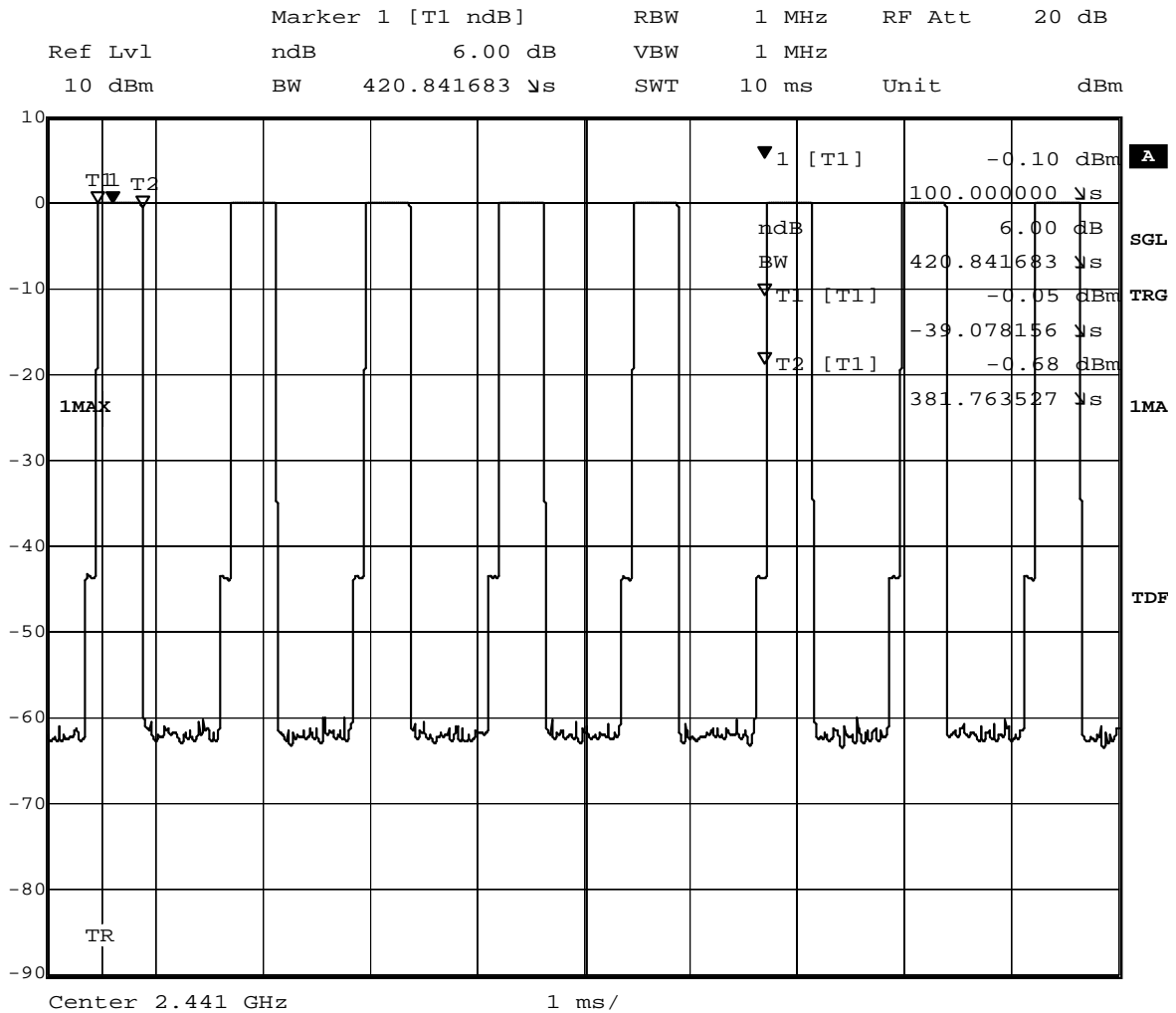

Title: Dwell time
 Comment A: CH M: 2441 MHz
 Date: 30.JUL.2008 10:58:18



8.8.2 Dwell time operating mode 2 (DH3)

Op. Mode

op-mode 2 Time slot measurement of a DH3 packet

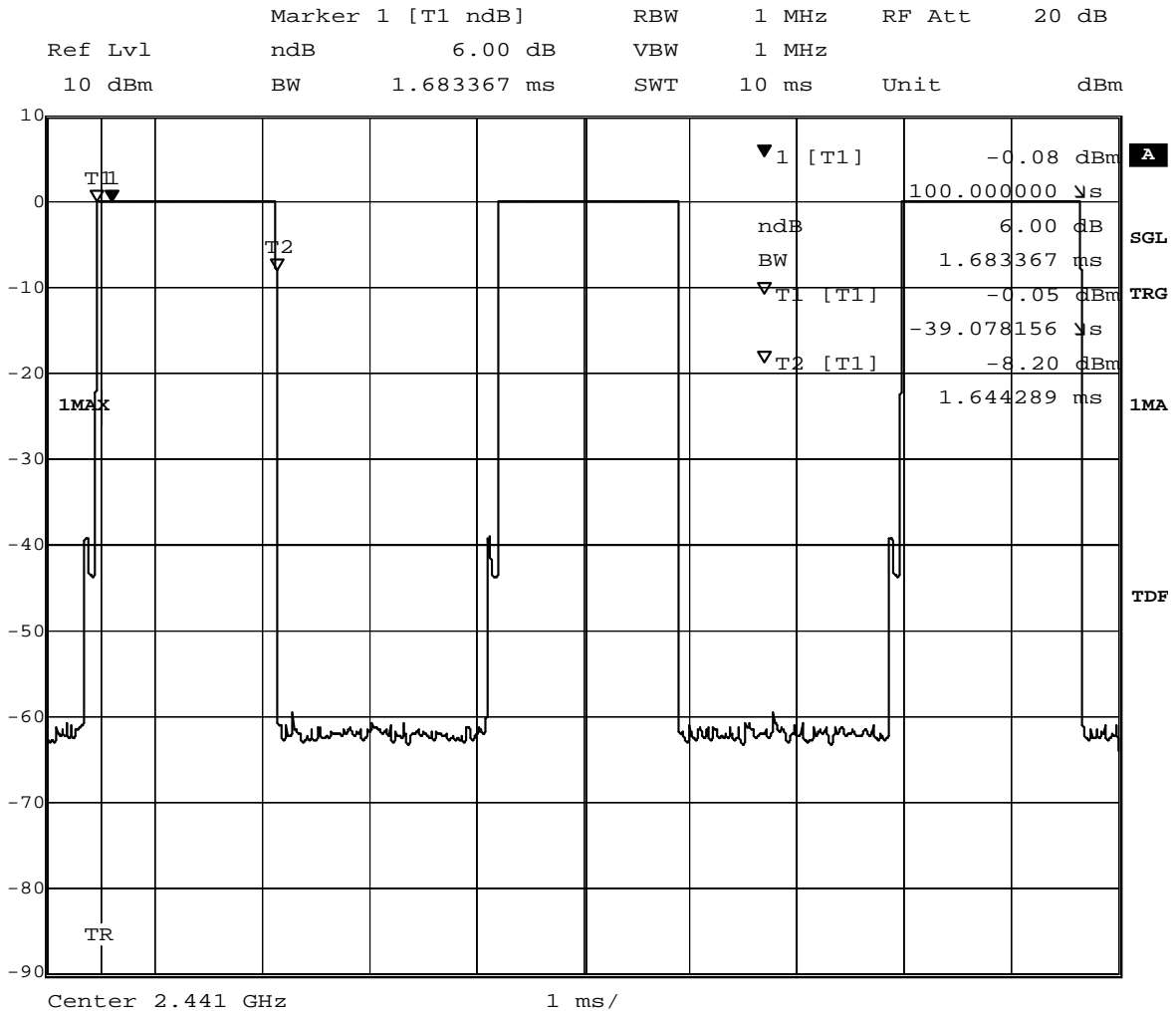

Title: Dwell time
 Comment A: CH M: 2441 MHz
 Date: 30.JUL.2008 10:58:37



8.8.3 Dwell time operating mode 2 (DH5)

Op. Mode

op-mode 2 Time slot measurement of a DH5 packet

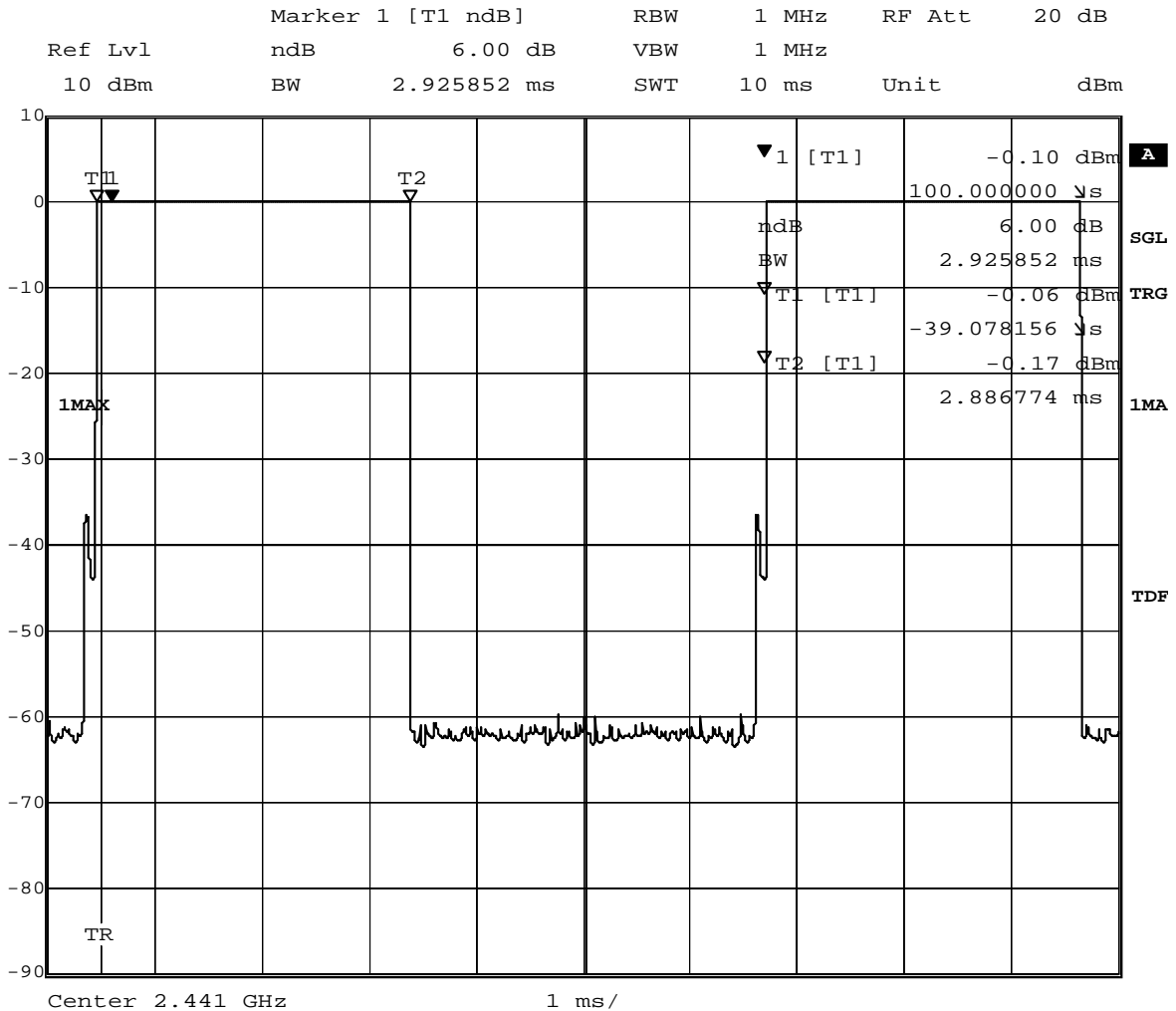

Title: Dwell time
 Comment A: CH M: 2441 MHz
 Date: 30.JUL.2008 10:58:56



8.8.4 Dwell time operating mode 7 (3-DH1)

Op. Mode

op-mode 7 Time slot measurement of a 3-DH1 packet

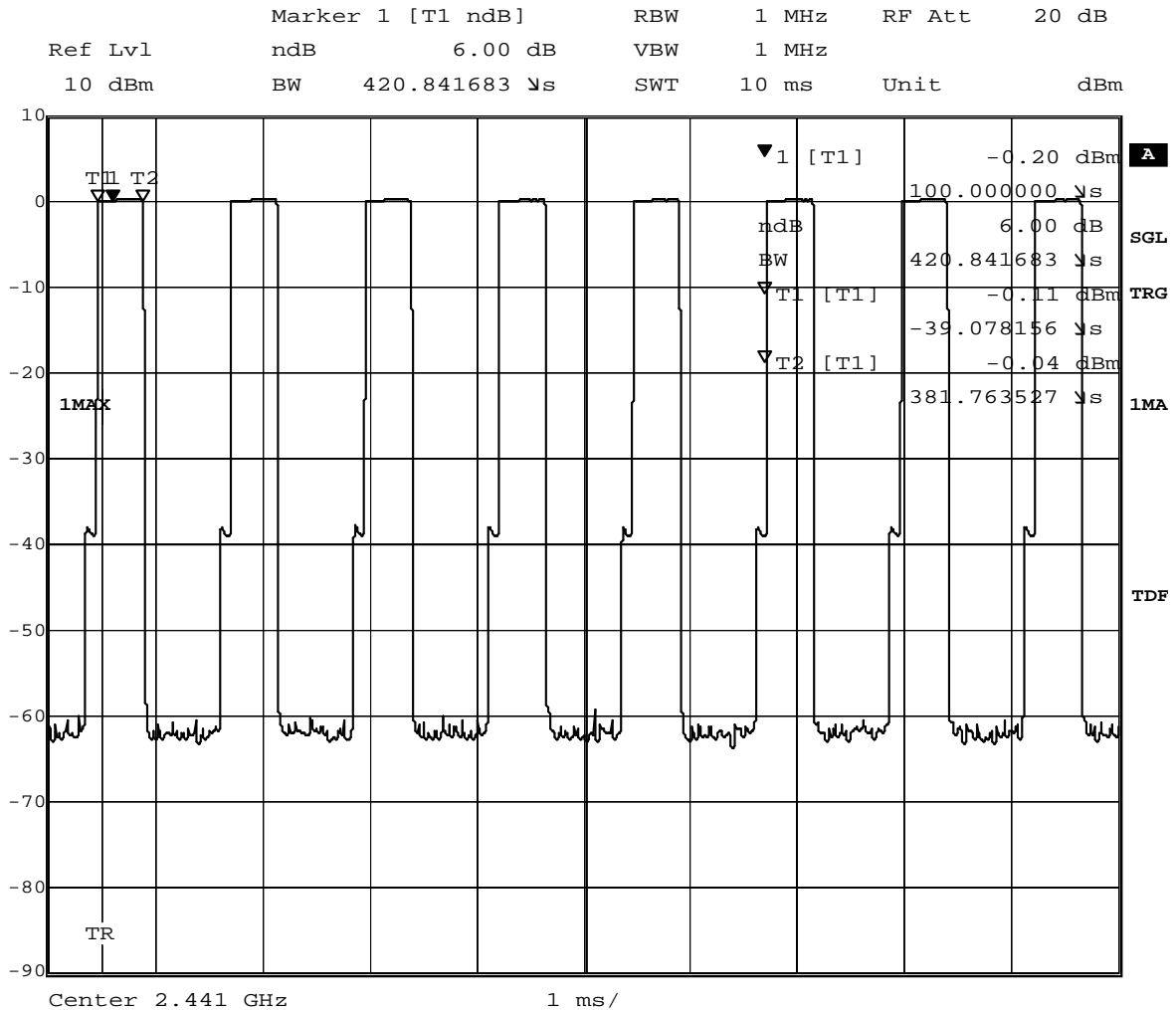

Title: Dwell time
 Comment A: CH M: 2441 MHz
 Date: 30.JUL.2008 11:03:03



8.8.5 Dwell time operating mode 7 (3-DH3)

Op. Mode

op-mode 7 Time slot measurement of a 3-DH3 packet

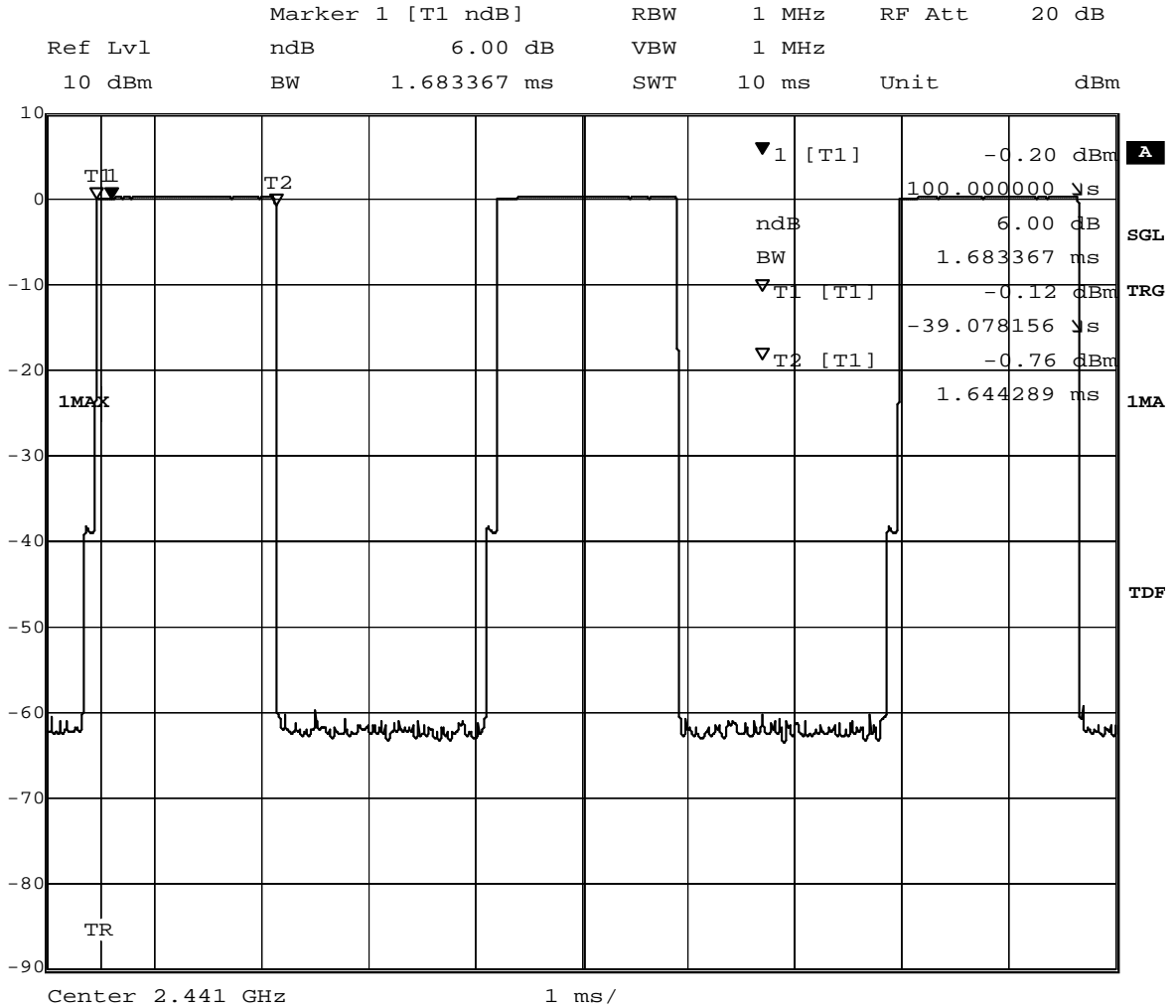

Title: Dwell time
 Comment A: CH M: 2441 MHz
 Date: 30.JUL.2008 11:03:23



8.8.6 Dwell time operating mode 7 (3-DH5)

Op. Mode

op-mode 7 Time slot measurement of a 3-DH5 packet

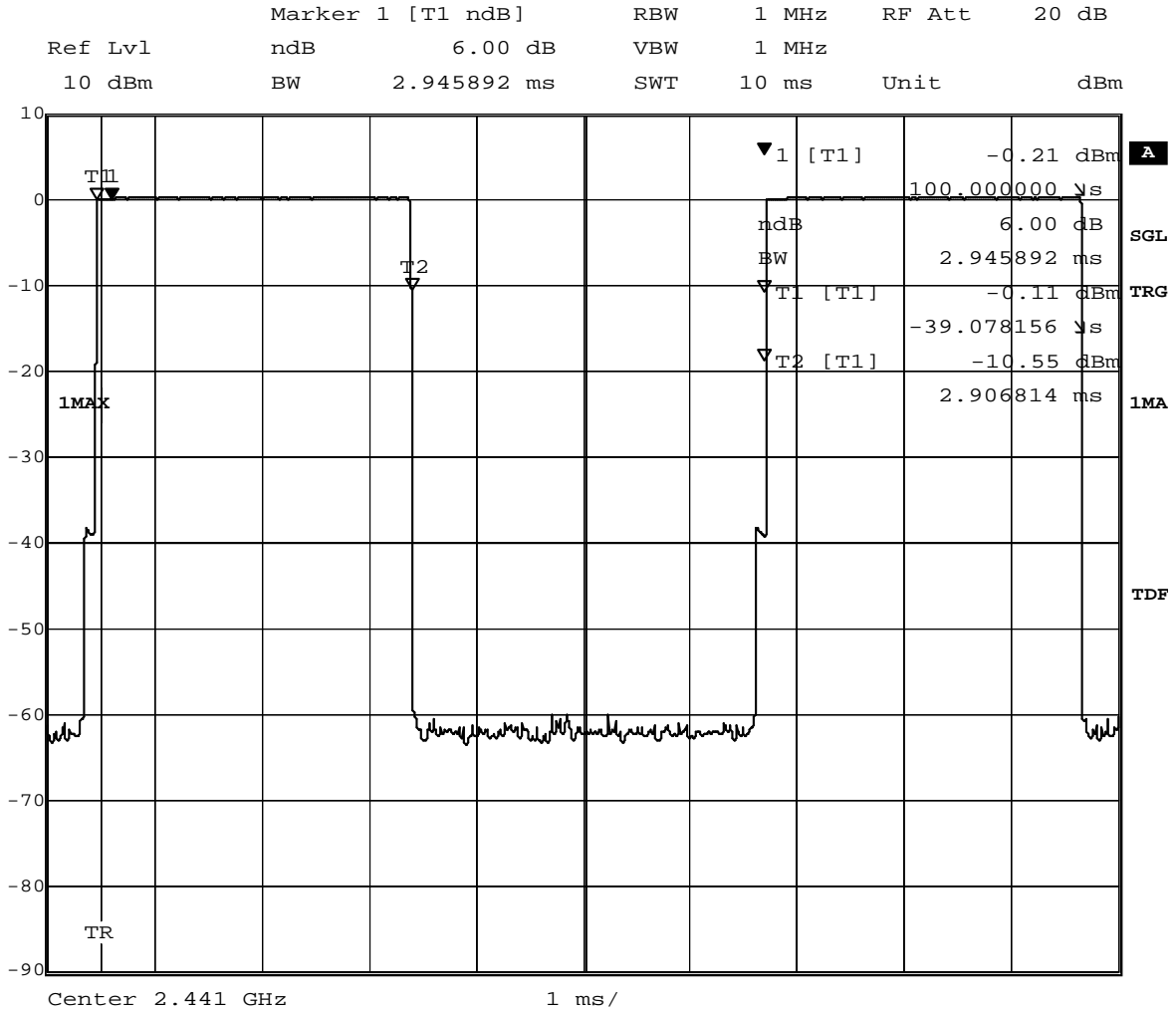

Title: Dwell time
 Comment A: CH M: 2441 MHz
 Date: 30.JUL.2008 11:03:42



8.8.7 Dwell time operating mode 11 (2-DH1)

Op. Mode

op-mode 11 Time slot measurement of a 2-DH1 packet

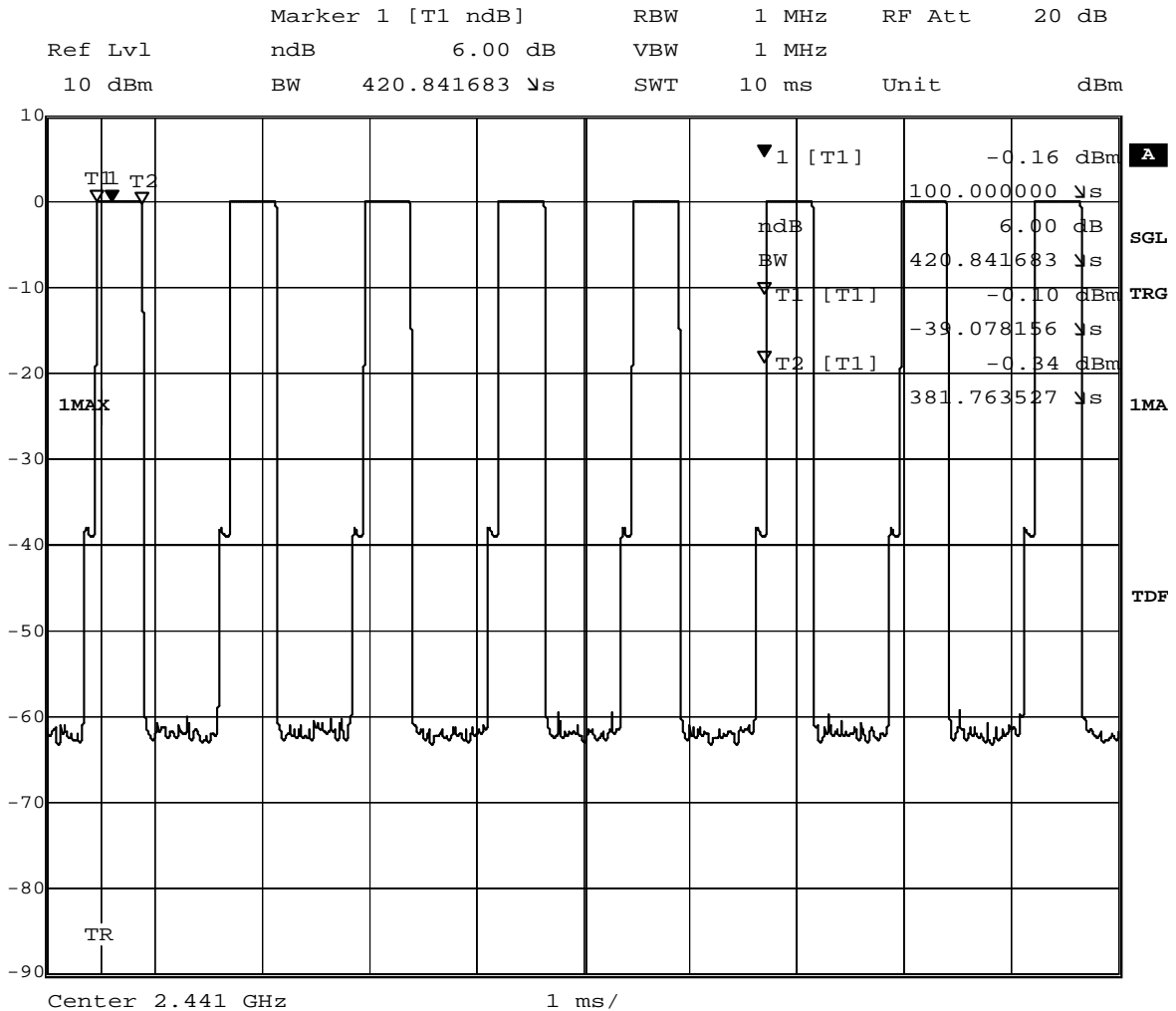

Title: Dwell time
 Comment A: CH M: 2441 MHz
 Date: 30.JUL.2008 11:00:59



8.8.8 Dwell time operating mode 11 (2-DH3)

Op. Mode

op-mode 11 Time slot measurement of a 2-DH3 packet

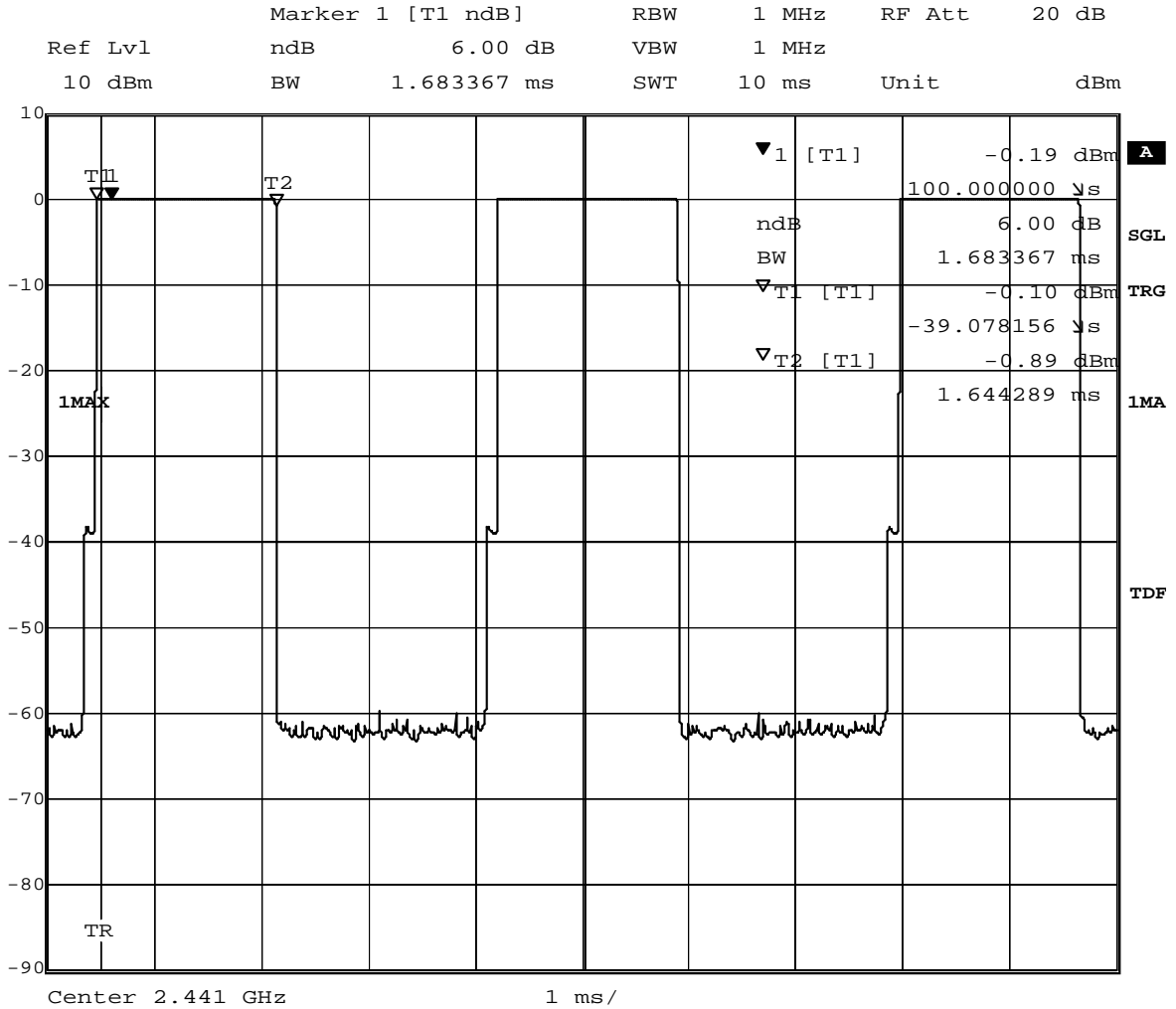

Title: Dwell time
 Comment A: CH M: 2441 MHz
 Date: 30.JUL.2008 11:01:18



8.8.9 Dwell time operating mode 11 (2-DH5)

Op. Mode

op-mode 11 Time slot measurement of a 2-DH5 packet

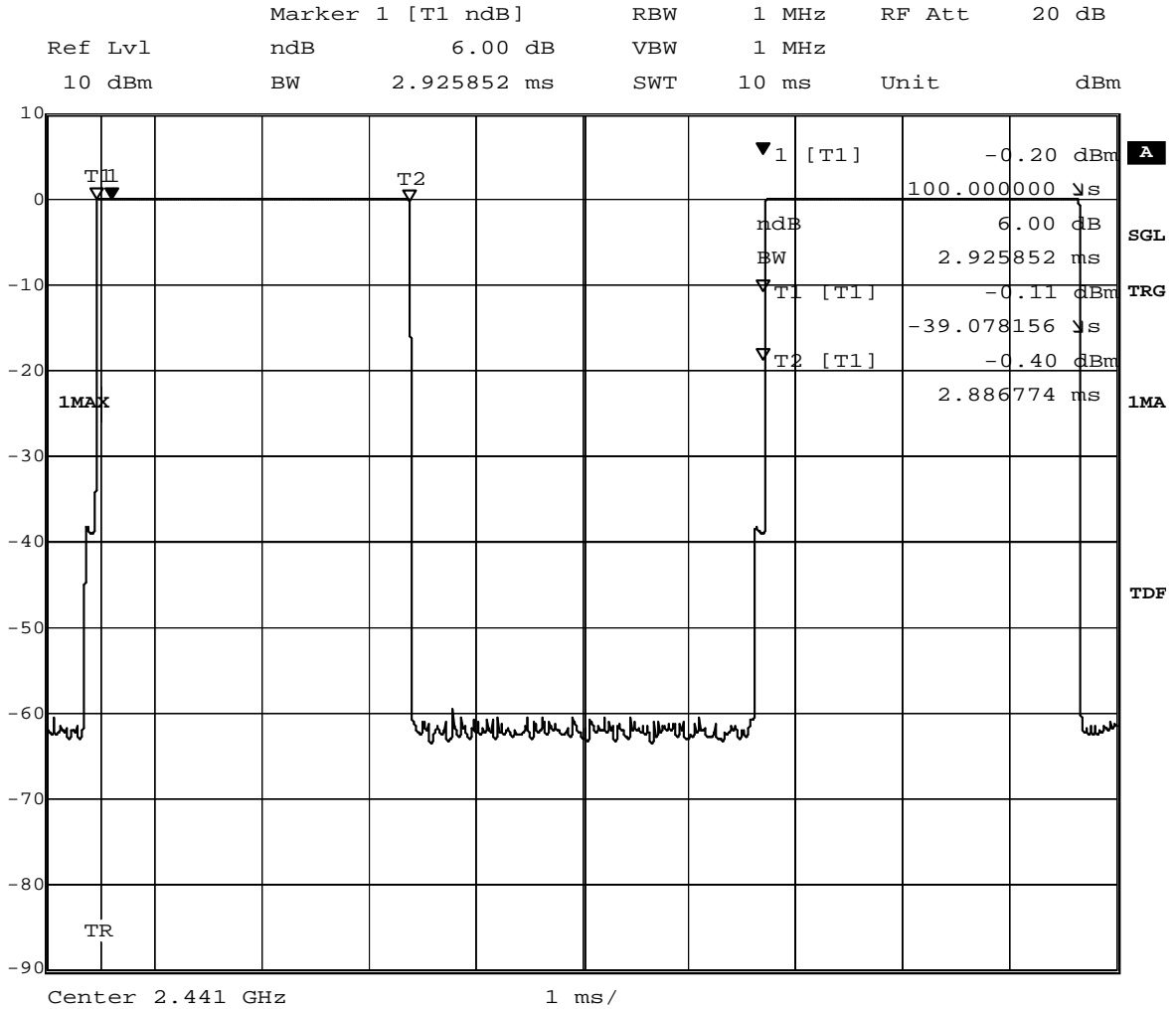

Title: Dwell time
 Comment A: CH M: 2441 MHz
 Date: 30.JUL.2008 11:01:38



8.9 Channel separation

8.9.1 Channel separation operating mode 4

Op. Mode

op-mode 4

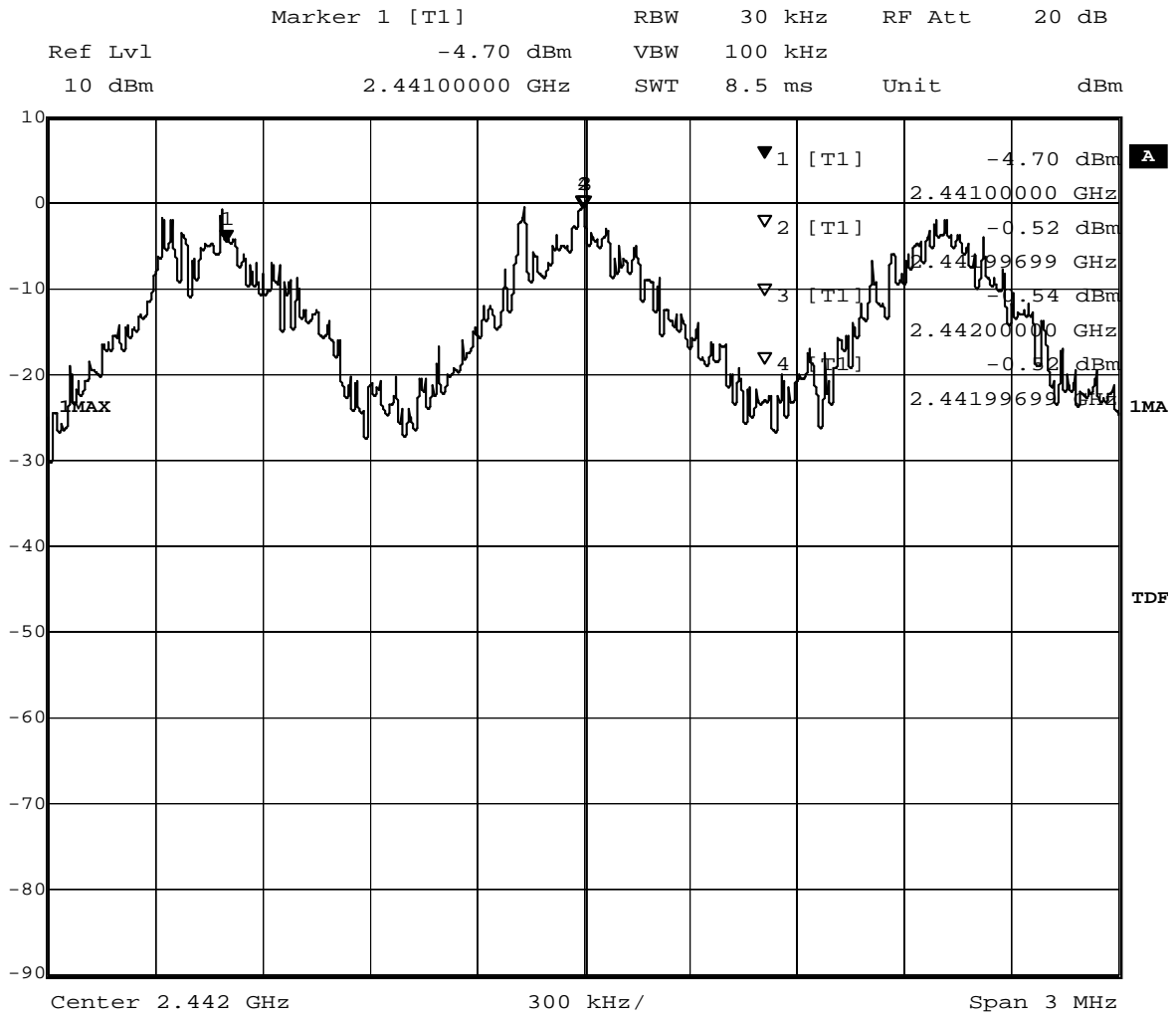

Title: Number of hopping frequencies
 Comment A: CH H: Hopping
 Date: 30.JUL.2008 11:06:29



8.9.2 Channel separation operating mode 9

Op. Mode

op-mode 9

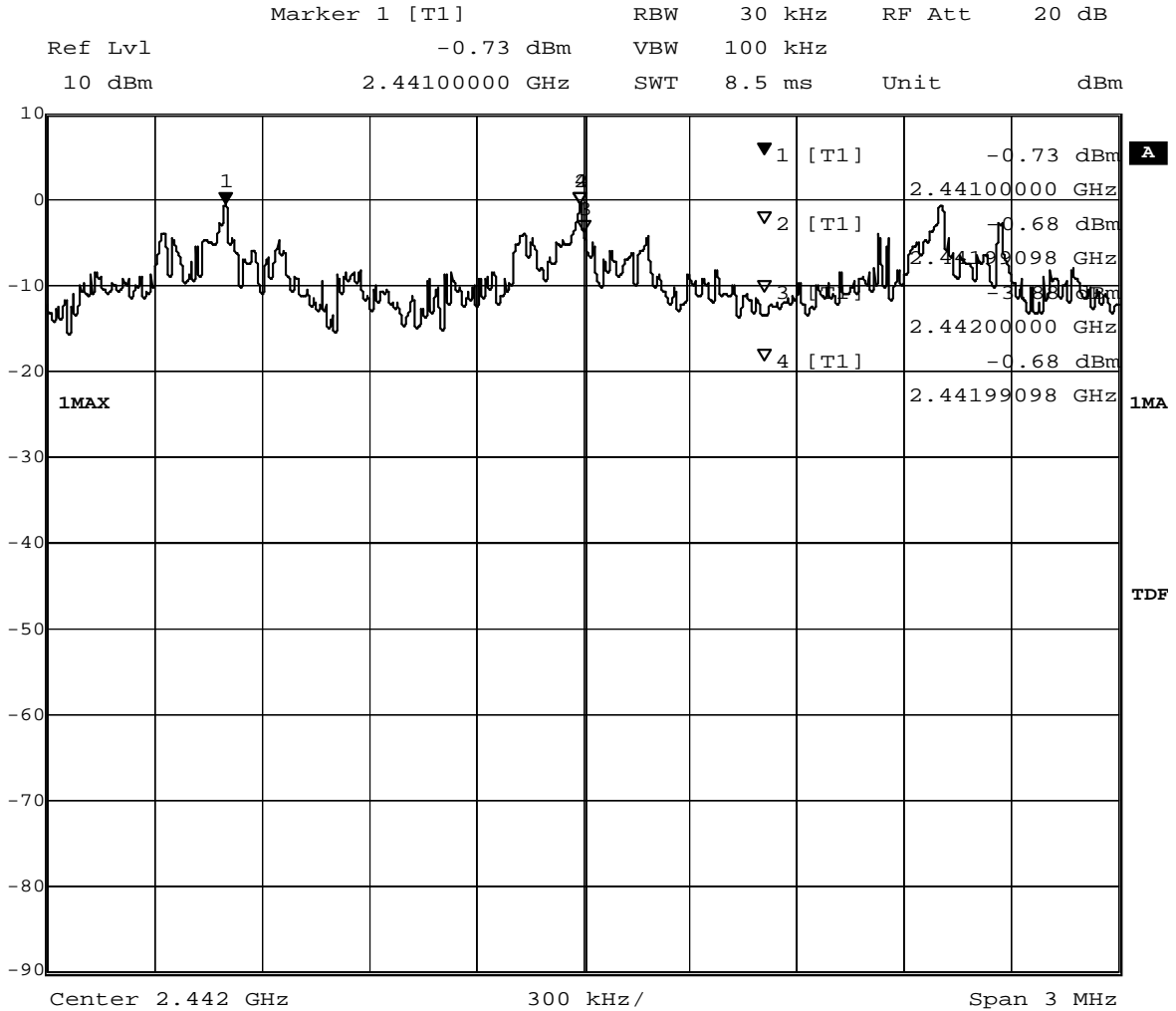

Title: Number of hopping frequencies
Comment A: CH H: Hopping
Date: 30.JUL.2008 11:50:34



8.9.3 Channel separation operating mode 13

Op. Mode

op-mode 13

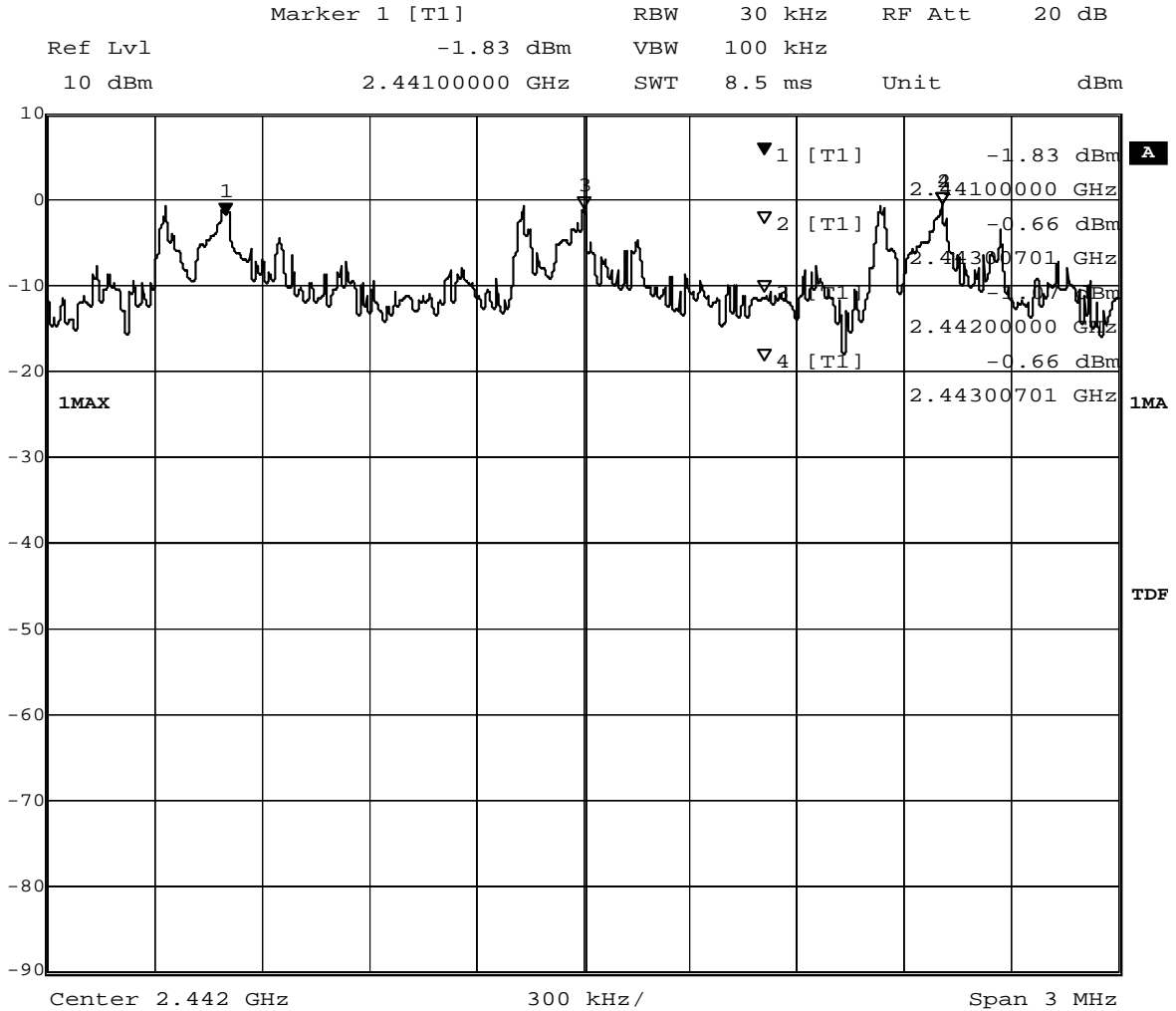

Title: Number of hopping frequencies
 Comment A: CH H: Hopping
 Date: 30.JUL.2008 11:32:00



8.10 Number of hopping frequencies

Op. Mode

op-mode 4

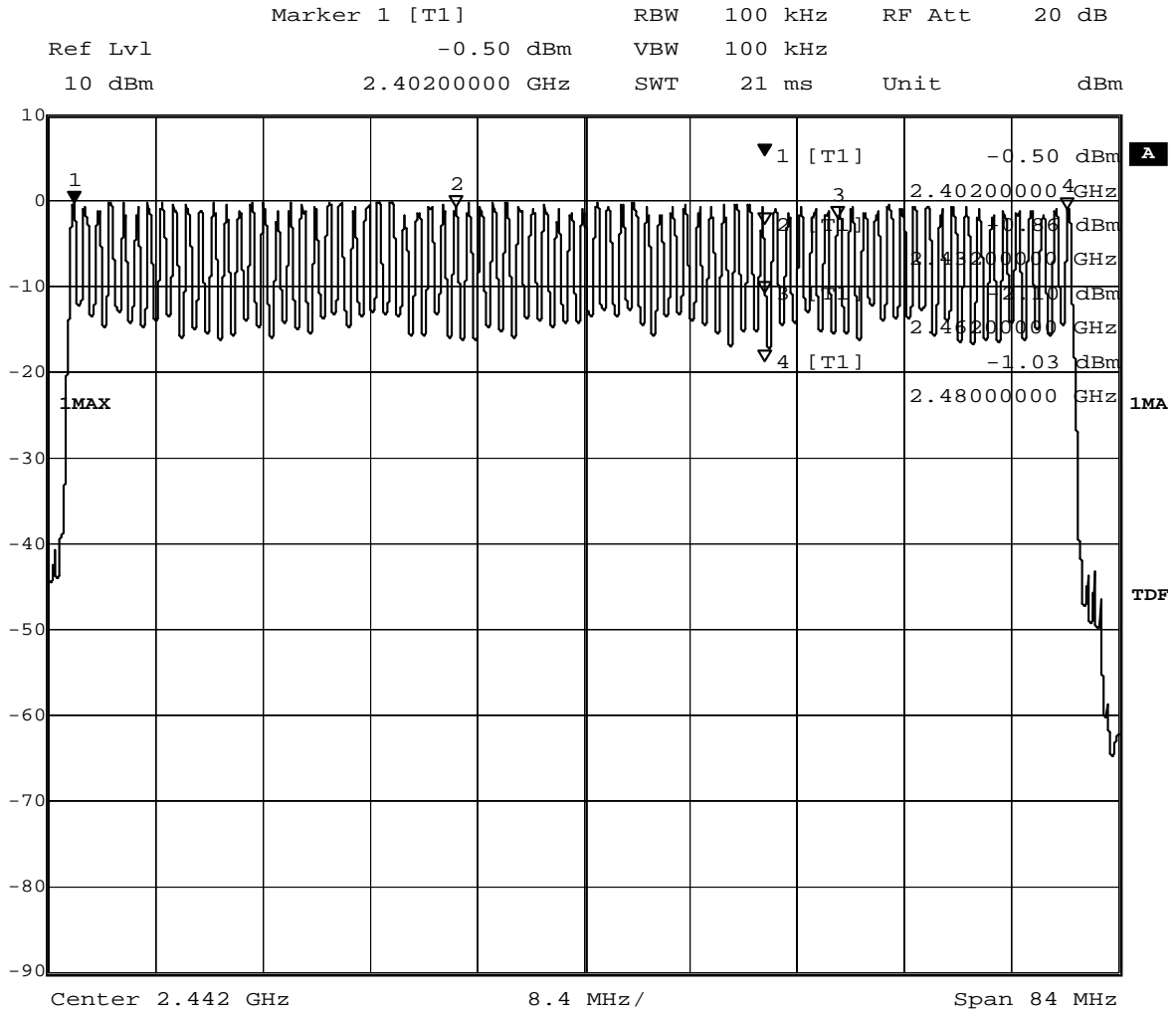

Title: Number of hopping frequencies
Comment A: CH H: Hopping
Date: 30.JUL.2008 11:08:48