**CETECOM™****CETECOM ICT Services**
consulting - testing - certification >>>

TEST REPORT

Test report no.: 1-1954-55-04/10



Testing laboratory

CETECOM ICT Services GmbH
Untertuerkheimer Straße 6 – 10
66117 Saarbruecken / Germany
Phone: + 49 681 5 98 - 0
Fax: + 49 681 5 98 - 9075
Internet: <http://www.cetecom.com>
e-mail: ict@cetecom.com**Accredited test laboratory:**The test laboratory (area of testing) is accredited according to DIN EN ISO/IEC 17025
DAR registration number: DGA-PL-176/94-D1

Area of Testing: Radio/Satellite Communications

Applicant

Sony Ericsson Mobile Communications ABNya Vattentornet
22188 Lund / Sweden
Phone: +46 46 19 30 00
Fax: +46 46 19 32 95
Contact: Johan Wedin
e-mail: johan.wedin@sonyericsson.com
Phone: +46 70 71 95 73 6

Manufacturer

Sony Ericsson Mobile Communications ABNya Vattentornet
22188 Lund / Sweden

Test standard/s

47 CFR Part 15	Title 47 of the Code of Federal Regulations; Chapter I-Federal Communications Commission subchapter A - general, Part 15-Radio frequency devices
RSS - 210 Issue 8	Spectrum Management and Telecommunications - Radio Standards Specification Low-power Licence-exempt Radiocommunication Devices (All Frequency Bands): Category I Equipment

For further applied test standards please refer to section 3 of this test report.

Test item

Kind of test item:	Mobile Phone GSM/GPRS/EDGE 850/900/1800/1900/UMTS Band 1/UMTS Band 8/HSDPA/HSUPA/BT2.1+EDR/WLAN/A-GPS/FM-Receiver/ANT+
Model name:	AAD-3880097-BV
FCC ID:	PY7A3880097
IC:	4170B-A3880097
Frequency [MHz]:	ISM band 2400 MHz to 2483.5 MHz (Lowest channel 2402 MHz; highest channel 2480 MHz)
Power supply:	3.7V DC by Li-polymer battery BA750 / DC power supply EP800
Temperature range:	-20 °C to +55 °C

Test performed:

2011-01-14 Marco Bertolino

Test report authorised:

2011-01-14 Jakob Reschke

1 Table of contents

1	Table of contents	2
2	General information	3
2.1	Notes.....	3
2.2	Application details	3
3	Test standard/s	3
4	Test environment	3
5	Test item	4
6	Test laboratories sub-contracted	4
7	Summary of measurement results	5
8	RF measurement testing	6
8.1	Description of test setup.....	6
8.1.1	Radiated measurements.....	6
8.1.2	Conducted measurements.....	7
8.2	Additional comments	7
8.3	RSP100 test report cover sheet / performance test data.....	8
9	Measurement results.....	9
9.1	Antenna gain.....	9
9.2	Power spectral density.....	10
9.3	Carrier frequency separation.....	11
9.4	Number of hopping channels	13
9.5	Time of occupancy (dwell time).....	15
9.6	Spectrum bandwidth of a FHSS system – 20 dB bandwidth.....	16
9.7	Maximum output power.....	22
9.8	Band edge compliance conducted	29
9.9	Band edge compliance radiated	37
9.10	TX spurious emissions conducted	44
9.11	TX spurious emissions radiated	52
9.12	RX spurious emissions radiated	66
9.13	TX spurious emissions radiated < 30 MHz	72
9.14	TX spurious emissions conducted < 30 MHz.....	75
10	Test equipment and ancillaries used for tests.....	78
Annex A	Photographs of the test setup.....	80
Annex B	External photographs of the EUT.....	85
Annex C	Internal photographs of the EUT	91
Annex D	Document history	101
Annex E	Further information.....	101

2 General information

2.1 Notes

The test results of this test report relate exclusively to the test item specified in this test report. CETECOM ICT Services GmbH does not assume responsibility for any conclusions and generalisations drawn from the test results with regard to other specimens or samples of the type of the equipment represented by the test item. The test report may only be reproduced or published in full. Reproduction or publication of extracts from the report requires the prior written approval of CETECOM ICT Services GmbH.

2.2 Application details

Date of receipt of order:	2010-11-29
Date of receipt of test item:	2011-01-05
Start of test:	2011-01-05
End of test:	2011-01-14
Person(s) present during the test:	-/-

3 Test standard/s

Test standard	Version	Test standard description
47 CFR Part 15	2009-10	Title 47 of the Code of Federal Regulations; Chapter I-Federal Communications Commission subchapter A - general, Part 15-Radio frequency devices
RSS - 210 Issue 8	2010-12	Spectrum Management and Telecommunications - Radio Standards Specification Low-power Licence-exempt Radiocommunication Devices (All Frequency Bands): Category I Equipment

4 Test environment

Temperature:	T_{nom}	+20 °C during room temperature tests
	T_{max}	+55 °C during high temperature test
	T_{min}	-20 °C during low temperature test
Relative humidity content:		44 %
Air pressure:		not relevant for this kind of testing
Power supply:	V_{nom}	3.7 V DC by Li-polymer battery BA750 / DC power supply EP800
	V_{max}	4.1 V
	V_{min}	3.3 V

5 Test item

Kind of test item	:	Mobile Phone GSM/GPRS/EDGE 850/900/1800/1900/UMTS Band 1/UMTS Band 8/HSDPA/HSUPA/BT2.1+EDR/WLAN/A-GPS/FM-Receiver/ANT+
Type identification	:	AAD-3880097-BV
S/N serial number	:	Radiated: CB5A1CG1MP; CB5A1CG1LU Conducted: CB5A1CG1LM; CB5A1CG1MN
HW hardware status	:	AP1
SW software status	:	1.2.A.0.193 ATP
Frequency band [MHz]	:	ISM band 2400 MHz – 2483.5 MHz (Lowest channel 2402 MHz; highest channel 2480 MHz)
Type of modulation	:	FHSS technology with GFSK, Pi/4 DQPSK and 8 DPSK modulation
Number of channels	:	79
Antenna	:	Integrated PCB antenna → for more information, please take a look at the annex C – internal photos of the EUT
Power supply	:	3.7 V DC by Li-polymer battery BA750 / DC power supply EP800
Temperature range	:	-20 °C to +55 °C

6 Test laboratories sub-contracted

None

7 Summary of measurement results



No deviations from the technical specifications were ascertained



There were deviations from the technical specifications ascertained

TC Identifier	Description	Verdict	Date	Remark
RF-Testing	CFR Part 15 RSS 210, Issue 7, Annex 8	Passed	2011-01-14	-/-

Test specification clause	Test case	Temperature conditions	Power source voltages	Mode	Pass	Fail	NA	NP	Results (max.)
§15.247(b)(4) RSS 210 / A8.4(2)	Antenna gain	Nominal	Nominal	GFSK	<input checked="" type="checkbox"/>	<input type="checkbox"/>	<input type="checkbox"/>	<input type="checkbox"/>	complies
§15.247(e) RSS 210 / A8.2(b)	Power spectral density	Nominal	Nominal	GFSK Pi/4 DQPSK 8 DPSK	<input type="checkbox"/>	<input type="checkbox"/>	<input checked="" type="checkbox"/>	<input type="checkbox"/>	-/-
§15.247(a)(1) RSS 210 / A8.1(b)	Carrier frequency separation	Nominal	Nominal	GFSK	<input checked="" type="checkbox"/>	<input type="checkbox"/>	<input type="checkbox"/>	<input type="checkbox"/>	complies
§15.247(a)(1) RSS 210 / A8.1(d)	Number of hopping channels	Nominal	Nominal	GFSK	<input checked="" type="checkbox"/>	<input type="checkbox"/>	<input type="checkbox"/>	<input type="checkbox"/>	complies
§15.247(a)(1) (iii) RSS 210 / A8.3(1)	Time of occupancy (dwell time)	Nominal	Nominal	GFSK Pi/4 DQPSK 8 DPSK	<input checked="" type="checkbox"/>	<input type="checkbox"/>	<input type="checkbox"/>	<input type="checkbox"/>	complies
§15.247(a)(1) RSS 210 / A8.2(a)	Spectrum bandwidth of a FHSS system 20dB bandwidth	Nominal	Nominal	GFSK Pi/4 DQPSK 8 DPSK	<input checked="" type="checkbox"/> <input checked="" type="checkbox"/> <input checked="" type="checkbox"/>	<input type="checkbox"/> <input type="checkbox"/> <input type="checkbox"/>	<input type="checkbox"/> <input type="checkbox"/> <input type="checkbox"/>	<input type="checkbox"/> <input type="checkbox"/> <input type="checkbox"/>	complies
§15.247(b)(1) RSS-210 / A8.4(2)	Maximum output power	Nominal	Nominal	GFSK Pi/4 DQPSK 8 DPSK	<input checked="" type="checkbox"/> <input checked="" type="checkbox"/> <input checked="" type="checkbox"/>	<input type="checkbox"/> <input type="checkbox"/> <input type="checkbox"/>	<input type="checkbox"/> <input type="checkbox"/> <input type="checkbox"/>	<input type="checkbox"/> <input type="checkbox"/> <input type="checkbox"/>	complies
§15.247(d) RSS-210 / A8.5	Band edge compliance conducted	Nominal	Nominal	GFSK Pi/4 DQPSK 8 DPSK	<input checked="" type="checkbox"/> <input checked="" type="checkbox"/> <input checked="" type="checkbox"/>	<input type="checkbox"/> <input type="checkbox"/> <input type="checkbox"/>	<input type="checkbox"/> <input type="checkbox"/> <input type="checkbox"/>	<input type="checkbox"/> <input type="checkbox"/> <input type="checkbox"/>	complies
§15.205 RSS-210 / A8.5	Band edge compliance radiated	Nominal	Nominal	GFSK Pi/4 DQPSK 8 DPSK	<input checked="" type="checkbox"/> <input checked="" type="checkbox"/> <input checked="" type="checkbox"/>	<input type="checkbox"/> <input type="checkbox"/> <input type="checkbox"/>	<input type="checkbox"/> <input type="checkbox"/> <input type="checkbox"/>	<input type="checkbox"/> <input type="checkbox"/> <input type="checkbox"/>	complies
§15.247(d) RSS-210 / A8.5	TX spurious emissions conducted	Nominal	Nominal	GFSK Pi/4 DQPSK 8 DPSK	<input checked="" type="checkbox"/> <input checked="" type="checkbox"/> <input checked="" type="checkbox"/>	<input type="checkbox"/> <input type="checkbox"/> <input type="checkbox"/>	<input type="checkbox"/> <input type="checkbox"/> <input type="checkbox"/>	<input type="checkbox"/> <input type="checkbox"/> <input type="checkbox"/>	complies
§15.247(d) RSS-210 / A8.5	TX spurious emissions radiated	Nominal	Nominal	8 DPSK	<input checked="" type="checkbox"/>	<input type="checkbox"/>	<input type="checkbox"/>	<input type="checkbox"/>	complies
§15.109 RSS-Gen.	RX spurious emissions radiated	Nominal	Nominal	-/-	<input checked="" type="checkbox"/>	<input type="checkbox"/>	<input type="checkbox"/>	<input type="checkbox"/>	complies
§15.209(a) RSS-Gen	TX spurious emissions radiated < 30 MHz	Nominal	Nominal	8 DPSK	<input checked="" type="checkbox"/>	<input type="checkbox"/>	<input type="checkbox"/>	<input type="checkbox"/>	complies
§15.107(a)	Conducted emissions < 30 MHz	Nominal	Nominal	8 DPSK	<input checked="" type="checkbox"/>	<input type="checkbox"/>	<input type="checkbox"/>	<input type="checkbox"/>	complies

Note: NA = Not Applicable; NP = Not Performed

8 RF measurement testing

8.1 Description of test setup

8.1.1 Radiated measurements

The radiated measurements are performed in vertical and horizontal plane in the frequency range from 9 kHz to 25 GHz in semi-anechoic chambers. The EUT is positioned on a non-conductive support with a height of 0.80 m above a conductive ground plane that covers the whole chamber. The receiving antennas are confirmed with specifications ANSI C63.2-1996 clause 15 and ANSI C63.4-2003 clause 4.1.5. These antennas can be moved over the height range between 1.0 m and 4.0 m in order to search for maximum field strength emitted from EUT. The measurement distances between EUT and receiving antennas are indicated in the test setups for the various frequency ranges. For each measurement, the EUT is rotated in all three axes until the maximum field strength is received. The wanted and unwanted emissions are received by spectrum analysers where the detector modes and resolution bandwidths over various frequency ranges are set according to requirement ANSI C63-4-2003 clause 4.2.

Antennas are confirmed with ANSI C63.2-1996 item 15.

Semi anechoic chamber

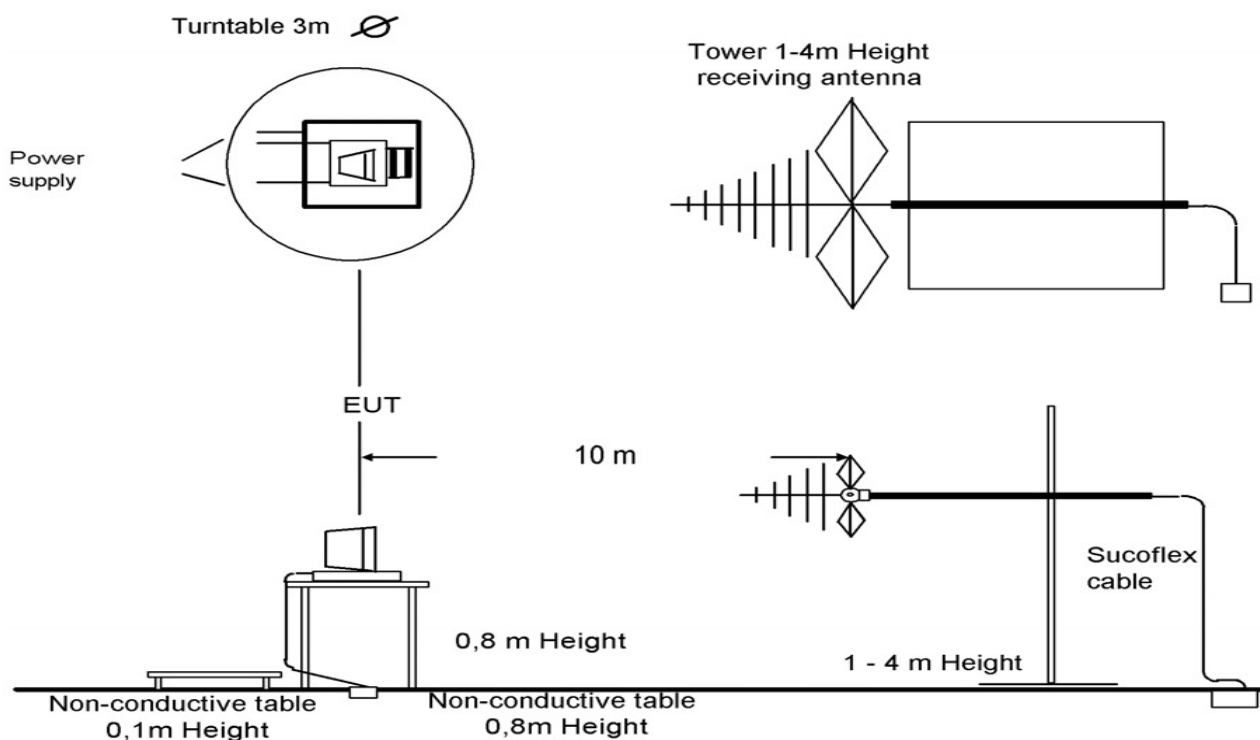

Picture 1: Diagram radiated measurements

9 kHz - 30 MHz:	active loop antenna
30 MHz – 1 GHz:	tri-log antenna
> 1 GHz:	horn antenna

All measurements are done in accordance with the Filing and Measurement Guidelines for Frequency Hopping Spread Spectrum Systems DA 00-705 and Appendix A "BLUETOOTH® APPROVALS". The EUT is powered by an external power supply with nominal voltage. The signalling is performed from outside the chamber with a signalling unit (CMU200 or other) by air link using signalling antenna.

8.1.2 Conducted measurements

The EUT's RF signal is coupled out by the antenna connector which is supplied by the manufacturer. The signal is first 10dB attenuated before it is power divided (~6dB loss per branch). One of the signal paths is connected to the communication base Station (CMU200 or other), the other one is connected to the spectrum analyzer. The specific losses for both signal paths are first checked within a calibration. The measurement readings on the signalling unit/spectrum analyzer are corrected by the specific test set-up loss. The attenuator, power divider, signalling unit and the spectrum analyzer are impedance matched on 50 Ohm.

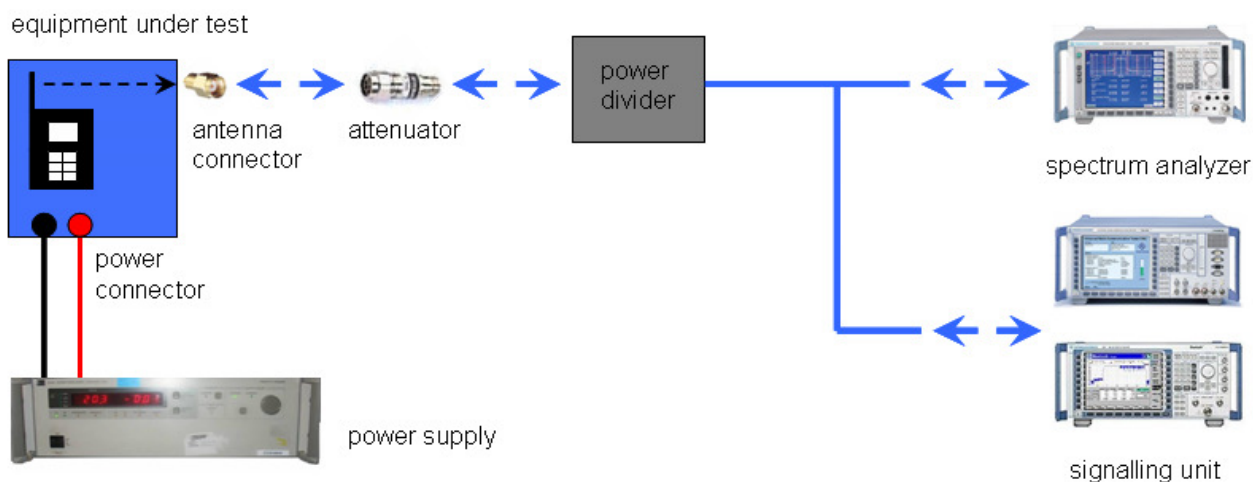

Picture 2: Diagram conducted measurements

8.2 Additional comments

The Bluetooth® word mark and logos are owned by the Bluetooth SIG Inc. and any use of such marks by Cetecom ICT Services GmbH is under license.

Reference documents: None

Special test descriptions: None

Configuration descriptions: TX tests: were performed with x-DH5 packets and static PRBS pattern payload.
RX/Standby tests: BT test mode enabled, scan enabled, TX Idle

Test mode: Bluetooth Test mode loop back enabled (EUT is controlled over CBT/CMU)
 Special software is used. EUT is transmitting pseudo random data by itself

8.3 RSP100 test report cover sheet / performance test data

Test report number	:	1-1954-55-04/10																		
Equipment model number	:	AAD-3880097-BV																		
Certification number	:	4170B-A3880097																		
Manufacturer (complete address)	:	Sony Ericsson Mobile Communications AB Nya Vattentorget 22188 Lund / Sweden																		
Tested to radio standards specification no.	:	RSS 210, Issue 8, Annex 8																		
Open area test site IC No.	:	IC 3462C-1																		
Frequency range	:	ISM band 2400 MHz – 2483.5 MHz (Lowest channel 2402 MHz; highest channel 2480 MHz)																		
RF-power [W] (max.)	:	<table> <tr> <td>Cond.:</td> <td>5.33 mW</td> <td>(GFSK)</td> </tr> <tr> <td>EIRP:</td> <td>3.06 mW</td> <td>(GFSK)</td> </tr> <tr> <td>Cond.:</td> <td>6.05 mW</td> <td>(Pi/4-DQPSK)</td> </tr> <tr> <td>EIRP:</td> <td>3.48 mW</td> <td>(Pi/4-DQPSK)</td> </tr> <tr> <td>Cond.:</td> <td>7.24 mW</td> <td>(8DPSK)</td> </tr> <tr> <td>EIRP:</td> <td>4.16 mW</td> <td>(8DPSK)</td> </tr> </table>	Cond.:	5.33 mW	(GFSK)	EIRP:	3.06 mW	(GFSK)	Cond.:	6.05 mW	(Pi/4-DQPSK)	EIRP:	3.48 mW	(Pi/4-DQPSK)	Cond.:	7.24 mW	(8DPSK)	EIRP:	4.16 mW	(8DPSK)
Cond.:	5.33 mW	(GFSK)																		
EIRP:	3.06 mW	(GFSK)																		
Cond.:	6.05 mW	(Pi/4-DQPSK)																		
EIRP:	3.48 mW	(Pi/4-DQPSK)																		
Cond.:	7.24 mW	(8DPSK)																		
EIRP:	4.16 mW	(8DPSK)																		
Occupied bandwidth (99%-BW) [kHz]	:	<table> <tr> <td>944</td> <td>(GFSK)</td> </tr> <tr> <td>1335</td> <td>(Pi/4-DQPSK)</td> </tr> <tr> <td>1311</td> <td>(8DPSK)</td> </tr> </table>	944	(GFSK)	1335	(Pi/4-DQPSK)	1311	(8DPSK)												
944	(GFSK)																			
1335	(Pi/4-DQPSK)																			
1311	(8DPSK)																			
Type of modulation	:	GFSK; Pi/4-DQPSK; 8DPSK																		
Emission designator (TRC-43)	:	<table> <tr> <td>944KFXD</td> <td>(GFSK)</td> </tr> <tr> <td>1M34GXD</td> <td>(Pi/4-DQPSK)</td> </tr> <tr> <td>1M31GXD</td> <td>(8DPSK)</td> </tr> </table>	944KFXD	(GFSK)	1M34GXD	(Pi/4-DQPSK)	1M31GXD	(8DPSK)												
944KFXD	(GFSK)																			
1M34GXD	(Pi/4-DQPSK)																			
1M31GXD	(8DPSK)																			
Antenna information	:	Integrated PCB antenna → for more information, please take a look at the annex C – internal photos of the EUT																		
Transmitter spurious (worst case) [dBμV/m @ 3m]:	:	49.30 dBμV/m @ 24.11 GHz(noise floor)																		
Receiver spurious (worst case) [dBμV/m @ 3m]:	:	49.28 dBμV/m @ 24.06 GHz(noise floor)																		

ATTESTATION:

DECLARATION OF COMPLIANCE:

I attest that the testing was performed or supervised by me; that the test measurements were made in accordance with the above-mentioned Industry Canada standard(s); and that the equipment identified in this application has been subjected to all the applicable test conditions specified in the Industry Canada standards and all of the requirements of the standard have been met.

Laboratory manager:

2011-01-14

Date

Marco Bertolino

Name

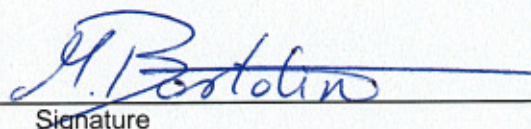

Signature

9 Measurement results

9.1 Antenna gain

Measurement:

The antenna gain of the complete system is calculated by the difference of radiated power in EIRP and the conducted power of the module.

Measurement parameters:

Measurement parameter	
Detector:	Peak
Sweep time:	Auto
Video bandwidth:	3 MHz
Resolution bandwidth:	3 MHz
Span:	5 MHz
Trace-Mode:	Max hold

Limits:

FCC	IC
CFR Part 15.247 (b)(4)	RSS 210, Issue 8, A 8.4(2)
Antenna Gain	
6 dBi	

Results:

T_{nom}	V_{nom}	lowest channel 2402 MHz	middle channel 2441 MHz	highest channel 2480 MHz
Conducted power [dBm] Measured with 8 DPSK modulation		8.60	7.99	8.43
Radiated power [dBm] Measured with 8 DPSK modulation		6.19	4.81	3.89
Gain [dBi] Calculated		-2.41	-3.18	-4.54

Result: The result of the measurement is passed.

9.2 Power spectral density

Description:

Measurement of the power spectral density of a digital modulated system. This requirement is only valid for digitally modulated systems without hopping functionality.

Measurement:

Measurement parameter	
Detector:	Peak
Sweep time:	500 s
Video bandwidth:	3 kHz
Resolution bandwidth:	3 kHz
Span:	150 kHz
Trace-Mode:	Max Hold

Limits:

FCC	IC
CFR Part 15.247 (e)	RSS 210, Issue 8, A 8.2(b)
Power Spectral Density	
For digitally modulated systems the transmitter power spectral density conducted from the transmitter to the antenna shall not be greater than 8 dBm in any 3 kHz band during any time interval of continuous transmission or over 1.0 second if the transmission exceeds 1.0-second duration.	

Result:

Modulation	Power spectral density [dBm/3kHz]		
	2412 MHz	2437 MHz	2462 MHz
Frequency			
GFSK	Not required for hopping systems!		
Pi/4 DQPSK			
8DPSK			
Measurement uncertainty	± 1.5 dB		

9.3 Carrier frequency separation

Description:

Measurement of the carrier frequency separation of a hopping system. The carrier frequency separation is constant for all modulation-modes. We use GFSK-modulation to show compliance. EUT in hopping mode.

Measurement:

Measurement parameter	
Detector:	Peak
Sweep time:	Auto
Video bandwidth:	100 kHz
Resolution bandwidth:	100 kHz
Span:	4 MHz
Trace-Mode:	Max Hold

Limits:

FCC	IC
CFR Part 15.247 (a)(1)	RSS 210, Issue 8, A 8.1(b)
Carrier Frequency Separation	
Minimum 25 kHz or two-thirds of the 20 dB bandwidth of the hopping system whichever is greater.	

Result:

Carrier frequency separation	~ 1 MHz
------------------------------	---------

Result: The result of the measurement is passed.

Plot 1: Carrier Frequency Separation (GFSK)

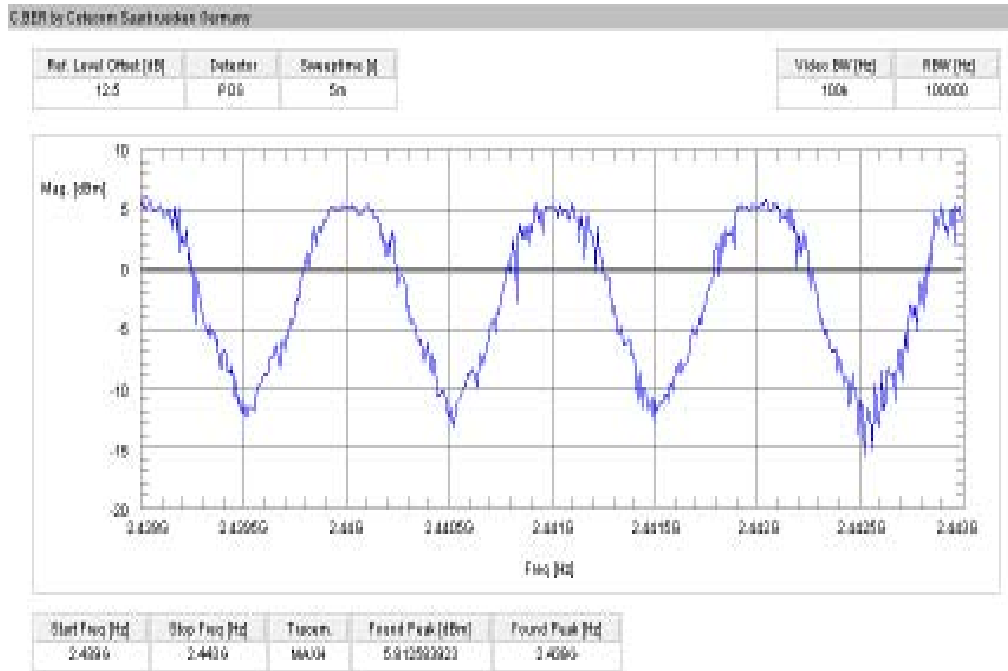

9.4 Number of hopping channels

Description:

Measurement of the total number of used hopping channels. The number of hopping channels is constant for all modulation-modes. We use GFSK-modulation to show compliance. EUT in hopping mode.

Measurement:

Measurement parameter	
Detector:	Peak
Sweep time:	Auto
Video bandwidth:	500 kHz
Resolution bandwidth:	500 kHz
Span:	Plot 1: 2400 – 2445 MHz Plot 2: 2445 – 2485 MHz
Trace-Mode:	Max Hold

Limits:

FCC	IC
CFR Part 15.247 (a)(1)	RSS 210, Issue 8, A 8.1(d)
Number of hopping channels	
At least 15 non overlapping hopping channels	

Result:

Number of hopping channels	79
----------------------------	----

Result: The result of the measurement is passed.

Plot 1: Number of hopping channels (GFSK)

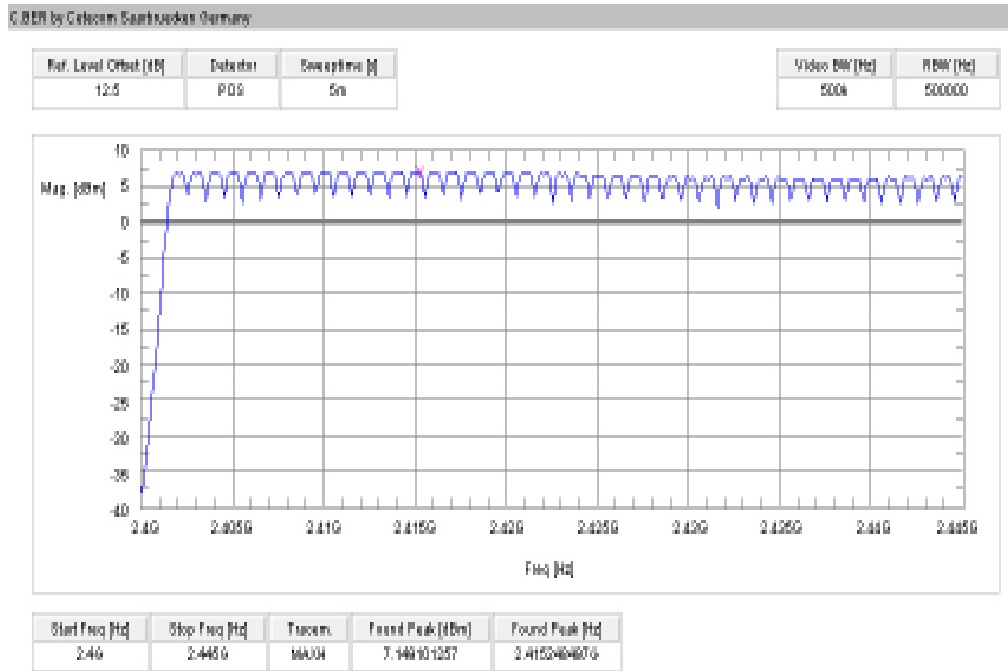

Plot 2: Number of hopping channels (GFSK)

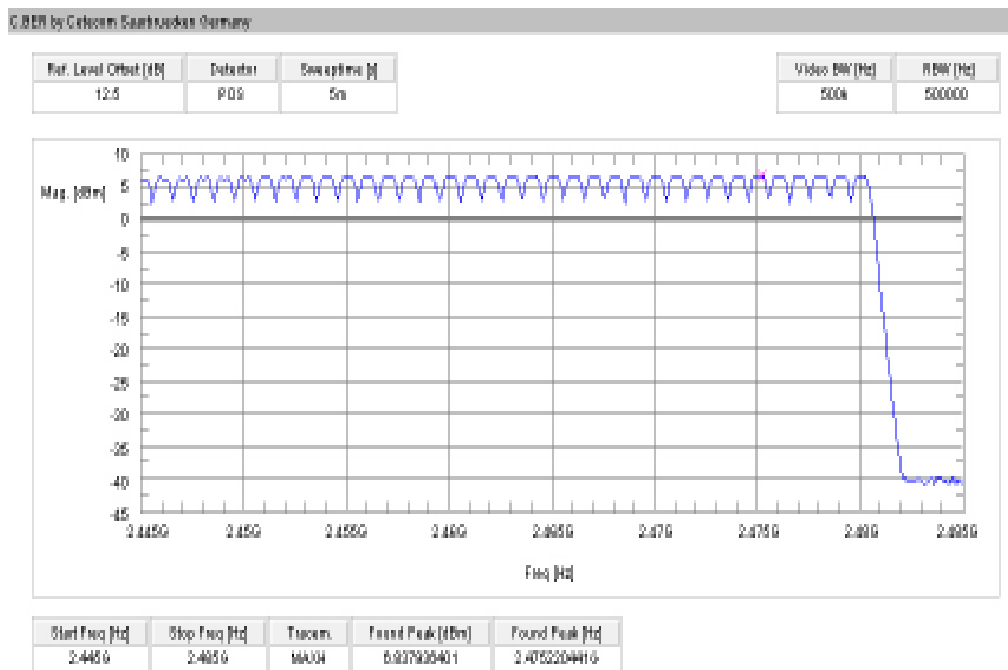

9.5 Time of occupancy (dwell time)

Measurement:

For Bluetooth® devices no measurements mandatory depending on the fixed requirements according to the Bluetooth® Core Specifications!

For Bluetooth® devices:

The channel staying time of 0.4 s within a 31.6 second period in data mode is constant for Bluetooth® devices and independent from the packet type (packet length). The calculation for a 31.6 second period is as follows:

Channel staying time = time slot length * hop rate / number of hopping channels * 31.6 s

Example for a DH1 packet (with a maximum length of one time slot)
 Channel staying time = $625 \mu\text{s} * 1600 * 1/\text{s} / 79 * 31.6 \text{ s} = 0.4 \text{ s}$ (in a 31.6 s period)

For multi-slot packets the hopping is reduced according to the length of the packet.

Example for a DH3 packet (with a maximum length of three time slots)
 Channel staying time = $3 * 625 \mu\text{s} * 1600/3 * 1/\text{s} / 79 * 31.6 \text{ s} = 0.4 \text{ s}$ (in a 31.6 s period)

Example for a DH5 packet (with a maximum length of five time slots)
 Channel staying time = $5 * 625 \mu\text{s} * 1600/5 * 1/\text{s} / 79 * 31.6 \text{ s} = 0.4 \text{ s}$ (in a 31.6 s period)

This is according to the Bluetooth® Core Specification V2.0 & V2.1 & V3.0 & V4.0 (+ critical errata) for all Bluetooth® devices.

The following table shows the relations:

Packet Size	Pulse Width [ms] *	Max. number of transmissions per channel in 31.6 sec
DH1	0.366	640
DH3	1.622	214
DH5	2.870	128

* according Bluetooth® specification

Result:

Packet Size	Pulse Width [ms]*	Max. number of transmissions in 31.6 sec	Dwell time [Pulse width * Number of transmissions]
DH1	0.366	640	234.2 ms
DH3	1.622	214	347.1 ms
DH5	2.870	128	367.4 ms

Limits:

FCC	IC
CFR Part 15.247 (a)(1)(iii)	RSS 210, Issue 8, A 8.3(1)
Time of occupancy (dwell time)	
The frequency hopping operation shall have an average time of occupancy on any frequency not exceeding 0.4 seconds within a duration in seconds equal to the number of hopping frequencies multiplied by 0.4.	

Result: The result of the measurement is passed.

9.6 Spectrum bandwidth of a FHSS system – 20 dB bandwidth

Description:

Measurement of the 20dB bandwidth of the modulated signal. The measurement is performed according to the “Measurement Guidelines” (DA 00-705, March 30, 2000). EUT in single channel mode.

Measurement:

Measurement parameter	
Detector:	Peak
Sweep time:	2 s
Video bandwidth:	30 kHz
Resolution bandwidth:	10 kHz
Span:	3 MHz
Trace-Mode:	Max Hold

Limits:

FCC	IC
CFR Part 15.247 (a)(1)	RSS 210, Issue 8, A 8.2(a)
Spectrum bandwidth of a FHSS system – 20 dB bandwidth	
GFSK < 1000 kHz Pi/4 DQPSK < 1500 kHz 8DPSK < 1500 kHz	

Result:

Modulation	20 dB BANDWIDTH [kHz]		
	2402 MHz	2441 MHz	2480 MHz
Frequency			
GFSK	944	938	938
Pi/4 DQPSK	1335	1335	1335
8DPSK	1305	1305	1311
Measurement uncertainty	± 30 kHz		

Result: The result of the measurement is passed.

Plot 1: Channel 00 / GFSK

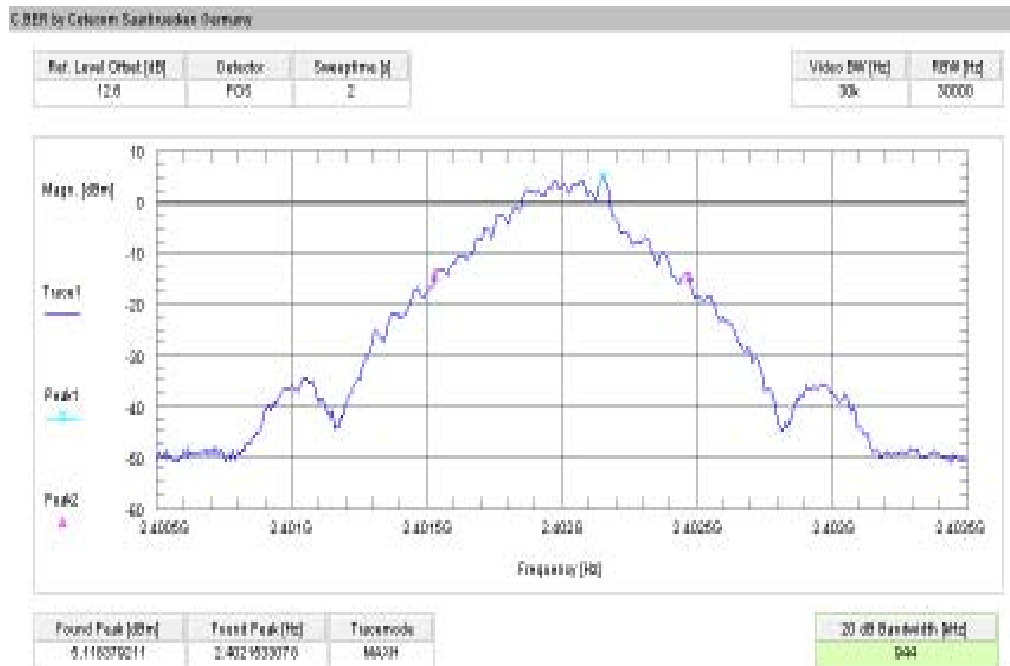

Plot 2: Channel 39 / GFSK

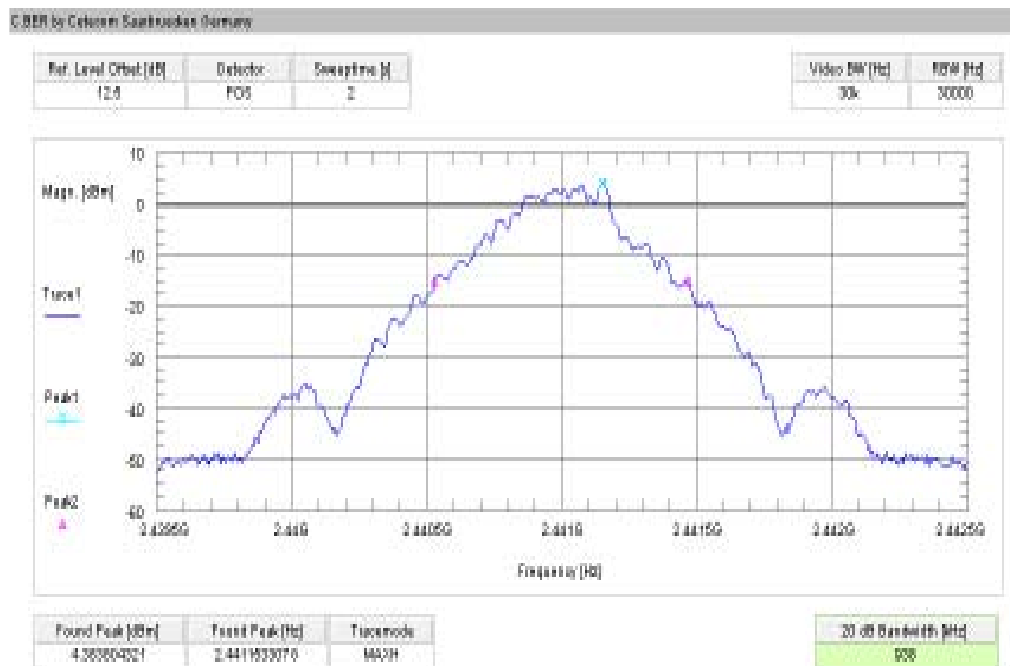

Plot 3: Channel 78 / GFSK

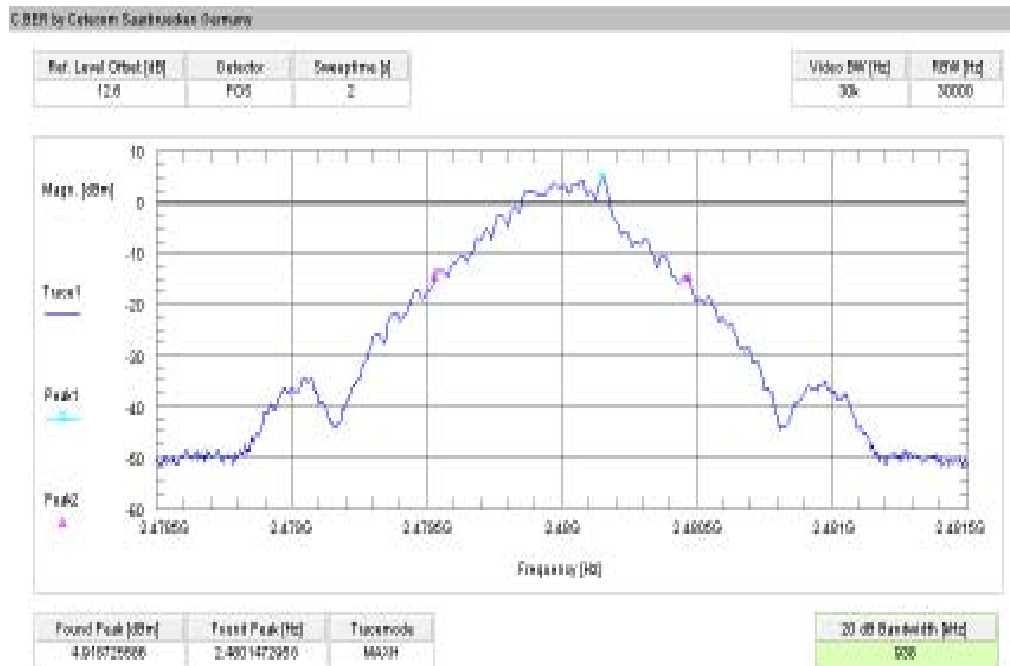

Plot 4: Channel 00 / Pi/4 DQPSK



Plot 5: Channel 39 / Pi/4 DQPSK



Plot 6: Channel 78 / Pi/4 DQPSK



Plot 7: Channel 00 / 8DPSK

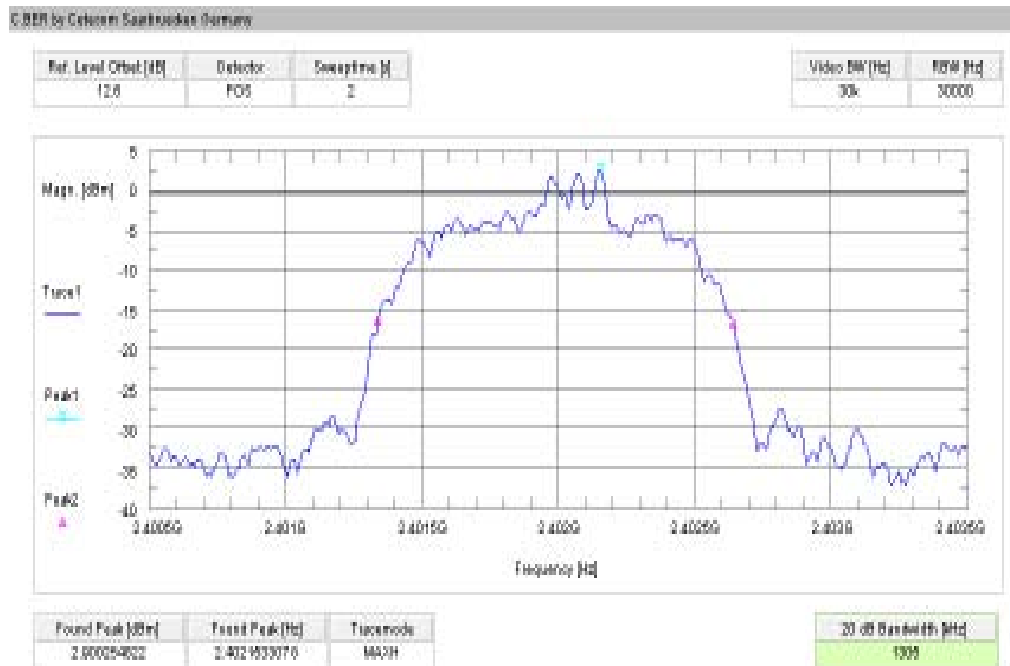

Plot 8: Channel 39 / 8DPSK

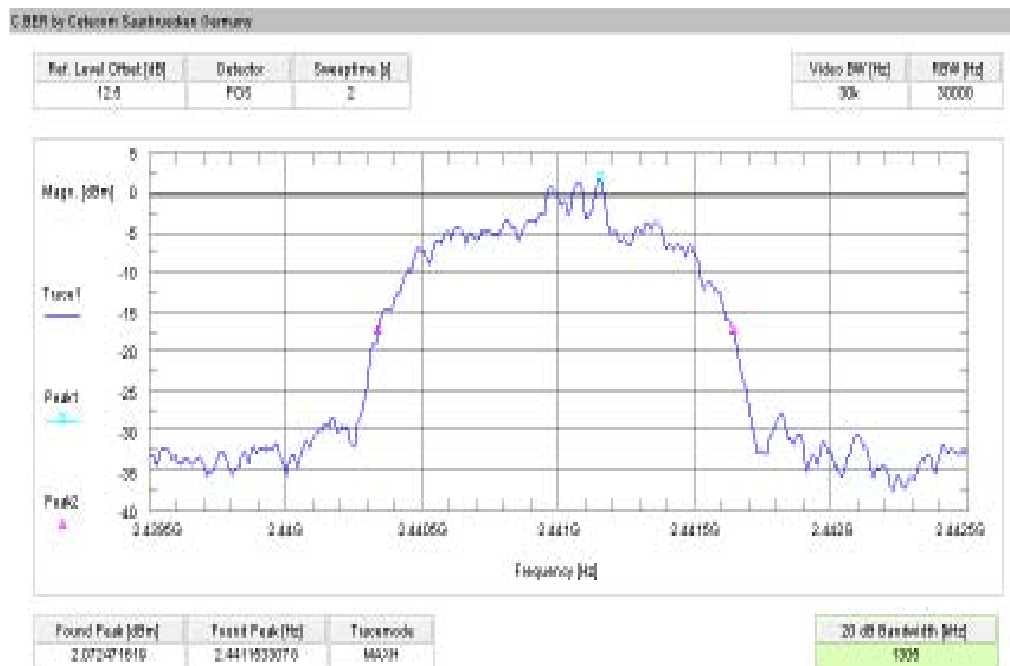

Plot 9: Channel 78 / 8DPSK

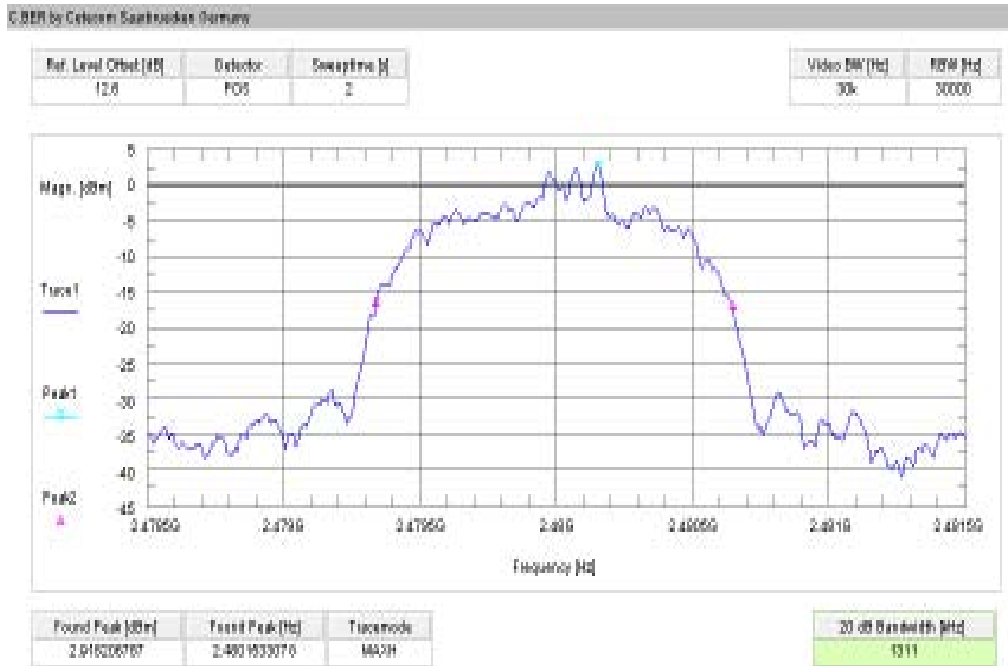

9.7 Maximum output power

Description:

Measurement of the maximum output power conducted and radiated. EUT in single channel mode.

Measurement:

Measurement parameter	
Detector:	Peak
Sweep time:	Auto
Video bandwidth:	3 MHz
Resolution bandwidth:	3 MHz
Span:	3 MHz
Trace-Mode:	Max Hold

Limits:

FCC	IC
CFR Part 15.247 (b)(1)	RSS 210, Issue 8, A 8.4(2)
Maximum output power	
[Conducted: 0.125 W – antenna gain max. 6 dBi] Systems using more than 75 hopping channels: Conducted: 1.0 W – antenna gain max. 6 dBi	

Result:

Modulation Frequency	Maximum output power conducted [dBm]		
	2402 MHz	2441 MHz	2480 MHz
GFSK	7.27	6.54	7.17
Pi/4 DQPSK	7.82	7.12	7.70
8DPSK	8.60	7.99	8.43
Measurement uncertainty	± 1 dB		

Modulation Frequency	Maximum output power radiated - EIRP [dBm]		
	2402 MHz	2441 MHz	2480 MHz
GFSK*)	4.86	3.36	2.63
Pi/4 DQPSK *)	5.41	3.94	3.16
8DPSK	6.19	4.81	3.89
Measurement uncertainty	± 3 dB		

*) - Values calculated with antenna gain

Result: [The result of the measurement is passed.](#)

Plot 1: Channel 00 / GFSK (conducted)

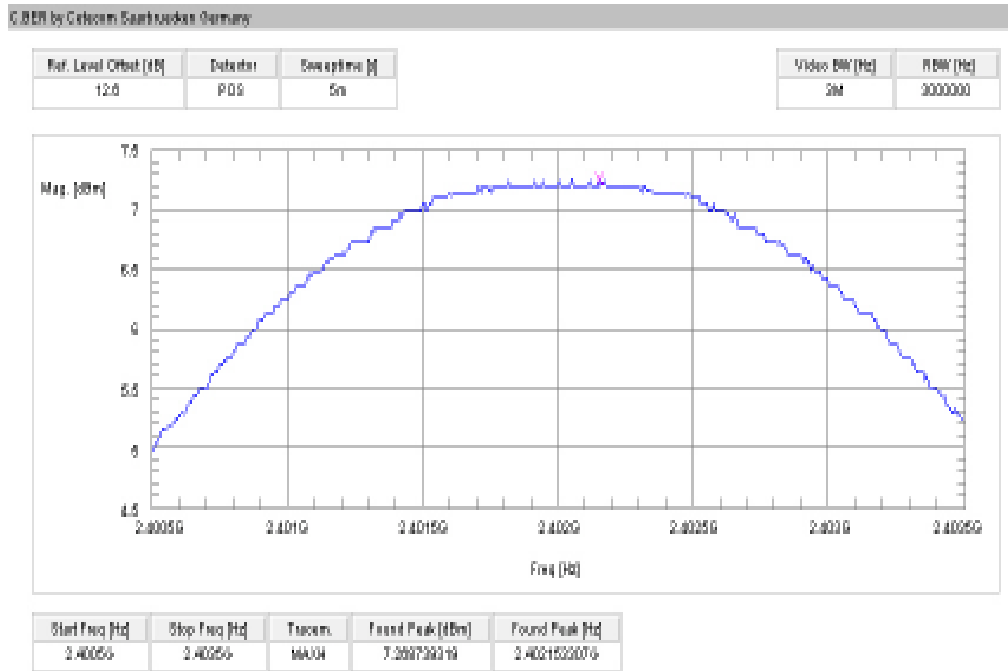

Plot 2: Channel 39 / GFSK (conducted)

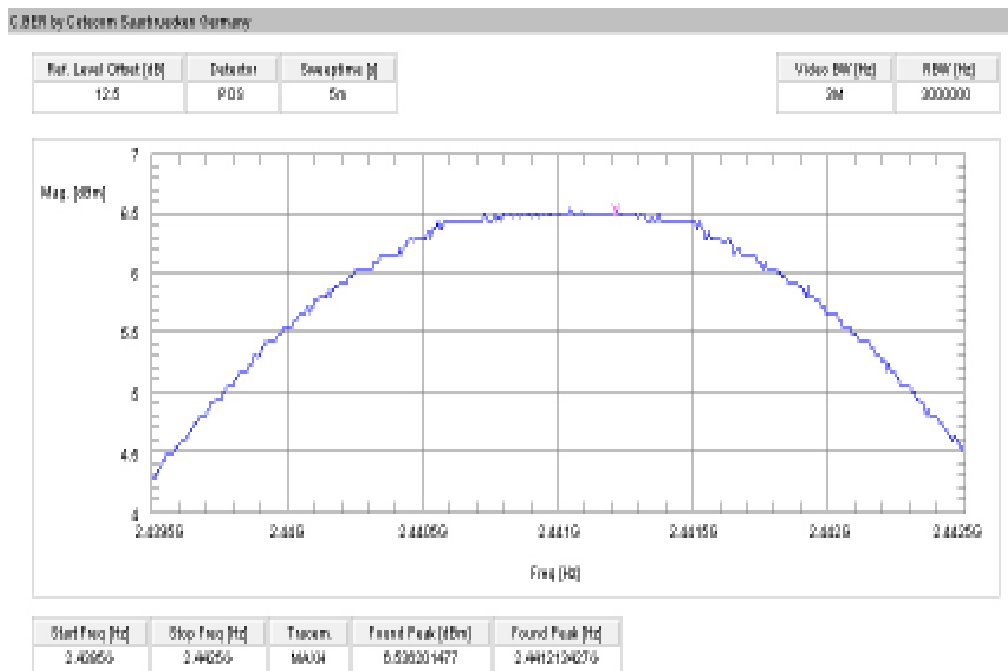

Plot 3: Channel 78 / GFSK (conducted)

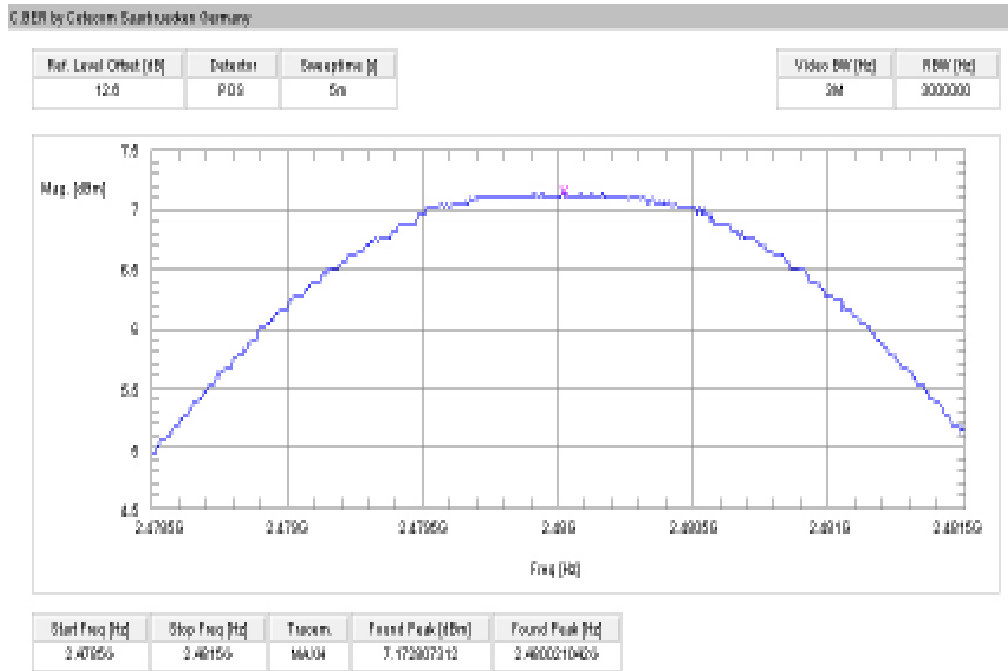

Plot 4: Channel 00 / Pi/4 DQPSK (conducted)

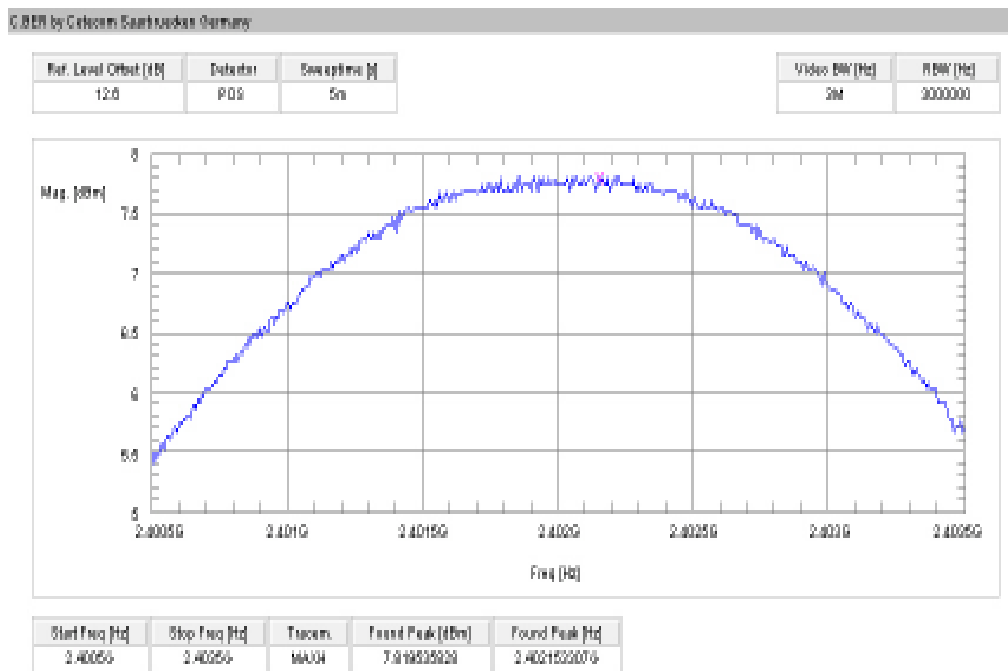

Plot 5: Channel 39 / Pi/4 DQPSK (conducted)

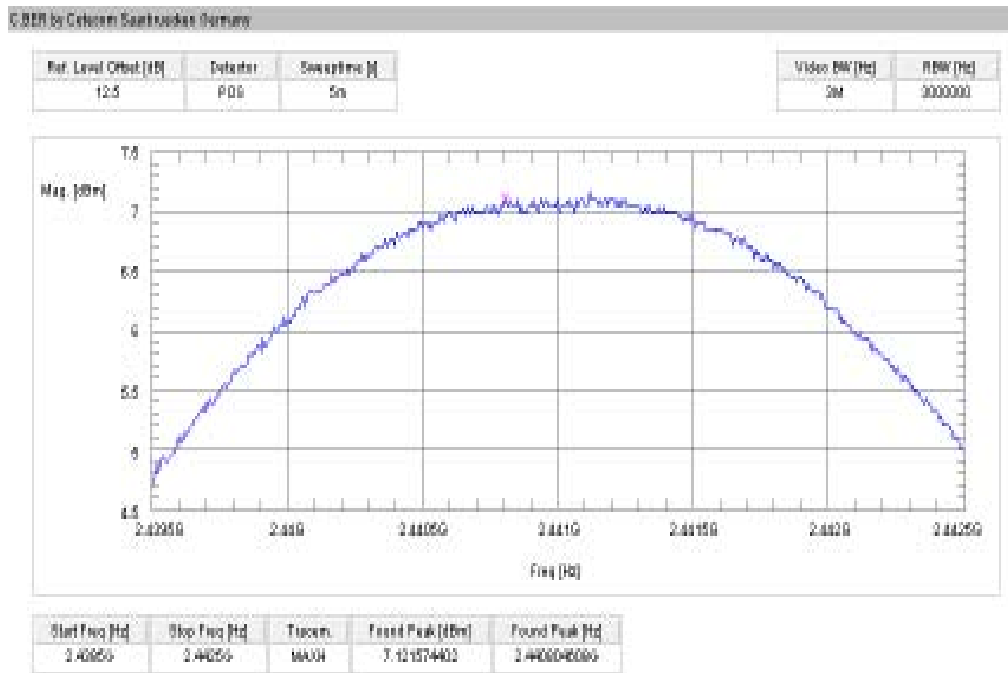

Plot 6: Channel 78 / Pi/4 DQPSK (conducted)

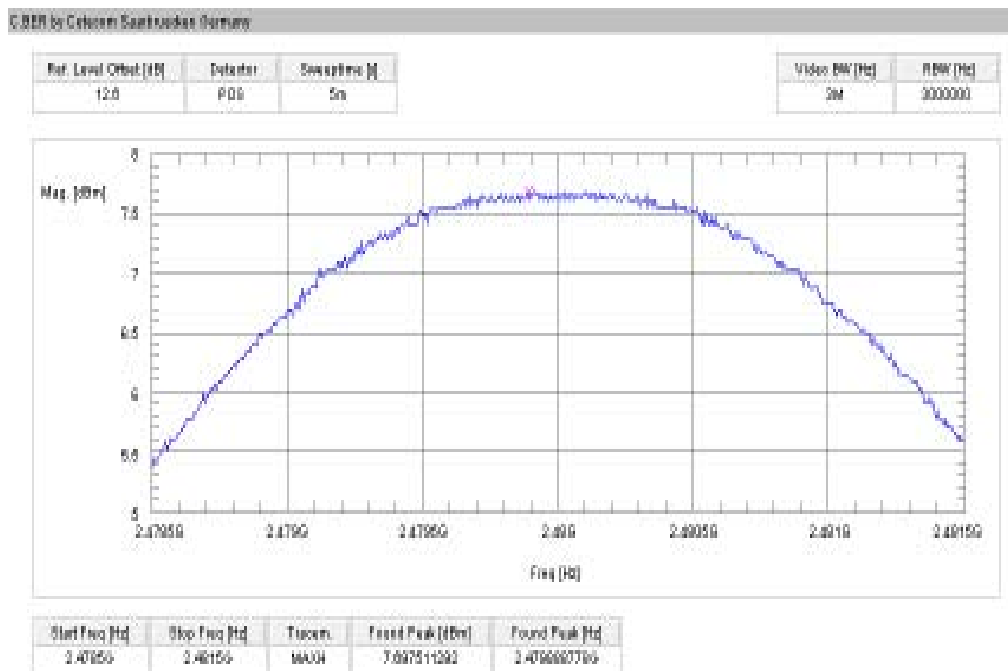

Plot 7: Channel 00 / 8DPSK (conducted)

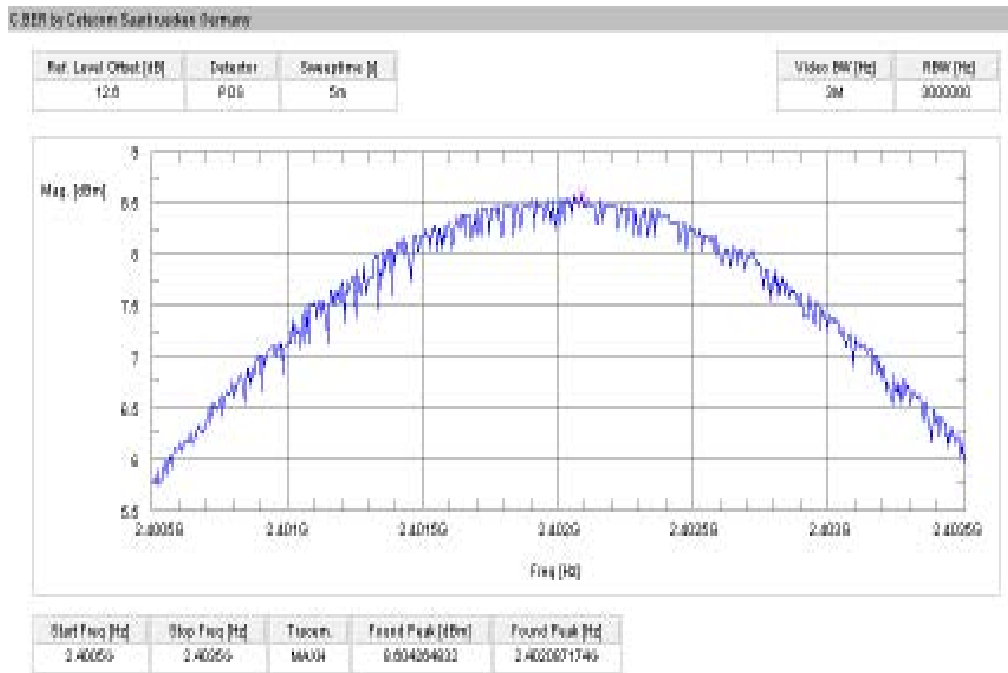

Plot 8: Channel 39 / 8DPSK (conducted)

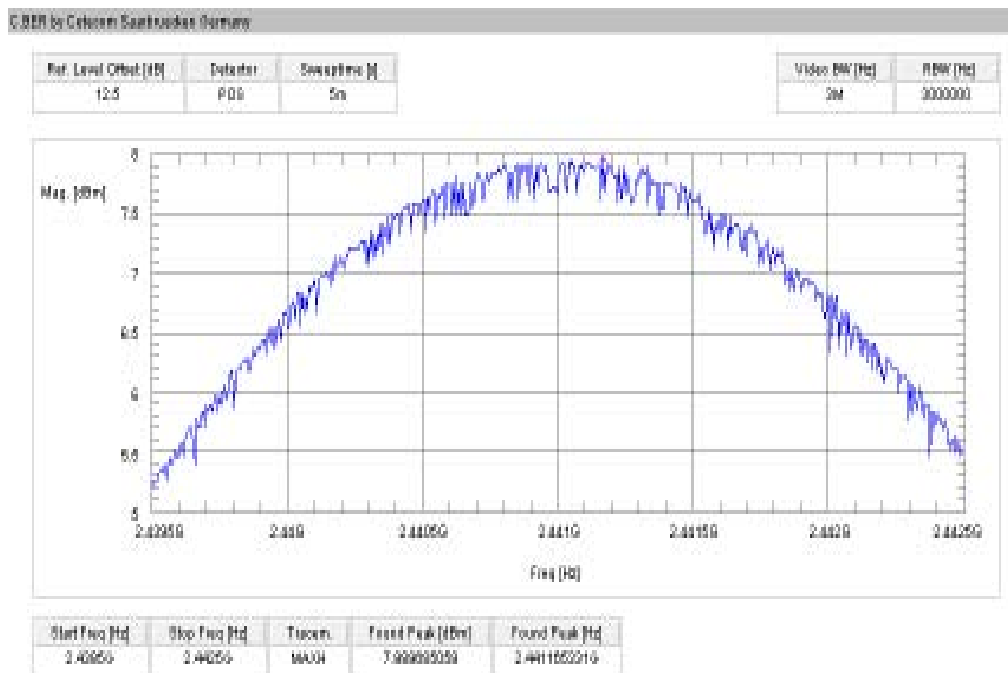

Plot 9: Channel 78 / 8DPSK (conducted)

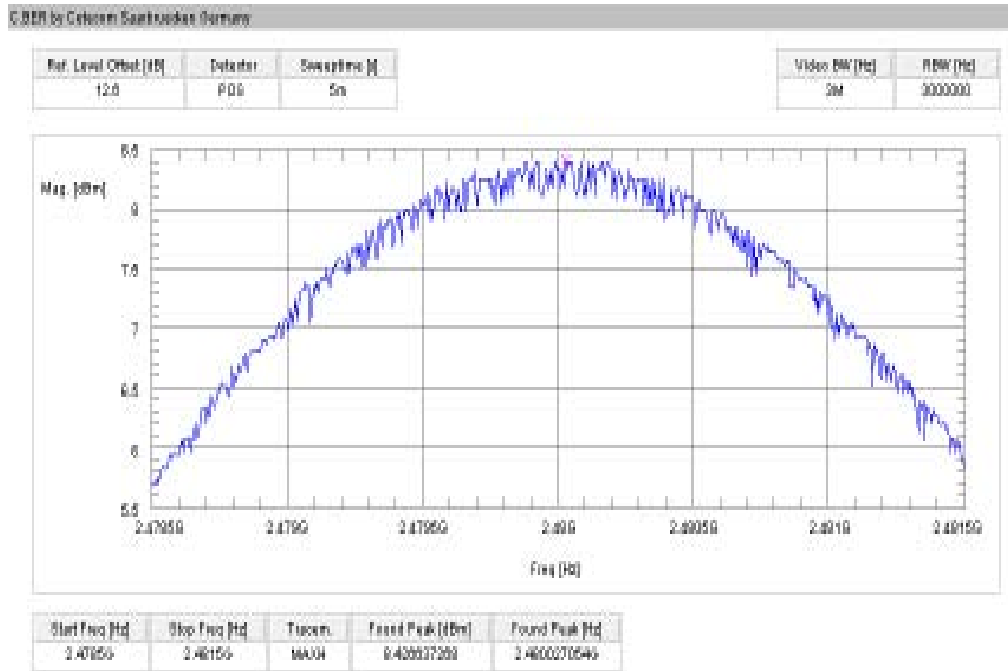

9.8 Band edge compliance conducted

Description:

Measurement of the conducted band edge compliance. EUT is measured at the lower and upper band edge in single channel and hopping mode. The measurement is repeated for all modulations.

Measurement:

Measurement parameter	
Detector:	Peak
Sweep time:	Auto
Video bandwidth:	100 kHz
Resolution bandwidth:	100 kHz
Span:	Lower Band Edge: 2395 – 2405 MHz higher Band Edge: 2478 – 2489 MHz
Trace-Mode:	Max Hold

Limits:

FCC	IC
CFR Part 15.247 (d)	RSS 210, Issue 8, A 8.5
Band edge compliance conducted	
<p>In any 100 kHz bandwidth outside the frequency band in which the spread spectrum or digitally modulated intentional radiator is operating, the radio frequency power that is produced by the intentional radiator shall be at least 20 dB below that in the 100 kHz bandwidth within the band that contains the highest level of the desired power, based on either an RF conducted or a radiated measurement. Attenuation below the general limits specified in Section 15.209(a) is not required.</p>	

Result: Also see plots

Szenario Modulation	Band edge compliance conducted [dB]		
	GFSK	Pi/4 DQPSK	8DPSK
Lower band edge – hopping off	> 20 dB	> 20 dB	> 20 dB
Lower band edge – hopping on	> 20 dB	> 20 dB	> 20 dB
Upper band edge – hopping off	> 20 dB	> 20 dB	> 20 dB
Upper band edge – hopping on	> 20 dB	> 20 dB	> 20 dB
Measurement uncertainty	± 1.5 dB		

Result: [The result of the measurement is passed.](#)

Plot 1: Lower band edge – hopping on / GFSK (conducted)

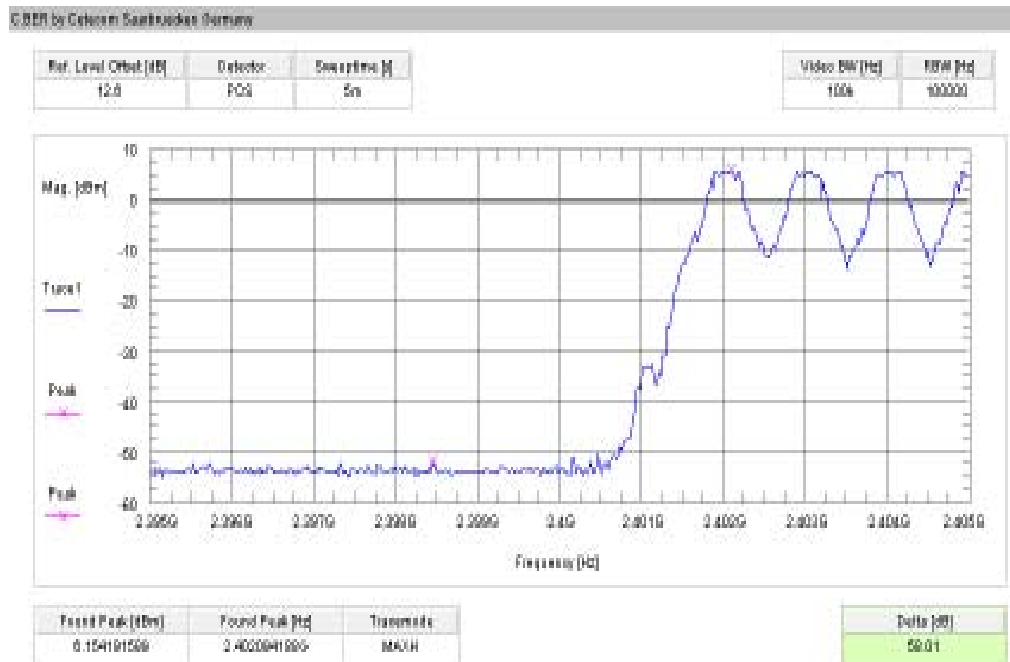

Plot 2: Upper band edge – hopping on / GFSK (conducted)

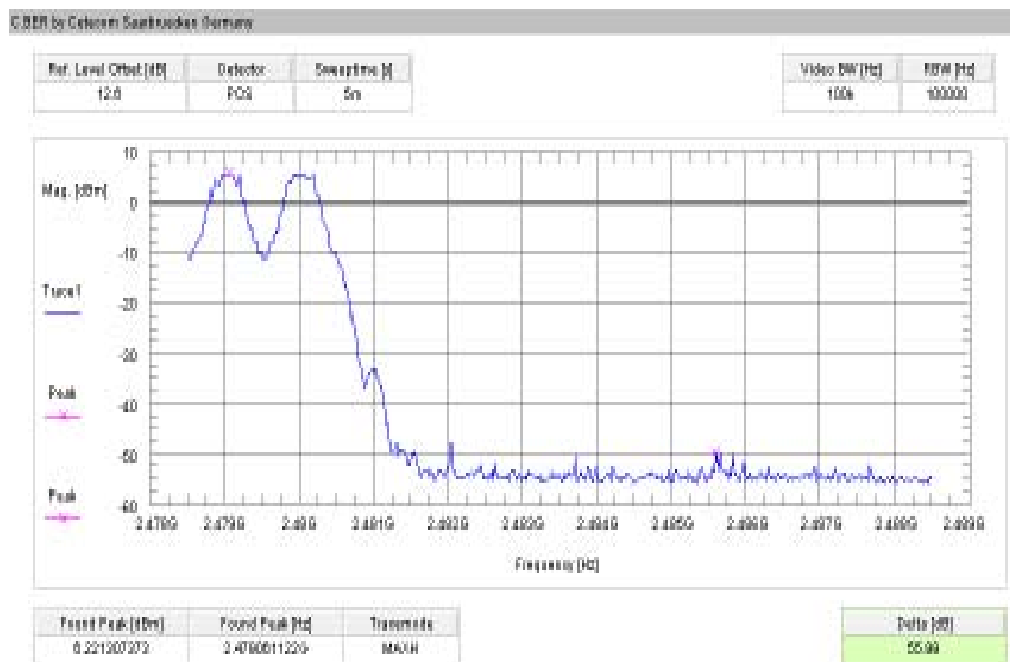

Plot 3: Lower band edge – hopping off / GFSK (conducted)

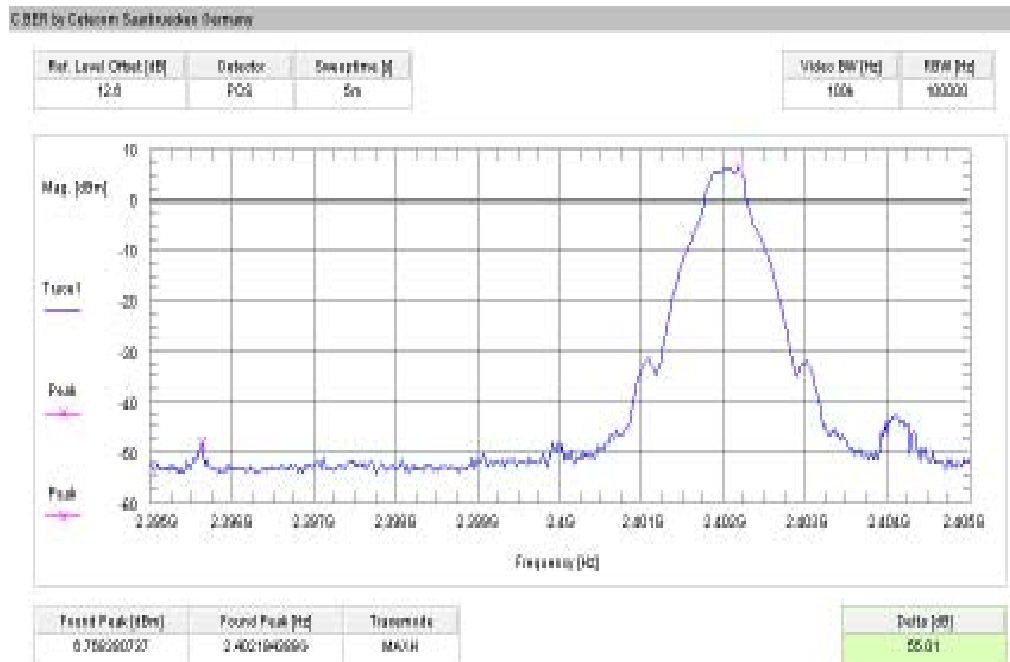

Plot 4: Upper band edge – hopping off / GFSK (conducted)

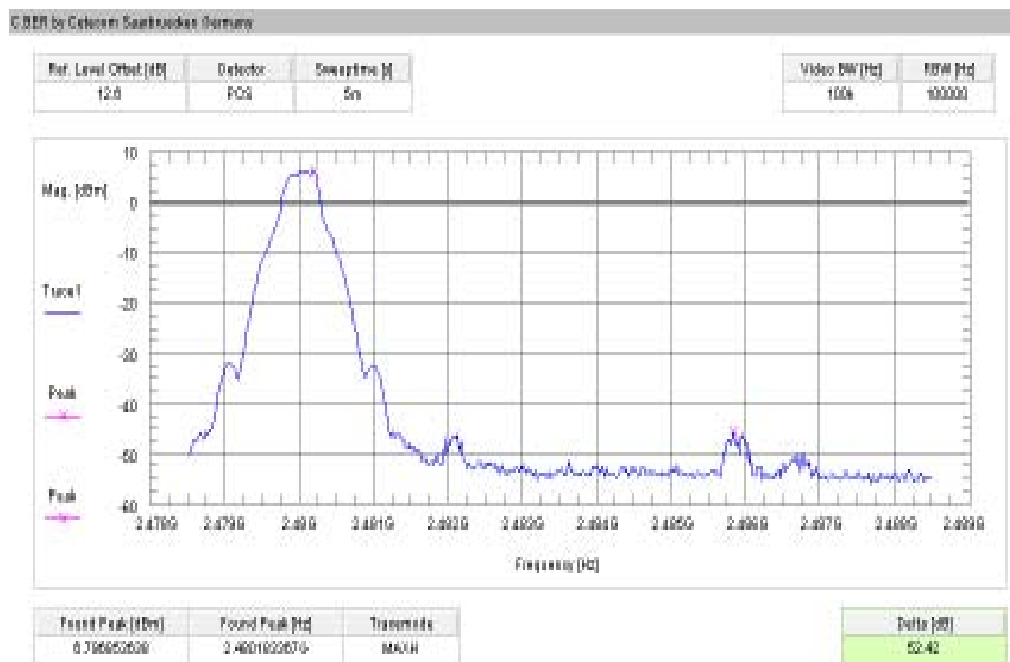

Plot 5: Lower band edge – hopping on / Pi/4 DQPSK (conducted)

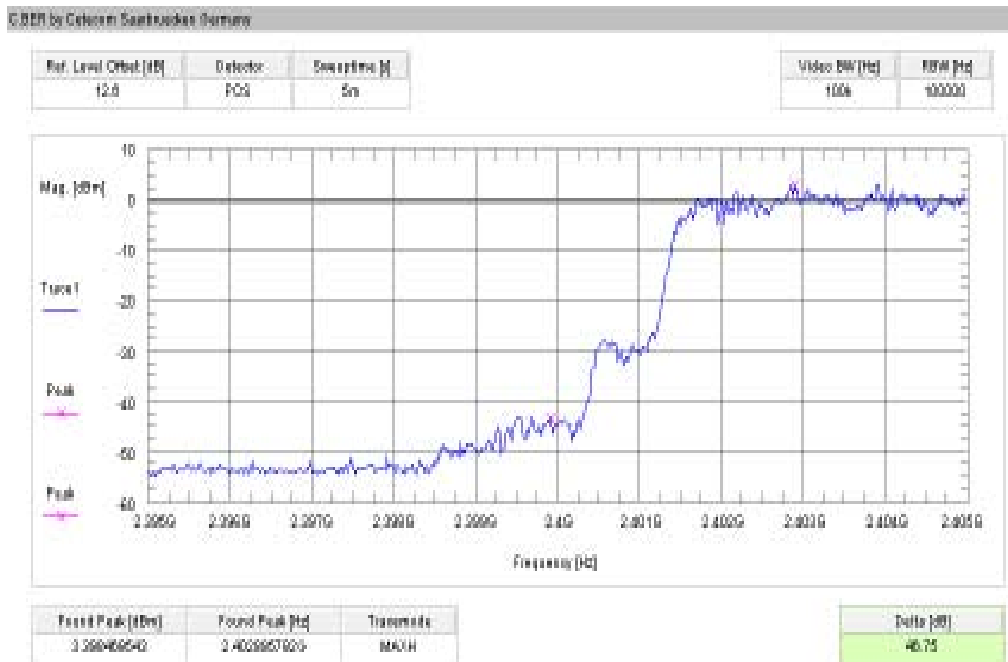

Plot 6: Upper band edge – hopping on / Pi/4 DQPSK (conducted)

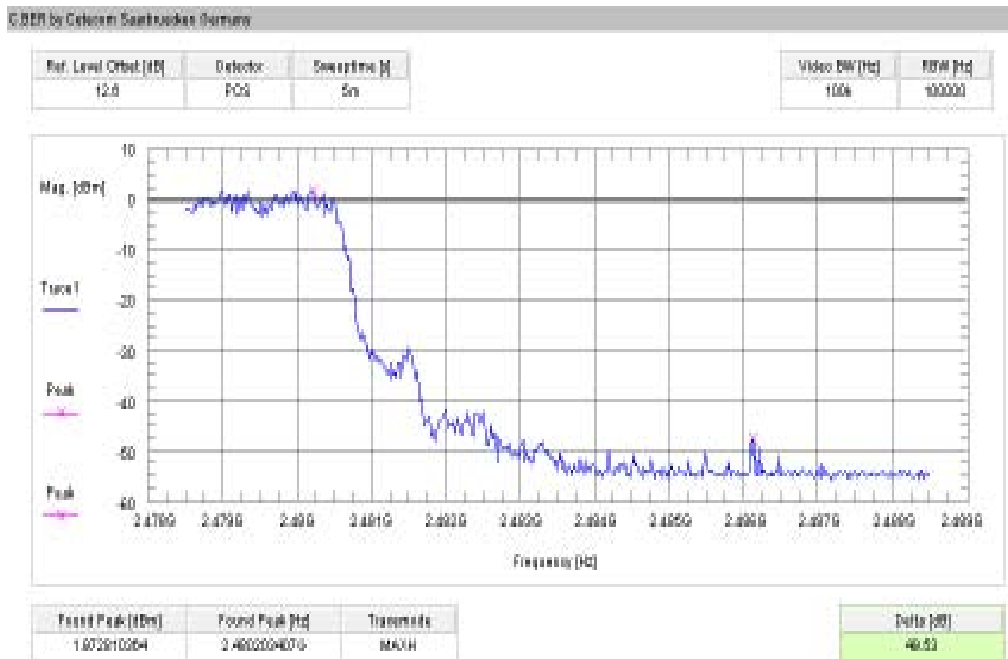

Plot 7: Lower band edge – hopping off / Pi/4 DQPSK (conducted)

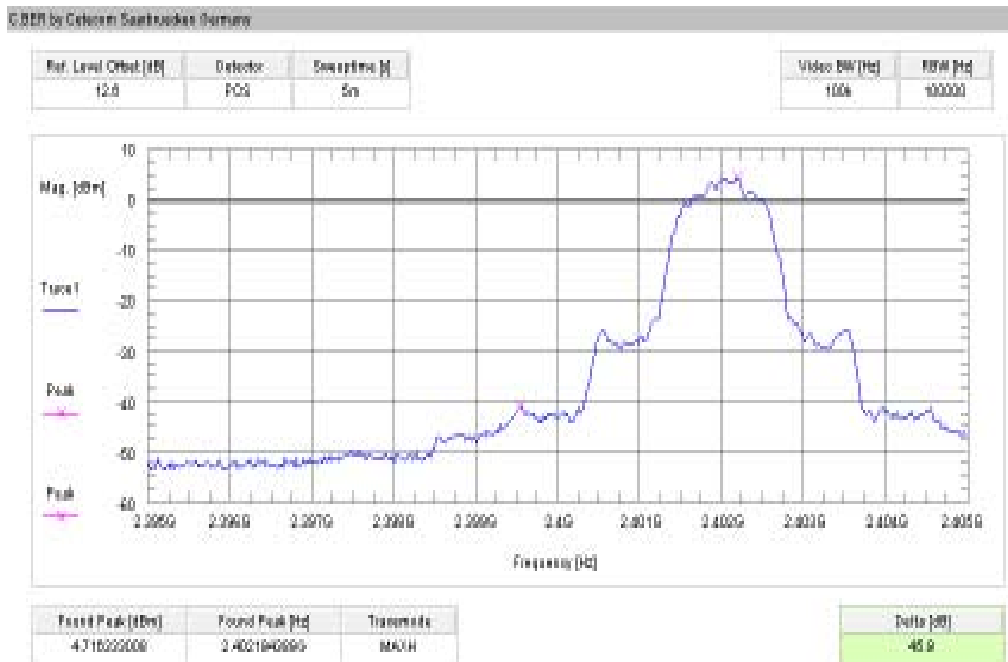

Plot 8: Upper band edge – hopping off / Pi/4 DQPSK (conducted)

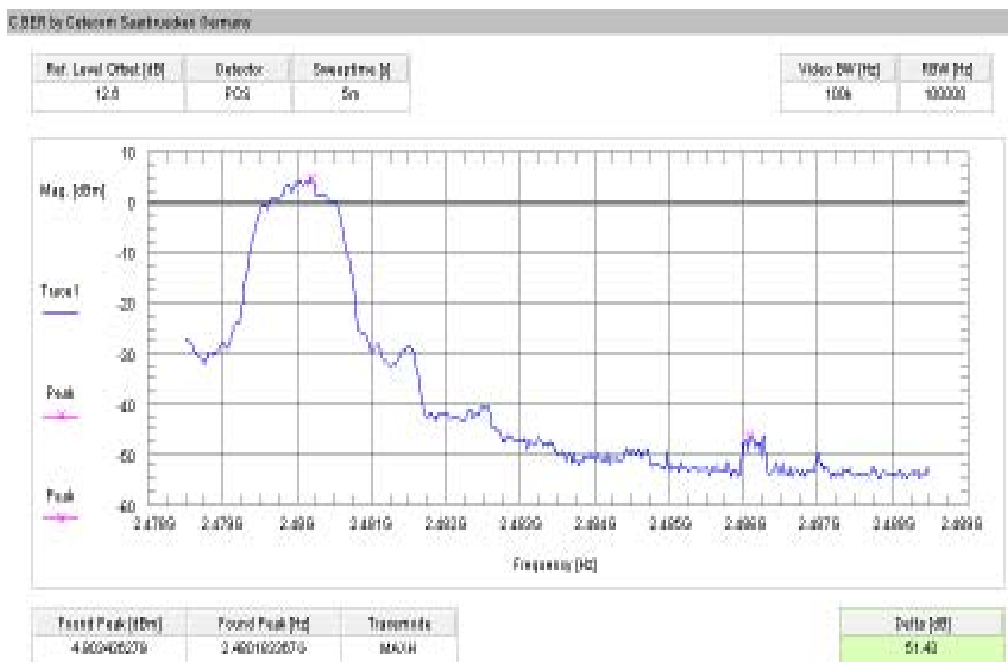

Plot 9: Lower band edge – hopping on / 8DPSK (conducted)

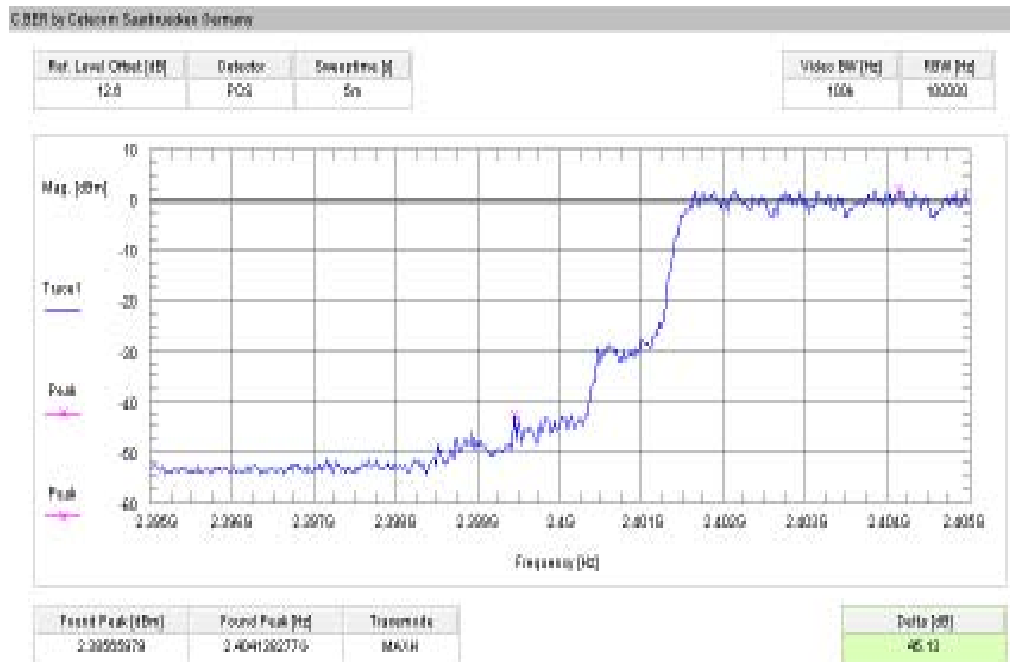

Plot 10: Upper band edge – hopping on / 8DPSK (conducted)

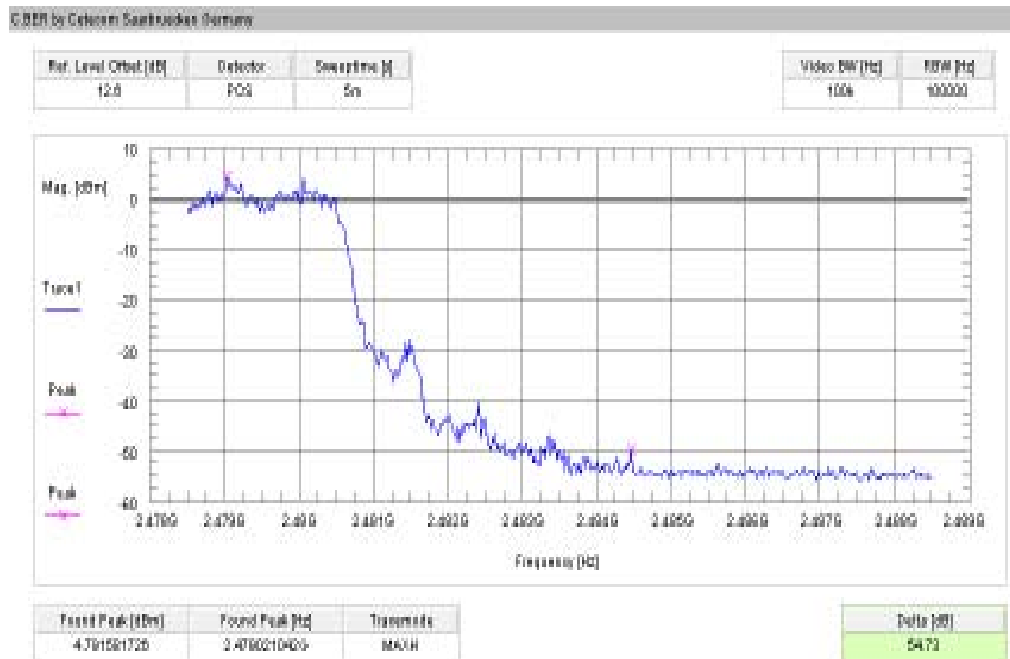

Plot 11: Lower band edge – hopping off / 8DPSK (conducted)

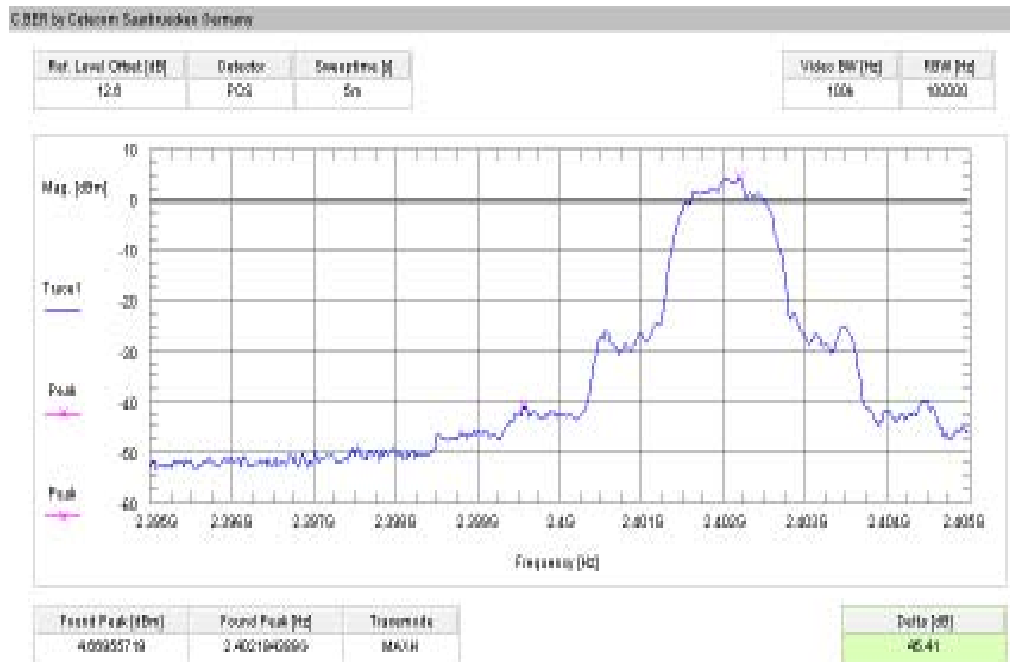

Plot 12: Upper band edge – hopping off / 8DPSK (conducted)

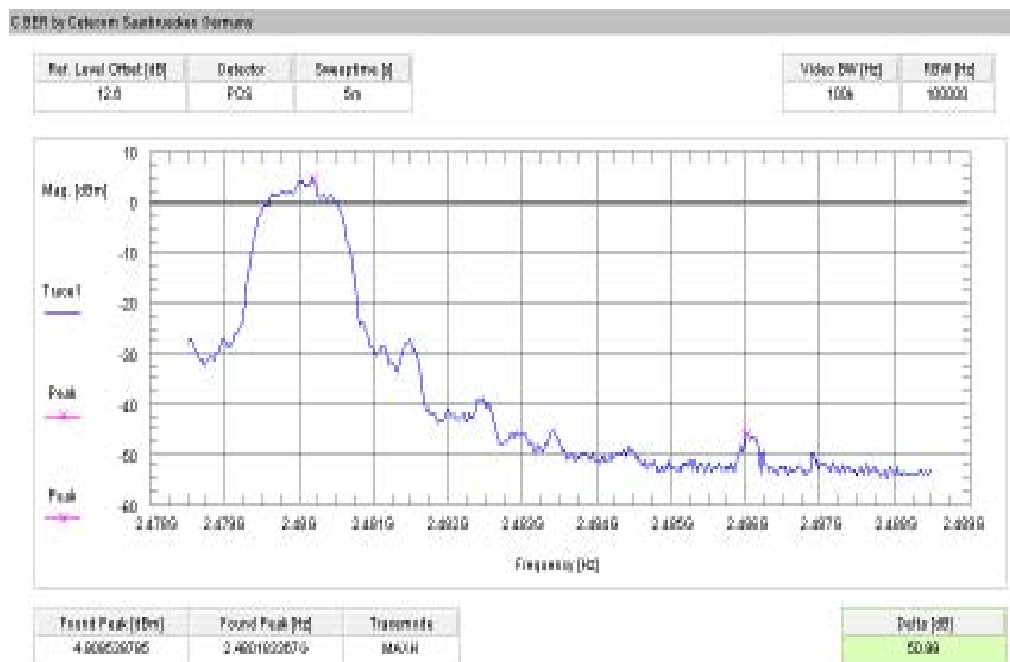

9.9 Band edge compliance radiated

Description:

Measurement of the radiated band edge compliance. The EUT is turned in the position that results in the maximum level at the band edge. Then a sweep over the corresponding restricted band is performed. The EUT is set to single channel mode and the transmit channel is channel 00 for the lower restricted band and channel 78 for the upper restricted band. The measurement is repeated for all modulations. Measurement distance is 3m.

Measurement:

Measurement parameter	
Detector:	Peak
Sweep time:	Auto
Video bandwidth:	10 Hz
Resolution bandwidth:	1 MHz
Span:	Lower Band: 2300 – 2400 MHz higher Band: 2480 – 2500 MHz
Trace-Mode:	Max Hold

Limits:

FCC	IC
CFR Part 15.205	RSS 210, Issue 8, A 8.5
Band edge compliance radiated	
<p>In any 100 kHz bandwidth outside the frequency band in which the spread spectrum or digitally modulated intentional radiator is operating, the radio frequency power that is produced by the intentional radiator shall be at least 20 dB below that in the 100 kHz bandwidth within the band that contains the highest level of the desired power, based on either an RF conducted or a radiated measurement. Attenuation below the general limits specified in Section 15.209(a) is not required. In addition, radiated emissions which fall in the restricted bands, as defined in Section 15.205(a), must also comply with the radiated emission limits specified in Section 15.209(a) (see Section 5.205(c)).</p>	
54 dB μ V/m AVG	

Result: Also see plots

Szenario Modulation	Band edge compliance radiated [dB μ V/m]		
	GFSK	Pi/4 DQPSK	8DPSK
Lower restricted band	< 54 (see plot 1)	< 54 (see plot 3)	< 54 (see plot 5)
Upper restricted band	< 54 (see plot 2)	< 54 (see plot 4)	< 54 (see plot 6)
Measurement uncertainty	\pm 3 dB		

Result: The result of the measurement is passed.

Plot 1: Lower Restricted Band / GFSK (radiated), vertical polarization

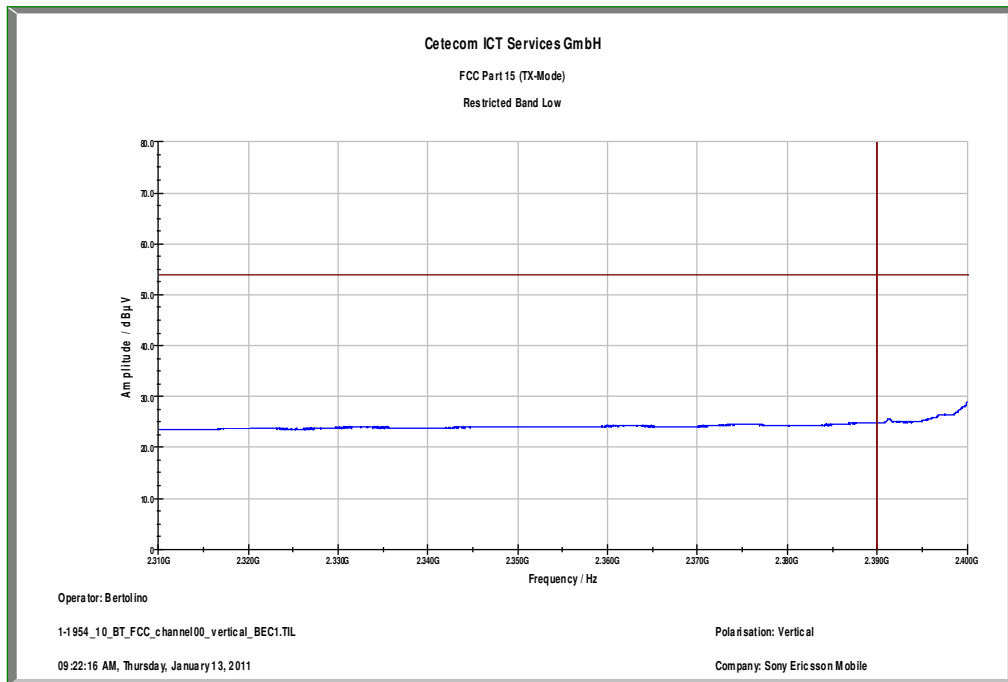

Plot 2: Upper Restricted Band / GFSK (radiated), vertical polarization

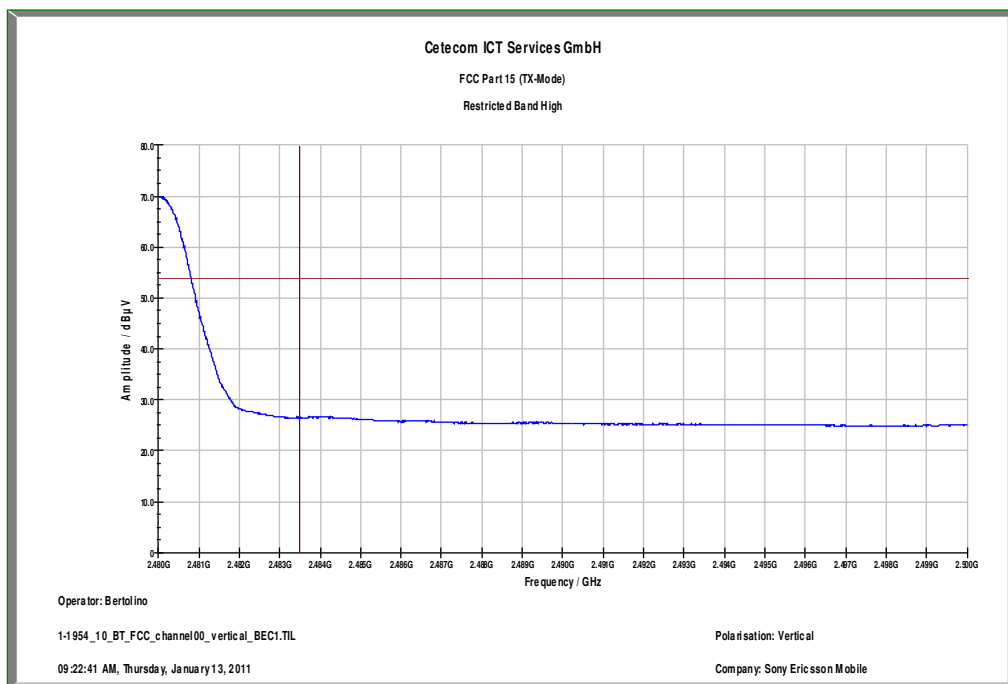

Plot 3: Lower Restricted Band / GFSK (radiated), horizontal polarization

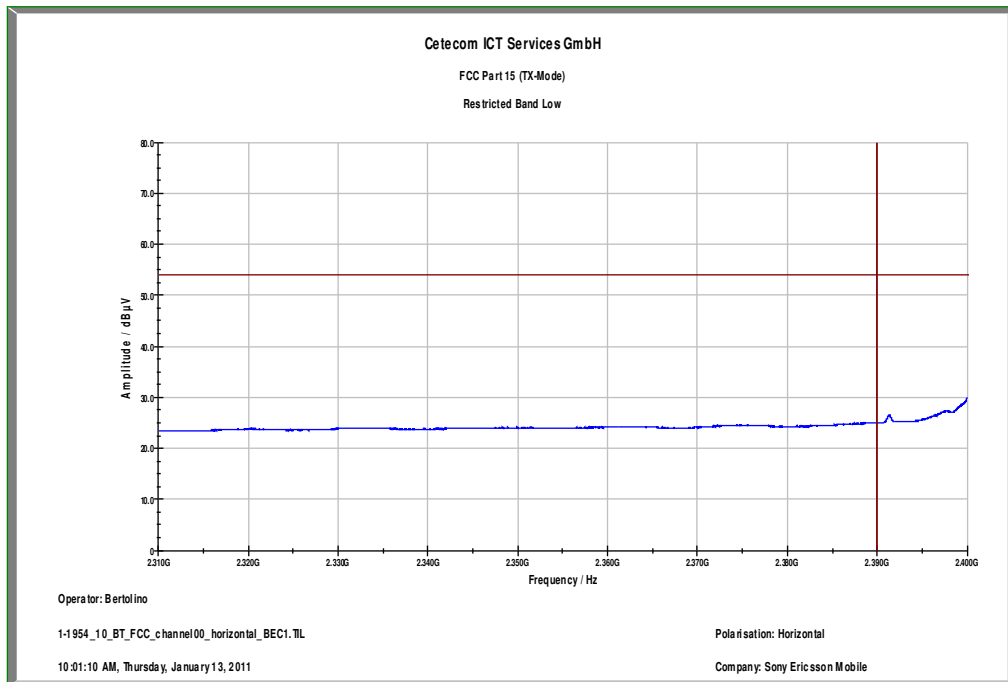

Plot 4: Upper Restricted Band / GFSK (radiated), horizontal polarization

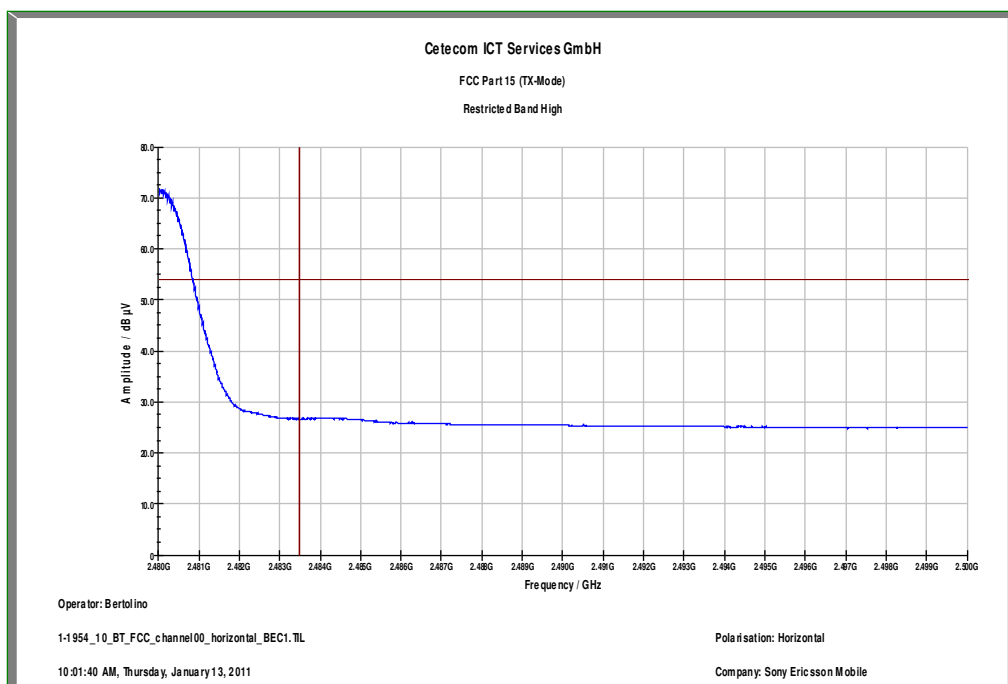

Plot 5: Lower Restricted Band / Pi/4 DQPSK (radiated), vertical polarization

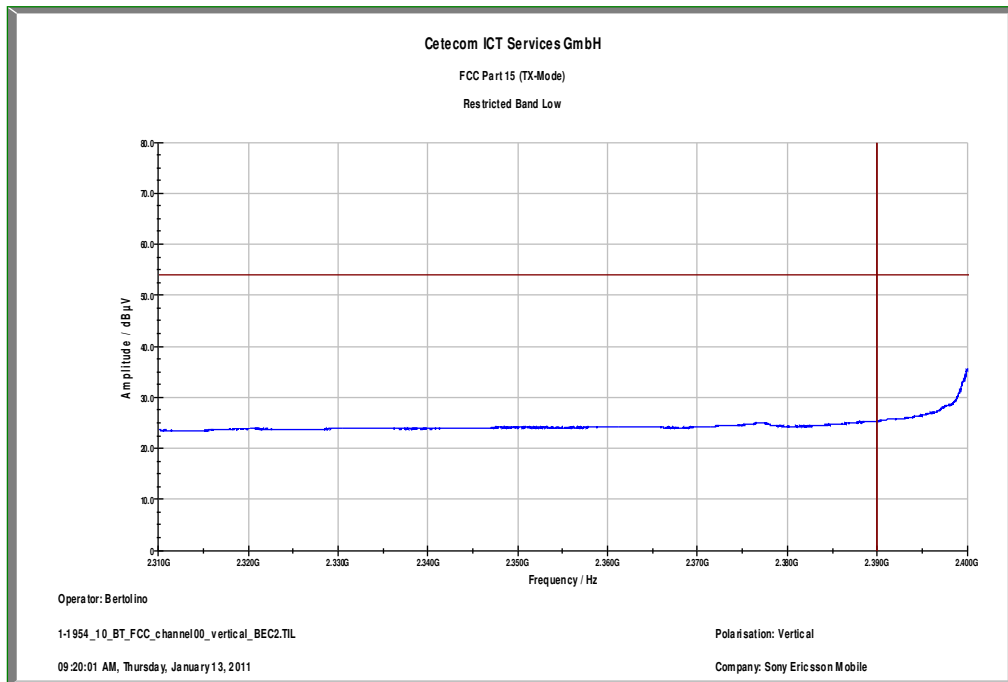

Plot 6: Upper Restricted Band / Pi/4 DQPSK (radiated), vertical polarization

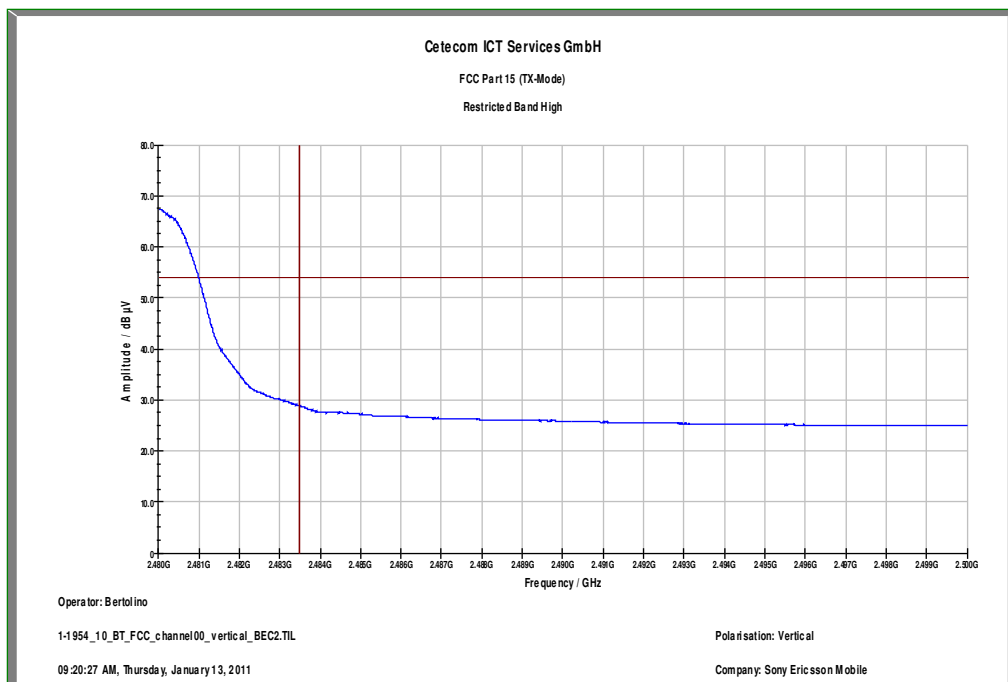

Plot 7: Lower Restricted Band / Pi/4 DQPSK (radiated), horizontal polarization

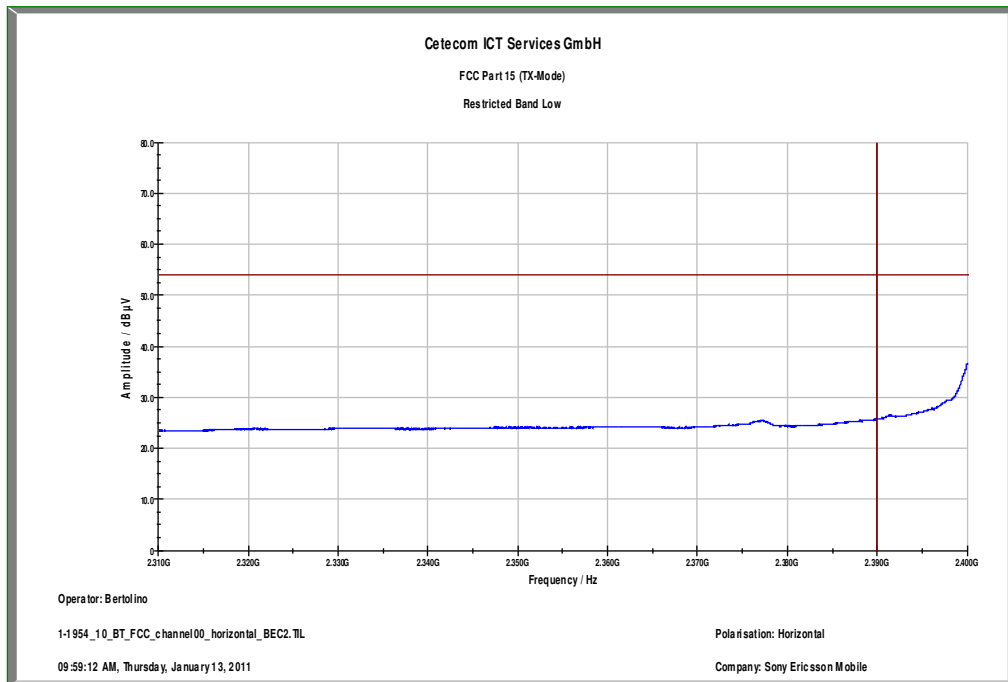

Plot 8: Upper Restricted Band / Pi/4 DQPSK (radiated), horizontal polarization

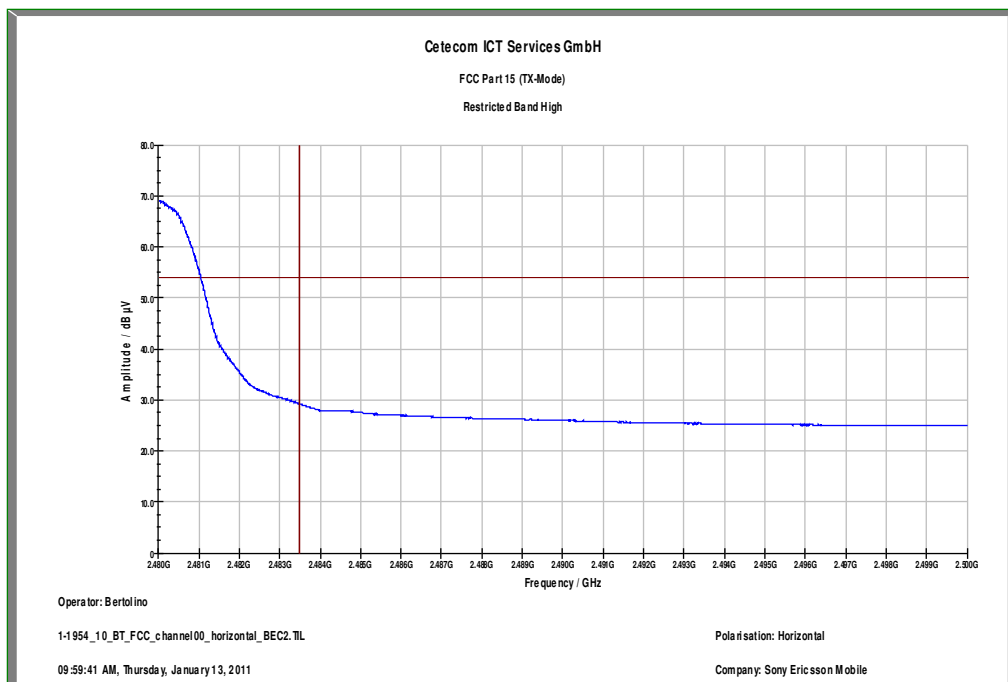

Plot 9: Lower Restricted Band / 8DPSK (radiated), vertical polarization

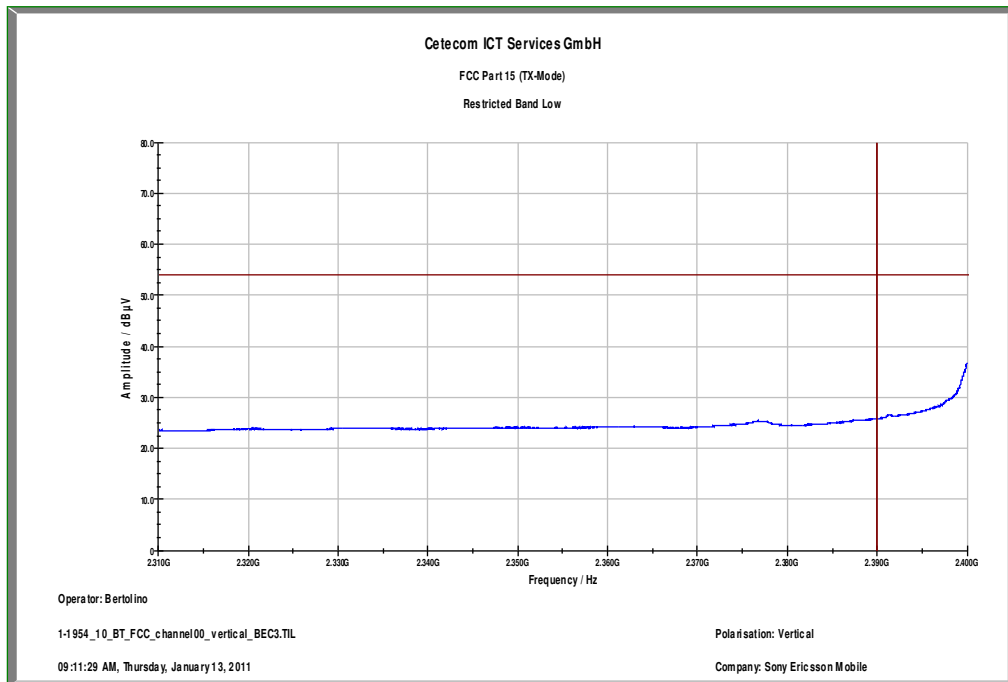

Plot 10: Upper Restricted Band / 8DPSK (radiated), vertical polarization

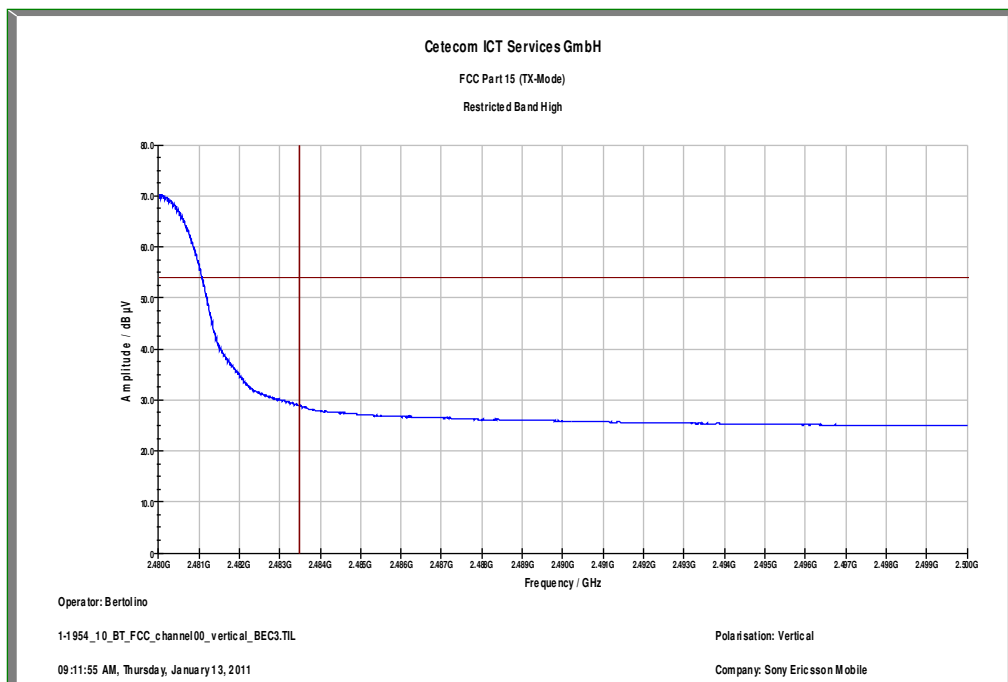

Plot 11: Lower Restricted Band / 8DPSK (radiated), horizontal polarization

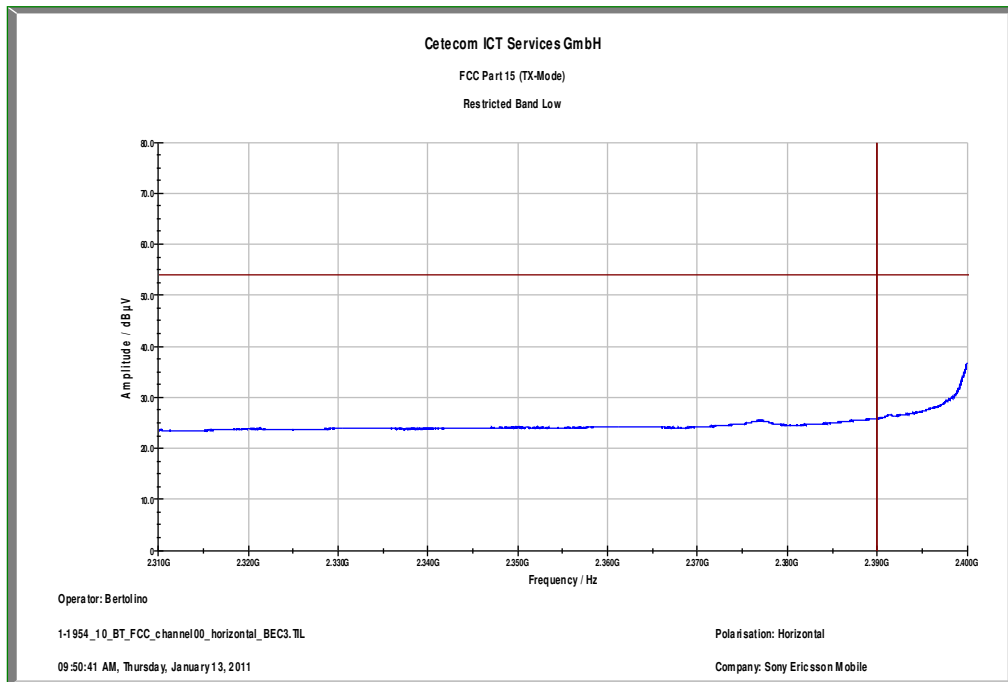

Plot 12: Upper Restricted Band / 8DPSK (radiated), horizontal polarization

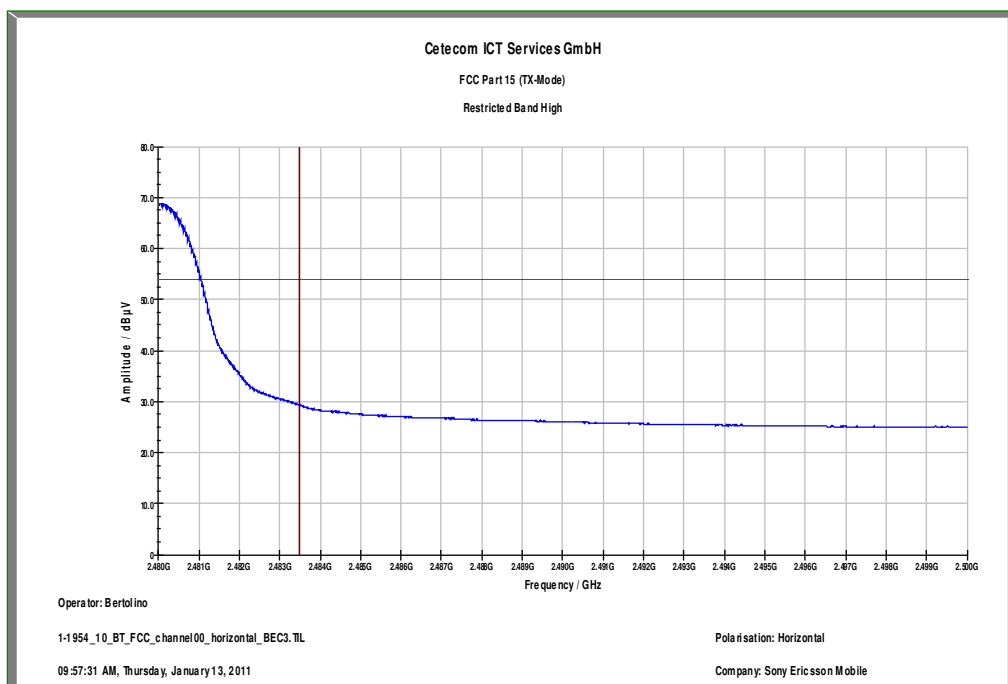

9.10 TX spurious emissions conducted

Description:

Measurement of the conducted spurious emissions in transmit mode. The EUT is set to single channel mode and the transmit channel is channel 00, channel 39 and channel 78. The measurement is repeated for all modulations.

Measurement:

Measurement parameter	
Detector:	Peak
Sweep time:	Auto
Video bandwidth:	F < 1 GHz: 100 kHz F > 1 GHz: 1 MHz
Resolution bandwidth:	F < 1 GHz: 100 kHz F > 1 GHz: 1 MHz
Span:	9 kHz to 25 GHz
Trace-Mode:	Max Hold

Limits:

FCC	IC
CFR Part 15.247(d)	RSS 210, Issue 8, A 8.5
TX spurious emissions conducted	
<p>In any 100 kHz bandwidth outside the frequency band in which the spread spectrum or digitally modulated intentional radiator is operating, the radio frequency power that is produced by the intentional radiator shall be at least 20 dB below that in the 100 kHz bandwidth within the band that contains the highest level of the desired power, based on either an RF conducted or a radiated measurement. Attenuation below the general limits specified in Section 15.209(a) is not required</p>	

Result: Also see plots

TX spurious emissions conducted					
GFSK - mode					
f [MHz]		amplitude of emission [dBm]	limit max. allowed emission power	actual attenuation below frequency of operation [dB]	results
2402		6.59	30 dBm		Operating frequency
<i>No critical peaks found – all detected emissions are below the 20 dBc criteria.</i>			-20 dBc		complies
2441		6.03	30 dBm		Operating frequency
<i>No critical peaks found – all detected emissions are below the 20 dBc criteria.</i>			-20 dBc		complies
2480		6.66	30 dBm		Operating frequency
<i>No critical peaks found – all detected emissions are below the 20 dBc criteria.</i>			-20 dBc		complies
Measurement uncertainty		± 3 dB			

TX spurious emissions conducted					
Pi/4-DQPSK - mode					
f [MHz]		amplitude of emission [dBm]	limit max. allowed emission power	actual attenuation below frequency of operation [dB]	results
2402		6.75	30 dBm		Operating frequency
<i>No critical peaks found – all detected emissions are below the 20 dBc criteria.</i>			-20 dBc		complies
2441		6.18	30 dBm		Operating frequency
<i>No critical peaks found – all detected emissions are below the 20 dBc criteria.</i>			-20 dBc		complies
2480		6.81	30 dBm		Operating frequency
<i>No critical peaks found – all detected emissions are below the 20 dBc criteria.</i>			-20 dBc		complies
Measurement uncertainty		± 3dB			

TX spurious emissions conducted					
8DPSK - mode					
f [MHz]		amplitude of emission [dBm]	limit max. allowed emission power	actual attenuation below frequency of operation [dB]	results
2402		7.21	30 dBm		Operating frequency
<i>No critical peaks found – all detected emissions are below the 20 dBc criteria.</i>			-20 dBc		complies
2441		6.66	30 dBm		Operating frequency
<i>No critical peaks found – all detected emissions are below the 20 dBc criteria.</i>			-20 dBc		complies
2480		7.21	30 dBm		Operating frequency
<i>No critical peaks found – all detected emissions are below the 20 dBc criteria.</i>			-20 dBc		complies
Measurement uncertainty		± 3dB			

Result: The result of the measurement is passed.

Plot 1: Channel 00 / GFSK

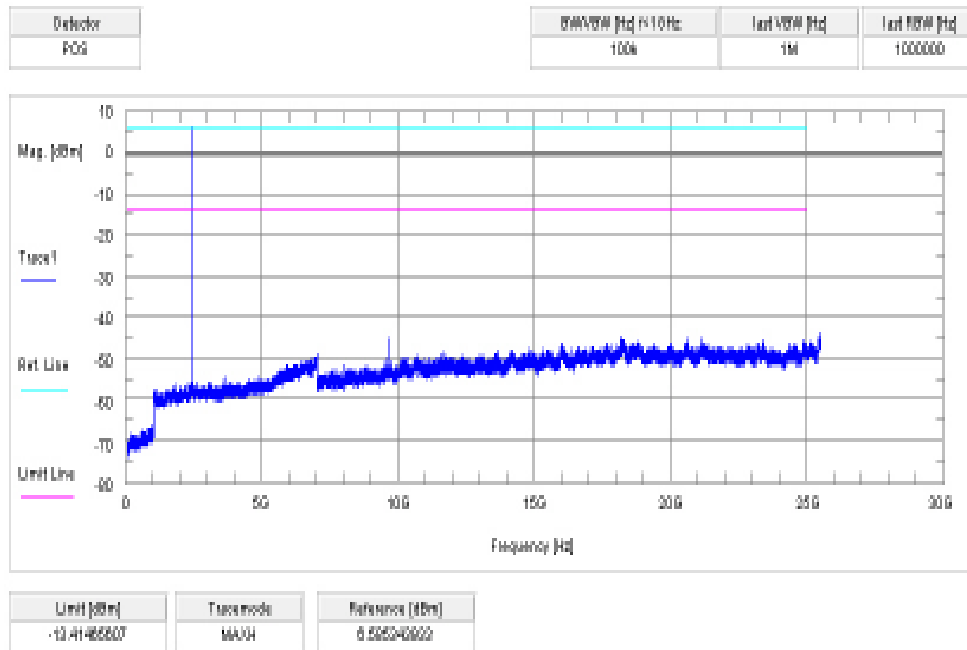

Plot 2: Channel 39 / GFSK

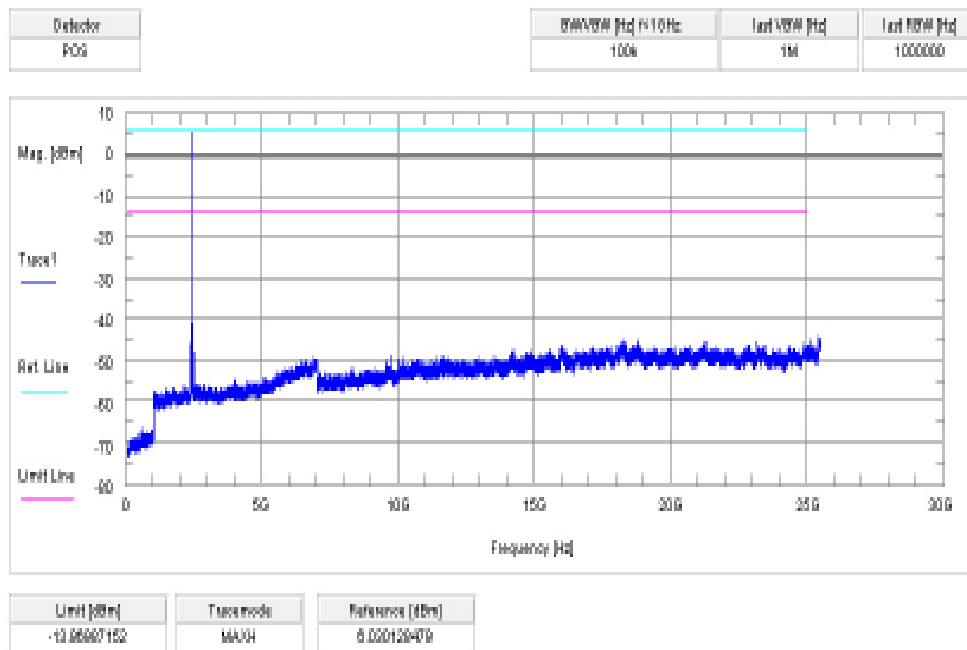

Plot 3: Channel 78 / GFSK

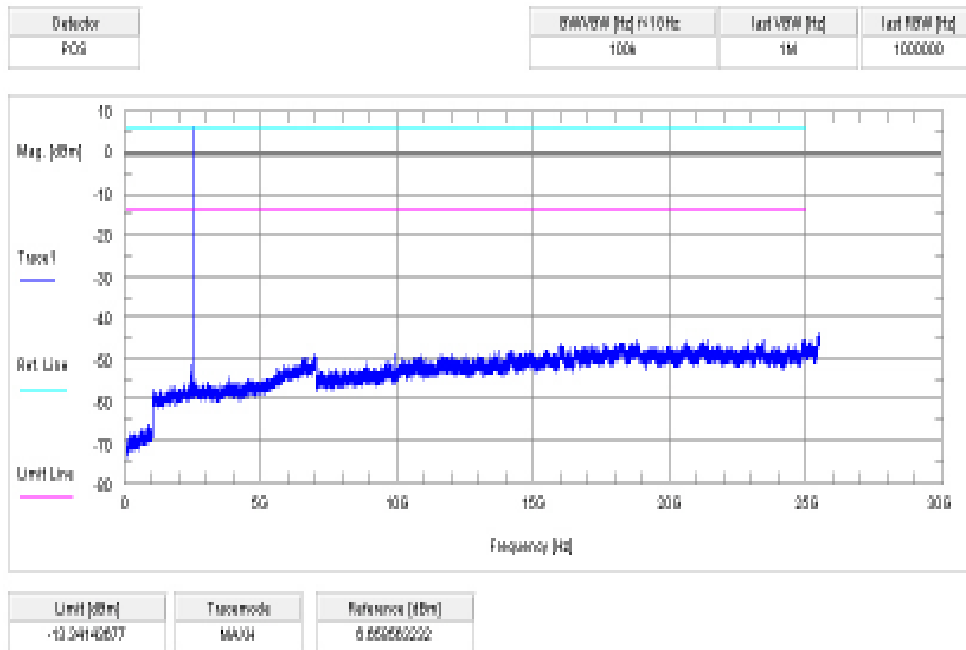

Plot 4: Channel 00 / Pi/4 DQPSK

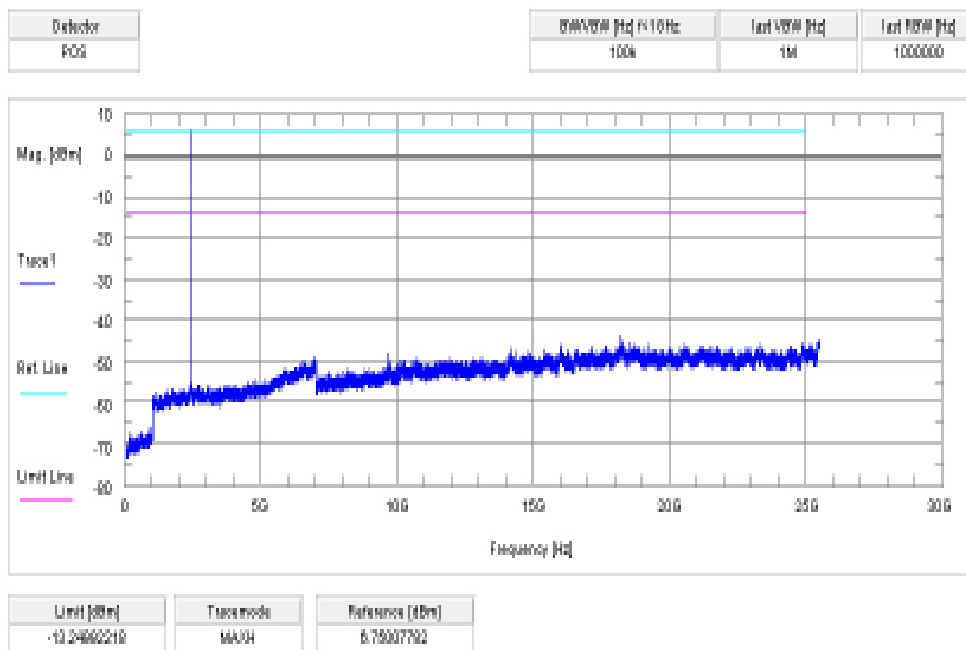

Plot 5: Channel 39 / Pi/4 DQPSK

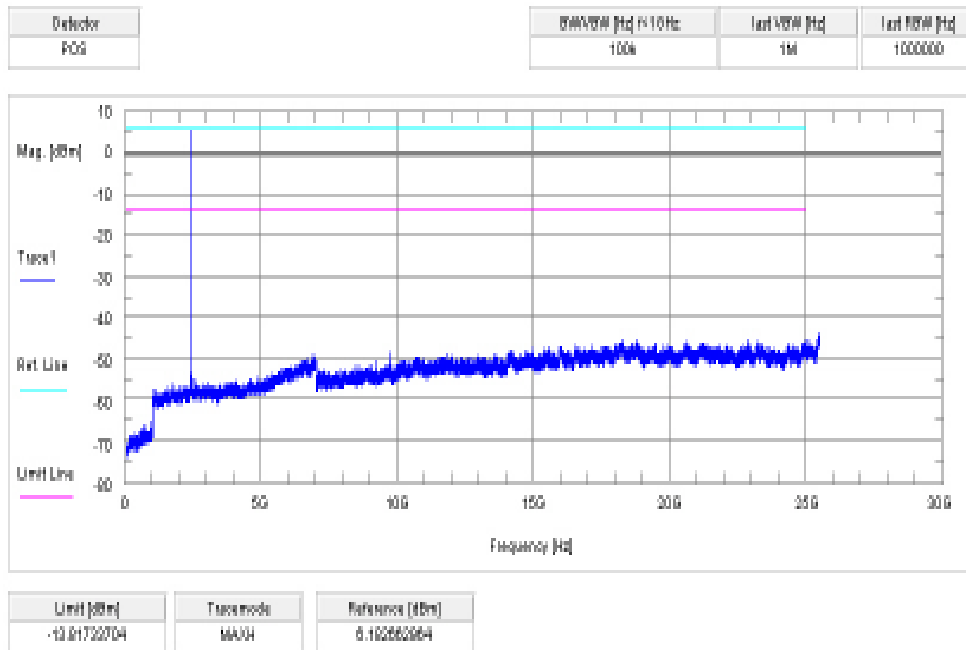

Plot 6: Channel 78 / Pi/4 DQPSK

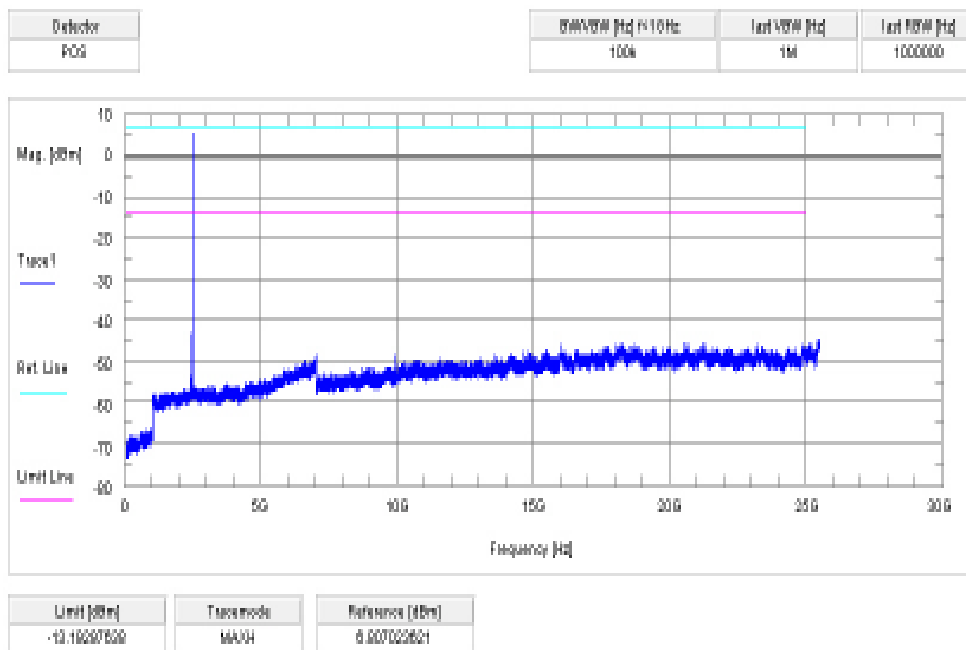

Plot 7: Channel 00 / 8DPSK

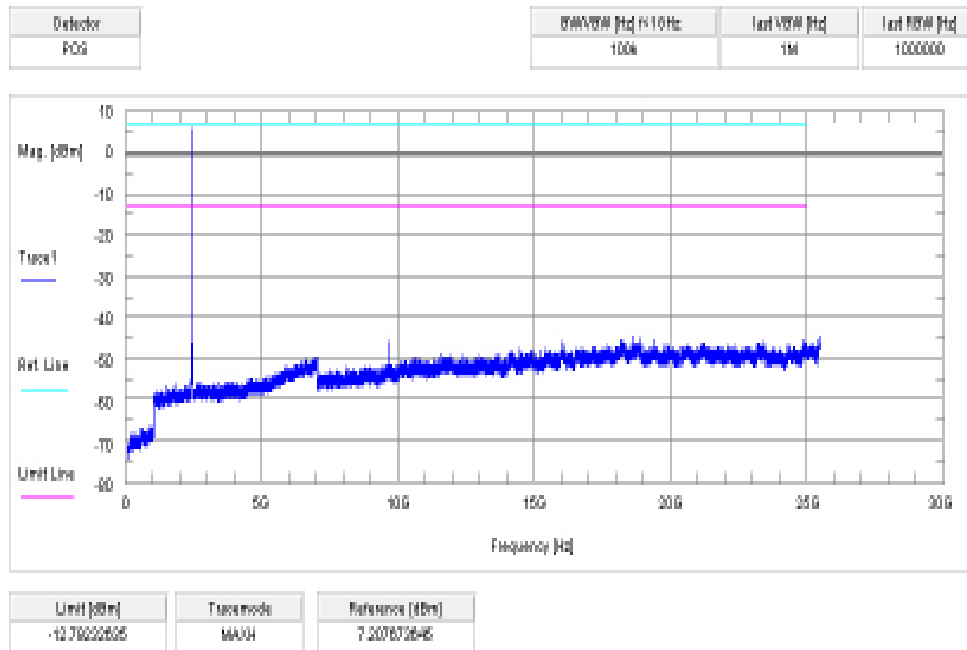

Plot 8: Channel 00 / 8DPSK

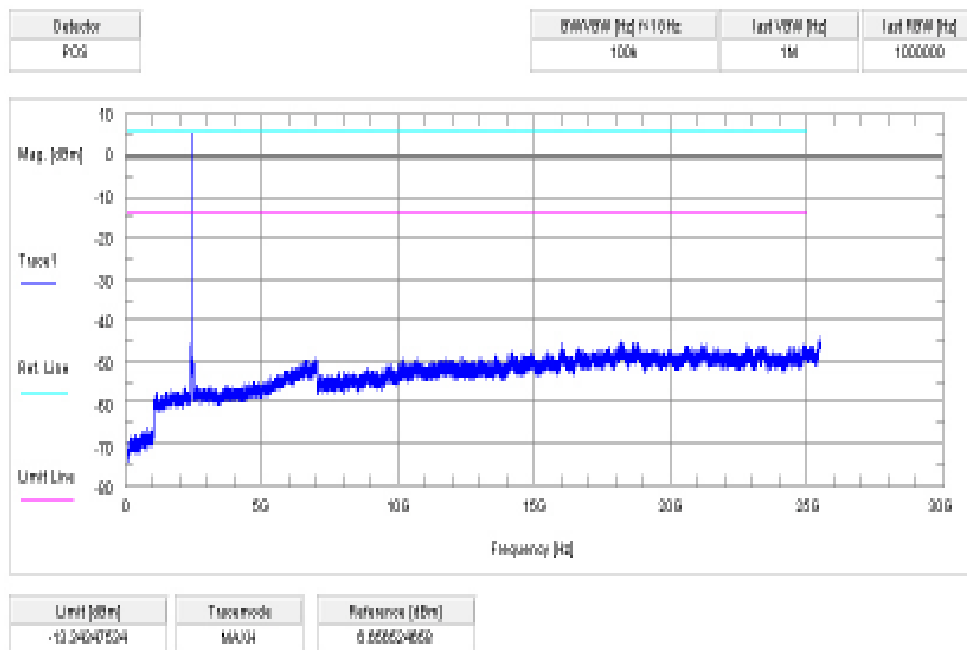

Plot 9: Channel 00 / 8DPSK

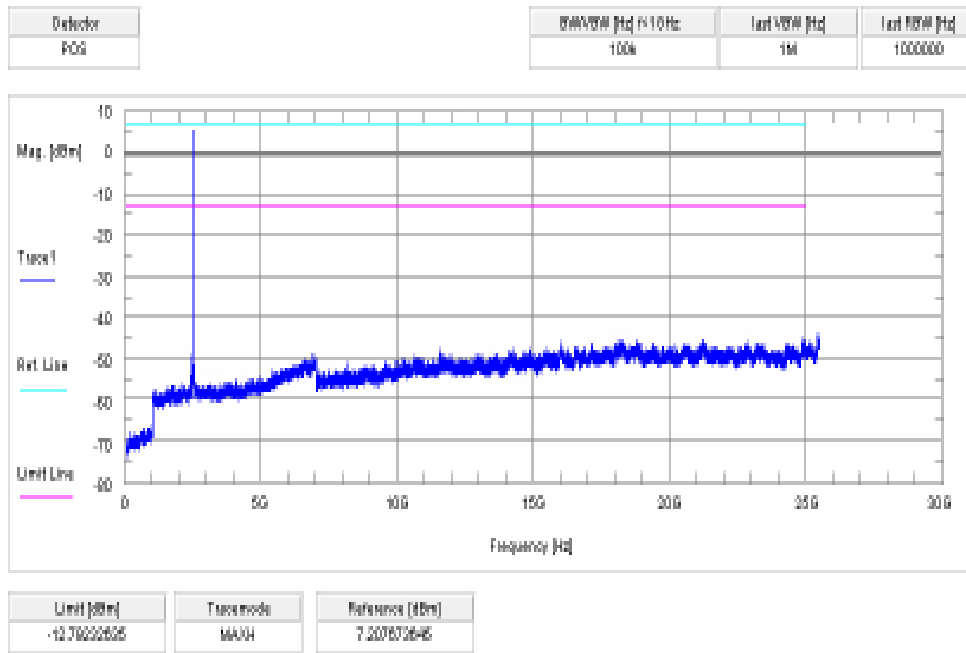

9.11 TX spurious emissions radiated

Description:

Measurement of the radiated spurious emissions in transmit mode. The EUT is set to single channel mode and the transmit channel is channel 00, channel 39 and channel 78. The measurement is performed in the mode with the highest output power.

Measurement:

Measurement parameter	
Detector:	Peak / Quasi Peak
Sweep time:	Auto
Video bandwidth:	Sweep: 100 kHz Remeasurement: 10 Hz
Resolution bandwidth:	F < 1 GHz: 100 kHz F > 1 GHz: 1 MHz
Span:	30 MHz to 25 GHz
Trace-Mode:	Max Hold
Measured Modulation:	<input type="checkbox"/> GFSK <input type="checkbox"/> Pi/4 DQPSK <input checked="" type="checkbox"/> 8DPSK

The modulation with the highest output power was used to perform the transmitter spurious emissions. If spurious were detected a re-measurement was performed on the detected frequency with each modulation.

Limits:

FCC		IC	
CFR Part 15.247(d)		RSS 210, Issue 8, A 8.5	
TX spurious emissions radiated			
<p>In any 100 kHz bandwidth outside the frequency band in which the spread spectrum or digitally modulated intentional radiator is operating, the radio frequency power that is produced by the intentional radiator shall be at least 20 dB below that in the 100 kHz bandwidth within the band that contains the highest level of the desired power, based on either an RF conducted or a radiated measurement. Attenuation below the general limits specified in Section 15.209(a) is not required. In addition, radiated emissions which fall in the restricted bands, as defined in §15.205(a), must also comply with the radiated emission limits specified in §15.209(a) (see §15.205(c)).</p>			
§15.209			
Frequency (MHz)	Field strength (dBµV/m)	Measurement distance	
30 - 88	30.0	10	
88 - 216	33.5	10	
216 - 960	36.0	10	
Above 960	54.0	3	

Result: Also see plots

TX spurious emissions radiated [dB μ V/m]								
2402 MHz			2441 MHz			2480 MHz		
F [MHz]	Detector	Level [dB μ V/m]	F [MHz]	Detector	Level [dB μ V/m]	F [MHz]	Detector	Level [dB μ V/m]
For measurements below 1 GHz – please take a look at the table below the 1 GHz plot.			For measurements below 1 GHz – please take a look at the table below the 1 GHz plot.			For measurements below 1 GHz – please take a look at the table below the 1 GHz plot.		
2375	1 MHz / 10 Hz PP	-41.57 V	2375	1 MHz / 10 Hz PP	-41.70 V	2375	1 MHz / 10 Hz PP	-41.64 V
-/-	-/-	-/-	-/-	-/-	-/-	-/-	-/-	-/-
For measurements between 12.75 GHz and 26 GHz – please take a look at the plots. No peaks detected.			For measurements between 12.75 GHz and 26 GHz – please take a look at the plots. No peaks detected.			For measurements between 12.75 GHz and 26 GHz – please take a look at the plots. No peaks detected.		
Measurement uncertainty			± 3 dB					

Result: The result of the measurement is passed.

Plot 1: 30 MHz to 1 GHz / channel 00 (horizontal & vertical)

Common Information

EUT: Sony Ericsson AAD-3880097-BV
 Serial Number: CB5A1CG1MJ
 Test Description: FCC Part 15 @ 10 m
 Operating Conditions: TX Bluetooth / ch 0
 Operator Name: HNA
 Comment: AC 110 V / 60 Hz

Scan Setup: STAN_Fin [EMI radiated]

Hardware Setup: Electric Field (NOS)
 Level Unit: dB μ V/m
Subrange **Detectors** **IF Bandwidth** **Meas. Time** **Receiver**
 30 MHz - 1,05 GHz QuasiPeak 120 kHz 15 s Receiver

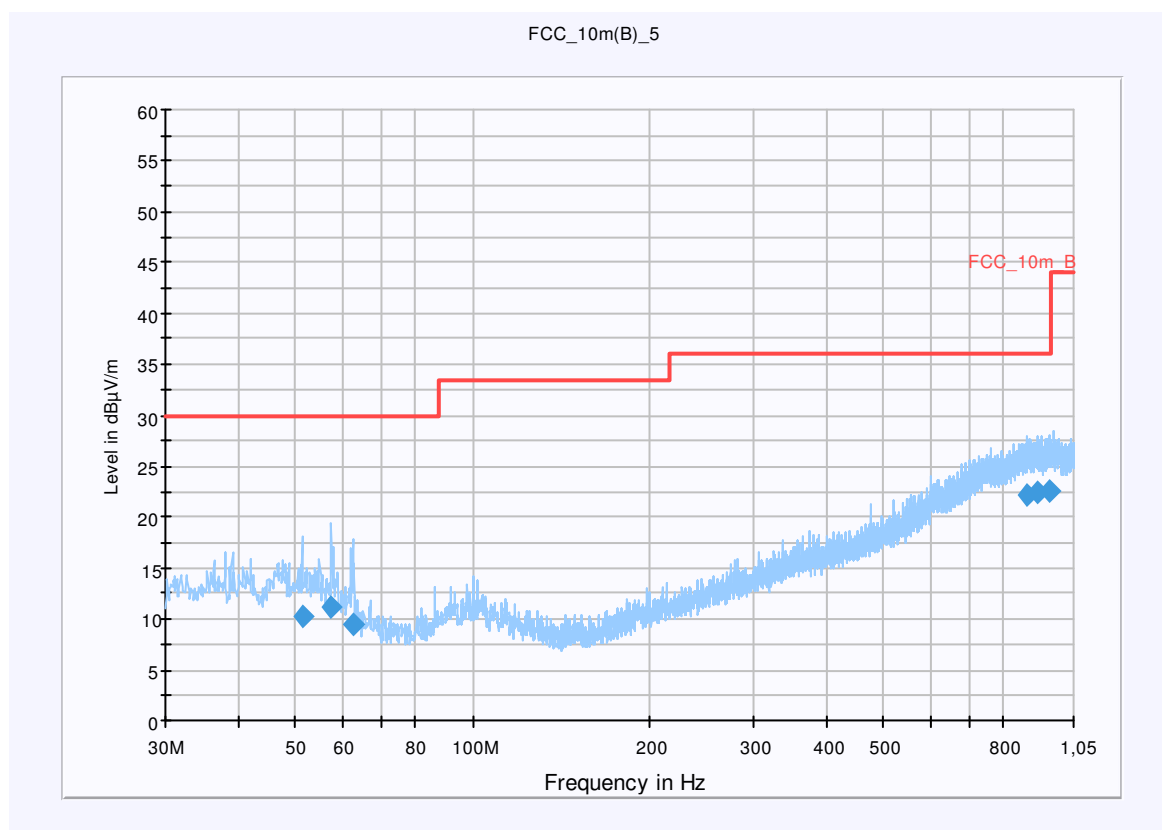

Final Result 1

Frequency (MHz)	QuasiPeak (dB μ V/m)	Meas. Time (ms)	Bandwidth (kHz)	Antenna height (cm)	Polarity	Turntable position (deg)	Corr. (dB)	Margin (dB)	Limit (dB μ V/m)	Comment
51.360000	10.2	15000.000	120.000	270.0	V	55.0	13.2	19.8	30.0	
57.600000	11.2	15000.000	120.000	98.0	V	86.0	12.2	18.8	30.0	
62.400000	9.4	15000.000	120.000	194.0	V	250.0	11.0	20.6	30.0	
873.840000	22.3	15000.000	120.000	270.0	H	145.0	24.9	13.7	36.0	
909.120000	22.4	15000.000	120.000	259.0	V	349.0	25.2	13.6	36.0	
952.200000	22.6	15000.000	120.000	270.0	H	44.0	25.4	13.4	36.0	

Hardware Setup: EMI radiated\Electric Field (NOS) - [EMI radiated]

Subrange 1	
Frequency Range:	30 MHz - 2 GHz
Receiver:	Receiver [ESCI 3] @ GPIB0 (ADR 20), SN 100083/003, FW 4.32
Signal Path:	without Notch FW 1.0
Antenna:	VULB 9163 SN 9163-295, FW --- Correction Table (vertical): VULP6113 Correction Table (horizontal): VULP6113 Correction Table: Cable_EN_1GHz (0909)
Antenna Tower:	Tower [EMCO 2090 Antenna Tower] @ GPIB0 (ADR 8), FW REV 3.12
Turntable:	Turntable [EMCO Turntable] @ GPIB0 (ADR 9), FW REV 3.12

EMC 32 Version 8.10.00

Plot 2: 1 GHz to 12.75 GHz / channel 00 (vertical)

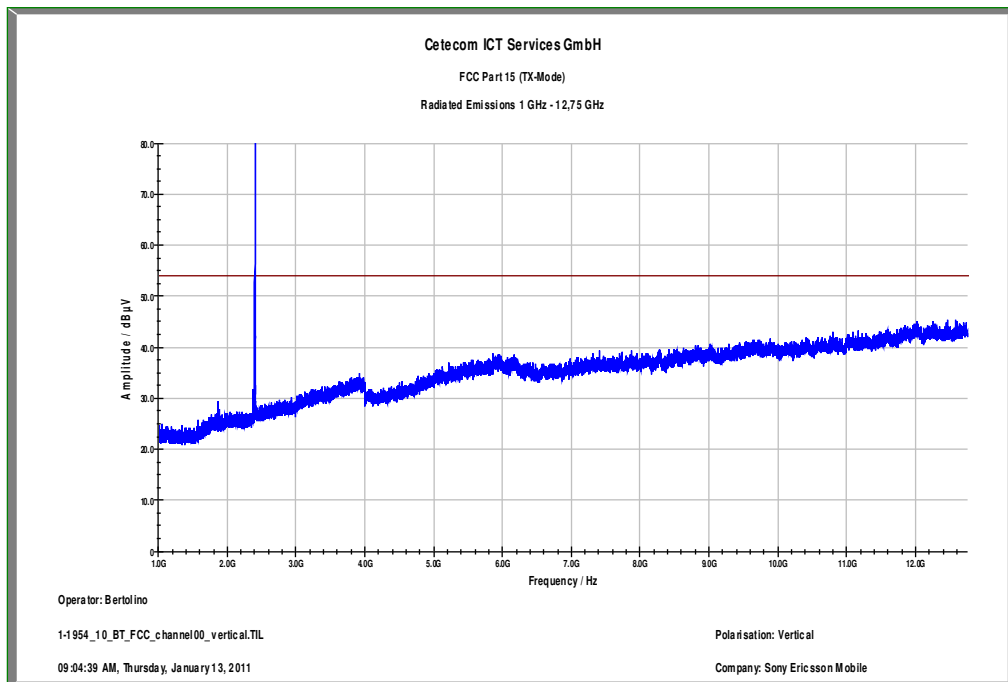

Plot 3: 1 GHz to 12.75 GHz / channel 00 (horizontal)

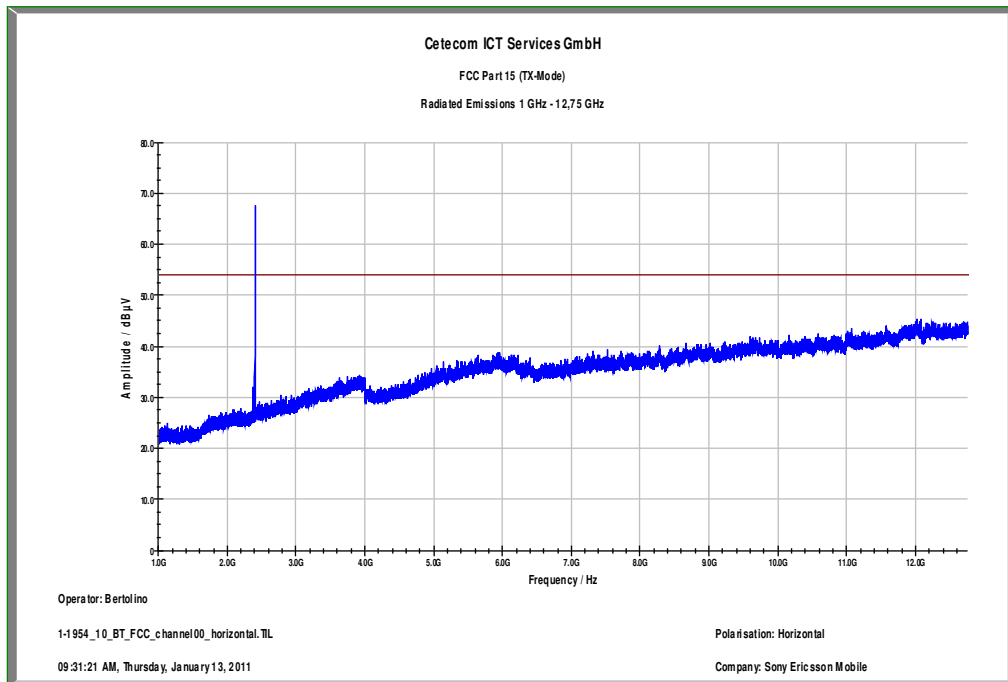

Plot 4: 12.75 GHz to 18 GHz / channel 00 (horizontal & vertical)

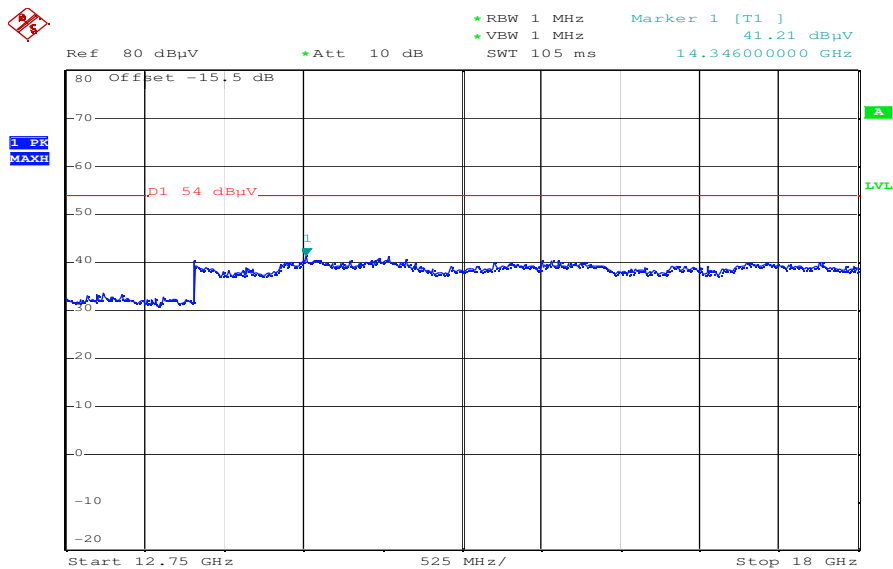

Date: 13.JAN.2011 13:43:02

Plot 5: 18 GHz to 26 GHz / channel 00 (horizontal & vertical)

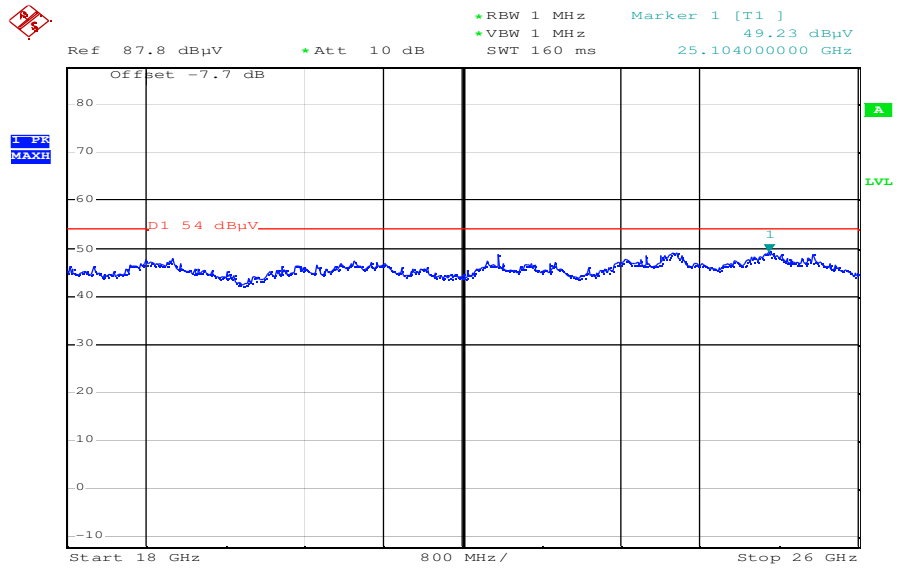

Date: 13.JAN.2011 13:47:49

Plot 6: 30 MHz to 1 GHz / channel 39 (horizontal & vertical)

Common Information

EUT: Sony Ericsson AAD-3880097-BV
 Serial Number: CB5A1CG1MJ
 Test Description: FCC Part 15 @ 10 m
 Operating Conditions: TX Bluetooth / ch 39
 Operator Name: HNA
 Comment: AC 110 V / 60 Hz

Scan Setup: STAN_Fin [EMI radiated]

Hardware Setup: Electric Field (NOS)
 Level Unit: dB μ V/m
Subrange **Detectors** **IF Bandwidth** **Meas. Time** **Receiver**
 30 MHz - 1,05 GHz QuasiPeak 120 kHz 15 s Receiver

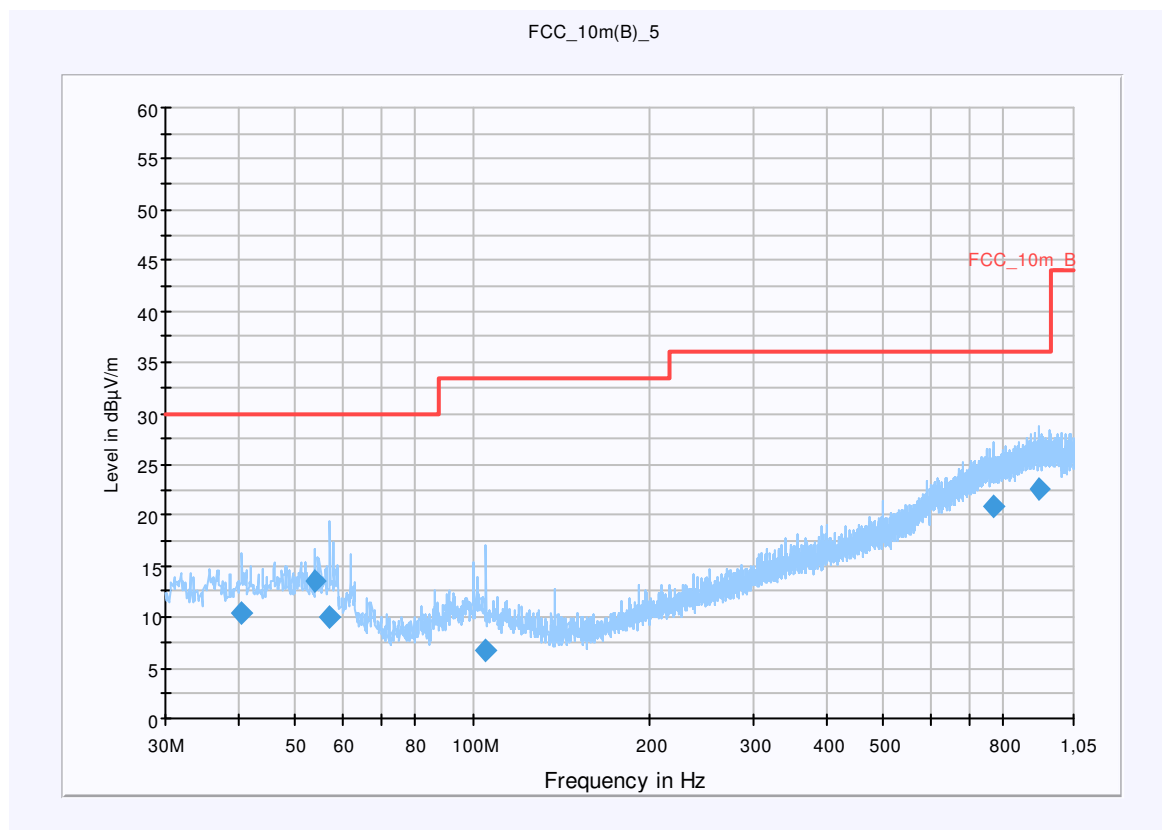

Final Result 1

Frequency (MHz)	QuasiPeak (dB μ V/m)	Meas. Time (ms)	Bandwidth (kHz)	Antenna height (cm)	Polarity	Turntable position (deg)	Corr. (dB)	Margin (dB)	Limit (dB μ V/m)	Comment
40.440000	10.4	15000.000	120.000	120.0	V	74.0	13.4	19.6	30.0	
54.000000	13.7	15000.000	120.000	110.0	V	65.0	13.0	16.4	30.0	
57.240000	10.0	15000.000	120.000	98.0	V	106.0	12.3	20.0	30.0	
105.360000	6.7	15000.000	120.000	270.0	V	49.0	11.4	26.8	33.5	
770.280000	20.9	15000.000	120.000	127.0	H	-2.0	23.7	15.1	36.0	
922.080000	22.5	15000.000	120.000	270.0	H	90.0	25.3	13.5	36.0	

Hardware Setup: EMI radiated\Electric Field (NOS) - [EMI radiated]

Subrange 1	
Frequency Range:	30 MHz - 2 GHz
Receiver:	Receiver [ESCI 3] @ GPIB0 (ADR 20), SN 100083/003, FW 4.32
Signal Path:	without Notch FW 1.0
Antenna:	VULB 9163 SN 9163-295, FW --- Correction Table (vertical): VULP6113 Correction Table (horizontal): VULP6113 Correction Table: Cable_EN_1GHz (0909)
Antenna Tower:	Tower [EMCO 2090 Antenna Tower] @ GPIB0 (ADR 8), FW REV 3.12
Turntable:	Turntable [EMCO Turntable] @ GPIB0 (ADR 9), FW REV 3.12

EMC 32 Version 8.10.00

Plot 7: 1 GHz to 12.75 GHz / channel 39 (vertical)

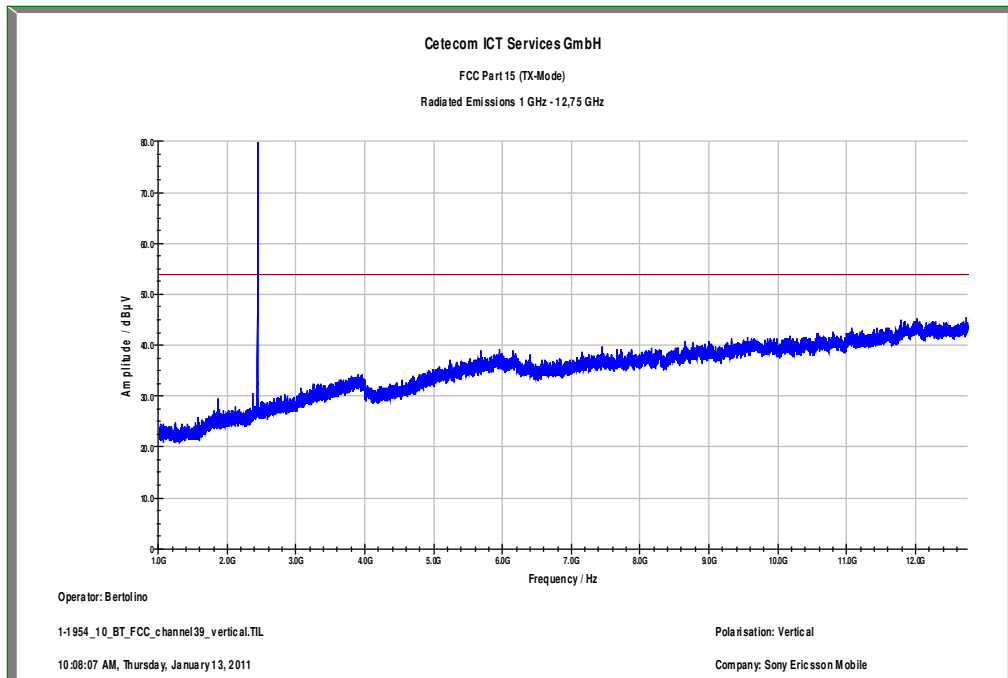

Plot 8: 1 GHz to 12.75 GHz / channel 39 (horizontal)

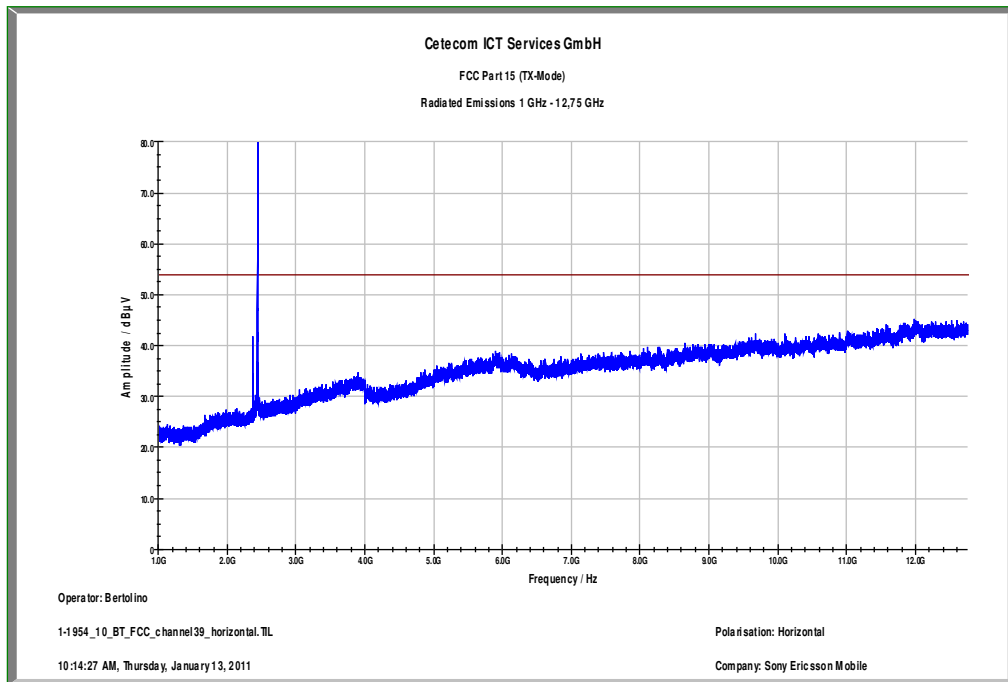

Plot 9: 12.75 GHz to 18 GHz / channel 39 (horizontal & vertical)

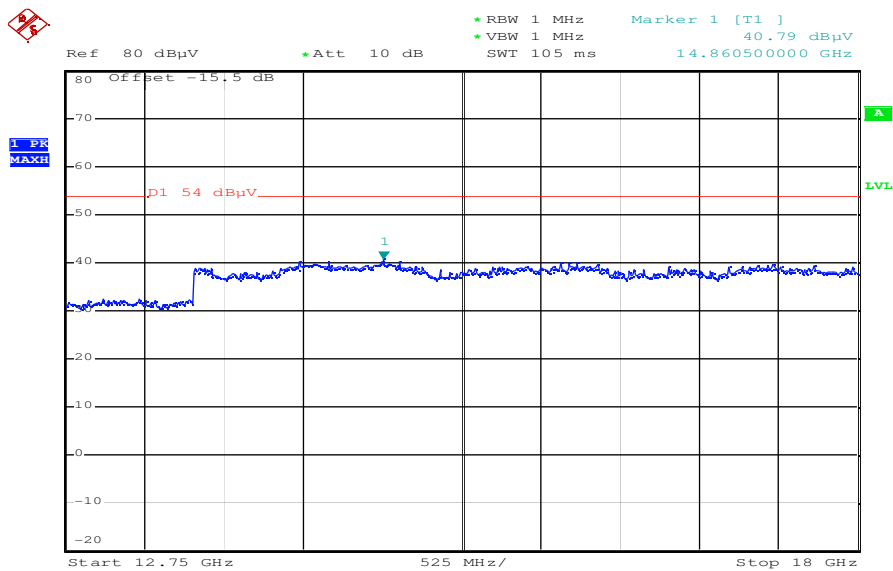

Date: 13.JAN.2011 13:43:49

Plot 10: 18 GHz to 26 GHz / channel 39 (horizontal & vertical)

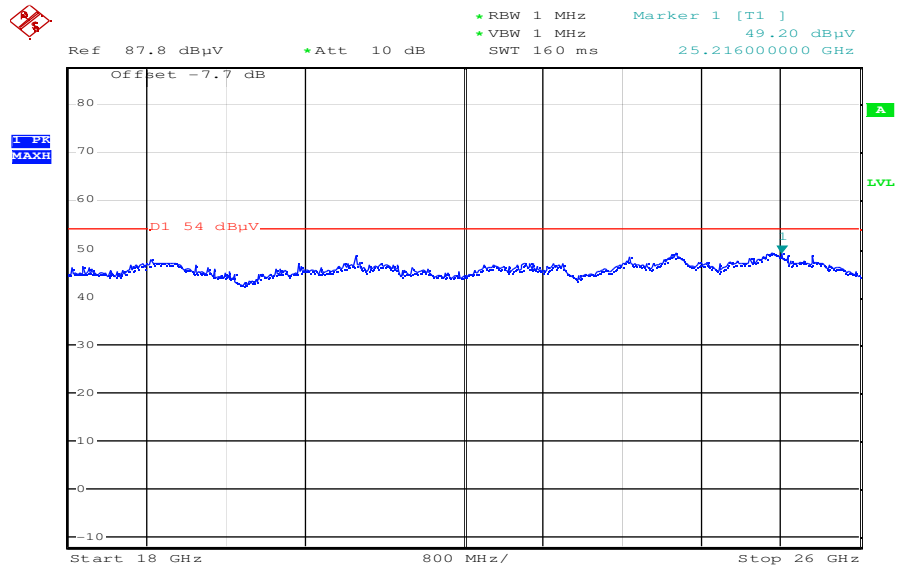

Date: 13.JAN.2011 13:48:32

Plot 11: 30 MHz to 1 GHz / channel 78 (horizontal & vertical)

Common Information

EUT: Sony Ericsson AAD-3880097-BV
 Serial Number: CB5A1CG1MJ
 Test Description: FCC Part 15 @ 10 m
 Operating Conditions: TX Bluetooth / ch 78
 Operator Name: HNA
 Comment: AC 110 V / 60 Hz

Scan Setup: STAN_Fin [EMI radiated]

Hardware Setup: Electric Field (NOS)
 Level Unit: dB μ V/m
Subrange **Detectors** **IF Bandwidth** **Meas. Time** **Receiver**
 30 MHz - 1,05 GHz QuasiPeak 120 kHz 15 s Receiver

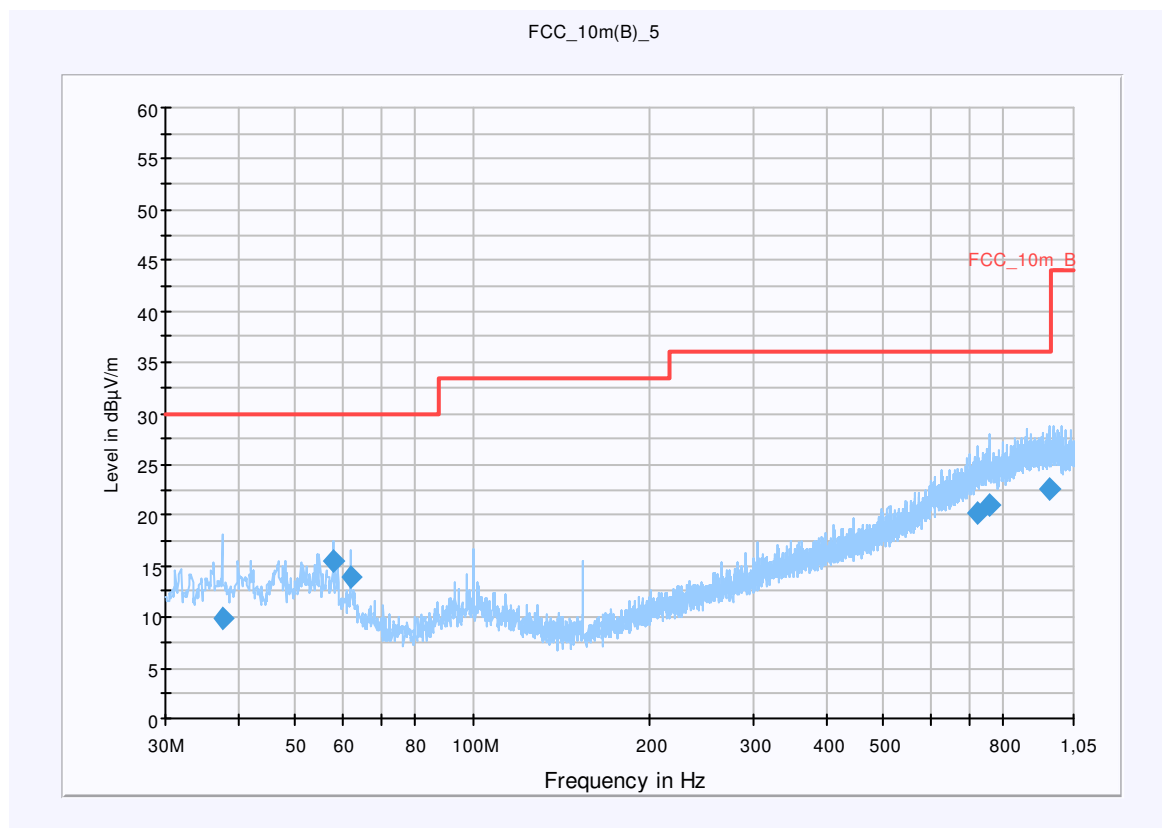

Final Result 1

Frequency (MHz)	QuasiPeak (dB μ V/m)	Meas. Time (ms)	Bandwidth (kHz)	Antenna height (cm)	Polarity	Turntable position (deg)	Corr. (dB)	Margin (dB)	Limit (dB μ V/m)	Comment
37.560000	9.9	15000.000	120.000	98.0	V	76.0	13.2	20.1	30.0	
57.960000	15.6	15000.000	120.000	98.0	V	275.0	12.1	14.4	30.0	
62.040000	13.9	15000.000	120.000	270.0	V	209.0	11.1	16.1	30.0	
719.880000	20.3	15000.000	120.000	270.0	H	-2.0	23.0	15.7	36.0	
755.520000	21.0	15000.000	120.000	109.0	V	187.0	23.7	15.0	36.0	
952.920000	22.6	15000.000	120.000	161.0	H	33.0	25.4	13.4	36.0	

Hardware Setup: EMI radiated\Electric Field (NOS) - [EMI radiated]

Subrange 1	
Frequency Range:	30 MHz - 2 GHz
Receiver:	Receiver [ESCI 3] @ GPIB0 (ADR 20), SN 100083/003, FW 4.32
Signal Path:	without Notch FW 1.0
Antenna:	VULB 9163 SN 9163-295, FW --- Correction Table (vertical): VULP6113 Correction Table (horizontal): VULP6113 Correction Table: Cable_EN_1GHz (0909)
Antenna Tower:	Tower [EMCO 2090 Antenna Tower] @ GPIB0 (ADR 8), FW REV 3.12
Turntable:	Turntable [EMCO Turntable] @ GPIB0 (ADR 9), FW REV 3.12

EMC 32 Version 8.10.00

Plot 12: 1 GHz to 12.75 GHz / channel 78 (vertical)

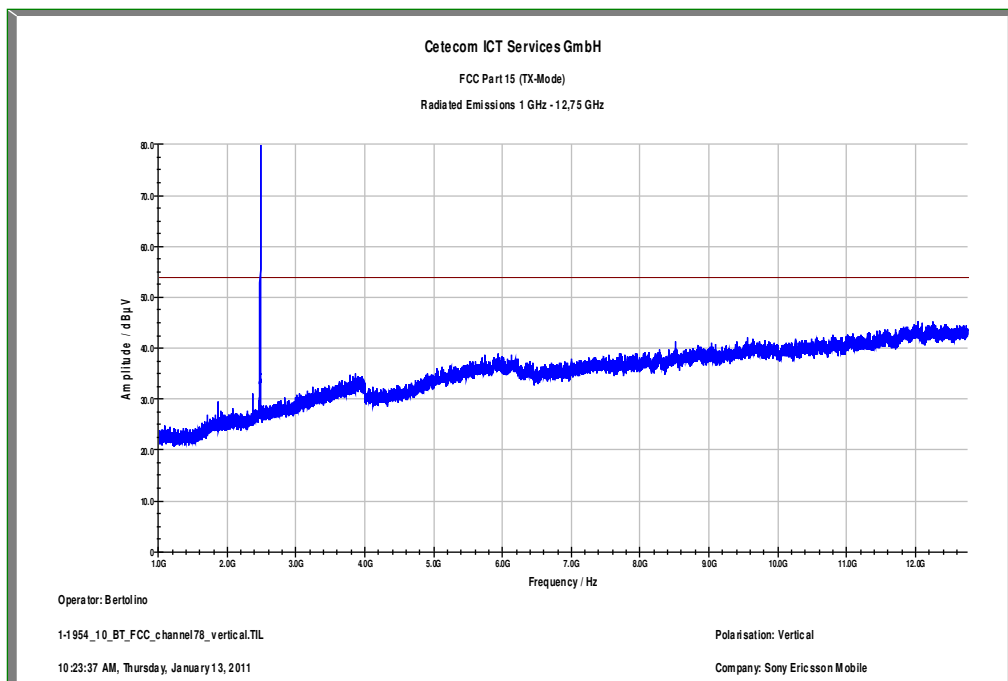

Plot 13: 1 GHz to 12.75 GHz / channel 78 (horizontal)

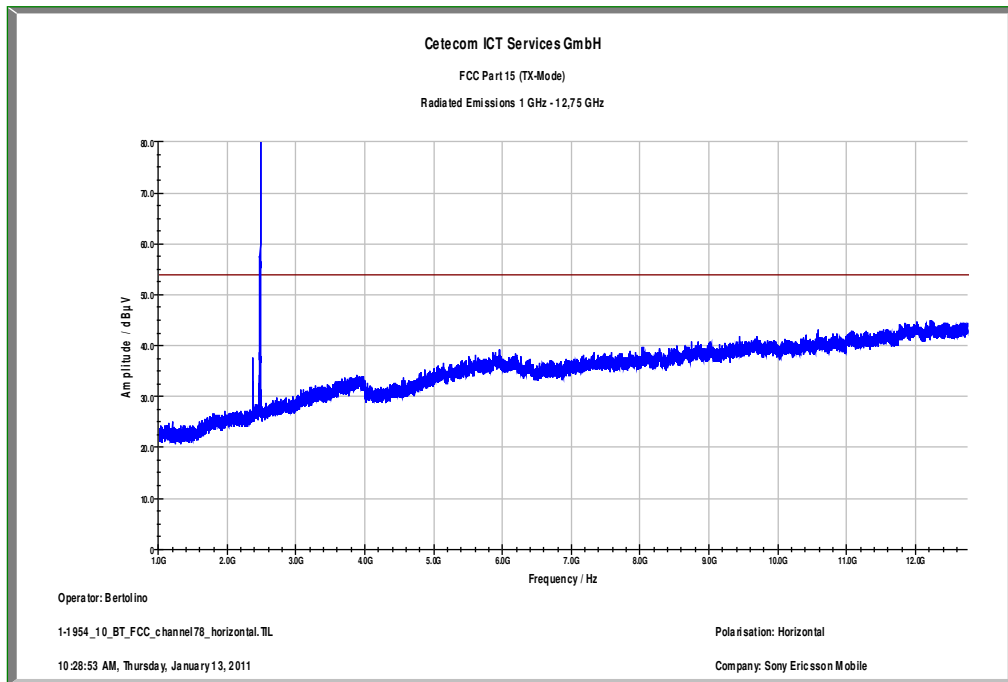

Plot 14: 12.75 GHz to 18 GHz / channel 78 (horizontal & vertical)

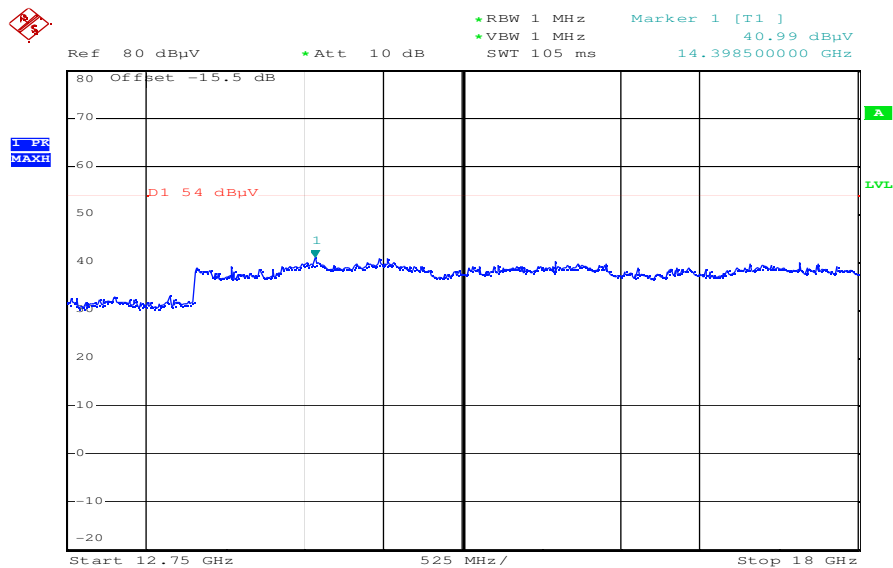

Date: 13.JAN.2011 13:44:48

Plot 15: 18 GHz to 26 GHz / channel 78 (horizontal & vertical)

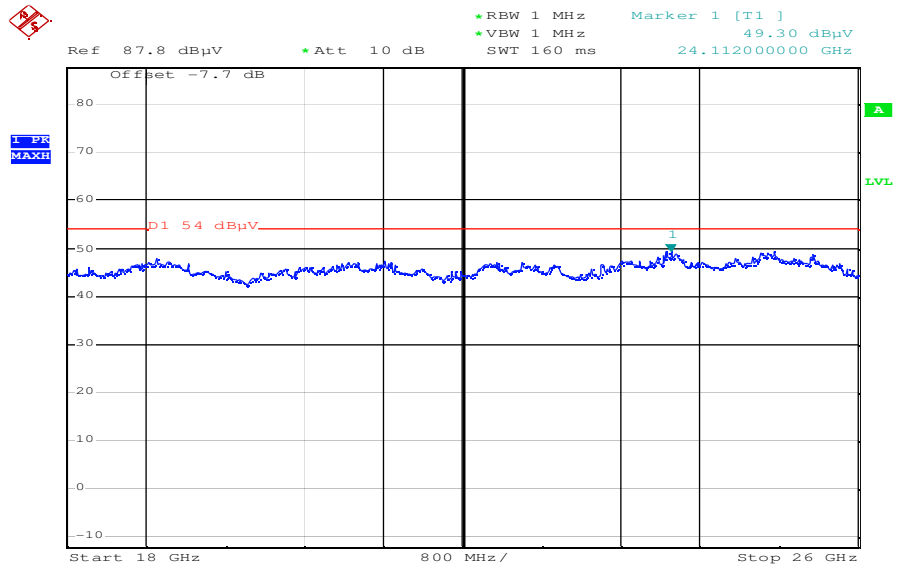

Date: 13.JAN.2011 13:49:10

9.12 RX spurious emissions radiated

Description:

Measurement of the radiated spurious emissions in idle/receive mode. The EUT is detached so all oscillators are active.

Measurement:

Measurement parameter	
Detector:	Peak / Quasi peak
Sweep time:	Auto
Video bandwidth:	Sweep: 100 kHz Remeasurement: 10 Hz
Resolution bandwidth:	F < 1 GHz: 100 kHz F > 1 GHz: 1 MHz
Span:	30 MHz to 25 GHz
Trace-Mode:	Max Hold

Limits:

FCC		IC	
CFR Part 15.109		RSS Gen, Issue 2, 4.10	
RX Spurious Emissions Radiated			
Frequency (MHz)	Field strength (dBμV/m)	Measurement distance	
30 - 88	30.0	10	
88 - 216	33.5	10	
216 - 960	36.0	10	
Above 960	54.0	3	

Result: Also see plots

RX spurious emissions radiated [dB μ V/m]		
F [MHz]	Detector	Level [dB μ V/m]
No critical peaks found		
Measurement uncertainty	±3 dB	

Result: The result of the measurement is passed.

Plot 1: 30 MHz to 1 GHz / idle-mode (horizontal & vertical)

Common Information

EUT: Sony Ericsson AAD-3880097-BV
 Serial Number: CB5A1CG1MJ
 Test Description: FCC Part 15 @ 10 m
 Operating Conditions: RX Bluetooth
 Operator Name: HNA
 Comment: AC 110 V / 60 Hz

Scan Setup: STAN_Fin [EMI radiated]

Hardware Setup: Electric Field (NOS)
 Level Unit: dBµV/m
Subrange **Detectors** **IF Bandwidth** **Meas. Time** **Receiver**
 30 MHz - 1,05 GHz QuasiPeak 120 kHz 15 s Receiver

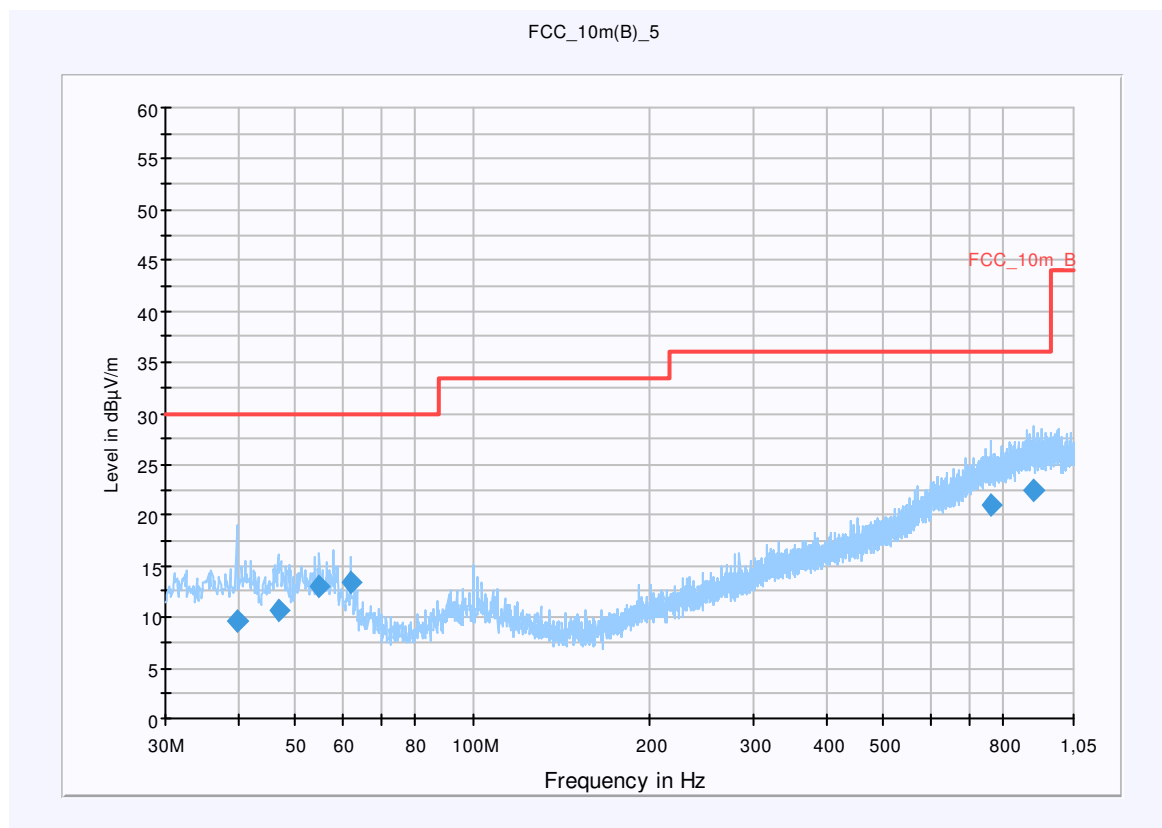

Final Result 1

Frequency (MHz)	QuasiPeak (dBµV/m)	Meas. Time (ms)	Bandwidth (kHz)	Antenna height (cm)	Polarity	Turntable position (deg)	Corr. (dB)	Margin (dB)	Limit (dBµV/m)	Comment
39.720000	9.7	15000.000	120.000	98.0	V	221.0	13.4	20.3	30.0	
46.800000	10.7	15000.000	120.000	218.0	V	-2.0	13.3	19.3	30.0	
54.960000	13.1	15000.000	120.000	98.0	V	313.0	12.9	16.9	30.0	
62.040000	13.4	15000.000	120.000	243.0	V	77.0	11.1	16.6	30.0	
762.360000	21.0	15000.000	120.000	270.0	V	234.0	23.7	15.0	36.0	
898.080000	22.4	15000.000	120.000	243.0	V	24.0	25.2	13.6	36.0	

Hardware Setup: EMI radiated\Electric Field (NOS) - [EMI radiated]

Subrange 1	
Frequency Range:	30 MHz - 2 GHz
Receiver:	Receiver [ESCI 3] @ GPIB0 (ADR 20), SN 100083/003, FW 4.32
Signal Path:	without Notch FW 1.0
Antenna:	VULB 9163 SN 9163-295, FW --- Correction Table (vertical): VULP6113 Correction Table (horizontal): VULP6113 Correction Table: Cable_EN_1GHz (0909)
Antenna Tower:	Tower [EMCO 2090 Antenna Tower] @ GPIB0 (ADR 8), FW REV 3.12
Turntable:	Turntable [EMCO Turntable] @ GPIB0 (ADR 9), FW REV 3.12

EMC 32 Version 8.10.00

Plot 2: 1 GHz to 12.75 GHz / idle-mode (vertical)

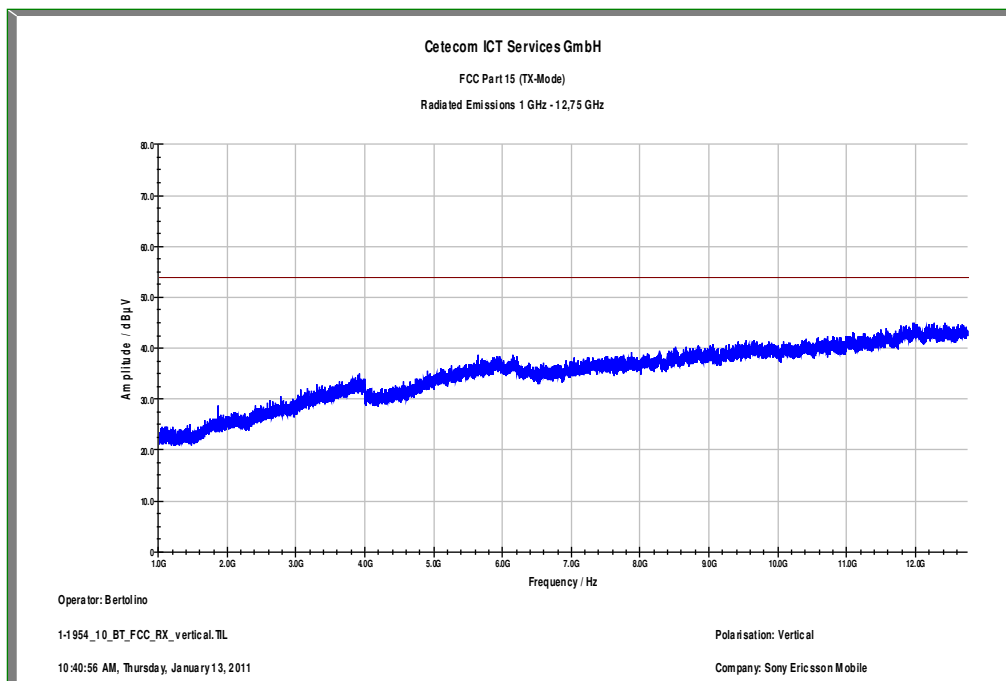

Plot 3: 1 GHz to 12.75 GHz / idle-mode (horizontal)

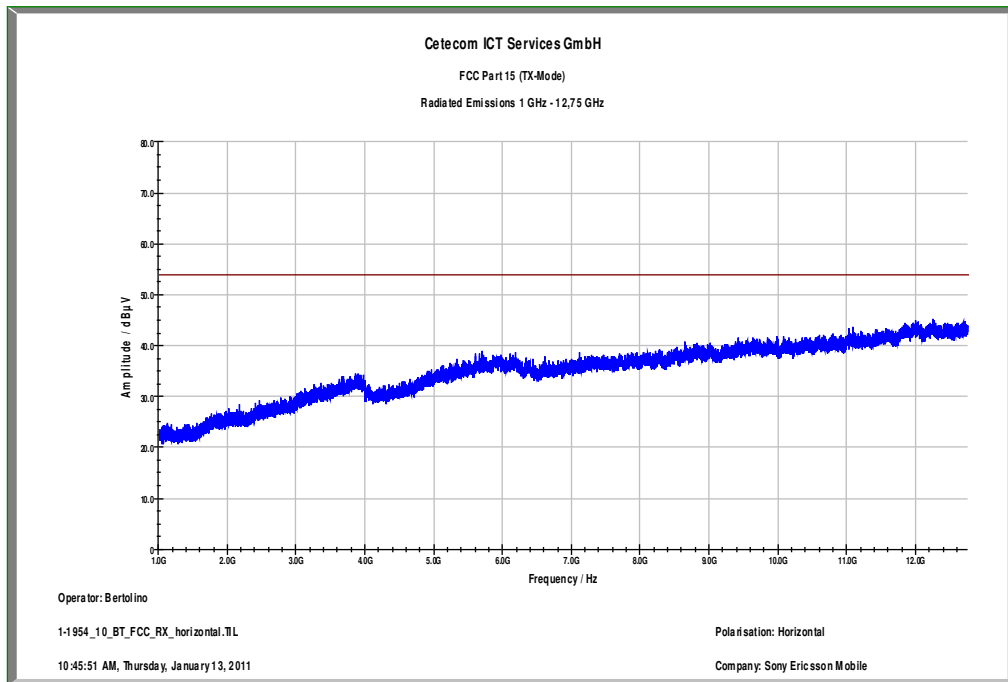

Plot 4: 12.75 GHz to 18 GHz / idle-mode (horizontal & vertical)

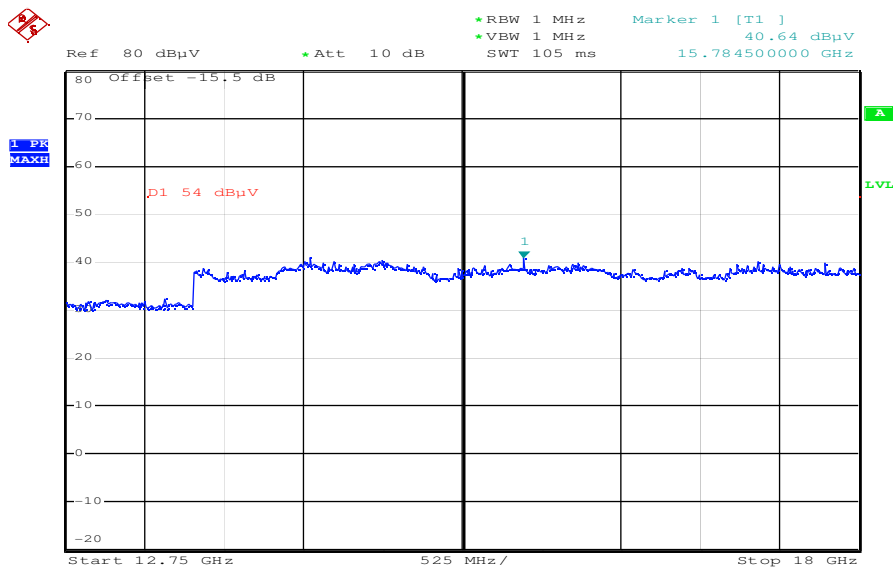

Date: 13.JAN.2011 13:45:23

Plot 5: 18 GHz to 26 GHz / idle-mode (horizontal & vertical)

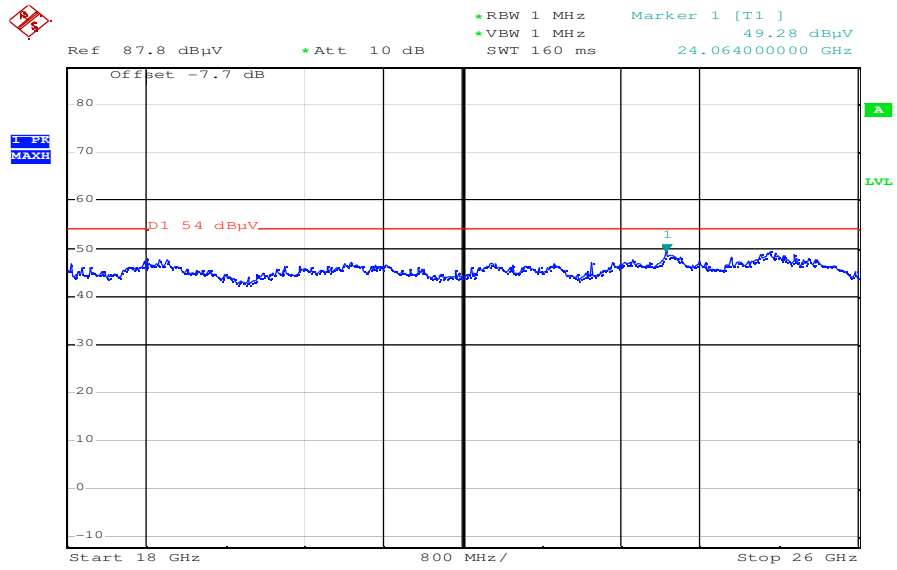

Date: 13.JAN.2011 13:46:52

9.13 TX spurious emissions radiated < 30 MHz

Description:

Measurement of the radiated spurious emissions in transmit mode below 30 MHz. The EUT is set to single channel mode and the transmit channel is channel 39. This measurement is representative for all channels and modes. If critical peaks are found channel 00 and channel 78 will be measured too. The measurement is performed in the mode with the highest output power. The limits are recalculated to a measurement distance of 3 m with 40 dB/decade according CFR Part 2.

Measurement:

Measurement parameter	
Detector:	Peak / Quasi peak
Sweep time:	Auto
Video bandwidth:	F < 150 kHz: 200 Hz F > 150 kHz: 9 kHz
Resolution bandwidth:	F < 150 kHz: 1 kHz F > 150 kHz: 100 kHz
Span:	9 kHz to 30 MHz
Trace-Mode:	Max Hold

Limits:

FCC		IC
CFR Part 15.209(a)		RSS 210, Issue 8, 2.2
TX spurious emissions radiated < 30 MHz		
Frequency (MHz)	Field strength (dBµV/m)	Measurement distance
0.009 – 0.490	2400/F(kHz)	300
0.490 – 1.705	24000/F(kHz)	30
1.705 – 30.0	30	30

Result: Also see plot

TX spurious emissions radiated < 30 MHz [dBµV/m]		
F [MHz]	Detector	Level [dBµV/m]
No critical peaks found.		
Measurement uncertainty	± 3 dB	

Result: The result of the measurement is passed.

Plot 1: 9 kHz to 30 MHz / channel 00

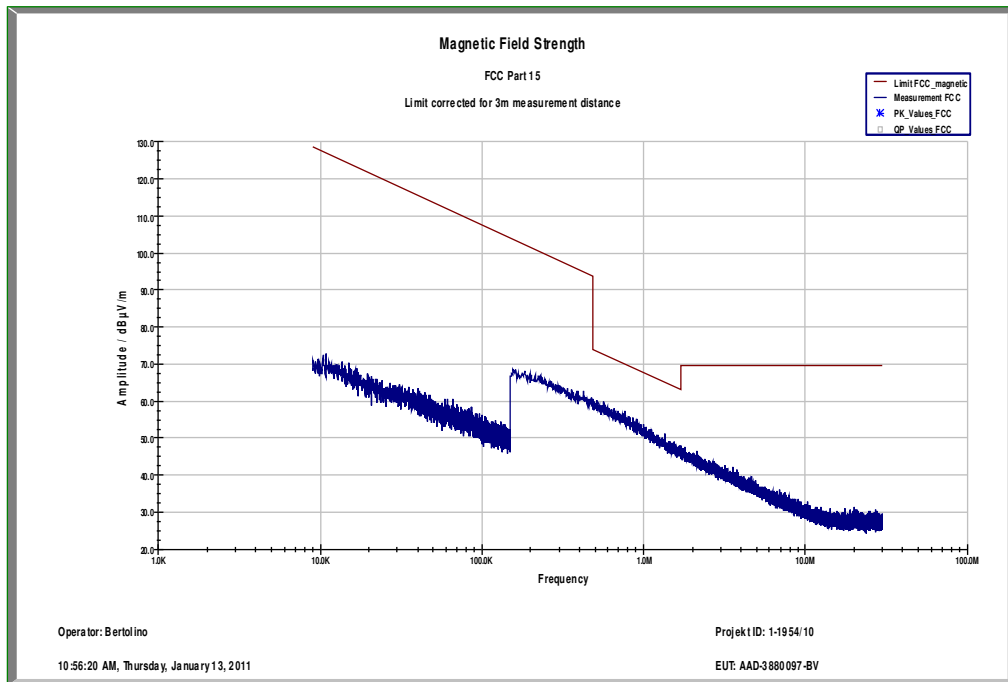

Plot 2: 9 kHz to 30 MHz / channel 39

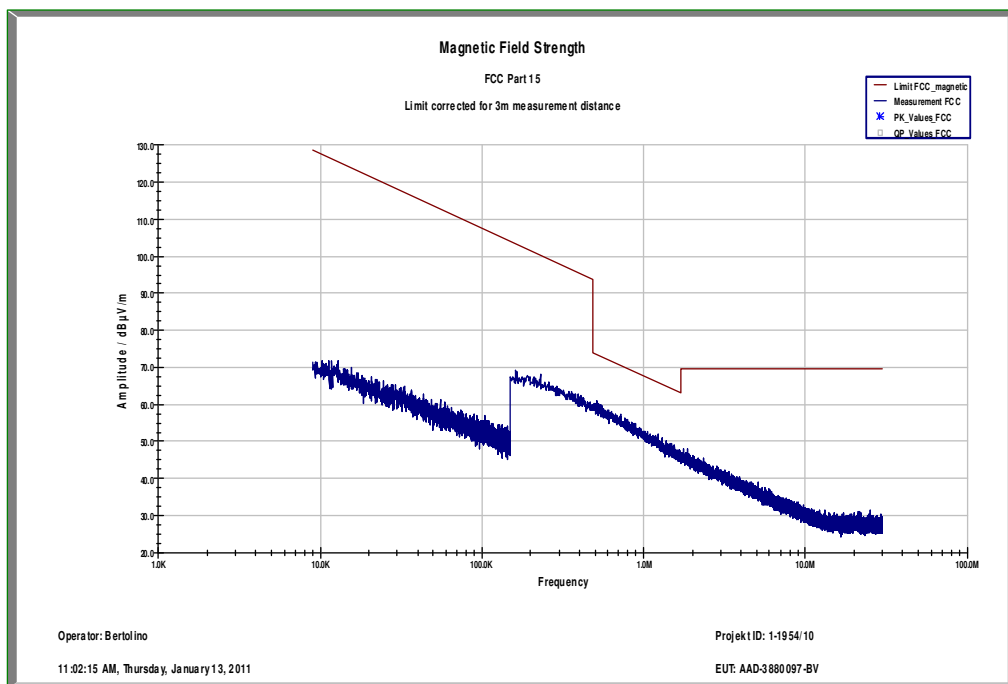

Plot 3: 9 kHz to 30 MHz / channel 78

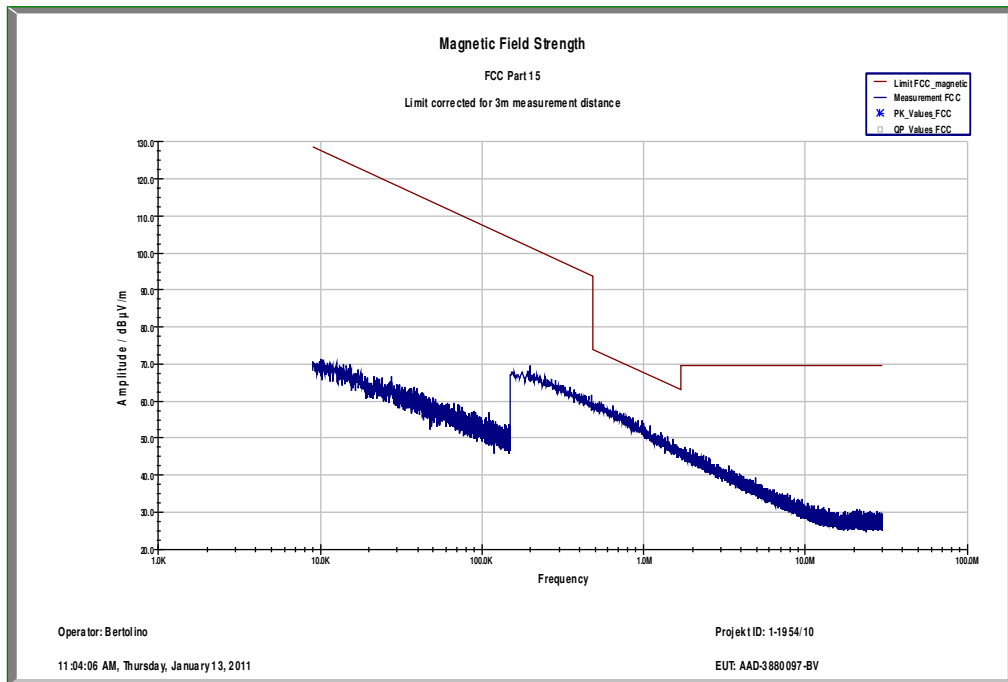

Plot 4: 9 kHz to 30 MHz / RX

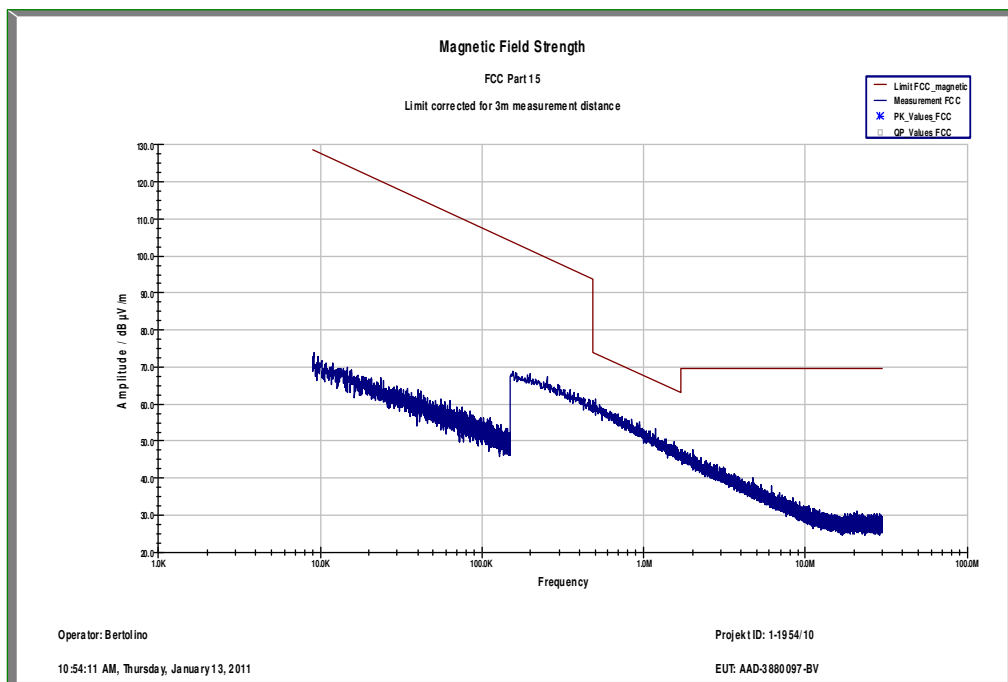

9.14 TX spurious emissions conducted < 30 MHz

Description:

Measurement of the conducted spurious emissions in transmit mode below 30 MHz. The EUT is set to single channel mode and the transmit channel is channel 39. This measurement is representative for all channels and modes. If critical peaks are found channel 00 and channel 78 will be measured too. The measurement is performed in the mode with the highest output power. Both power lines, phase and neutral line, are measured. Found peaks are remeasured with average and quasi peak detection to show compliance to the limits.

Measurement:

Measurement parameter	
Detector:	Peak - Quasi peak / average
Sweep time:	Auto
Video bandwidth:	F < 150 kHz: 200 Hz F > 150 kHz: 9 kHz
Resolution bandwidth:	F < 150 kHz: 1 kHz F > 150 kHz: 100 kHz
Span:	9 kHz to 30 MHz
Trace-Mode:	Max Hold

Limits:

FCC		IC	
CFR Part 15.107(a)		ICES-003, Issue 4	
TX spurious emissions conducted < 30 MHz			
Frequency (MHz)	Quasi-peak (dBµV/m)	Average (dBµV/m)	
0.15 – 0.5	66 to 56*	56 to 46*	
0.5 – 5	56	46	
5 – 30.0	60	50	

*Decreases with the logarithm of the frequency

Result: Also see plots

TX spurious emissions conducted < 30 MHz [dBµV/m]		
F [MHz]	Detector	Level [dBµV/m]
No critical peaks found.		
Measurement uncertainty	± 3 dB	

Result: The result of the measurement is passed.

Plot 1: 9 kHz to 30 MHz / phase Line, TX mode

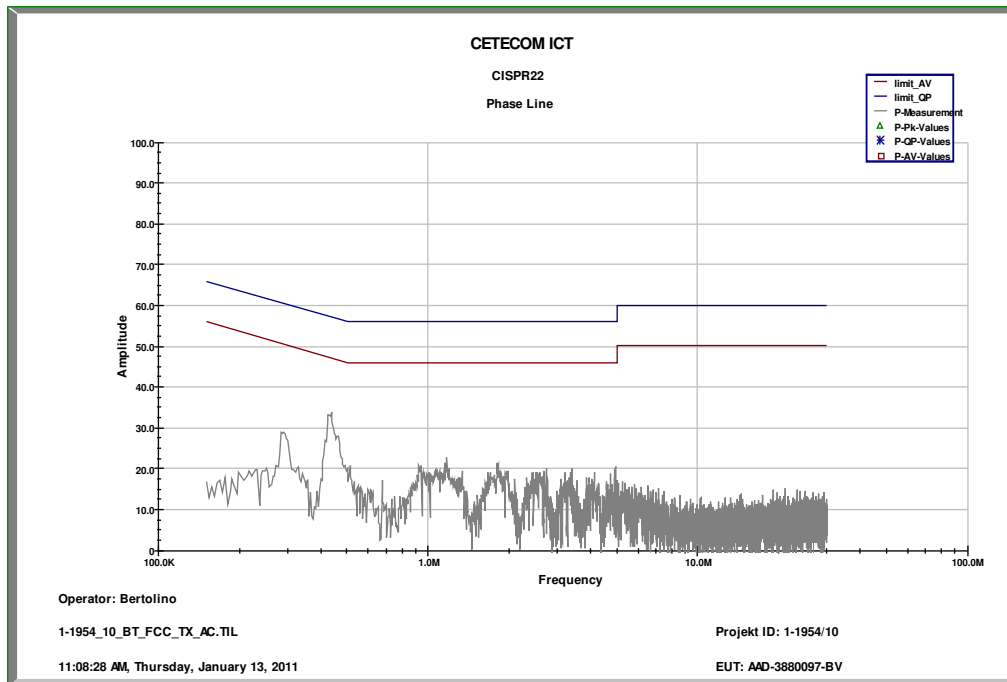

Plot 2: 9 kHz to 30 MHz / neutral Line, TX mode

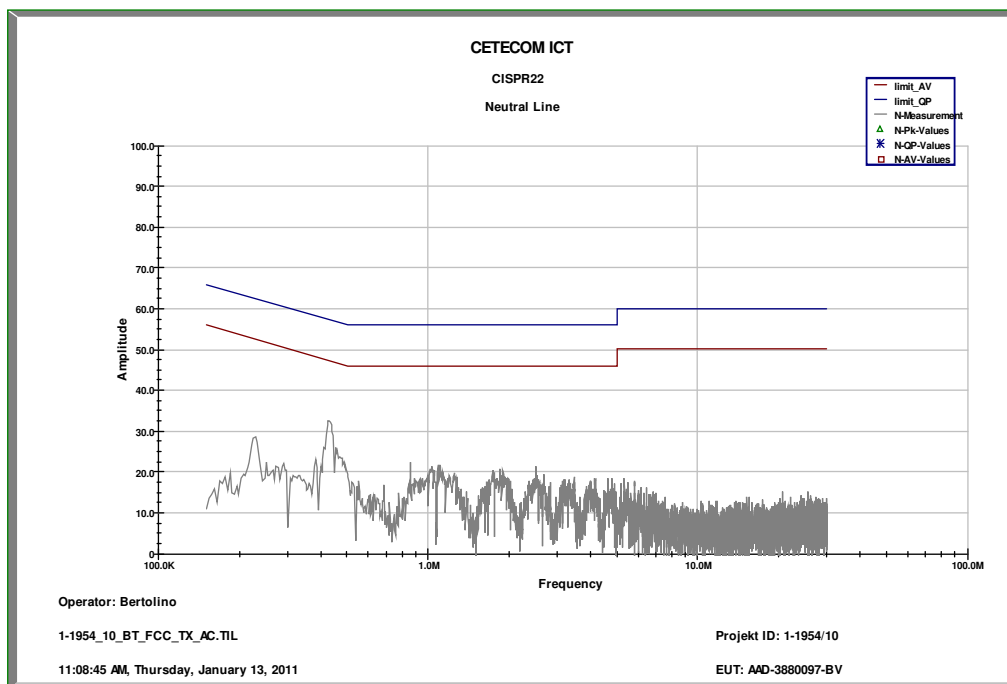

Plot 3: 9 kHz to 30 MHz / phase Line, RX mode

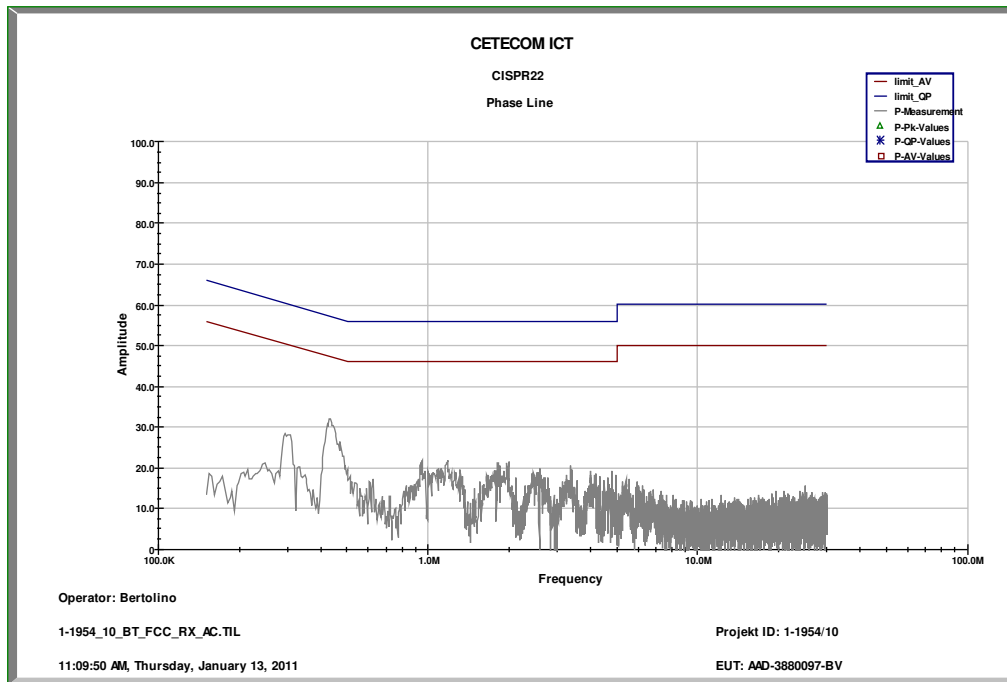

Plot 4: 9 kHz to 30 MHz / neutral Line, RX mode

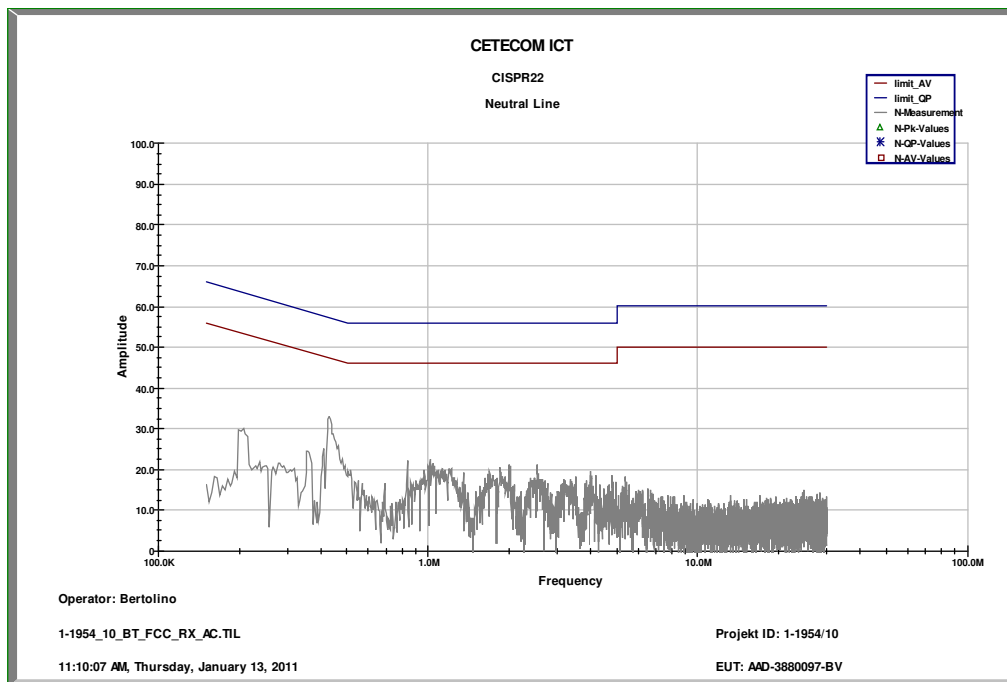

10 Test equipment and ancillaries used for tests

Typically, the calibrations of the test apparatus are commissioned to and performed by an accredited calibration laboratory. The calibration intervals are determined in accordance with the DIN EN ISO/IEC 17025. In addition to the external calibrations, the laboratory executes comparison measurements with other calibrated test systems or effective verifications. Weekly chamber inspections and range calibrations are performed. Where possible, rf-generating and signalling equipment as well as measuring receivers and analyzers are connected to an external high-precision 10 MHz reference (GPS-based or rubidium frequency standard).

In order to simplify the identification of the equipment used at some special tests, some items of test equipment and ancillaries can be provided with an identifier or number in the equipment list below (Labor/Item).

No.	Lab / Item	Equipment	Type	Manufact.	Serial No.	INV. No Cetecom	Kind of Calibration	Last Calibration	Next Calibration
1	45	Switch-Unit	3488A	HP Meßtechnik	2719A14505	300000368	g		
2	50	DC power supply, 60Vdc, 50A, 1200 W	6032A	HP Meßtechnik	2920A04466	300000580	k		
3	n. a.	software	SPS_PHE 1.4f	Spitzberger & Spieß	B5981; 5D1081;B5979	300000210	ne		
4	n. a.	EMI Test Receiver	ESCI 1166.5950.03	R&S	100083	300003312	k	08.01.2010	08.01.2012
5	n. a.	Analyzer-Reference-System (Harmonics and Flicker)	ARS 16/1	SPS	A3509 07/0 0205	300003314	k	01.06.2009	01.06.2011
6	n. a.	Amplifier	JS42-00502650-28-5A	MITEQ	1084532	300003379	ev		
7	n. a.	Antenna Tower	Model 2175	ETS-LINDGREN	64762	300003745	izw		
8	n. a.	Positioning Controller	Model 2090	ETS-LINDGREN	64672	300003746	izw		
9	n. a.	Turntable Interface-Box	Model 105637	ETS-LINDGREN	44583	300003747	izw		
10	n. a.	TRILOG Broadband Test-Antenna 30 MHz - 3 GHz	VULB9163	Schwarzbeck	295	300003787	k	01.04.2010	01.04.2012
11	n. a.	Spectrum-Analyzer	F5U26	R&S	200809	300003874	k	08.01.2010	08.01.2012
12	n. a.	Isolating Transformer	RT5A	Grundig	8041	300001626	g		
13	n. a.	PowerAttenuator	8325	Byrd	1530	300001595	ev		
14	n. a.	Double-Ridged Waveguide Horn Antenna 1-18.0GHz	3115	EMCO	8812-3088	300001032	viKI!	05.03.2009	05.03.2011
15	n. a.	Active Loop Antenna	6502	EMCO	2210	300001015	ne		
16	n. a.	Anechoic chamber	FAC 3/5m	MWB / TDK	87400/02	300000996		23.03.2009	
17	n. a.	Relais Matrix	3488A	HP Meßtechnik	2719A15013	300001156	ne		
18	n. a.	Relais Matrix	PSU	R&S	890167/024	300001168	ne		
19	n. a.	Isolating Transformer	RT5A	Grundig	9242	300001263	ne		
20	n. a.	Three-Way Power Splitter, 50 Ohm	11850C	HP Meßtechnik		300000997	ne		
21	n. a.	Switch / Control Unit	3488A	HP	2605e08770	300001443	ne		
22	n. a.	Amplifier	js42-00502650-28-5a	Parzich GMBH	928979	300003143	ne		
23	n. a.	Band Reject filter	WRCG2400/2483-2375/2505-50/10SS	Wainwright	11	300003351	ev		
24	n. a.	TILE-Software Emission	Quantum Change, Modell TILE-ICS/FULL	EMCO	none	300003451	ne		
25	n. a.	Highpass Filter	WHKX7.0/18G-8SS	Wainwright	18	300003789	ne		
26	n. a.	PSA Spectrum Analyzer 3 Hz - 26.5 GHz	E4440A	Agilent Technologies	MY48250080	300003812	k	08.09.2010	08.09.2012
27	n. a.	RF Filter Section	N9039A	Agilent	MY48260003	300003825	viKI!	08.09.2010	08.09.2012

		9kHz - 1GHz		Technologies					
28	n. a.	TRILOG Broadband Test-Antenna 30 MHz - 3 GHz	VULB9163	Schwarzbeck	371	300003854	vlKI!	17.12.2008	17.12.2011
29	n. a.	Switch / Control Unit	3488A	HP Meßtechnik		300001691	ne		
30	n. a.	Power Supply DC	NGPE 40/40	R&S	388	400000078	vlKI!	13.09.2010	13.09.2012
31	n. a.	Power Sensor 50 Ohms, 10 MHz - 18 GHz, 1 nW - 20 mW	NRV-Z1	R&S	833894/011	300002681-0010	k	09.09.2010	09.09.2012
32	n. a.	Hygro-Thermometer	-/-, 5-45°C, 20-100%rF	Thies Clima	-/-	400000080	k	04.05.2010	04.05.2011
33	n. a.	Vector Signal Generator, 300 kHz to 2.2 GHz	SMIQ03B	R&S	835541/055	300002681-0001	k	25.08.2008	25.08.2011
34	n. a.	Vector Signal Generator, 300 kHz to 2.2 GHz	SMIQ03B	R&S	835541/056	300002681-0002	k	26.08.2008	26.08.2011
35	n. a.	Signal Generator 0.01/2 - 20 GHz, Frequ. Resol. 0.1Hz	SMP02	R&S	835133/011	300002681-0003	k	26.08.2008	26.08.2011
36	n. a.	Dual Channel Power Meter	NRVD	R&S	835430/044	300002681-0004	k	13.09.2010	13.09.2012
37	n. a.	Signal Analyzer 20Hz-26,5GHz-150 to + 30 DBM	FSIQ26	R&S	835540/018	300002681-0005	k	07.01.2010	07.01.2012
38	n. a.	Frequency Standard (Rubidium Frequency Standard)	MFS (Rubidium)	R&S (Datum)	002	300002681-0009	Ve	13.09.2010	13.09.2012
39	n. a.	Directional Coupler	101020010	Krytar	70215	300002840	ev		
40	n. a.	DC-Blocker	8143	Inmet Corp.	none	300002842	ne		
41	n. a.	Powersplitter	6005-3	Inmet Corp.		300002841	ev		
42	n. a.	Temperature Test Chamber	VT 4002	Heraeus Voetsch	58566046820010	300003019	Ve	28.05.2009	28.05.2011
43	n. a.	CBT (Bluetooth Tester + EDR Signalling)	CBT 1153.9000K35	R&S	100185	300003416	vlKI!	13.09.2010	13.09.2012
44	n. a.	Spectrum Analyzer 9kHz to 30GHz - 140..+30dBm	FSP30	R&S	100886	300003575	k	07.09.2010	07.09.2012
45	n. a.	CBT-K57 Software-Option for CBT/CBT32	CBT-K57	R&S	101051	300003910	ne		

Agenda: Kind of Calibration

k calibration / calibrated
 ne not required (k, ev, izw, zw not required)
 ev periodic self verification
 Ve long-term stability recognized
 vlKI! Attention: extended calibration interval
 NK! Attention: not calibrated

EK limited calibration
 zw cyclical maintenance (external cyclical maintenance)
 izw internal cyclical maintenance
 g blocked for accredited testing
 *) next calibration ordered / currently in progress