

SONY®

Draft

User guide

SmartBand Talk

SWR30

Contents

Basics.....	3
Introduction.....	3
Hardware overview.....	3
Charging your SmartBand.....	4
Assembly.....	5
Turning your SmartBand Talk on and off.....	5
Setting up your SmartBand Talk.....	6
Preparing to use your SmartBand Talk.....	6
Reconnecting your SmartBand Talk.....	6
Resetting your SmartBand Talk.....	7
Settings for your SmartBand Talk.....	8
Using the SmartBand Talk SWR30 application.....	8
SmartBand alarm.....	8
Notifications.....	9
Call handling.....	10
Do not disturb.....	10
Display orientation.....	11
Display color.....	11
Finding your SmartBand Talk.....	11
Controlling applications from your SmartBand Talk.....	11
Logging your activities using the Lifelog application.....	13
Using the Lifelog application.....	13
Setting goals.....	15
Logging your sleep with your SmartBand.....	15
Creating life bookmarks.....	15
Important information.....	17
Using your SmartBand Talk in wet and dusty conditions.....	17
Legal information.....	18

Basics

Introduction

Your SmartBand Talk is designed to be worn on your dominant wrist and connects to your Android™ device to help you keep track of your daily activities. You can view the relevant data of your walking, running or sleeping on the SmartBand display and all the data is synchronised and stored via the Lifelog application on your Android™ device. The SmartBand also has a vibrate function which notifies you of alarms as well as incoming messages and calls. You can use the SmartBand to handle the incoming calls and control media playback on your Android™ device. You can even use the voice commands to get information or initiate an action.

Even when it's not connected to your Android™ device, your SmartBand Talk collects information about your step count as well as data about your walking, running and sleeping, and life bookmarks. Your SmartBand can store this data for up to two weeks.

- ! To use the SmartBand with your Android™ device, make sure that the software version of your Android™ device is Android™ 4.4 or later and that your Android™ device supports the Bluetooth® 3.0 (Classic). Also, remember that you need an active Internet connection to synchronise data between your SmartBand and Android™ device.

Hardware overview

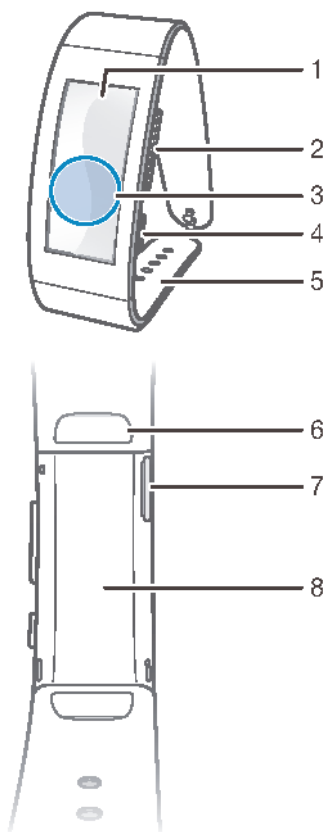

1	Display
2	Volume key
3	NFC detection area
4	Power key

5	Wrist band
6	Fix pin
7	Micro USB port
8	Core

Charging your SmartBand

Before using your SmartBand for the first time, you need to charge it for approximately 30 minutes. Sony chargers are recommended.

To charge your SmartBand Talk

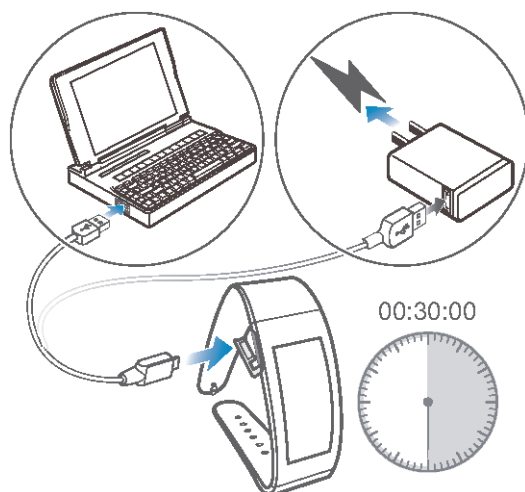

- 1 Plug one end of the USB cable into the charger or into the USB port of a computer.
- 2 Plug the other end of the cable into the Micro USB port of your SmartBand Talk.

To check the battery level of your SmartBand Talk

- 1 From the **Home screen** of your Android™ device, tap .
- 2 Find and tap **SmartBand Talk SWR30 > START**.

Low battery level notification

When your SmartBand is on and the battery level is less than 5%, your SmartBand emits two short vibrations and a popup window in the SmartBand application notifies you that your SmartBand is running out of battery.

Assembly

To detach your SmartBand Talk

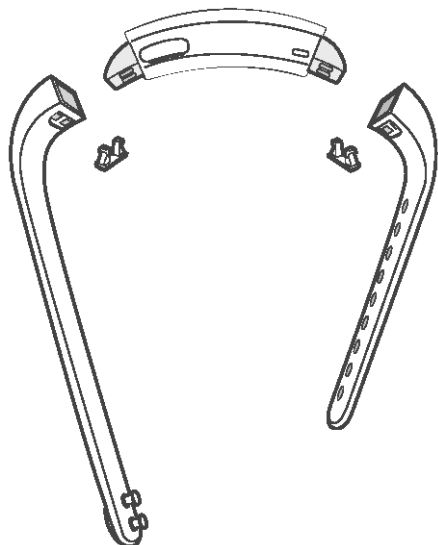

- 1 Remove the fix pins.
- 2 Remove the wrist bands.

Turning your SmartBand Talk on and off

To turn on your SmartBand Talk

- Press and hold down the power key until your SmartBand Talk vibrates.

To turn off your SmartBand Talk

- Press and hold down the power key for about 5 seconds, then release it.

Setting up your SmartBand Talk

Preparing to use your SmartBand Talk



For your SmartBand Talk to work, it must be connected to your Android™ device and the latest versions of the following applications must be installed on the Android™ device: **SmartBand Talk SWR30** and Lifelog.

If you set up your SmartBand Talk using NFC, you are guided during setup to Google Play™, from where you can install the necessary applications to use with your SmartBand Talk.

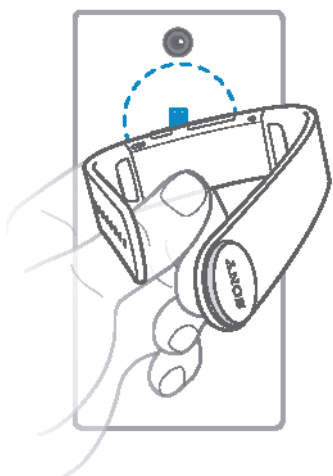

If you set up your SmartBand Talk using Bluetooth®, you have to go through some extra steps to install the necessary applications from Google Play™ and connect to your Android™ device.

To set up your SmartBand Talk using NFC



- 1 Make sure that your SmartBand Talk is charged for at least 30 minutes.
 - 2 Android™ device: Make sure that the NFC function is turned on and that the screen is active and unlocked.
 - 3 Place the Android™ device over your SmartBand Talk so that the NFC area of each device touches the other, then follow the instructions on the Android™ device to install the SmartBand Talk SWR30 application and the Lifelog application.  appears in the status bar when the SmartBand Talk is connected.
-  If you touch the NFC areas of each device to each other after all applications are installed and your SmartBand Talk is on and connected, the Lifelog application starts automatically.

To set up your SmartBand Talk using Bluetooth®

- 1 Make sure that your SmartBand Talk has been charged for at least 30 minutes.
 - 2 Turn on your SmartBand Talk.
 - 3 Android™ device: Turn on the Bluetooth® function, then scan for Bluetooth® devices and select SWR30 in the list of available devices.
 - 4 Follow the instructions to install the SmartBand Talk SWR30 application and the Lifelog application.  appears in the status bar when the SmartBand Talk is connected.
-  All applications required for the SmartBand Talk to work are available on Google Play™.

Reconnecting your SmartBand Talk

In cases where a connection gets lost, for example, when the connected Android™ device goes out of range, your SmartBand Talk automatically performs a series of reconnection attempts. If no connection is found after a certain period, your

SmartBand Talk stops trying to reconnect. When this happens, you can use the power key to restart the reconnection attempts, or you can use NFC to reconnect the two devices.

To force restart reconnection attempts

- Briefly press the power key.

To reconnect your SmartBand Talk using NFC

- 1 Android™ device: Make sure that the NFC function is turned on and that the screen is active and unlocked.
- 2 Place the Android™ device over your SmartBand Talk so that the NFC detection area of each device touches the other.  appears in the status bar when the SmartBand Talk is connected.

Resetting your SmartBand Talk

Reset your SmartBand Talk if it behaves unexpectedly or if you want to connect it to a new device.

To reset your SmartBand Talk

- 1 Turn off your SmartBand Talk.
- 2 Press and hold down the power key for at least 10 seconds.

Settings for your SmartBand Talk

Using the SmartBand Talk SWR30 application

You can view and change settings for your SmartBand Talk from the SmartBand Talk SWR30 application.



- 1 Turn the smart wake up function on or off. Add, edit or delete smart wake up alarms.
- 2 Turn the notifications function on or off. Select which notifications to forward to your SmartBand.
- 3 Turn incoming call notifications on or off. Select whether using your SmartBand to answer and reject calls directly.
- 4 Turn the do not disturb on or off. Add, edit or delete the do not disturb time.
- 5 Enable alarm notifications from Xperia™ devices.
- 6 Select the wearing orientation of the display.
- 7 Select the display color.

SmartBand alarm

Your SmartBand has two different alarm functions. One is the regular alarm function, which only works when your SmartBand is connected to an Xperia™ device. The other is the smart wake up function, which wakes you up when you have reached a state of light sleep, so you feel refreshed.

Alarm notifications from an Xperia™ device

Your SmartBand vibrates when pre-set alarms go off on a connected Xperia™ device.

To enable alarm notifications from an Xperia™ device

- 1 From the **Home screen** of your Xperia™ device, tap .
- 2 Find and tap **SmartBand Talk SWR30 > SETTINGS**.
- 3 Mark the **Alarm** checkbox.

To snooze an alarm when it vibrates

- Short press the power key on your SmartBand.

To turn off an alarm when it vibrates

- Long press the power key on your SmartBand.

Smart wake up alarm

You can set one or several smart wake up alarms in the **SmartBand Talk SWR30**. Smart wake up alarms wake you up at the best time based on your sleep cycle. They notify you with a continuous vibration. The Smart wake up function uses sleep data from your SmartBand over a pre-set time period to wake you up when you reach a state of light sleep.

For example, if you set a smart wake up alarm for 06:30 – 07:00, it wakes you up sometime between 06:30 and 07:00 when you reach a state of light sleep. If you do not reach a state of light sleep during this period, the smart wake up alarm wakes you up at 07:00.

To add a smart wake up alarm

- 1 From the **Home screen** of your Android™ device, tap .
- 2 Find and tap **SmartBand Talk SWR30 > SETTINGS**.
- 3 Tap **Smart wake up alarm**, then tap **+**.
- 4 Tap **Time**, then scroll up or down to adjust the setting and tap **Set**.
- 5 Tap **Repeat**, then mark the days for the alarm recurrence and tap **OK**.
- 6 Tap **Wake up interval**, then select an option.
- 7 Tap **Alarm window**, then select an option of how long before the alarm you want to be woken up.
- 8 Mark the **Has alarm signal** checkbox if you want the alarm alerts with sound.
- 9 Tap **Done**.

To edit an exiting smart wake up alarm

- 1 From the **Home screen** of your Android™ device, tap .
- 2 Find and tap **SmartBand Talk SWR30 > SETTINGS**.
- 3 Tap **Smart wake up alarm**, then tap the alarm that you want to set.
- 4 Tap **Time**, then scroll up or down to adjust the setting and tap **Set**.
- 5 Tap **Repeat**, then mark the days for the alarm recurrence and tap **OK**.
- 6 Tap **Wake up interval**, then select an option.
- 7 Tap **Alarm window**, then select an option of how long before the alarm you want to be woken up.
- 8 Mark the **Has alarm signal** checkbox if you want the alarm alerts with sound.
- 9 Tap **Done**.

To delete a smart wake up alarm

- 1 From the **Home screen** of your Android™ device, tap .
- 2 Find and tap **SmartBand Talk SWR30 > SETTINGS**.
- 3 Tap **Smart wake up alarm**, then touch and hold the alarm that you want to delete.
- 4 Tap **X**, then tap **Yes**.

To turn on a smart wake up alarm

- 1 From the **Home screen** of your Android™ device, tap .
- 2 Find and tap **SmartBand Talk SWR30 > SETTINGS**.
- 3 Tap **Smart wake up alarm**, then drag the slider beside the smart wake up alarm that you want to activate to the right.

To turn off a smart wake up alarm when it vibrates

- Long press the power key on your SmartBand.

Notifications

All notifications that appear in the status bar on a connected Android™ device can be forwarded to your SmartBand. For example, when there is an incoming notification, your SmartBand vibrates continuously. Use the SmartBand application to select which notifications to forward to your SmartBand.

To turn on the notifications function

- 1 From the **Home screen** of your Android™ device, tap .
- 2 Find and tap **SmartBand Talk SWR30 > SETTINGS**.
- 3 Drag the slider besides **Notifications** to the right.
- 4 If you are turning on the notifications function for the first time, follow the instructions that appear on the screen to give the SmartBand application access to your notifications.

To select which notifications to forward to your SmartBand

- 1 From the **Home screen** of your Android™ device, tap .
- 2 Find and tap **SmartBand Talk SWR30 > SETTINGS > Notifications**.
- 3 Tap **+Add application**.
- 4 Tap **Downloaded** or **All applications**.
- 5 In the list that appears, mark or unmark the desired options.
- 6 Tap **Done**.

Call handling

Your SmartBand notifies you with continuous vibrations when a call is coming in. You can also use your SmartBand to take or reject an incoming call directly.

To turn on the incoming call notification function

- 1 From the **Home screen** of your Android™ device, tap .
- 2 Find and tap **SmartBand Talk SWR30 > SETTINGS**.
- 3 Drag the slider beside **Call handling** to the right.

To turn on the answering and making phone calls function on your SmartBand

- 1 From the **Home screen** of your Android™ device, tap .
- 2 Find and tap **SmartBand Talk SWR30 > SETTINGS**.
- 3 Tap **Call handling**.
- 4 Mark the **Audio routing** checkbox.

To answer an incoming call from your SmartBand

- Short press the power key on your SmartBand.

To reject an incoming call from your SmartBand

- Long press the power key on your SmartBand.

Do not disturb

You can turn off all the notifications, events and alert sounds by turning on the do not disturb function. But when this function is on, the smart wake up alarm is not turned off.

To turn on the do not disturb function

- 1 From the **Home screen** of your Android™ device, tap .
- 2 Find and tap **SmartBand Talk SWR30 > SETTINGS**.
- 3 Drag the slide beside **Do not disturb** to the right.

To select the do not disturb time

- 1 From the **Home screen** of your Android™ device, tap .
- 2 Find and tap **SmartBand Talk SWR30 > SETTINGS > Do not disturb**.
- 3 Drag the slide beside **Repeat** to the right.
- 4 Tap **Repeat**.
- 5 Tap the start time, then scroll up or down to adjust the setting and tap **Set**.
- 6 Tap the end time, then scroll up or down to adjust the setting and tap **Set**.
- 7 Tap **Done**.

Display orientation

You can set the display orientation of your SmartBand according to on which arm you wear your SmartBand.

To select the display orientation

- 1 From the **Home screen** of your Android™ device, tap .
- 2 Find and tap **SmartBand Talk SWR30 > SETTINGS**
- 3 Tap **Display orientation**, then select an option.
- 4 Tap **OK**.

Display color

You can select the display color for your SmartBand to make it more like your style.

To select the display color

- 1 From the **Home screen** of your Android™ device, tap .
- 2 Find and tap **SmartBand Talk SWR30 > SETTINGS**.
- 3 Tap **Display color**, then select an option.
- 4 Tap **OK**.

Finding your SmartBand Talk

In case you forget where you left it, you can locate your SmartBand Talk by activating the ringer remotely.

To find your SmartBand Talk

- 1 From the **Home screen** of your Xperia™ device, tap .
- 2 Find and tap **SmartBand Talk SWR30 > START**.
- 3 Tap **Find Smartband > Find Smartband**. Your SmartBand starts to ring loudly.

-  You can press any key on your SmartBand to mute the ringing.

Controlling applications from your SmartBand Talk

You can add up to nine applications shown on your SmartBand. You can control the selected applications on the connected Android™ device using your SmartBand Talk directly. For example, if you have selected the Media player, you can control media playing on the connected Android™ device using your SmartBand.

To select an application to control using your SmartBand

- 1 From the **Home screen** of your Android™ device, tap .
- 2 Find and tap **SmartBand Talk SWR30 > MY APPS**.
- 3 Tap **Add apps**, then select an option.
- 4 If you want to download more applications, tap **Get more apps**. Then follow the downloading instructions.

To rearrange the selected applications

- 1 From the **Home screen** of your Android™ device, tap .
- 2 Find and tap **SmartBand Talk SWR30 > MY APPS**.
- 3 Press and drag an application to your desired position.

To edit a selected application

- 1 From the **Home screen** of your Android™ device, tap .
- 2 Find and tap **SmartBand Talk SWR30 > MY APPS**.
- 3 Tap an application, then edit according to the setting instructions.

To delete a selected application

- 1 From the **Home screen** of your Android™ device, tap .
- 2 Find and tap **SmartBand Talk SWR30 > MY APPS**.
- 3 Press and drag an application to **X**.

To control media player on your Android™ device from your SmartBand

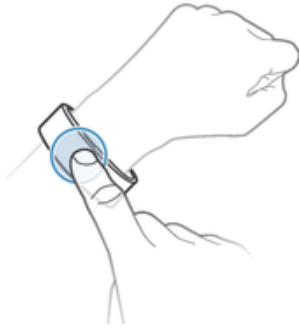

- 1 Make sure that your SmartBand is connected to your Android™ device.
- 2 Select Media player as the application that can be controlled through your SmartBand Talk.
- 3 Short press the power key on your SmartBand three times to enter Media player mode.
- 4 To play or pause the media file, tap the SmartBand once. To go to the next media file, tap twice. To go to the previous media file, tap three times.
- 5 To deselect the Media player as the application controlled by your SmartBand, short press the power key or wait for 30 seconds without touching the SmartBand (to allow the application to be deselected automatically).

Logging your activities using the Lifelog application

Using the Lifelog application

The Lifelog application records your physical, social and entertainment activities. For example, you can see if you've been walking or running and how you communicate with your friends. You can also see what pictures you took and what music you listened to. To start using the Lifelog application, you need to download it from Google Play™ and then set up an account.

- 💡 The statistics that the Lifelog application generates from your physical activities, for example, walking distance and calorie count, are based on the height and weight data you provide. Results may vary from user to user.

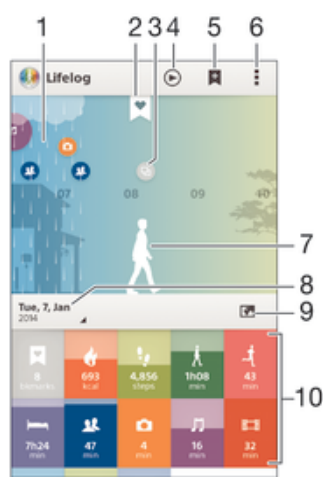

- 1 Show all logged activities and life bookmarks
- 2 View detailed information about a life bookmark
- 3 View information about application usage
- 4 View all logged activities since the start of the day
- 5 Add a life bookmark
- 6 View menu options
- 7 Physical activities log
- 8 View all logged activities for the selected day
- 9 Switch between dashboard and map view
- 10 Activities dashboard

To set up an account for the Lifelog application

- 1 From the **Home screen** of your Android™ device, tap , then find and tap **Lifelog**.
- 2 Follow the instructions that appear on the screen and accept the terms and conditions.
- 3 Create a new account or select to use an existing one. Sony PlayStation® Network accounts can also be used.
- 4 Follow the instructions that appear on the screen to create a Lifelog account.



To log in to the Lifelog application

- 1 From the **Home screen** of your Android™ device, tap , then find and tap **Lifelog**.
- 2 Follow the instructions that appear on the screen and accept the terms and conditions.



Adjusting the stride length for walking and running

The Lifelog application uses the number of steps you have taken and your stride length to calculate the distance you have walked or run. The automatic stride length used by default is based on your gender and height. If you feel that the distances measured by the Lifelog application are not accurate enough, you can adjust your stride length.

To adjust the stride length for walking

- 1 From the **Home screen** of your Android™ device, tap , then find and tap **Lifelog**.
- 2 Tap  > **Settings** > **Profile**.
- 3 Find and tap **Stride length**.
- 4 Unmark the **Automatic** checkbox if it is marked, then scroll up or down to adjust the setting and tap **Set**.

To adjust the stride length for running

- 1 From the **Home screen** of your Android™ device, tap , then find and tap **Lifelog**.
- 2 Tap  > **Settings** > **Profile**.
- 3 Find and tap **Running stride length**.
- 4 Unmark the **Automatic** checkbox if it is marked, then scroll up or down to adjust the setting and tap **Set**.

Activity box overview

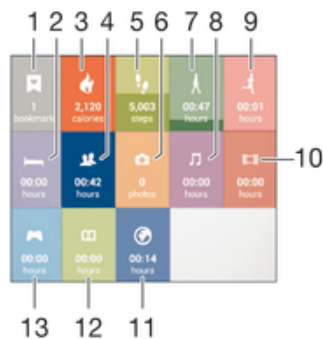

- 1 View all logged life bookmarks
- 2 View your sleep hours and check the quality of your sleep based on the information collected
- 3 View the amount of active calories that you have burned while exercising and the passive calories that you have burned while not exercising
- 4 View the time you have spent using communication applications from Google Play™ and some other applications such as the Phone and the Messaging applications from Sony
- 5 View the number of steps you have taken and logged in the Lifelog application
- 6 View how many photos you have taken
- 7 View the total time you have spent walking for longer than just a few steps
- 8 View the time you have spent listening to music using applications from Google Play™ and some other applications such as the "WALKMAN" application
- 9 View the total time you have spent running with a high steps-per-minute ratio for longer than just a few steps

- 10 View your total time spent watching movies, TV shows and other video content using applications from Google Play™ and some other applications
- 11 View your total time spent browsing while using applications from Google Play™ and some other web browsers
- 12 View your total time spent reading books or comics using applications from Google Play™ and some other applications
- 13 View your total time spent playing games using applications from Google Play™ and PlayStation® Store

Activity overview

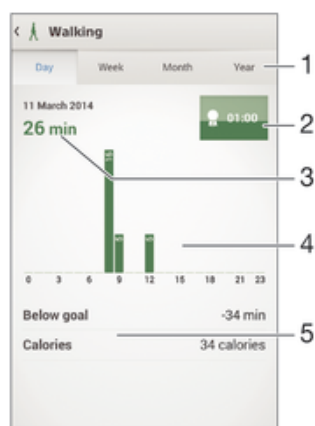

- 1 Show data in a day, week, month or year view
- 2 Show your current goal status
- 3 Show the current activity in different units
- 4 Show the amount of activity using the chosen unit type
- 5 Details about your activity

Setting goals

Set goals for activities in your daily life, for example, the number of steps to take, the distance you want to walk, or the amount of calories you want to burn.

To set a goal

- 1 In the Lifelog application, tap the activity that you want to set a goal for.
- 2 Tap **Day**, then tap the goal dashboard.
- 3 Scroll up or down to adjust the value for your goal, then tap **Set**.

Logging your sleep with your SmartBand

Your SmartBand can log the hours you sleep, as well as the status for light sleep, deep sleep and your awake time during sleep hours to help you understand your sleep quality. The data that your SmartBand tracks is logged in the Lifelog application. In order to log sleep data, SmartBand must be in night mode.

To view your sleep data

- In the Lifelog application, tap **Sleep** from the Activities dashboard.

Creating life bookmarks

Use your SmartBand to create life bookmarks. Life bookmarks save information about time and locations, and help you remember special occasions. For location data to be gathered, you must have an active Internet connection.

To create a life bookmark using the Lifelog application

- 1 In the Lifelog application, tap .
- 2 Follow the on-screen instructions.
- 3 If necessary, add notes, then tap **OK**.

To create a life bookmark using your SmartBand Talk

- 1 Make sure that your SmartBand is turned on.
- 2 Press the power key to go to the Life bookmark screen.
- 3 Tap  on the SmartBand screen to log the place and time.
- 4 Connect your SmartBand to your Android™ device. If necessary, add notes to the bookmark using the Lifelog application.

Important information

Using your SmartBand Talk in wet and dusty conditions

Your SmartBand Talk is waterproof and dust resistant in compliance with the Ingress Protection (IP) ratings IP55 and IP58, as explained in the table below.

These specific IP ratings mean that your SmartBand Talk is dust resistant and is protected against low pressure water stream as well as against the effects of immersion for 30 minutes in fresh (non-saline) water up to 3 metres deep.

You can use your SmartBand Talk:

- in dusty environments, for example, on a windy beach.
- when your fingers are wet.
- in some extreme weather conditions, for example, when it's snowing or raining.
- in fresh (non-saline) water depths of 3 metres or less, for example, in a fresh water lake or river.
- in a chlorinated swimming pool.

Even if your SmartBand Talk is resistant to dust and water, you should avoid exposing it unnecessarily to environments with excessive dust, sand and mud or to moist environments with extreme high or low temperatures. The waterproof ability of the micro USB port cannot be guaranteed in all environments or conditions.

Never immerse your SmartBand Talk in salt water or let the micro USB port come in contact with salt water. For example, if you're at the beach, remember to keep your SmartBand Talk away from the sea water. Also, never expose the SmartBand Talk to any liquid chemicals. For example, if you're washing dishes by hand using liquid detergent, avoid bringing your SmartBand Talk in contact with the detergent. After exposure to non-fresh water, rinse your SmartBand Talk using fresh water.

Normal wear and tear along with damage to your SmartBand Talk can reduce its ability to resist dust or moisture. After using the SmartBand Talk in water, dry off the areas around the micro USB port.

All compatible accessories, including batteries, chargers and micro USB cables, are not waterproof and dust resistant on their own.

Your warranty does not cover damage or defects caused by abuse or improper use of your SmartBand Talk (including use in environments where the relevant IP rating limitations are exceeded). If you have any further questions about the use of your products, refer to our Customer support service for help. To view more specific information about water resistance, go to <http://www.sonymobile.com/global-en/support/discover-more/water-and-dust-resistance/>.

Ingress Protection Rating

Your SmartBand Talk has an IP rating, which means it has undergone certified tests to measure its resistance levels to both dust and water. The first digit in the two-digit IP rating indicates the level of protection against solid objects, including dust. The second digit indicates how resistant the device is to water.

Resistance to solid objects and dust	Resistance to water
IP0X: No special protection	IPX0: No special protection
IP1X: Protected against solid objects > 50 mm in diameter	IPX1: Protected against dripping water
IP2X: Protected against solid objects > 12.5 mm in diameter	IPX2: Protected against dripping water when tilted up to 15 degrees from normal position
IP3X: Protected against solid objects > 2.5 mm in diameter	IPX3: Protected against spraying water
IP4X: Protected against solid objects > 1 mm in diameter	IPX4: Protected against splashing water

IP5X. Protected against dust; limited ingress (no harmful deposit)

IPX5. Protected against water jet spray for at least 3 minutes

IP6X. Dust tight

IPX6. Protected against heavy jet spray for at least 3 minutes

IPX7. Protected against the effects of immersion in up to 1 metre of water for 30 minutes

IPX8. Protected against the effects of continued immersion in water depths greater than 1 metre. The exact conditions are specified for each device by the manufacturer.

Legal information

Sony SWR30



Prior to use, please read the *Important information* leaflet separately provided.

This User guide is published by Sony Mobile Communications AB or its local affiliated company, without any warranty. Improvements and changes to this User guide necessitated by typographical errors, inaccuracies of current information, or improvements to programs and/or equipment, may be made by Sony Mobile Communications AB at any time and without notice. Such changes will, however, be incorporated into new editions of this User guide.

All rights reserved.

©2014 Sony Mobile Communications AB.

Interoperability and compatibility among Bluetooth® devices varies. Device generally supports products utilizing Bluetooth spec. 1.2 or higher, and Headset or Handsfree profile.

Sony is the trademark or registered trademark of Sony Corporation. Bluetooth is the trademark of the Bluetooth (SIG) Inc. and is used under license. All other marks are the property of their respective owners. All rights reserved.

All product and company names mentioned herein are the trademarks or registered trademarks of their respective owners. Any rights not expressly granted herein are reserved. All other trademarks are property of their respective owners.

Visit www.sonymobile.com for more information.

All illustrations are for illustration only and may not accurately depict the actual accessory.

Declaration of Conformity

We, Sony Mobile Communications AB of
Nya Vattentorget
SE-221 88 Lund, Sweden

declare under our sole responsibility that our product

Sony type **RD-0140**

and in combination with our accessories, to which this declaration relates is in conformity with the appropriate standards **EN 300 328:V1.8.1, EN 301 489-17:V2.2.1, EN 301 489-3:V1.6.1 and EN 60 950-1:2006 +A11:2009 +A1:2010+A12:2011+A12:2011** following the provisions of, Radio Equipment and Telecommunication Terminal Equipment directive 1999/5/EC.

Lund, July 2014

CE 0682



Pär Thuresson,
Quality Officer, SVP, Quality & Customer Services

FCC Statement

This device complies with Part 15 of the FCC rules. Operation is subject to the following two conditions: (1) This device may not cause harmful interference, and (2) This device must accept any interference received, including interference that may cause undesired operation.



Any change or modification not expressly approved by Sony may void the user's authority to operate the equipment.

This equipment has been tested and found to comply with the limits for a Class B digital device, pursuant to Part 15 of the FCC Rules. These limits are designed to provide reasonable protection against harmful interference in a residential installation. This equipment generates, uses and can radiate radio frequency energy and, if not installed and used in accordance with the instructions, may cause harmful interference to radio communications. However, there is no guarantee that interference will not occur in a particular installation.

If this equipment does cause harmful interference to radio or television reception, which can be determined by turning the equipment off and on, the user is encouraged to try to correct the interference by one or more of the following measures:

- Reorient or relocate the receiving antenna.
- Increase the separation between the equipment and receiver.
- Connect the equipment into an outlet on a circuit different from that to which the receiver is connected.
- Consult the dealer or an experienced radio/TV technician for help.

AVISO IMPORTANTE PARA MÉXICO

La operación de este equipo está sujeta a las siguientes dos condiciones: (1) es posible que este equipo o dispositivo no cause interferencia perjudicial y (2) este equipo o dispositivo debe aceptar cualquier interferencia, incluyendo la que pueda causar su operación no deseada.

Para consultar la información relacionada al número del certificado, refiérase a la etiqueta del empaque y/o del producto.

Alimentación: 5,0 Vcc

Industry Canada Statement

This device complies with RSS-210 of Industry Canada.

Operation is subject to the following two conditions: (1) this device may not cause interference, and (2) this device must accept any interference, including interference that may cause undesired operation of the device. This Class B digital apparatus complies with Canadian ICES-003.

Cet appareil numérique de la classe B est conforme à la norme NMB-003 du Canada.

Avis d'industrie Canada

Le présent appareil est conforme aux CNR d'Industrie Canada applicables aux appareils radio exempts de licence.

L'exploitation est autorisée aux deux conditions suivantes: (1) l'appareil ne doit pas produire de brouillage, et, and (2) l'utilisateur de l'appareil doit accepter tout brouillage radioélectrique subi, même si le brouillage est susceptible d'en compromettre le fonctionnement.