



FCC RF Test Report

APPLICANT : Sony Mobile Communications Inc.
EQUIPMENT : GSM/WCDMA/LTE Phone + Bluetooth, DTS/UNII a/b/g/n/ac,
ANT+, and NFC
BRAND NAME : Sony
FCC ID : PY7-PM0881
STANDARD : 47 CFR Part 2, 22(H), 24(E), 27
CLASSIFICATION : PCS Licensed Transmitter Held to Ear (PCE)

The product was received on Jul. 16, 2015 and completely tested on Sep. 01, 2015. We, SPORTON INTERNATIONAL INC., would like to declare that the tested sample has been evaluated in accordance with the test procedures given in ANSI / TIA / EIA-603-C-2004 and the testing has shown the tested sample to be in compliance with the applicable technical standards.

The test results in this report apply exclusively to the tested model / sample. Without written approval of SPORTON INTERNATIONAL INC., the test report shall not be reproduced except in full.

Reviewed by: Joseph Lin / Supervisor

Approved by: Jones Tsai / Manager



SPORTON INTERNATIONAL INC.

No. 52, Hwa Ya 1st Rd., Hwa Ya Technology Park, Kwei-Shan District, Tao Yuan City, Taiwan, R.O.C.

SPORTON INTERNATIONAL INC.

TEL : 886-3-327-3456

FAX : 886-3-328-4978

FCC ID : PY7-PM0881

Page Number : 1 of 28

Report Issued Date : Sep. 08, 2015

Report Version : Rev. 01

Report Template No.: BU5-FGLTE Version 1.3



TABLE OF CONTENTS

REVISION HISTORY..... 3
SUMMARY OF TEST RESULT 4
1 GENERAL DESCRIPTION 6
1.1 Applicant 6
1.2 Manufacturer 6
1.3 Product Feature of Equipment Under Test..... 6
1.4 Modification of EUT 7
1.5 Emission Designator 7
1.6 Testing Location 9
1.7 Applicable Standards 9
2 TEST CONFIGURATION OF EQUIPMENT UNDER TEST 10
2.1 Test Mode 10
2.2 Connection Diagram of Test System 12
2.3 Support Unit used in test configuration and system 12
2.4 Measurement Results Explanation Example 12
3 CONDUCTED TEST ITEMS 13
3.1 Measuring Instruments 13
3.2 Test Setup 13
3.3 Test Result of Conducted Test 13
3.4 Conducted Output Power 14
3.5 Peak-to-Average Ratio 15
3.6 Occupied Bandwidth 16
3.7 Conducted Band Edge 17
3.8 Conducted Spurious Emission 19
3.9 Frequency Stability 20
4 RADIATED TEST ITEMS 21
4.1 Measuring Instruments 21
4.2 Test Setup 21
4.3 Test Result of Radiated Test 21
4.4 Effective Radiated Power and Effective Isotropic Radiated Power 22
4.5 Radiated Spurious Emission 24
5 LIST OF MEASURING EQUIPMENT 26
6 UNCERTAINTY OF EVALUATION 28

APPENDIX A. TEST RESULTS OF CONDUCTED TEST

APPENDIX B. TEST RESULTS OF RADIATED TEST



REVISION HISTORY

REPORT NO.	VERSION	DESCRIPTION	ISSUED DATE
FG571618B	Rev. 01	Initial issue of report	Sep. 08, 2015



SUMMARY OF TEST RESULT

Report Section	FCC Rule	Description	Limit	Result	Remark
3.4	§2.1046	Conducted Output Power	Reporting Only	PASS	-
3.5	§24.232(d)	Peak-to-Average Ratio	<13 dB	PASS	-
3.6	§2.1049	Occupied Bandwidth	Reporting Only	PASS	-
3.7	§2.1051 §22.917(a) §24.238(a) §27.53(g) §27.53(h)	Conducted Band Edge Measurement (Band 2) (Band 4) (Band 5) (Band 12) (Band 17)	< 43+10log ₁₀ (P[Watts])	PASS	-
	§27.53(m)(4)	Conducted Band Edge Measurement (Band 7)	§27.53(m)(4)		
3.8	§2.1051 §22.917(a) §24.238(a) §27.53(g) §27.53(h)	Conducted Spurious Emission (Band 2) (Band 4) (Band 5) (Band 12) (Band 17)	< 43+10log ₁₀ (P[Watts])	PASS	-
	§2.1051 §27.53(m)(4)	Conducted Spurious Emission (Band 7)	< 55+10log ₁₀ (P[Watts])		



Report Section	FCC Rule	Description	Limit	Result	Remark
3.9	§2.1055 §22.355	Frequency Stability Temperature & Voltage	< 2.5 ppm	PASS	-
	§2.1055 §24.235 §27.54		Within Authorized Band		
4.4	§22.913(a)(2)	Effective Radiated Power (Band 5)	ERP < 7 Watt	PASS	-
	§27.50(c)(10)	Effective Radiated Power (Band 12) (Band 17)	ERP < 3 Watt		
	§24.232(c) §27.50(h)(2)	Equivalent Isotropic Radiated Power (Band 2) (Band 7)	EIRP < 2Watt		
	§27.50(d)(4)	Equivalent Isotropic Radiated Power (Band 4)	EIRP < 1Watt		
4.5	§2.1053 §22.917(a) §24.238(a) §27.53(g) §27.53(h)	Radiated Spurious Emission (Band 2) (Band 4) (Band 5) (Band 12) (Band 17)	< 43+10log ₁₀ (P[Watts])	PASS	Under limit 22.68 dB at 10260.000 MHz
	§2.1053 §27.53(m)(4)	Radiated Spurious Emission (Band 7)	< 55+10log ₁₀ (P[Watts])		

Remark: Except effective Radiated Power and Equivalent Isotropic Radiated Power of LTE Band4, LTE Band 7, LTE Band 12 and LTE Band 17 are carrying out, FG571618B report reuses test data from the FG571617B report.



1 General Description

1.1 Applicant

Sony Mobile Communications Inc.
Nya Vattentorget, 22188 Lund, Sweden

1.2 Manufacturer

Sony Mobile Communications Inc.
1-8-15 Konan, Minato-ku, Tokyo, 108-0075, Japan

1.3 Product Feature of Equipment Under Test

GSM/WCDMA/LTE, Bluetooth, DTS/UNII a/b/g/n/ac, ANT+, NFC, and GPS

Product Specification subjective to this standard	
Antenna Type	Monopole Antenna

EUT Information List				
IMEI	HW Version	SW Version	S/N	Performed Test Item
004402455123103	A	32.0.A.0.287	CB5A273TP8	Conducted Measurement
004402455122380			CB5A273TP1	Radiated Spurious Emission
004402455122380			CB5A273TP1 CB5A27905N	ERP/EIRP Test
004402455104988				

Accessory List	
AC Adapter	Model No. : UCH20
	Type No. : AC-0061-US
	S/N : 2115W15500021
Earphone	Model No. : MDR-NC31E
	Type No. : AG-1110
USB Cable	Model No. : UCB11
	Type No. : AI-0120
	S/N : 1522A731000010A

Note:

1. Above EUT list and accessory list used are electrically identical per declared by manufacturer.
2. Above the accessories list are used to exercise the EUT during test.
3. For other wireless features of this EUT, test report will be issued separately.



1.4 Modification of EUT

No modifications are made to the EUT during all test items.

1.5 Emission Designator

LTE Band 2	QPSK			16QAM		
BW(MHz)	Emission Designator (99%OBW)	Frequency Tolerance (ppm)	Maximum EIRP(W)	Emission Designator (99%OBW)	Frequency Tolerance (ppm)	Maximum EIRP(W)
1.4	1M09G7D		0.2523	1M09W7D		0.1892
3	2M73G7D		0.2655	2M73W7D		0.2188
5	4M50G7D		0.2399	4M51W7D		0.2018
10	9M15G7D	0.0088	0.2477	9M05W7D		0.2028
15	13M5G7D		0.1982	13M5W7D		0.2495
20	18M5G7D		0.2685	18M5W7D		0.2198
LTE Band 4	QPSK			16QAM		
BW(MHz)	Emission Designator (99%OBW)	Frequency Tolerance (ppm)	Maximum EIRP(W)	Emission Designator (99%OBW)	Frequency Tolerance (ppm)	Maximum EIRP(W)
1.4	1M09G7D		0.2247	1M09W7D		0.1977
3	2M72G7D		0.2296	2M72W7D		0.2014
5	4M51G7D		0.2244	4M49W7D		0.1901
10	9M05G7D	0.0010	0.2239	9M03W7D		0.1845
15	13M5G7D		0.2178	13M5W7D		0.1742
20	18M4G7D		0.2158	18M5W7D		0.1791
LTE Band 5	QPSK			16QAM		
BW(MHz)	Emission Designator (99%OBW)	Frequency Tolerance (ppm)	Maximum ERP(W)	Emission Designator (99%OBW)	Frequency Tolerance (ppm)	Maximum ERP(W)
1.4	1M09G7D		0.0624	1M10W7D		0.0535
3	2M73G7D		0.0687	2M73W7D		0.0556
5	4M49G7D		0.0627	4M49W7D		0.0577
10	9M05G7D	0.0029	0.0644	9M05W7D		0.0543



LTE Band 7		QPSK			16QAM		
BW(MHz)	Emission Designator (99%OBW)	Frequency Tolerance (ppm)	Maximum EIRP(W)	Emission Designator (99%OBW)	Frequency Tolerance (ppm)	Maximum EIRP(W)	
5	4M52G7D		0.1202	4M49W7D		0.1208	
10	9M03G7D	0.0006	0.1633	9M07W7D		0.1318	
15	13M5G7D		0.1503	13M5W7D		0.1355	
20	18M5G7D		0.1469	18M5W7D		0.1340	
LTE Band 12		QPSK			16QAM		
BW(MHz)	Emission Designator (99%OBW)	Frequency Tolerance (ppm)	Maximum ERP(W)	Emission Designator (99%OBW)	Frequency Tolerance (ppm)	Maximum ERP(W)	
1.4	1M09G7D		0.0401	1M09W7D		0.0350	
3	2M73G7D		0.0425	2M75W7D		0.0343	
5	4M51G7D		0.0410	4M50W7D		0.0342	
10	9M05G7D	0.0123	0.0378	9M05W7D		0.0315	
LTE Band 17		QPSK			16QAM		
BW(MHz)	Emission Designator (99%OBW)	Frequency Tolerance (ppm)	Maximum ERP(W)	Emission Designator (99%OBW)	Frequency Tolerance (ppm)	Maximum ERP(W)	
5	4M49G7D		0.0383	4M50W7D		0.0322	
10	9M03G7D	0.0124	0.0376	9M03W7D		0.0320	



1.6 Testing Location

Sporton Lab is accredited to ISO 17025 by Taiwan Accreditation Foundation (TAF code : 1190) and the FCC designation No. TW1022 under the FCC 2.948(e) by Mutual Recognition Agreement (MRA) in FCC Test.

Test Site	SPORTON INTERNATIONAL INC.	
Test Site Location	No. 52, Hwa Ya 1 st Rd., Hwa Ya Technology Park, Kwei-Shan District, Tao Yuan City, Taiwan, R.O.C. TEL: +886-3-327-3456 FAX: +886-3-328-4978	
Test Site No.	Sporton Site No.	
	TH05-HY	03CH07-HY

1.7 Applicable Standards

According to the specifications of the manufacturer, the EUT must comply with the requirements of the following standards:

- ♦ 47 CFR Part 2, 22(H), 24(E), 27
- ♦ ANSI / TIA / EIA-603-C-2004
- ♦ FCC KDB 971168 D01 Power Meas. License Digital Systems v02r02

Remark: All test items were verified and recorded according to the standards and without any deviation during the test.



2 Test Configuration of Equipment Under Test

2.1 Test Mode

Antenna port conducted and radiated test items listed below are performed according to KDB 971168 D01 Power Meas. License Digital Systems v02r02 with maximum output power.

Radiated measurements are performed by rotating the EUT in three different orthogonal test planes to find the maximum emission.

Test Items	Band	Bandwidth (MHz)						Modulation		RB #			Test Channel		
		1.4	3	5	10	15	20	QPSK	16QAM	1	Half	Full	L	M	H
Max. Output Power	2	✓	✓	✓	✓	✓	✓	✓	✓	✓	✓	✓	✓	✓	✓
	4	✓	✓	✓	✓	✓	✓	✓	✓	✓	✓	✓	✓	✓	✓
	5	✓	✓	✓	✓	-	-	✓	✓	✓	✓	✓	✓	✓	✓
	7	-	-	✓	✓	✓	✓	✓	✓	✓	✓	✓	✓	✓	✓
	12	✓	✓	✓	✓	-	-	✓	✓	✓	✓	✓	✓	✓	✓
	17	-	-	✓	✓	-	-	✓	✓	✓	✓	✓	✓	✓	✓
Peak-to-Average Ratio	2						✓	✓	✓	✓		✓	✓	✓	✓
	4						✓	✓	✓	✓		✓	✓	✓	✓
	5				✓	-	-	✓	✓	✓		✓	✓	✓	✓
	7	-	-				✓	✓	✓	✓		✓	✓	✓	✓
	12				✓	-	-	✓	✓	✓		✓	✓	✓	✓
	17	-	-		✓	-	-	✓	✓	✓		✓	✓	✓	✓
26dB and 99% Bandwidth	2	✓	✓	✓	✓	✓	✓	✓	✓			✓	✓	✓	✓
	4	✓	✓	✓	✓	✓	✓	✓	✓			✓	✓	✓	✓
	5	✓	✓	✓	✓	-	-	✓	✓			✓	✓	✓	✓
	7	-	-	✓	✓	✓	✓	✓	✓			✓	✓	✓	✓
	12	✓	✓	✓	✓	-	-	✓	✓			✓	✓	✓	✓
	17	-	-	✓	✓	-	-	✓	✓			✓	✓	✓	✓
Conducted Band Edge	2	✓	✓	✓	✓	✓	✓	✓	✓	✓		✓	✓		✓
	4	✓	✓	✓	✓	✓	✓	✓	✓	✓		✓	✓		✓
	5	✓	✓	✓	✓	-	-	✓	✓	✓		✓	✓		✓
	7	-	-	✓	✓	✓	✓	✓	✓	✓		✓	✓		✓
	12	✓	✓	✓	✓	-	-	✓	✓	✓		✓	✓		✓
	17	-	-	✓	✓	-	-	✓	✓	✓		✓	✓		✓



Test Items	Band	Bandwidth (MHz)						Modulation		RB #			Test Channel		
		1.4	3	5	10	15	20	QPSK	16QAM	1	Half	Full	L	M	H
Conducted Spurious Emission	2	√	√	√	√	√	√	√	√	√			√	√	√
	4	√	√	√	√	√	√	√	√	√			√	√	√
	5	√	√	√	√	-	-	√	√	√			√	√	√
	7	-	-	√	√	√	√	√	√	√			√	√	√
	12	√	√	√	√	-	-	√	√	√			√	√	√
	17	-	-	√	√	-	-	√	√	√			√	√	√
Frequency Stability	2	√			√			√				√		√	
	4	√			√			√				√		√	
	5	√			√	-	-	√				√		√	
	7	-	-	√	√			√				√		√	
	12	√			√	-	-	√				√		√	
	17	-	-	√	√	-	-	√				√		√	
E.R.P./E.I.R.P.	2	√	√	√	√	√	√	√	√	√	√		√	√	√
	4	√	√	√	√	√	√	√	√	√			√	√	√
	5	√	√	√	√	-	-	√	√	√			√	√	√
	7	-	-	√	√	√	√	√	√	√	√		√	√	√
	12	√	√	√	√	√	√	√	√	√			√	√	√
	17	-	-	√	√	-	-	√	√	√			√	√	√
Radiated Spurious Emission	2	√	√	√	√	√	√	√		√			√	√	√
	4	√	√	√	√	√	√	√		√			√	√	√
	5	√	√	√	√	-	-	√		√			√	√	√
	7	-	-	√	√	√	√	√		√			√	√	√
	12	√	√	√	√	-	-	√		√			√	√	√
	17	-	-	√	√	-	-	√		√			√	√	√
Note	<p>1. The mark "√" means that this configuration is chosen for testing</p> <p>2. The mark "-" means that this bandwidth is not supported.</p> <p>3. The device is investigated from 30MHz to 10 times of fundamental signal for radiated spurious emission test under different RB size/offset and modulations in exploratory test. Subsequently, only the worst case emissions are reported.</p>														

2.2 Connection Diagram of Test System

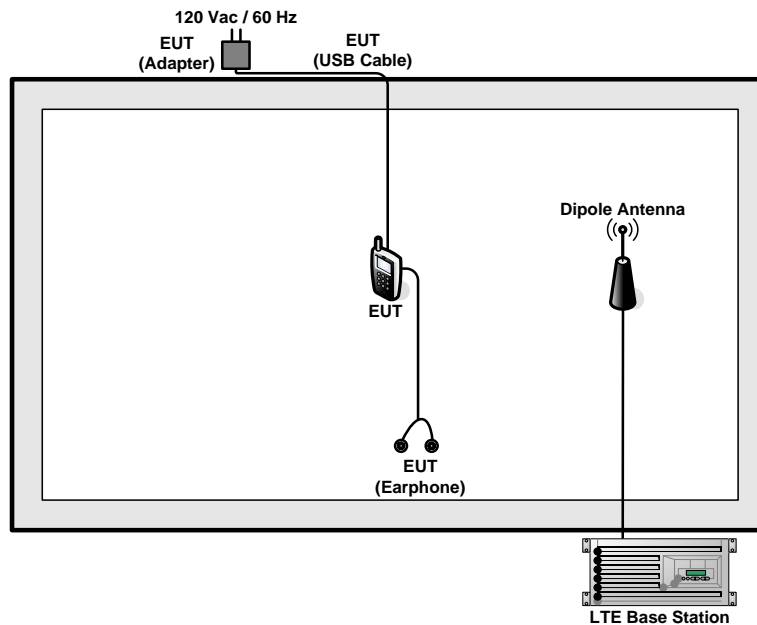

2.3 Support Unit used in test configuration and system

Item	Equipment	Trade Name	Model No.	FCC ID	Data Cable	Power Cord
1.	LTE Base Station	Anritsu	MT8820C	N/A	N/A	Unshielded, 1.8 m

2.4 Measurement Results Explanation Example

For all conducted test items:

The offset level is set in the spectrum analyzer to compensate the RF cable loss and attenuator factor between EUT conducted output port and spectrum analyzer. With the offset compensation, the spectrum analyzer reading level is exactly the EUT RF output level.

The spectrum analyzer offset is derived from RF cable loss and attenuator factor.

Offset = RF cable loss + attenuator factor.

Following shows an offset computation example with cable loss 4.2 dB and 10dB attenuator.

Example :

$$\begin{aligned} \text{Offset(dB)} &= \text{RF cable loss(dB)} + \text{attenuator factor(dB)}. \\ &= 4.2 + 10 = 14.2 \text{ (dB)} \end{aligned}$$

3 Conducted Test Items

3.1 Measuring Instruments

See list of measuring instruments of this test report.

3.2 Test Setup

3.2.1 Conducted Output Power



3.2.2 Peak-to-Average Ratio, Occupied Bandwidth ,Conducted Band-Edge and Conducted Spurious Emission



3.2.3 Frequency Stability

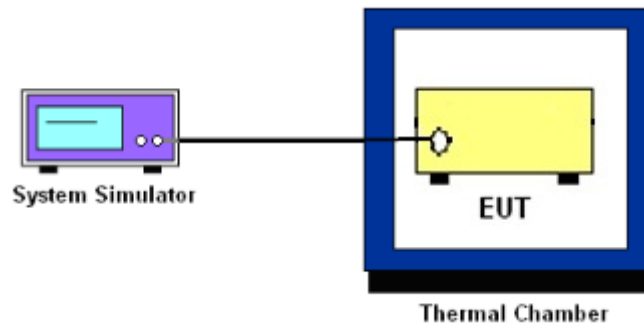

3.3 Test Result of Conducted Test

Please refer to Appendix A.



3.4 Conducted Output Power

3.4.1 Description of the Conducted Output Power Measurement

A system simulator was used to establish communication with the EUT. Its parameters were set to force the EUT transmitting at maximum output power. The measured power in the radio frequency on the transmitter output terminals shall be reported.

3.4.2 Test Procedures

1. The transmitter output port was connected to the system simulator.
2. Set EUT at maximum power through the system simulator.
3. Select lowest, middle, and highest channels for each band and different modulation.
4. Measure and record the power level from the system simulator.



3.5 Peak-to-Average Ratio

3.5.1 Description of the PAR Measurement

Power Complementary Cumulative Distribution Function (CCDF) curves provide a means for characterizing the power peaks of a digitally modulated signal on a statistical basis. A CCDF curve depicts the probability of the peak signal amplitude exceeding the average power level. Most contemporary measurement instrumentation include the capability to produce CCDF curves for an input signal provided that the instrument's resolution bandwidth can be set wide enough to accommodate the entire input signal bandwidth. In measuring transmissions in this band using an average power technique, the peak-to-average ratio (PAR) of the transmission may not exceed 13 dB.

3.5.2 Test Procedures

1. The testing follows FCC KDB 971168 v02r02 Section 5.7.1.
2. The EUT was connected to spectrum and system simulator via a power divider.
3. Set the CCDF (Complementary Cumulative Distribution Function) option in spectrum analyzer.
4. The highest RF powers were measured and recorded the maximum PAPR level associated with a probability of 0.1 %.
5. Record the deviation as Peak to Average Ratio.



3.6 Occupied Bandwidth

3.6.1 Description of Occupied Bandwidth Measurement

The occupied bandwidth is the width of a frequency band such that, below the lower and above the upper frequency limits, the mean powers emitted are each equal to a specified percentage 0.5% of the total mean transmitted power.

The 26 dB emission bandwidth is defined as the frequency range between two points, one above and one below the carrier frequency, at which the spectral density of the emission is attenuated 26 dB below the maximum in-band spectral density of the modulated signal. Spectral density (power per unit bandwidth) is to be measured with a detector of resolution bandwidth equal to approximately 1.0% of the emission bandwidth.

3.6.2 Test Procedures

1. The testing follows FCC KDB 971168 v02r02 Section 4.2.
2. The EUT was connected to spectrum analyzer and system simulator via a power divider.
3. The spectrum analyzer center frequency is set to the nominal EUT channel center frequency. The span range for the spectrum analyzer shall be between two and five times the anticipated OBW.
4. The nominal resolution bandwidth (RBW) shall be in the range of 1 to 5 % of the anticipated OBW, and the VBW shall be at least 3 times the RBW.
5. Set the detection mode to peak, and the trace mode to max hold.
6. Determine the reference value: Set the EUT to transmit a modulated signal. Allow the trace to stabilize. Set the spectrum analyzer marker to the highest level of the displayed trace.
(this is the reference value)
7. Determine the “-26 dB down amplitude” as equal to (Reference Value – X).
8. Place two markers, one at the lowest and the other at the highest frequency of the envelope of the spectral display such that each marker is at or slightly below the “-X dB down amplitude” determined in step 6. If a marker is below this “-X dB down amplitude” value it shall be placed as close as possible to this value. The OBW is the positive frequency difference between the two markers.
9. Use the 99 % power bandwidth function of the spectrum analyzer and report the measured bandwidth.



3.7 Conducted Band Edge

3.7.1 Description of Conducted Band Edge Measurement

22.917(a) for Band 5

For operations in the 824 – 849 MHz band, the FCC limit is $43 + 10\log_{10}(P[\text{Watts}])$ dB below the transmitter power P(Watts) in a 100kHz bandwidth. However, in the 1MHz bands immediately outside and adjacent to the licensee's frequency block, a resolution bandwidth of at least one percent of the emission bandwidth of the fundamental emission of the transmitter may be employed.

24.238 (a) for Band 2

For operations in the 1850-1910 and 1930-1990 MHz band, the FCC limit is $43 + 10\log_{10}(P[\text{Watts}])$ dB below the transmitter power P(Watts) in a 1MHz bandwidth. However, in the 1 MHz bands immediately outside and adjacent to the frequency block a resolution bandwidth of at least one percent of the emission bandwidth of the fundamental emission of the transmitter may be employed.

27.53 (g) for Band 12,17

For operations in the 698 -746 MHz band, the FCC limit is $43 + 10\log_{10}(P[\text{Watts}])$ dB below the transmitter power P(Watts) in a 100 kHz bandwidth. However, in the 100 kilohertz bands immediately outside and adjacent to a licensee's frequency block, a resolution bandwidth of at least 30 kHz may be employed.

27.53 (h) for Band 4

For operations in the 1710 – 1755 MHz band, the FCC limit is $43 + 10\log_{10}(P[\text{Watts}])$ dB below the transmitter power P(Watts) in a 1 MHz bandwidth. However, in the 1MHz bands immediately outside and adjacent to the licensee's frequency block, a resolution bandwidth of at least one percent of the emission bandwidth of the fundamental emission of the transmitter may be employed.



27.53(m)(4) for Band 7

For mobile digital stations, the attenuation factor shall be not less than $40 + 10 \log (P)$ dB on all frequencies between the channel edge and 5 megahertz from the channel edge, $43 + 10 \log (P)$ dB on all frequencies between 5 megahertz and X megahertz from the channel edge, and $55 + 10 \log (P)$ dB on all frequencies more than X megahertz from the channel edge, where X is the greater of 6 megahertz or the actual emission bandwidth as defined in paragraph (m)(6) of this section. In addition, the attenuation factor shall not be less that $43 + 10 \log (P)$ dB on all frequencies between 2490.5 MHz and 2496 MHz and $55 + 10 \log (P)$ dB at or below 2490.5 MHz. Mobile Satellite Service licensees operating on frequencies below 2495 MHz may also submit a documented interference complaint against BRS licensees operating on channel BRS Channel 1 on the same terms and conditions as adjacent channel BRS or EBS licensees.

3.7.2 Test Procedures

1. The testing follows FCC KDB 971168 v02r02 Section 6.0.
2. The EUT was connected to spectrum analyzer and system simulator via a power divider.
3. The band edges of low and high channels for the highest RF powers were measured.
4. Set RBW $\geq 1\%$ EBW in the 1MHz band immediately outside and adjacent to the band edge.
5. Beyond the 1 MHz band from the band edge, RBW=1MHz was used.
6. Set spectrum analyzer with RMS detector.
7. The RF fundamental frequency should be excluded against the limit line in the operating frequency band.
8. Checked that all the results comply with the emission limit line.

Example:

The limit line is derived from $43 + 10\log(P)$ dB below the transmitter power P(Watts)
= $P(W) - [43 + 10\log(P)]$ (dB)
= $[30 + 10\log(P)]$ (dBm) - $[43 + 10\log(P)]$ (dB) = -13dBm.

9. For LTE Band 7, the other 40 dB, and 55 dB have additionally applied same calculation above.



3.8 Conducted Spurious Emission

3.8.1 Description of Conducted Spurious Emission Measurement

The power of any emission outside of the authorized operating frequency ranges must be lower than the transmitter power (P) by a factor of at least $43 + 10 \log (P)$ dB.

For Band 7:

The power of any emission outside of the authorized operating frequency ranges must be lower than the transmitter power (P) by a factor of at least $55 + 10 \log (P)$ dB.

It is measured by means of a calibrated spectrum analyzer and scanned from 30 MHz up to a frequency including its 10th harmonic.

3.8.2 Test Procedures

1. The testing follows FCC KDB 971168 v02r02 Section 6.0.
2. The EUT was connected to spectrum analyzer and system simulator via a power divider.
3. The RF output of EUT was connected to the spectrum analyzer by RF cable and attenuator. The path loss was compensated to the results for each measurement.
4. The middle channel for the highest RF power within the transmitting frequency was measured.
5. The conducted spurious emission for the whole frequency range was taken.
6. Make the measurement with the spectrum analyzer's RBW = 1MHz, VBW = 3MHz.
7. Set spectrum analyzer with RMS detector.
8. Taking the record of maximum spurious emission.
9. The RF fundamental frequency should be excluded against the limit line in the operating frequency band.
10. The limit line is derived from $43 + 10\log(P)$ dB below the transmitter power P(Watts)
 $= P(W) - [43 + 10\log(P)]$ (dB)
 $= [30 + 10\log(P)]$ (dBm) - $[43 + 10\log(P)]$ (dB)
 $= -13$ dBm.
11. For Band 7
The limit line is derived from $55 + 10\log(P)$ dB below the transmitter power P(Watts)
 $= P(W) - [55 + 10\log(P)]$ (dB)
 $= [30 + 10\log(P)]$ (dBm) - $[55 + 10\log(P)]$ (dB)
 $= -25$ dBm.



3.9 Frequency Stability

3.9.1 Description of Frequency Stability Measurement

The frequency stability shall be measured by variation of ambient temperature and variation of primary supply voltage to ensure that the fundamental emission stays within the authorized frequency block. The frequency stability of the transmitter shall be maintained within $\pm 0.00025\%$ ($\pm 2.5\text{ppm}$) of the center frequency.

3.9.2 Test Procedures for Temperature Variation

1. The testing follows FCC KDB 971168 v02r02 Section 9.0.
2. The EUT was set up in the thermal chamber and connected with the system simulator.
3. With power OFF, the temperature was decreased to -30°C and the EUT was stabilized before testing. Power was applied and the maximum change in frequency was recorded within one minute.
4. With power OFF, the temperature was raised in 10°C step up to 50°C . The EUT was stabilized at each step for at least half an hour. Power was applied and the maximum frequency change was recorded within one minute.

3.9.3 Test Procedures for Voltage Variation

1. The testing follows FCC KDB 971168 v02r02 Section 9.0.
2. The EUT was placed in a temperature chamber at $25\pm 5^{\circ}\text{C}$ and connected with the system simulator.
3. The power supply voltage to the EUT was varied from 85% to 115% of the nominal value measured at the input to the EUT.
4. The variation in frequency was measured for the worst case.

4 Radiated Test Items

4.1 Measuring Instruments

See list of measuring instruments of this test report.

4.2 Test Setup

4.2.1 For radiated test from 30MHz to 1GHz

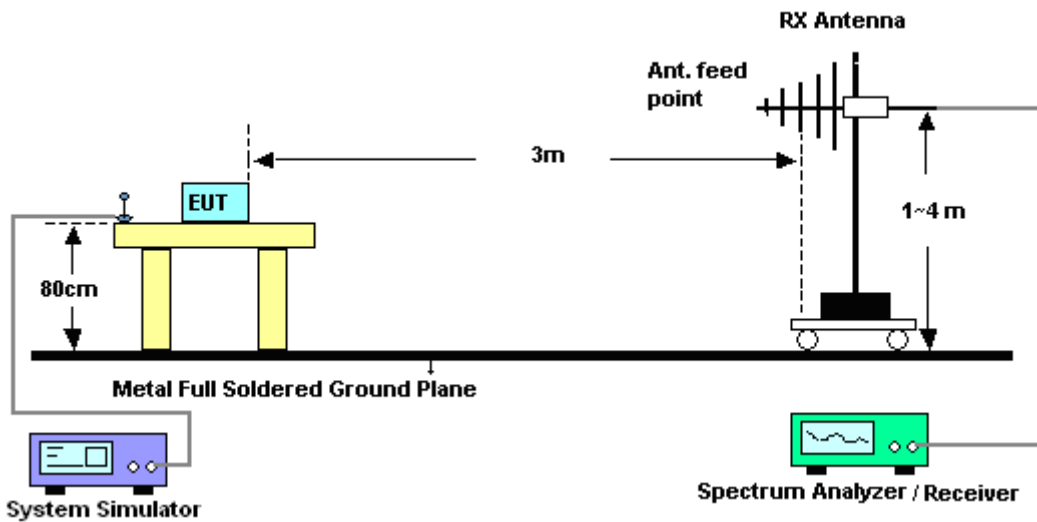

4.2.2 For radiated test above 1GHz

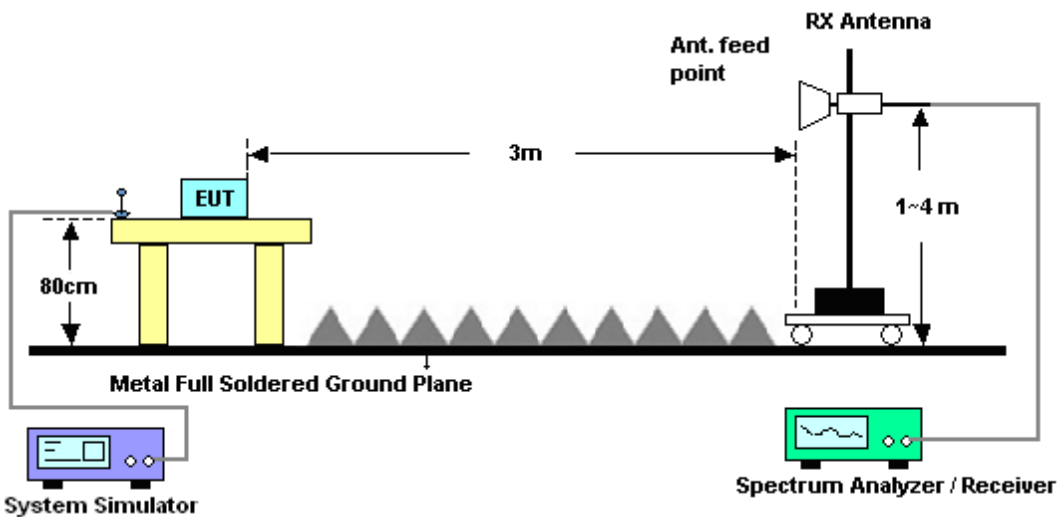

4.3 Test Result of Radiated Test

Please refer to Appendix B.



4.4 Effective Radiated Power and Effective Isotropic Radiated Power

4.4.1 Description of the ERP/EIRP Measurement

Effective radiated power output measurements by substitution method according to ANSI / TIA / EIA-603-C-2004, and the spectrum analyzer configuration follows KDB 971168 D01 Power Meas. License Digital Systems v02r02. Mobile and portable (hand-held) stations operating are limited to average ERP of 7 watts with LTE band 5 and 3 watts with LTE band 12 / 17.

Equivalent isotropic radiated power output measurements by substitution method according to ANSI / TIA / EIA-603-C-2004, and the spectrum analyzer configuration follows KDB 971168 D01 Power Meas. License Digital Systems v02r02. Mobile and portable (hand-held) stations operating are limited to average EIRP of 2 watts with LTE band 2 / 7 and 1 watt with LTE band 4.

4.4.2 Test Procedures

1. The EUT was placed on a non-conductive rotating platform 0.8 meters high in a semi-anechoic chamber. The radiated emission at the fundamental frequency was measured at 3 m with a test antenna and a spectrum analyzer with RMS detector per section 5. of KDB 971168 D01.
2. During the measurement, the system simulator parameters were set to force the EUT transmitting at maximum output power. The maximum emission was recorded from analyzer power level (LVL) from the 360 degrees rotation of the turntable and the test antenna raised and lowered over a range from 1 to 4 meters in both horizontally and vertically polarized orientations.
3. Effective Isotropic Radiated Power (EIRP) was measured by substitution method according to TIA/EIA-603-C. The EUT was replaced by the substitution antenna at same location, and then a known power from S.G. was applied into the dipole antenna through a Tx cable, and then recorded the maximum Analyzer reading through raised and lowered the test antenna. The correction factor (in dB) = S.G. - Tx Cable loss + Substitution antenna gain - Analyzer reading. Then the EUT's EIRP was calculated with the correction factor, $EIRP = LVL + \text{Correction factor}$ and $ERP = EIRP - 2.15$. Take the record of the output power at substitution antenna.



	LTE Average					
LTE BW	1.4M	3M	5M	10M	15M	20M
Span	3MHz	6MHz	10MHz	20MHz	30MHz	40MHz
RBW	30kHz	100kHz	100kHz	300kHz	300kHz	300kHz
VBW	100kHz	300kHz	300kHz	1MHz	1MHz	1MHz
Detector	RMS	RMS	RMS	RMS	RMS	RMS
Trace	Average	Average	Average	Average	Average	Average
Average Type	Power	Power	Power	Power	Power	Power
Sweep Count	100	100	100	100	100	100

	LTE Peak					
LTE BW	1.4M	3M	5M	10M	15M	20M
Span	3MHz	6MHz	10MHz	20MHz	30MHz	40MHz
RBW	30kHz	100kHz	100kHz	300kHz	300kHz	300kHz
VBW	100kHz	300kHz	300kHz	1MHz	1MHz	1MHz
Detector	Peak	Peak	Peak	Peak	Peak	Peak
Trace	Max Hold	Max Hold	Max Hold	Max Hold	Max Hold	Max Hold
Power	Channel	Channel	Channel	Channel	Channel	Channel



4.5 Radiated Spurious Emission

4.5.1 Description of Radiated Spurious Emission

The radiated spurious emission was measured by substitution method according to ANSI / TIA / EIA-603-C-2004. The power of any emission outside of the authorized operating frequency ranges must be attenuated below the transmitter power (P) by a factor of at least $43 + 10 \log (P)$ dB.

For Band 7

The power of any emission outside of the authorized operating frequency ranges must be attenuated below the transmitter power (P) by a factor of at least $55 + 10 \log (P)$ dB.

For LTE Band 12,17

For operations in the 746-758 MHz, 775-788 MHz, and 805-806 MHz bands, emissions in the band 1559-1610 MHz shall be limited to -70 dBW/MHz equivalent isotropically radiated power (EIRP) for wideband signals, and -80 dBW EIRP for discrete emissions of less than 700 Hz bandwidth.

The spectrum is scanned from 30 MHz up to a frequency including its 10th harmonic.



4.5.2 Test Procedures

1. The testing follows FCC KDB 971168 v02r02 Section 5.8 and ANSI / TIA-603-C-2004 Section 2.2.12.
2. The EUT was placed on a rotatable wooden table with 0.8 meter above ground.
3. The EUT was set 3 meters from the receiving antenna, which was mounted on the antenna tower.
4. The table was rotated 360 degrees to determine the position of the highest spurious emission.
5. The height of the receiving antenna is varied between one meter and four meters to search the maximum spurious emission for both horizontal and vertical polarizations.
6. Make the measurement with the spectrum analyzer's RBW = 1MHz, VBW = 3MHz, taking the record of maximum spurious emission.
7. A horn antenna was substituted in place of the EUT and was driven by a signal generator.
8. Tune the output power of signal generator to the same emission level with EUT maximum spurious emission.
9. Taking the record of output power at antenna port.
10. Repeat step 7 to step 8 for another polarization.
11. The RF fundamental frequency should be excluded against the limit line in the operating frequency band.

The limit line is derived from $43 + 10\log(P)$ dB below the transmitter power P(Watts)
= P(W)- [43 + 10log(P)] (dB)
= [30 + 10log(P)] (dBm) - [43 + 10log(P)] (dB)
= -13dBm.

For Band 7:

The limit line is derived from $55 + 10\log(P)$ dB below the transmitter power P(Watts)

12. EIRP (dBm) = S.G. Power – Tx Cable Loss + Tx Antenna Gain
13. ERP (dBm) = EIRP - 2.15



5 List of Measuring Equipment

Instrument	Manufacturer	Model No.	Serial No.	Characteristics	Calibration Date	Test Date	Due Date	Remark
LTE Base Station	Anritsu	MT8820C	6201432821	GSM/GPRS /WCDMA/LTE	Oct. 27, 2014	Aug. 09, 2015~ Aug. 10, 2015	Oct. 26, 2015	Conducted (TH05-HY)
Spectrum Analyzer	Rohde & Schwarz	FSV40	101397	10Hz~40GHz	Sep. 17, 2014	Aug. 09, 2015~ Aug. 10, 2015	Sep. 16 2015	Conducted (TH05-HY)
Temperature Chamber	ESPEC	SH-641	92013720	-30°~70°	Dec. 04, 2014	Aug. 09, 2015~ Aug. 10, 2015	Dec. 03, 2015	Conducted (TH05-HY)
Hygrometer	Testo	608-H1	34897199	N/A	May 04, 2015	Aug. 09, 2015~ Aug. 10, 2015	May 03, 2016	Conducted (TH05-HY)
RF cable	WOKEN	S05	S05-130708-038	N/A	Jan. 21, 2015	Aug. 09, 2015~ Aug. 10, 2015	Jan. 20, 2016	Conducted (TH05-HY)
Bilog Antenna	Schaffner	CBL6111C	2726	30MHz ~ 1GHz	Sep. 27, 2014	Aug. 13, 2015 ~ Sep. 01, 2015	Sep. 26, 2015	Radiation (03CH07-HY)
Double Ridge Horn Antenna	EMCO	3117	00066583	1GHz~18GHz	Jul. 20, 2015	Aug. 13, 2015 ~ Sep. 01, 2015	Jul. 19, 2016	Radiation (03CH07-HY)
EMI Test Receiver	Rohde & Schwarz	ESCI 7	100724	9kHz~7GHz	Aug. 30, 2014	Aug. 13, 2015~ Aug. 24, 2015	Aug. 29, 2015	Radiation (03CH07-HY)
EMI Test Receiver	Rohde & Schwarz	ESCI 7	100724	9kHz~7GHz	Aug. 25, 2015	Aug. 25, 2015 ~ Sep. 01, 2015	Aug. 24, 2016	Radiation (03CH07-HY)
Horn Antenna	SCHWARZBECK	BBHA 9120D	9120D-1328	1GHz ~ 18GHz	Nov. 05, 2014	Aug. 13, 2015 ~ Sep. 01, 2015	Nov. 04, 2015	Radiation (03CH07-HY)
Hygrometer	Testo	608-H1	34897197	N/A	May 06, 2014	Aug. 13, 2015 ~ Sep. 01, 2015	May 03, 2016	Radiation (03CH07-HY)
Preamplifier	COM-POWER	PA-103A	161241	10MHz-1000MHz	Mar. 12, 2015	Aug. 13, 2015 ~ Sep. 01, 2015	Mar. 11, 2016	Radiation (03CH07-HY)
Preamplifier	Agilent	8449B	3008A02362	1GHz~ 26.5GHz	Oct. 21, 2014	Aug. 13, 2015 ~ Sep. 01, 2015	Oct. 20, 2015	Radiation (03CH07-HY)
Signal Analyzer	Rohde & Schwarz	FSV 30	101749	10Hz~30GHz	Mar. 10, 2015	Aug. 13, 2015 ~ Sep. 01, 2015	Mar. 09, 2016	Radiation (03CH07-HY)
Controller	ChainTek	Chaintek 3000	N/A	Control Turn table	N/A	Aug. 13, 2015 ~ Sep. 01, 2015	N/A	Radiation (03CH07-HY)
Controller	Max-Full	MF7802	MF780208368	Control Ant Mast	N/A	Aug. 13, 2015 ~ Sep. 01, 2015	N/A	Radiation (03CH07-HY)
Antenna Mast	Max-Full	MFA520BS	N/A	1m~4m	N/A	Aug. 13, 2015 ~ Sep. 01, 2015	N/A	Radiation (03CH07-HY)
Turn Table	ChainTek	Chaintek 3000	N/A	0~360 degree	N/A	Aug. 13, 2015 ~ Sep. 01, 2015	N/A	Radiation (03CH07-HY)
RF Cable	HUBER + SUHNER	SUCOFLEX 104	MY84209521	1GHz~40GHz	Dec. 04, 2014	Aug. 13, 2015 ~ Sep. 01, 2015	Dec. 03, 2015	Radiation (03CH07-HY)
RF Cable	HUBER + SUHNER	SUCOFLEX 104	MY84209521	9KHz~1GHz	Dec. 04, 2014	Aug. 13, 2015 ~ Sep. 01, 2015	Dec. 03, 2015	Radiation (03CH07-HY)
Test software	Audix	E3	6.2009-8-24	N/A	N/A	Aug. 13, 2015 ~ Sep. 01, 2015	N/A	Radiation (03CH07-HY)



Instrument	Manufacturer	Model No.	Serial No.	Characteristics	Calibration Date	Test Date	Due Date	Remark
Filter	Wainwright	WLKS1200-8SS	SN3	1.2G Low Pass	Oct. 01, 2014	Aug. 13, 2015 ~ Sep. 01, 2015	Sep. 30, 2015	Radiation (03CH07-HY)
Filter	Wainwright	WHK1.5/15 G-10SS	SN32	1.5G High Pass	Oct. 01, 2014	Aug. 13, 2015 ~ Sep. 01, 2015	Sep. 30, 2015	Radiation (03CH07-HY)
Filter	Microwave	H3G018G1	SN477220	3.0G High Pass	Oct. 01, 2014	Aug. 13, 2015 ~ Sep. 01, 2015	Sep. 30, 2015	Radiation (03CH07-HY)
Notch Filter	Wainwright	WRCG824/849-40/8SS	SN35	CDMA 850	Oct. 01, 2014	Aug. 13, 2015 ~ Sep. 01, 2015	Sep. 30, 2015	Radiation (03CH07-HY)
Notch Filter	Wainwright	WRCG1710/1755-1690/1	SN2	AWS Band	Oct. 01, 2014	Aug. 13, 2015 ~ Sep. 01, 2015	Sep. 30, 2015	Radiation (03CH07-HY)
Notch Filter	Wainwright	WRCT1850/1910-40/8S	SN21	1900	Oct. 01, 2014	Aug. 13, 2015 ~ Sep. 01, 2015	Sep. 30, 2015	Radiation (03CH07-HY)
Notch Filter	Wainwright	WRCT2500/2570-10/40-	SN1 R	LTE Band7	Oct. 01, 2014	Aug. 13, 2015 ~ Sep. 01, 2015	Sep. 30, 2015	Radiation (03CH07-HY)
Notch Filter	Wainwright	WRCT698/798-10/40-8S	SN1	700	Oct. 01, 2014	Aug. 13, 2015 ~ Sep. 01, 2015	Sep. 30, 2015	Radiation (03CH07-HY)



6 Uncertainty of Evaluation

Uncertainty of Radiated Emission Measurement (30 MHz ~ 1000 MHz)

Measuring Uncertainty for a Level of Confidence of 95% ($U = 2Uc(y)$)	2.54
---	------

Uncertainty of Radiated Emission Measurement (1 GHz ~ 40 GHz)

Measuring Uncertainty for a Level of Confidence of 95% ($U = 2Uc(y)$)	4.72
---	------



Appendix A. Test Results of Conducted Test

Conducted Output Power(Average power)

LTE Band 2 Maximum Average Power [dBm]						
BW [MHz]	RB Size	RB Offset	Mod	Lowest	Middle	Highest
1.4	1	0	QPSK	19.51	19.79	19.80
1.4	1	2		19.64	19.84	19.82
1.4	1	5		19.61	19.71	19.82
1.4	3	0		19.46	19.62	19.68
1.4	3	1		19.59	19.71	19.77
1.4	3	2		19.51	19.71	19.80
1.4	6	0		19.48	19.65	19.68
1.4	1	0	16-QAM	19.53	20.07	20.07
1.4	1	2		19.52	20.00	20.05
1.4	1	5		19.93	20.08	20.09
1.4	3	0		19.62	19.73	19.74
1.4	3	1		19.58	19.69	19.75
1.4	3	2		19.66	19.77	19.79
1.4	6	0		19.57	19.69	19.77
3	1	0	QPSK	19.42	19.77	19.69
3	1	7		19.74	19.96	19.84
3	1	14		19.46	19.78	19.64
3	8	0		19.51	19.73	19.70
3	8	4		19.52	19.73	19.76
3	8	7		19.50	19.69	19.74
3	15	0		19.52	19.69	19.71
3	1	0	16-QAM	19.70	20.01	19.93
3	1	7		20.01	20.11	20.07
3	1	14		19.73	20.05	19.92
3	8	0		19.57	19.79	19.69
3	8	4		19.59	19.78	19.69
3	8	7		19.56	19.75	19.70
3	15	0		19.49	19.68	19.64



LTE Band 2 Maximum Average Power [dBm]						
BW [MHz]	RB Size	RB Offset	Mod	Lowest	Middle	Highest
5	1	0	QPSK	19.57	19.67	19.70
5	1	12		19.60	19.62	19.62
5	1	24		19.52	19.66	19.67
5	12	0		19.49	19.68	19.65
5	12	6		19.60	19.68	19.69
5	12	11		19.54	19.61	19.66
5	25	0		19.57	19.62	19.67
5	1	0	16-QAM	19.82	19.93	19.96
5	1	12		20.00	20.07	20.04
5	1	24		19.86	19.98	19.97
5	12	0		19.53	19.66	19.64
5	12	6		19.57	19.65	19.68
5	12	11		19.51	19.60	19.65
5	25	0		19.59	19.66	19.66
10	1	0	QPSK	19.93	19.93	19.73
10	1	24		19.87	19.68	19.68
10	1	49		19.86	19.65	19.68
10	25	0		19.63	19.66	19.71
10	25	12		19.62	19.66	19.63
10	25	24		19.45	19.71	19.73
10	50	0		19.49	19.64	19.70
10	1	0	16-QAM	20.04	20.05	20.11
10	1	24		20.02	20.03	20.07
10	1	49		19.98	19.95	20.00
10	25	0		19.96	19.66	19.71
10	25	12		19.59	19.68	19.61
10	25	24		19.48	19.70	19.69
10	50	0		19.52	19.66	19.69



LTE Band 2 Maximum Average Power [dBm]						
BW [MHz]	RB Size	RB Offset	Mod	Lowest	Middle	Highest
15	1	0	QPSK	19.87	19.95	19.66
15	1	37		19.75	19.57	19.29
15	1	74		19.82	19.74	19.53
15	36	0		19.96	19.82	19.53
15	36	18		19.85	19.83	19.54
15	36	37		19.83	19.81	19.50
15	75	0		19.80	19.82	19.52
15	1	0	16-QAM	20.08	20.02	19.92
15	1	37		20.08	19.98	19.76
15	1	74		20.03	20.02	19.82
15	36	0		19.92	19.84	19.51
15	36	18		19.85	19.82	19.53
15	36	37		19.81	19.80	19.52
15	75	0		19.86	19.80	19.56
20	1	0	QPSK	19.60	20.00	19.74
20	1	49		19.26	19.66	19.40
20	1	99		19.25	19.69	19.44
20	50	0		19.88	19.84	19.54
20	50	24		19.82	19.75	19.53
20	50	49		19.80	19.76	19.51
20	100	0		19.83	19.78	19.53
20	1	0	16-QAM	20.00	20.15	19.87
20	1	49		19.84	19.93	19.71
20	1	99		19.83	19.95	19.72
20	50	0		19.80	19.83	19.53
20	50	24		19.82	19.77	19.54
20	50	49		19.79	19.75	19.48
20	100	0		19.85	19.80	19.50



LTE Band 4 Maximum Average Power [dBm]						
BW [MHz]	RB Size	RB Offset	Mod	Lowest	Middle	Highest
1.4	1	0	QPSK	21.47	21.56	21.67
1.4	1	2		21.59	21.63	21.73
1.4	1	5		21.58	21.66	21.65
1.4	3	0		21.46	21.51	21.50
1.4	3	1		21.55	21.57	21.64
1.4	3	2		21.54	21.68	21.64
1.4	6	0		21.47	21.52	21.58
1.4	1	0	16-QAM	21.88	21.89	21.98
1.4	1	2		21.87	21.95	22.01
1.4	1	5		21.92	21.95	21.99
1.4	3	0		21.55	21.61	21.62
1.4	3	1		21.55	21.63	21.69
1.4	3	2		21.55	21.88	21.72
1.4	6	0		21.03	21.11	21.18
3	1	0	QPSK	21.56	21.66	21.60
3	1	7		21.81	21.63	21.60
3	1	14		21.51	21.59	21.61
3	8	0		21.55	21.62	21.56
3	8	4		21.48	21.73	21.65
3	8	7		21.46	21.67	21.65
3	15	0		21.46	21.68	21.66
3	1	0	16-QAM	21.76	21.79	21.78
3	1	7		21.84	22.11	22.24
3	1	14		21.68	21.98	21.94
3	8	0		21.23	21.22	21.19
3	8	4		21.16	21.32	21.24
3	8	7		21.15	21.25	21.28
3	15	0		21.13	21.19	21.22



LTE Band 4 Maximum Average Power [dBm]						
BW [MHz]	RB Size	RB Offset	Mod	Lowest	Middle	Highest
5	1	0	QPSK	21.63	21.72	21.67
5	1	12		21.47	21.70	21.58
5	1	24		21.60	21.61	21.67
5	12	0		21.56	21.60	21.56
5	12	6		21.51	21.61	21.67
5	12	11		21.49	21.64	21.60
5	25	0		21.46	21.70	21.63
5	1	0	16-QAM	21.90	22.12	21.95
5	1	12		21.90	22.16	22.23
5	1	24		21.93	22.03	22.02
5	12	0		21.07	21.18	21.11
5	12	6		21.01	21.12	21.14
5	12	11		20.98	21.18	21.11
5	25	0		20.99	21.20	21.16
10	1	0	QPSK	21.69	21.85	21.79
10	1	24		21.69	21.74	21.77
10	1	49		21.58	21.60	21.61
10	25	0		21.53	21.68	21.58
10	25	12		21.62	21.60	21.65
10	25	24		21.54	21.61	21.55
10	50	0		21.58	21.58	21.61
10	1	0	16-QAM	22.05	21.84	22.09
10	1	24		21.90	21.82	22.03
10	1	49		21.85	21.81	21.91
10	25	0		21.01	21.18	21.28
10	25	12		21.12	21.21	21.18
10	25	24		21.06	21.16	21.16
10	50	0		21.08	21.16	21.09



LTE Band 4 Maximum Average Power [dBm]						
BW [MHz]	RB Size	RB Offset	Mod	Lowest	Middle	Highest
15	1	0	QPSK	21.68	21.71	21.71
15	1	37		21.53	21.71	21.56
15	1	74		21.52	21.49	21.56
15	36	0		21.57	21.68	21.68
15	36	18		21.63	21.63	21.70
15	36	37		21.62	21.58	21.57
15	75	0		21.58	21.70	21.64
15	1	0	16-QAM	21.95	22.01	21.98
15	1	37		21.86	22.15	21.95
15	1	74		21.84	21.77	21.83
15	36	0		21.06	21.18	21.18
15	36	18		21.14	21.15	21.20
15	36	37		21.10	21.08	21.06
15	75	0		21.09	21.22	21.17
20	1	0	QPSK	21.81	21.86	21.89
20	1	49		21.51	21.57	21.58
20	1	99		21.56	21.50	21.52
20	50	0		21.62	21.75	21.75
20	50	24		21.59	21.63	21.61
20	50	49		21.61	21.69	21.59
20	100	0		21.57	21.67	21.63
20	1	0	16-QAM	22.15	22.21	22.25
20	1	49		21.76	21.82	21.83
20	1	99		21.83	21.78	21.77
20	50	0		21.29	21.25	21.24
20	50	24		21.23	21.21	21.21
20	50	49		21.19	21.19	21.20
20	100	0		21.16	21.22	21.20



LTE Band 5 Maximum Average Power [dBm]						
BW [MHz]	RB Size	RB Offset	Mod	Lowest	Middle	Highest
1.4	1	0	QPSK	22.96	23.04	22.91
1.4	1	2		22.93	22.99	22.91
1.4	1	5		22.90	22.98	22.86
1.4	3	0		22.79	22.93	22.73
1.4	3	1		22.85	22.91	22.82
1.4	3	2		22.86	22.92	22.82
1.4	6	0		21.77	21.83	21.73
1.4	1	0	16-QAM	22.23	22.34	22.19
1.4	1	2		22.15	22.22	22.04
1.4	1	5		22.22	22.30	22.19
1.4	3	0		21.83	22.02	21.81
1.4	3	1		21.82	21.88	21.75
1.4	3	2		21.90	21.91	21.84
1.4	6	0		20.78	20.85	20.75
3	1	0	QPSK	22.83	22.93	22.85
3	1	7		23.09	23.11	22.91
3	1	14		22.83	22.86	22.75
3	8	0		21.79	21.91	21.78
3	8	4		21.82	21.85	21.72
3	8	7		21.77	21.81	21.75
3	15	0		21.79	21.82	21.81
3	1	0	16-QAM	22.05	22.14	22.03
3	1	7		22.32	22.44	22.30
3	1	14		22.07	22.15	21.98
3	8	0		20.79	20.89	20.79
3	8	4		20.81	20.83	20.71
3	8	7		20.79	20.83	20.74
3	15	0		20.74	20.77	20.77



LTE Band 5 Maximum Average Power [dBm]						
BW [MHz]	RB Size	RB Offset	Mod	Lowest	Middle	Highest
5	1	0	QPSK	22.84	22.94	22.82
5	1	12		22.82	22.86	22.75
5	1	24		22.80	22.87	22.73
5	12	0		21.75	21.88	21.70
5	12	6		21.81	21.85	21.78
5	12	11		21.80	21.81	21.73
5	25	0		21.77	21.80	21.74
5	1	0	16-QAM	22.05	22.19	22.05
5	1	12		22.27	22.37	22.29
5	1	24		22.11	22.17	22.03
5	12	0		20.70	20.81	20.67
5	12	6		20.75	20.75	20.73
5	12	11		20.71	20.73	20.69
5	25	0		20.74	20.79	20.73
10	1	0	QPSK	23.02	23.13	23.00
10	1	24		22.92	22.98	22.95
10	1	49		22.84	22.90	22.73
10	25	0		21.79	21.92	21.80
10	25	12		21.84	21.83	21.78
10	25	24		21.80	21.85	21.70
10	50	0		21.76	21.86	21.75
10	1	0	16-QAM	22.16	22.28	22.20
10	1	24		22.21	22.18	22.19
10	1	49		22.10	22.18	22.07
10	25	0		20.75	20.88	20.76
10	25	12		20.80	20.79	20.75
10	25	24		20.78	20.82	20.68
10	50	0		20.73	20.80	20.73



LTE Band 7 Maximum Average Power [dBm]						
BW [MHz]	RB Size	RB Offset	Mod	Lowest	Middle	Highest
5	1	0	QPSK	19.35	19.34	19.39
5	1	12		19.23	19.15	19.33
5	1	24		19.28	19.30	19.38
5	12	0		19.31	19.29	19.35
5	12	6		19.25	19.31	19.40
5	12	11		19.27	19.28	19.37
5	25	0		19.30	19.27	19.34
5	1	0	16-QAM	19.62	19.64	19.67
5	1	12		19.69	19.58	19.79
5	1	24		19.56	19.56	19.76
5	12	0		19.47	19.46	19.54
5	12	6		19.42	19.43	19.59
5	12	11		19.45	19.45	19.57
5	25	0		19.47	19.39	19.54
10	1	0	QPSK	19.33	19.31	19.48
10	1	24		19.34	19.29	19.40
10	1	49		19.33	19.29	19.41
10	25	0		19.32	19.31	19.47
10	25	12		19.27	19.28	19.38
10	25	24		19.34	19.30	19.36
10	50	0		19.29	19.21	19.43
10	1	0	16-QAM	19.61	19.69	19.80
10	1	24		19.66	19.61	19.82
10	1	49		19.57	19.77	19.83
10	25	0		19.48	19.44	19.63
10	25	12		19.42	19.42	19.52
10	25	24		19.51	19.46	19.55
10	50	0		19.46	19.37	19.60



LTE Band 7 Maximum Average Power [dBm]						
BW [MHz]	RB Size	RB Offset	Mod	Lowest	Middle	Highest
15	1	0	QPSK	19.18	19.31	19.47
15	1	37		19.13	19.31	19.56
15	1	74		19.28	19.14	19.36
15	36	0		19.24	19.36	19.55
15	36	18		19.30	19.33	19.53
15	36	37		19.31	19.24	19.37
15	75	0		19.25	19.32	19.42
15	1	0	16-QAM	19.56	19.69	19.85
15	1	37		19.52	19.49	19.78
15	1	74		19.66	19.42	19.69
15	36	0		19.37	19.31	19.51
15	36	18		19.42	19.45	19.63
15	36	37		19.28	19.38	19.54
15	75	0		19.37	19.43	19.54
20	1	0	QPSK	19.39	19.43	19.58
20	1	49		19.26	19.27	19.40
20	1	99		19.34	19.22	19.41
20	50	0		19.30	19.42	19.49
20	50	24		19.37	19.30	19.53
20	50	49		19.48	19.25	19.48
20	100	0		19.40	19.34	19.55
20	1	0	16-QAM	19.70	19.75	19.86
20	1	49		19.60	19.59	19.69
20	1	99		19.79	19.52	19.73
20	50	0		19.43	19.34	19.44
20	50	24		19.33	19.44	19.48
20	50	49		19.41	19.40	19.64
20	100	0		19.37	19.42	19.65



LTE Band 12 Maximum Average Power [dBm]						
BW [MHz]	RB Size	RB Offset	Mod	Lowest	Middle	Highest
1.4	1	0	QPSK	22.85	23.05	23.25
1.4	1	2		22.89	23.12	23.20
1.4	1	5		22.77	23.08	23.14
1.4	3	0		22.71	22.92	23.06
1.4	3	1		22.78	23.00	23.10
1.4	3	2		22.79	23.00	23.10
1.4	6	0		21.64	21.90	22.00
1.4	1	0	16-QAM	22.06	22.31	22.50
1.4	1	2		22.09	22.30	22.45
1.4	1	5		22.10	22.38	22.45
1.4	3	0		21.75	21.97	22.09
1.4	3	1		21.81	21.99	22.12
1.4	3	2		21.83	22.01	22.17
1.4	6	0		20.77	20.99	21.07
3	1	0	QPSK	22.86	23.02	23.14
3	1	7		23.11	23.27	23.13
3	1	14		22.92	23.07	23.12
3	8	0		21.76	21.90	22.15
3	8	4		21.83	21.98	22.11
3	8	7		21.82	21.97	22.12
3	15	0		21.76	21.94	22.15
3	1	0	16-QAM	21.97	22.14	22.32
3	1	7		22.12	22.43	22.52
3	1	14		22.12	22.26	22.33
3	8	0		20.83	20.96	21.18
3	8	4		20.87	21.02	21.12
3	8	7		20.88	21.02	21.13
3	15	0		20.76	20.93	21.11



LTE Band 12 Maximum Average Power [dBm]						
BW [MHz]	RB Size	RB Offset	Mod	Lowest	Middle	Highest
5	1	0	QPSK	22.79	23.05	23.15
5	1	12		22.90	22.97	23.16
5	1	24		22.92	23.01	23.14
5	12	0		21.71	21.93	22.01
5	12	6		21.86	21.98	22.17
5	12	11		21.89	21.96	22.12
5	25	0		21.81	21.97	22.12
5	1	0	16-QAM	22.06	22.26	22.37
5	1	12		22.20	22.46	22.49
5	1	24		22.21	22.30	22.43
5	12	0		20.79	20.92	21.09
5	12	6		20.85	20.95	21.18
5	12	11		20.90	20.94	21.11
5	25	0		20.84	20.95	21.10
10	1	0	QPSK	23.08	23.29	23.25
10	1	24		22.97	23.11	23.05
10	1	49		22.94	23.09	23.07
10	25	0		21.83	21.90	21.99
10	25	12		21.91	22.03	21.94
10	25	24		21.86	21.91	21.98
10	50	0		21.82	22.01	21.91
10	1	0	16-QAM	22.18	22.39	22.35
10	1	24		22.23	22.29	22.25
10	1	49		22.23	22.38	22.43
10	25	0		20.85	20.92	20.97
10	25	12		20.90	21.00	20.93
10	25	24		20.88	20.93	20.98
10	50	0		20.78	20.96	20.92



LTE Band 17 Maximum Average Power [dBm]						
BW [MHz]	RB Size	RB Offset	Mod	Lowest	Middle	Highest
5	1	0	QPSK	22.81	22.95	22.97
5	1	12		22.88	22.90	22.91
5	1	24		22.89	23.02	23.02
5	12	0		21.79	21.85	21.91
5	12	6		21.93	21.93	22.08
5	12	11		21.83	21.88	22.00
5	25	0		21.86	21.96	21.96
5	1	0	16-QAM	22.03	22.16	22.18
5	1	12		22.36	22.32	22.29
5	1	24		22.17	22.34	22.38
5	12	0		20.73	20.84	20.94
5	12	6		20.81	20.93	21.04
5	12	11		20.74	20.82	20.93
5	25	0		20.84	20.91	20.88
10	1	0	QPSK	22.91	23.08	23.10
10	1	24		22.86	23.00	23.08
10	1	49		22.90	23.05	23.08
10	25	0		21.88	21.93	21.89
10	25	12		21.91	22.00	21.99
10	25	24		21.88	22.00	22.02
10	50	0		21.83	21.96	21.98
10	1	0	16-QAM	22.15	22.25	22.31
10	1	24		22.14	22.30	22.31
10	1	49		22.25	22.38	22.36
10	25	0		20.86	20.92	20.83
10	25	12		20.91	20.97	20.96
10	25	24		20.88	20.98	20.97
10	50	0		20.79	20.94	20.97



LTE Band 2

Peak-to-Average Ratio

Mode	LTE Band 2 / 20MHz				
Mod.	QPSK		16QAM		Limit: 13dB
RB Size	1RB	Full RB	1RB	Full RB	Result
Lowest CH	4.7	5.01	5.54	5.94	PASS
Middle CH	4.52	5.01	5.57	6.14	
Highest CH	4.64	5.1	5.42	6.06	



LTE Band 2 / 20MHz / QPSK

Lowest Channel / 1RB

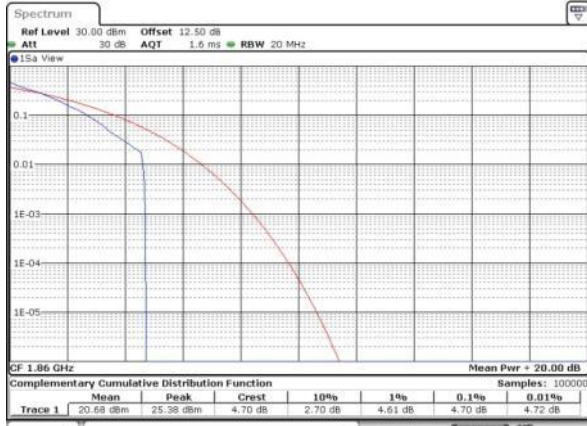

Date: 9 AUG 2015 10:05:38

Lowest Channel / Full RB

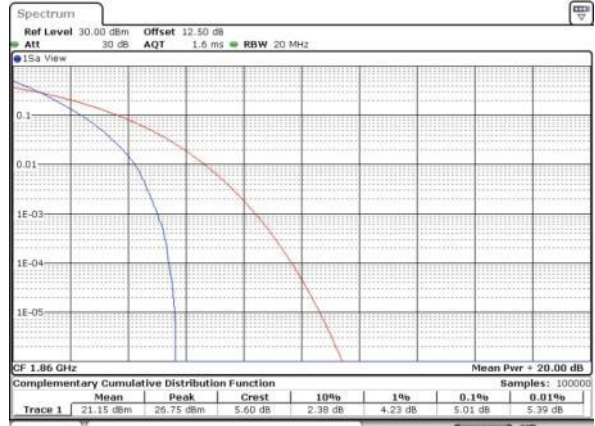

Date: 9 AUG 2015 10:05:48

Middle Channel / 1RB

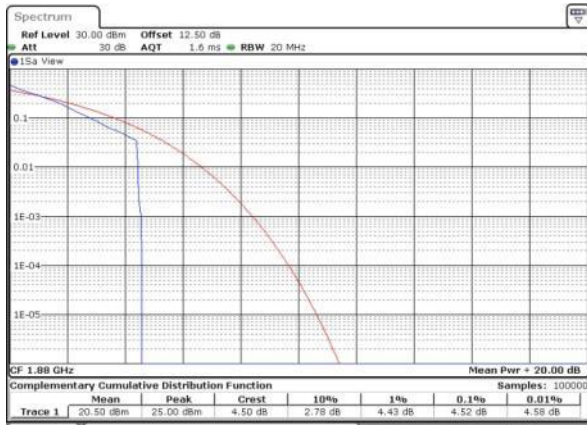

Date: 9 AUG 2015 10:05:58

Middle Channel / Full RB



Date: 9 AUG 2015 10:06:06

Highest Channel / 1RB



Date: 9 AUG 2015 10:06:18

Highest Channel / Full RB



Date: 9 AUG 2015 10:06:28



LTE Band 2 / 20MHz / 16QAM

Lowest Channel / 1RB

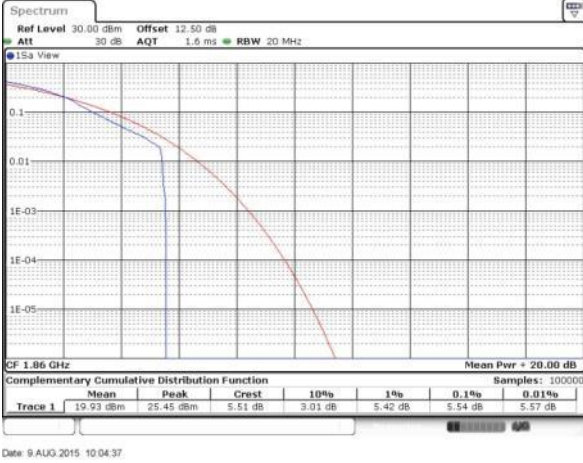

Lowest Channel / Full RB

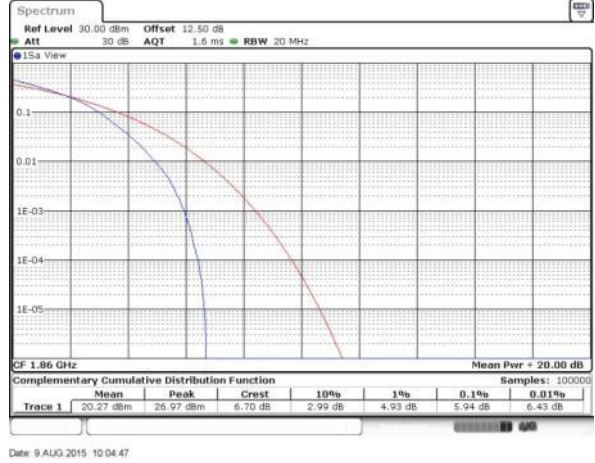

Middle Channel / 1RB

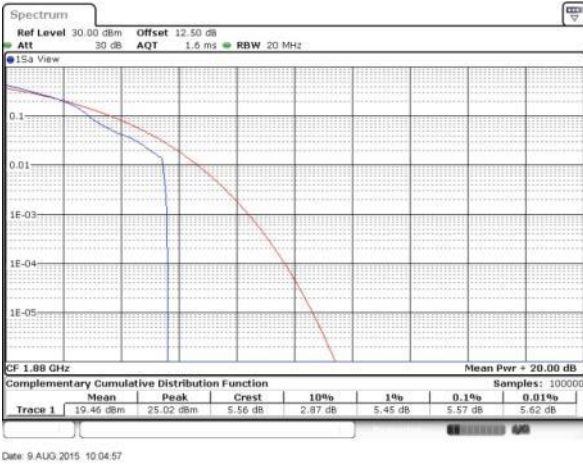

Middle Channel / Full RB

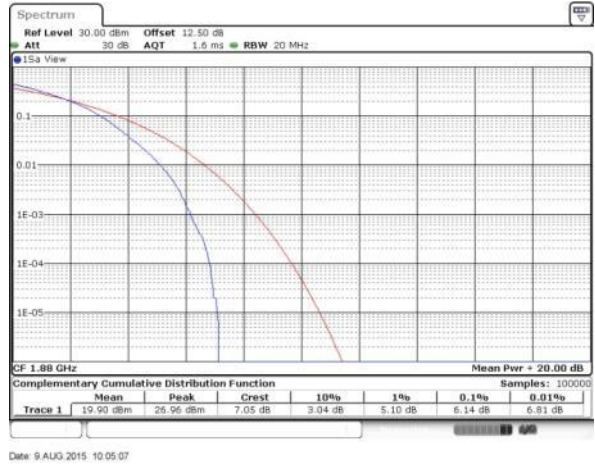

Highest Channel / 1RB

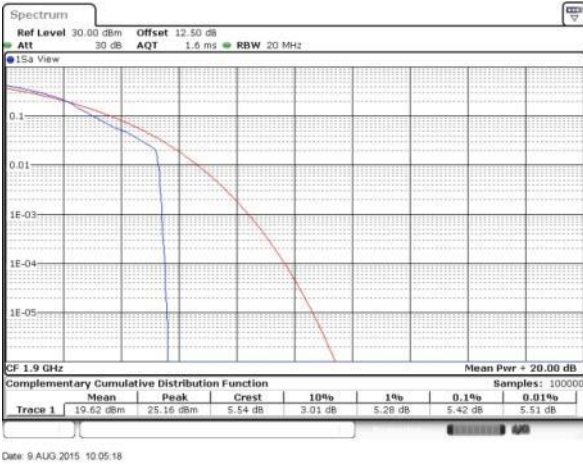

Highest Channel / Full RB





26dB Bandwidth

Mode	LTE Band 2 : 26dB BW(MHz)											
	1.4MHz		3MHz		5MHz		10MHz		15MHz		20MHz	
BW												
Mod.	QPSK	16QAM	QPSK	16QAM	QPSK	16QAM	QPSK	16QAM	QPSK	16QAM	QPSK	16QAM
Lowest CH	1.24	1.23	2.99	3.05	4.86	4.91	9.87	9.73	14.39	14.36	20.18	20.18
Middle CH	1.23	1.23	3.03	3.02	4.88	4.92	9.75	9.77	14.45	14.51	20.26	20.18
Highest CH	1.23	1.24	2.96	3.07	4.88	4.86	9.71	9.93	14.45	14.33	20.26	20.42



LTE Band 2

Lowest Channel / 1.4MHz / QPSK

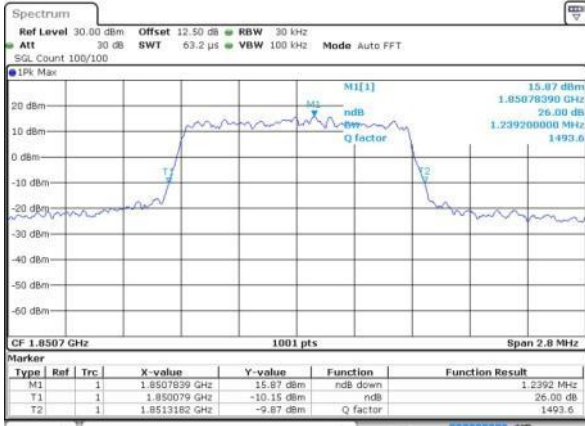

Date: 9 AUG 2015 09:47:14

Lowest Channel / 1.4MHz / 16QAM

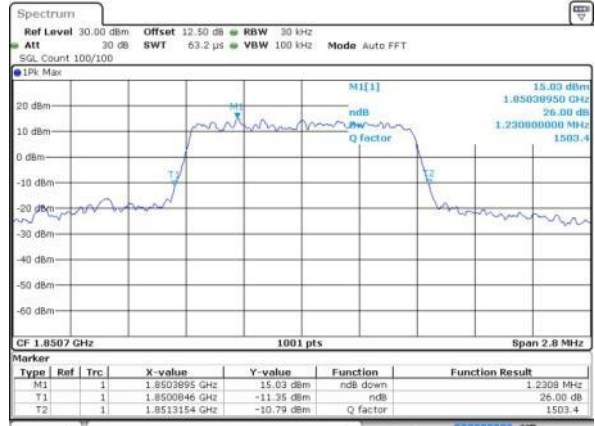

Date: 9 AUG 2015 09:47:25

Middle Channel / 1.4MHz / QPSK

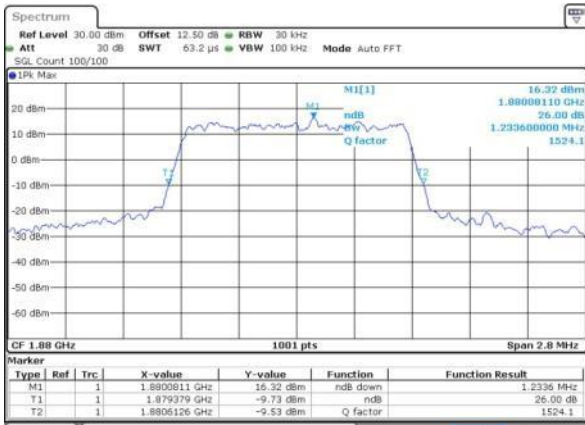

Date: 9 AUG 2015 09:54:23

Middle Channel / 1.4MHz / 16QAM

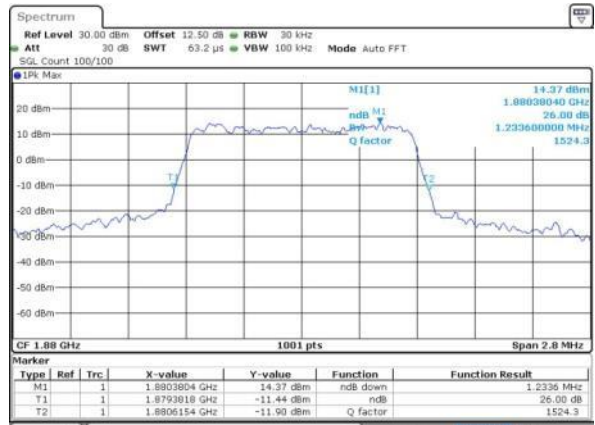

Date: 9 AUG 2015 11:01:24

Highest Channel / 1.4MHz / QPSK

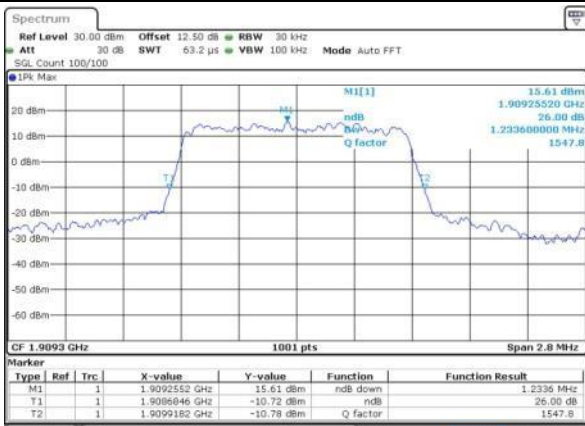

Date: 9 AUG 2015 09:56:55

Highest Channel / 1.4MHz / 16QAM

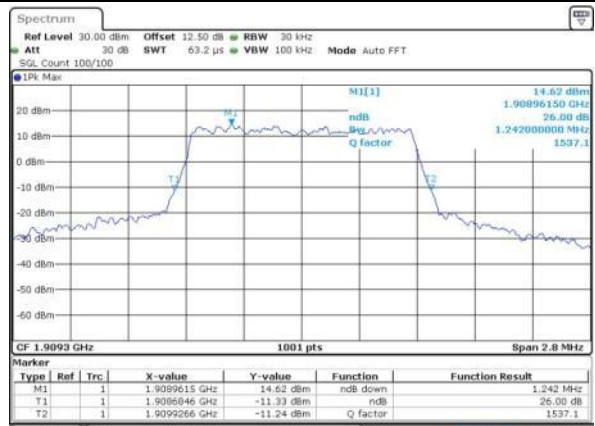

Date: 9 AUG 2015 09:57:06



LTE Band 2

Lowest Channel / 3MHz / QPSK

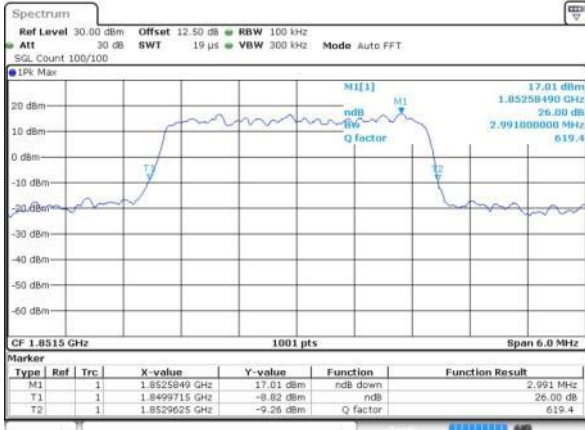

Date: 9 AUG 2015 08:04:58

Lowest Channel / 3MHz / 16QAM

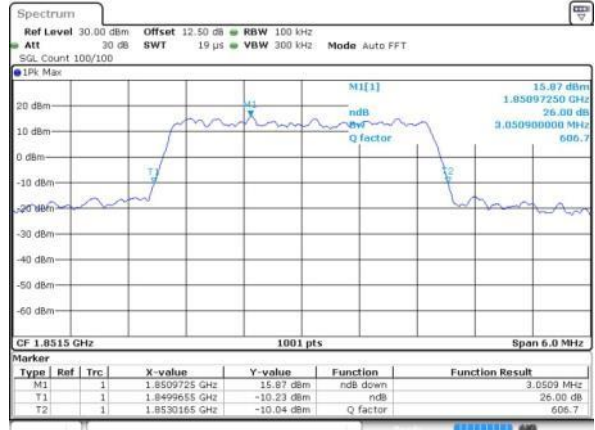

Date: 9 AUG 2015 08:05:09

Middle Channel / 3MHz / QPSK

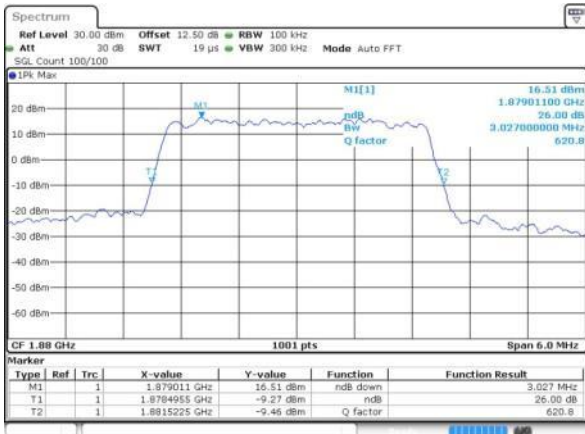

Date: 9 AUG 2015 08:12:08

Middle Channel / 3MHz / 16QAM



Date: 9 AUG 2015 08:12:16

Highest Channel / 3MHz / QPSK

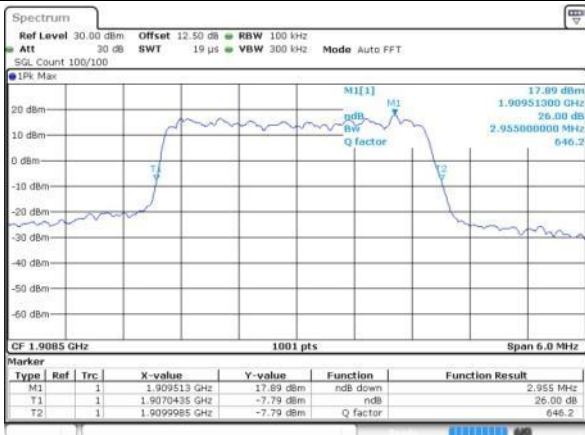

Date: 9 AUG 2015 08:14:39

Highest Channel / 3MHz / 16QAM

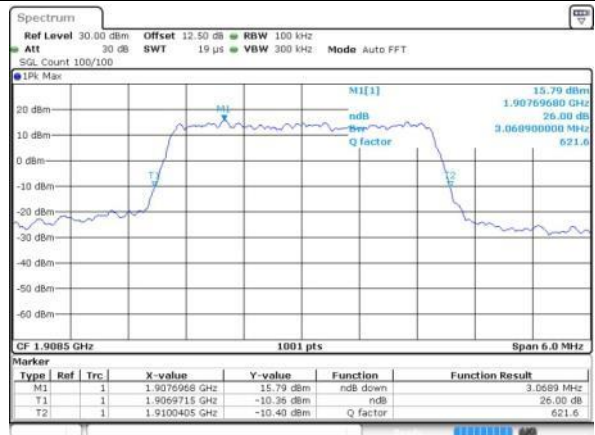

Date: 9 AUG 2015 08:14:49



LTE Band 2

Lowest Channel / 5MHz / QPSK

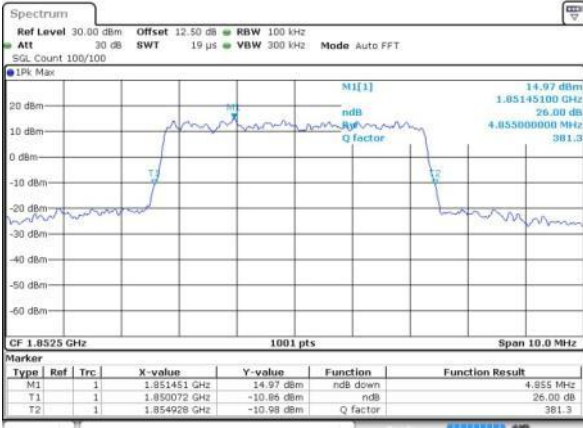

Date: 9 AUG 2015 08:21:47

Lowest Channel / 5MHz / 16QAM

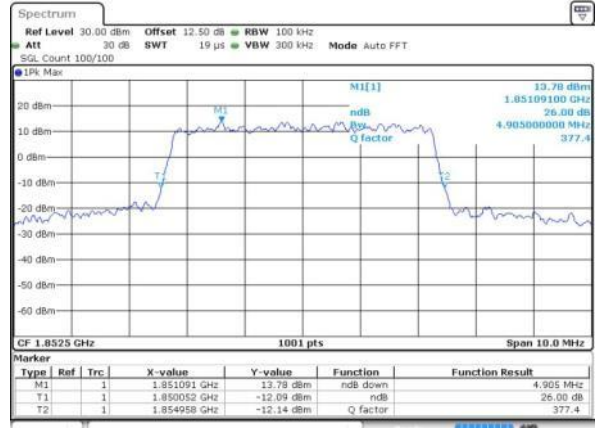

Date: 9 AUG 2015 08:21:57

Middle Channel / 5MHz / QPSK

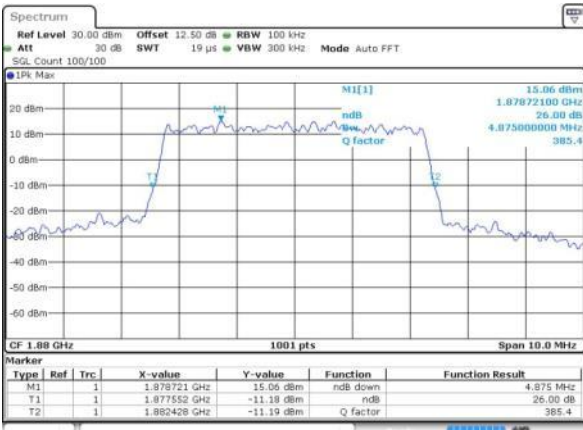

Date: 9 AUG 2015 08:28:55

Middle Channel / 5MHz / 16QAM

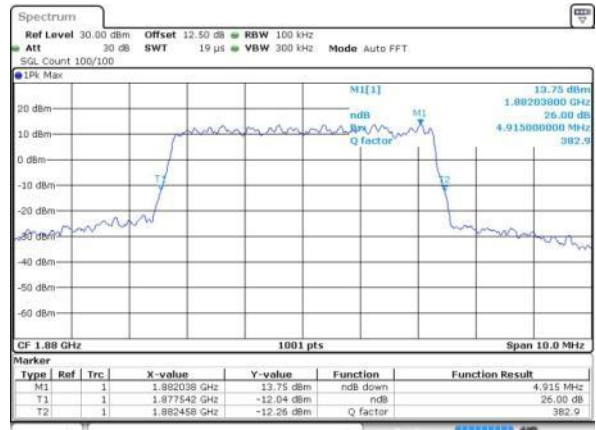

Date: 9 AUG 2015 08:29:05

Highest Channel / 5MHz / QPSK

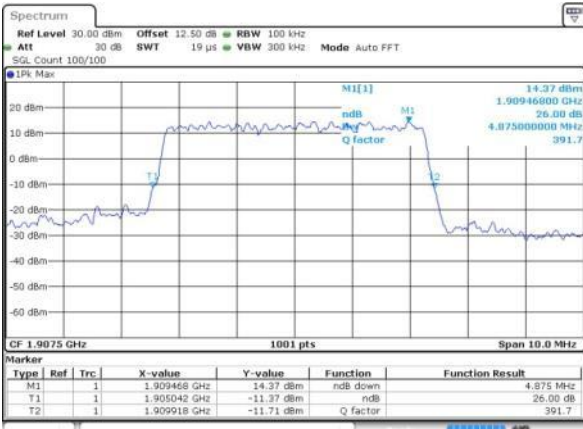

Date: 9 AUG 2015 08:31:26

Highest Channel / 5MHz / 16QAM

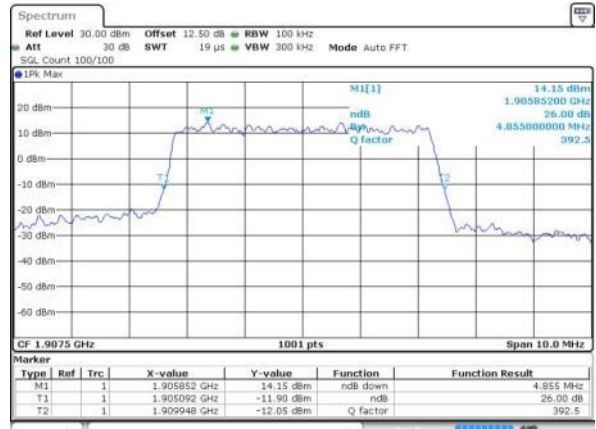

Date: 9 AUG 2015 08:31:36



LTE Band 2

Lowest Channel / 10MHz / QPSK

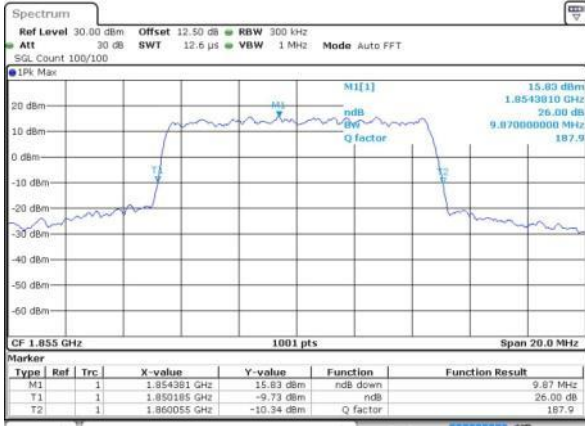

Date: 9 AUG 2015 08:38:34

Lowest Channel / 10MHz / 16QAM

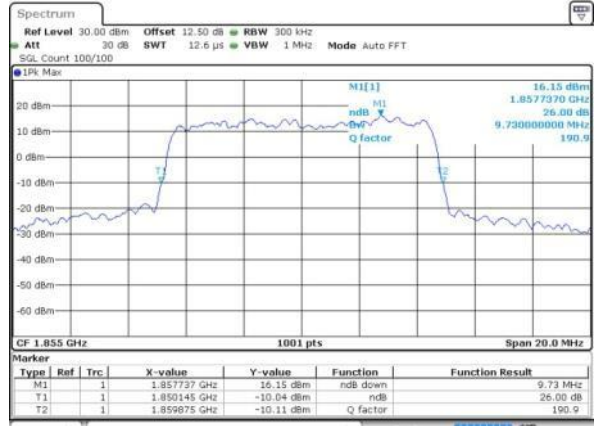

Date: 9 AUG 2015 08:38:44

Middle Channel / 10MHz / QPSK

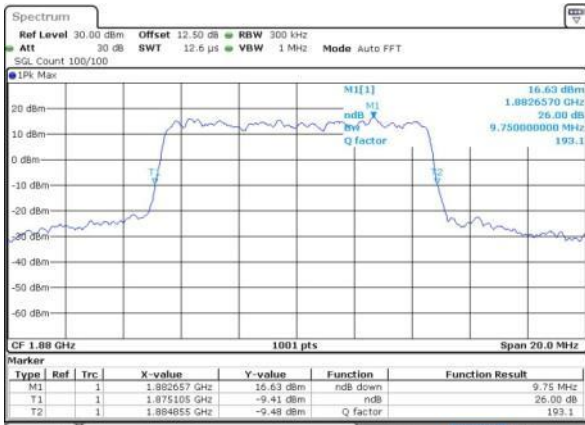

Date: 9 AUG 2015 08:45:42

Middle Channel / 10MHz / 16QAM

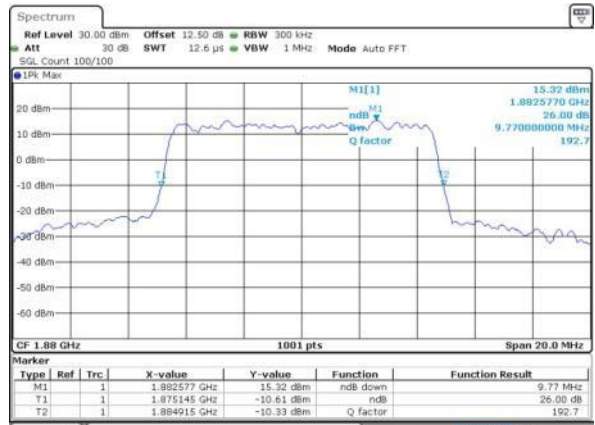

Date: 9 AUG 2015 08:45:52

Highest Channel / 10MHz / QPSK

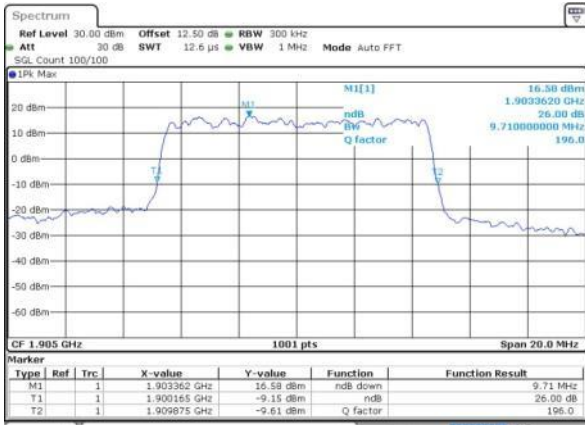

Date: 9 AUG 2015 08:48:13

Highest Channel / 10MHz / 16QAM

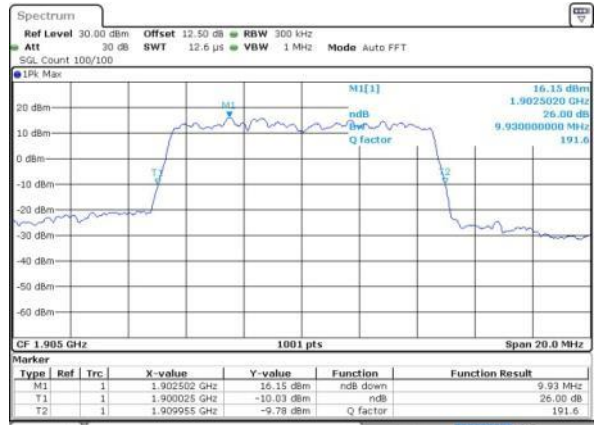

Date: 9 AUG 2015 08:48:23



LTE Band 2

Lowest Channel / 15MHz / QPSK

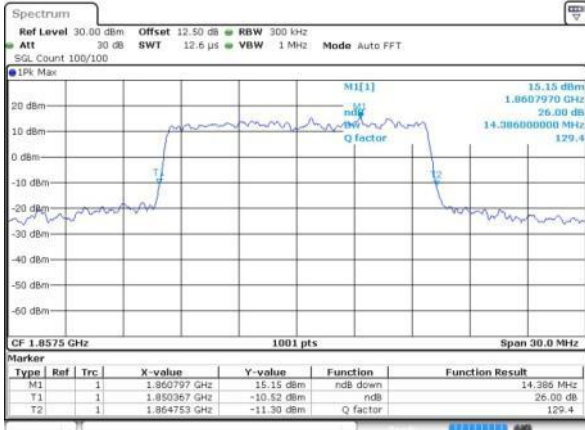

Date: 9 AUG 2015 08:55:21

Lowest Channel / 15MHz / 16QAM

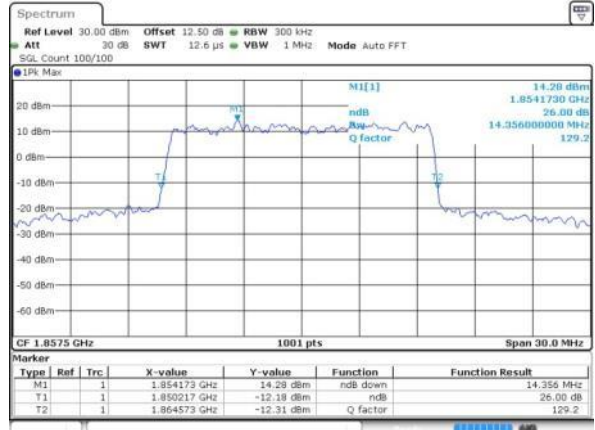

Date: 9 AUG 2015 08:55:31

Middle Channel / 15MHz / QPSK

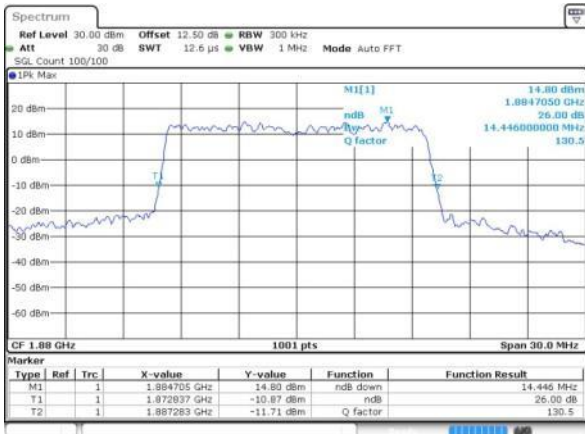

Date: 9 AUG 2015 09:02:28

Middle Channel / 15MHz / 16QAM

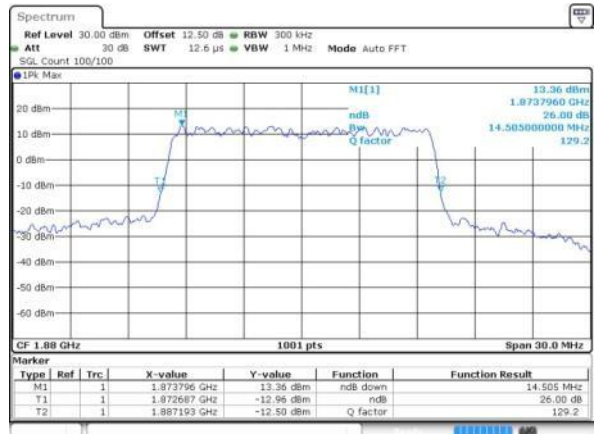

Date: 9 AUG 2015 09:02:36

Highest Channel / 15MHz / QPSK



Date: 9 AUG 2015 09:04:59

Highest Channel / 15MHz / 16QAM



Date: 9 AUG 2015 09:05:10



LTE Band 2

Lowest Channel / 20MHz / QPSK

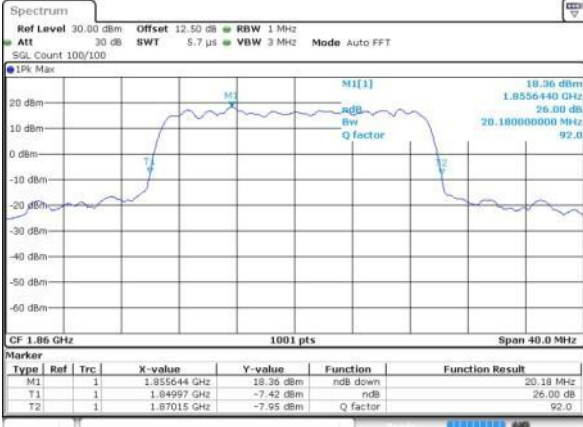

Date: 9 AUG 2015 09:12:07

Lowest Channel / 20MHz / 16QAM

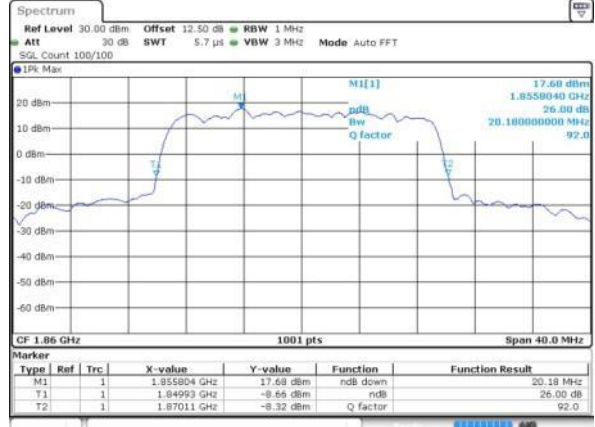

Date: 9 AUG 2015 09:12:18

Middle Channel / 20MHz / QPSK

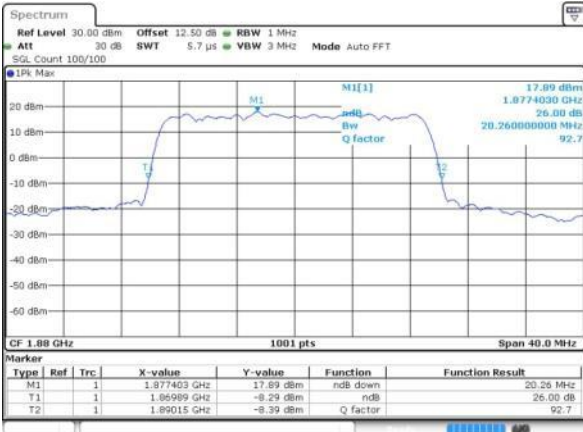

Date: 9 AUG 2015 09:19:15

Middle Channel / 20MHz / 16QAM

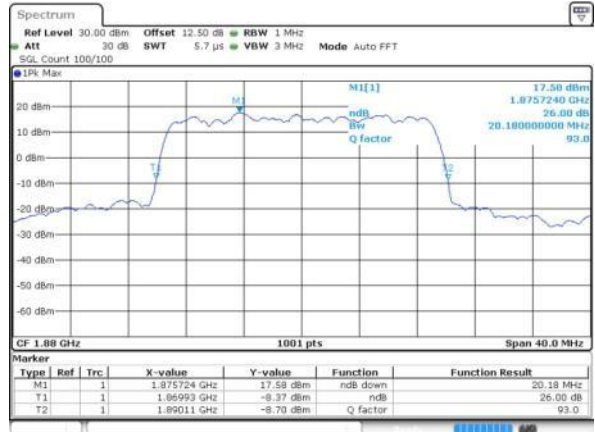

Date: 9 AUG 2015 09:19:26

Highest Channel / 20MHz / QPSK

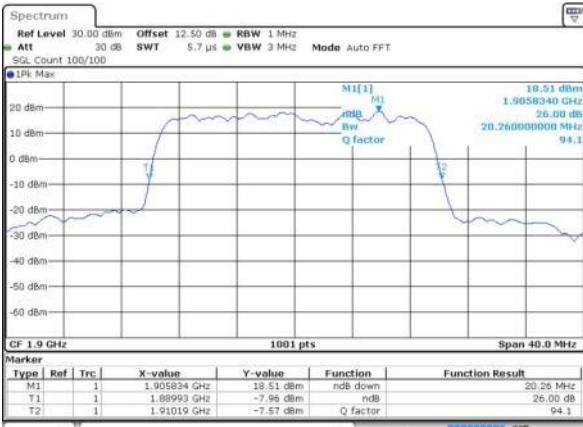

Date: 9 AUG 2015 09:21:46

Highest Channel / 20MHz / 16QAM

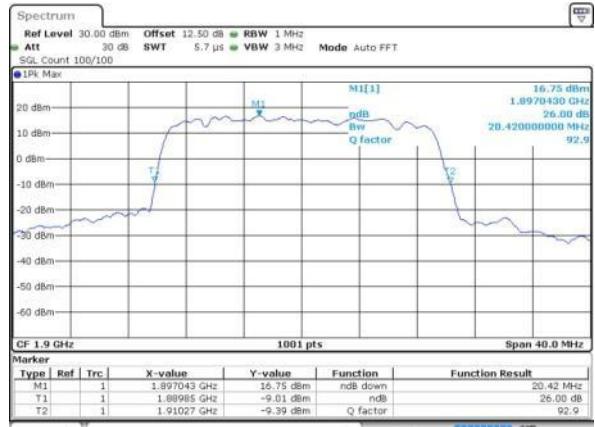

Date: 9 AUG 2015 09:21:57



Occupied Bandwidth

Mode	LTE Band 2 : 99%OBW(MHz)											
	1.4MHz		3MHz		5MHz		10MHz		15MHz		20MHz	
BW												
Mod.	QPSK	16QAM	QPSK	16QAM	QPSK	16QAM	QPSK	16QAM	QPSK	16QAM	QPSK	16QAM
Lowest CH	1.09	1.09	2.72	2.73	4.48	4.51	9.03	9.03	13.43	13.46	18.34	18.34
Middle CH	1.09	1.09	2.7	2.72	4.47	4.49	9.05	9.05	13.52	13.46	18.5	18.54
Highest CH	1.09	1.09	2.73	2.73	4.5	4.51	9.15	9.01	13.4	13.46	18.3	18.26



LTE Band 2

Lowest Channel / 1.4MHz / QPSK

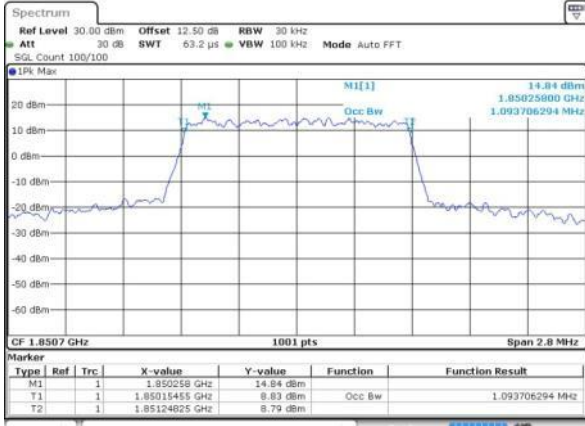

Date: 9 AUG 2015 09:46:53

Lowest Channel / 1.4MHz / 16QAM

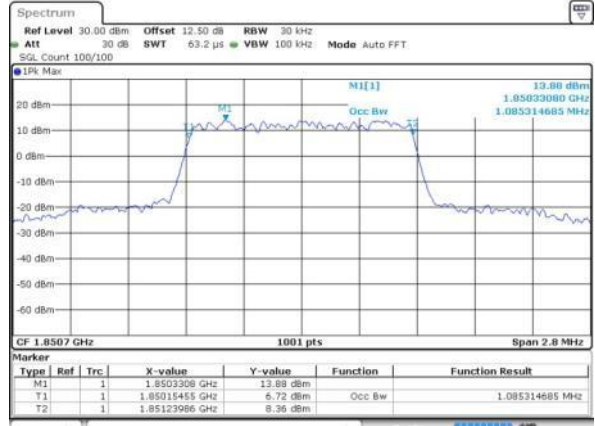

Date: 9 AUG 2015 09:47:04

Middle Channel / 1.4MHz / QPSK

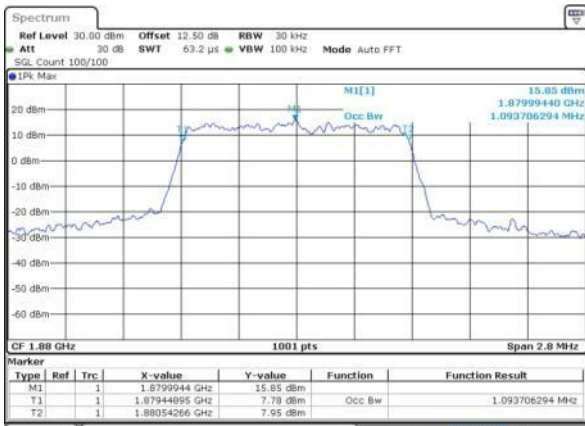

Date: 9 AUG 2015 09:54:02

Middle Channel / 1.4MHz / 16QAM

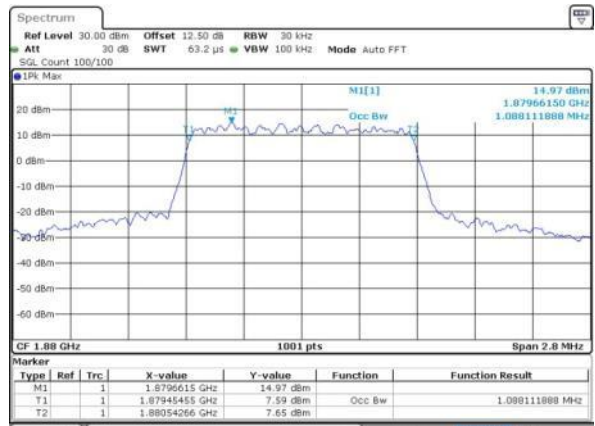

Date: 9 AUG 2015 09:54:13

Highest Channel / 1.4MHz / QPSK

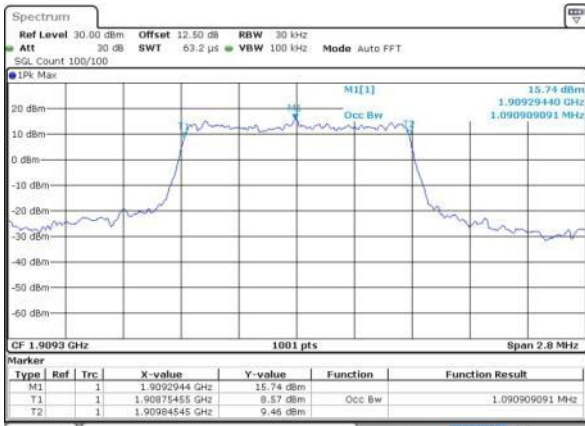

Date: 9 AUG 2015 09:56:34

Highest Channel / 1.4MHz / 16QAM

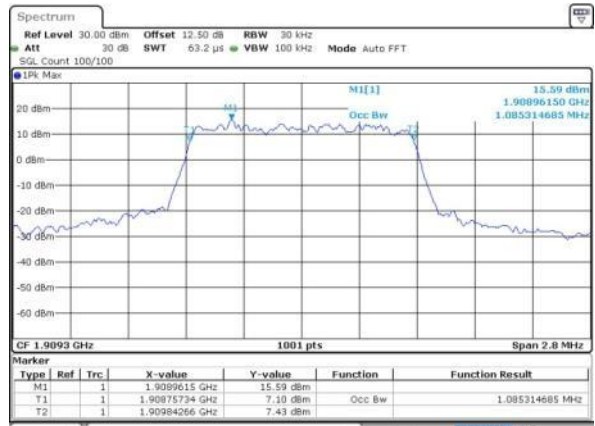

Date: 9 AUG 2015 09:56:45



LTE Band 2

Lowest Channel / 3MHz / QPSK

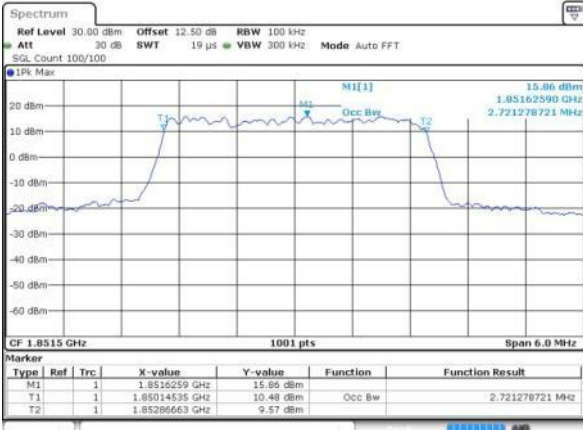

Date: 9 AUG 2015 08:04:37

Lowest Channel / 3MHz / 16QAM

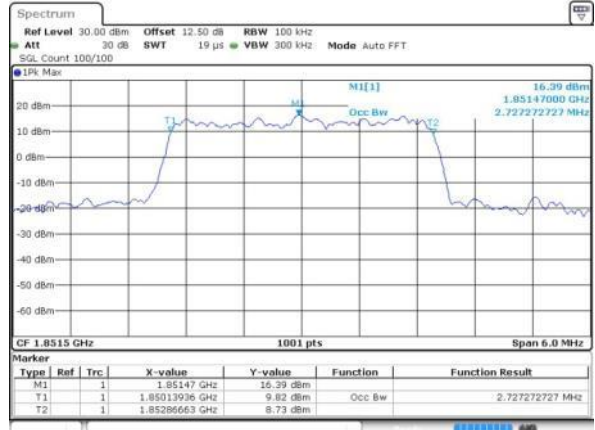

Date: 9 AUG 2015 08:04:48

Middle Channel / 3MHz / QPSK

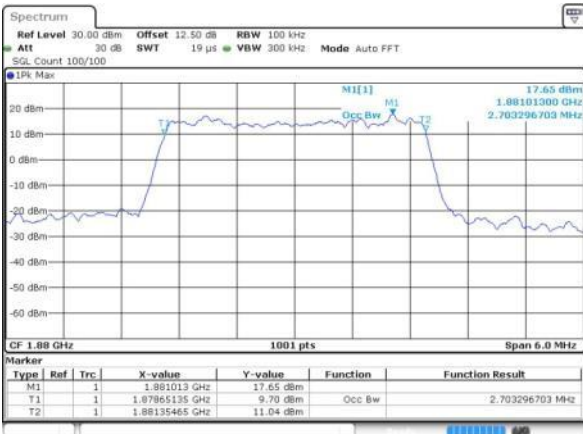

Date: 9 AUG 2015 08:11:47

Middle Channel / 3MHz / 16QAM

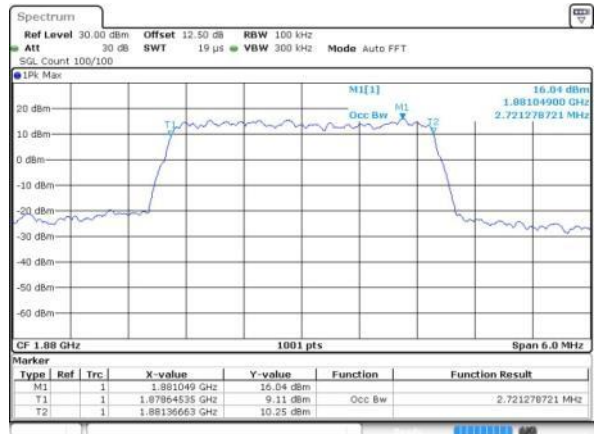

Date: 9 AUG 2015 08:11:57

Highest Channel / 3MHz / QPSK

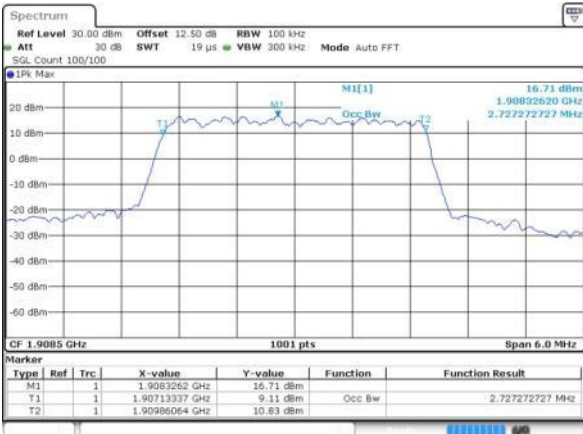

Date: 9 AUG 2015 08:14:18

Highest Channel / 3MHz / 16QAM

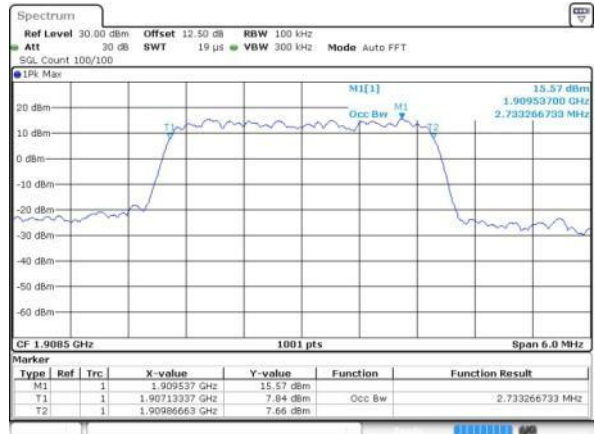

Date: 9 AUG 2015 08:14:28



LTE Band 2

Lowest Channel / 5MHz / QPSK

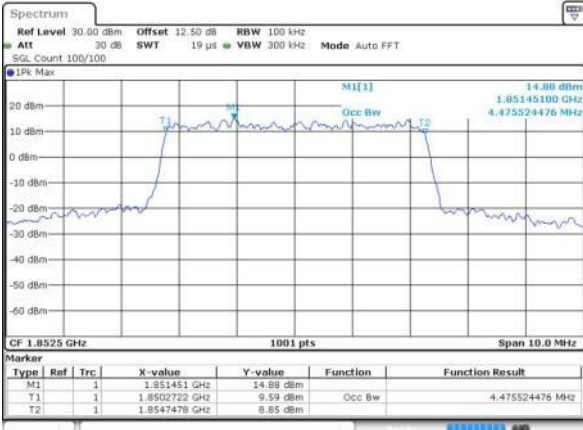

Date: 9 AUG 2015 08:21:26

Lowest Channel / 5MHz / 16QAM

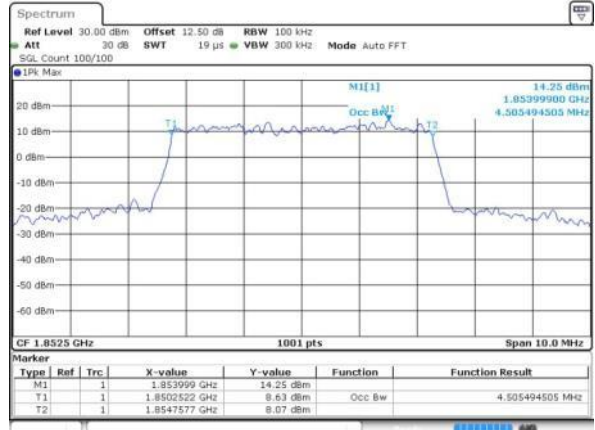

Date: 9 AUG 2015 08:21:37

Middle Channel / 5MHz / QPSK

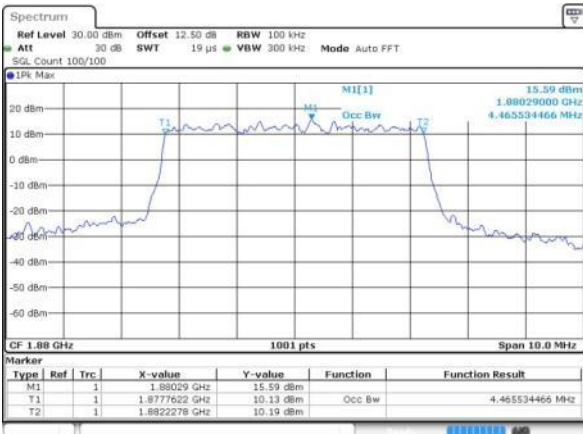

Date: 9 AUG 2015 08:28:34

Middle Channel / 5MHz / 16QAM

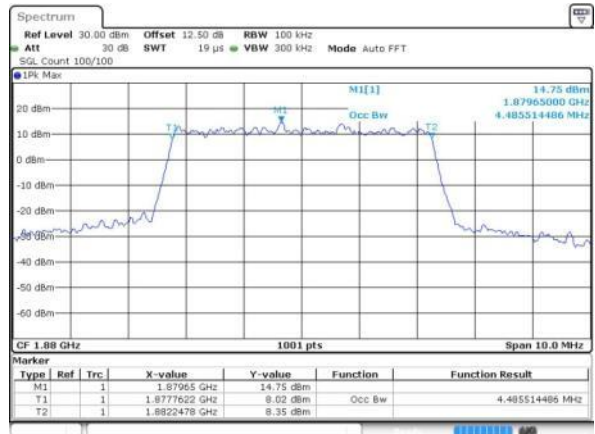

Date: 9 AUG 2015 08:28:44

Highest Channel / 5MHz / QPSK

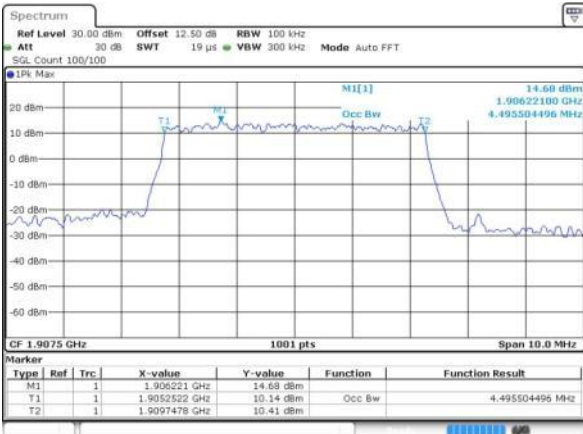

Date: 9 AUG 2015 08:31:05

Highest Channel / 5MHz / 16QAM

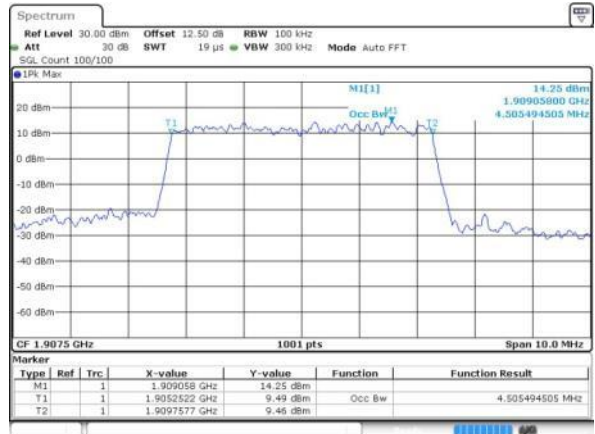

Date: 9 AUG 2015 08:31:15



LTE Band 2

Lowest Channel / 10MHz / QPSK

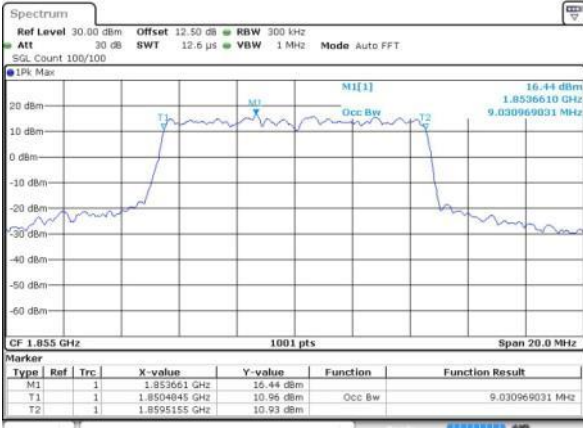

Date: 9 AUG 2015 08:38:13

Lowest Channel / 10MHz / 16QAM

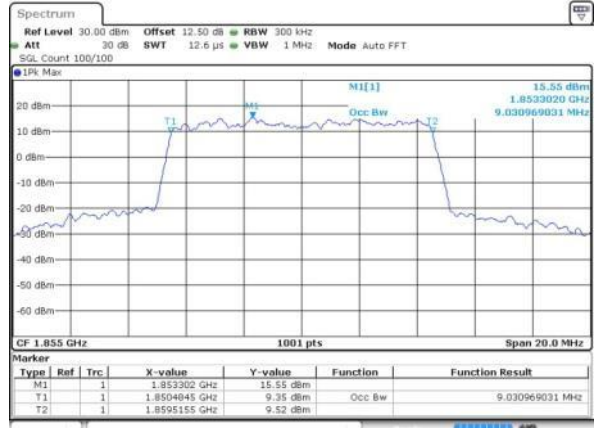

Date: 9 AUG 2015 08:38:23

Middle Channel / 10MHz / QPSK

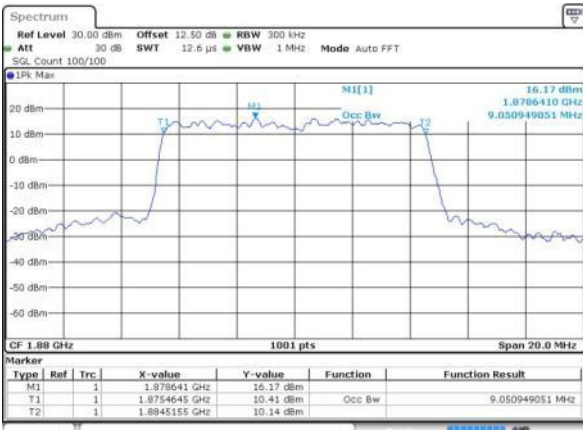

Date: 9 AUG 2015 08:45:21

Middle Channel / 10MHz / 16QAM

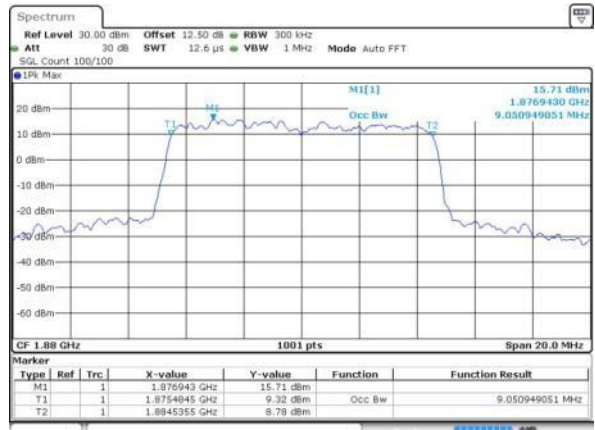

Date: 9 AUG 2015 08:45:31

Highest Channel / 10MHz / QPSK

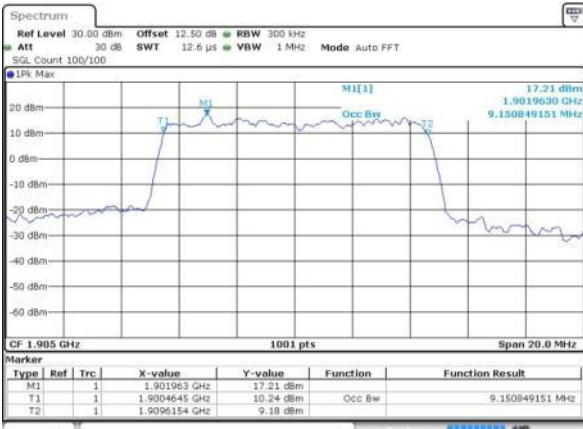

Date: 9 AUG 2015 08:47:52

Highest Channel / 10MHz / 16QAM

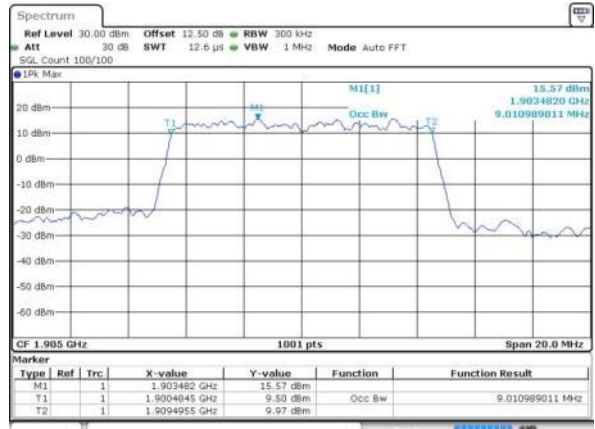

Date: 9 AUG 2015 08:48:02



LTE Band 2

Lowest Channel / 15MHz / QPSK

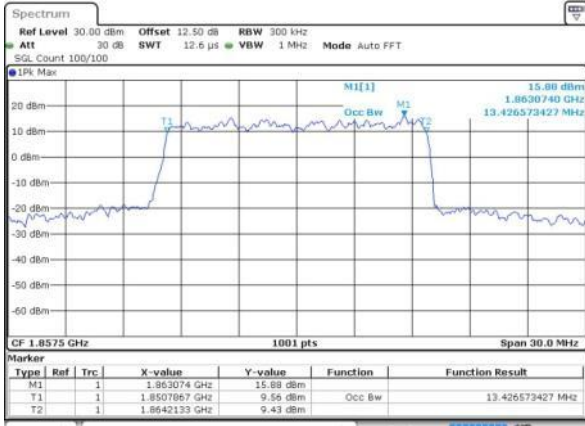

Date: 9 AUG 2015 08:55:00

Lowest Channel / 15MHz / 16QAM

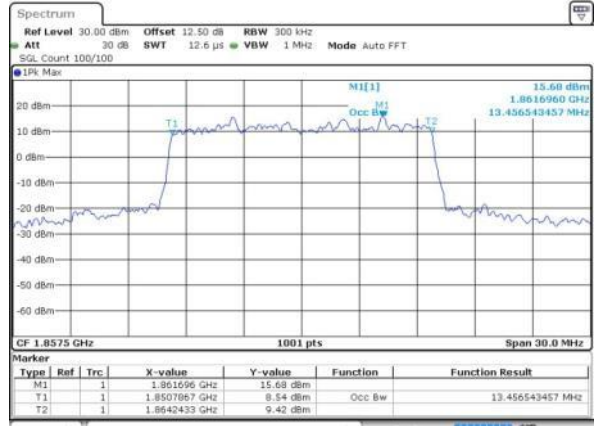

Date: 9 AUG 2015 08:55:10

Middle Channel / 15MHz / QPSK

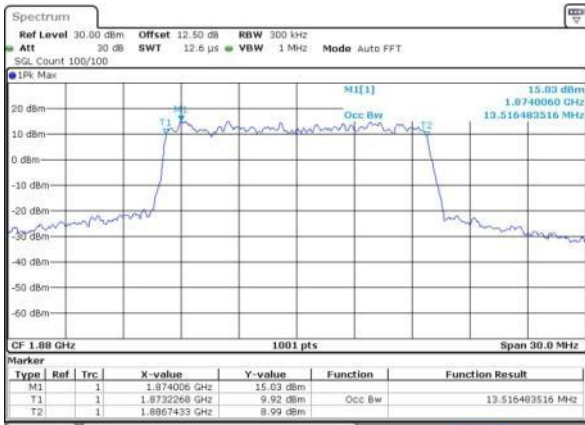

Date: 9 AUG 2015 09:02:08

Middle Channel / 15MHz / 16QAM

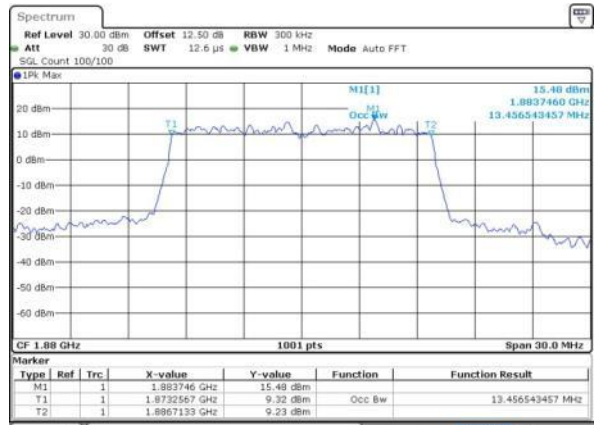

Date: 9 AUG 2015 09:02:16

Highest Channel / 15MHz / QPSK

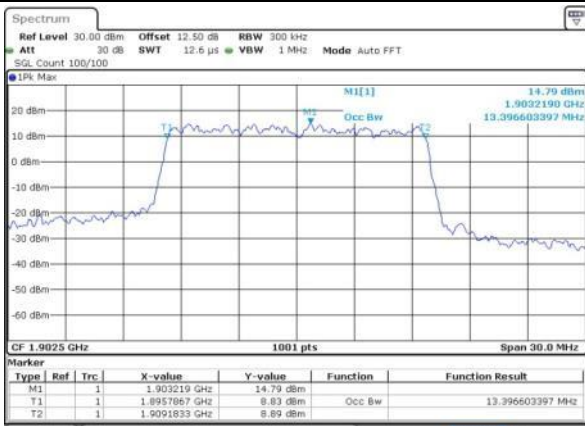

Date: 9 AUG 2015 09:04:39

Highest Channel / 15MHz / 16QAM

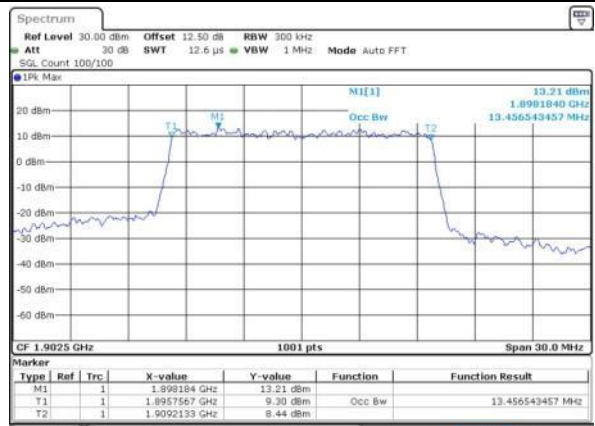

Date: 9 AUG 2015 09:04:49



LTE Band 2

Lowest Channel / 20MHz / QPSK

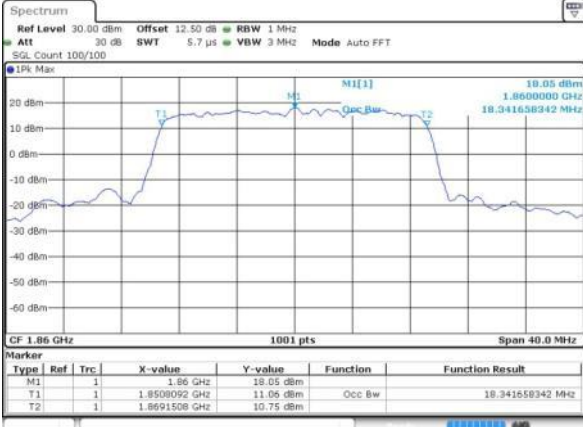

Date: 9 AUG 2015 09:11:46

Lowest Channel / 20MHz / 16QAM



Date: 9 AUG 2015 09:11:57

Middle Channel / 20MHz / QPSK



Date: 9 AUG 2015 09:18:54

Middle Channel / 20MHz / 16QAM



Date: 9 AUG 2015 09:19:05

Highest Channel / 20MHz / QPSK

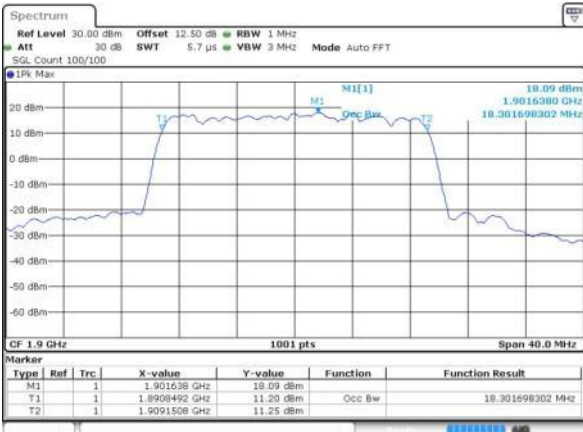

Date: 9 AUG 2015 09:21:25

Highest Channel / 20MHz / 16QAM



Date: 9 AUG 2015 09:21:36



Conducted Band Edge



LTE Band 2 / 1.4MHz / QPSK

Lowest Band Edge / 1RB

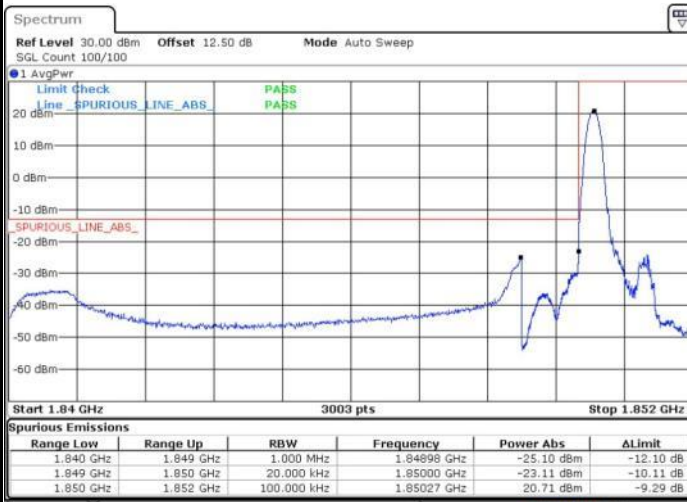

Date: 9 AUG 2015 09:48:34

Highest Band Edge / 1RB

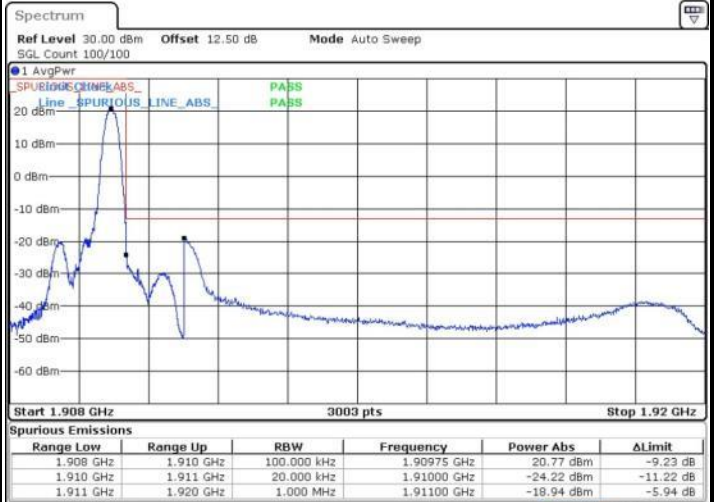

Date: 9 AUG 2015 09:58:14

Lowest Band Edge / Full RB

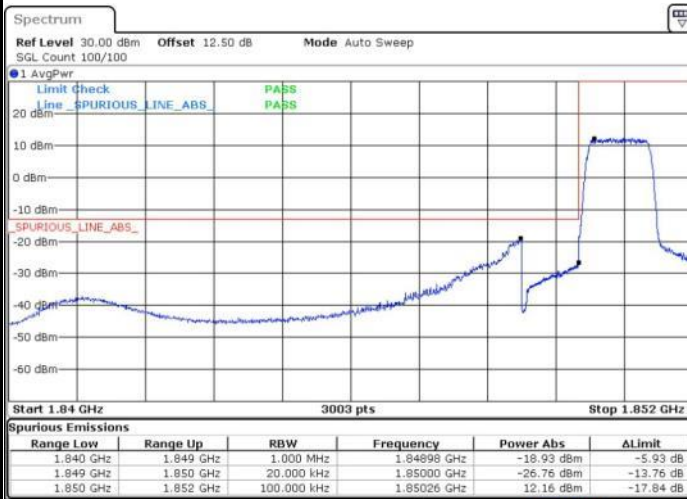

Date: 9 AUG 2015 09:50:52

Highest Band Edge / Full RB

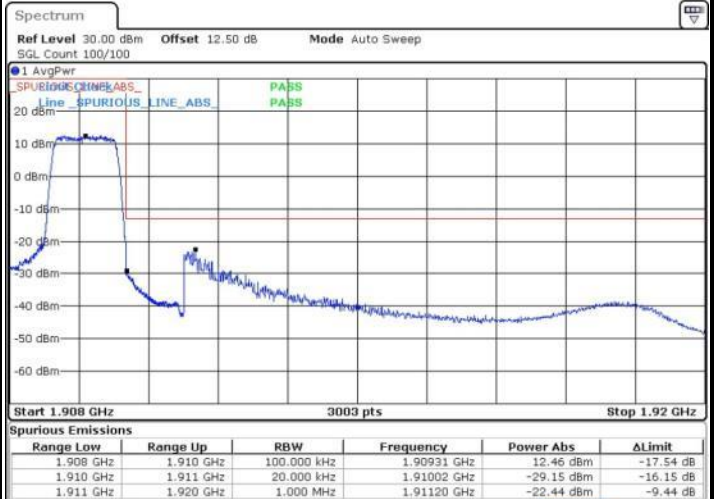

Date: 9 AUG 2015 10:00:33



LTE Band 2 / 1.4MHz / 16QAM

Lowest Band Edge / 1 RB

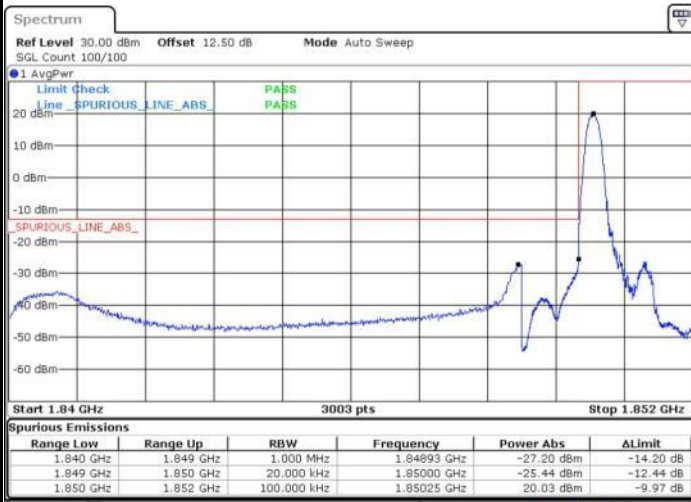

Date: 9 AUG 2015 09:49:43

Highest Band Edge / 1 RB

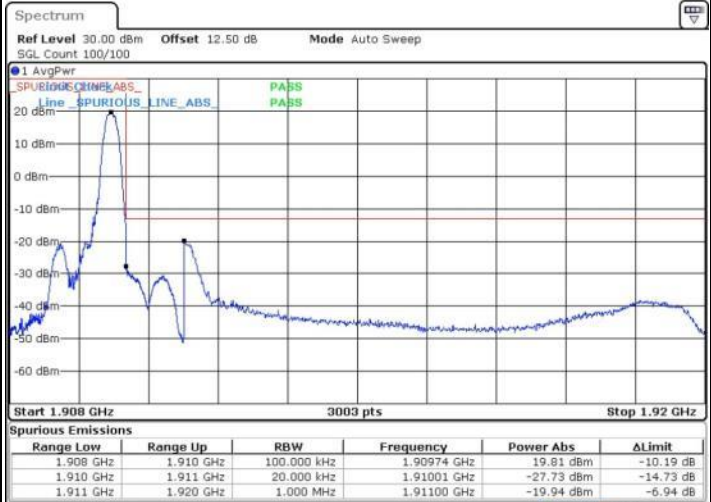

Date: 9 AUG 2015 09:59:24

Lowest Band Edge / Full RB

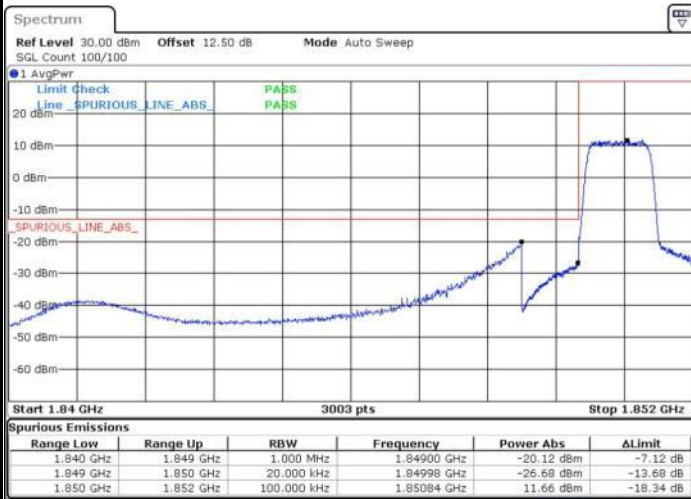

Date: 9 AUG 2015 09:52:02

Highest Band Edge / Full RB



Date: 9 AUG 2015 10:01:42



LTE Band 2 / 3MHz / QPSK

Lowest Band Edge / 1RB

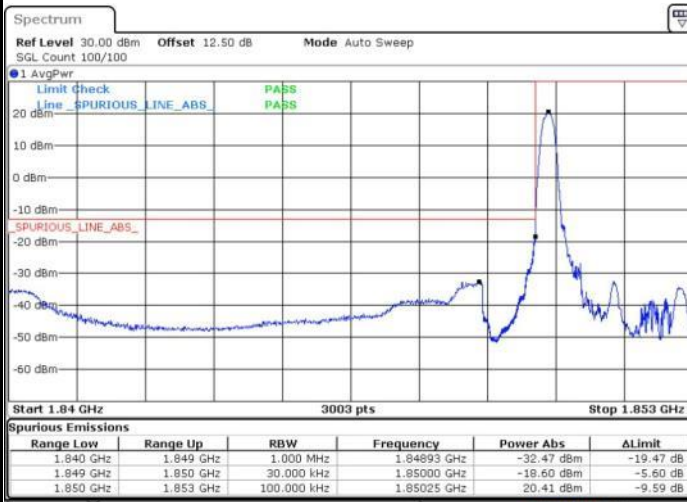

Date: 9 AUG 2015 08:06:18

Highest Band Edge / 1 RB

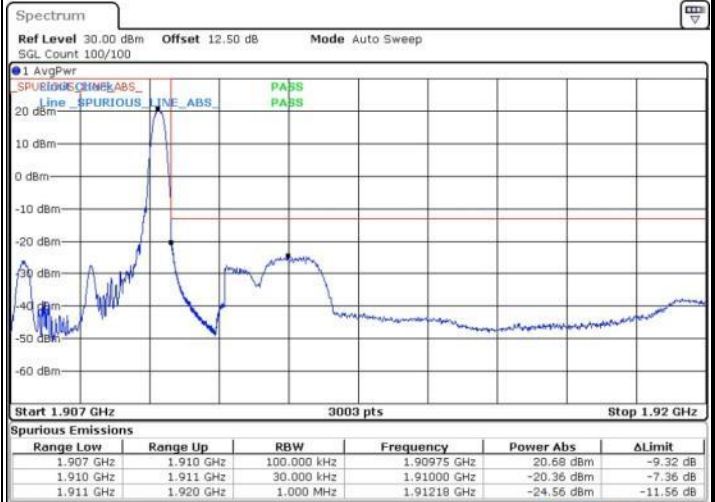

Date: 9 AUG 2015 08:15:58

Lowest Band Edge / Full RB



Date: 9 AUG 2015 08:08:37

Highest Band Edge / Full RB

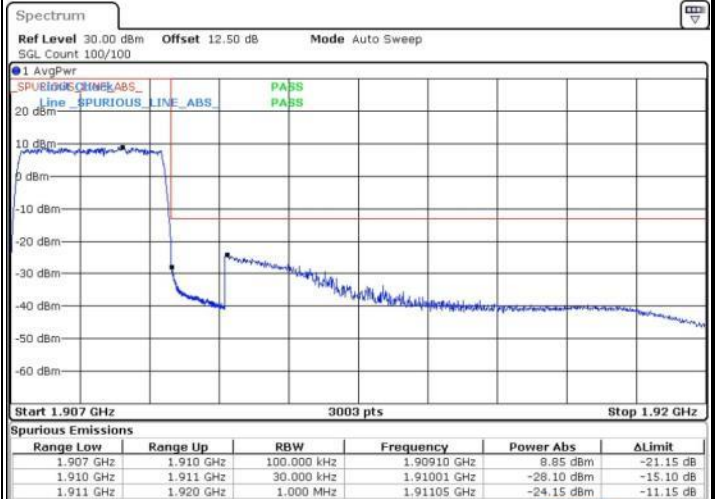

Date: 9 AUG 2015 08:18:17



LTE Band 2 / 3MHz / 16QAM

Lowest Band Edge / 1 RB

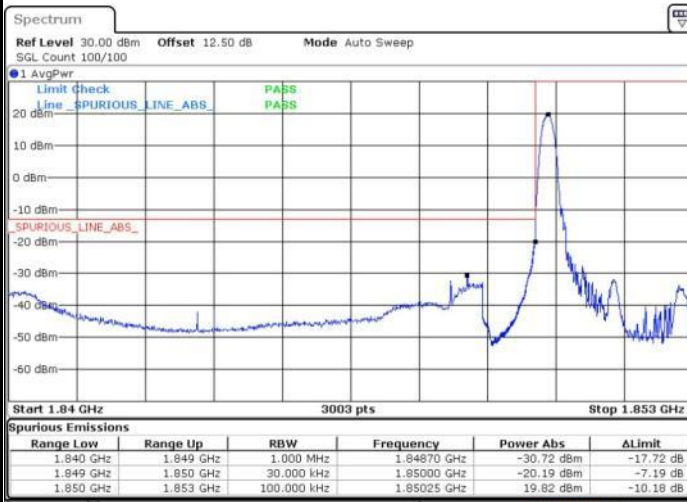

Date: 9 AUG 2015 08:07:28

Highest Band Edge / 1 RB

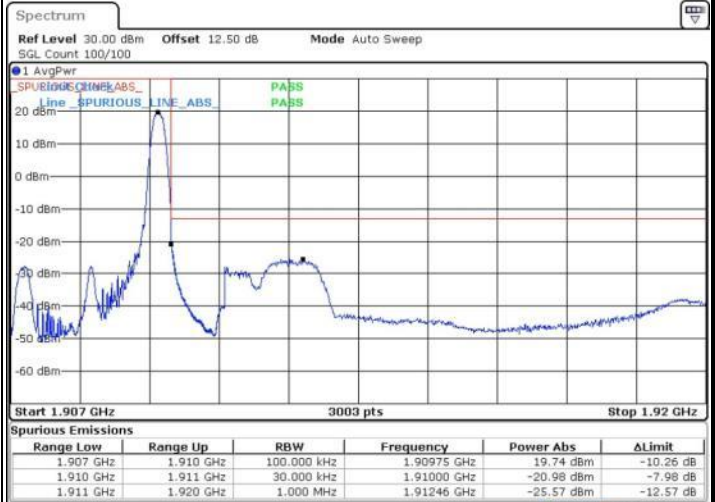

Date: 9 AUG 2015 08:17:07

Lowest Band Edge / Full RB



Date: 9 AUG 2015 08:08:46

Highest Band Edge / Full RB



Date: 9 AUG 2015 08:19:26



LTE Band 2 / 5MHz / QPSK

Lowest Band Edge / 1 RB

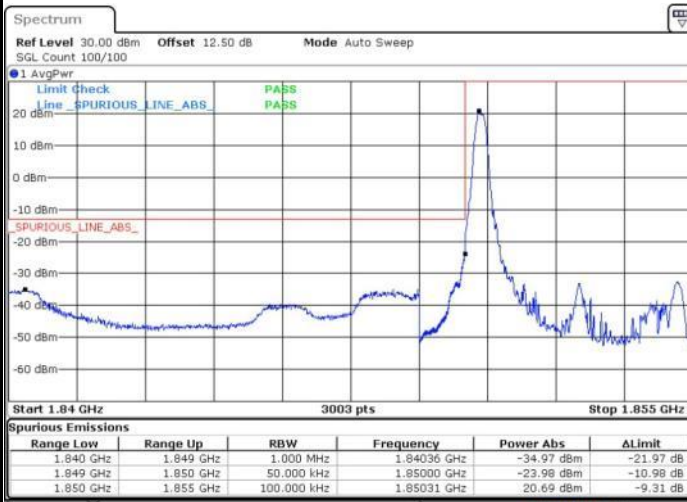

Date: 9 AUG 2015 08:23:06

Highest Band Edge / 1 RB

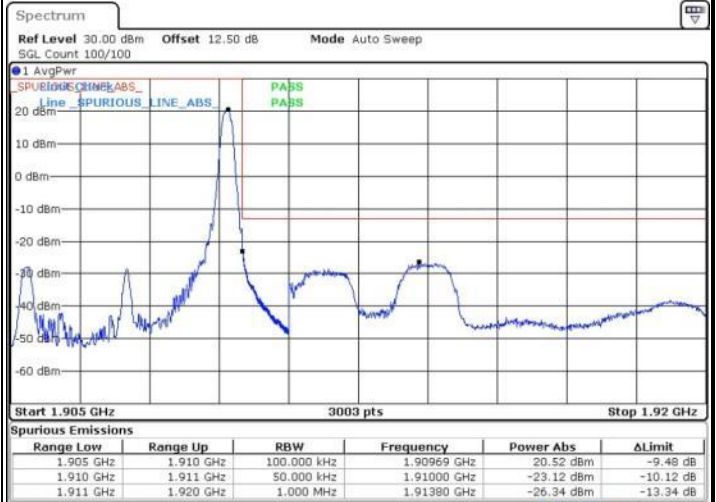

Date: 9 AUG 2015 08:32:45

Lowest Band Edge / Full RB

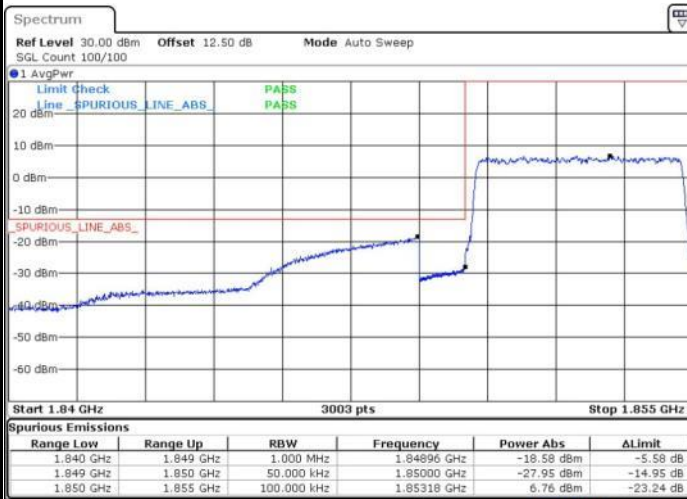

Date: 9 AUG 2015 08:25:24

Highest Band Edge / Full RB

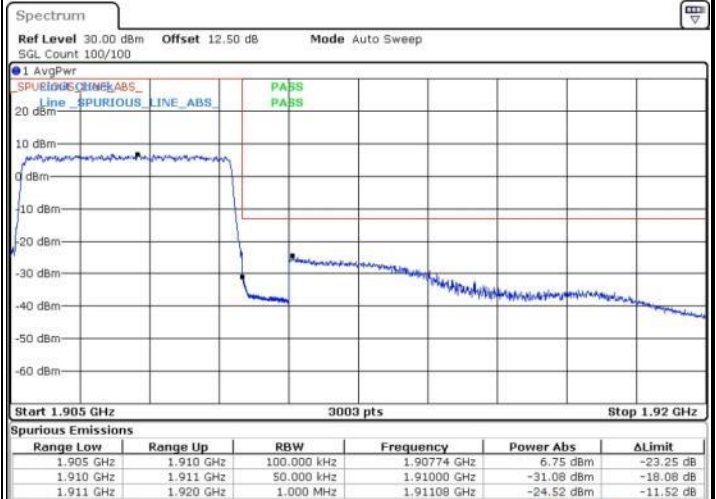

Date: 9 AUG 2015 08:35:04



LTE Band 2 / 5MHz / 16QAM

Lowest Band Edge / 1RB

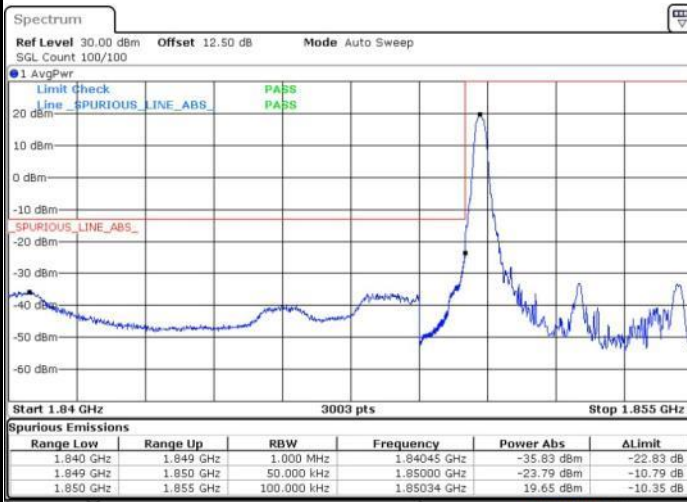

Date: 9 AUG 2015 08:24:15

Highest Band Edge / 1 RB

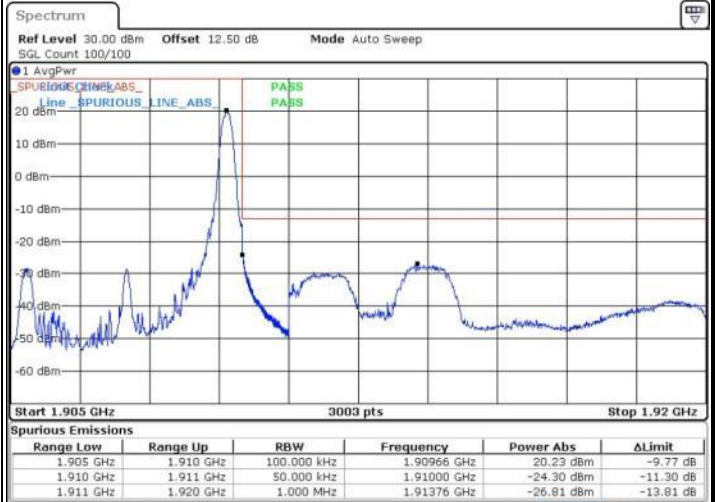

Date: 9 AUG 2015 08:33:54

Lowest Band Edge / Full RB



Date: 9 AUG 2015 08:26:34

Highest Band Edge / Full RB



Date: 9 AUG 2015 08:36:13



LTE Band 2 / 10MHz / QPSK

Lowest Band Edge / 1 RB

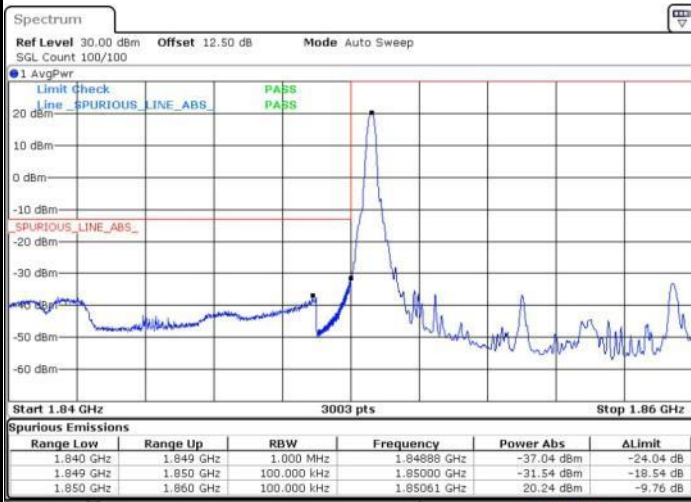

Date: 9 AUG 2015 08:39:53

Highest Band Edge / 1 RB

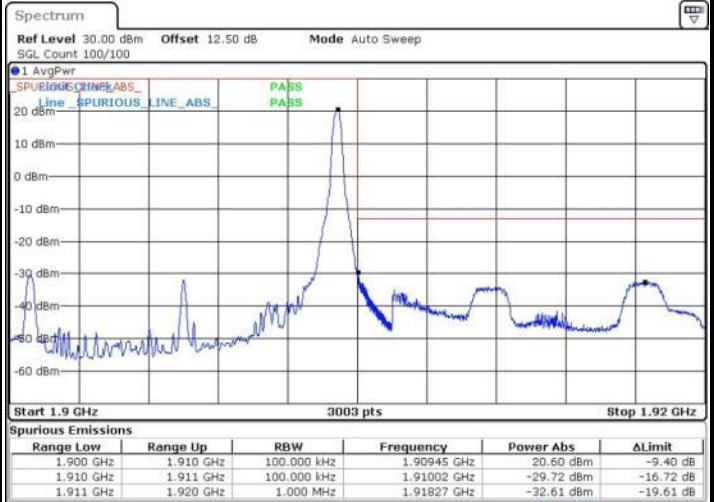

Date: 9 AUG 2015 08:49:32

Lowest Band Edge / Full RB



Date: 9 AUG 2015 08:42:11

Highest Band Edge / Full RB

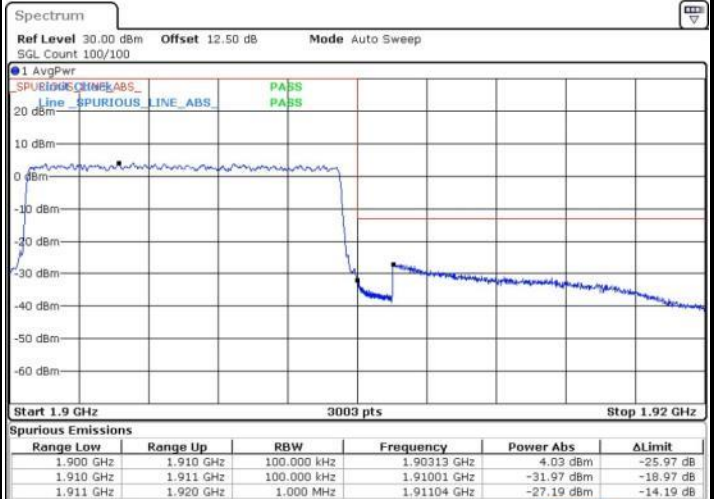

Date: 9 AUG 2015 08:51:50



LTE Band 2 / 10MHz / 16QAM

Lowest Band Edge / 1 RB

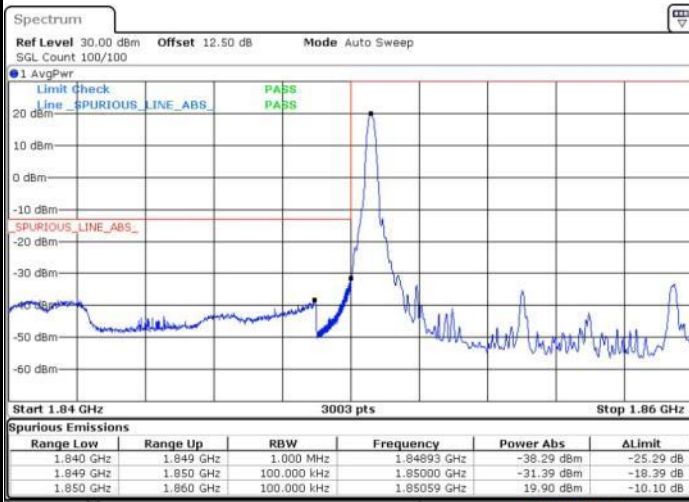

Date: 9 AUG 2015 08:41:02

Highest Band Edge / 1 RB

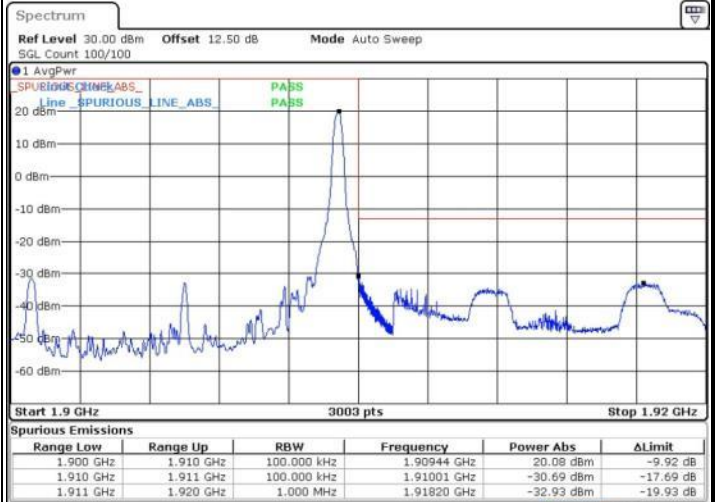

Date: 9 AUG 2015 08:50:41

Lowest Band Edge / Full RB

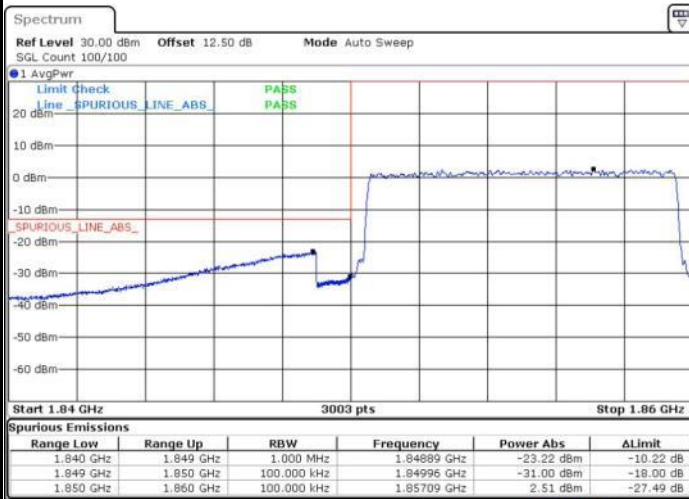

Date: 9 AUG 2015 08:43:21

Highest Band Edge / Full RB

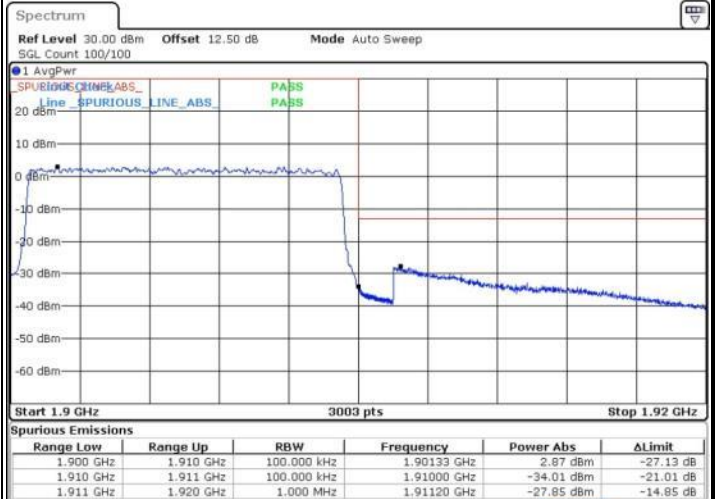

Date: 9 AUG 2015 08:52:59



LTE Band 2 / 15MHz / QPSK

Lowest Band Edge / 1 RB

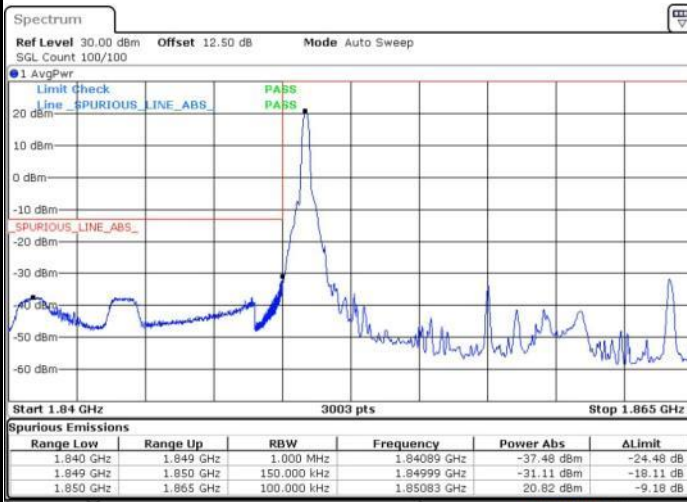

Date: 9 AUG 2015 08:56:40

Highest Band Edge / 1 RB

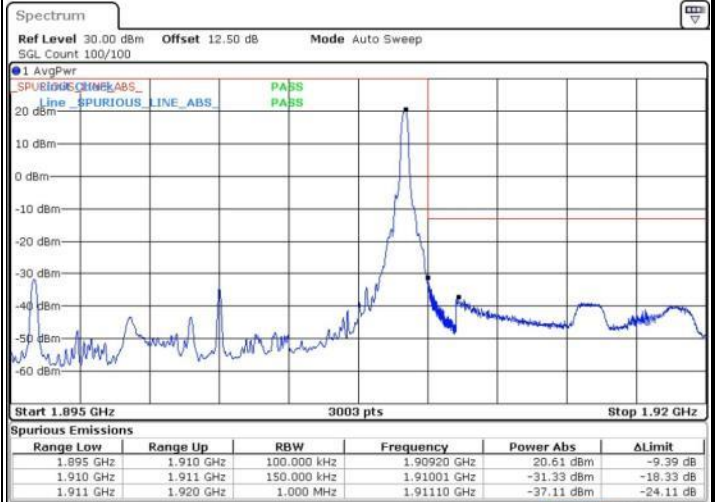

Date: 9 AUG 2015 09:06:19

Lowest Band Edge / Full RB

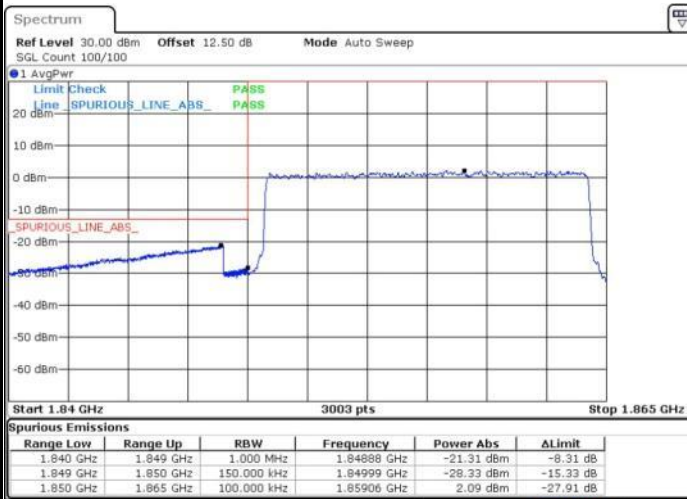

Date: 9 AUG 2015 08:58:58

Highest Band Edge / Full RB

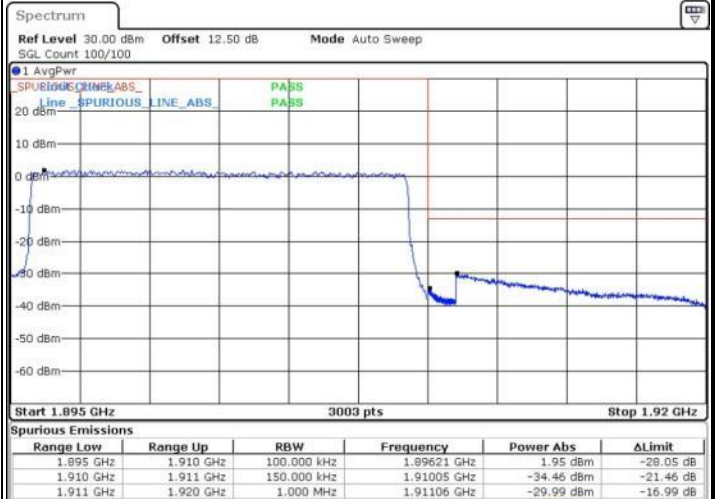

Date: 9 AUG 2015 09:08:37



LTE Band 2 / 15MHz / 16QAM

Lowest Band Edge / 1 RB

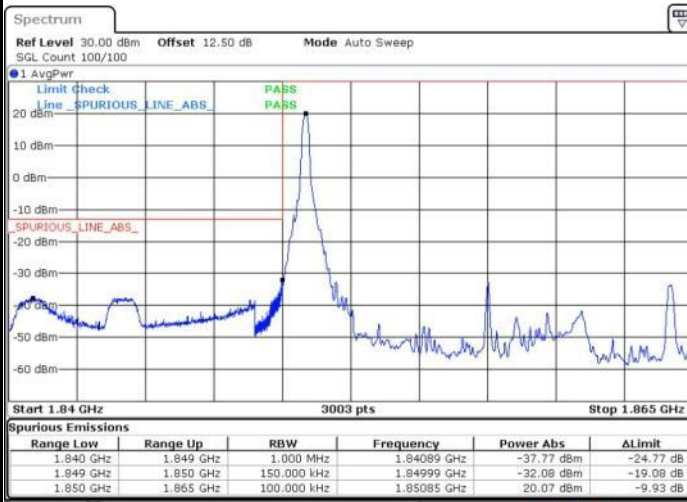

Date: 9 AUG 2015 08:57:49

Highest Band Edge / 1 RB

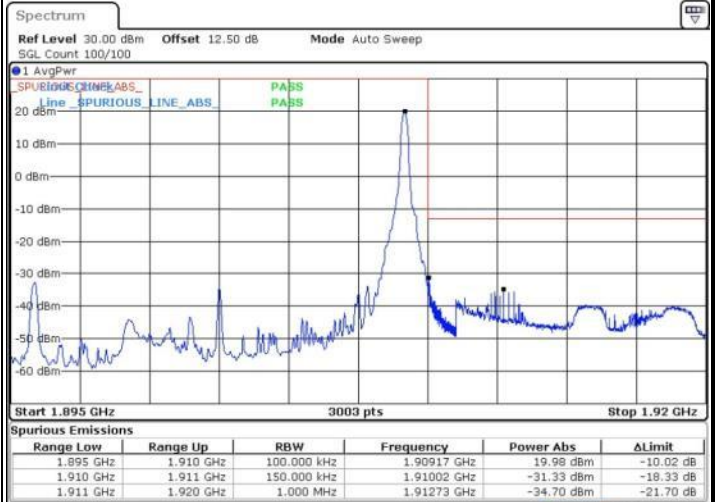

Date: 9 AUG 2015 09:07:28

Lowest Band Edge / Full RB

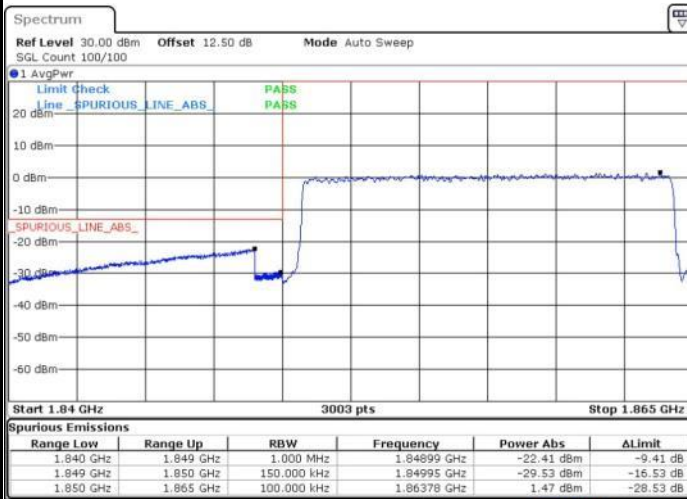

Date: 9 AUG 2015 09:00:07

Highest Band Edge / Full RB

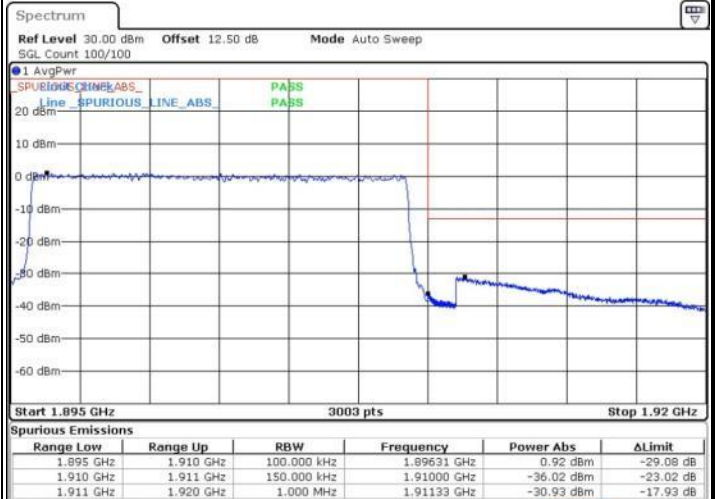

Date: 9 AUG 2015 09:09:46