



FCC/IC RF Test Report

APPLICANT : Sony Mobile Communications Inc.
EQUIPMENT : Smart phone
BRAND NAME : SONY
TYPE NAME : PM-0860-BV
FCC ID : PY7-PM0860
IC : 4170B-PM0860
STANDARD : FCC Part 15 Subpart E §15.407
IC RSS-210 issue 8
CLASSIFICATION : (NII) Unlicensed National Information Infrastructure

The product was received on Dec. 31, 2014 and testing was completed on Jan. 22, 2015. We, SPORTON INTERNATIONAL INC., would like to declare that the tested sample has been evaluated in accordance with the test procedures and has been in compliance with the applicable technical standards.

The test results in this report apply exclusively to the tested model / sample. Without written approval of SPORTON INTERNATIONAL INC., the test report shall not be reproduced except in full.

Reviewed by: Joseph Lin / Supervisor

Approved by: Jones Tsai / Manager



SPORTON INTERNATIONAL INC.

No. 52, Hwa Ya 1st Rd., Hwa Ya Technology Park, Kwei-Shan District, Tao Yuan City, Taiwan, R.O.C.



TABLE OF CONTENTS

REVISION HISTORY..... 3

SUMMARY OF TEST RESULT 4

1 GENERAL DESCRIPTION 5

 1.1 Applicant 5

 1.2 Manufacturer..... 5

 1.3 Feature of Equipment Under Test 5

 1.4 Product Specification of Equipment Under Test..... 6

 1.5 Modification of EUT 7

 1.6 Testing Location 8

 1.7 Applicable Standards..... 8

2 TEST CONFIGURATION OF EQUIPMENT UNDER TEST 9

 2.1 Carrier Frequency Channel 9

 2.2 Pre-Scanned RF Power..... 10

 2.3 Test Mode..... 11

 2.4 Connection Diagram of Test System..... 12

 2.5 Support Unit used in test configuration and system 13

 2.6 EUT Operation Test Setup 13

 2.7 Measurement Results Explanation Example..... 13

3 TEST RESULT..... 14

 3.1 26dB & 99% Occupied Bandwidth Measurement 14

 3.2 Maximum Conducted Output Power Measurement 16

 3.3 Power Spectral Density Measurement 18

 3.4 Unwanted Radiated Emission Measurement 21

 3.5 AC Conducted Emission Measurement..... 27

 3.6 Frequency Stability Measurement..... 33

 3.7 Automatically Discontinue Transmission 34

 3.8 Antenna Requirements..... 35

4 LIST OF MEASURING EQUIPMENTS..... 36

5 UNCERTAINTY OF EVALUATION 38

APPENDIX A. CONDUCTED TEST RESULTS

APPENDIX B. RADIATED TEST RESULTS



REVISION HISTORY

REPORT NO.	VERSION	DESCRIPTION	ISSUED DATE
FR4D3145E	Rev. 01	Initial issue of report	Mar. 16, 2015

**SUMMARY OF TEST RESULT**

Report Section	FCC Rule	IC Rule	Description	Limit	Result	Remark
3.1	2.1049 15.403(i)	RSS-210 A9.2	26dB & 99% Bandwidth	-	Pass	-
3.2	15.407(a)	RSS-210 A9.2	Maximum Conducted Output Power	FCC \leq 24dBm (depend on band) IC RSS-210 A9.2 Limit	Pass	-
3.3	15.407(a)	RSS-210 A9.2	Power Spectral Density	FCC \leq 11dBm (depend on band) IC RSS-210 A9.2 Limit	Pass	-
3.4	15.407(b)	RSS-210 A9.3	Unwanted Emissions	\leq -17, -27 dBm (depend on band)&15.209(a)	Pass	Under limit -3.18 dB at 5470.000 MHz
3.5	15.207	RSS-Gen 7.2.4	AC Conducted Emission	15.207(a)	Pass	Under limit 12.70 dB at 2.686 MHz
3.6	15.407(g)	-	Frequency Stability	Within Operation Band	Pass	-
3.7	15.407(c)	RSS-210 A9.4	Automatically Discontinue Transmission	Discontinue Transmission	Pass	-
3.8	15.203 & 15.407(a)	RSS-210 A9.2	Antenna Requirement	N/A	Pass	-



1 General Description

1.1 Applicant

Sony Mobile Communications Inc.
Nya Vattentorget, 22188 Lund, Sweden

1.2 Manufacturer

Arima Communications Corp.
6F, No. 866, Jhongjheng Rd., Jhonghe Dist., New Taipei City 23586, Taiwan

1.3 Feature of Equipment Under Test

The Equipment Under Test (hereafter called: EUT) is Smart phone supporting, GSM / WCDMA / LTE, Wi-Fi 2.4GHz 802.11 b/g/n, 5GHz 802.11a/n, Bluetooth with FM Receiver, GPS, and NFC features, and below is details of information.

Product Feature	
Equipment	Smart phone
Brand Name	SONY
Type Name	PM-0860-BV
FCC ID	PY7-PM0860
IC	4170B-PM0860
GSM Operating Band(s)	GSM 850/900/1800/1900MHz
GPRS / EGPRS Multi Slot Class	GPRS Class 12, EGPRS Class 12
WCDMA Operating Band(s)	FDD Band I / II / IV / V / VIII
WCDMA Rel. Version	Rel. 8
LTE Operating Band(s)	FDD Band II / IV / V / VII / XII / XIII / XVII
LTE Rel. Version	Rel. 8
Wi-Fi Specification	802.11a/b/g/n (HT20/HT40)
Bluetooth Version	v3.0+EDR / v4.0-LE
NFC Specification	ISO14443A / ISO14443B / Felica
Power Supply	Battery / AC Adapter / Car Charger

Remark: The above EUT's information was declared by manufacturer. Please refer to the specifications or user's manual for more detailed description.



1.4 Product Specification of Equipment Under Test

Product Specification subjective to this standard	
Tx/Rx Frequency Range	5180 MHz ~ 5240 MHz 5260 MHz ~ 5320 MHz 5500 MHz ~ 5580 MHz and 5660 MHz ~ 5700 MHz
Maximum Output Power to Antenna	<5180 MHz ~ 5240 MHz> 802.11a : 13.95 dBm / 0.0248 W 802.11n HT20 : 11.25 dBm / 0.0133 W 802.11n HT40 : 11.38 dBm / 0.0137 W <5260 MHz ~ 5320 MHz> 802.11a : 13.98 dBm / 0.0250 W 802.11n HT20 : 11.45 dBm / 0.0140 W 802.11n HT40 : 11.49 dBm / 0.0141 W <5500 MHz ~ 5580 MHz and 5660 MHz ~ 5700 MHz> 802.11a : 13.98 dBm / 0.0250 W 802.11n HT20 : 11.42 dBm / 0.0139 W 802.11n HT40 : 11.40 dBm / 0.0138 W
99% Occupied Bandwidth	802.11a : 17.85 MHz 802.11n HT20 : 18.50 MHz 802.11n HT40 : 36.70 MHz
Antenna Type	<5180 MHz ~ 5240 MHz> PIFA Antenna with gain -7.00 dBi <5260 MHz ~ 5320 MHz> PIFA Antenna with gain -6.50 dBi <5500 MHz ~ 5580 MHz and 5660 MHz ~ 5700 MHz> PIFA Antenna with gain -7.00 dBi
Type of Modulation	OFDM (BPSK / QPSK / 16QAM / 64QAM)



EUT Information List				
IMEI	HW Version	SW Version	S/N	Performed Test Item
IMEI : 004402453631198	A	27.1.A.0.38	RV4C13D10724	RF conducted measurement
IMEI : 004402453631180			RV4C13D10872	Radiated Spurious Emission Conducted Emission

Accessory List	
AC Adapter	Model No. : EP800
	Type No. : AC-0030-US
	S/N : 3113W46622783 for Radiation Spurious Emission 3114W37321262 for Conducted Emission
Battery	Model No. : Ram
Earphone	Model No. : MH410c
	Type No. : AG-1103
	S/N : 1411204C00BC7D0 for Radiation Spurious Emission 1411204C00BCC46 for Conducted Emission
USB Cable 1	Model No. : EC450
	Type No. : AI-0700
	S/N : 143912D8330504A

Note:

- 1. Above EUT list and accessory list used are electrically identical per declared by manufacturer.
- 2. Above the accessories list are used to exercise the EUT during test.
- 3. For other wireless features of this EUT, test report will be issued separately.

1.5 Modification of EUT

No modifications are made to the EUT during all test items.



1.6 Testing Location

Sporton Lab is accredited to ISO 17025 by Taiwan Accreditation Foundation (TAF code : 1190) and the FCC designation No. TW1022 under the FCC 2.948(e) by Mutual Recognition Agreement (MRA) in FCC Test.

Test Site	SPORTON INTERNATIONAL INC.			
Test Site Location	No. 52, Hwa Ya 1 st Rd., Hwa Ya Technology Park, Kwei-Shan District, Tao Yuan City, Taiwan, R.O.C. TEL: +886-3-327-3456 FAX: +886-3-328-4978			
Test Site No.	Sporton Site No.			IC Registration No.
	TH02-HY	CO05-HY	03CH06-HY	4086B-1

Note: The test site complies with ANSI C63.4 2009 requirement.

1.7 Applicable Standards

According to the specifications of the manufacturer, the EUT must comply with the requirements of the following standards:

- ♦ FCC Part 15 Subpart E
- ♦ FCC KDB 789033 D02 General UNII Test Procedures New Rules v01
- ♦ ANSI C63.10-2013
- ♦ IC RSS-210 Issued 8
- ♦ IC RSS-Gen Issue 4
- ♦ NOTICE 2012-DRS0126

Remark:

1. All test items were verified and recorded according to the standards and without any deviation during the test.
2. FCC permits the use of the 1.5 meter table as an alternative in C63.10-2013 through inquiry tracking number 961829.
3. This EUT has also been tested and complied with the requirements of FCC Part 15, Subpart B, recorded in a separate test report.
4. Per the section 2.2.3 of Notice of 2012-DRS0126, “ Receivers Excluded from Industry Canada Requirements”, only radiocommunication receivers operating in stand-alone mode within the band 30-960 MHz and scanner receivers are subject to Industry Canada requirements.



2 Test Configuration of Equipment Under Test

The EUT has been associated with peripherals and configuration operated in a manner tended to maximize its emission characteristics in a typical application. Frequency range investigated: conducted emission (150 kHz to 30 MHz) and radiated emission (9 kHz to the 10th harmonic of the highest fundamental frequency or to 40 GHz, whichever is lower). For radiated measurement, pre-scanned in three orthogonal panels, X, Y, Z. The worst cases (X plane) were recorded in this report.

The final configuration from all the combinations and the worst-case data rates were investigated by measuring the maximum power across all the data rates and modulation modes under section 2.2.

Based on the worst configuration found above, the RF power setting is set individually to meet FCC compliance limit for the final conducted and radiated tests shown in section 2.3.

2.1 Carrier Frequency Channel

Frequency Band	Channel	Freq. (MHz)	Channel	Freq. (MHz)
5150-5250 MHz Band 1 (U-NII-1)	36	5180	44	5220
	38	5190	46	5230
	40	5200	48	5240

Frequency Band	Channel	Freq. (MHz)	Channel	Freq. (MHz)
5250-5350 MHz Band 2 (U-NII-2A)	52	5260	60	5300
	54	5270	62	5310
	56	5280	64	5320

Frequency Band	Channel	Freq. (MHz)	Channel	Freq. (MHz)
5470-5600 MHz and 5650-5725 MHz Band 3 (U-NII-2C)	100	5500	116	5580
	102	5510	132	5660
	104	5520	134	5670
	108	5540	136	5680
	110	5550	140	5700
	112	5560		

Note: The above Frequency and Channel in boldface were 802.11n HT40.



2.2 Pre-Scanned RF Power

Preliminary tests were performed in different data rate and data rate associated with the highest power were chosen for full test in the following tables. Final Output Power equals to Measured Output Power adds the duty factor.

5GHz 802.11a mode								
Data Rate (MHz)	6M bps	9M bps	12M bps	18M bps	24M bps	36M bps	48M bps	54M bps
Average Power (dBm)	13.98	13.95	13.89	13.96	13.84	13.94	13.93	13.92

5GHz 802.11n HT20 mode								
Data Rate (MHz)	MCS0	MCS1	MCS2	MCS3	MCS4	MCS5	MCS6	MCS7
Average Power (dBm)	11.45	11.43	11.38	11.36	11.41	11.43	11.36	11.42

5GHz 802.11n HT40 mode								
Data Rate (MHz)	MCS0	MCS1	MCS2	MCS3	MCS4	MCS5	MCS6	MCS7
Average Power (dBm)	11.49	11.42	11.43	11.42	11.40	11.45	11.48	11.40



2.3 Test Mode

Final test mode of conducted test items and radiated spurious emissions are considering the modulation and worse data rates from the power table described in section 2.2.

Modulation	Data Rate
802.11a	6 Mbps
802.11n HT20	MCS0
802.11n HT40	MCS0

AC Conducted Emission	Mode 1 : GSM1900 Idle + Bluetooth Link + WLAN Link + Earphone + USB Cable (Charging from Adapter) + Camera + Battery
------------------------------	--

Ch. #		Band I : 5150-5250 MHz	Band II : 5250-5350 MHz	Band III : 5470-5600 MHz and 5650-5725MHz
		802.11a	802.11a	802.11a
L	Low	36	52	100
M	Middle	44	60	116
H	High	48	64	140

Ch. #		Band I : 5150-5250 MHz	Band II : 5250-5350 MHz	Band III : 5470-5600 MHz and 5650-5725MHz
		802.11n HT20	802.11n HT20	802.11n HT20
L	Low	36	52	100
M	Middle	44	60	116
H	High	48	64	140

Ch. #		Band I : 5150-5250 MHz	Band II : 5250-5350 MHz	Band III : 5470-5600 MHz and 5650-5725MHz
		802.11n HT40	802.11n HT40	802.11n HT40
L	Low	38	54	102
M	Middle	-	-	110
H	High	46	62	134

2.4 Connection Diagram of Test System

<WLAN Tx Mode>

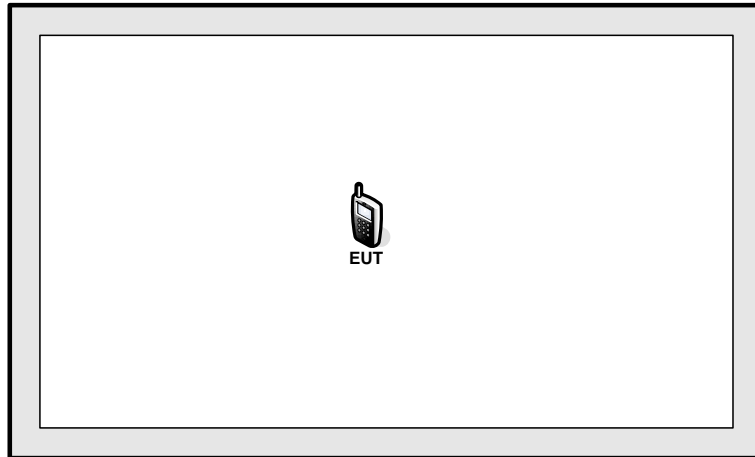

<AC Conducted Emission Mode>

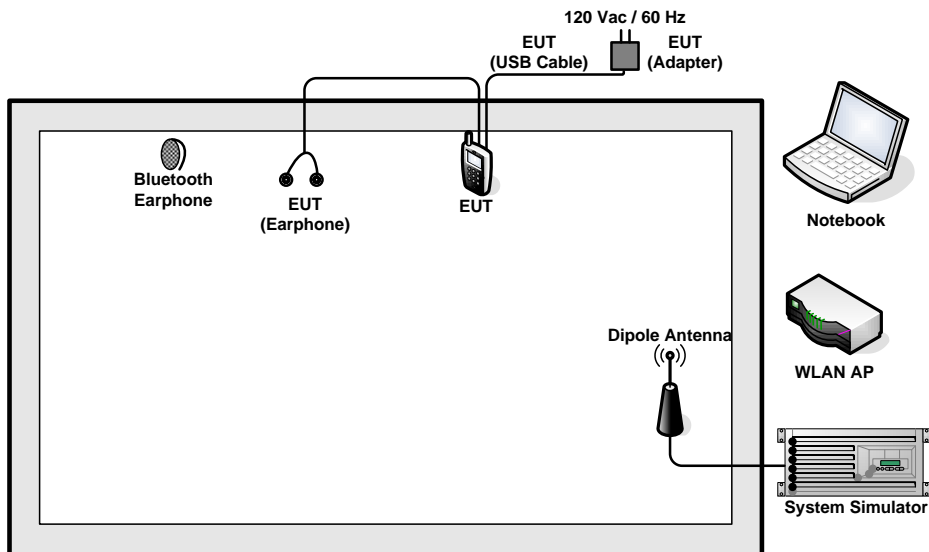



2.5 Support Unit used in test configuration and system

Item	Equipment	Trade Name	Model Name	FCC ID	Data Cable	Power Cord
1.	System Simulator	Anritsu	MT8820C	N/A	N/A	Unshielded, 1.8 m
2.	WLAN AP	D-Link	DIR-628	KA2DIR628A2	N/A	Unshielded, 1.8 m
3.	Bluetooth Earphone	Sony	SBH20	PY7-RD0010	Unshielded, 0.75m	N/A
4.	Notebook	DELL	Latitude E6320	FCC DoC/ Contains FCC ID: QDS-BRCM1054	N/A	AC I/P: Unshielded, 1.2 m DC O/P: Shielded, 1.8 m
5.	SD Card	SanDisk	MicroSD HC	FCC DoC	N/A	N/A

2.6 EUT Operation Test Setup

For WLAN RF test items, an engineering test program was provided and enabled to make EUT continuous transmit/receive.

2.7 Measurement Results Explanation Example

For all conducted test items:

The offset level is set in the spectrum analyzer to compensate the RF cable loss and attenuator factor between EUT conducted output port and spectrum analyzer. With the offset compensation, the spectrum analyzer reading level is exactly the EUT RF output level.

Example :

The spectrum analyzer offset is derived from RF cable loss and attenuator factor.

Offset = RF cable loss + attenuator factor.

Following shows an offset computation example with cable loss 4.2 dB and 10dB attenuator.

$$\begin{aligned} \text{Offset(dB)} &= \text{RF cable loss(dB)} + \text{attenuator factor(dB)}. \\ &= 4.2 + 10 = 14.2 \text{ (dB)} \end{aligned}$$

3 Test Result

3.1 26dB & 99% Occupied Bandwidth Measurement

3.1.1 Description of 26dB & 99% Occupied Bandwidth

This section is for reporting purpose only.

There is no restriction limits for bandwidth.

3.1.2 Measuring Instruments

The measuring equipment is listed in the section 4 of this test report.

3.1.3 Test Procedures

1. The testing follows FCC KDB 789033 D02 General UNII Test Procedures New Rules v01.
Section C) Emission bandwidth
2. Set RBW = approximately 1% of the emission bandwidth.
3. Set the VBW > RBW.
4. Detector = Peak.
5. Trace mode = max hold
6. Measure the maximum width of the emission that is 26 dB down from the peak of the emission.
Compare this with the RBW setting of the analyzer. Readjust RBW and repeat measurement as needed until the RBW/EBW ratio is approximately 1%.
7. For 99% Bandwidth Measurement, the spectrum analyzer's resolution bandwidth (RBW) is set 1MHz and set the Video bandwidth (VBW) $\geq 3 * RBW$.
8. Measure and record the results in the test report.

3.1.4 Test Setup

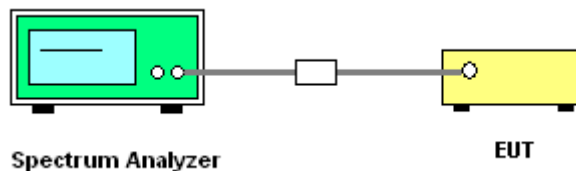



3.1.5 Test Result of 26dB & 99% Occupied Bandwidth Plots

Please refer to Appendix A.

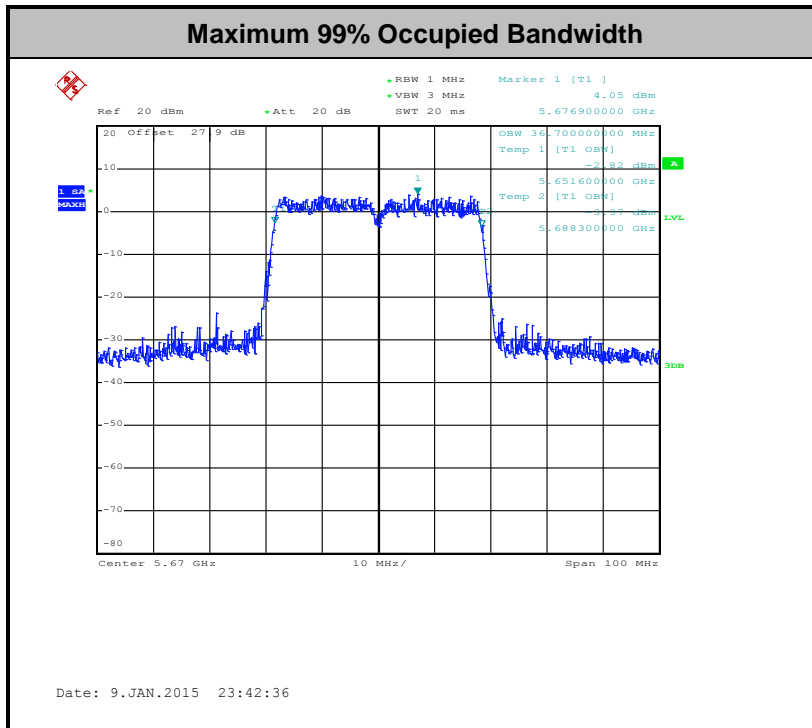
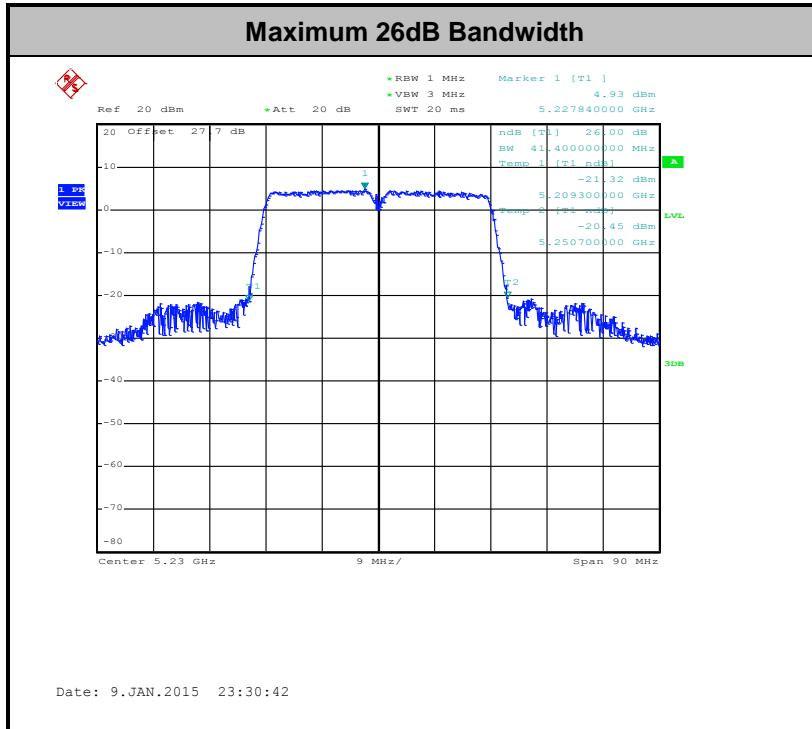

Note : The occupied channel bandwidth is maintained within the band of operation for all of the modulations.



3.2 Maximum Conducted Output Power Measurement

3.2.1 Limit of Maximum Conducted Output Power

For mobile and portable client devices in the 5.15–5.25 GHz band, the maximum conducted output power over the frequency band of operation shall not exceed 250 mW.

For the 5.25–5.35 GHz and 5.47–5.725 GHz bands, the maximum conducted output power over the frequency bands of operation shall not exceed the lesser of 250 mW or 11 dBm 10 log B, where B is the 26 dB emission bandwidth in megahertz.

If transmitting antennas of directional gain greater than 6 dBi are used, the peak output power shall be reduced by the amount in dB that the directional gain of the antenna exceeds 6 dBi.

Note that U-NII-2 band, devices with a maximum e.i.r.p. greater than 500 mW shall implement TPC in order to have the capability to operate at least 6 dB below the maximum permitted e.i.r.p. of 1 W.

3.2.2 Measuring Instruments

The measuring equipment is listed in the section 4 of this test report.

3.2.3 Test Procedures

The testing follows Method PM of FCC KDB 789033 D02 General UNII Test Procedures New Rules v01.

Method PM (Measurement using an RF average power meter):

1. Measurement is performed using a wideband RF power meter.
2. The EUT is configured to transmit continuously with a consistent duty cycle at its maximum power control level.
3. Measure the average power of the transmitter, and the average power is corrected with duty factor, $10 \log(1/x)$, where x is the duty cycle.

3.2.4 Test Setup

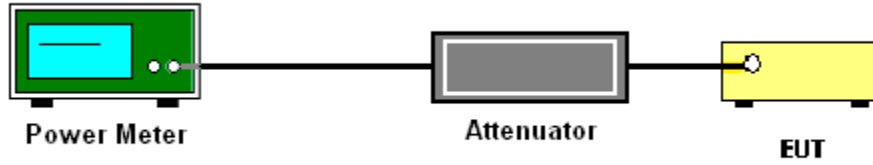

3.2.5 Test Result of Maximum Conducted Output Power

Please refer to Appendix A.



3.3 Power Spectral Density Measurement

3.3.1 Limit of Power Spectral Density

For mobile and portable client devices in the 5.15–5.25 GHz band, the maximum power spectral density shall not exceed 11dBm in any 1 megahertz band.

For the 5.25–5.35 GHz and 5.47–5.725 GHz bands, the maximum power spectral density shall not exceed 11 dBm in any 1 megahertz band.

If transmitting antennas of directional gain greater than 6 dBi are used, the peak output power shall be reduced by the amount in dB that the directional gain of the antenna exceeds 6 dBi.

3.3.2 Measuring Instruments

The measuring equipment is listed in the section 4 of this test report.

3.3.3 Test Procedures

The testing follows FCC KDB 789033 D02 General UNII Test Procedures New Rules v01.
Section F) Maximum power spectral density.

Method SA-2

(trace averaging across on and off times of the EUT transmissions, followed by duty cycle correction).

1. The testing follows Method SA-2 of FCC KDB 789033 D02 General UNII Test Procedures New Rules v01.
 - Measure the duty cycle.
 - Set span to encompass the entire emission bandwidth (EBW) of the signal.
 - Set RBW = 1 MHz.
 - Set VBW \geq 3 MHz.
 - Number of points in sweep \geq 2 Span / RBW.
 - Sweep time = auto.
 - Detector = RMS
 - Trace average at least 100 traces in power averaging mode.
 - Add $10 \log(1/x)$, where x is the duty cycle, to the measured power in order to compute the average power during the actual transmission times. For example, add $10 \log(1/0.25) = 6$ dB if the duty cycle is 25 percent.
2. The RF output of EUT was connected to the spectrum analyzer by a low loss cable.
3. Each plot has already offset with cable loss, and attenuator loss. Measure the PPSD and record it.

3.3.4 Test Setup

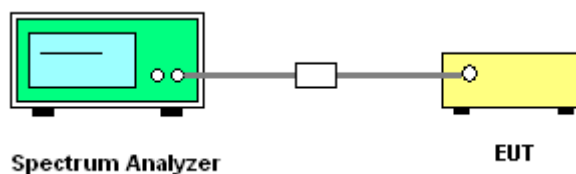



3.3.5 Test Result of Power Spectral Density

Please refer to Appendix A.

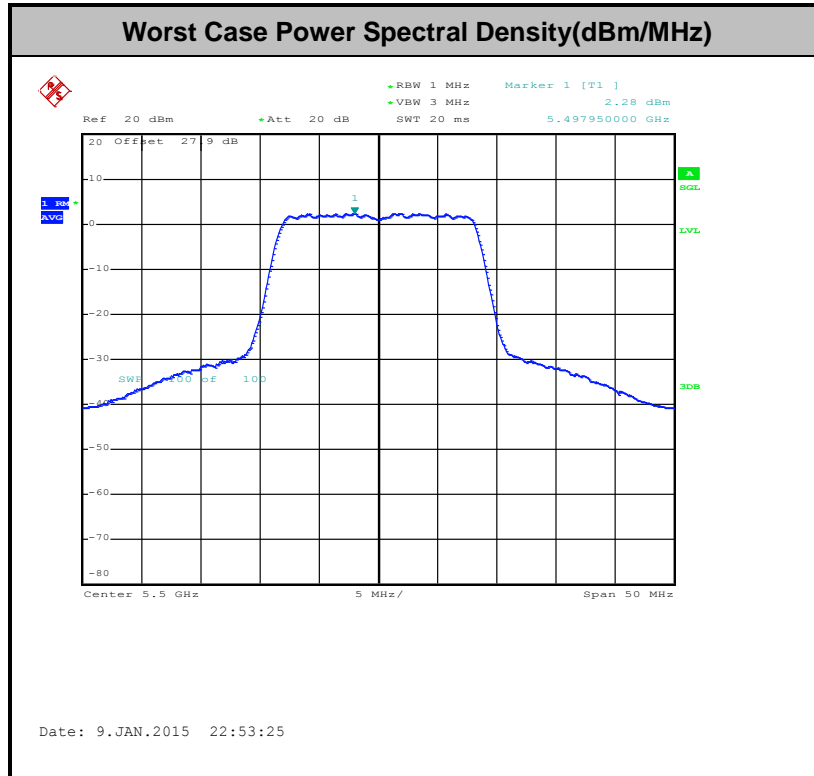

Note: Average Power Density (dB) = Measured value+ Duty Factor



3.4 Unwanted Radiated Emission Measurement

This section as specified in FCC Part 15.407(b) is to measure unwanted emissions through radiated measurement for band edge spurious emissions and out of band emissions measurement. The unwanted emissions shall comply with 15.407(b)(1) to (6), and restricted bands per FCC Part15.205.

3.4.1 Limit of Unwanted Emissions

(1) For transmitters operating in the 5150-5250 MHz band: all emissions outside of the 5150-5350 MHz band shall not exceed an EIRP of -27dBm/MHz.

For transmitters operating in the 5250-5350 MHz band: all emissions outside of the 5150-5350 MHz band shall not exceed an EIRP of -27 dBm/MHz. Devices operating in the 5250-5350 MHz band that generate emissions in the 5150-5250 MHz band must meet all applicable technical requirements for operation in the 5150-5250 MHz band (including indoor use) or alternatively meet an out-of-band emission EIRP limit of -27 dBm/MHz in the 5150-5250 MHz band.

For transmitters operating in the 5470-5600 MHz and 5650-5725MHz band: all emissions outside of the 5470-5600 MHz and 5650-5725MHz band shall not exceed an EIRP of -27 dBm/MHz.

(2) Unwanted spurious emissions fallen in restricted bands per FCC Part15.205 shall comply with the general field strength limits set forth in § 15.209 as below table,

Frequency (MHz)	Field Strength (microvolts/meter)	Measurement Distance (meters)
0.009 – 0.490	2400/F(kHz)	300
0.490 – 1.705	24000/F(kHz)	30
1.705 – 30.0	30	30
30 – 88	100	3
88 – 216	150	3
216 - 960	200	3
Above 960	500	3

Note: The following formula is used to convert the EIRP to field strength.

$$E = \frac{1000000\sqrt{30P}}{3} \mu V/m, \text{ where } P \text{ is the eirp (Watts)}$$



EIRP (dBm)	Field Strength at 3m (dBµV/m)
-17	78.3
- 27	68.3

(3) KDB789033 v01 G)2)c) As specified in 15.407(b), emissions above 1000 MHz that are outside of the restricted bands are subject to a peak emission limit of -27 dBm/MHz (or -17 dBm/MHz as specified in 15.407(b)(4)). However, an out-of-band emission that complies with both the average and peak limits of 15.209 is not required to satisfy the -27 dBm/MHz or -17 dBm/MHz peak emission limit.

3.4.2 Measuring Instruments

The measuring equipment is listed in the section 4 of this test report.



3.4.3 Test Procedures

1. The testing follows FCC KDB 789033 D02 General UNII Test Procedures New Rules v01. Section G) Unwanted emissions measurement.

(1) Procedure for Unwanted Emissions Measurements Below 1000MHz

- RBW = 120 kHz
- VBW = 300 kHz
- Detector = Peak
- Trace mode = max hold

(2) Procedure for Peak Unwanted Emissions Measurements Above 1000 MHz

- RBW = 1 MHz
- VBW ≥ 3 MHz
- Detector = Peak
- Sweep time = auto
- Trace mode = max hold

(3) Procedures for Average Unwanted Emissions Measurements Above 1000MHz

- RBW = 1 MHz
- VBW = 10 Hz, when duty cycle is no less than 98 percent.
- VBW ≥ 1/T, when duty cycle is less than 98 percent where T is the minimum transmission duration over which the transmitter is on and is transmitting at its maximum power control level for the tested mode of operation.

Band	Duty Cycle(%)	T(μs)	1/T(kHz)	VBW Setting
802.11a	89.17	1400	0.71	1kHz
802.11n HT20	88.44	1300	0.77	1kHz
802.11n HT40	79.56	654	1.53	3kHz

2. The EUT was placed on a turntable with 0.8 meter for frequency below 1GHz and 1.5 meter for frequency above 1GHz respectively above ground.
3. The EUT was set 3 meters from the interference receiving antenna which was mounted on the top of a variable height antenna tower.
4. The antenna is a broadband antenna and its height is adjusted between one meter and four meters above ground to find the maximum value of the field strength for both horizontal polarization and vertical polarization of the antenna.
5. For each suspected emission, the EUT was arranged to its worst case and then adjust the antenna tower (from 1 m to 4 m) and turntable (from 0 degree to 360 degrees) to find the

maximum reading.

6. For testing below 1GHz, if the emission level of the EUT in peak mode was 3 dB lower than the limit specified, then peak values of EUT will be reported, otherwise, the emissions will be repeated one by one using the CISPR quasi-peak method and reported.
7. For testing above 1GHz, the emission level of the EUT in peak mode was 20dB lower than average limit (that means the emission level in average mode also complies with the limit in average mode), then peak values of EUT will be reported, otherwise, the emissions will be measured in average mode again and reported.

3.4.4 Test Setup

For radiated emissions below 30MHz

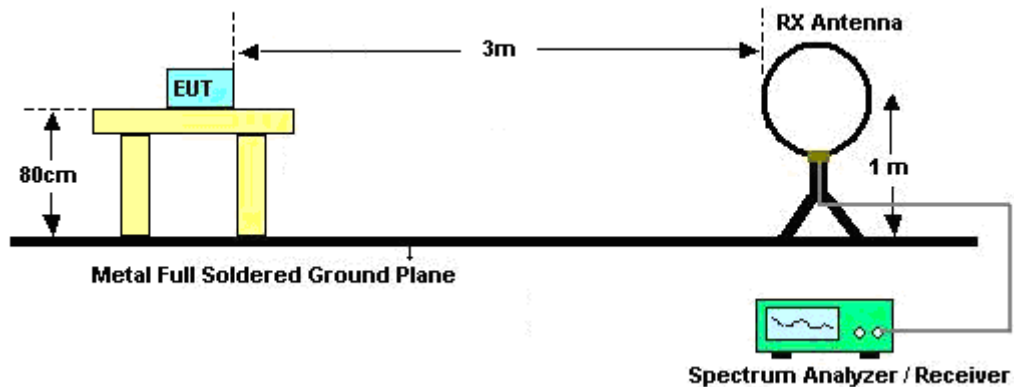

For radiated emissions from 30MHz to 1GHz

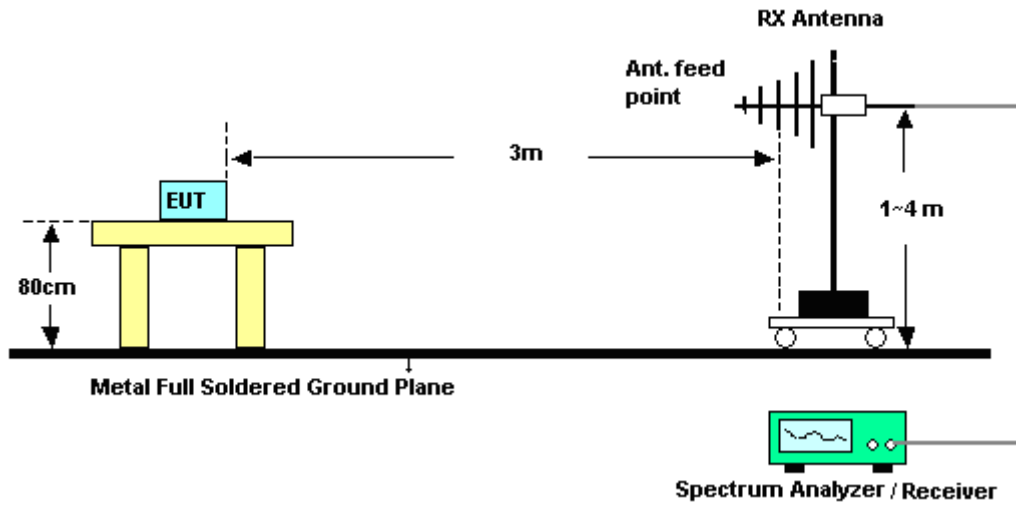

For radiated emissions above 1GHz

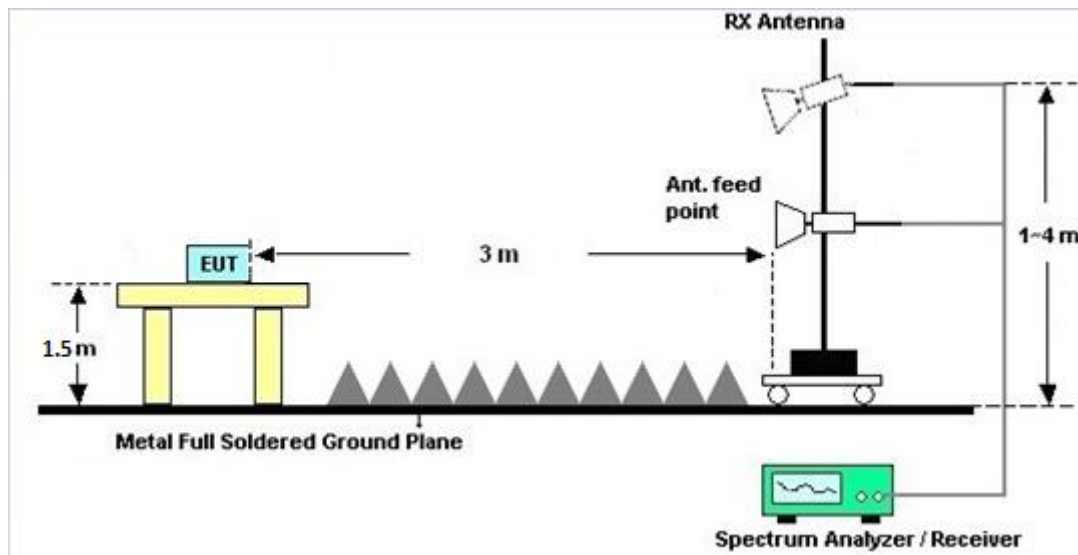

3.4.5 Test Results of Radiated Emissions (9 kHz ~ 30 MHz)

The low frequency, which started from 9 kHz to 30MHz, was pre-scanned and the result which was 20dB lower than the limit line per 15.31(o) was not reported.



3.4.6 Test Result of Radiated Band Edges

Please refer to Appendix B.

3.4.7 Test Result of Unwanted Radiated Emission (30MHz ~ 10th Harmonic)

Please refer to Appendix B.



3.5 AC Conducted Emission Measurement

3.5.1 Limit of AC Conducted Emission

For equipment that is designed to be connected to the public utility (AC) power line, the radio frequency voltage that is conducted back onto the AC power line on any frequency or frequencies within the band 150 kHz to 30 MHz shall not exceed the limits in the following table.

Frequency of emission (MHz)	Conducted limit (dB μ V)	
	Quasi-peak	Average
0.15-0.5	66 to 56*	56 to 46*
0.5-5	56	46
5-30	60	50

*Decreases with the logarithm of the frequency.

3.5.2 Measuring Instruments

The measuring equipment is listed in the section 4 of this test report.

3.5.3 Test Procedures

1. The EUT was placed 0.4 meter from the conducting wall of the shielding room was kept at least 80 centimeters from any other grounded conducting surface.
2. Connect EUT to the power mains through a line impedance stabilization network (LISN).
3. All the support units are connecting to the other LISN.
4. The LISN provides 50 ohm coupling impedance for the measuring instrument.
5. The FCC states that a 50 ohm, 50 microhenry LISN should be used.
6. Both sides of AC line were checked for maximum conducted interference.
7. The frequency range from 150 kHz to 30 MHz was searched.
8. Set the test-receiver system to Peak Detect Function and specified bandwidth with Maximum Hold Mode.

3.5.4 Test Setup

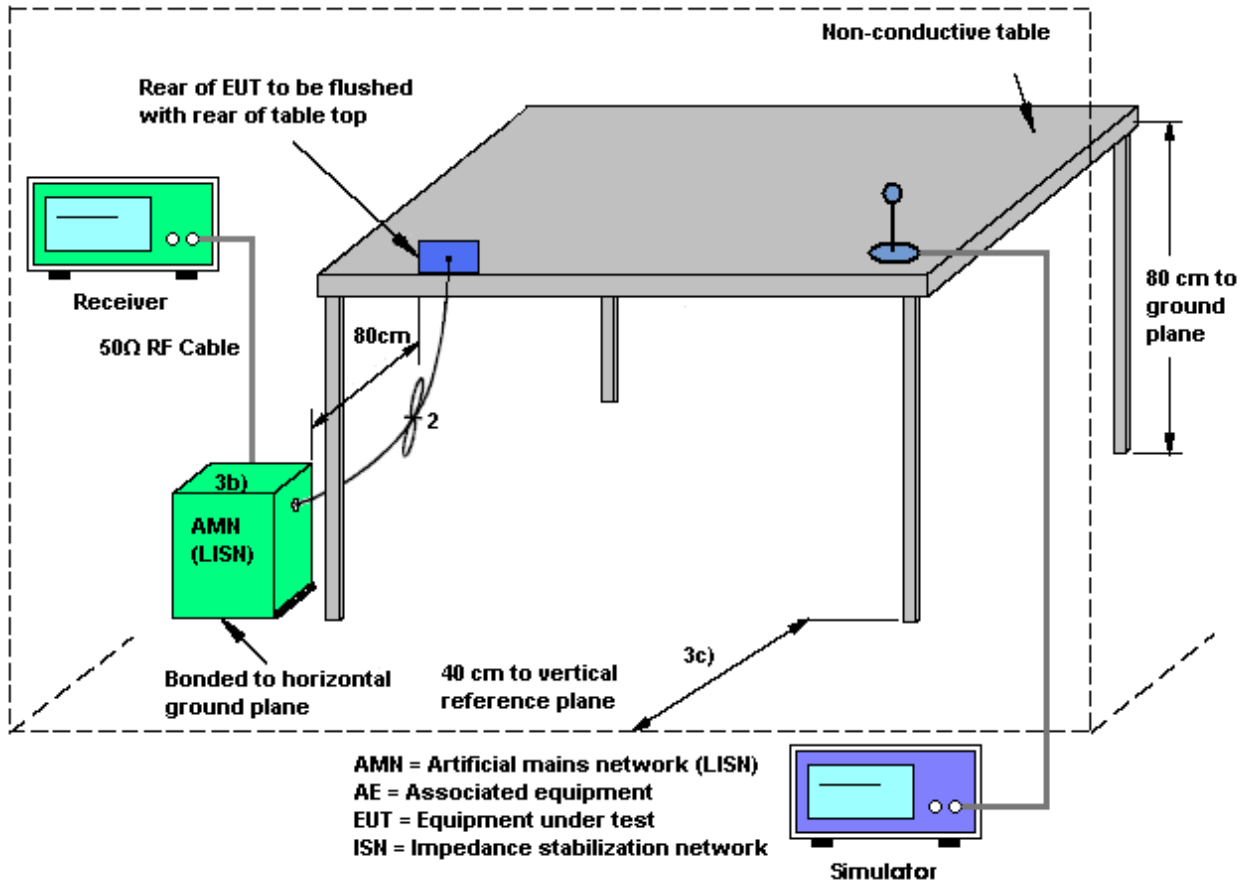



3.5.5 Test Result of AC Conducted Emission

Test Mode :	Mode 1	Temperature :	21~23°C
Test Engineer :	Eric Jeng	Relative Humidity :	46~48%
Test Voltage :	120Vac / 60Hz	Phase :	Line
Function Type :	GSM1900 Idle + Bluetooth Link + WLAN Link + Earphone + USB Cable (Charging from Adapter) + Camera + Battery		

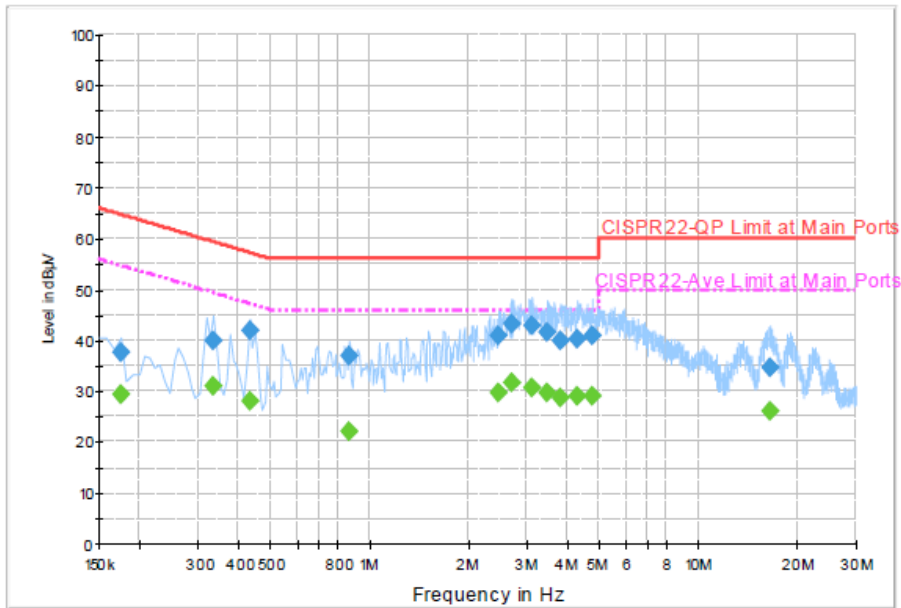

Final Result : QuasiPeak

Frequency (MHz)	QuasiPeak (dBµV)	Filter	Line	Corr. (dB)	Margin (dB)	Limit (dBµV)
0.174000	37.5	Off	L1	19.4	27.3	64.8
0.334000	39.8	Off	L1	19.4	19.6	59.4
0.430000	41.8	Off	L1	19.5	15.5	57.3
0.862000	36.9	Off	L1	19.5	19.1	56.0
2.470000	41.1	Off	L1	19.6	14.9	56.0
2.686000	43.3	Off	L1	19.7	12.7	56.0
3.118000	42.9	Off	L1	19.6	13.1	56.0
3.470000	41.7	Off	L1	19.6	14.3	56.0
3.774000	40.0	Off	L1	19.7	16.0	56.0
4.278000	40.3	Off	L1	19.7	15.7	56.0
4.734000	40.8	Off	L1	19.7	15.2	56.0
16.406000	34.7	Off	L1	19.8	25.3	60.0



Test Mode :	Mode 1	Temperature :	21~23°C
Test Engineer :	Eric Jeng	Relative Humidity :	46~48%
Test Voltage :	120Vac / 60Hz	Phase :	Line
Function Type :	GSM1900 Idle + Bluetooth Link + WLAN Link + Earphone + USB Cable (Charging from Adapter) + Camera + Battery		

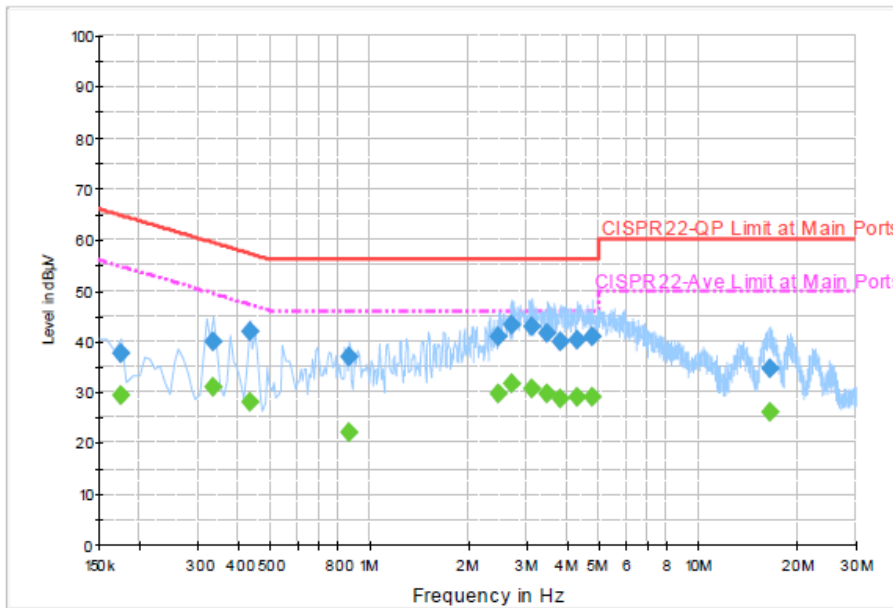

Final Result : Average

Frequency (MHz)	Average (dBµV)	Filter	Line	Corr. (dB)	Margin (dB)	Limit (dBµV)
0.174000	29.4	Off	L1	19.4	25.4	54.8
0.334000	31.2	Off	L1	19.4	18.2	49.4
0.430000	28.2	Off	L1	19.5	19.1	47.3
0.862000	22.0	Off	L1	19.5	24.0	46.0
2.470000	29.7	Off	L1	19.6	16.3	46.0
2.686000	31.6	Off	L1	19.7	14.4	46.0
3.118000	30.5	Off	L1	19.6	15.5	46.0
3.470000	29.6	Off	L1	19.6	16.4	46.0
3.774000	28.9	Off	L1	19.7	17.1	46.0
4.278000	29.1	Off	L1	19.7	16.9	46.0
4.734000	29.1	Off	L1	19.7	16.9	46.0
16.406000	26.0	Off	L1	19.8	24.0	50.0



Test Mode :	Mode 1	Temperature :	21~23°C
Test Engineer :	Eric Jeng	Relative Humidity :	46~48%
Test Voltage :	120Vac / 60Hz	Phase :	Neutral
Function Type :	GSM1900 Idle + Bluetooth Link + WLAN Link + Earphone + USB Cable (Charging from Adapter) + Camera + Battery		

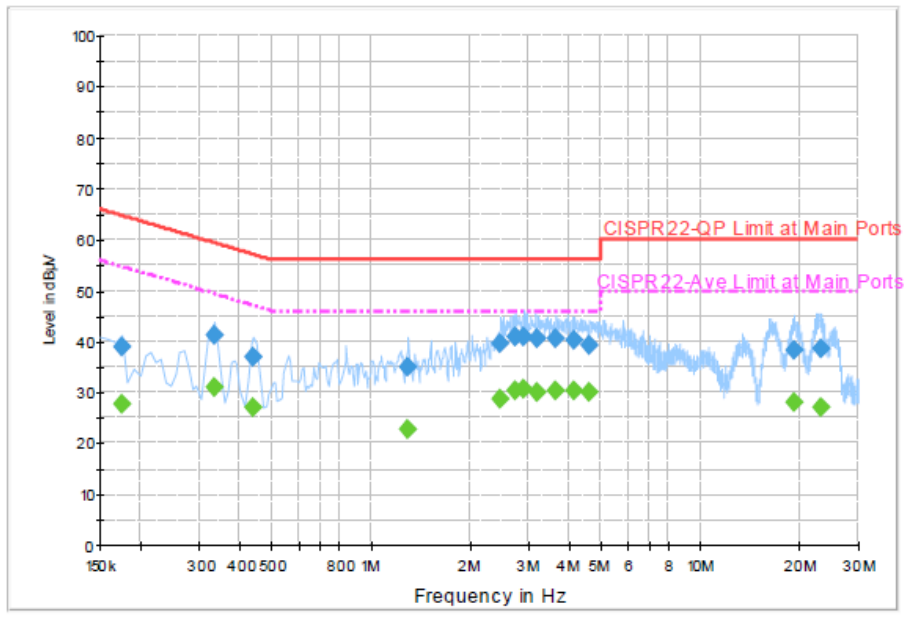

Final Result : QuasiPeak

Frequency (MHz)	QuasiPeak (dBµV)	Filter	Line	Corr. (dB)	Margin (dB)	Limit (dBµV)
0.174000	39.0	Off	N	19.4	25.8	64.8
0.334000	41.1	Off	N	19.4	18.3	59.4
0.438000	36.9	Off	N	19.5	20.2	57.1
1.294000	34.9	Off	N	19.6	21.1	56.0
2.462000	39.6	Off	N	19.6	16.4	56.0
2.742000	41.1	Off	N	19.6	14.9	56.0
2.910000	40.9	Off	N	19.6	15.1	56.0
3.198000	40.6	Off	N	19.6	15.4	56.0
3.638000	40.6	Off	N	19.6	15.4	56.0
4.142000	40.1	Off	N	19.6	15.9	56.0
4.598000	39.3	Off	N	19.7	16.7	56.0
19.294000	38.3	Off	N	20.0	21.7	60.0
23.038000	38.7	Off	N	20.0	21.3	60.0



Test Mode :	Mode 1	Temperature :	21~23°C
Test Engineer :	Eric Jeng	Relative Humidity :	46~48%
Test Voltage :	120Vac / 60Hz	Phase :	Neutral
Function Type :	GSM1900 Idle + Bluetooth Link + WLAN Link + Earphone + USB Cable (Charging from Adapter) + Camera + Battery		

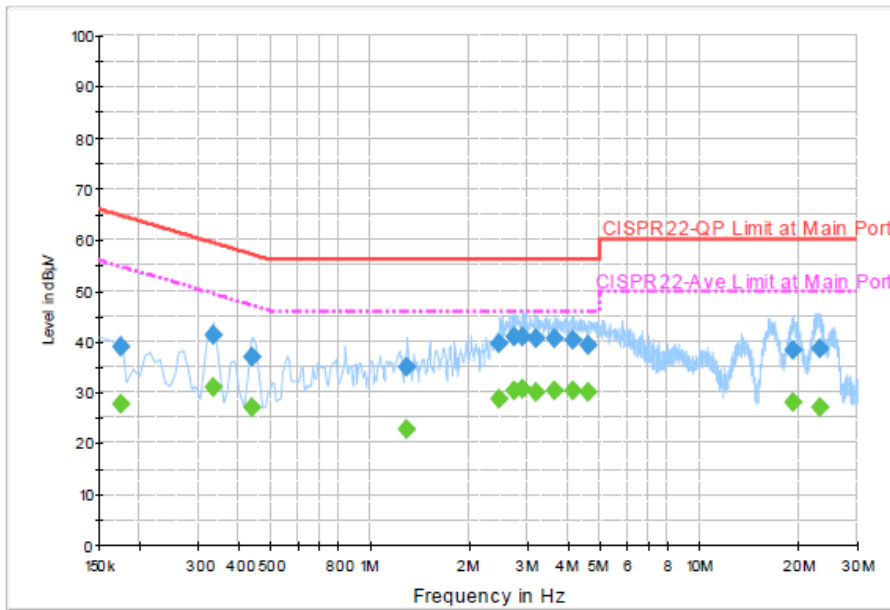

Final Result : Average

Frequency (MHz)	Average (dBµV)	Filter	Line	Corr. (dB)	Margin (dB)	Limit (dBµV)
0.174000	27.8	Off	N	19.4	27.0	54.8
0.334000	31.0	Off	N	19.4	18.4	49.4
0.438000	27.0	Off	N	19.5	20.1	47.1
1.294000	22.8	Off	N	19.6	23.2	46.0
2.462000	28.8	Off	N	19.6	17.2	46.0
2.742000	30.3	Off	N	19.6	15.7	46.0
2.910000	30.7	Off	N	19.6	15.3	46.0
3.198000	29.9	Off	N	19.6	16.1	46.0
3.638000	30.3	Off	N	19.6	15.7	46.0
4.142000	30.4	Off	N	19.6	15.6	46.0
4.598000	30.0	Off	N	19.7	16.0	46.0
19.294000	28.1	Off	N	20.0	21.9	50.0
23.038000	26.9	Off	N	20.0	23.1	50.0

3.6 Frequency Stability Measurement

3.6.1 Limit of Frequency Stability

Manufacturers of U-NII devices are responsible for ensuring frequency stability such that an emission is maintained within the band of operation under all conditions of normal operation as specified in the user's manual.

3.6.2 Measuring Instruments

The measuring equipment is listed in the section 4 of this test report.

3.6.3 Test Procedures

1. To ensure emission at the band edge is maintained within the authorized band, those values shall be measured by radiation emissions at upper and lower frequency points, and finally compensated by frequency deviation as procedures below.
2. The EUT was operated at the maximum output power, and connected to the spectrum analyzer, which is set to maximum hold function and peak detector. The peak value of the power envelope was measured and noted. The upper and lower frequency points were respectively measured relatively 10dB lower than the measured peak value.
3. The frequency deviation was calculated by adding the upper frequency point and the lower frequency point divided by two. Those detailed values of frequency deviation are provided in table below.

3.6.4 Test Setup



3.6.5 Test Result of Frequency Stability

Please refer to Appendix A.



3.7 Automatically Discontinue Transmission

3.7.1 Limit of Automatically Discontinue Transmission

The device shall automatically discontinue transmission in case of either absence of information to transmit or operational failure. These provisions are not intended to preclude the transmission of control or signaling information or the use of repetitive codes used by certain digital technologies to complete frame or burst intervals. Applicants shall include in their application for equipment authorization to describe how this requirement is met.

3.7.2 Measuring Instruments

The measuring equipment is listed in the section 4 of this test report.

3.7.3 Test Result of Automatically Discontinue Transmission

While the EUT is not transmitting any information, the EUT can automatically discontinue transmission and become standby mode for power saving. The EUT can detect the controlling signal of ACK message transmitting from remote device and verify whether it shall resend or discontinue transmission.



3.8 Antenna Requirements

3.8.1 Standard Applicable

According to FCC 47 CFR Section 15.407(a)(1)(2) ,if transmitting antenna directional gain is greater than 6 dBi, both the peak transmit power and the peak power spectral density shall be reduced by the amount in dB that the directional gain of the antenna exceeds 6 dBi.

3.8.2 Antenna Anti-Replacement Construction

An embedded-in antenna design is used.

3.8.3 Antenna Gain

The antenna gain is less than 6 dBi. Therefore, it is not necessary to reduce maximum peak output power limit.



4 List of Measuring Equipments

Instrument	Manufacturer	Model No.	Serial No.	Characteristics	Calibration Date	Test Date	Due Date	Remark
Spectrum Analyzer	Rohde & Schwarz	FSP40	100055	9kHz~40GHz	Jun. 09, 2014	Jan. 02, 2015~ Jan. 22, 2015	Jun. 08, 2015	Conducted (TH02-HY)
Power Meter	Anritsu	ML2495A	1036004	300MHz~40GHz	Aug. 09, 2014	Jan. 02, 2015~ Jan. 22, 2015	Aug. 08, 2015	Conducted (TH02-HY)
Power Sensor	Anritsu	MA2411B	1027253	300MHz~40GHz	Aug. 11, 2014	Jan. 02, 2015~ Jan. 22, 2015	Aug. 10, 2015	Conducted (TH02-HY)
Hygrometer	Testo	608-H1	34897199	N/A	May 06, 2014	Jan. 02, 2015~ Jan. 22, 2015	May 05, 2015	Conducted (TH02-HY)
RF cable	WOKEN	S05	S05-130708-038	0.1MHz~40GHz	Jan. 22, 2014	Jan. 02, 2015~ Jan. 20, 2015	Jan. 21, 2015	Conducted (TH02-HY)
RF cable	WOKEN	S05	S05-130708-038	0.1MHz~40GHz	Jan. 21, 2015	Jan. 21, 2015~ Jan. 22, 2015	Jan. 20, 2016	Conducted (TH02-HY)
Spectrum Analyzer	Agilent	E4408B	MY44211028	9kHz ~ 26.5GHz	Aug. 23, 2014	Jan. 07, 2015~ Jan. 15, 2015	Aug. 22, 2015	Radiation (03CH06-HY)
EMI Test Receiver	Rohde & Schwarz	ESU26	100390	20Hz~26.5GHz	Dec. 15 2014	Jan. 07, 2015~ Jan. 15, 2015	Dec. 14, 2015	Radiation (03CH06-HY)
EMI Test Receiver	R&S	ESVS10	834468/0003	20MHz ~ 1000MHz	May 06, 2014	Jan. 07, 2015~ Jan. 15, 2015	May 05, 2015	Radiation (03CH06-HY)
Loop Antenna	R&S	HFH2-Z2	100315	9 kHz~30 MHz	Jul. 28, 2014	Jan. 07, 2015~ Jan. 15, 2015	Jul. 27, 2015	Radiation (03CH06-HY)
Bilog Antenna	Teseq GmbH	CBL6112D	35379	30MHz -2GHz	Sep. 27, 2014	Jan. 07, 2015~ Jan. 15, 2015	Sep. 26, 2015	Radiation (03CH06-HY)
Double Ridge Horn Antenna	EMCO	3117	00066583	1GHz ~ 18GHz	Jul. 24, 2014	Jan. 07, 2015~ Jan. 15, 2015	Jul. 23, 2015	Radiation (03CH06-HY)
SHF-EHF Horn Antenna	SCHWARZBECK	BBHA 9170	BBHA9170251	18GHz- 40GHz	Oct. 02, 2014	Jan. 07, 2015~ Jan. 15, 2015	Oct. 01, 2015	Radiation (03CH06-HY)
Amplifier	SONOMA	310N	186713	9kHz ~ 1GHz	Apr. 16, 2014	Jan. 07, 2015~ Jan. 15, 2015	Apr. 15, 2015	Radiation (03CH06-HY)
Preamplifier	MITEQ	AMF-7D-0010 1800-30-10P	1815698	1GHz~18GHz	Dec. 12, 2014	Jan. 07, 2015~ Jan. 15, 2015	Dec. 11, 2015	Radiation (03CH06-HY)
Preamplifier	MITEQ	JS44-180040 00-33-8P	1840917	18GHz ~ 40GHz	Jun. 09, 2014	Jan. 07, 2015~ Jan. 15, 2015	Jun. 08, 2015	Radiation (03CH06-HY)
Preamplifier	Agilent	8449B	3008A01917	1GHz ~ 26.5GHz	Apr. 10, 2014	Jan. 07, 2015~ Jan. 15, 2015	Apr. 09, 2015	Radiation (03CH06-HY)
Controller	INN-CO	CO2000	8000604	N/A	N/A	Jan. 07, 2015~ Jan. 15, 2015	N/A	Radiation (03CH06-HY)
Turn Table	INN-CO	DS2000	420/650/00	0 ~ 360 degree	N/A	Jan. 07, 2015~ Jan. 15, 2015	N/A	Radiation (03CH06-HY)
Antenna Mast	MF	MF-7802	MF780208212	1 m ~ 4 m	N/A	Jan. 07, 2015~ Jan. 15, 2015	N/A	Radiation (03CH06-HY)
RF Cable	HUBER + SUHNER	RG 142	NA	30MHz ~ 1GHz	Nov. 27, 2014	Jan. 07, 2015~ Jan. 15, 2015	Nov. 26, 2015	Radiation (03CH06-HY)
RF Cable	Infinet	LL142	Infinet CA3601-3601-10 00	1GHz ~ 26.5GHz	Nov. 27, 2014	Jan. 07, 2015~ Jan. 15, 2015	Nov. 26, 2015	Radiation (03CH06-HY)



Instrument	Manufacturer	Model No.	Serial No.	Characteristics	Calibration Date	Test Date	Due Date	Remark
RF Cable	HUBER + SUHNER	SUCOFLEX 104	MY8420952 1	9KHz~1GHz	Dec. 04, 2014	Jan. 07, 2015~ Jan. 15, 2015	Dec. 03, 2015	Radiation (03CH06-HY)
RF Cable	HUBER + SUHNER	SUCOFLEX 104	MY8420952 1	1GHz~40GHz	Dec. 04, 2014	Jan. 07, 2015~ Jan. 15, 2015	Dec. 03, 2015	Radiation (03CH06-HY)
Filter	Wainwright	WLKS4500-8SS	SN19	4.5G Low Pass	Oct. 01, 2014	Jan. 07, 2015~ Jan. 15, 2015	Sep. 30, 2015	Radiation (03CH06-HY)
Filter	Microwave Circuits	H07G18G3	282388	7G High Pass	Oct. 01, 2014	Jan. 07, 2015~ Jan. 15, 2015	Sep. 30, 2015	Radiation (03CH06-HY)
Hygrometer	WISEWIND	410	BU5004	N/A	May 06, 2014	Jan. 07, 2015~ Jan. 15, 2015	May 05, 2015	Radiation (03CH06-HY)
Test Software	Audix	E3	Version 6.2009-8-24	N/A	N/A	Jan. 07, 2015~ Jan. 15, 2015	N/A	Radiation (03CH06-HY)
EMI Test Receiver	Rohde & Schwarz	ESCS 30	100356	9kHz ~ 2.75GHz	Dec. 01, 2014	Jan. 07, 2015	Nov. 30, 2015	Conduction (CO05-HY)
LISN (for auxiliary equipment)	Rohde & Schwarz	ENV216	100081	9kHz ~ 30MHz	Dec. 08, 2014	Jan. 07, 2015	Dec. 07, 2015	Conduction (CO05-HY)
LISN	Rohde & Schwarz	ENV216	100080	9kHz ~ 30MHz	Dec. 02, 2014	Jan. 07, 2015	Dec. 01, 2015	Conduction (CO05-HY)
AC Power Source	ChainTek	APC-1000W	N/A	N/A	N/A	Jan. 07, 2015	N/A	Conduction (CO05-HY)
Test Software	N/A	EMC32	8.40.0	N/A	N/A	Jan. 07, 2015	N/A	Conduction (CO05-HY)
Hygrometer	Testo	608-H1	34913912	N/A	Apr. 23, 2014	Jan. 07, 2015	Apr. 22, 2015	Conduction (CO05-HY)
LF Cable	Shuner	RG-402	N/A	N/A	Oct. 07, 2014	Jan. 07, 2015	Oct. 06, 2015	Conduction (CO05-HY)

Note: Test equipment calibration is traceable to the procedure of ISO17025.



5 Uncertainty of Evaluation

Uncertainty of Conducted Emission Measurement (150kHz ~ 30MHz)

Measuring Uncertainty for a Level of Confidence of 95% ($U = 2Uc(y)$)	2.26
---	------

Uncertainty of Radiated Emission Measurement (30 MHz ~ 1000 MHz)

Measuring Uncertainty for a Level of Confidence of 95% ($U = 2Uc(y)$)	4.50
---	------

Test Engineer:	Bill Kuo	Temperature:	21~25	°C
Test Date:	Jan. 02, 2015 ~ Jan. 22, 2015	Relative Humidity:	51~54	%

TEST RESULTS DATA
26dB and 99% OBW

Band I										
Mod.	Data Rate	NTX	CH.	Freq. (MHz)	99% Bandwidth (MHz)	26 dB Bandwidth (MHz)	IC 99% Bandwidth Power Limit (dBm)	IC 99% Bandwidth EIRP Limit (dBm)		
11a	6Mbps	1	36	5180	17.75	23.05	-	22.49		
11a	6Mbps	1	44	5220	17.80	22.15	-	22.50		
11a	6Mbps	1	48	5240	17.75	22.00	-	22.49		
HT20	MCS0	1	36	5180	18.50	22.45	-	22.67		
HT20	MCS0	1	44	5220	18.45	21.80	-	22.66		
HT20	MCS0	1	48	5240	18.50	21.70	-	22.67		
HT40	MCS0	1	38	5190	36.50	41.31	-	23.01		
HT40	MCS0	1	46	5230	36.60	41.40	-	23.01		

TEST RESULTS DATA
Average Power Table

FCC Band I										
Mod.	Data Rate	N _{TX}	CH.	Freq. (MHz)	Duty Factor (dB)	Average Conducted Power (dBm)	FCC Conducted Power Limit (dBm)	DG (dBi)		Pass/Fail
11a	6Mbps	1	36	5180	0.50	13.87	24.00	-7.00		Pass
11a	6Mbps	1	44	5220	0.50	13.95	24.00	-7.00		Pass
11a	6Mbps	1	48	5240	0.50	13.92	24.00	-7.00		Pass
HT20	MCS0	1	36	5180	0.53	11.25	24.00	-7.00		Pass
HT20	MCS0	1	44	5220	0.53	11.14	24.00	-7.00		Pass
HT20	MCS0	1	48	5240	0.53	11.17	24.00	-7.00		Pass
HT40	MCS0	1	38	5190	0.99	11.38	24.00	-7.00		Pass
HT40	MCS0	1	46	5230	0.99	11.14	24.00	-7.00		Pass

IC Band I										
Mod.	Data Rate	N _{TX}	CH.	Freq. (MHz)	Duty Factor (dB)	Average Conducted Power (dBm)	IC Conducted Power Limit (dBm)	DG (dBi)	IC EIRP Power Limit (dBm)	Pass/Fail
11a	6Mbps	1	36	5180	0.50	13.87	29.49	-7.00	22.49	Pass
11a	6Mbps	1	44	5220	0.50	13.95	29.50	-7.00	22.50	Pass
11a	6Mbps	1	48	5240	0.50	13.92	29.49	-7.00	22.49	Pass
HT20	MCS0	1	36	5180	0.53	11.25	29.67	-7.00	22.67	Pass
HT20	MCS0	1	44	5220	0.53	11.14	29.66	-7.00	22.66	Pass
HT20	MCS0	1	48	5240	0.53	11.17	29.67	-7.00	22.67	Pass
HT40	MCS0	1	38	5190	0.99	11.38	30.01	-7.00	23.01	Pass
HT40	MCS0	1	46	5230	0.99	11.14	30.01	-7.00	23.01	Pass

TEST RESULTS DATA
Power Spectral Density

FCC Band I										
Mod.	Data Rate	NTX	CH.	Freq. (MHz)	Duty Factor (dB)	Average Power Density (dBm/MHz)	Average PSD Limit (dBm/MHz)	DG (dBi)	-	Pass/Fail
11a	6Mbps	1	36	5180	0.50	2.12	11.00	-7.00		Pass
11a	6Mbps	1	44	5220	0.50	2.28	11.00	-7.00		Pass
11a	6Mbps	1	48	5240	0.50	2.20	11.00	-7.00		Pass
HT20	MCS0	1	36	5180	0.53	-0.42	11.00	-7.00		Pass
HT20	MCS0	1	44	5220	0.53	-1.00	11.00	-7.00		Pass
HT20	MCS0	1	48	5240	0.53	-1.12	11.00	-7.00		Pass
HT40	MCS0	1	38	5190	0.99	-3.92	11.00	-7.00		Pass
HT40	MCS0	1	46	5230	0.99	-3.82	11.00	-7.00		Pass

IC Band I										
Mod.	Data Rate	NTX	CH.	Freq. (MHz)	Duty Factor (dB)	Average Power Density (dBm/MHz)	Average PSD Limit (dBm/MHz)	DG (dBi)	IC EIRP PSD Limit (dBm/MHz)	Pass/Fail
11a	6Mbps	1	36	5180	0.50	2.12	17.00	-7.00	10	Pass
11a	6Mbps	1	44	5220	0.50	2.28	17.00	-7.00	10	Pass
11a	6Mbps	1	48	5240	0.50	2.20	17.00	-7.00	10	Pass
HT20	MCS0	1	36	5180	0.53	-0.42	17.00	-7.00	10	Pass
HT20	MCS0	1	44	5220	0.53	-1.00	17.00	-7.00	10	Pass
HT20	MCS0	1	48	5240	0.53	-1.12	17.00	-7.00	10	Pass
HT40	MCS0	1	38	5190	0.99	-3.92	17.00	-7.00	10	Pass
HT40	MCS0	1	46	5230	0.99	-3.82	17.00	-7.00	10	Pass

TEST RESULTS DATA
26dB and 99% OBW

Band II										
Mod.	Data Rate	NTX	CH.	Freq. (MHz)	99% Bandwidth (MHz)	26 dB Bandwidth (MHz)	IC 99% Bandwidth Power Limit (dBm)	IC 99% Bandwidth EIRP Limit (dBm)	FCC 26dB Bandwidth Power Limit (dBm)	Note
11a	6Mbps	1	52	5260	17.85	22.65	23.52	29.52	23.98	
11a	6Mbps	1	60	5300	17.7	21.7	23.48	29.48	23.98	
11a	6Mbps	1	64	5320	17.7	21.6	23.48	29.48	23.98	
HT20	MCS0	1	52	5260	18.5	22.15	23.67	29.67	23.98	
HT20	MCS0	1	60	5300	18.4	21.9	23.65	29.65	23.98	
HT20	MCS0	1	64	5320	18.45	21.9	23.66	29.66	23.98	
HT40	MCS0	1	54	5270	36.5	41.22	23.98	30.00	23.98	
HT40	MCS0	1	62	5310	36.6	41.31	23.98	30.00	23.98	

TEST RESULTS DATA
Average Power Table

FCC Band II										
Mod.	Data Rate	NTX	CH.	Freq. (MHz)	Duty Factor (dB)	Average Conducted Power (dBm)	FCC Conducted Power Limit (dBm)	DG (dBi)		Pass/Fail
11a	6Mbps	1	52	5260	0.50	13.83	23.98	-6.50		Pass
11a	6Mbps	1	60	5300	0.50	13.95	23.98	-6.50		Pass
11a	6Mbps	1	64	5320	0.50	13.98	23.98	-6.50		Pass
HT20	MCS0	1	52	5260	0.53	11.45	23.98	-6.50		Pass
HT20	MCS0	1	60	5300	0.53	11.31	23.98	-6.50		Pass
HT20	MCS0	1	64	5320	0.53	11.29	23.98	-6.50		Pass
HT40	MCS0	1	54	5270	0.99	11.49	23.98	-6.50		Pass
HT40	MCS0	1	62	5310	0.99	10.45	23.98	-6.50		Pass

IC Band II										
Mod.	Data Rate	NTX	CH.	Freq. (MHz)	Duty Factor (dB)	Average Conducted Power (dBm)	IC Conducted Power Limit (dBm)	DG (dBi)	IC EIRP Power Limit (dBm)	Pass/Fail
11a	6Mbps	1	52	5260	0.50	13.83	23.52	-6.50	29.52	Pass
11a	6Mbps	1	60	5300	0.50	13.95	23.48	-6.50	29.48	Pass
11a	6Mbps	1	64	5320	0.50	13.98	23.48	-6.50	29.48	Pass
HT20	MCS0	1	52	5260	0.53	11.45	23.67	-6.50	29.67	Pass
HT20	MCS0	1	60	5300	0.53	11.31	23.65	-6.50	29.65	Pass
HT20	MCS0	1	64	5320	0.53	11.29	23.66	-6.50	29.66	Pass
HT40	MCS0	1	54	5270	0.99	11.49	23.98	-6.50	30.00	Pass
HT40	MCS0	1	62	5310	0.99	10.45	23.98	-6.50	30.00	Pass

TEST RESULTS DATA
Power Spectral Density

Band II										
Mod.	Data Rate	NTX	CH.	Freq. (MHz)	Duty Factor (dB)	Average Power Density (dBm/MHz)	Average PSD Limit (dBm/MHz)	DG (dBi)		Pass/Fail
11a	6Mbps	1	52	5260	0.50	2.28	11.00	-6.50		Pass
11a	6Mbps	1	60	5300	0.50	1.96	11.00	-6.50		Pass
11a	6Mbps	1	64	5320	0.50	2.07	11.00	-6.50		Pass
HT20	MCS0	1	52	5260	0.53	-0.42	11.00	-6.50		Pass
HT20	MCS0	1	60	5300	0.53	-0.90	11.00	-6.50		Pass
HT20	MCS0	1	64	5320	0.53	-0.81	11.00	-6.50		Pass
HT40	MCS0	1	54	5270	0.99	-4.03	11.00	-6.50		Pass
HT40	MCS0	1	62	5310	0.99	-4.52	11.00	-6.50		Pass

TEST RESULTS DATA
26dB and 99% OBW

Band III										
Mod.	Data Rate	NTX	CH.	Freq. (MHz)	99% Bandwidth (MHz)	26 dB Bandwidth (MHz)	IC 99% Bandwidth Power Limit (dBm)	IC 99% Bandwidth EIRP Limit (dBm)	FCC 26dB Bandwidth Power Limit (dBm)	Note
11a	6Mbps	1	100	5500	17.7	21.4	23.48	29.48	23.98	
11a	6Mbps	1	116	5580	17.65	21.5	23.47	29.47	23.98	
11a	6Mbps	1	140	5700	17.6	21.3	23.46	29.46	23.98	
HT20	MCS0	1	100	5500	18.4	21.95	23.65	29.65	23.98	
HT20	MCS0	1	116	5580	18.45	21.7	23.66	29.66	23.98	
HT20	MCS0	1	140	5700	18.5	21.65	23.67	29.67	23.98	
HT40	MCS0	1	102	5510	36.5	41.22	23.98	30.00	23.98	
HT40	MCS0	1	110	5550	36.6	41.4	23.98	30.00	23.98	
HT40	MCS0	1	134	5670	36.7	41.13	23.98	30.00	23.98	

TEST RESULTS DATA
Average Power Table

FCC Band III										
Mod.	Data Rate	NTX	CH.	Freq. (MHz)	Duty Factor (dB)	Average Conducted Power (dBm)	FCC Conducted Power Limit (dBm)	DG (dBi)		Pass/Fail
11a	6Mbps	1	100	5500	0.50	13.97	23.98	-7.00		Pass
11a	6Mbps	1	116	5580	0.50	13.98	23.98	-7.00		Pass
11a	6Mbps	1	140	5700	0.50	13.88	23.98	-7.00		Pass
HT20	MCS0	1	100	5500	0.53	11.42	23.98	-7.00		Pass
HT20	MCS0	1	116	5580	0.53	11.40	23.98	-7.00		Pass
HT20	MCS0	1	140	5700	0.53	11.28	23.98	-7.00		Pass
HT40	MCS0	1	102	5510	0.99	11.20	23.98	-7.00		Pass
HT40	MCS0	1	110	5550	0.99	11.40	23.98	-7.00		Pass
HT40	MCS0	1	134	5670	0.99	11.31	23.98	-7.00		Pass

IC Band III										
Mod.	Data Rate	NTX	CH.	Freq. (MHz)	Duty Factor (dB)	Average Conducted Power (dBm)	IC Conducted Power Limit (dBm)	DG (dBi)	IC EIRP Power Limit (dBm)	Pass/Fail
11a	6Mbps	1	100	5500	0.50	13.97	23.48	-7.00	29.48	Pass
11a	6Mbps	1	116	5580	0.50	13.98	23.47	-7.00	29.47	Pass
11a	6Mbps	1	140	5700	0.50	13.88	23.46	-7.00	29.46	Pass
HT20	MCS0	1	100	5500	0.53	11.42	23.65	-7.00	29.65	Pass
HT20	MCS0	1	116	5580	0.53	11.40	23.66	-7.00	29.66	Pass
HT20	MCS0	1	140	5700	0.53	11.28	23.67	-7.00	29.67	Pass
HT40	MCS0	1	102	5510	0.99	11.20	23.98	-7.00	30.00	Pass
HT40	MCS0	1	110	5550	0.99	11.40	23.98	-7.00	30.00	Pass
HT40	MCS0	1	134	5670	0.99	11.31	23.98	-7.00	30.00	Pass

TEST RESULTS DATA
Power Spectral Density

Band III										
Mod.	Data Rate	NTX	CH.	Freq. (MHz)	Duty Factor (dB)	Average Power Density (dBm/MHz)	Average PSD Limit (dBm/MHz)	DG (dBi)		Pass/Fail
11a	6Mbps	1	100	5500	0.50	2.78	11.00	-7.00		Pass
11a	6Mbps	1	116	5580	0.50	2.15	11.00	-7.00		Pass
11a	6Mbps	1	140	5700	0.50	2.19	11.00	-7.00		Pass
HT20	MCS0	1	100	5500	0.53	-0.51	11.00	-7.00		Pass
HT20	MCS0	1	116	5580	0.53	-0.64	11.00	-7.00		Pass
HT20	MCS0	1	140	5700	0.53	-0.63	11.00	-7.00		Pass
HT40	MCS0	1	102	5510	0.99	-3.27	11.00	-7.00		Pass
HT40	MCS0	1	110	5550	0.99	-3.65	11.00	-7.00		Pass
HT40	MCS0	1	134	5670	0.99	-3.95	11.00	-7.00		Pass

TEST RESULTS DATA
Frequency Stability

Band I										
Mod.	Data Rate	NTX	CH.	Freq. (MHz)	Center Frequency (MHz)	Frequency Deviation (MHz)	Frequency Stability (ppm)	Temperature (°C)	Voltage (V)	Note
11a	6Mbps	1	36	5180	5180.000	0.000	0.00	20	3.2	
11a	6Mbps	1	36	5180	5180.000	0.000	0.00	20	4.2	
11a	6Mbps	1	36	5180	5180.000	0.000	0.00	20	3.7	
11a	6Mbps	1	36	5180	5180.000	0.000	0.00	-30	3.7	
11a	6Mbps	1	36	5180	5180.000	0.000	0.00	50	3.7	

Band II										
Mod.	Data Rate	NTX	CH.	Freq. (MHz)	Center Frequency (MHz)	Frequency Deviation (MHz)	Frequency Stability (ppm)	Temperature (°C)	Voltage (V)	Note
11a	6Mbps	1	64	5320	5320.000	0.000	0.00	20	3.2	
11a	6Mbps	1	64	5320	5320.000	0.000	0.00	20	4.2	
11a	6Mbps	1	64	5320	5320.000	0.000	0.00	20	3.7	
11a	6Mbps	1	64	5320	5320.000	0.000	0.00	-30	3.7	
11a	6Mbps	1	64	5320	5320.000	0.000	0.00	50	3.7	

Band III										
Mod.	Data Rate	NTX	CH.	Freq. (MHz)	Center Frequency (MHz)	Frequency Deviation (MHz)	Frequency Stability (ppm)	Temperature (°C)	Voltage (V)	Note
11a	6Mbps	1	100	5500	5500.000	0.000	0.00	20	3.2	
11a	6Mbps	1	100	5500	5500.000	0.000	0.00	20	4.2	
11a	6Mbps	1	100	5500	5500.000	0.000	0.00	20	3.7	
11a	6Mbps	1	100	5500	5500.000	0.000	0.00	-30	3.7	
11a	6Mbps	1	100	5500	5500.000	0.000	0.00	50	3.7	



Appendix B. Radiated Spurious Emission

Test Engineer :	Donny Pang	Temperature :	22~24°C
		Relative Humidity :	40~44%

15E Band 1 - 5150~5250MHz

WIFI 802.11a (Band Edge @ 3m)

WIFI	Note	Frequency	Level	Over	Limit	Read	Antenna	Cable	Preamp	Ant	Table	Peak	Pol.	
Ant.				Limit	Line	Level	Factor	Loss	Factor	Pos	Pos	Avg.		
1		(MHz)	(dBμV/m)	(dB)	(dBμV/m)	(dBμV)	(dB/m)	(dB)	(dB)	(cm)	(deg)	(P/A)	(H/V)	
802.11a CH 36 5180MHz		5150	57.12	-16.88	74	47.64	34.65	8.82	33.99	150	118	P	H	
		5148.05	44.59	-9.41	54	35.11	34.65	8.82	33.99	150	118	A	H	
	*	5180	106.28	-	-	96.83	34.68	8.76	33.99	150	118	P	H	
	*	5180	96.53	-	-	87.08	34.68	8.76	33.99	150	118	A	H	
													H	
														H
			5133.65	52.89	-21.11	74	43.37	34.63	8.88	33.99	296	52	P	V
			5027.6	40.81	-13.19	54	31.14	34.53	9.13	33.99	296	52	A	V
	*		5180	100.09	-	-	90.64	34.68	8.76	33.99	296	52	P	V
	*		5180	89.67	-	-	80.22	34.68	8.76	33.99	296	52	A	V
														V
														V
802.11a CH 44 5220MHz		5149.55	54.31	-19.69	74	44.83	34.65	8.82	33.99	161	292	P	H	
		5140.25	43.12	-10.88	54	33.58	34.65	8.88	33.99	161	292	A	H	
	*	5220	106.7	-	-	97.27	34.72	8.7	33.99	161	292	P	H	
	*	5220	96.03	-	-	86.6	34.72	8.7	33.99	161	292	A	H	
			5373.1	55.2	-18.8	74	45.59	34.87	8.72	33.98	161	292	P	H
			5372.66	43.53	-10.47	54	33.92	34.87	8.72	33.98	161	292	A	H
			5125.1	52.51	-21.49	74	42.99	34.63	8.88	33.99	221	11	P	V
			5011.55	40.48	-13.52	54	30.76	34.52	9.19	33.99	221	11	A	V
	*		5220	95.49	-	-	86.06	34.72	8.7	33.99	221	11	P	V
	*		5220	85.25	-	-	75.82	34.72	8.7	33.99	221	11	A	V
			5453.4	52.4	-21.6	74	42.65	34.95	8.78	33.98	221	11	P	V
			5374.2	40.56	-13.44	54	30.94	34.87	8.73	33.98	221	11	A	V



802.11a CH 48 5240MHz	*	5240	108.03	-	-	98.59	34.73	8.7	33.99	150	295	P	H
	*	5240	98.35	-	-	88.91	34.73	8.7	33.99	150	295	A	H
		5393	55.83	-18.17	74	46.2	34.88	8.73	33.98	150	295	P	H
		5392.57	43.95	-10.05	54	34.32	34.88	8.73	33.98	150	295	A	H
													H
													H
	*	5240	95.12	-	-	85.68	34.73	8.7	33.99	151	163	P	V
	*	5240	85.04	-	-	75.6	34.73	8.7	33.99	151	163	A	V
		5366.5	53.28	-20.72	74	43.67	34.87	8.72	33.98	151	163	P	V
		5353.74	40.26	-13.74	54	30.67	34.85	8.72	33.98	151	163	A	V
													V
													V

Remark	1. No other spurious found. 2. All results are PASS against Peak and Average limit line.
--------	---



15E band 1 5150~5250MHz

WIFI 802.11a (Harmonic @ 3m)

WIFI	Note	Frequency	Level	Over	Limit	Read	Antenna	Cable	Preamp	Ant	Table	Peak	Pol.
Ant.				Limit	Line	Level	Factor	Loss	Factor	Pos	Pos	Avg.	
1		(MHz)	(dBμV/m)	(dB)	(dBμV/m)	(dBμV)	(dB/m)	(dB)	(dB)	(cm)	(deg)	(P/A)	(H/V)
802.11a CH 36 5180MHz		8290	46	-28	74	56.85	35.68	12.68	59.21	100	0	P	H
		10360	41.53	-32.47	74	49.36	37.29	12.92	58.04	100	0	P	H
		15540	46.71	-27.29	74	48.32	40.13	17.02	58.76	100	0	P	H
													H
		8290	43.96	-30.04	74	54.81	35.68	12.68	59.21	100	0	P	V
		10360	42.36	-31.64	74	50.19	37.29	12.92	58.04	100	0	P	V
		15540	46.95	-27.05	74	48.56	40.13	17.02	58.76	100	0	P	V
802.11a CH 44 5220MHz		8350	48.81	-25.19	74	59.57	35.66	12.74	59.16	100	0	P	H
		10440	41.18	-32.82	74	48.73	37.35	13.02	57.92	100	0	P	H
		15660	46.8	-27.2	74	48.13	40.26	17.02	58.61	100	0	P	H
													H
		8350	46.53	-27.47	74	57.29	35.66	12.74	59.16	100	0	P	V
		10440	41.07	-32.93	74	48.62	37.35	13.02	57.92	100	0	P	V
		15660	45.65	-28.35	74	46.98	40.26	17.02	58.61	100	0	P	V
802.11a CH 48 5240MHz		8385	48.38	-25.62	74	59.05	35.65	12.8	59.12	100	0	P	H
		10480	42.05	-31.95	74	49.4	37.39	13.09	57.83	100	0	P	H
		15720	47.7	-26.3	74	48.88	40.32	17.03	58.53	100	0	P	H
													H
		8385	47.02	-26.98	74	57.69	35.65	12.8	59.12	100	0	P	V
		10480	42.74	-31.26	74	50.09	37.39	13.09	57.83	100	0	P	V
		15720	46.81	-27.19	74	47.99	40.32	17.03	58.53	100	0	P	V
Remark	1. No other spurious found. 2. All results are PASS against Peak and Average limit line.												



15E band 1 5150~5250MHz

WIFI 802.11n HT20 (Band Edge @ 3m)

WIFI	Note	Frequency	Level	Over	Limit	Read	Antenna	Cable	Preamp	Ant	Table	Peak	Pol.	
Ant.				Limit	Line	Level	Factor	Loss	Factor	Pos	Pos	Avg.		
1		(MHz)	(dBμV/m)	(dB)	(dBμV/m)	(dBμV)	(dB/m)	(dB)	(dB)	(cm)	(deg)	(P/A)	(H/V)	
802.11n HT20 CH 36 5180MHz		5147.9	54.5	-19.5	74	45.02	34.65	8.82	33.99	136	290	P	H	
		5150	41.8	-12.2	54	32.32	34.65	8.82	33.99	136	290	A	H	
	*	5180	102.01	-	-	92.56	34.68	8.76	33.99	136	290	P	H	
	*	5180	93.67	-	-	84.22	34.68	8.76	33.99	136	290	A	H	
													H	
													H	
			5027	52.76	-21.24	74	43.09	34.53	9.13	33.99	100	215	P	V
			5001.05	40.53	-13.47	54	30.83	34.5	9.19	33.99	100	215	A	V
	*		5180	92.65	-	-	83.2	34.68	8.76	33.99	100	215	P	V
	*		5180	82.63	-	-	73.18	34.68	8.76	33.99	100	215	A	V
													V	
													V	
802.11n HT20 CH 44 5220MHz		5096.15	53.03	-20.97	74	43.48	34.6	8.94	33.99	155	296	P	H	
		5140.1	41.38	-12.62	54	31.84	34.65	8.88	33.99	155	296	A	H	
	*	5220	104.18	-	-	94.75	34.72	8.7	33.99	155	296	P	H	
	*	5220	94.25	-	-	84.82	34.72	8.7	33.99	155	296	A	H	
			5372.11	53.44	-20.56	74	43.83	34.87	8.72	33.98	155	296	P	H
			5372.22	42.03	-11.97	54	32.42	34.87	8.72	33.98	155	296	A	H
			5049.35	53.03	-20.97	74	43.4	34.55	9.07	33.99	288	13	P	V
			5014.85	40.42	-13.58	54	30.7	34.52	9.19	33.99	288	13	A	V
	*		5220	93.43	-	-	84	34.72	8.7	33.99	288	13	P	V
	*		5220	83.18	-	-	73.75	34.72	8.7	33.99	288	13	A	V
		5354.29	52.85	-21.15	74	43.26	34.85	8.72	33.98	288	13	P	V	
		5373.21	40.34	-13.66	54	30.73	34.87	8.72	33.98	288	13	A	V	



802.11n HT20 CH 48 5240MHz	*	5240	105.15	-	-	95.71	34.73	8.7	33.99	150	292	P	H
	*	5240	94.78	-	-	85.34	34.73	8.7	33.99	150	292	A	H
		5360.23	54.81	-19.19	74	45.22	34.85	8.72	33.98	150	292	P	H
		5392.46	42.16	-11.84	54	32.53	34.88	8.73	33.98	150	292	A	H
													H
													H
	*	5240	94.01	-	-	84.57	34.73	8.7	33.99	285	15	P	V
	*	5240	83.51	-	-	74.07	34.73	8.7	33.99	285	15	A	V
		5392.13	52.57	-21.43	74	42.94	34.88	8.73	33.98	285	15	P	V
		5375.85	40.32	-13.68	54	30.7	34.87	8.73	33.98	285	15	A	V
													V
													V

Remark	1. No other spurious found. 2. All results are PASS against Peak and Average limit line.
--------	---



15E band 1 5150~5250MHz

WIFI 802.11n HT20 (Harmonic @ 3m)

WIFI	Note	Frequency	Level	Over	Limit	Read	Antenna	Cable	Preamp	Ant	Table	Peak	Pol.
Ant.				Limit	Line	Level	Factor	Loss	Factor	Pos	Pos	Avg.	
1		(MHz)	(dBμV/m)	(dB)	(dBμV/m)	(dBμV)	(dB/m)	(dB)	(dB)	(cm)	(deg)	(P/A)	(H/V)
802.11n HT20 CH 36 5180MHz		8290	47.31	-26.69	74	58.16	35.68	12.68	59.21	100	0	P	H
		10360	41.97	-32.03	74	49.8	37.29	12.92	58.04	100	0	P	H
		15540	45.99	-28.01	74	47.6	40.13	17.02	58.76	100	0	P	H
													H
		8290	45.14	-28.86	74	55.99	35.68	12.68	59.21	100	0	P	V
		10360	42.05	-31.95	74	49.88	37.29	12.92	58.04	100	0	P	V
		15540	47.04	-26.96	74	48.65	40.13	17.02	58.76	100	0	P	V
													V
802.11n HT20 CH 44 5220MHz		8350	48.62	-25.38	74	59.38	35.66	12.74	59.16	100	0	P	H
		10440	41.87	-32.13	74	49.42	37.35	13.02	57.92	100	0	P	H
		15660	46.48	-27.52	74	47.81	40.26	17.02	58.61	100	0	P	H
													H
		8350	46.84	-27.16	74	57.6	35.66	12.74	59.16	100	0	P	V
		10440	41.39	-32.61	74	48.94	37.35	13.02	57.92	100	0	P	V
		15660	46.71	-27.29	74	48.04	40.26	17.02	58.61	100	0	P	V
													V
802.11n HT20 CH 48 5240MHz		8385	49.38	-24.62	74	60.05	35.65	12.8	59.12	100	0	P	H
		10480	42.27	-31.73	74	49.62	37.39	13.09	57.83	100	0	P	H
		15720	45.53	-28.47	74	46.71	40.32	17.03	58.53	100	0	P	H
													H
		8385	47.03	-26.97	74	57.7	35.65	12.8	59.12	100	0	P	V
		10480	42.33	-31.67	74	49.68	37.39	13.09	57.83	100	0	P	V
		15720	46.21	-27.79	74	47.39	40.32	17.03	58.53	100	0	P	V
													V
Remark	1. No other spurious found. 2. All results are PASS against Peak and Average limit line.												



15E band 1 5150~5250MHz

WIFI 802.11n HT40 (Band Edge @ 3m)

WIFI	Note	Frequency	Level	Over	Limit	Read	Antenna	Cable	Preamp	Ant	Table	Peak	Pol.
Ant.				Limit	Line	Level	Factor	Loss	Factor	Pos	Pos	Avg.	
1		(MHz)	(dBμV/m)	(dB)	(dBμV/m)	(dBμV)	(dB/m)	(dB)	(dB)	(cm)	(deg)	(P/A)	(H/V)
802.11n HT40 CH 38 5190MHz		5149.4	68.84	-5.16	74	59.36	34.65	8.82	33.99	153	293	P	H
		5150	49.38	-4.62	54	39.9	34.65	8.82	33.99	153	293	A	H
	*	5190	101.38	-	-	91.93	34.68	8.76	33.99	153	293	P	H
	*	5190	91.22	-	-	81.77	34.68	8.76	33.99	153	293	A	H
		5356.71	53.54	-20.46	74	43.95	34.85	8.72	33.98	153	293	P	H
		5365.73	41.9	-12.1	54	32.29	34.87	8.72	33.98	153	293	A	H
		5147.3	58.69	-15.31	74	49.21	34.65	8.82	33.99	288	235	P	V
		5149.7	44.68	-9.32	54	35.2	34.65	8.82	33.99	288	235	A	V
	*	5190	95.25	-	-	85.8	34.68	8.76	33.99	288	235	P	V
	*	5190	85.58	-	-	76.13	34.68	8.76	33.99	288	235	A	V
		5356.71	52.53	-21.47	74	42.94	34.85	8.72	33.98	288	235	P	V
		5369.03	40.89	-13.11	54	31.28	34.87	8.72	33.98	288	235	A	V
802.11n HT40 CH 46 5230MHz		5088.5	53.1	-20.9	74	43.5	34.58	9.01	33.99	152	278	P	H
		5034.65	41.26	-12.74	54	31.59	34.53	9.13	33.99	152	278	A	H
	*	5230	101.97	-	-	92.53	34.73	8.7	33.99	152	278	P	H
	*	5230	92.05	-	-	82.61	34.73	8.7	33.99	152	278	A	H
		5380.03	53.82	-20.18	74	44.19	34.88	8.73	33.98	152	278	P	H
		5377.72	42.6	-11.4	54	32.97	34.88	8.73	33.98	152	278	A	H
		5033.75	52.94	-21.06	74	43.27	34.53	9.13	33.99	272	13	P	V
		5001.35	40.91	-13.09	54	31.21	34.5	9.19	33.99	272	13	A	V
	*	5230	90.87	-	-	81.43	34.73	8.7	33.99	272	13	P	V
	*	5230	81.41	-	-	71.97	34.73	8.7	33.99	272	13	A	V
		5457.69	53.35	-20.65	74	43.6	34.95	8.78	33.98	272	13	P	V
		5351.98	40.79	-13.21	54	31.2	34.85	8.72	33.98	272	13	A	V
Remark	1. No other spurious found. 2. All results are PASS against Peak and Average limit line.												



15E band 1 5150~5250MHz

WIFI 802.11n HT40 (Harmonic @ 3m)

WIFI	Note	Frequency	Level	Over	Limit	Read	Antenna	Cable	Preamp	Ant	Table	Peak	Pol.
Ant.				Limit	Line	Level	Factor	Loss	Factor	Pos	Pos	Avg.	
1		(MHz)	(dBμV/m)	(dB)	(dBμV/m)	(dBμV)	(dB/m)	(dB)	(dB)	(cm)	(deg)	(P/A)	(H/V)
802.11n HT40 CH 38 5190MHz		8305	48.45	-25.55	74	59.28	35.68	12.68	59.19	100	0	P	H
		10380	41.2	-32.8	74	48.95	37.31	12.95	58.01	100	0	P	H
		15570	48.32	-25.68	74	49.85	40.17	17.02	58.72	100	0	P	H
													H
		8305	45.16	-28.84	74	55.99	35.68	12.68	59.19	100	0	P	V
		10380	41.14	-32.86	74	48.89	37.31	12.95	58.01	100	0	P	V
		15570	47.06	-26.94	74	48.59	40.17	17.02	58.72	100	0	P	V
802.11n HT40 CH 46 5230MHz		8370	48.77	-25.23	74	59.47	35.65	12.77	59.12	100	0	P	H
		10460	42.27	-31.73	74	49.74	37.36	13.06	57.89	100	0	P	H
		15690	45.95	-28.05	74	47.2	40.29	17.03	58.57	100	0	P	H
													H
		8370	47.05	-26.95	74	57.75	35.65	12.77	59.12	100	0	P	V
		10460	42.15	-31.85	74	49.62	37.36	13.06	57.89	100	0	P	V
		15690	46.08	-27.92	74	47.33	40.29	17.03	58.57	100	0	P	V
													V
Remark	1. No other spurious found. 2. All results are PASS against Peak and Average limit line.												



15E Band 2 - 5250~5350MHz

WIFI 802.11a (Band Edge @ 3m)

WIFI	Note	Frequency	Level	Over	Limit	Read	Antenna	Cable	Preamp	Ant	Table	Peak	Pol.	
Ant.				Limit	Line	Level	Factor	Loss	Factor	Pos	Pos	Avg.		
1		(MHz)	(dBμV/m)	(dB)	(dBμV/m)	(dBμV)	(dB/m)	(dB)	(dB)	(cm)	(deg)	(P/A)	(H/V)	
802.11a CH 52 5260MHz		5040.5	53.25	-20.75	74	43.56	34.55	9.13	33.99	133	295	P	H	
		5107.85	41.03	-12.97	54	31.46	34.62	8.94	33.99	133	295	A	H	
	*	5260	107.22	-	-	97.72	34.77	8.71	33.98	133	295	P	H	
	*	5260	97.14	-	-	87.64	34.77	8.71	33.98	133	295	A	H	
													H	
														H
			5045.45	52.51	-21.49	74	42.88	34.55	9.07	33.99	290	216	P	V
			5000.3	40.35	-13.65	54	30.65	34.5	9.19	33.99	290	216	A	V
	*		5260	96.35	-	-	86.85	34.77	8.71	33.98	290	216	P	V
	*		5260	85.92	-	-	76.42	34.77	8.71	33.98	290	216	A	V
														V
														V
802.11a CH 60 5300MHz		5000	53.33	-20.67	74	43.63	34.5	9.19	33.99	147	292	P	H	
		5147	40.8	-13.2	54	31.32	34.65	8.82	33.99	147	292	A	H	
	*	5300	107.28	-	-	97.74	34.8	8.72	33.98	147	292	P	H	
	*	5300	97.68	-	-	88.14	34.8	8.72	33.98	147	292	A	H	
			5352.31	57.28	-16.72	74	47.69	34.85	8.72	33.98	147	292	P	H
			5380.03	45.51	-8.49	54	35.88	34.88	8.73	33.98	147	292	A	H
			5128.4	52.43	-21.57	74	42.91	34.63	8.88	33.99	255	6	P	V
			5007.8	40.31	-13.69	54	30.59	34.52	9.19	33.99	255	6	A	V
	*		5300	96.58	-	-	87.04	34.8	8.72	33.98	255	6	P	V
	*		5300	86.57	-	-	77.03	34.8	8.72	33.98	255	6	A	V
			5372	53.71	-20.29	74	44.1	34.87	8.72	33.98	255	6	P	V
			5361.55	40.67	-13.33	54	31.06	34.87	8.72	33.98	255	6	A	V



802.11a CH 64 5320MHz	*	5320	108.22	-	-	98.66	34.82	8.72	33.98	149	292	P	H
	*	5320	98.01	-	-	88.45	34.82	8.72	33.98	149	292	A	H
		5357.37	59.35	-14.65	74	49.76	34.85	8.72	33.98	149	292	P	H
		5353.41	46.66	-7.34	54	37.07	34.85	8.72	33.98	149	292	A	H
													H
													H
	*	5320	96.95	-	-	87.39	34.82	8.72	33.98	150	38	P	V
	*	5320	86.51	-	-	76.95	34.82	8.72	33.98	150	38	A	V
		5400.93	53.63	-20.37	74	43.98	34.9	8.73	33.98	150	38	P	V
		5399.83	40.86	-13.14	54	31.21	34.9	8.73	33.98	150	38	A	V
													V
													V
Remark	1. No other spurious found. 2. All results are PASS against Peak and Average limit line.												



15E band 2 5250~5350MHz
WIFI 802.11a (Harmonic @ 3m)

WIFI	Note	Frequency	Level	Over	Limit	Read	Antenna	Cable	Preamp	Ant	Table	Peak	Pol.
Ant.				Limit	Line	Level	Factor	Loss	Factor	Pos	Pos	Avg.	
1		(MHz)	(dBμV/m)	(dB)	(dBμV/m)	(dBμV)	(dB/m)	(dB)	(dB)	(cm)	(deg)	(P/A)	(H/V)
802.11a CH 52 5260MHz		8415	48.25	-25.75	74	58.9	35.63	12.81	59.09	100	0	P	H
		10520	41.39	-32.61	74	48.65	37.41	13.12	57.79	100	0	P	H
		15780	47.08	-26.92	74	48.14	40.38	17.03	58.47	100	0	P	H
													H
		8415	46.29	-27.71	74	56.94	35.63	12.81	59.09	100	0	P	V
		10520	41.71	-32.29	74	48.97	37.41	13.12	57.79	100	0	P	V
		15780	47.69	-26.31	74	48.75	40.38	17.03	58.47	100	0	P	V
802.11a CH 60 5300MHz		8480	49.01	-24.99	74	59.59	35.61	12.83	59.02	100	0	P	H
		10600	40.58	-33.42	74	47.65	37.46	13.23	57.76	100	0	P	H
		15900	46.37	-27.63	74	47.15	40.5	17.04	58.32	100	0	P	H
													H
		8480	47.97	-26.03	74	58.55	35.61	12.83	59.02	100	0	P	V
		10600	41.03	-32.97	74	48.1	37.46	13.23	57.76	100	0	P	V
		15900	46.28	-27.72	74	47.06	40.5	17.04	58.32	100	0	P	V
802.11a CH 64 5320MHz		8510	49.33	-24.67	74	59.87	35.61	12.85	59	100	0	P	H
		10640	40.83	-33.17	74	47.79	37.48	13.3	57.74	100	0	P	H
		15960	46.18	-27.82	74	46.8	40.57	17.05	58.24	100	0	P	H
													H
		8510	48.78	-25.22	74	59.32	35.61	12.85	59	100	0	P	V
		10640	40.99	-33.01	74	47.95	37.48	13.3	57.74	100	0	P	V
		15960	46.79	-27.21	74	47.41	40.57	17.05	58.24	100	0	P	V
Remark	1. No other spurious found. 2. All results are PASS against Peak and Average limit line.												



15E band 2 5250~5350MHz

WIFI 802.11n HT20 (Band Edge @ 3m)

WIFI	Note	Frequency	Level	Over	Limit	Read	Antenna	Cable	Preamp	Ant	Table	Peak	Pol.	
Ant.				Limit	Line	Level	Factor	Loss	Factor	Pos	Pos	Avg.		
1		(MHz)	(dBμV/m)	(dB)	(dBμV/m)	(dBμV)	(dB/m)	(dB)	(dB)	(cm)	(deg)	(P/A)	(H/V)	
802.11n HT20 CH 52 5260MHz		5055.05	52.94	-21.06	74	43.29	34.57	9.07	33.99	146	296	P	H	
		5001.05	40.61	-13.39	54	30.91	34.5	9.19	33.99	146	296	A	H	
	*	5260	105.25	-	-	95.75	34.77	8.71	33.98	146	296	P	H	
	*	5260	94.89	-	-	85.39	34.77	8.71	33.98	146	296	A	H	
													H	
													H	
802.11n HT20 CH 60 5300MHz		5012.9	53.07	-20.93	74	43.35	34.52	9.19	33.99	140	292	P	H	
		5009.6	40.62	-13.38	54	30.9	34.52	9.19	33.99	140	292	A	H	
	*	5300	105.23	-	-	95.69	34.8	8.72	33.98	140	292	P	H	
	*	5300	94.9	-	-	85.36	34.8	8.72	33.98	140	292	A	H	



802.11n HT20 CH 64 5320MHz	*	5320	106.27	-	-	96.71	34.82	8.72	33.98	149	292	P	H
	*	5320	95.81	-	-	86.25	34.82	8.72	33.98	149	292	A	H
		5379.37	57.02	-16.98	74	47.39	34.88	8.73	33.98	149	292	P	H
		5351.21	45.24	-8.76	54	35.65	34.85	8.72	33.98	149	292	A	H
													H
													H
	*	5320	94.88	-	-	85.32	34.82	8.72	33.98	231	7	P	V
	*	5320	84.78	-	-	75.22	34.82	8.72	33.98	231	7	A	V
		5358.47	52.84	-21.16	74	43.25	34.85	8.72	33.98	231	7	P	V
		5363.42	40.71	-13.29	54	31.1	34.87	8.72	33.98	231	7	A	V
												V	
												V	

Remark	1. No other spurious found. 2. All results are PASS against Peak and Average limit line.
--------	---



15E band 2 5250~5350MHz

WIFI 802.11n HT20 (Harmonic @ 3m)

WIFI	Note	Frequency	Level	Over	Limit	Read	Antenna	Cable	Preamp	Ant	Table	Peak	Pol.
Ant.				Limit	Line	Level	Factor	Loss	Factor	Pos	Pos	Avg.	
1		(MHz)	(dBμV/m)	(dB)	(dBμV/m)	(dBμV)	(dB/m)	(dB)	(dB)	(cm)	(deg)	(P/A)	(H/V)
802.11n HT20 CH 52 5260MHz		8415	48.49	-25.51	74	59.14	35.63	12.81	59.09	100	0	P	H
		10520	41.63	-32.37	74	48.89	37.41	13.12	57.79	100	0	P	H
		15780	45.78	-28.22	74	46.84	40.38	17.03	58.47	100	0	P	H
													H
		8415	46.98	-27.02	74	57.63	35.63	12.81	59.09	100	0	P	V
		10520	41.53	-32.47	74	48.79	37.41	13.12	57.79	100	0	P	V
		15780	47.17	-26.83	74	48.23	40.38	17.03	58.47	100	0	P	V
													V
802.11n HT20 CH 60 5300MHz		8480	50.04	-23.96	74	60.62	35.61	12.83	59.02	100	0	P	H
		10600	40.88	-33.12	74	47.95	37.46	13.23	57.76	100	0	P	H
		15900	46.26	-27.74	74	47.04	40.5	17.04	58.32	100	0	P	H
													H
		8480	47.97	-26.03	74	58.55	35.61	12.83	59.02	100	0	P	V
		10600	40.17	-33.83	74	47.24	37.46	13.23	57.76	100	0	P	V
		15900	46.13	-27.87	74	46.91	40.5	17.04	58.32	100	0	P	V
													V
802.11n HT20 CH 64 5320MHz		8510	50.17	-23.83	74	60.71	35.61	12.85	59	100	0	P	H
		10640	41.18	-32.82	74	48.14	37.48	13.3	57.74	100	0	P	H
		15960	46.36	-27.64	74	46.98	40.57	17.05	58.24	100	0	P	H
													H
		8510	47.89	-26.11	74	58.43	35.61	12.85	59	100	0	P	V
		10640	40.84	-33.16	74	47.8	37.48	13.3	57.74	100	0	P	V
		15960	46.61	-27.39	74	47.23	40.57	17.05	58.24	100	0	P	V
													V
Remark	1. No other spurious found. 2. All results are PASS against Peak and Average limit line.												



15E band 2 5250~5350MHz

WIFI 802.11n HT40 (Band Edge @ 3m)

WIFI	Note	Frequency	Level	Over	Limit	Read	Antenna	Cable	Preamp	Ant	Table	Peak	Pol.
Ant.				Limit	Line	Level	Factor	Loss	Factor	Pos	Pos	Avg.	
1		(MHz)	(dBμV/m)	(dB)	(dBμV/m)	(dBμV)	(dB/m)	(dB)	(dB)	(cm)	(deg)	(P/A)	(H/V)
802.11n HT40 CH 54 5270MHz		5033.6	53.26	-20.74	74	43.59	34.53	9.13	33.99	153	291	P	H
		5001.95	41.19	-12.81	54	31.49	34.5	9.19	33.99	153	291	A	H
	*	5270	102.23	-	-	92.73	34.77	8.71	33.98	153	291	P	H
	*	5270	92.37	-	-	82.87	34.77	8.71	33.98	153	291	A	H
		5351.87	54.72	-19.28	74	45.13	34.85	8.72	33.98	153	291	P	H
		5352.64	43.19	-10.81	54	33.6	34.85	8.72	33.98	153	291	A	H
		5010.05	54.21	-19.79	74	44.49	34.52	9.19	33.99	163	44	P	V
		5000.75	41.02	-12.98	54	31.32	34.5	9.19	33.99	163	44	A	V
	*	5270	89.33	-	-	79.83	34.77	8.71	33.98	163	44	P	V
	*	5270	79.57	-	-	70.07	34.77	8.71	33.98	163	44	A	V
		5374.86	53.31	-20.69	74	43.69	34.87	8.73	33.98	163	44	P	V
		5365.29	41	-13	54	31.39	34.87	8.72	33.98	163	44	A	V
802.11n HT40 CH 62 5310MHz		5008.25	53.15	-20.85	74	43.43	34.52	9.19	33.99	153	293	P	H
		5043.8	41.07	-12.93	54	31.44	34.55	9.07	33.99	153	293	A	H
	*	5310	101.97	-	-	92.41	34.82	8.72	33.98	153	293	P	H
	*	5310	92.36	-	-	82.8	34.82	8.72	33.98	153	293	A	H
		5350.22	66.26	-7.74	74	56.67	34.85	8.72	33.98	153	293	P	H
		5350	48.3	-5.7	54	38.71	34.85	8.72	33.98	153	293	A	H
		5017.1	52.68	-21.32	74	43.02	34.52	9.13	33.99	156	36	P	V
		5007.65	41.04	-12.96	54	31.32	34.52	9.19	33.99	156	36	A	V
	*	5310	90.7	-	-	81.14	34.82	8.72	33.98	156	36	P	V
	*	5310	80.99	-	-	71.43	34.82	8.72	33.98	156	36	A	V
		5350.88	55.9	-18.1	74	46.31	34.85	8.72	33.98	156	36	P	V
		5350	42.07	-11.93	54	32.48	34.85	8.72	33.98	156	36	A	V
Remark	1. No other spurious found. 2. All results are PASS against Peak and Average limit line.												



15E band 2 5250~5350MHz

WIFI 802.11n HT40 (Harmonic @ 3m)

WIFI	Note	Frequency	Level	Over	Limit	Read	Antenna	Cable	Preamp	Ant	Table	Peak	Pol.
Ant.				Limit	Line	Level	Factor	Loss	Factor	Pos	Pos	Avg.	
1		(MHz)	(dBμV/m)	(dB)	(dBμV/m)	(dBμV)	(dB/m)	(dB)	(dB)	(cm)	(deg)	(P/A)	(H/V)
802.11n HT40 CH 54 5270MHz		8430	49.68	-24.32	74	60.31	35.63	12.81	59.07	100	0	P	H
		10540	40.2	-33.8	74	47.41	37.42	13.16	57.79	100	0	P	H
		15810	45.69	-28.31	74	46.67	40.41	17.04	58.43	100	0	P	H
													H
		8430	47.72	-26.28	74	58.35	35.63	12.81	59.07	100	0	P	V
		10540	40.67	-33.33	74	47.88	37.42	13.16	57.79	100	0	P	V
		15810	46.26	-27.74	74	47.24	40.41	17.04	58.43	100	0	P	V
													V
802.11n HT40 CH 62 5310MHz		8495	50.02	-23.98	74	60.58	35.6	12.84	59	100	0	P	H
		10620	41.42	-32.58	74	48.44	37.47	13.26	57.75	100	0	P	H
		15930	46.39	-27.61	74	47.1	40.53	17.04	58.28	100	0	P	H
													H
		8495	48.98	-25.02	74	59.54	35.6	12.84	59	100	0	P	V
		10620	40.38	-33.62	74	47.4	37.47	13.26	57.75	100	0	P	V
		15930	46.61	-27.39	74	47.32	40.53	17.04	58.28	100	0	P	V
													V
Remark	1. No other spurious found. 2. All results are PASS against Peak and Average limit line.												



15E Band 3 - 5470~5725MHz

WIFI 802.11a (Band Edge @ 3m)

WIFI	Note	Frequency	Level	Over	Limit	Read	Antenna	Cable	Preamp	Ant	Table	Peak	Pol.	
Ant.				Limit	Line	Level	Factor	Loss	Factor	Pos	Pos	Avg.		
1		(MHz)	(dBμV/m)	(dB)	(dBμV/m)	(dBμV)	(dB/m)	(dB)	(dB)	(cm)	(deg)	(P/A)	(H/V)	
802.11a CH 100 5500MHz		5451.6	59.63	-14.37	74	49.88	34.95	8.78	33.98	143	291	P	H	
		5469.68	47.3	-6.7	54	37.53	34.97	8.78	33.98	143	291	A	H	
	*	5500	109.15	-	-	99.33	35	8.8	33.98	143	291	P	H	
	*	5500	98.69	-	-	88.87	35	8.8	33.98	143	291	A	H	
													H	
													H	
			5393.04	53.81	-20.19	74	44.18	34.88	8.73	33.98	128	7	P	V
			5457.36	40.91	-13.09	54	31.16	34.95	8.78	33.98	128	7	A	V
	*		5500	98.2	-	-	88.38	35	8.8	33.98	128	7	P	V
	*		5500	87.76	-	-	77.94	35	8.8	33.98	128	7	A	V
													V	
													V	
802.11a CH 116 5580MHz		5392.24	56.18	-17.82	74	46.55	34.88	8.73	33.98	137	296	P	H	
		5427.6	43.54	-10.46	54	33.85	34.92	8.75	33.98	137	296	A	H	
	*	5580	108.83	-	-	98.88	35.04	8.9	33.99	137	296	P	H	
	*	5580	99.09	-	-	89.14	35.04	8.9	33.99	137	296	A	H	
			5763.96	54.92	-19.08	74	44.49	35.16	9.27	34	137	296	P	H
			5733.16	42.57	-11.43	54	32.21	35.13	9.22	33.99	137	296	A	H
			5366.8	52.95	-21.05	74	43.34	34.87	8.72	33.98	136	31	P	V
			5368.88	40.39	-13.61	54	30.78	34.87	8.72	33.98	136	31	A	V
	*		5578	98.94	-	-	88.99	35.04	8.9	33.99	136	31	P	V
	*		5578	88.79	-	-	78.84	35.04	8.9	33.99	136	31	A	V
			5758.2	53.25	-20.75	74	42.82	35.16	9.27	34	136	31	P	V
			5732.68	40.72	-13.28	54	30.36	35.13	9.22	33.99	136	31	A	V



802.11a CH 140 5700MHz	*	5700	108.57	-	-	98.34	35.11	9.11	33.99	145	300	P	H
	*	5700	98.46	-	-	88.23	35.11	9.11	33.99	145	300	A	H
		5727.32	62.69	-11.31	74	52.39	35.13	9.16	33.99	145	300	P	H
		5725.24	46.99	-7.01	54	36.69	35.13	9.16	33.99	145	300	A	H
													H
													H
	*	5700	99.22	-	-	88.99	35.11	9.11	33.99	139	29	P	V
	*	5700	89.21	-	-	78.98	35.11	9.11	33.99	139	29	A	V
		5725.4	54.72	-19.28	74	44.42	35.13	9.16	33.99	139	29	P	V
		5745.24	41.69	-12.31	54	31.32	35.14	9.22	33.99	139	29	A	V
													V
													V

Remark	1. No other spurious found. 2. All results are PASS against Peak and Average limit line.
--------	---



15E band 3 - 5470~5725MHz

WIFI 802.11a (Harmonic @ 3m)

WIFI	Note	Frequency	Level	Over	Limit	Read	Antenna	Cable	Preamp	Ant	Table	Peak	Pol.	
Ant.				Limit	Line	Level	Factor	Loss	Factor	Pos	Pos	Avg.		
1		(MHz)	(dBμV/m)	(dB)	(dBμV/m)	(dBμV)	(dB/m)	(dB)	(dB)	(cm)	(deg)	(P/A)	(H/V)	
802.11a CH 100 5500MHz		8800	46.83	-27.17	74	57.21	35.84	12.78	59	100	0	P	H	
		11000	42.05	-31.95	74	48.17	37.7	13.78	57.6	100	0	P	H	
		16500	46.98	-27.02	74	44.94	41.2	17.44	56.6	100	0	P	H	
													H	
		8800	47.53	-26.47	74	57.91	35.84	12.78	59	100	0	P	V	
		11000	41.71	-32.29	74	47.83	37.7	13.78	57.6	100	0	P	V	
		16500	47.18	-26.82	74	45.14	41.2	17.44	56.6	100	0	P	V	
														V
802.11a CH 116 5580MHz		8925	46.78	-27.22	74	56.43	35.93	13.42	59	100	0	P	H	
		11160	42.5	-31.5	74	48.48	37.83	13.99	57.8	100	0	P	H	
		16740	48.24	-25.76	74	46.11	41.25	17.62	56.74	100	0	P	H	
													H	
		8930	46.68	-27.32	74	56.33	35.93	13.42	59	100	0	P	V	
		11160	42.46	-31.54	74	48.44	37.83	13.99	57.8	100	0	P	V	
		16740	47.71	-26.29	74	45.58	41.25	17.62	56.74	100	0	P	V	
														V
802.11a CH 140 5700MHz		11400	43.57	-30.43	74	49.29	38.02	14.34	58.08	100	0	P	H	
		17100	47.26	-26.74	74	45.39	41.22	17.89	57.24	100	0	P	H	
													H	
													H	
		11400	43.74	-30.26	74	49.46	38.02	14.34	58.08	100	0	P	V	
		17100	48.19	-25.81	74	46.32	41.22	17.89	57.24	100	0	P	V	
														V
														V
Remark	1. No other spurious found. 2. All results are PASS against Peak and Average limit line.													



15E band 3 - 5470~5725MHz

WIFI 802.11n HT20 (Band Edge @ 3m)

WIFI	Note	Frequency	Level	Over	Limit	Read	Antenna	Cable	Preamp	Ant	Table	Peak	Pol.	
Ant.				Limit	Line	Level	Factor	Loss	Factor	Pos	Pos	Avg.		
1		(MHz)	(dBμV/m)	(dB)	(dBμV/m)	(dBμV)	(dB/m)	(dB)	(dB)	(cm)	(deg)	(P/A)	(H/V)	
802.11n HT20 CH 100 5500MHz		5466	58.53	-15.47	74	48.76	34.97	8.78	33.98	148	289	P	H	
		5465.84	45.95	-8.05	54	36.18	34.97	8.78	33.98	148	289	A	H	
	*	5500	106.86	-	-	97.04	35	8.8	33.98	148	289	P	H	
	*	5500	96.22	-	-	86.4	35	8.8	33.98	148	289	A	H	
													H	
													H	
802.11n HT20 CH 116 5580MHz		5391.92	55.61	-18.39	74	45.98	34.88	8.73	33.98	134	288	P	H	
		5427.76	43.09	-10.91	54	33.4	34.92	8.75	33.98	134	288	A	H	
	*	5580	106.96	-	-	97.01	35.04	8.9	33.99	134	288	P	H	
	*	5580	96.56	-	-	86.61	35.04	8.9	33.99	134	288	A	H	



802.11n HT20 CH 140 5700MHz	*	5700	106.01	-	-	95.78	35.11	9.11	33.99	152	289	P	H
	*	5700	95.79	-	-	85.56	35.11	9.11	33.99	152	289	A	H
		5725.24	59.98	-14.02	74	49.68	35.13	9.16	33.99	152	289	P	H
		5725	45.84	-8.16	54	35.54	35.13	9.16	33.99	152	289	A	H
													H
													H
	*	5700	96.6	-	-	86.37	35.11	9.11	33.99	152	29	P	V
	*	5700	86.25	-	-	76.02	35.11	9.11	33.99	152	29	A	V
		5735.16	53.64	-20.36	74	43.27	35.14	9.22	33.99	152	29	P	V
		5725	41.52	-12.48	54	31.22	35.13	9.16	33.99	152	29	A	V
													V
													V

Remark	1. No other spurious found. 2. All results are PASS against Peak and Average limit line.
--------	---



15E band 3 - 5470~5725MHz

WIFI 802.11n HT20 (Harmonic @ 3m)

WIFI	Note	Frequency	Level	Over	Limit	Read	Antenna	Cable	Preamp	Ant	Table	Peak	Pol.
Ant.				Limit	Line	Level	Factor	Loss	Factor	Pos	Pos	Avg.	
1		(MHz)	(dBμV/m)	(dB)	(dBμV/m)	(dBμV)	(dB/m)	(dB)	(dB)	(cm)	(deg)	(P/A)	(H/V)
802.11n HT20 CH 100 5500MHz		8800	47.09	-26.91	74	57.47	35.84	12.78	59	100	0	P	H
		11000	43.31	-30.69	74	49.43	37.7	13.78	57.6	100	0	P	H
		16500	47.3	-26.7	74	45.26	41.2	17.44	56.6	100	0	P	H
													H
		8800	48.08	-25.92	74	58.46	35.84	12.78	59	100	0	P	V
		11000	42.2	-31.8	74	48.32	37.7	13.78	57.6	100	0	P	V
		16500	47.49	-26.51	74	45.45	41.2	17.44	56.6	100	0	P	V
													V
802.11n HT20 CH 116 5580MHz		8930	46.88	-27.12	74	56.53	35.93	13.42	59	100	0	P	H
		11160	42.74	-31.26	74	48.72	37.83	13.99	57.8	100	0	P	H
		16740	48.27	-25.73	74	46.14	41.25	17.62	56.74	100	0	P	H
													H
		8930	46.48	-27.52	74	56.13	35.93	13.42	59	100	0	P	V
		11160	42.7	-31.3	74	48.68	37.83	13.99	57.8	100	0	P	V
		16740	48.43	-25.57	74	46.3	41.25	17.62	56.74	100	0	P	V
													V
802.11n HT20 CH 140 5700MHz		11400	43.33	-30.67	74	49.05	38.02	14.34	58.08	100	0	P	H
		17100	47.32	-26.68	74	45.45	41.22	17.89	57.24	100	0	P	H
													H
													H
		11400	44.95	-29.05	74	50.67	38.02	14.34	58.08	100	0	P	V
		17100	43.45	-30.55	74	41.58	41.22	17.89	57.24	100	0	P	V
													V
Remark	1. No other spurious found. 2. All results are PASS against Peak and Average limit line.												



15E band 3 - 5470~5725MHz

WIFI 802.11n HT40 (Band Edge @ 3m)

WIFI	Note	Frequency	Level	Over	Limit	Read	Antenna	Cable	Preamp	Ant	Table	Peak	Pol.
Ant.				Limit	Line	Level	Factor	Loss	Factor	Pos	Pos	Avg.	
1		(MHz)	(dBμV/m)	(dB)	(dBμV/m)	(dBμV)	(dB/m)	(dB)	(dB)	(cm)	(deg)	(P/A)	(H/V)
802.11n HT40 CH 102 5510MHz		5469.36	65.68	-8.32	74	55.91	34.97	8.78	33.98	145	291	P	H
		5470	50.82	-3.18	54	41.05	34.97	8.78	33.98	145	291	A	H
	*	5510	102.83	-	-	92.98	35	8.83	33.98	145	291	P	H
	*	5510	92.88	-	-	83.03	35	8.83	33.98	145	291	A	H
		5725.4	53.54	-20.46	74	43.24	35.13	9.16	33.99	145	291	P	H
		5754.52	41.48	-12.52	54	31.09	35.16	9.22	33.99	145	291	A	H
		5469.36	56.89	-17.11	74	47.12	34.97	8.78	33.98	149	27	P	V
		5470	43.27	-10.73	54	33.5	34.97	8.78	33.98	149	27	A	V
	*	5510	93.1	-	-	83.25	35	8.83	33.98	149	27	P	V
	*	5510	83.12	-	-	73.27	35	8.83	33.98	149	27	A	V
	5744.92	53.14	-20.86	74	42.77	35.14	9.22	33.99	149	27	P	V	
	5747.16	41.28	-12.72	54	30.91	35.14	9.22	33.99	149	27	A	V	
802.11n HT40 CH 110 5550MHz		5465.2	56.07	-17.93	74	46.3	34.97	8.78	33.98	136	289	P	H
		5401.52	44.11	-9.89	54	34.46	34.9	8.73	33.98	136	289	A	H
	*	5550	104.37	-	-	94.47	35.03	8.85	33.98	136	289	P	H
	*	5550	94.33	-	-	84.43	35.03	8.85	33.98	136	289	A	H
		5738.76	54.03	-19.97	74	43.66	35.14	9.22	33.99	136	289	P	H
		5727.72	42.01	-11.99	54	31.71	35.13	9.16	33.99	136	289	A	H
		5444.56	52.97	-21.03	74	43.27	34.93	8.75	33.98	145	28	P	V
		5403.12	40.93	-13.07	54	31.28	34.9	8.73	33.98	145	28	A	V
	*	5550	93.98	-	-	84.08	35.03	8.85	33.98	145	28	P	V
	*	5550	83.23	-	-	73.33	35.03	8.85	33.98	145	28	A	V
	5733.8	53.97	-20.03	74	43.61	35.13	9.22	33.99	145	28	P	V	
	5729.24	41.41	-12.59	54	31.11	35.13	9.16	33.99	145	28	A	V	



802.11n HT40 CH 134 5670MHz		5456.72	53.75	-20.25	74	44	34.95	8.78	33.98	144	290	P	H
		5388.24	41.74	-12.26	54	32.11	34.88	8.73	33.98	144	290	A	H
	*	5670	104.07	-	-	93.9	35.1	9.06	33.99	144	290	P	H
	*	5670	94.16	-	-	83.99	35.1	9.06	33.99	144	290	A	H
		5726.2	58.52	-15.48	74	48.22	35.13	9.16	33.99	144	290	P	H
		5727.32	44.52	-9.48	54	34.22	35.13	9.16	33.99	144	290	A	H
		5404.08	52.97	-21.03	74	43.32	34.9	8.73	33.98	168	30	P	V
		5376.56	40.84	-13.16	54	31.22	34.87	8.73	33.98	168	30	A	V
	*	5670	94.25	-	-	84.08	35.1	9.06	33.99	168	30	P	V
	*	5670	84.57	-	-	74.4	35.1	9.06	33.99	168	30	A	V
		5740.92	53.71	-20.29	74	43.34	35.14	9.22	33.99	168	30	P	V
	5734.36	41.65	-12.35	54	31.29	35.13	9.22	33.99	168	30	A	V	

Remark	1. No other spurious found. 2. All results are PASS against Peak and Average limit line.												
--------	---	--	--	--	--	--	--	--	--	--	--	--	--



15E band 3 - 5470~5725MHz

WIFI 802.11n HT40 (Harmonic @ 3m)

WIFI	Note	Frequency	Level	Over	Limit	Read	Antenna	Cable	Preamp	Ant	Table	Peak	Pol.
Ant.				Limit	Line	Level	Factor	Loss	Factor	Pos	Pos	Avg.	
1		(MHz)	(dBμV/m)	(dB)	(dBμV/m)	(dBμV)	(dB/m)	(dB)	(dB)	(cm)	(deg)	(P/A)	(H/V)
802.11n HT40 CH 102 5510MHz		8815	48.13	-25.87	74	58.5	35.85	12.78	59	100	0	P	H
		11020	42.84	-31.16	74	48.93	37.71	13.82	57.62	100	0	P	H
		16530	46.83	-27.17	74	44.78	41.21	17.46	56.62	100	0	P	H
													H
		8815	47.73	-26.27	74	58.1	35.85	12.78	59	100	0	P	V
		11020	41.65	-32.35	74	47.74	37.71	13.82	57.62	100	0	P	V
		16530	48.07	-25.93	74	46.02	41.21	17.46	56.62	100	0	P	V
													V
802.11n HT40 CH 110 5550MHz		8880	47.51	-26.49	74	57.44	35.91	13.16	59	100	0	P	H
		11100	42.51	-31.49	74	48.53	37.78	13.92	57.72	100	0	P	H
		16650	48.14	-25.86	74	46.04	41.23	17.56	56.69	100	0	P	H
													H
		8880	47.23	-26.77	74	57.16	35.91	13.16	59	100	0	P	V
		11100	42.65	-31.35	74	48.67	37.78	13.92	57.72	100	0	P	V
		16650	48.26	-25.74	74	46.16	41.23	17.56	56.69	100	0	P	V
													V
802.11n HT40 CH 134 5670MHz		11340	43.83	-30.17	74	49.62	37.97	14.24	58	100	0	P	H
		17010	48.4	-25.6	74	46.24	41.29	17.83	56.96	100	0	P	H
													H
													H
		11340	42.56	-31.44	74	48.35	37.97	14.24	58	100	0	P	V
		17010	48.83	-25.17	74	46.67	41.29	17.83	56.96	100	0	P	V
													V
Remark	1. No other spurious found. 2. All results are PASS against Peak and Average limit line.												



15E Emission below 1GHz

WIFI 802.11a (LF @ 3m)

WIFI	Note	Frequency	Level	Over	Limit	Read	Antenna	Cable	Preamp	Ant	Table	Peak	Pol.	
Ant.		(MHz)	(dBµV/m)	(dB)	(dBµV/m)	(dBµV)	(dB/m)	(dB)	(dB)	(cm)	(deg)	(P/A)	(H/V)	
802.11a LF		51.06	20.91	-19.09	40	43.9	7.98	0.81	31.78			P	H	
		109.65	23.08	-20.42	43.5	41.48	12.2	1.15	31.75			P	H	
		133.95	21.86	-21.64	43.5	40.76	11.56	1.29	31.75			P	H	
		574.4	28.61	-17.39	46	38.65	19.34	2.65	32.03	100	213	P	H	
		755	27.59	-18.41	46	36.32	20.2	3.05	31.98			P	H	
		842.5	28.36	-17.64	46	36.19	20.73	3.21	31.77			P	H	
													H	
													H	
													H	
													H	
													H	
													H	
													H	
			30	26.42	-13.58	40	39.08	18.5	0.64	31.8			P	V
			48.63	28.23	-11.77	40	50.49	8.73	0.79	31.78	144	121	P	V
			147.72	27.25	-16.25	43.5	47.03	10.64	1.33	31.75			P	V
			660.5	28.8	-17.2	46	38.61	19.41	2.82	32.04			P	V
			847.4	29.5	-16.5	46	37.25	20.78	3.22	31.75			P	V
		938.4	32.39	-13.61	46	38.94	21.28	3.35	31.18			P	V	
													V	
													V	
													V	
													V	
													V	
Remark	1. No other spurious found. 2. All results are PASS against limit line.													



15E Emission below 1GHz

WIFI 802.11n HT20 (LF @ 3m)

WIFI	Note	Frequency	Level	Over	Limit	Read	Antenna	Cable	Preamp	Ant	Table	Peak	Pol.	
Ant.				Limit	Line	Level	Factor	Loss	Factor	Pos	Pos	Avg.		
1		(MHz)	(dBμV/m)	(dB)	(dBμV/m)	(dBμV)	(dB/m)	(dB)	(dB)	(cm)	(deg)	(P/A)	(H/V)	
802.11n HT20 LF		30	17.63	-22.37	40	30.29	18.5	0.64	31.8			P	H	
		96.15	20.64	-22.86	43.5	41.07	10.24	1.08	31.75			P	H	
		136.65	21.48	-22.02	43.5	40.53	11.4	1.3	31.75			P	H	
		545.7	26.16	-19.84	46	36.27	19.34	2.54	31.99	100	244	P	H	
		756.4	25.65	-20.35	46	34.38	20.2	3.05	31.98			P	H	
		949.6	25.26	-20.74	46	31.68	21.3	3.35	31.07			P	H	
													H	
													H	
													H	
													H	
													H	
													H	
			46.2	26.58	-13.42	40	48.42	9.17	0.77	31.78	100	233	P	V
			65.64	24.81	-15.19	40	49.48	6.18	0.92	31.77			P	V
			77.25	24.04	-15.96	40	48.02	6.8	0.98	31.76			P	V
			515.6	24.63	-21.37	46	36.11	17.96	2.51	31.95			P	V
			865.6	25.02	-20.98	46	32.57	20.85	3.27	31.67			P	V
			939.8	30.78	-15.22	46	37.29	21.3	3.35	31.16			P	V
														V
														V
													V	
													V	
													V	
Remark	1. No other spurious found. 2. All results are PASS against limit line.													



15E Emission below 1GHz

WIFI 802.11n HT40 (LF @ 3m)

WIFI	Note	Frequency	Level	Over	Limit	Read	Antenna	Cable	Preamp	Ant	Table	Peak	Pol.	
Ant.				Limit	Line	Level	Factor	Loss	Factor	Pos	Pos	Avg.		
1		(MHz)	(dBμV/m)	(dB)	(dBμV/m)	(dBμV)	(dB/m)	(dB)	(dB)	(cm)	(deg)	(P/A)	(H/V)	
802.11n HT40 LF		51.06	20.05	-19.95	40	43.04	7.98	0.81	31.78			P	H	
		109.65	19.91	-23.59	43.5	38.31	12.2	1.15	31.75			P	H	
		138.81	21.62	-21.88	43.5	40.86	11.2	1.31	31.75			P	H	
		804	24.39	-21.61	46	33.17	20.08	3.07	31.93			P	H	
		828.5	27.23	-18.77	46	35.34	20.56	3.16	31.83	100	134	P	H	
		949.6	25.43	-20.57	46	31.85	21.3	3.35	31.07			P	H	
													H	
													H	
													H	
													H	
													H	
													H	
													H	
			42.15	23.03	-16.97	40	43.15	10.92	0.75	31.79			P	V
			66.45	24.67	-15.33	40	49.26	6.26	0.92	31.77	100	201	P	V
			101.55	17.54	-25.96	43.5	37.06	11.12	1.11	31.75			P	V
			748	25.31	-20.69	46	34.08	20.18	3.04	31.99			P	V
			902	26.21	-19.79	46	33.27	21.08	3.37	31.51			P	V
			911.1	25.88	-20.12	46	32.93	21.01	3.37	31.43			P	V
														V
													V	
													V	
													V	
													V	
													V	
Remark	1. No other spurious found. 2. All results are PASS against limit line.													



Note symbol

*	Fundamental Frequency which can be ignored. However, the level of any unwanted emissions shall not exceed the level of the fundamental frequency per 15.209(c).
!	Test result is over limit line.
P/A	Peak or Average
H/V	Horizontal or Vertical



A calculation example for radiated spurious emission is shown as below:

WIFI	Note	Frequency	Level	Over	Limit	Read	Antenna	Cable	Preamp	Ant	Table	Peak	Pol.
Ant.				Limit	Line	Level	Factor	Loss	Factor	Pos	Pos	Avg.	
1		(MHz)	(dBμV/m)	(dB)	(dBμV/m)	(dBμV)	(dB/m)	(dB)	(dB)	(cm)	(deg)	(P/A)	(H/V)
802.11b		2390	55.45	-18.55	74	54.51	32.22	4.58	35.86	103	308	P	H
CH 01													
2412MHz		2390	43.54	-10.46	54	42.6	32.22	4.58	35.86	103	308	A	H

- Level(dBμV/m) =
Antenna Factor(dB/m) + Cable Loss(dB) + Read Level(dBμV) - Preamp Factor(dB)
- Over Limit(dB) = Level(dBμV/m) – Limit Line(dBμV/m)

For Peak Limit @ 2390MHz:

- Level(dBμV/m)
= Antenna Factor(dB/m) + Cable Loss(dB) + Read Level(dBμV) - Preamp Factor(dB)
= 32.22(dB/m) + 4.58(dB) + 54.51(dBμV) – 35.86 (dB)
= 55.45 (dBμV/m)
- Over Limit(dB)
= Level(dBμV/m) – Limit Line(dBμV/m)
= 55.45(dBμV/m) – 74(dBμV/m)
= -18.55(dB)

For Average Limit @ 2390MHz:

- Level(dBμV/m)
= Antenna Factor(dB/m) + Cable Loss(dB) + Read Level(dBμV) - Preamp Factor(dB)
= 32.22(dB/m) + 4.58(dB) + 42.6(dBμV) – 35.86 (dB)
= 43.54 (dBμV/m)
- Over Limit(dB)
= Level(dBμV/m) – Limit Line(dBμV/m)
= 43.54(dBμV/m) – 54(dBμV/m)
= -10.46(dB)

Both peak and average measured complies with the limit line, so test result is “PASS”.