



HAC T-COIL SIGNAL TEST REPORT

**FCC CFR47 PART 20.19
ANSI C63.19-2011**

For
GSM/W-CDMA/LTE + BLUETOOTH, DTS/UNII a/b/g/n/ac, ANT+ & NFC

FCC ID: PY7-PM0841

**Report Number: 15U20107-S4
Issue Date: 5/7/2015**

Prepared for
**SONY MOBILE COMMUNICATIONS INC.
NYA VATTENTORNET MOBILVAGEN 10
LUND 22188
SWEDEN**

Prepared by
**UL VERIFICATION SERVICES INC.
47173 BENICIA STREET
FREMONT, CA 94538, U.S.A.
TEL: (510) 771-1000
FAX: (510) 661-0888**



NVLAP LAB CODE 200065-0

Revision History

Rev.	Date	Revisions	Revised By
--	5/7/2015	Initial Issue	--

Table of Contents



1. Attestation of Test Results	4
2. Test Methodology	5
3. Facilities and Accreditation	5
4. Calibration and Uncertainty	5
4.1. <i>Measuring Instrument Calibration.....</i>	<i>5</i>
4.2. <i>Measurement Uncertainty.....</i>	<i>6</i>
5. Device Under Test	7
5.1. <i>Air Interfaces and Operating Mode.....</i>	<i>7</i>
6. Test Procedures.....	8
7. Audio Level and Gain Measurements	10
8. T-coil Measurement Criteria.....	12
8.1. <i>Frequency Response</i>	<i>12</i>
8.2. <i>Signal to Noise</i>	<i>13</i>
9. HAC (T-coil) Test Results.....	14
9.1. <i>Worst Case T-Coil Test Plot</i>	<i>15</i>
Appendix.....	16
<i>A_15U20107v0 Setup Photo.....</i>	<i>16</i>
<i>B_15U20107v0 Frequency Response & SNR Test Plots.....</i>	<i>16</i>
<i>C_15U20107v0 Probe Cal. Certificates.....</i>	<i>16</i>

1. Attestation of Test Results

Applicant Name	SONY MOBILE COMMUNICATIONS, INC.
FCC ID	PY7-PM0841
Applicable Standards	FCC 47 CFR § 20.19 ANSI C63.19-2011 Published RF exposure KDB procedures
Device Category	Portable
Exposure Category	General Population/Uncontrolled Exposure
HAC Rating	T3
Date Tested	4/3/2015 to 4/24/2015
Test Results	Pass

UL Verification Services Inc. tested the above equipment in accordance with the requirements set forth in the above standards. All indications of Pass/Fail in this report are opinions expressed by UL Verification Services Inc. based on interpretations and/or observations of test results. Measurement Uncertainties were not taken into account and are published for informational purposes only. The test results show that the equipment tested is capable of demonstrating compliance with the requirements as documented in this report.

Note: The results documented in this report apply only to the tested sample, under the conditions and modes of operation as described herein. This document may not be altered or revised in any way unless done so by UL Verification Services Inc. and all revisions are duly noted in the revisions section. Any alteration of this document not carried out by UL Verification Services Inc. will constitute fraud and shall nullify the document. This report must not be used by the client to claim product certification, approval, or endorsement by NVLAP, NIST, any agency of the Federal Government, or any agency of any government (NIST Handbook 150, Annex A). This report is written to support regulatory compliance of the applicable standards stated above.

Approved & Released By: 	Prepared By: 
Devin Chang Senior Engineer UL Verification Services Inc.	Coltyce Sanders Laboratory Engineer UL Verification Services Inc.

2. Test Methodology

The tests documented in this report were performed in accordance with ANSI C63.19-2011 Methods of Measurement of Compatibility between Wireless Communications Devices and Hearing Aids and FCC published procedure KDB 285076 D01 HAC Guidance v04 and KDB 285076 D02 T-Coil testing for CMRS IP v01r01.

3. Facilities and Accreditation

The test sites and measurement facilities used to collect data are located at

47173 Benicia Street	47266 Benicia Street
SAR Lab C	SAR Lab 2

UL Verification Services Inc. is accredited by NVLAP, Laboratory Code 200065-0. The full scope of accreditation can be viewed at <http://ts.nist.gov/standards/scopes/2000650.htm>

4. Calibration and Uncertainty

4.1. Measuring Instrument Calibration

The measuring equipment used to perform the tests documented in this report has been calibrated in accordance with the manufacturers' recommendations, and is traceable to recognized national standards.

Name of Equipment	Manufacturer	Type/Model	Serial No.	Cal. Due Date
Robot - Six Axes	Stäubli	TX90 XL	N/A	N/A
Robot Remote Control	Stäubli	CS8C	N/A	N/A
DASY5 Measurement Server	SPEAG	SEUMS001BA	1041	N/A
Probe Alignment Unit	SPEAG	LB (V2)	261	N/A
Audio Magnetic Measuring Ins.I	SPEAG	AMMI	1127	N/A
Coordinating SystemI	SPEAG	AMCC	N/A	N/A
ABM Probe	SPEAG	AM1DV3	3092	7/18/2015
Data Acquisition Electronics	SPEAG	DAE4	1259	1/14/2016
Radio Communication Tester	R & S	CMU 200	838114/032	7/30/2015

4.2. Measurement Uncertainty

Measurement Uncertainty for Audio Band Magnetic Measurement

Error Description	Uncertainty values (%)	Probe Dist.	Div.	c AMB1	c AMB2	Std. Unc.	
						AMB1 (%)	AMB2 (%)
Probe Sensitivity							
Reference level	3.0	N	1	1.00	1.00	3.00	3.00
AMCC geometry	0.4	R	1.73	1.00	1.00	0.23	0.23
AMCC current	0.6	R	1.73	1.00	1.00	0.35	0.35
Probe positioning during calibration	0.1	R	1.73	1.00	1.00	0.06	0.06
Noise contribution	0.7	R	1.73	0.01	1.00	0.01	0.40
Frequency slope	5.9	R	1.73	0.10	1.00	0.34	3.41
Probe System							
Repeatability / drift	1.0	R	1.73	1.00	1.00	0.58	0.58
Linearity / Dynamic range	0.6	R	1.73	1.00	1.00	0.35	0.35
Acoustic noise	1.0	R	1.73	0.10	1.00	0.06	0.58
Probe angle	2.3	R	1.73	1.00	1.00	1.33	1.33
Spectral processing	0.9	R	1.73	1.00	1.00	0.52	0.52
Integration time	0.6	N	1.00	1.00	5.00	0.60	3.00
Field disturbance	0.2	R	1.73	1.00	1.00	0.12	0.12
Test Signal							
Reference signal spectral response	0.6	R	1.73	0.00	1.00	0.00	0.35
Positioning							
Probe positioning	1.9	R	1.73	1.00	1.00	1.10	1.10
Phantom positioning	0.9	R	1.73	1.00	1.00	0.52	0.52
EUT positioning	1.9	R	1.73	1.00	1.00	1.10	1.10
External Contributions							
RF interference	0.0	R	1.73	1.00	1.00	0.00	0.00
Test signal variation	2.0	R	1.73	1.00	1.00	1.15	1.15
Combined Std. Uncertainty (ABM field)						4.02	6.08
Expanded Std. Uncertainty (%)						8.04	12.15
Notes for table							
1. N - Nomal							
2. R - Rectangular							
3. Div. - Divisor used to obtain standard uncertainty							

5. Device Under Test

Normal operation	Held to head
Back Cover	<input type="checkbox"/> Normal Battery Cover <input type="checkbox"/> Normal Battery Cover with NFC <input type="checkbox"/> Wireless Charger Battery Cover <input type="checkbox"/> Wireless Charger Battery Cover with NFC <input checked="" type="checkbox"/> The rechargeable battery is not user accessible.

5.1. Air Interfaces and Operating Mode

Air-Interface	Bands (MHz)	Type Transport	HAC Tested	Simultaneous but not Tested	Concurrent HAC Tested or not Tested	Voice over digital Transport OTT Capability	Wi-Fi Low Power	Additional GSM Power Reduction
GSM	850 / 1900	VO	Yes	Yes – Wi-Fi/BT	Not tested ¹	NA	NA	NA
GPRS	850 / 1900	DT	No	Yes – Wi-Fi/BT	NA	Yes	NA	NA
EGPRS	850 / 1900	DT	No	Yes – Wi-Fi/BT	NA	Yes	NA	NA
W-CDMA R99	II / V	VO	Yes	Yes - Wi-Fi/BT	Not tested ¹	NA	NA	NA
HSPA	II / V	DT	No	Yes – Wi-Fi/BT	NA	Yes	NA	NA
CDMA	BC 0 / 1	VO	Yes	Yes – Wi-Fi/BT	Not tested ¹	NA	NA	NA
EVDO	BC 0 / 1	DT	No	Yes – Wi-Fi/BT	NA	NA	NA	NA
LTE - FDD	2 / 4 / 5 / 7 / 13	VD	No ²	Yes – Wi-Fi/BT	Not tested ¹	Yes	NA	NA
Wi-Fi	2400	DT	No	Yes – WWAN	Not tested ¹	NA	No	NA
Wi-Fi	5000	DT	No	Yes – WWAN	Not tested ¹	NA	No	NA
BT	2400	DT	No	Yes – WWAN	Not tested ¹	NA	NA	NA
Type Transport VO = Voice only DT = Digital Transport VD = CMRS and Data transport (HAC Tested)				Note: 1. No concurrent mode was found to be the Worst Case mode 2. No associated T-Coil measurement has been made in accordance with 285076 D02 T-Coil testing for CMRS IP from October 2013 TCB workshop.				

6. Test Procedures

ANSI C63.19-2011, Section 7

This document describes the procedures used to measure the ABM (T-Coil) performance of the WD. In addition to measuring the absolute signal levels, the A-weighted magnitude of the unintended signal shall also be determined. In order to assure that the required signal quality is measured, the measurement of the intended signal and the measurement of the unintended signal must be made at the same location for all measurement positions. In addition, the RF field strength at each measurement location must be at or below that required for the assigned category.

Measurements shall not include undesired properties from the WD's RF field; therefore, use of a coaxial connection to a base station simulator or non-radiating load may be necessary. However, even then with a coaxial connection to a base station simulator or non-radiating load there may still be RF leakage from the WD, which may interfere with the desired measurement. Pre-measurement checks should be made to avoid this possibility. All measurements shall be done with the WD operating on battery power with an appropriate normal speech audio signal input level given in Table 7.1. If the device display can be turned off during a phone call then that may be done during the measurement as well.

Measurements shall be performed at two locations specified in A.3, with the correct probe orientation for a particular location, in a multistage sequence by first measuring the field intensity of the desired T-Coil signal (ABM1) that is useful to a hearing aid T-Coil. The undesired magnetic components (ABM2) must be measured at the same location as the desired ABM or T-Coil signal (ABM1), and the ratio of desired to undesired ABM signals must be calculated. For the perpendicular field location, only the ABM1 frequency response shall be determined in a third measurement stage. The flow chart in Figure 7.3 illustrates this three-stage, two orientation process.

The following steps summarize the basic test flow for determining ABM1¹ and ABM2². These steps assume that a sine wave or narrowband 1/3 octave signal can be used for the measurement of ABM1.

- a. A validation of the test setup and instrumentation may be performed using a TMFS or Helmholtz coil. Measure the emissions and confirm that they are within the specified tolerance.
- b. Position the WD in the test setup and connect the WD RF connector to a base station simulator or a non-radiating load as shown in Figure 7.1 or Figure 7.2. Confirm that equipment that requires calibration has been calibrated, and that the noise level meets the requirements given in 7.3.1.
- c. The drive level to the WD is set such that the reference input level specified in Table 7.1 is input to the base station simulator (or manufacturer's test mode equivalent) in the 1 kHz, 1/3 octave band. This drive level shall be used for the T-Coil signal test (ABM1) at $f = 1$ kHz. Either a sine wave at 1025 Hz or a voice-like signal, band-limited to the 1 kHz 1/3 octave, as defined in 7.4.2, shall be used for the reference audio signal. If interference is found at 1025 Hz an alternative nearby reference audio signal frequency may be used.⁴⁶ The same drive level will be used for the ABM1 frequency response measurements at each 1/3 octave band center frequency. The WD volume control may be set at any level up to maximum, provided that a signal at any frequency at maximum modulation would not result in clipping or signal overload.
- d. Determine the magnetic measurement locations for the WD device (A.3), if not already specified by the manufacturer, as described in 7.4.4.1.1 and 7.4.4.2.

¹ **Audio Band Magnetic signal - desired (ABM1):** Measured quantity of the desired magnetic signal

² **Audio Band Magnetic signal - undesired (ABM2):** Measured quantity of the undesired magnetic signal, such as interference from battery current and similar non-signal elements.

- e. At each measurement location, measure and record the desired T-Coil magnetic signals (ABM1 at f_i) as described in 7.4.4.2 in each individual ISO 266-1975 R10 standard 1/3 octave band. The desired audio band input frequency (f_i) shall be centered in each 1/3 octave band maintaining the same drive level as determined in item c) and the reading taken for that band.

Equivalent methods of determining the frequency response may also be employed, such as fast Fourier transform (FFT) analysis using noise excitation or input–output comparison using simulated speech. The full-band integrated or half-band integrated probe output, as specified in D.9, may be used, as long as the appropriate calibration curve is applied to the measured result, so as to yield an accurate measurement of the field magnitude. (The resulting measurement shall be an accurate measurement in dB A/m.)

All measurements of the desired signal shall be shown to be of the desired signal and not of an undesired signal. This may be shown by turning the desired signal ON and OFF with the probe measuring the same location. If the scanning method is used the scans shall show that all measurement points selected for the ABM1 measurement meet the ambient and test system noise criteria in 7.3.1.

- f. At the measurement location for each orientation, measure and record the undesired broadband audio magnetic signal (ABM2) as specified in 7.4.4.4 with no audio signal applied (or digital zero applied, if appropriate) using A-weighting and the half-band integrator. Calculate the ratio of the desired to undesired signal strength (i.e., signal quality).
- g. Obtain the data from the postprocessor, SEMCAD, and determine the category that properly classifies the signal quality based on Table 8.5.

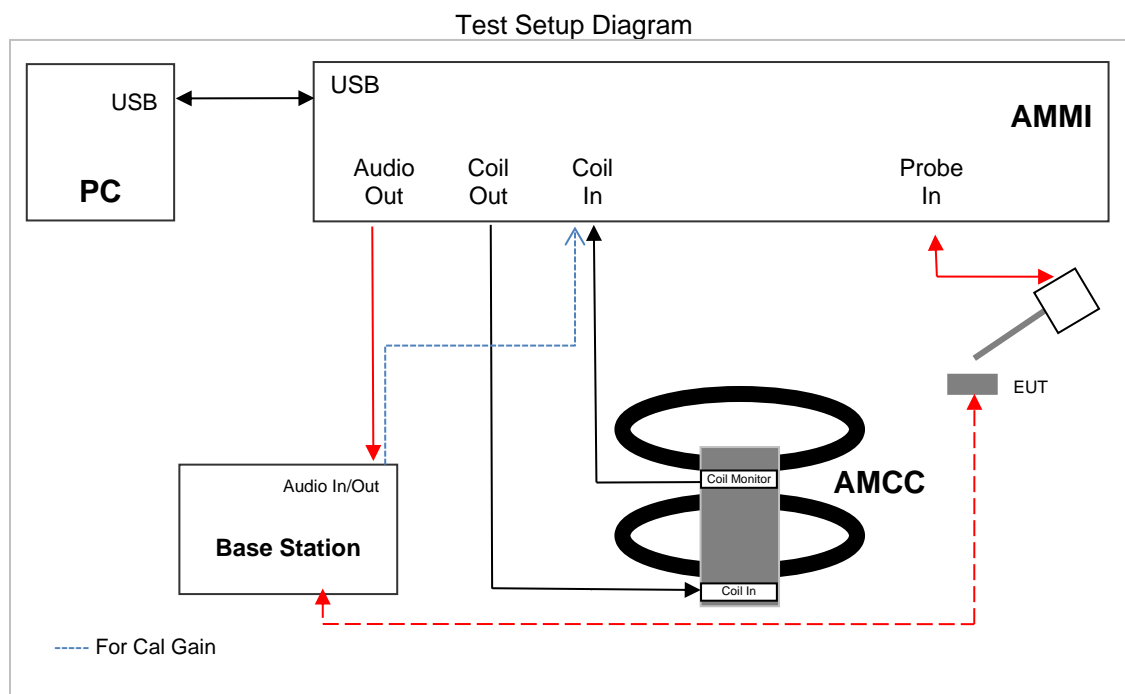

7. Audio Level and Gain Measurements

Establish a call and obtain the 1 kHz speech output signal at 3.14 dBm0 from the CMU200 using the Network Bitstream "Decoder Cal." Perform a measurement job to measure the RMS Coil Signal. Note the voltage level and calculate the desired level for GSM/W-CDMA and CDMA, which are, according to ANSI C63.19-2011 Section 7.4.2.1, -16 dBm0 and -18 dBm0 respectively. To determine the appropriate audio level, use the following equations, where x dBm0 is the measured RMS Coil Signal:

GSM/W-CDMA

$$\text{Audio Level}_{-16 \text{ dBm0}} = ((-16 \text{ dBm0}) - (3.14 \text{ dBm0})) + x \text{ dBV}$$

Audio Signal (dBm0)	Signal Type	Measured Audio Level
3.14	1 kHz sine	-2.51
-16		-21.65

Change the Network Bitstream from "Decoder Cal" to "Encoder Cal." Similarly, run a measurement job with the "Encoder Cal" codec active and set the Gain in the measurement job to 10. Note the RMS Coil signal. To calculate the gain, the following equation was used, where y dBm0 is the measured RMS Coil Signal for the "Encoder Cal" measurement:

GSM/W-CDMA

$$\text{Gain}_{-16 \text{ dBm0}} = 10^{((\text{Audio Level}_{-16 \text{ dBm0}} - y \text{ dBm0}) / 20) * 10}$$

Audio Signal (dBm0)	Signal Type	Measured Audio Level	Measured Coil Signal	Calculated Gain
-16	1 kHz sine	-21.65	-19.34	7.66

Finally, to determine the required gain for testing, we multiply the resultant gain with the required gain to achieve an approximate level of a 1 kHz sine signal.

RESULTS

Audio Signal (dBm0)	Signal Type	Required Gain Factor	Calculated Gain	Adjusted Gain*
-16	48k_voice_1kHz	4.33	7.66	33.17
	48k_voice_300-3000	8.48	7.66	64.96

* An adjustment was made to -16 dBm0's 48K_voice_1kHz and 48k_voice_300-3000. When the gain is set to 33.17 and 64.96, the Audio Level measured is -21.70 and -21.81 dBV respectively. The gain was manually adjusted until the Audio Level matched the original. The gains used for this project are **36.33** and **71.07** for 48K_voice_1kHz and 48k_voice_300-3000 respectively.

Establish a call and obtain the 1 kHz speech output signal at 3.14 dBm0 from the CMU200 using the Network Bitstream “Decoder Cal.” Perform a measurement job to measure the RMS Coil Signal. Note the voltage level and calculate the desired level for GSM/W-CDMA and CDMA, which are, according to ANSI C63.19-2011 Section 7.4.2.1, -16 dBm0 and -18 dBm0 respectively. To determine the appropriate audio level, use the following equations, where *x dBm0* is the measured RMS Coil Signal:

CDMA

$$\text{Audio Level}_{-18 \text{ dBm0}} = ((-18 \text{ dBm0}) - (3.14 \text{ dBm0})) + x \text{ dBv}$$

Audio Signal (dBm0)	Signal Type	Measured Audio Level
3.14	1 kHz sine	-2.51
-18		-23.65

Change the Network Bitstream from “Decoder Cal” to “Encoder Cal.” Similarly, run a measurement job with the “Encoder Cal” codec active and set the Gain in the measurement job to 10. Note the RMS Coil signal. To calculate the gain, the following equation was used, where *y dBm0* is the measured RMS Coil Signal for the “Encoder Cal” measurement:

CDMA

$$\text{Gain}_{-18 \text{ dBm0}} = 10^{((\text{Audio Level}_{-18 \text{ dBm0}} - y \text{ dBm0}) / 20) * 10}$$

Audio Signal (dBm0)	Signal Type	Measured Audio Level	Measured Coil Signal	Calculated Gain
-18	1 kHz sine	-23.65	-19.76	6.39

Finally, to determine the required gain for testing, we multiply the resultant gain with the required gain to achieve an approximate level of a 1 kHz sine signal.

RESULTS

Audio Signal (dBm0)	Signal Type	Required Gain Factor	Calculated Gain	Adjusted Gain*
-18	48k_voice_1kHz	4.33	6.39	27.67
	48k_voice_300-3000	8.48	6.39	54.19

* Adjustments were made to -18 dBm0's 48k_voice_1kHz and 48k_voice_300-3000. When the gain is set to 27.67 and 54.19, the Audio Levels are -23.67 and -23.74 dBVs respectively. The gain was manually adjusted until the Audio Levels matched the original. The gains used for this project are **27.75** and **54.75** for 48K_voice_1kHz and 48k_voice_300-3000 respectively.

8. T-coil Measurement Criteria

8.1. Frequency Response

The frequency response of the axial component of the magnetic field, measured in 1/3 octave bands, shall follow the response curve, over the frequency range 300 Hz to 3000 Hz.

Figure 8.1 and Figure 8.2 provide the boundaries for the specified frequency. These response curves are for true field strength measurements of the T-Coil signal. Thus the 6 dB/octave probe response has been corrected from the raw readings.

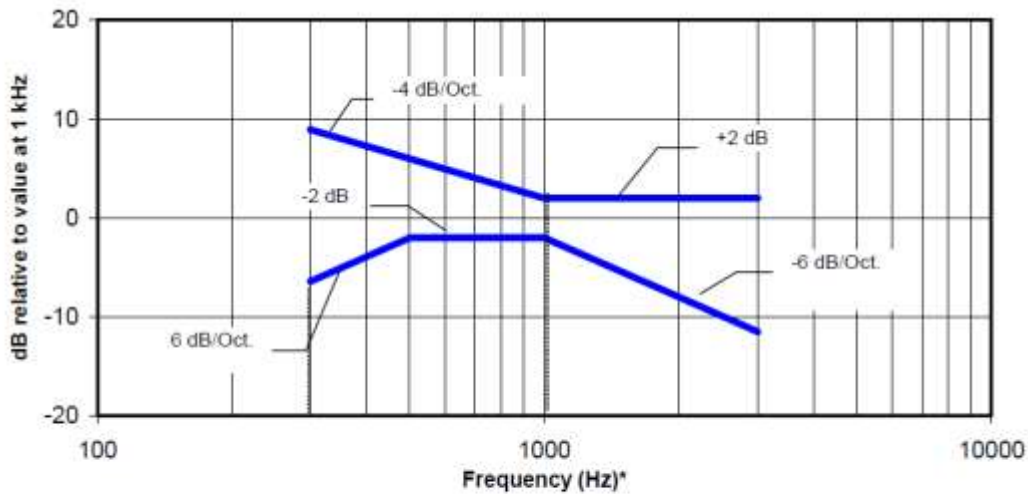

NOTE—The frequency response is between 300 Hz and 3000 Hz.

Figure 8.1—Magnetic field frequency response for WDs with field strength ≤ -15 dB (A/m) at 1 kHz

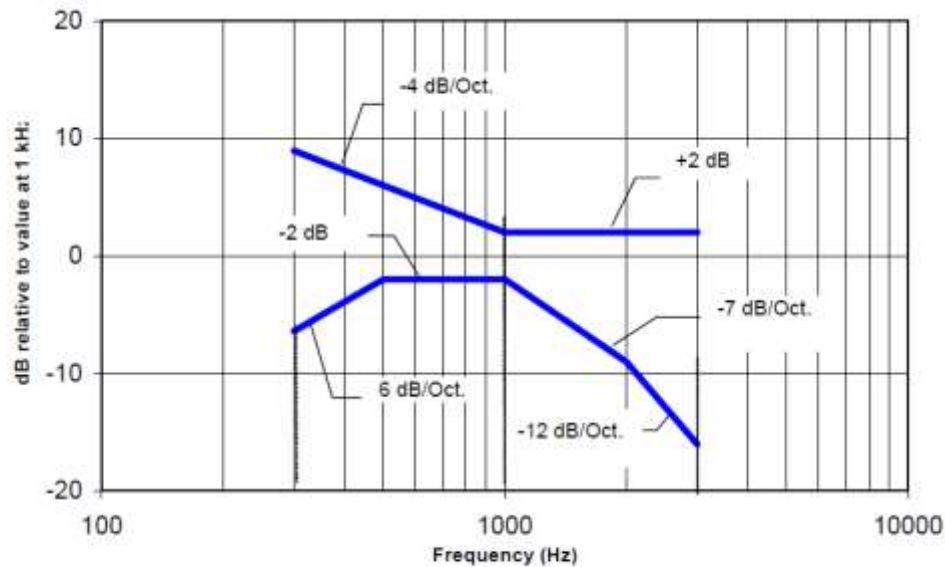

NOTE—The frequency response is between 300 Hz and 3000 Hz.

Figure 8.2—Magnetic field frequency response for WDs with a field that exceeds -15 dB(A/m) at 1 kHz

8.2. Signal to Noise

This specifies the signal-to-noise quality requirement for the intended T-Coil signal from a WD. The worst signal to noise of the two T-Coil signal measurements, as determined in Clause 7, shall be used to determine the T-Coil mode category per Table 8.5.

Only the RF immunity of the hearing aid is measured in T-Coil mode. It is assumed that a hearing aid can have no immunity to an interference signal in the audio band, which is the intended reception band for this mode. So, the only criterion that can be measured is the RF immunity in T-Coil Mode. This is measured using the same procedure as for the audio coupling mode and at the same levels as specified in 6.4.

Table 8.5—T-Coil signal-to-noise categories

Category	Telephone parameters WD signal quality [(signal + noise)-to-noise ratio in decibels]
Category T1	0 dB to 10 dB
Category T2	10 dB to 20 dB
Category T3	20 dB to 30 dB
Category T4	>30 dB

Measurement locations and reference plane to be used for the T-coil measurements

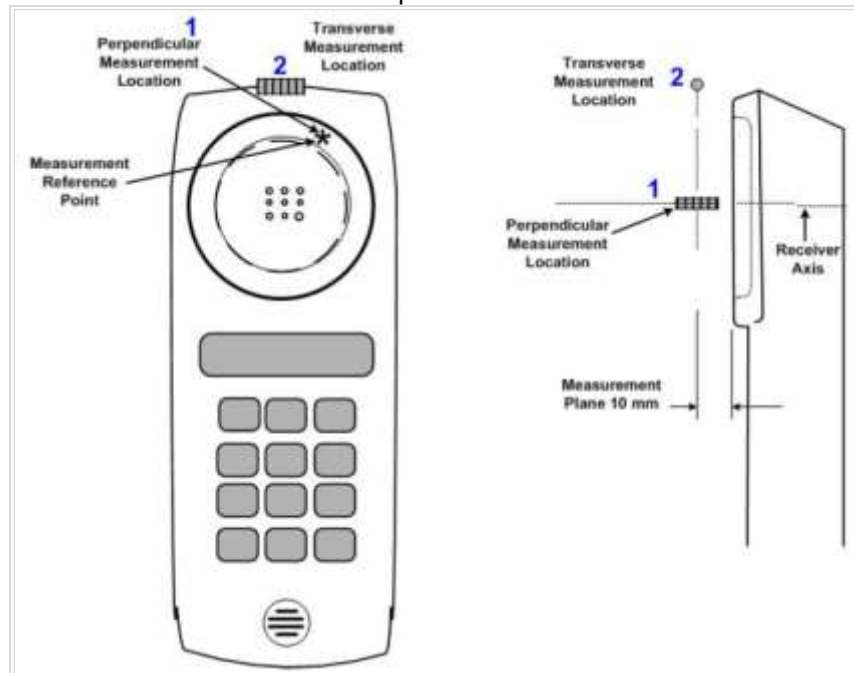

9. HAC (T-coil) Test Results

Mode	Channel and Frequency	Probe Orientation	Frequency Response	ABM1 ≥ -16 dB (A/m)	BWC Factor (dB)	ABM SNR (dB)	T-Rating
GSM850 Voice Coder Speechcodec Low	190 836.6 MHz	z (axial)	Pass	-8.11	0.16	32.48	T4
		y (Transversal)		-8.64	0.16	29.22	T3
GSM1900 Voice Coder Speechcodec Low	661 1880 MHz	z (axial)	Pass	-6.90	0.16	35.03	T4
		y (Transversal)		-8.62	0.16	30.51	T4
W-CDMA Band V Voice Coder Speechcodec Low	4183 836.6 MHz	z (axial)	Pass	1.63	0.16	44.31	T4
		y (Transversal)		-6.61	0.16	41.09	T4
W-CDMA Band II Voice Coder Speechcodec Low	9400 1880 MHz	z (axial)	Pass	-0.85	0.16	43.26	T4
		y (Transversal)		-6.44	0.16	38.70	T4
Mode	Channel and Frequency	Probe Orientation	Frequency Response	ABM1 ≥ -18 dB (A/m)	BWC Factor (dB)	ABM SNR (dB)	T-Rating
CDMA2000 BC0 RC1 / SO3 Voice Coder: 8K EVRC Low	384 836.52 MHz	z (axial)	Pass	-2.72	0.16	44.81	T4
		y (Transversal)		-5.26	0.16	41.93	T4
CDMA2000 BC1 RC1 / SO3 Voice Coder: 8K EVRC Low	600 1880 MHz	z (axial)	Pass	1.71	0.16	46.79	T4
		y (Transversal)		-3.76	0.16	44.32	T4

Note:

The radial longitudinal (x axis) measurements are no longer required per ANSI C63.19-2011

9.1. Worst Case T-Coil Test Plot

Test Laboratory: UL Verification Services Inc., SAR Lab 2

Date: 4/3/2015

GSM 850

Communication System: UID 0, GPRS-FDD (TDMA, GMSK, 1 slot) (0); Frequency: 836.6 MHz; Duty Cycle: 1:8.00018
 Phantom section: TCoil Section

DASY5 Configuration:

- Probe: AM1DV3 - 3092; ; Calibrated: 7/18/2014
- Sensor-Surface: 0mm (Fix Surface)
- Electronics: DAE4 Sn1259; Calibrated: 1/14/2015
- Phantom: HAC Test Arch with AMCC; Type: SD HAC P01 BB
- Measurement SW: DASY52, Version 52.8 (7);SEMCAD X Version 14.6.10 (7164)

T-Coil scan (scan for ANSI C63.19-2007 & 2011 compliance)/General Scans ch 190/y (transversal) 4.2mm 50 x 50/ABM Interpolated SNR(x,y,z) (121x121x1): Interpolated grid:

dx=1.000 mm, dy=1.000 mm
 Signal Type: Audio File (.wav) 48k_voice_1kHz_1s.wav
 Output Gain: 36.33
 Measure Window Start: 300ms
 Measure Window Length: 1000ms
 BWC applied: 0.16 dB
 Device Reference Point: 0, 0, -6.3 mm

Cursor:

ABM1/ABM2 = 29.22 dB
 ABM1 comp = -8.64 dBA/m
 BWC Factor = 0.16 dB
 Location: 2.9, 4.6, 3.7 mm

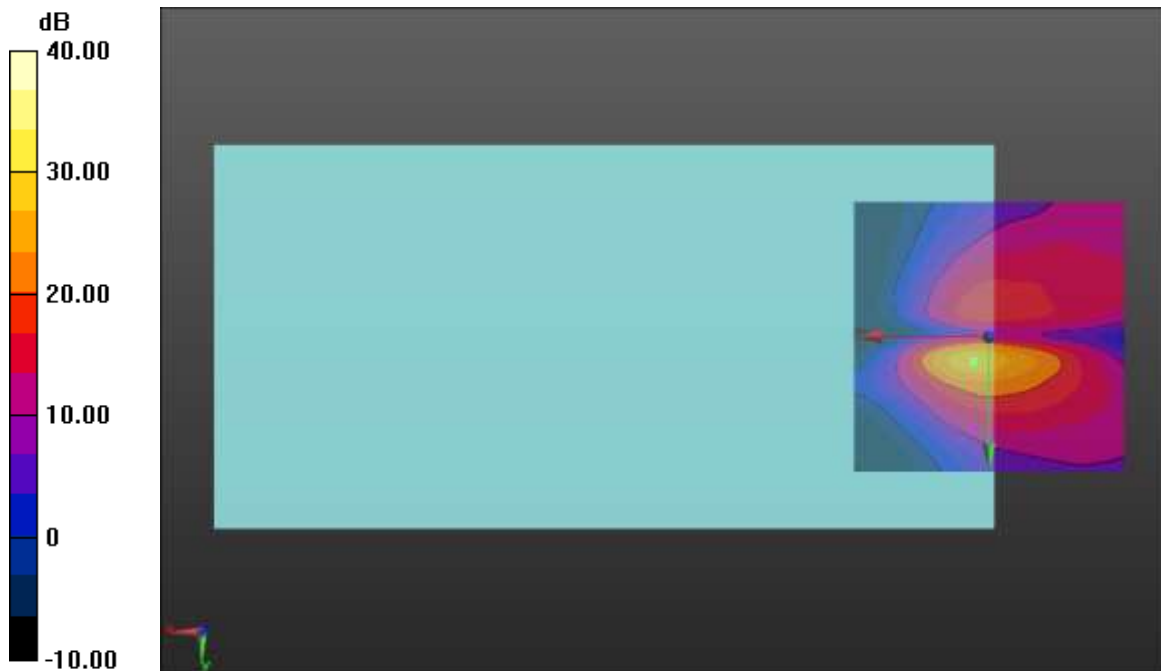

0 dB = 1.000 = 0.00 dB

Appendix

Refer to separated files for the following appendixes

A_15U20107v0 Setup Photo

B_15U20107v0 Frequency Response & SNR Test Plots

C_15U20107v0 Probe Cal. Certificates

END OF REPORT