



FCC RADIO TEST REPORT

FCC ID : PY7-87261H
Equipment : GSM/WCDMA/LTE Phone with BT, DTS/UNII
a/b/g/n/ac/ax, GPS, WPC and NFC
Brand Name : Sony
Applicant : Sony Mobile Communications Inc.
4-12-3 Higashi-Shinagawa, Shinagawa-ku,
Tokyo, 140-0002, Japan
Manufacturer : Sony Mobile Communications Inc.
4-12-3 Higashi-Shinagawa, Shinagawa-ku,
Tokyo, 140-0002, Japan
Standard : FCC Part 15 Subpart C §15.247

The product was received on Dec. 04, 2019 and testing was started from Dec. 22, 2019 and completed on Jan. 31, 2020. We, SPORTON INTERNATIONAL INC. EMC & Wireless Communications Laboratory, would like to declare that the tested sample has been evaluated in accordance with the test procedures and has been in compliance with the applicable technical standards.

The report must not be used by the client to claim product certification, approval, or endorsement by TAF or any agency of government.

The test results in this report apply exclusively to the tested model / sample. Without written approval of SPORTON INTERNATIONAL INC. EMC & Wireless Communications Laboratory, the test report shall not be reproduced except in full.

Louis Wu

Approved by: Louis Wu

SPORTON INTERNATIONAL INC. EMC & Wireless Communications Laboratory

No. 52, Huaya 1st Rd., Guishan Dist., Taoyuan City, Taiwan (R.O.C.)



Table of Contents

History of this test report 3

Summary of Test Result..... 4

1 General Description 5

 1.1 Product Feature of Equipment Under Test..... 5

 1.2 Modification of EUT..... 5

 1.3 Testing Location..... 6

 1.4 Applicable Standards 6

2 Test Configuration of Equipment Under Test 7

 2.1 Carrier Frequency Channel..... 7

 2.2 Test Mode..... 8

 2.3 Connection Diagram of Test System..... 9

 2.4 Support Unit used in test configuration and system 11

 2.5 EUT Operation Test Setup..... 11

 2.6 Measurement Results Explanation Example 11

3 Test Result..... 12

 3.1 Number of Channel Measurement 12

 3.2 Hopping Channel Separation Measurement 14

 3.3 Dwell Time Measurement 20

 3.4 20dB and 99% Bandwidth Measurement 22

 3.5 Output Power Measurement 33

 3.6 Conducted Band Edges Measurement 34

 3.7 Conducted Spurious Emission Measurement 41

 3.8 Radiated Band Edges and Spurious Emission Measurement 51

 3.9 AC Conducted Emission Measurement 56

 3.10 Antenna Requirements 58

4 List of Measuring Equipment..... 59

5 Uncertainty of Evaluation..... 61

Appendix A. Conducted Test Results

Appendix B. AC Conducted Emission Test Result

Appendix C. Radiated Spurious Emission

Appendix D. Radiated Spurious Emission Plots

Appendix E. Duty Cycle Plots



History of this test report

Report No.	Version	Description	Issued Date
FR901542-02A	01	Initial issue of report	Feb. 04, 2020



Summary of Test Result

Report Clause	Ref Std. Clause	Test Items	Result (PASS/FAIL)	Remark
3.1	15.247(a)(1)	Number of Channels	Pass	-
3.2	15.247(a)(1)	Hopping Channel Separation	Pass	-
3.3	15.247(a)(1)	Dwell Time of Each Channel	Pass	-
3.4	15.247(a)(1)	20dB Bandwidth	Pass	-
3.4	2.1049	99% Occupied Bandwidth	Reporting only	-
3.5	15.247(b)(1)	Peak Output Power	Pass	-
3.6	15.247(d)	Conducted Band Edges	Pass	-
3.7	15.247(d)	Conducted Spurious Emission	Pass	-
3.8	15.247(d)	Radiated Band Edges and Radiated Spurious Emission	Pass	Under limit 22.66 dB at 2483.720 MHz
3.9	15.207	AC Conducted Emission	Pass	Under limit 11.23 dB at 1.585 MHz
3.10	15.203 & 15.247(b)	Antenna Requirement	Pass	-

Declaration of Conformity:

The test results with all measurement uncertainty excluded are presented in accordance with the regulation limits or requirements declared by manufacturers.

Comments and Explanations:

The declared of product specification for EUT presented in the report are provided by the manufacturer, and the manufacturer takes all the responsibilities for the accuracy of product specification.

Reviewed by: Wii Chang**Report Producer: Yvonne Cheng**



1 General Description

1.1 Product Feature of Equipment Under Test

GSM/WCDMA/LTE, Bluetooth, DTS/UNII a/b/g/n/ac/ax, NFC, GNSS and WPC.

Standards-related Product Specification	
Antenna Type / Gain	Loop Antenna with gain -2.40 dBi

EUT Information List			
HW Version	SW Version	S/N	Performed Test Item
A	0.261	BH950071J7	RF conducted measurement
	2.98	QV7100AP2A	Radiated Spurious Emission
	2.38	QV7100Q62A	AC Conducted Emission

Accessory List	
AC Adapter	Model Name : UCH32
	S/N: 6218W30200178 (for Radiated Spurious Emission) 6218W30200005 (for Conducted Emission)
Earphone	Model Name : STH40D
	S/N : S458096
Bluetooth Earphone	Model Name : SBH82D
	S/N : N/A
USB Cable	Model Name : UCB24
	S/N : N/A
Audio Cable	Model Name : EC234
	S/N : N/A

Note:

1. Above EUT list used are electrically identical per declared by manufacturer.
2. Above the accessories list are used to exercise the EUT during test, and the serial number of each type of accessories is listed in each section of this report. .
3. For other wireless features of this EUT, test report will be issued separately.

1.2 Modification of EUT

No modifications are made to the EUT during all test items.



1.3 Testing Location

Test Site	SPORTON INTERNATIONAL INC. EMC & Wireless Communications Laboratory	
Test Site Location	No.52, Huaya 1st Rd., Guishan Dist., Taoyuan City, Taiwan (R.O.C.) TEL: +886-3-327-3456 FAX: +886-3-328-4978	
Test Site No.	Sporton Site No.	
	TH05-HY	CO05-HY

Note: The test site complies with ANSI C63.4 2014 requirement.

Test Site	SPORTON INTERNATIONAL INC. EMC & Wireless Communications Laboratory	
Test Site Location	No.58, Aly. 75, Ln. 564, Wenhua 3rd, Rd., Guishan Dist., Taoyuan City, Taiwan (R.O.C.) TEL: +886-3-327-0868 FAX: +886-3-327-0855	
Test Site No.	Sporton Site No.	
	03CH16-HY	

Note: The test site complies with ANSI C63.4 2014 requirement.

FCC Designation No.: TW1190 and TW0007

1.4 Applicable Standards

According to the specifications of the manufacturer, the EUT must comply with the requirements of the following standards:

- ♦ FCC Part 15 Subpart C §15.247
- ♦ FCC KDB Publication No. 558074 D01 DTS Meas. Guidance v05r02
- ♦ FCC KDB 414788 D01 Radiated Test Site v01r01.
- ♦ ANSI C63.10-2013

Remark:

1. All test items were verified and recorded according to the standards and without any deviation during the test.
2. This EUT has also been tested and complied with the requirements of FCC Part 15, Subpart B, recorded in a separate test report.



2 Test Configuration of Equipment Under Test

2.1 Carrier Frequency Channel

Frequency Band	Channel	Freq. (MHz)	Channel	Freq. (MHz)	Channel	Freq. (MHz)
2400-2483.5 MHz	0	2402	27	2429	54	2456
	1	2403	28	2430	55	2457
	2	2404	29	2431	56	2458
	3	2405	30	2432	57	2459
	4	2406	31	2433	58	2460
	5	2407	32	2434	59	2461
	6	2408	33	2435	60	2462
	7	2409	34	2436	61	2463
	8	2410	35	2437	62	2464
	9	2411	36	2438	63	2465
	10	2412	37	2439	64	2466
	11	2413	38	2440	65	2467
	12	2414	39	2441	66	2468
	13	2415	40	2442	67	2469
	14	2416	41	2443	68	2470
	15	2417	42	2444	69	2471
	16	2418	43	2445	70	2472
	17	2419	44	2446	71	2473
	18	2420	45	2447	72	2474
	19	2421	46	2448	73	2475
	20	2422	47	2449	74	2476
	21	2423	48	2450	75	2477
	22	2424	49	2451	76	2478
	23	2425	50	2452	77	2479
	24	2426	51	2453	78	2480
	25	2427	52	2454	-	-
	26	2428	53	2455	-	-



2.2 Test Mode

- a. The EUT has been associated with peripherals and configuration operated in a manner tended to maximize its emission characteristics in a typical application. Frequency range investigated: conduction emission (150 kHz to 30 MHz), radiation emission (9 kHz to the 10th harmonic of the highest fundamental frequency or to 40 GHz, whichever is lower). For radiated measurement, pre-scanned in three orthogonal panels, X, Y, Z. The worst cases (X plane) were recorded in this report, and the worst mode of radiated spurious emissions is Bluetooth 3Mbps mode, and recorded in this report.
- b. AC power line Conducted Emission was tested under maximum output power.

The following summary table is showing all test modes to demonstrate in compliance with the standard.

Summary table of Test Cases			
Test Item	Data Rate / Modulation		
	Bluetooth BR 1Mbps GFSK	Bluetooth EDR 2Mbps $\pi/4$ -DQPSK	Bluetooth EDR 3Mbps 8-DPSK
Conducted Test Cases	Mode 1: CH00_2402 MHz Mode 2: CH39_2441 MHz Mode 3: CH78_2480 MHz	Mode 4: CH00_2402 MHz Mode 5: CH39_2441 MHz Mode 6: CH78_2480 MHz	Mode 7: CH00_2402 MHz Mode 8: CH39_2441 MHz Mode 9: CH78_2480 MHz
Radiated Test Cases	Bluetooth 1Mbps GFSK / EDR 2Mbps $\pi/4$-DQPSK / EDR 3Mbps 8-DPSK		
	Mode 1: CH00_2402 MHz for 1Mbps Mode 2: CH39_2441 MHz for 1Mbps Mode 3: CH78_2480 MHz for 1Mbps Mode 4: CH00_2402 MHz for 2Mbps Mode 5: CH39_2441 MHz for 2Mbps Mode 6: CH78_2480 MHz for 2Mbps Mode 7: CH00_2402 MHz for 3Mbps Mode 8: CH39_2441 MHz for 3Mbps Mode 9: CH78_2480 MHz for 3Mbps		
AC Conducted Emission	Mode 1 : GSM850 Idle + Bluetooth Link + WLAN (2.4GHz) Link + MPEG4 + USB Cable (Charging from Adapter) + Earphone + Battery Mode 2 : GSM850 Idle + Bluetooth Link + WLAN (2.4GHz) Link + MPEG4 + Earphone + Battery + WPC Charging pad (Charging from Adapter)		

2.3 Connection Diagram of Test System

<AC Conducted Emission>

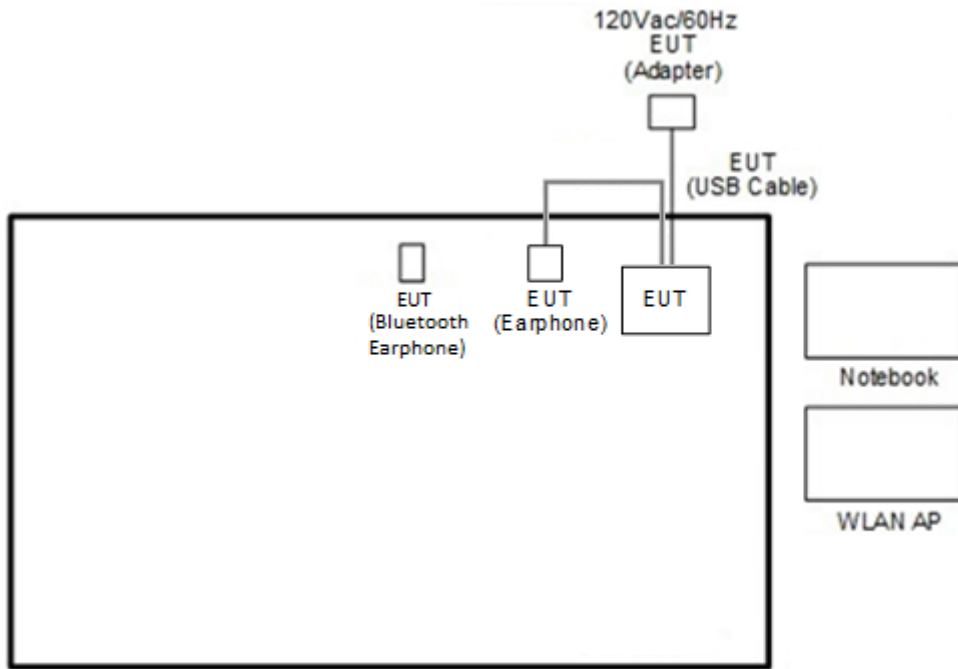

<AC Conducted Emission with WPC Charger>

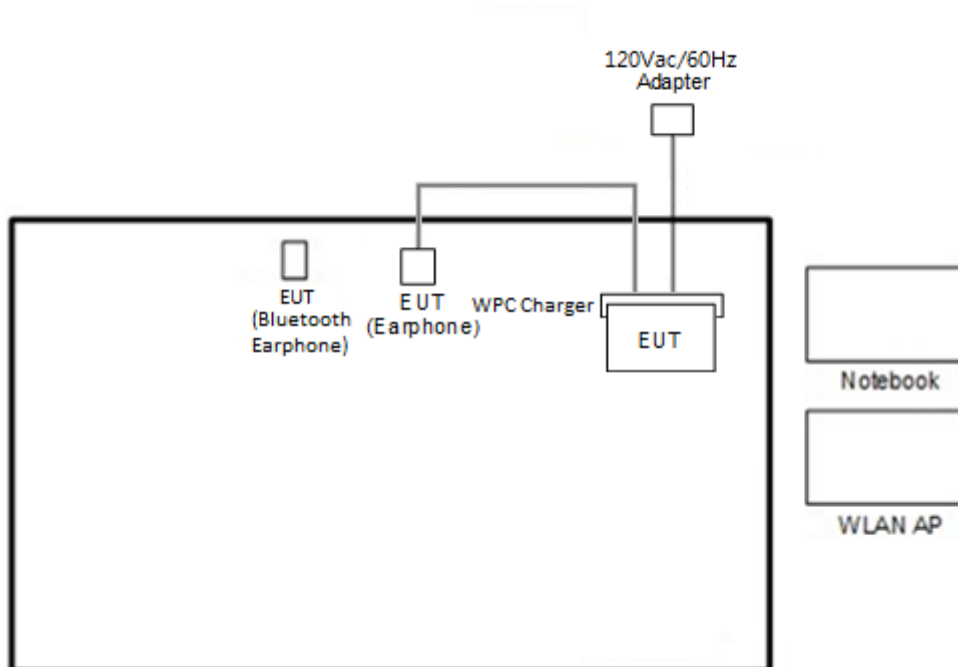

<For Radiated Emissions Measurement >

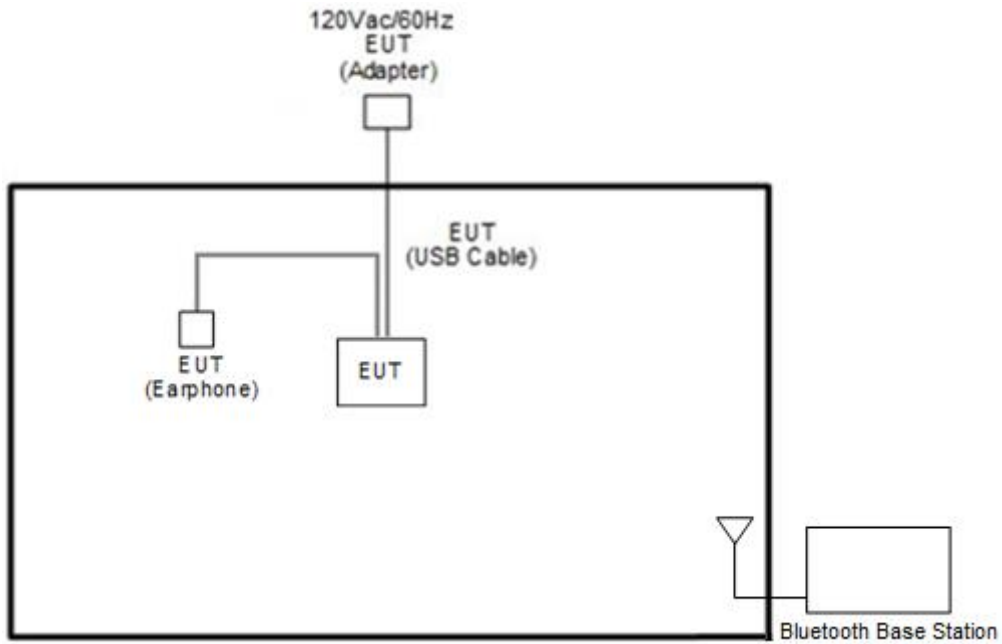

<For Radiated Emissions Measurement with WPC Charger>

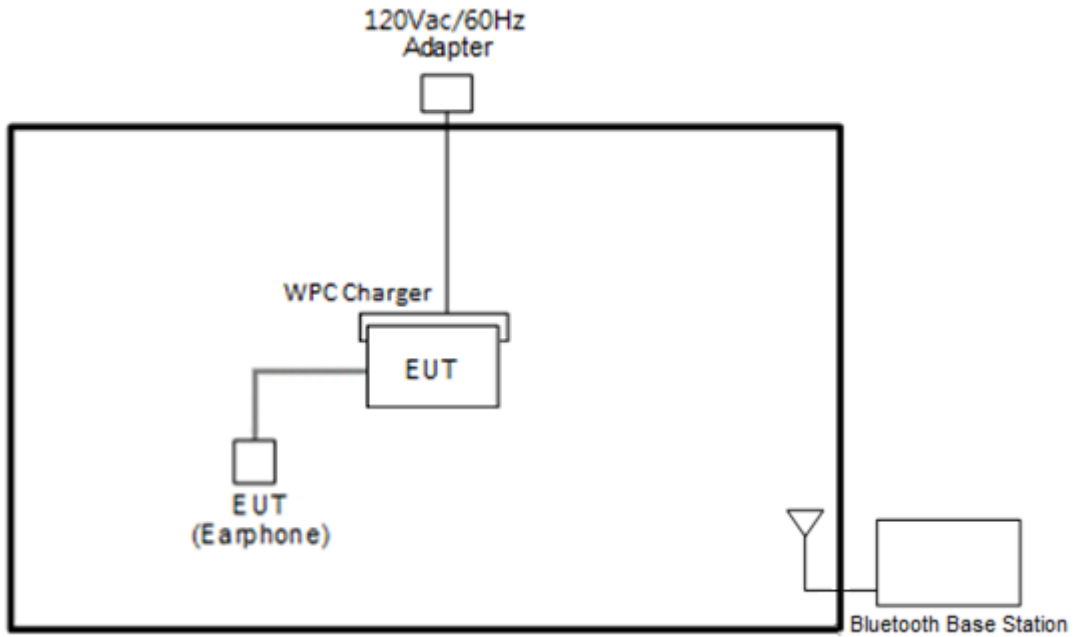



2.4 Support Unit used in test configuration and system

Item	Equipment	Trade Name	Model Name	FCC ID	Data Cable	Power Cord
1.	System Simulator	R&S	CMU 200	N/A	N/A	Unshielded, 1.8 m
2.	Bluetooth Base Station	R&S	CBT32	N/A	N/A	Unshielded, 1.8 m
3.	WLAN AP	ASUS	RT-AC66U	MSQ-RTAC66U	N/A	Unshielded, 1.8 m
4.	Notebook	DELL	Latitude E3400	FCC DoC	N/A	AC I/P: Unshielded, 1.2 m DC O/P: Shielded, 1.8 m
5.	SD Card	SanDisk	MicroSD HC	FCC DoC	N/A	N/A
6.	Wireless charging pad	belkin	F7U050	N/A	N/A	N/A

2.5 EUT Operation Test Setup

The RF test items, utility “FTMC_bridge_forURC_v0.39” was installed in Notebook which was programmed in order to make the EUT get into the engineering modes to contact with base station to provide channel selection, power level, data rate and the application type and for continuous transmitting signals.

2.6 Measurement Results Explanation Example

For all conducted test items:

The offset level is set in the spectrum analyzer to compensate the RF cable loss and attenuator factor between EUT conducted output port and spectrum analyzer. With the offset compensation, the spectrum analyzer reading level is exactly the EUT RF output level.

Example:

The spectrum analyzer offset is derived from RF cable loss and attenuator factor.

Offset = RF cable loss + attenuator factor.

Following shows an offset computation example with cable loss 4.2 dB and 10dB attenuator.

Offset(dB) = RF cable loss(dB) + attenuator factor(dB).

$$= 4.2 + 10 = 14.2 \text{ (dB)}$$

3 Test Result

3.1 Number of Channel Measurement

3.1.1 Limits of Number of Hopping Frequency

Frequency hopping systems in the 2400-2483.5 MHz band shall use at least 15 channels.

3.1.2 Measuring Instruments

See list of measuring equipment of this test report.

3.1.3 Test Procedure

1. The testing follows ANSI C63.10-2013 clause 7.8.3.
2. The RF output of EUT was connected to the spectrum analyzer by RF cable and attenuator. The path loss was compensated to the results for each measurement.
3. Set to the maximum power setting and enable the EUT transmit continuously.
4. Enable the EUT hopping function.
5. Use the following spectrum analyzer settings: Span = the frequency band of operation; RBW = 300kHz; VBW \geq RBW; Sweep = auto; Detector function = peak; Trace = max hold.
6. The number of hopping frequency used is defined as the number of total channel.
7. Record the measurement data derived from spectrum analyzer.

3.1.4 Test Setup





3.1.5 Test Result of Number of Hopping Frequency

Please refer to Appendix A.

Number of Hopping Channel Plot on Channel 00 - 78

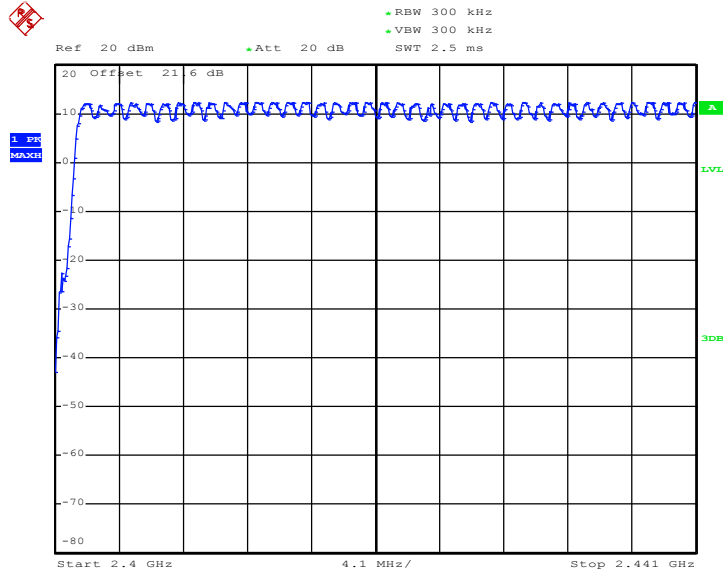

Date: 14.JAN.2020 21:14:14

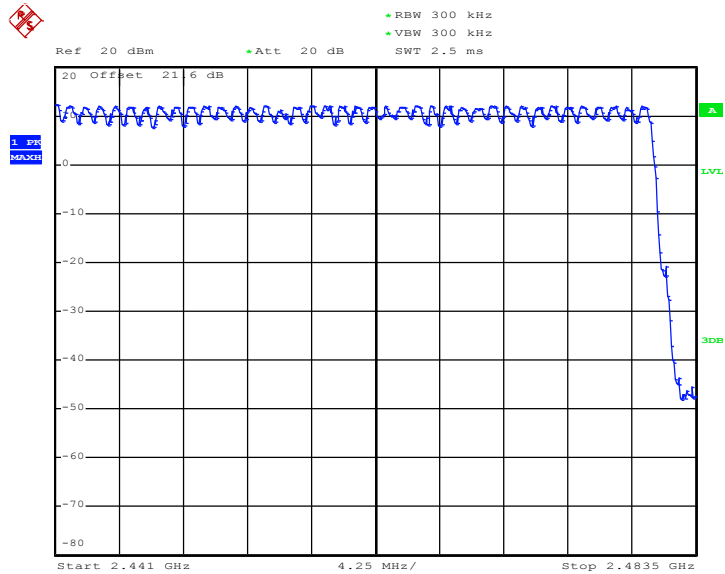

Date: 14.JAN.2020 21:15:14

3.2 Hopping Channel Separation Measurement

3.2.1 Limit of Hopping Channel Separation

Frequency hopping systems operating in the 2400-2483.5 MHz band may have hopping channel carrier frequencies that are separated by 25 kHz or two-thirds of the 20 dB bandwidth of the hopping channel, whichever is greater.

3.2.2 Measuring Instruments

See list of measuring equipment of this test report.

3.2.3 Test Procedures

1. The testing follows ANSI C63.10-2013 clause 7.8.2.
2. The RF output of EUT was connected to the spectrum analyzer by RF cable and attenuator. The path loss was compensated to the results for each measurement.
3. Set to the maximum power setting and enable the EUT transmit continuously.
4. Enable the EUT hopping function.
5. Use the following spectrum analyzer settings:
Span = wide enough to capture the peaks of two adjacent channels;
RBW = 300kHz; VBW \geq RBW; Sweep = auto; Detector function = peak; Trace = max hold.
6. Measure and record the results in the test report.

3.2.4 Test Setup

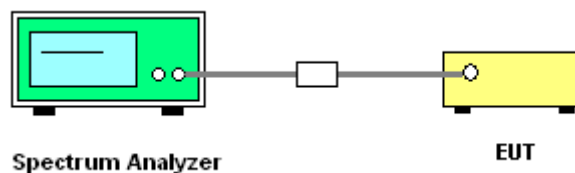

3.2.5 Test Result of Hopping Channel Separation

Please refer to Appendix A.



<1Mbps>

Channel Separation Plot on Channel 00 - 01

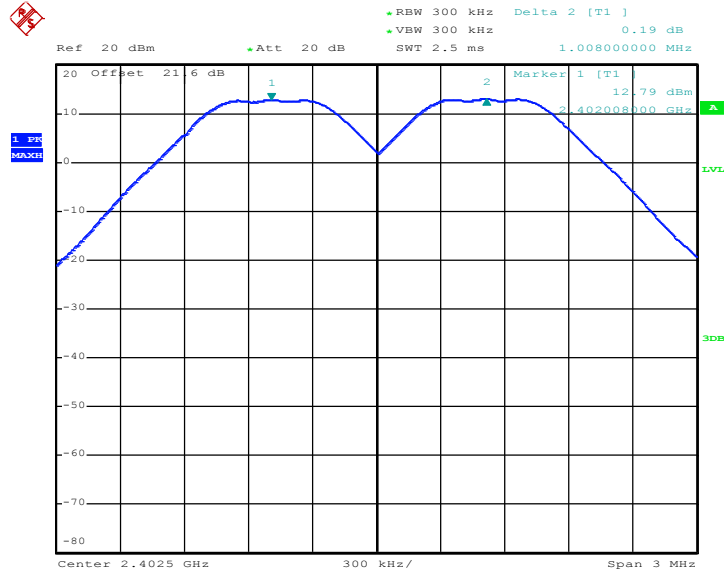

Date: 14.JAN.2020 21:50:54

Channel Separation Plot on Channel 39 - 40

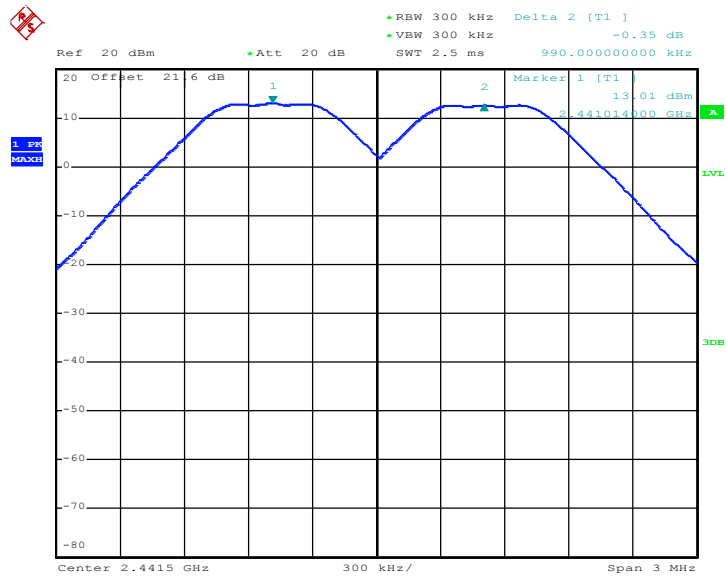

Date: 14.JAN.2020 22:17:18



Channel Separation Plot on Channel 77 - 78

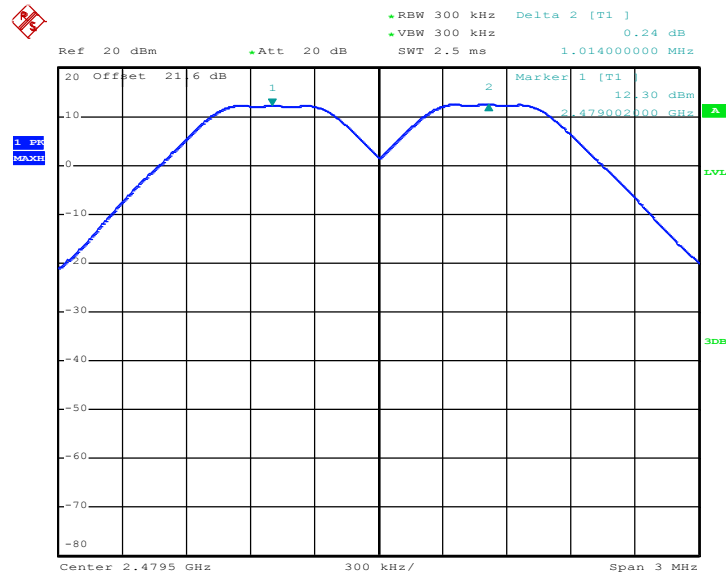

Date: 14.JAN.2020 22:43:08

<2Mbps>

Channel Separation Plot on Channel 00 - 01

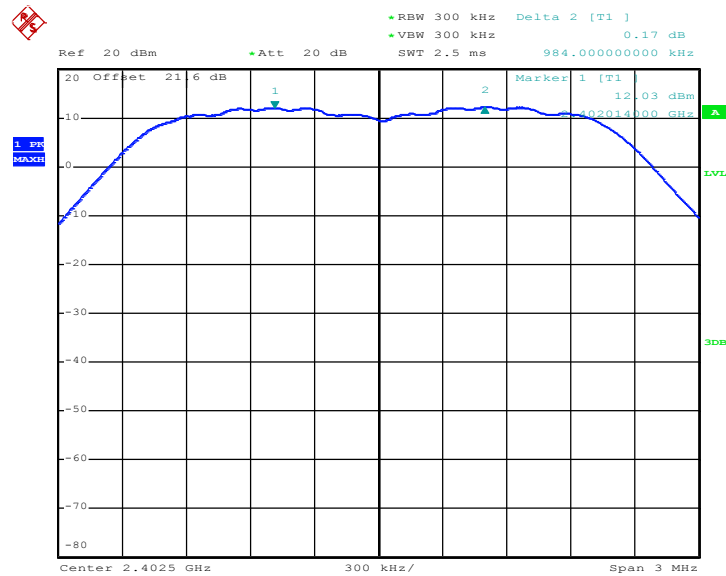

Date: 14.JAN.2020 23:43:06



Channel Separation Plot on Channel 39 - 40

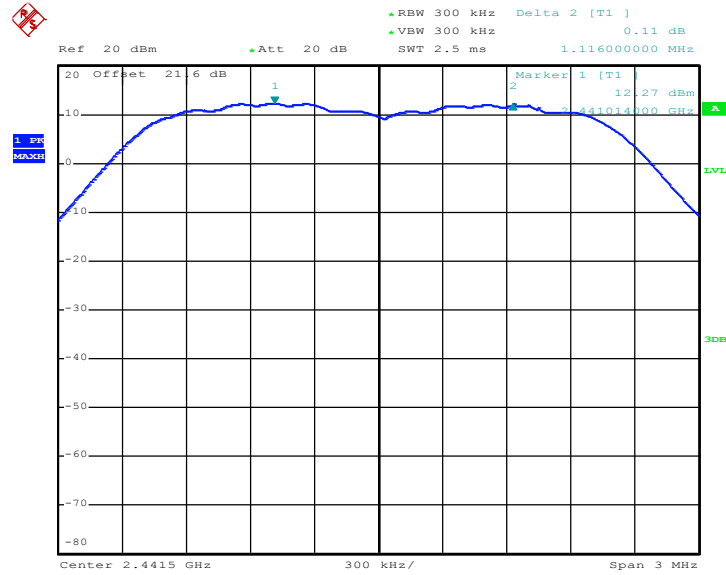

Date: 14.JAN.2020 23:49:54

Channel Separation Plot on Channel 77 - 78

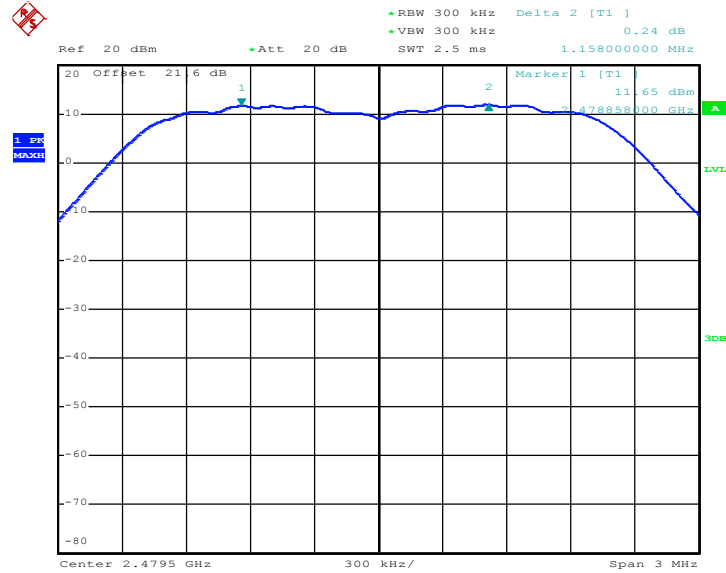

Date: 15.JAN.2020 00:01:44



<3Mbps>

Channel Separation Plot on Channel 00 - 01

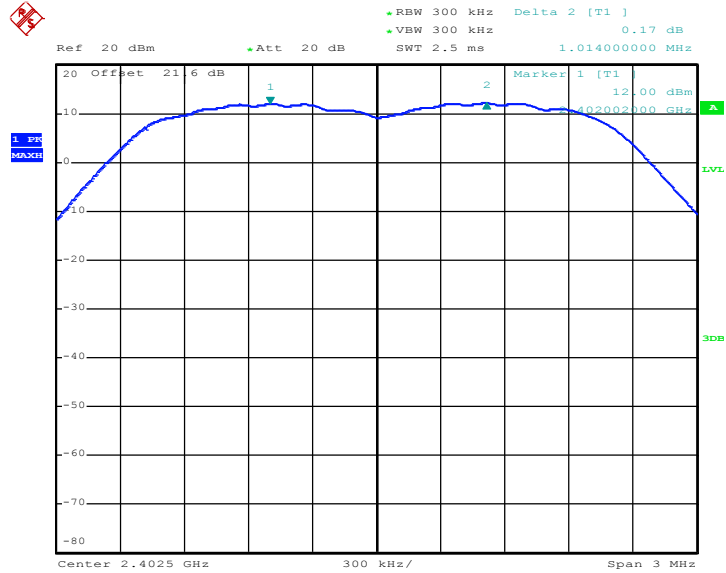

Date: 15.JAN.2020 00:12:55

Channel Separation Plot on Channel 39 - 40

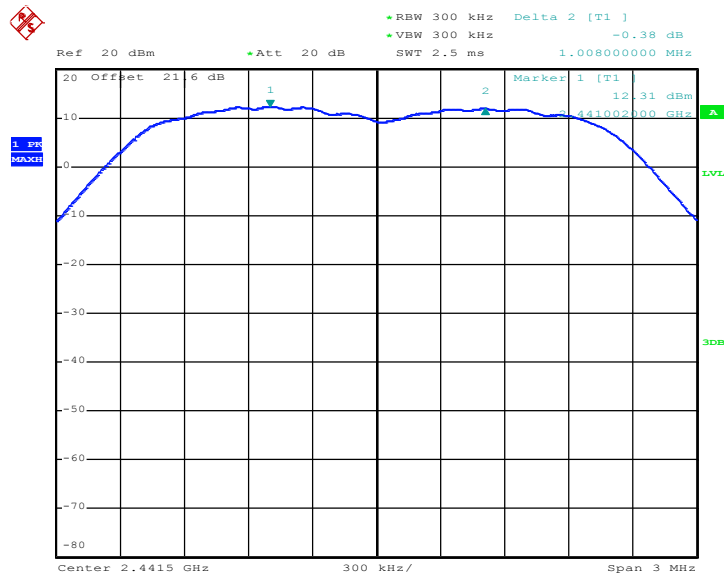

Date: 15.JAN.2020 00:19:36



Channel Separation Plot on Channel 77 - 78

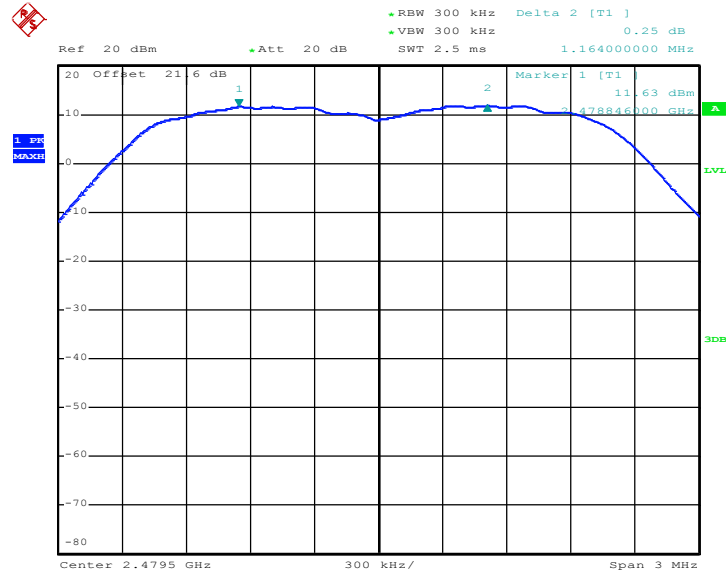

Date: 15.JAN.2020 00:27:34

3.3 Dwell Time Measurement

3.3.1 Limit of Dwell Time

The average time of occupancy on any channel shall not be greater than 0.4 seconds within a period of 0.4 seconds multiplied by the number of hopping channels employed.

3.3.2 Measuring Instruments

See list of measuring equipment of this test report.

3.3.3 Test Procedures

1. The testing follows ANSI C63.10-2013 clause 7.8.4.
2. The RF output of EUT was connected to the spectrum analyzer by RF cable and attenuator. The path loss was compensated to the results for each measurement.
3. Set to the maximum power setting and enable the EUT transmit continuously.
4. Enable the EUT hopping function.
5. Use the following spectrum analyzer settings: Span = zero span, centered on a hopping channel; RBW = 1 MHz; VBW \geq RBW; Sweep = as necessary to capture the entire dwell time per hopping channel; Detector function = peak; Trace = max hold.
6. Measure and record the results in the test report.

3.3.4 Test Setup



3.3.5 Test Result of Dwell Time

Please refer to Appendix A.



Package Transfer Time Plot

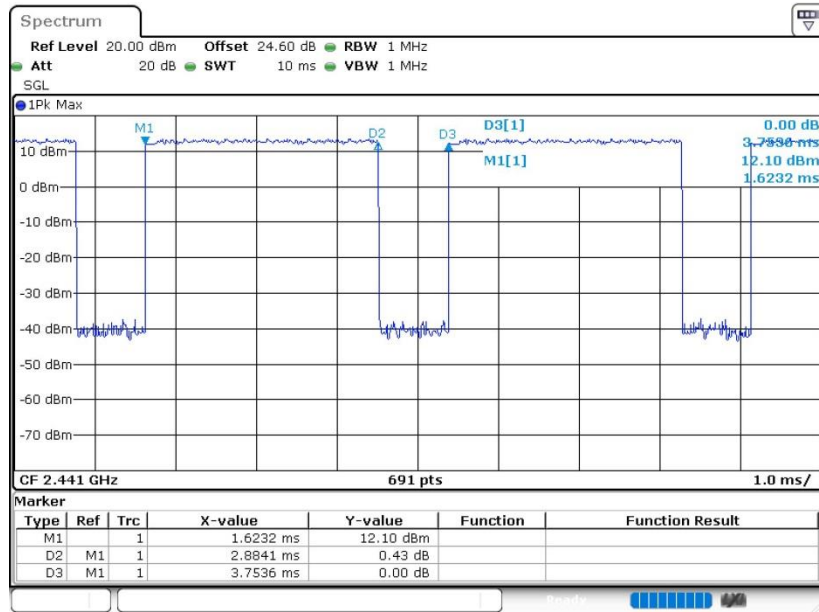

Date: 22.DEC.2019 18:37:39

Remark:

1. In normal mode, hopping rate is 1600 hops/s with 6 slots in 79 hopping channels. With channel hopping rate (1600 / 6 / 79) in Occupancy Time Limit (0.4 x 79) (s), Hops Over Occupancy Time comes to (1600 / 6 / 79) x (0.4 x 79) = 106.67 hops.
2. In AFH mode, hopping rate is 800 hops/s with 6 slots in 20 hopping channels. With channel hopping rate (800 / 6 / 20) in Occupancy Time Limit (0.4 x 20) (s), Hops Over Occupancy Time comes to (800 / 6 / 20) x (0.4 x 20) = 53.33 hops.
3. Dwell Time(s) = Hops Over Occupancy Time (hops) x Package Transfer Time

3.4 20dB and 99% Bandwidth Measurement

3.4.1 Limit of 20dB and 99% Bandwidth

Reporting only

3.4.2 Measuring Instruments

See list of measuring equipment of this test report.

3.4.3 Test Procedures

1. The testing follows ANSI C63.10-2013 clause 6.9.2 and 6.9.3.
2. The RF output of EUT was connected to the spectrum analyzer by RF cable and attenuator. The path loss was compensated to the results for each measurement.
3. Set to the maximum power setting and enable the EUT transmit continuously.
4. Use the following spectrum analyzer settings for 20dB Bandwidth measurement.
Span = approximately 2 to 5 times the 20 dB bandwidth, centered on a hopping channel;
RBW \geq 1-5% of the OBW; VBW \geq RBW; Sweep = auto; Detector function = peak;
Trace = max hold.
5. Use the following spectrum analyzer settings for 99 % Bandwidth measurement.
Span = approximately 1.5 to 5 times the 99% bandwidth, centered on a hopping channel;
RBW \geq 1-5% of the 99% bandwidth; VBW \geq 3 * RBW; Sweep = auto; Detector function = peak;
Trace = max hold.
6. Measure and record the results in the test report.

3.4.4 Test Setup



3.4.5 Test Result of 20dB Bandwidth

Please refer to Appendix A.



<1Mbps>

20 dB Bandwidth Plot on Channel 00

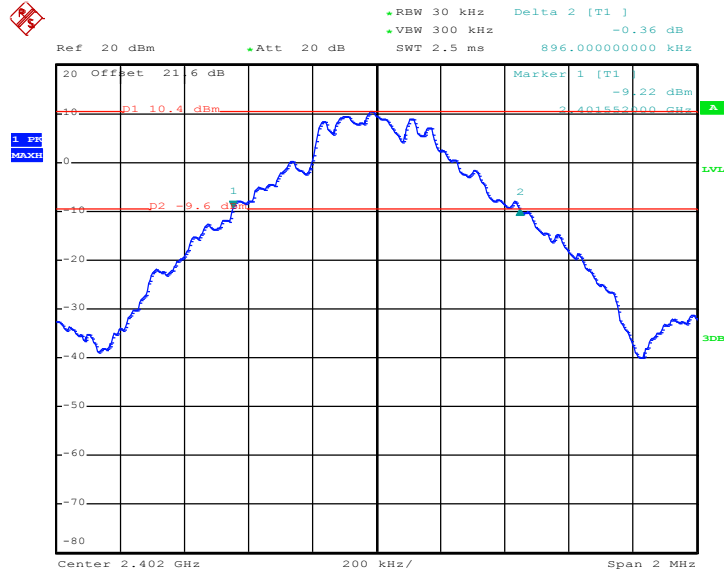

Date: 14.JAN.2020 21:54:42

20 dB Bandwidth Plot on Channel 39

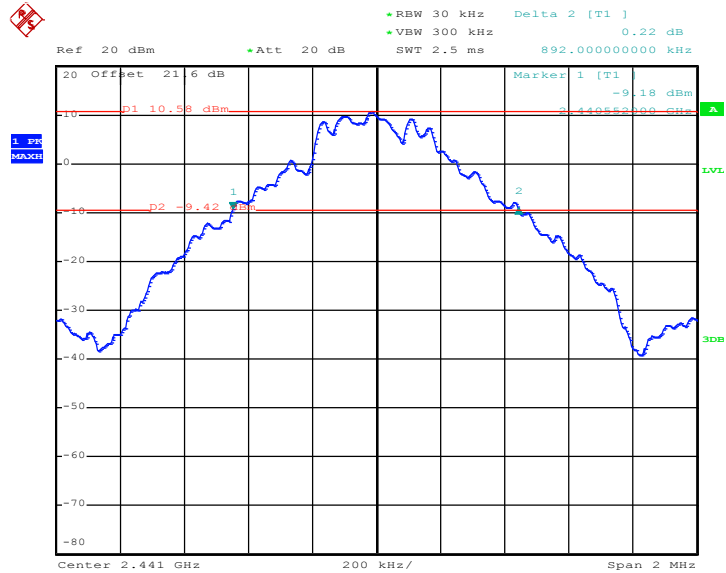

Date: 14.JAN.2020 22:19:24



20 dB Bandwidth Plot on Channel 78

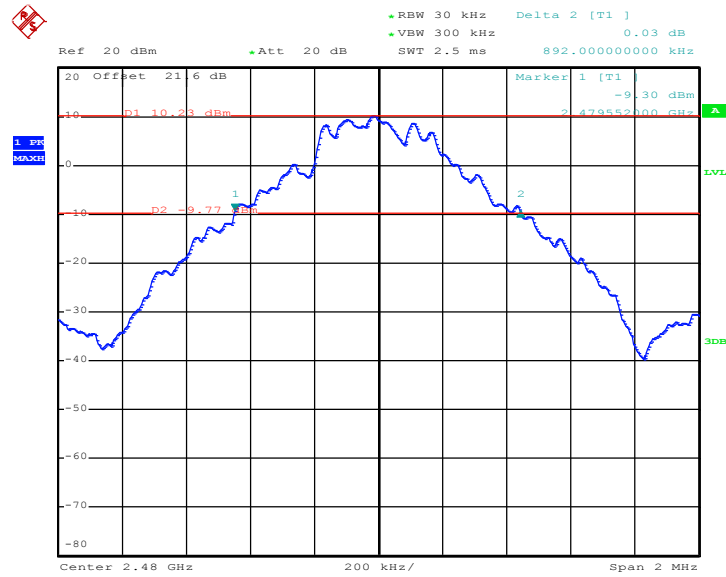

Date: 14.JAN.2020 23:22:50

<2Mbps>

20 dB Bandwidth Plot on Channel 00

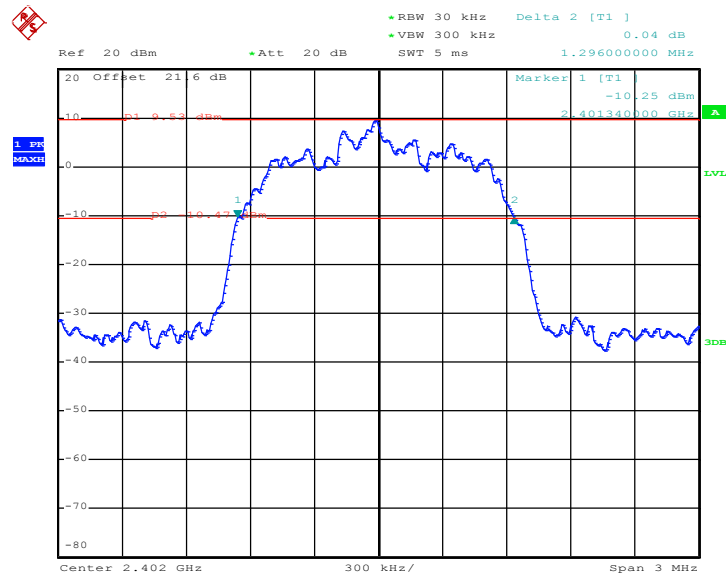

Date: 14.JAN.2020 23:45:18



20 dB Bandwidth Plot on Channel 39

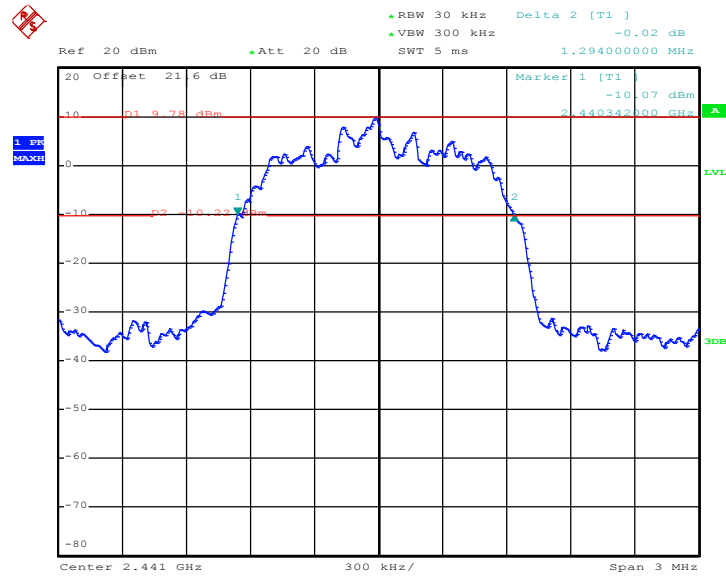

Date: 14.JAN.2020 23:51:31

20 dB Bandwidth Plot on Channel 78

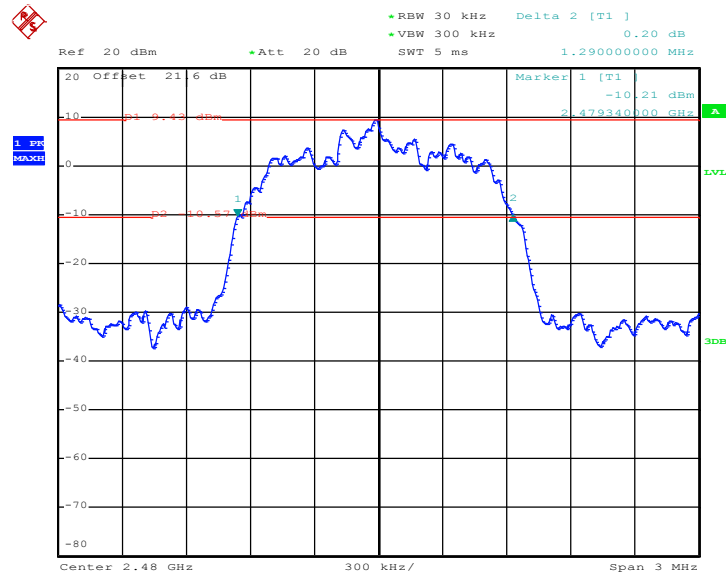

Date: 15.JAN.2020 00:03:46



<3Mbps>

20 dB Bandwidth Plot on Channel 00

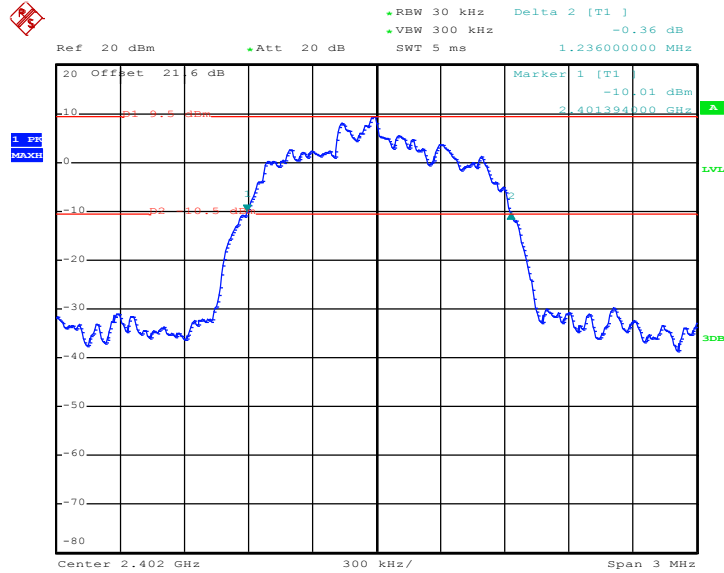

Date: 15.JAN.2020 00:14:40

20 dB Bandwidth Plot on Channel 39

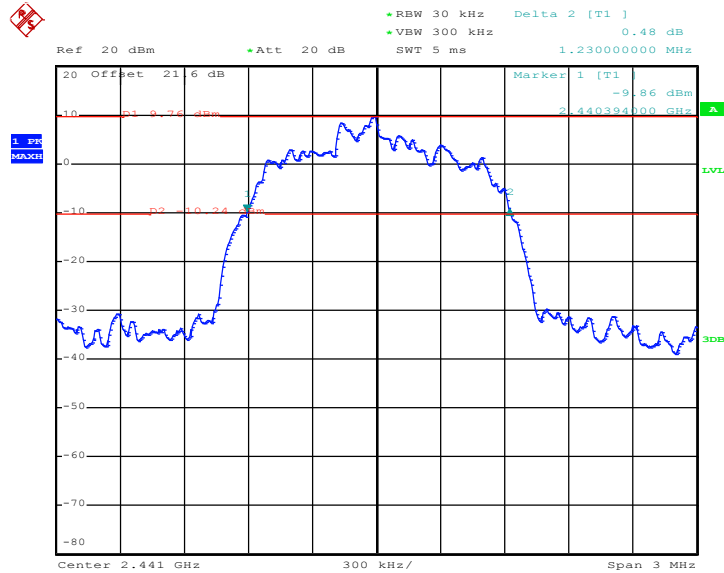

Date: 15.JAN.2020 00:21:06



20 dB Bandwidth Plot on Channel 78

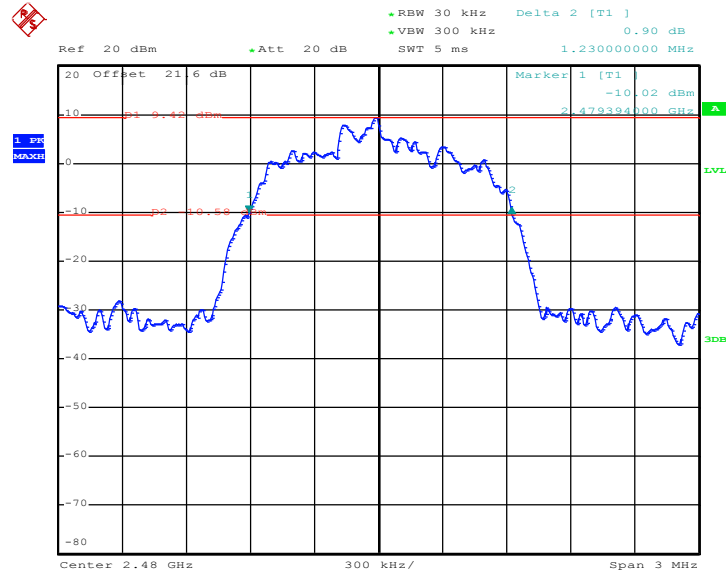

Date: 15.JAN.2020 00:28:55



3.4.6 Test Result of 99% Occupied Bandwidth

Please refer to Appendix A.

<1Mbps>

99% Occupied Bandwidth Plot on Channel 00

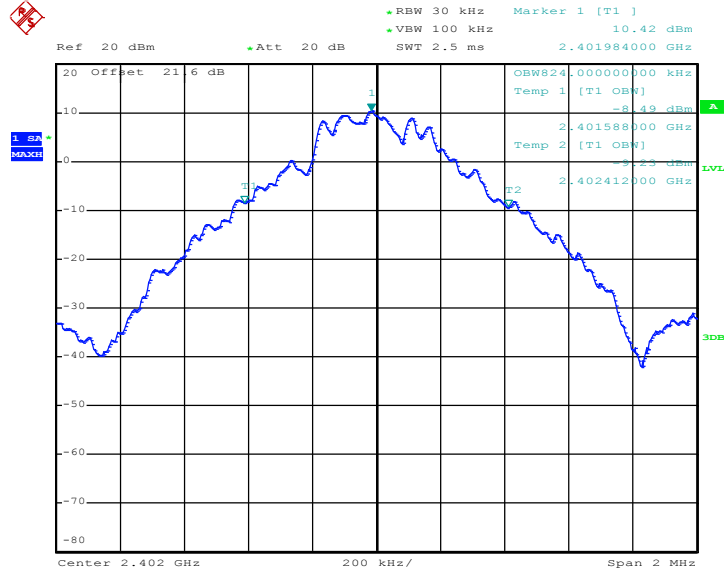

Date: 14.JAN.2020 22:01:53



99% Occupied Bandwidth Plot on Channel 39

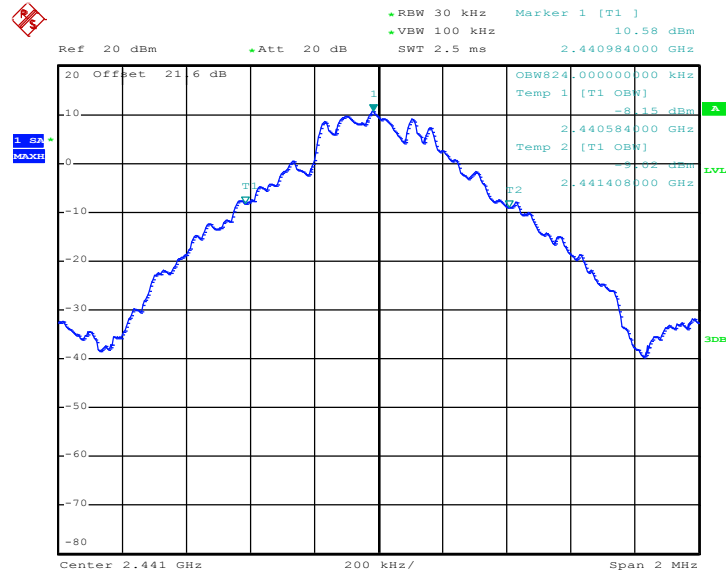

Date: 14.JAN.2020 22:20:41

99% Occupied Bandwidth Plot on Channel 78

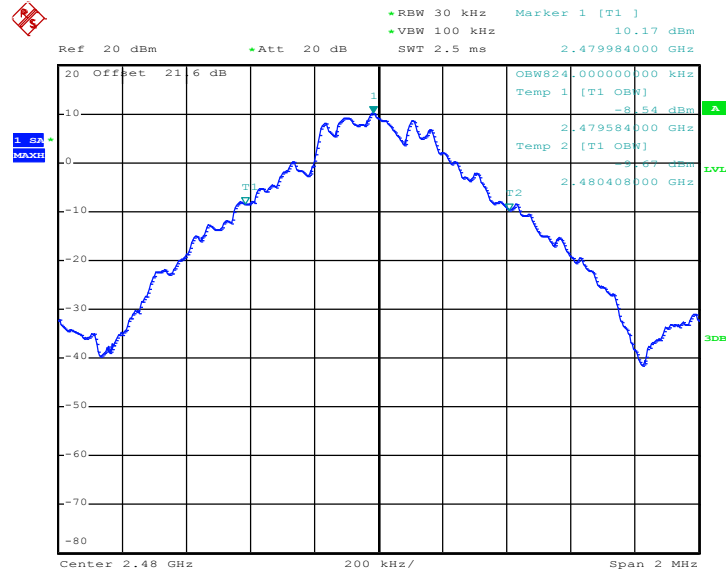

Date: 14.JAN.2020 23:30:33



<2Mbps>

99% Occupied Bandwidth Plot on Channel 00

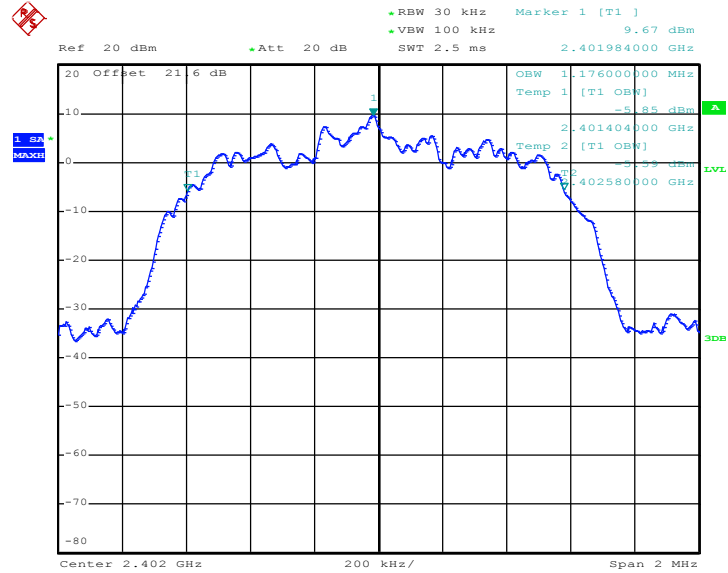

Date: 14.JAN.2020 23:47:59

99% Occupied Bandwidth Plot on Channel 39

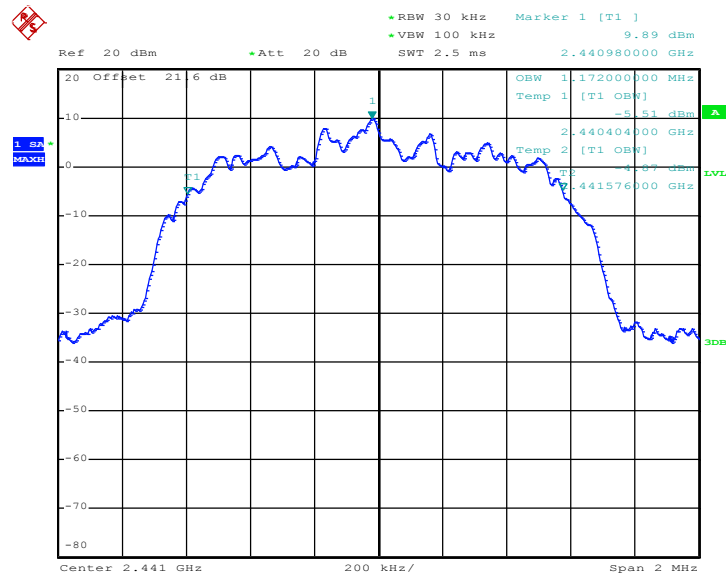

Date: 14.JAN.2020 23:53:44



99% Occupied Bandwidth Plot on Channel 78

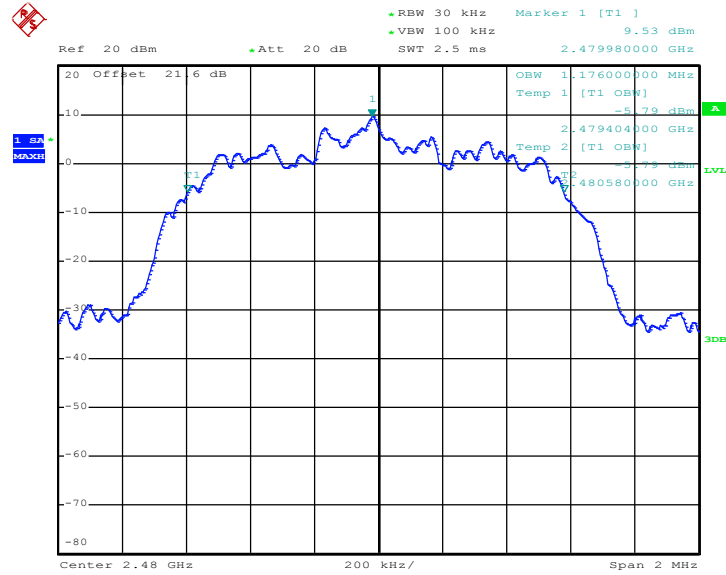

Date: 15.JAN.2020 00:05:58

<3Mbps>

99% Occupied Bandwidth Plot on Channel 00

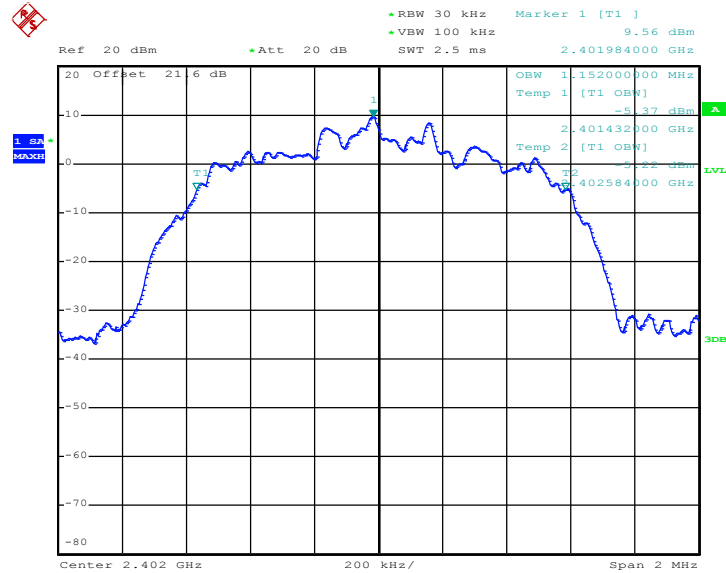

Date: 15.JAN.2020 00:16:35



99% Occupied Bandwidth Plot on Channel 39

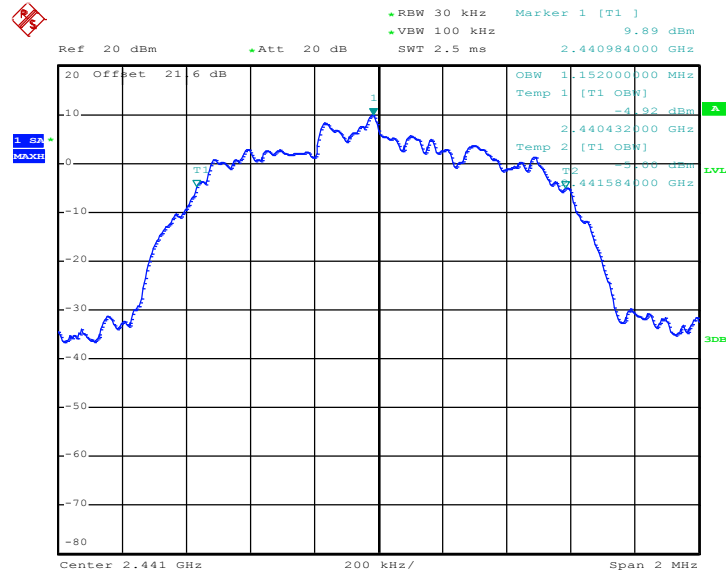

Date: 15.JAN.2020 00:22:23

99% Occupied Bandwidth Plot on Channel 78

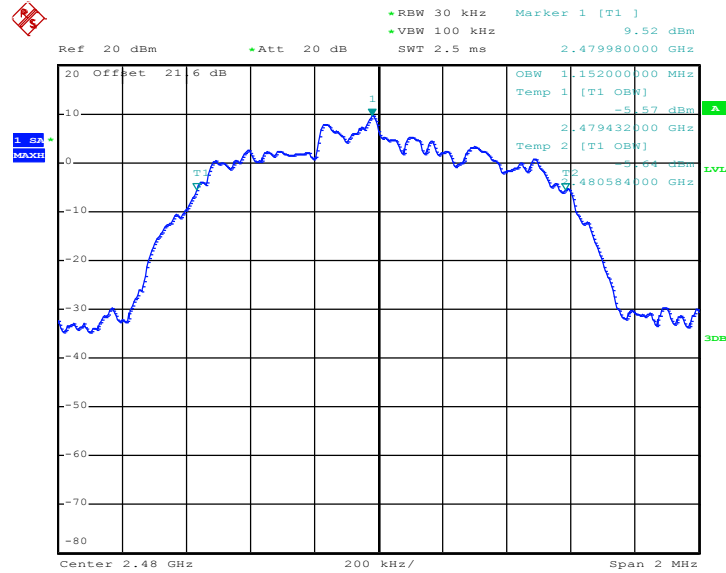

Date: 15.JAN.2020 00:30:47

Note: The occupied channel bandwidth is maintained within the band of operation for all of the modulations.

3.5 Output Power Measurement

3.5.1 Limit of Output Power

The maximum peak conducted output power of the intentional radiator shall not exceed the following:

- (1) For frequency hopping systems operating in the 2400-2483.5 MHz band employing at least 75 non-overlapping hopping channels, and all frequency hopping systems in the 5725-5850 MHz band: 1 watt. For all other frequency hopping systems in the 2400-2483.5 MHz band 0.125 watts.

3.5.2 Measuring Instruments

See list of measuring equipment of this test report.

3.5.3 Test Procedures

1. The testing follows ANSI C63.10-2013 clause 7.8.5.
2. The RF output of EUT was connected to the power meter by RF cable and attenuator. The path loss was compensated to the results for each measurement.
3. Set to the maximum power setting and enable the EUT transmit continuously.
4. Measure the conducted output power with cable loss and record the results in the test report.
5. Measure and record the results in the test report.

3.5.4 Test Setup

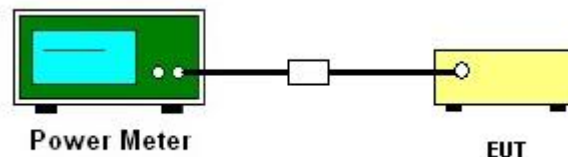

3.5.5 Test Result of Peak Output Power

Please refer to Appendix A.

3.5.6 Test Result of Average Output Power (Reporting Only)

Please refer to Appendix A.

3.6 Conducted Band Edges Measurement

3.6.1 Limit of Band Edges

In any 100 kHz bandwidth outside the intentional radiation frequency band, the radio frequency power shall be at least 20 dB below the highest level of the radiated power. In addition, radiated emissions which fall in the restricted bands must also comply with the radiated emission limits.

3.6.2 Measuring Instruments

See list of measuring equipment of this test report.

3.6.3 Test Procedures

1. The testing follows ANSI C63.10-2013 clause 7.8.6.
2. Set to the maximum power setting and enable the EUT transmit continuously.
3. Set RBW = 100kHz, VBW = 300kHz. Band edge emissions must be at least 20 dB down from the highest emission level within the authorized band as measured with a 100kHz RBW. The attenuation shall be 30 dB instead of 20 dB when RMS conducted output power procedure is used.
4. Enable hopping function of the EUT and then repeat step 2. and 3.
5. Measure and record the results in the test report.

3.6.4 Test Setup

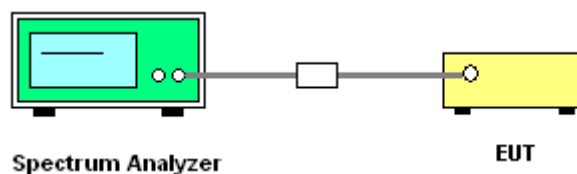



3.6.5 Test Result of Conducted Band Edges

<1Mbps>

Low Band Edge Plot on Channel 00

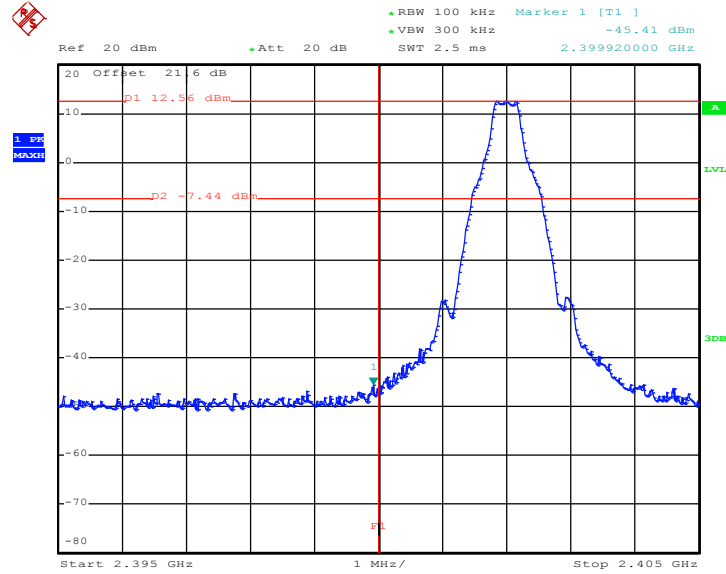

Date: 14.JAN.2020 21:58:40

High Band Edge Plot on Channel 78

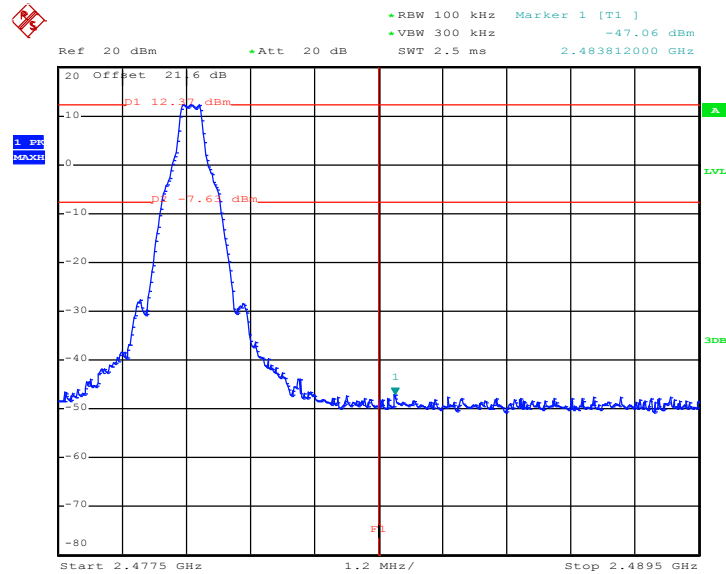

Date: 14.JAN.2020 23:27:34

<2Mbps>

Low Band Edge Plot on Channel 00

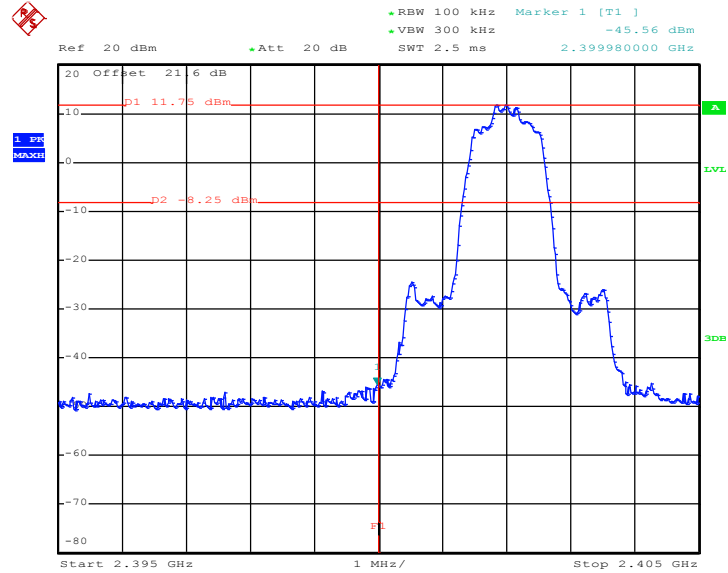

Date: 14.JAN.2020 23:46:57

High Band Edge Plot on Channel 78

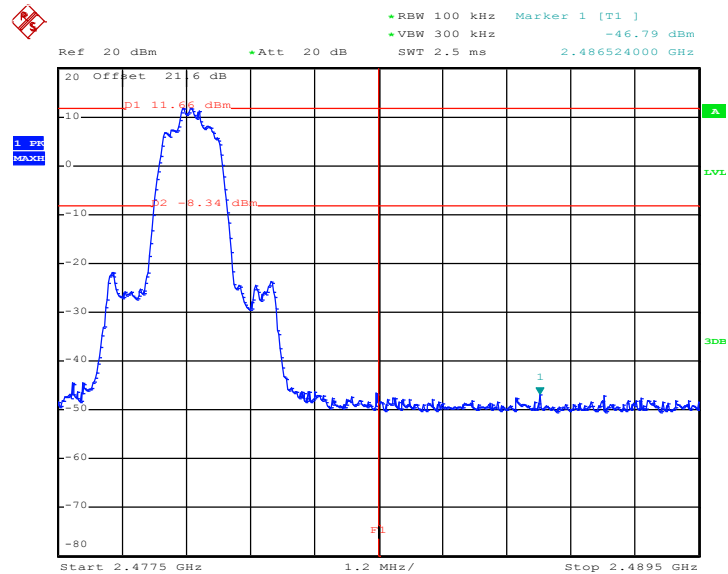

Date: 15.JAN.2020 00:05:03



<3Mbps>

Low Band Edge Plot on Channel 00

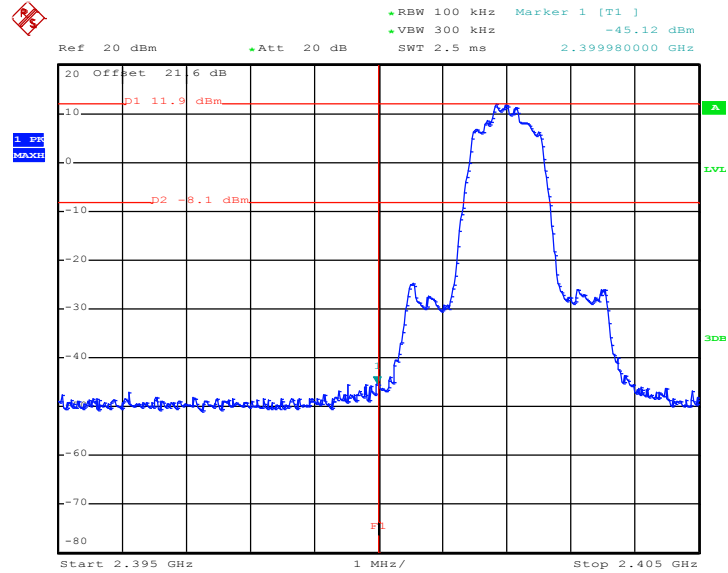

Date: 15.JAN.2020 00:15:40

High Band Edge Plot on Channel 78

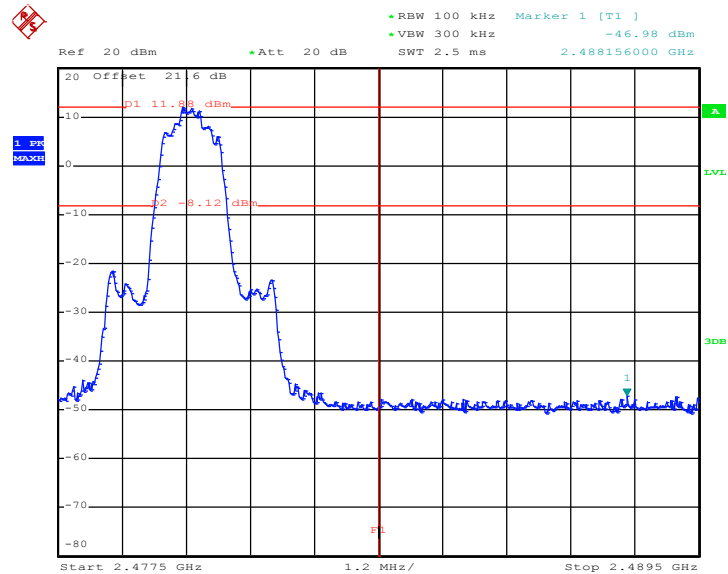

Date: 15.JAN.2020 00:29:52

3.6.6 Test Result of Conducted Hopping Mode Band Edges

<1Mbps>

Hopping Mode Low Band Edge Plot

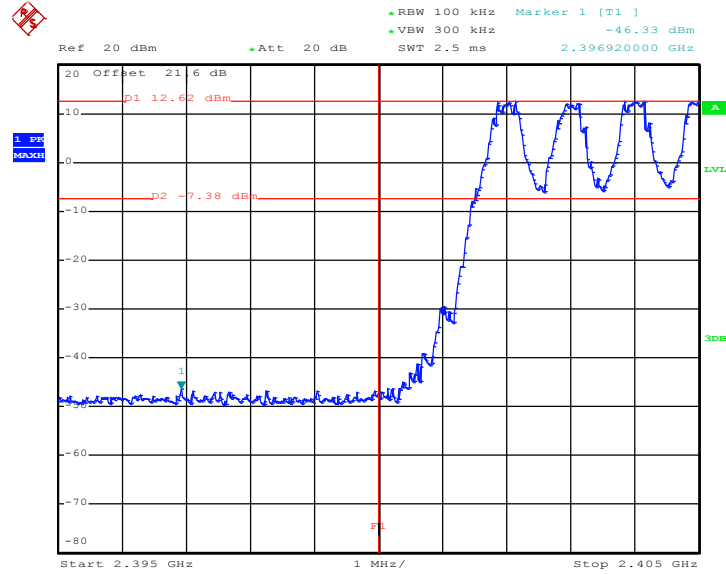

Date: 14.JAN.2020 21:45:58

Hopping Mode High Band Edge Plot

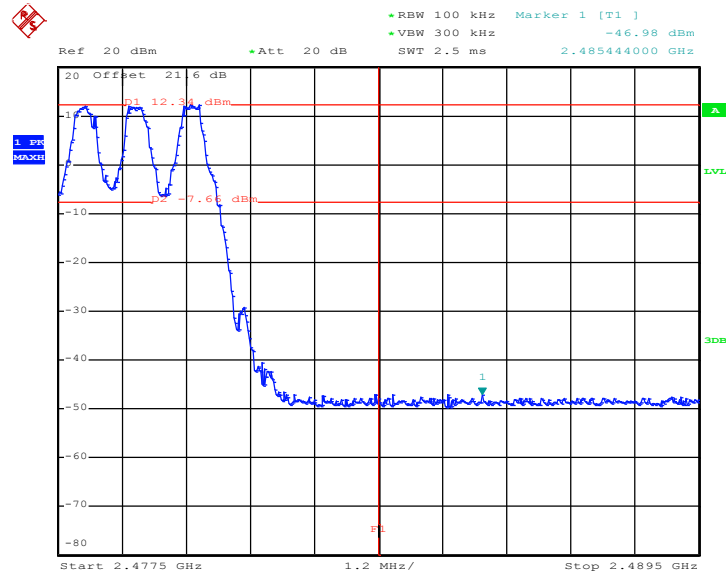

Date: 14.JAN.2020 21:47:22



<2Mbps>

Hopping Mode Low Band Edge Plot

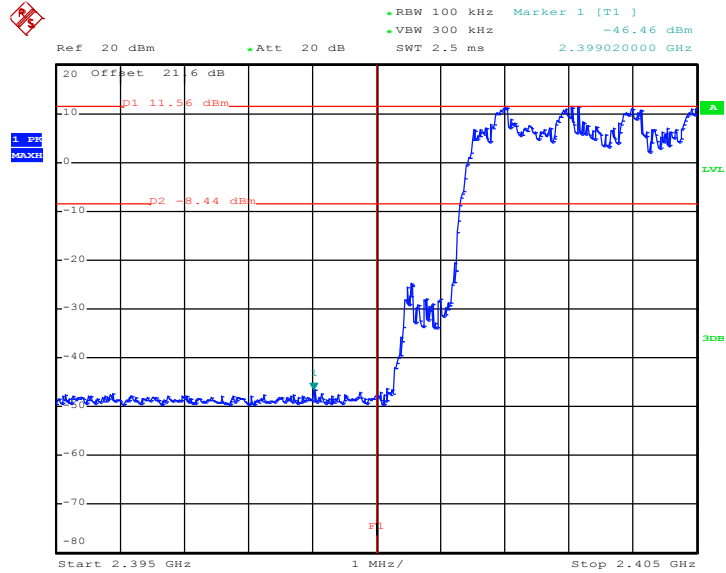

Date: 14.JAN.2020 21:41:42

Hopping Mode High Band Edge Plot

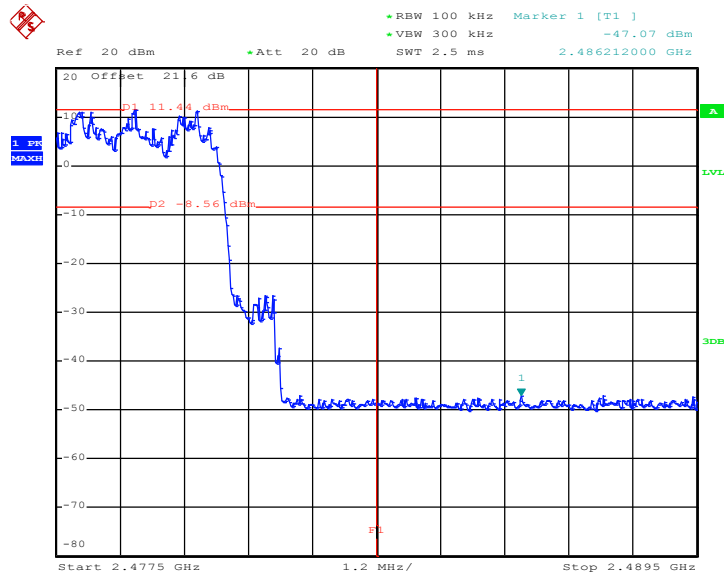

Date: 14.JAN.2020 21:42:40

<3Mbps>

Hopping Mode Low Band Edge Plot

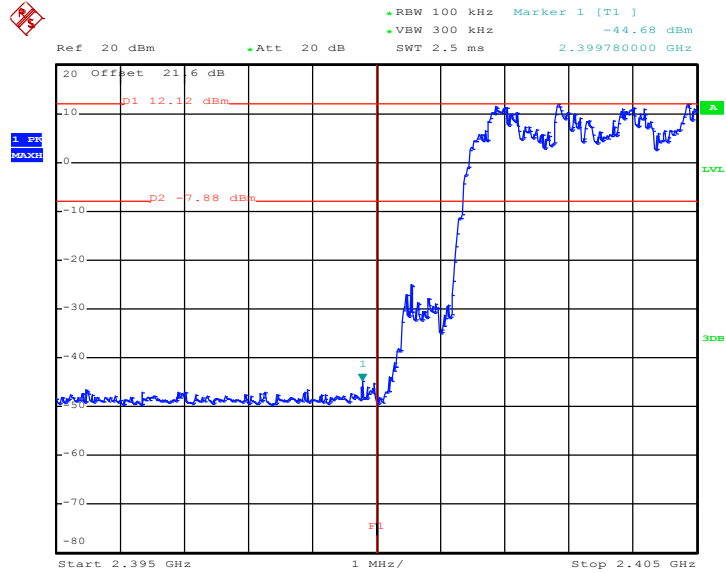

Date: 14.JAN.2020 21:37:21

Hopping Mode High Band Edge Plot

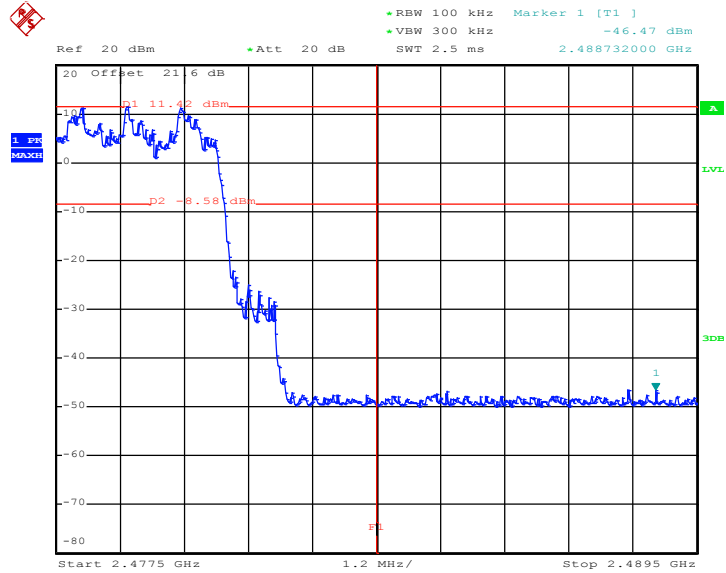

Date: 14.JAN.2020 21:38:17

3.7 Conducted Spurious Emission Measurement

3.7.1 Limit of Spurious Emission Measurement

In any 100 kHz bandwidth outside the intentional radiation frequency band, the radio frequency power shall be at least 20 dB below the highest level of the radiated power. In addition, radiated emissions which fall in the restricted bands must also comply with the radiated emission limits.

3.7.2 Measuring Instruments

See list of measuring equipment of this test report.

3.7.3 Test Procedure

1. The testing follows ANSI C63.10-2013 clause 7.8.8.
2. The RF output of EUT was connected to the spectrum analyzer by RF cable and attenuator. The path loss was compensated to the results for each measurement.
3. Set to the maximum power setting and enable the EUT transmit continuously.
4. Set RBW = 100 kHz, VBW = 300kHz, scan up through 10th harmonic. All harmonics / spurs must be at least 20 dB down from the highest emission level within the authorized band as measured with a 100 kHz RBW.
5. Measure and record the results in the test report.
6. The RF fundamental frequency should be excluded against the limit line in the operating frequency band.

3.7.4 Test Setup





3.7.5 Test Result of Conducted Spurious Emission

<1Mbps>

CSE Plot on Ch 00 between 30MHz ~ 3 GHz

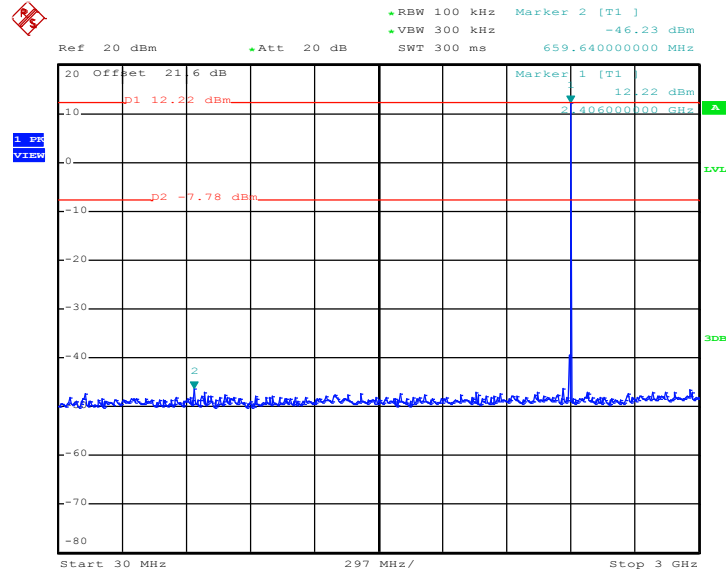

Date: 14.JAN.2020 22:14:14

1Mbps CSE Plot on Ch 00 between 2 GHz ~ 25 GHz

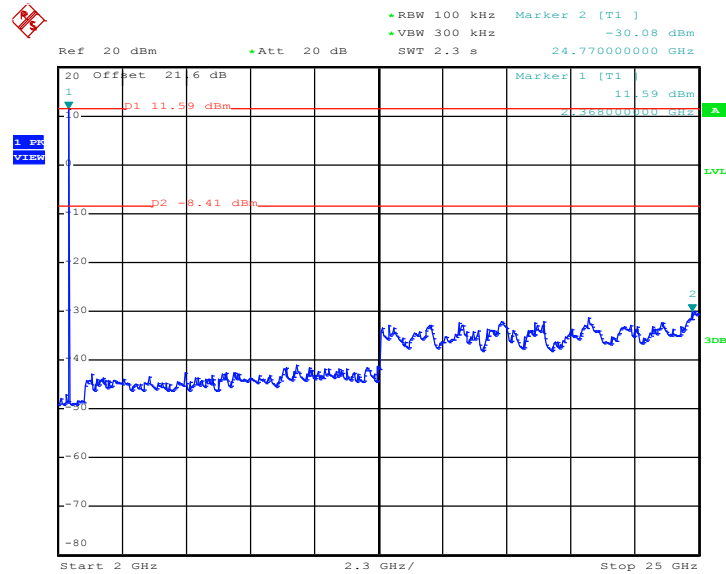

Date: 14.JAN.2020 22:14:58



CSE Plot on Ch 39 between 30MHz ~ 3 GHz

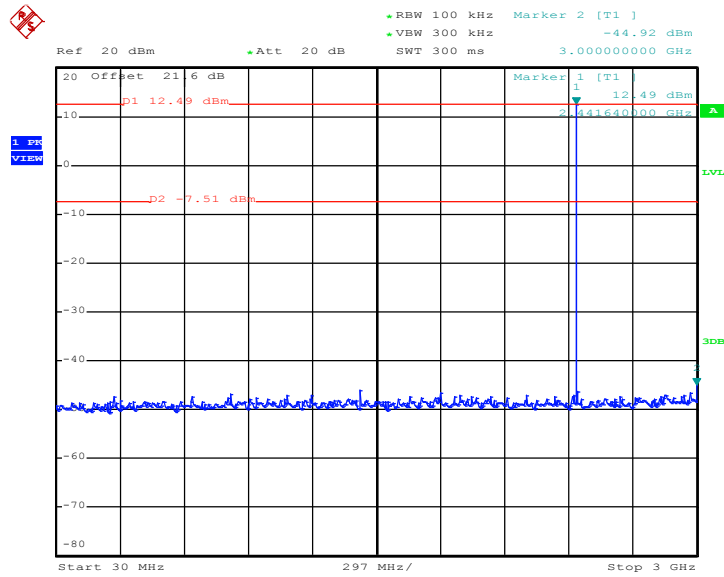

Date: 14.JAN.2020 22:40:57

CSE Plot on Ch 39 between 2 GHz ~ 25 GHz

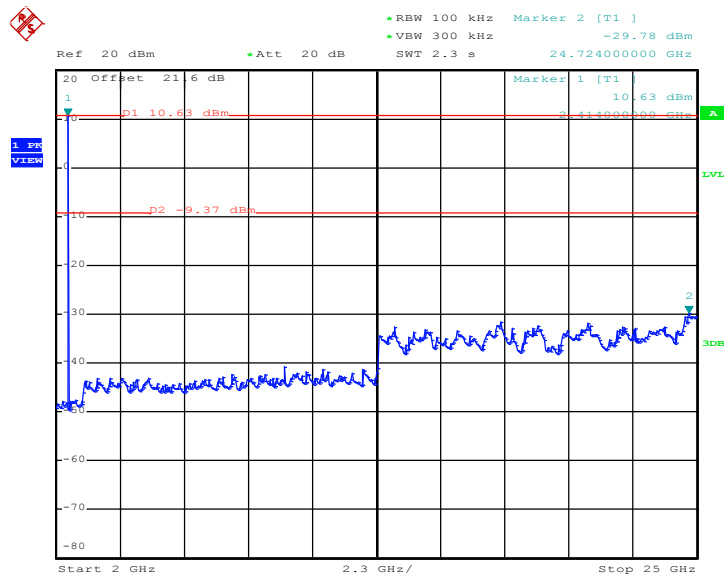

Date: 14.JAN.2020 22:41:27



CSE Plot on Ch 78 between 30MHz ~ 3 GHz

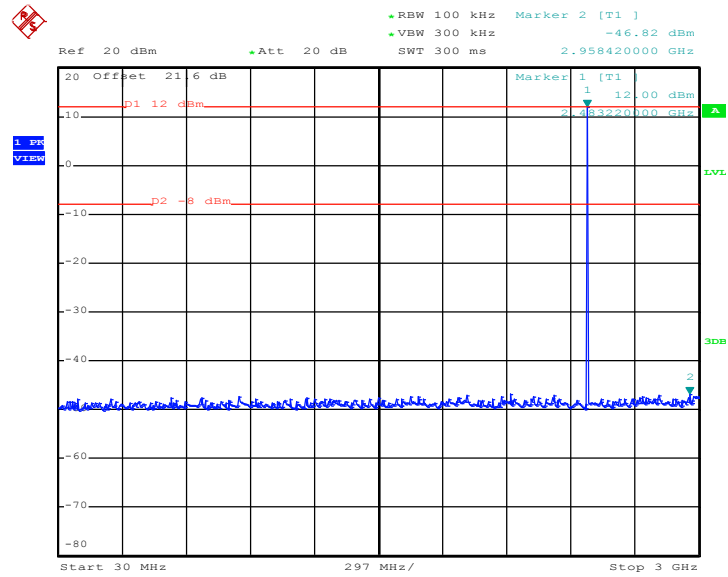

Date: 14.JAN.2020 23:32:00

CSE Plot on Ch 78 between 2 GHz ~ 25 GHz

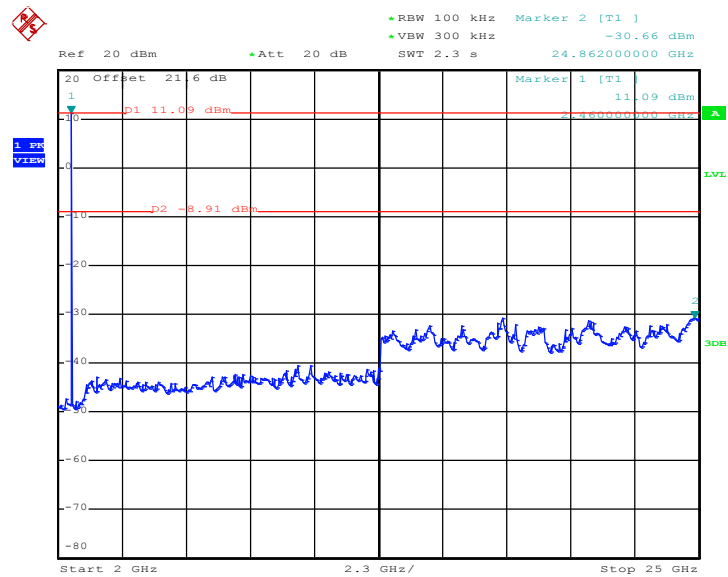

Date: 14.JAN.2020 23:32:44



<2Mbps>

CSE Plot on Ch 00 between 30MHz ~ 3 GHz

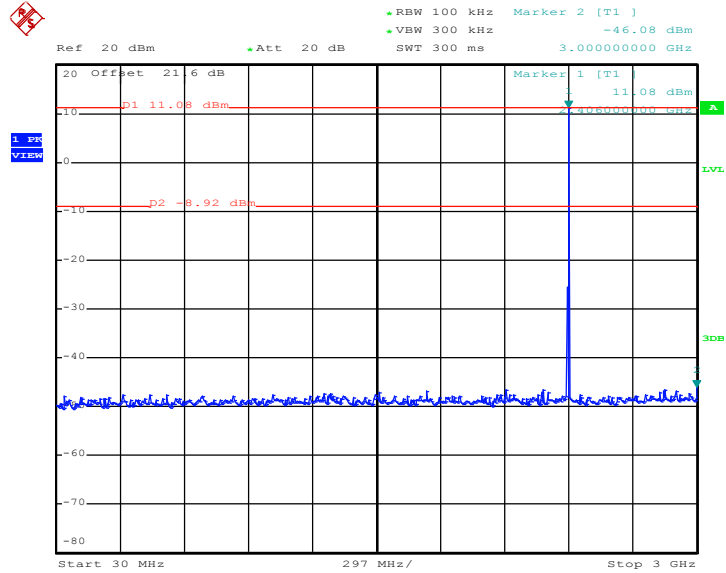

Date: 14.JAN.2020 23:59:21

CSE Plot on Ch 00 between 2 GHz ~ 25 GHz

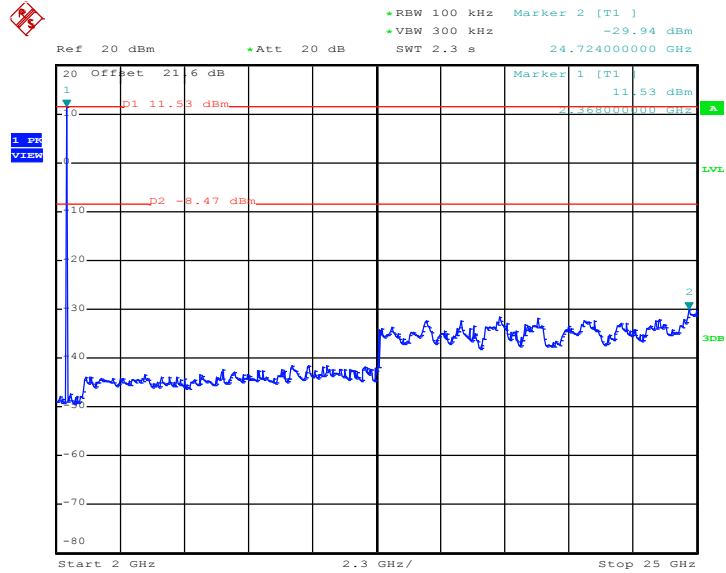

Date: 14.JAN.2020 23:59:52



CSE Plot on Ch 39 between 30MHz ~ 3 GHz

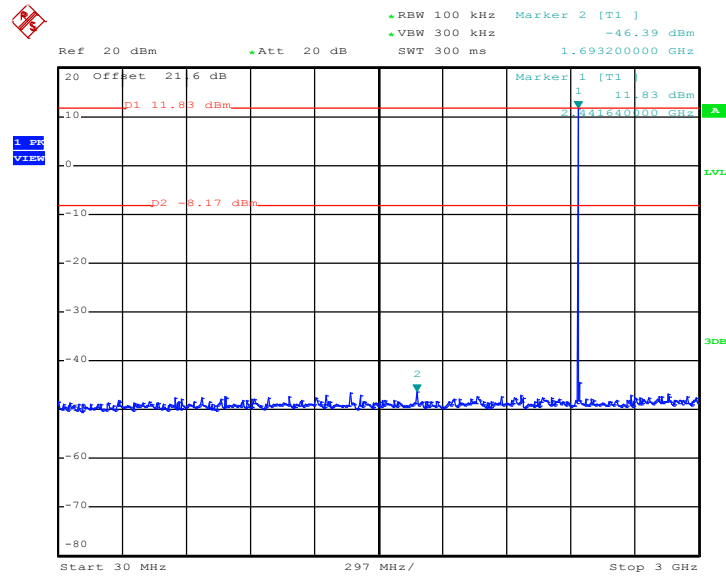

Date: 14.JAN.2020 23:54:55

CSE Plot on Ch 39 between 2 GHz ~ 25 GHz

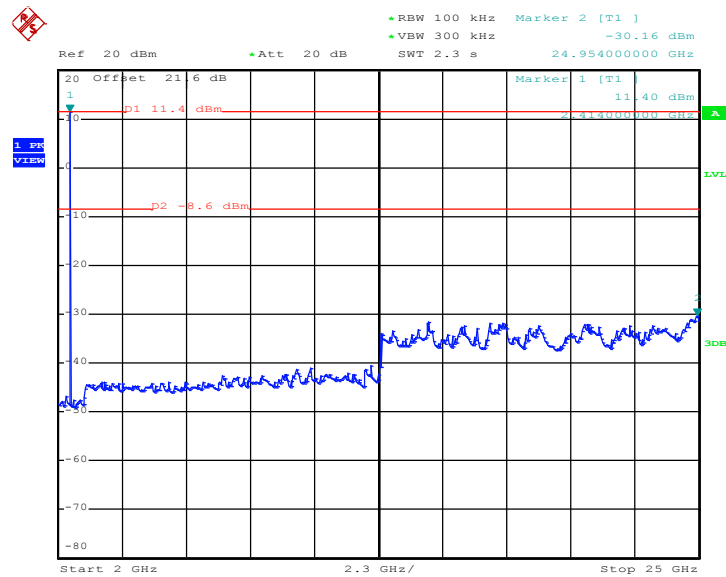

Date: 14.JAN.2020 23:55:25



CSE Plot on Ch 78 between 30MHz ~ 3 GHz

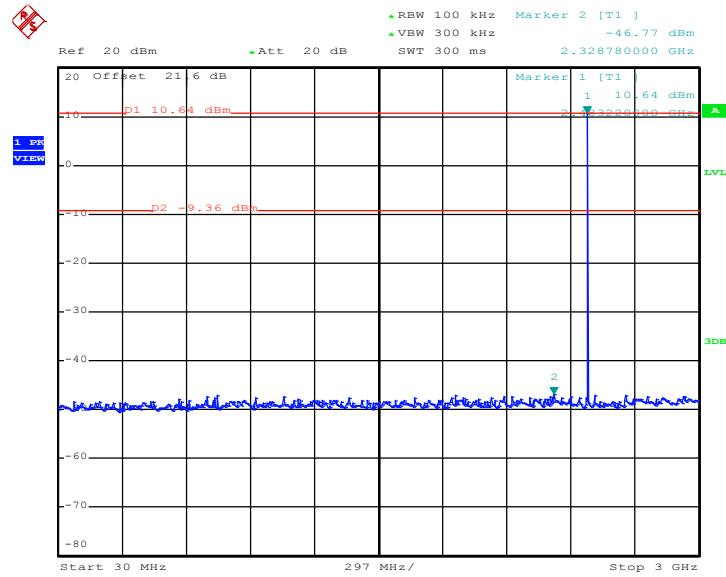

Date: 15.JAN.2020 00:10:06

CSE Plot on Ch 78 between 2 GHz ~ 25 GHz

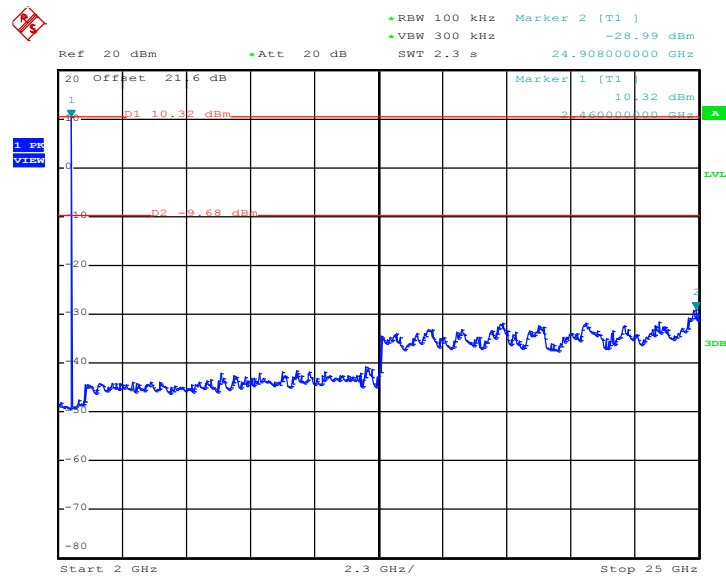

Date: 15.JAN.2020 00:10:37



<3Mbps>

CSE Plot on Ch 00 between 30MHz ~ 3 GHz

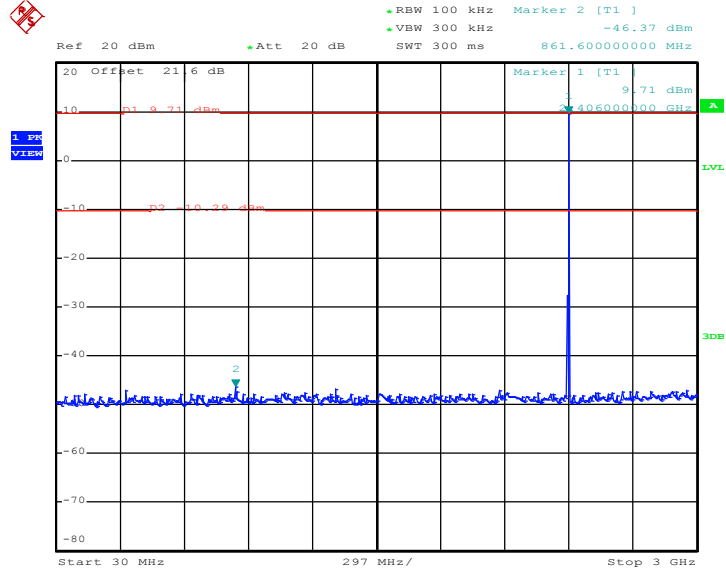

Date: 15.JAN.2020 00:17:31

CSE Plot on Ch 00 between 2 GHz ~ 25 GHz

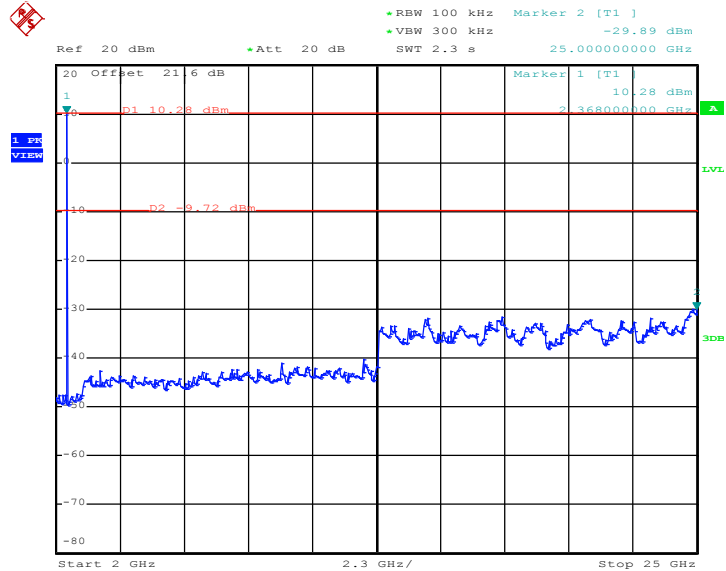

Date: 15.JAN.2020 00:18:01



CSE Plot on Ch 39 between 30MHz ~ 3 GHz

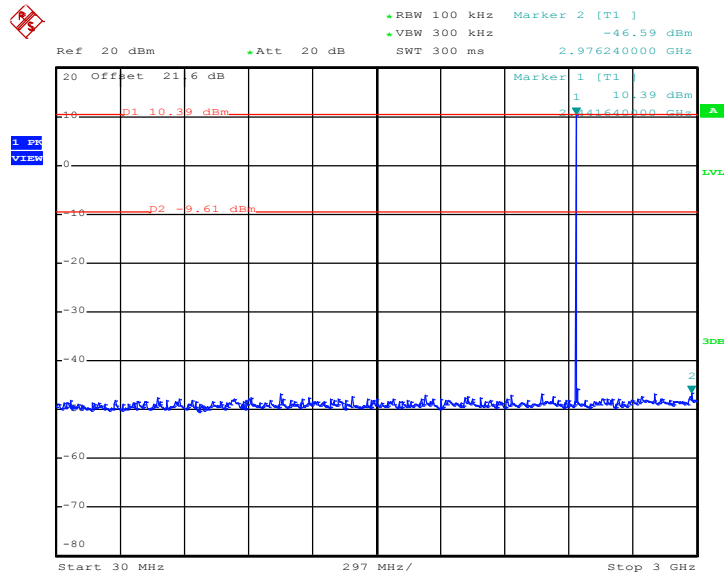

Date: 15.JAN.2020 00:24:29

CSE Plot on Ch 39 between 2 GHz ~ 25 GHz

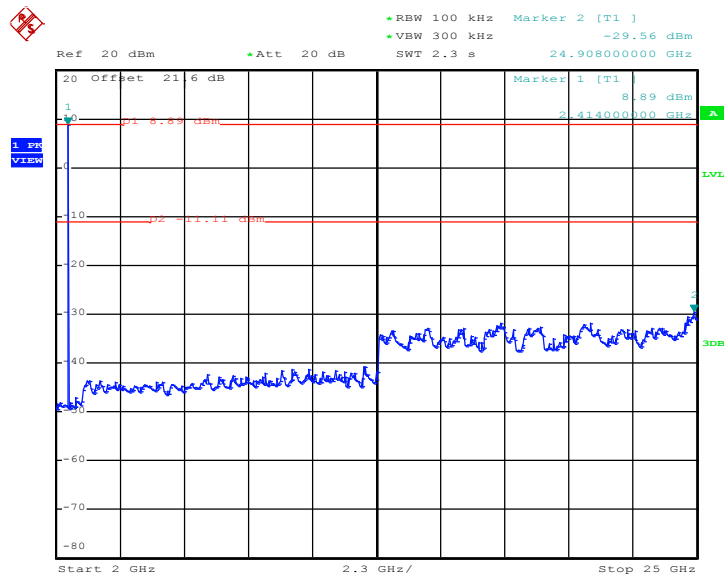

Date: 15.JAN.2020 00:24:59



CSE Plot on Ch 78 between 30MHz ~ 3 GHz

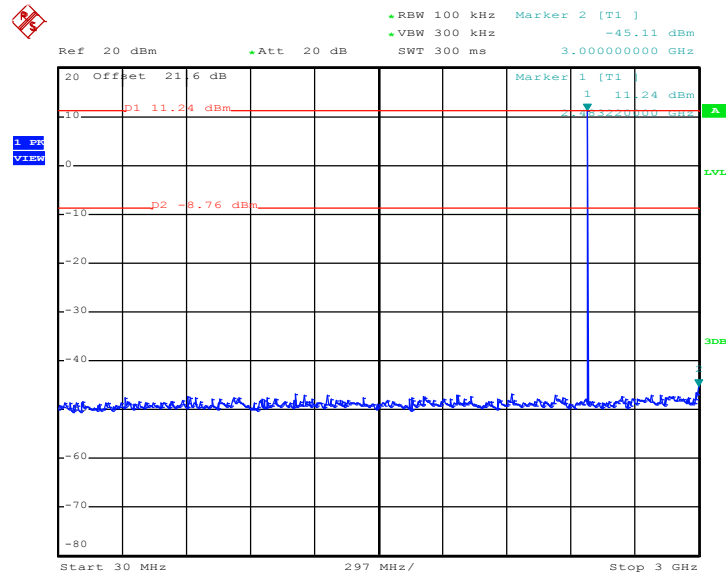

Date: 15.JAN.2020 00:32:11

CSE Plot on Ch 78 between 2 GHz ~ 25 GHz

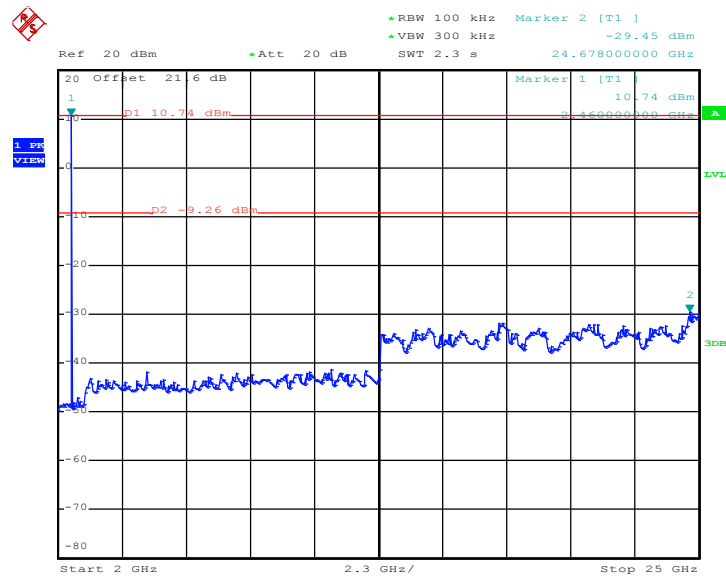

Date: 15.JAN.2020 00:32:41



3.8 Radiated Band Edges and Spurious Emission Measurement

3.8.1 Limit of Radiated Band Edges and Spurious Emission

In any 100 kHz bandwidth outside the intentional radiator frequency band, all harmonics/spurious must be at least 20 dB below the highest emission level within the authorized band. In addition, radiated emissions which fall in the restricted bands must also comply with the limits as below.

Frequency (MHz)	Field Strength (microvolts/meter)	Measurement Distance (meters)
0.009 – 0.490	2400/F(kHz)	300
0.490 – 1.705	24000/F(kHz)	30
1.705 – 30.0	30	30
30 – 88	100	3
88 – 216	150	3
216 - 960	200	3
Above 960	500	3

3.8.2 Measuring Instruments

See list of measuring equipment of this test report.



3.8.3 Test Procedures

1. The EUT was placed on a turntable with 0.8 meter for frequency below 1GHz and 1.5 meter for frequency above 1GHz respectively above ground.
2. The EUT was set 3 meters from the interference receiving antenna, which was mounted on the top of a variable height antenna tower.
3. For each suspected emission, the EUT was arranged to its worst case and then tune the Antenna tower (from 1 m to 4 m) and turntable (from 0 degree to 360 degrees) to find the maximum reading. A pre-amp and a high pass filter are used for the test in order to get better signal level to comply with the guidelines.
4. Set to the maximum power setting and enable the EUT transmit continuously.
5. Use the following spectrum analyzer settings:
 - (1) Span shall wide enough to fully capture the emission being measured;
 - (2) Set RBW=100 kHz for $f < 1 \text{ GHz}$, RBW=1MHz for $f > 1\text{GHz}$; VBW \geq RBW; Sweep = auto; Detector function = peak; Trace = max hold for peak
 - (3) For average measurement: use duty cycle correction factor method per 15.35(c).
Duty cycle = On time/100 milliseconds
On time = $N_1 * L_1 + N_2 * L_2 + \dots + N_{n-1} * L_{n-1} + N_n * L_n$
Where N_1 is number of type 1 pulses, L_1 is length of type 1 pulses, etc.
Average Emission Level = Peak Emission Level + $20 * \log(\text{Duty cycle})$
6. Corrected Reading: Antenna Factor + Cable Loss + Read Level - Preamp Factor = Level
7. For testing below 1GHz, if the emission level of the EUT in peak mode was 3 dB lower than the limit specified, then peak values of EUT will be reported, otherwise, the emissions will be repeated one by one using the CISPR quasi-peak method and reported.
8. For testing above 1GHz, the emission level of the EUT in peak mode was 20dB lower than average limit (that means the emission level in average mode also complies with the limit in average mode), then peak values of EUT will be reported, otherwise, the emissions will be measured in average mode again and reported.

Note: The average levels were calculated from the peak level corrected with duty cycle correction factor (-24.79dB) derived from $20 \log(\text{dwell time}/100\text{ms})$. This correction is only for signals that hop with the fundamental signal, such as band-edge and harmonic. Other spurious signals that are independent of the hopping signal would not use this correction.

3.8.4 Test Setup

For radiated emissions below 30MHz

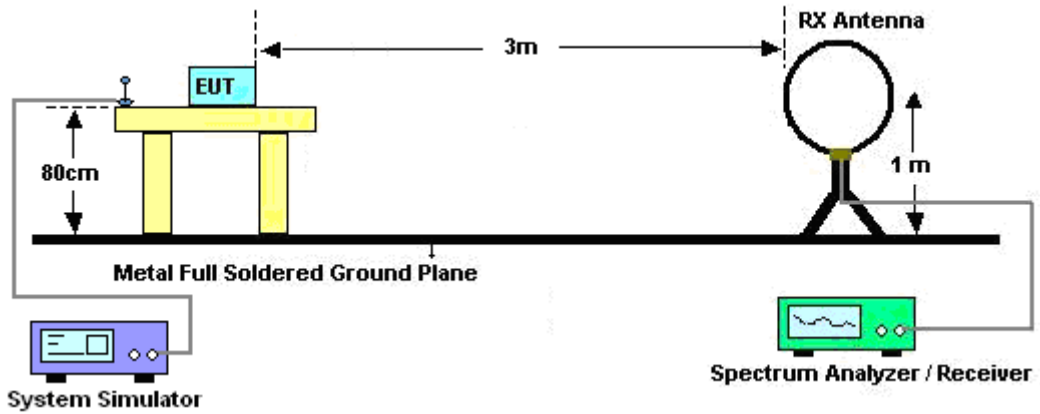

For radiated emissions from 30MHz to 1GHz

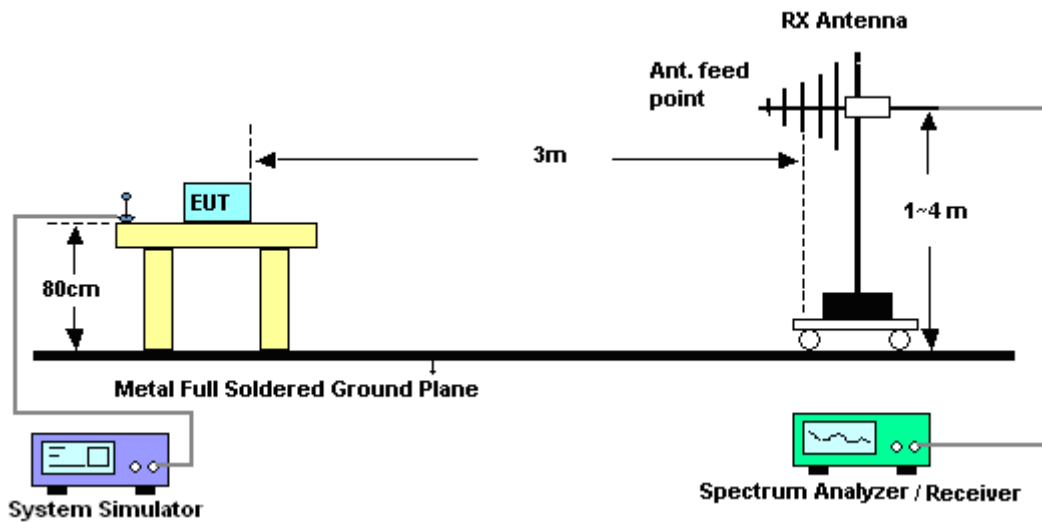

For radiated emissions from 1GHz to 18GHz

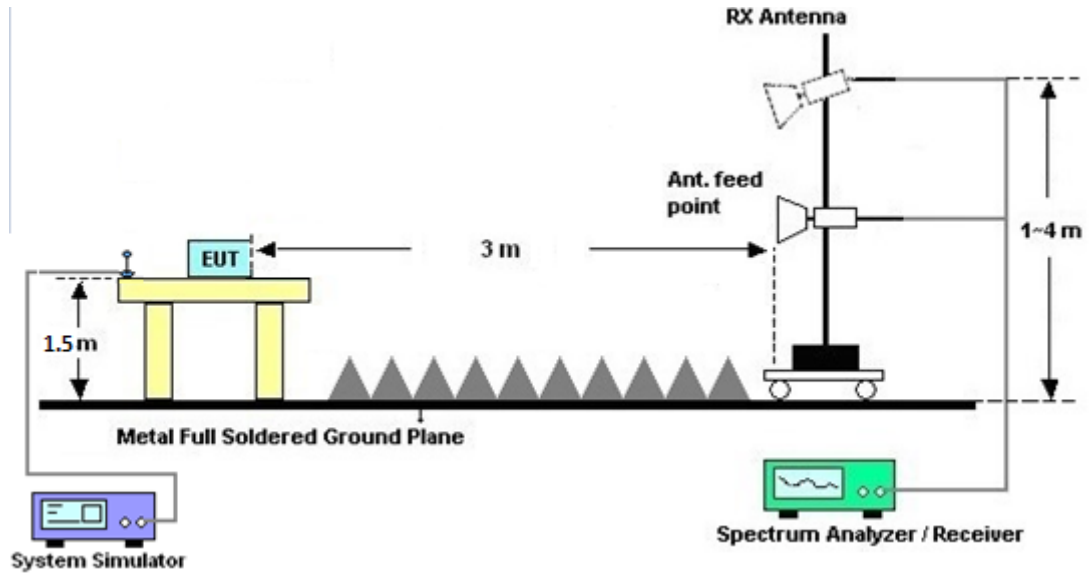

For radiated emissions from 18GHz to 26GHz

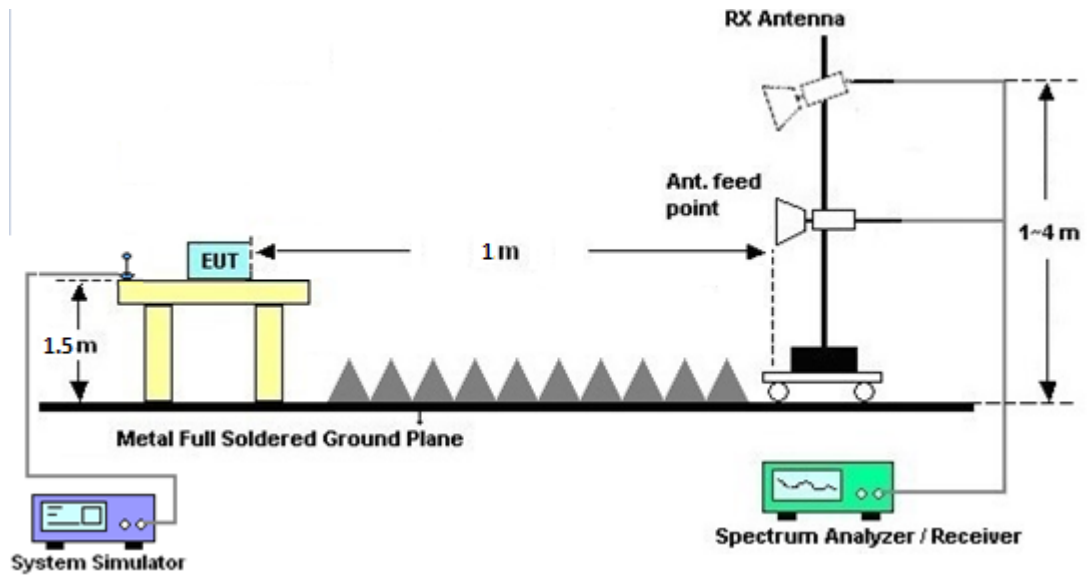



3.8.5 Test Results of Radiated Spurious Emissions (9 kHz ~ 30 MHz)

The low frequency, which started from 9 kHz to 30MHz, was pre-scanned and the result which was 20dB lower than the limit line was not reported.

There is a comparison data of both open-field test site and alternative test site - semi-Anechoic chamber according to 414788 D01 Radiated Test Site v01r01, and the result came out very similar.

3.8.6 Test Result of Radiated Spurious at Band Edges

Please refer to Appendix C and D.

3.8.7 Duty Cycle

Please refer to Appendix E.

3.8.8 Test Result of Radiated Spurious Emission (30MHz ~ 10th Harmonic)

Please refer to Appendix C and D.



3.9 AC Conducted Emission Measurement

3.9.1 Limit of AC Conducted Emission

For equipment that is designed to be connected to the public utility (AC) power line, the radio frequency voltage that is conducted back onto the AC power line on any frequency or frequencies within the band 150 kHz to 30 MHz shall not exceed the limits in the following table.

Frequency of emission (MHz)	Conducted limit (dB μ V)	
	Quasi-peak	Average
0.15-0.5	66 to 56*	56 to 46*
0.5-5	56	46
5-30	60	50

*Decreases with the logarithm of the frequency.

3.9.2 Measuring Instruments

See list of measuring equipment of this test report.

3.9.3 Test Procedures

1. The EUT was placed 0.4 meter from the conducting wall of the shielding room was kept at least 80 centimeters from any other grounded conducting surface.
2. Connect EUT to the power mains through a line impedance stabilization network (LISN).
3. All the support units are connecting to the other LISN.
4. The LISN provides 50 ohm coupling impedance for the measuring instrument.
5. The FCC states that a 50 ohm, 50 microhenry LISN should be used.
6. Both sides of AC line were checked for maximum conducted interference.
7. The frequency range from 150 kHz to 30 MHz was searched.
8. Set the test-receiver system to Peak Detect Function and specified bandwidth (IF Bandwidth = 9kHz) with Maximum Hold Mode. Then measurement is also conducted by Average Detector and Quasi-Peak Detector Function respectively.

3.9.4 Test Setup



3.9.5 Test Result of AC Conducted Emission

Please refer to Appendix B.



3.10 Antenna Requirements

3.10.1 Standard Applicable

If directional gain of transmitting antennas is greater than 6dBi, the power shall be reduced by the same level in dB comparing to gain minus 6dBi. The use of a permanently attached antenna or of an antenna that uses a unique coupling to the intentional radiator shall be considered sufficient to comply with the rule.

3.10.2 Antenna Anti-Replacement Construction

An embedded-in antenna design is used.

3.10.3 Antenna Gain

The antenna peak gain of EUT is less than 6 dBi. Therefore, it is not necessary to reduce maximum peak output power limit.



4 List of Measuring Equipment

Instrument	Manufacturer	Model No.	Serial No.	Characteristics	Calibration Date	Test Date	Due Date	Remark
Loop Antenna	Rohde & Schwarz	HFH2-Z2	100488	9 kHz~30 MHz	Dec. 26, 2019	Jan. 04, 2020~ Jan. 31, 2020	Dec. 25, 2020	Radiation (03CH16-HY)
Bilog Antenna	TESEQ	CBL6111D& 00802N1D0 1N-06	47020&06	30MHz to 1GHz	Oct. 13, 2019	Jan. 04, 2020~ Jan. 31, 2020	Oct. 12, 2020	Radiation (03CH16-HY)
Horn Antenna	SCHWARZBE CK	BBHA 9120 D	9120D-1522	1G~18GHz	Sep. 19, 2019	Jan. 04, 2020~ Jan. 31, 2020	Sep. 18, 2020	Radiation (03CH16-HY)
Amplifier	SONOMA	310N	371607	9kHz~1000MHz	Oct. 01, 2019	Jan. 04, 2020~ Jan. 31, 2020	Sep. 30, 2020	Radiation (03CH16-HY)
Preamplifier	Jet-Power	JPA0118-55- 303	1710001800 054001	1GHz~18GHz	May 19, 2019	Jan. 04, 2020~ Jan. 31, 2020	May 18, 2020	Radiation (03CH16-HY)
Preamplifier	EMEC	EMC184045 B	980192	18GHz ~40GHz	Jul. 10, 2019	Jan. 04, 2020~ Jan. 31, 2020	Jul. 09, 2020	Radiation (03CH16-HY)
Preamplifier	Keysight	83017A	MY5327026 4	1GHz~26.5GHz	Dec. 11, 2019	Jan. 04, 2020~ Jan. 31, 2020	Dec. 10, 2020	Radiation (03CH16-HY)
EMI Test Receiver	Keysight	N9038A (MXE)	MY5542017 0	20MHz~8.4GHz	Mar. 08, 2019	Jan. 04, 2020~ Jan. 31, 2020	Mar. 07, 2020	Radiation (03CH16-HY)
Spectrum Analyzer	Agilent	E4446A	MY5018013 6	3Hz~44GHz	Apr. 29, 2019	Jan. 04, 2020~ Jan. 31, 2020	Apr. 28, 2020	Radiation (03CH16-HY)
RF Cable	HUBER + SUHNER	SUCOFLEX 104	MY11680/4P E	NA	Aug. 30, 2019	Jan. 04, 2020~ Jan. 31, 2020	Aug. 29, 2020	Radiation (03CH16-HY)
RF Cable	HUBER + SUHNER	SUCOFLEX 104	MY11688/4P E	NA	Aug. 30, 2019	Jan. 04, 2020~ Jan. 31, 2020	Aug. 29, 2020	Radiation (03CH16-HY)
RF Cable	HUBER + SUHNER	SUCOFLEX 102	EC-A5-300-5 757	NA	Aug. 30, 2019	Jan. 04, 2020~ Jan. 31, 2020	Aug. 29, 2020	Radiation (03CH16-HY)
RF Cable	HUBER + SUHNER	SUCOFLEX 102	505134/2	30MHz~40GHz	Feb. 26, 2019	Jan. 04, 2020~ Jan. 31, 2020	Feb. 25, 2020	Radiation (03CH16-HY)
RF Cable	HUBER + SUHNER	SUCOFLEX 102	800740/2	30MHz~40GHz	Feb. 26, 2019	Jan. 04, 2020~ Jan. 31, 2020	Feb. 25, 2020	Radiation (03CH16-HY)
SHF-EHF Horn Antenna	SCHWARZBE CK	BBHA 9170	BBHA91705 76	18GHz~40GHz	May 14, 2019	Jan. 04, 2020~ Jan. 31, 2020	May 13, 2020	Radiation (03CH16-HY)
Preamplifier	EMEC	EM18G40G	060715	18GHz~40GHz	Dec. 13, 2019	Jan. 04, 2020~ Jan. 31, 2020	Dec. 12, 2020	Radiation (03CH16-HY)
Hygrometer	TECPEL	DTM-303B	TP161243	N/A	Jun. 17, 2019	Jan. 04, 2020~ Jan. 31, 2020	Jun. 16, 2020	Radiation (03CH16-HY)
Software	Audix	E3 6.2009-8-24	RK-001136	N/A	N/A	Jan. 04, 2020~ Jan. 31, 2020	N/A	Radiation (03CH16-HY)
Filter	Wainwright	WLK4-1000- 1530-8000-4 0SS	SN11	1.53G Low Pass	Sep. 15, 2019	Jan. 04, 2020~ Jan. 31, 2020	Sep. 14, 2020	Radiation (03CH16-HY)
Filter	Wainwright	WHKX12-27 00-3000-180 00-60SS	SN3	3GHz High Pass Filter	Sep. 15, 2019	Jan. 04, 2020~ Jan. 31, 2020	Sep. 14, 2020	Radiation (03CH16-HY)



Instrument	Manufacturer	Model No.	Serial No.	Characteristics	Calibration Date	Test Date	Due Date	Remark
Hygrometer	Testo	608-H2	41410069	N/A	Jun. 17, 2019	Dec. 22, 2019~ Jan. 15, 2020	Jun. 16, 2020	Conducted (TH05-HY)
Power Meter	Agilent	E4416A	GB4129234 4	N/A	Dec. 21, 2019	Dec. 22, 2019~ Jan. 15, 2020	Dec. 20, 2020	Conducted (TH05-HY)
Power Sensor	Agilent	E9327A	US4044154 8	50MHz~18GHz	Dec. 21, 2019	Dec. 22, 2019~ Jan. 15, 2020	Dec. 20, 2020	Conducted (TH05-HY)
Signal Analyzer	Rohde & Schwarz	FSV40	101566	10Hz~40GHz	Jul. 15, 2019	Dec. 22, 2019~ Jan. 15, 2020	Jul. 14, 2020	Conducted (TH05-HY)
Spectrum Analyzer	Rohde & Schwarz	FSP40	100055	9kHz-40GHz	Aug. 14, 2019	Dec. 22, 2019~ Jan. 15, 2020	Aug. 13, 2020	Conducted (TH05-HY)
Switch Box & RF Cable	Burgeon	ETF-058	EC1208382	N/A	Mar. 27, 2019	Dec. 22, 2019~ Jan. 15, 2020	Mar. 26, 2020	Conducted (TH05-HY)
AC Power Source	ChainTek	APC-1000W	N/A	N/A	N/A	Dec. 26, 2019~ Jan. 16, 2020	N/A	Conduction (CO05-HY)
EMI Test Receiver	Rohde & Schwarz	ESR3	102388	9kHz~3.6GHz	Nov. 15, 2019	Dec. 26, 2019~ Jan. 16, 2020	Nov. 14, 2020	Conduction (CO05-HY)
Hygrometer	Testo	608-H1	34913912	N/A	Mar. 19, 2019	Dec. 26, 2019~ Jan. 16, 2020	Mar. 18, 2020	Conduction (CO05-HY)
LISN	Rohde & Schwarz	ENV216	100081	9kHz~30MHz	Nov. 15, 2019	Dec. 26, 2019~ Jan. 16, 2020	Nov. 14, 2020	Conduction (CO05-HY)
Software	Rohde & Schwarz	EMC32 V10.30	N/A	N/A	N/A	Dec. 26, 2019~ Jan. 16, 2020	N/A	Conduction (CO05-HY)
LF Cable	HUBER + SUHNER	RG-214/U	LF01	N/A	Dec. 31, 2018	Dec. 26, 2019	Dec. 30, 2019	Conduction (CO05-HY)
LF Cable	HUBER + SUHNER	RG-214/U	LF01	N/A	Jan. 02, 2020	Jan. 16, 2020	Jan. 01, 2021	Conduction (CO05-HY)
Pulse Limiter	Rohde & Schwarz	ESH3-Z2	100851	N/A	Dec. 31, 2018	Dec. 26, 2019	Dec. 30, 2019	Conduction (CO05-HY)
Pulse Limiter	Rohde & Schwarz	ESH3-Z2	100851	N/A	Jan. 02, 2020	Jan. 16, 2020	Jan. 01, 2021	Conduction (CO05-HY)



5 Uncertainty of Evaluation

Uncertainty of Conducted Emission Measurement (150 kHz ~ 30 MHz)

Measuring Uncertainty for a Level of Confidence of 95% ($U = 2Uc(y)$)	2.0
---	-----

Uncertainty of Radiated Emission Measurement (30 MHz ~ 1000 MHz)

Measuring Uncertainty for a Level of Confidence of 95% ($U = 2Uc(y)$)	4.9
---	-----

Uncertainty of Radiated Emission Measurement (1000 MHz ~ 18000 MHz)

Measuring Uncertainty for a Level of Confidence of 95% ($U = 2Uc(y)$)	6.7
---	-----

Uncertainty of Radiated Emission Measurement (18000 MHz ~ 40000 MHz)

Measuring Uncertainty for a Level of Confidence of 95% ($U = 2Uc(y)$)	3.9
---	-----

Appendix A. Test Result of Conducted Test Items

Test Engineer:	Derek Hsu and Shiming Liu	Temperature:	21~25	°C
Test Date:	2019/12/22~2020/1/15	Relative Humidity:	51~54	%

TEST RESULTS DATA**20dB and 99% Occupied Bandwidth and Hopping Channel Separation**

Mod.	Data Rate	NTX	CH.	Freq. (MHz)	20db BW (MHz)	99% Bandwidth (MHz)	Hopping Channel Separation Measurement (MHz)	Hopping Channel Separation Measurement Limit (MHz)	Pass/Fail
DH	1Mbps	1	0	2402	0.896	0.824	1.008	0.5973	Pass
DH	1Mbps	1	39	2441	0.892	0.824	0.990	0.5947	Pass
DH	1Mbps	1	78	2480	0.892	0.824	1.014	0.5947	Pass
2DH	2Mbps	1	0	2402	1.296	1.176	0.984	0.8640	Pass
2DH	2Mbps	1	39	2441	1.294	1.172	1.116	0.8627	Pass
2DH	2Mbps	1	78	2480	1.290	1.176	1.158	0.8600	Pass
3DH	3Mbps	1	0	2402	1.236	1.152	1.014	0.8240	Pass
3DH	3Mbps	1	39	2441	1.230	1.152	1.008	0.8200	Pass
3DH	3Mbps	1	78	2480	1.230	1.152	1.164	0.8200	Pass

TEST RESULTS DATA**Dwell Time**

Mod.	Hopping Channel Number Rate	Hops Over Occupancy Time(hops)	Package Transfer Time (msec)	Dwell Time (sec)	Limits (sec)	Pass/Fail
Nomal	79	106.67	2.88	0.31	0.4	Pass
AFH	20	53.33	2.88	0.15	0.4	Pass

TEST RESULTS DATA**Peak Power Table**

DH	CH.	NTX	Peak Power (dBm)	Power Limit (dBm)	Test Result
DH1	0	1	13.46	30.00	Pass
	39	1	13.77	30.00	Pass
	78	1	13.28	30.00	Pass
2DH1	0	1	14.31	20.97	Pass
	39	1	14.72	20.97	Pass
	78	1	14.18	20.97	Pass
3DH1	0	1	14.91	20.97	Pass
	39	1	15.23	20.97	Pass
	78	1	14.41	20.97	Pass

TEST RESULTS DATA**Average Power Table****(Reporting Only)**

DH	CH.	NTX	Average Power (dBm)	Duty Factor (dB)
DH1	0	1	13.21	5.22
	39	1	13.52	5.22
	78	1	13.10	5.22
2DH1	0	1	12.21	5.11
	39	1	12.38	5.11
	78	1	12.11	5.11
3DH1	0	1	12.24	5.06
	39	1	12.39	5.06
	78	1	12.14	5.06

TEST RESULTS DATA**Number of Hopping Frequency**

Number of Hopping (Channel)	Adaptive Frequency Hopping (Channel)	Limits (Channel)	Pass/Fail
79	20	> 15	Pass



Appendix B. AC Conducted Emission Test Results

Test Engineer :	Howard Huang and Tom Lee	Temperature :	22~25°C
		Relative Humidity :	45~52%

EUT Information

Report NO : 9O1542-02
 Test Mode : Mode 1
 Test Voltage : 120Vac/60Hz
 Phase : Line

Full Spectrum

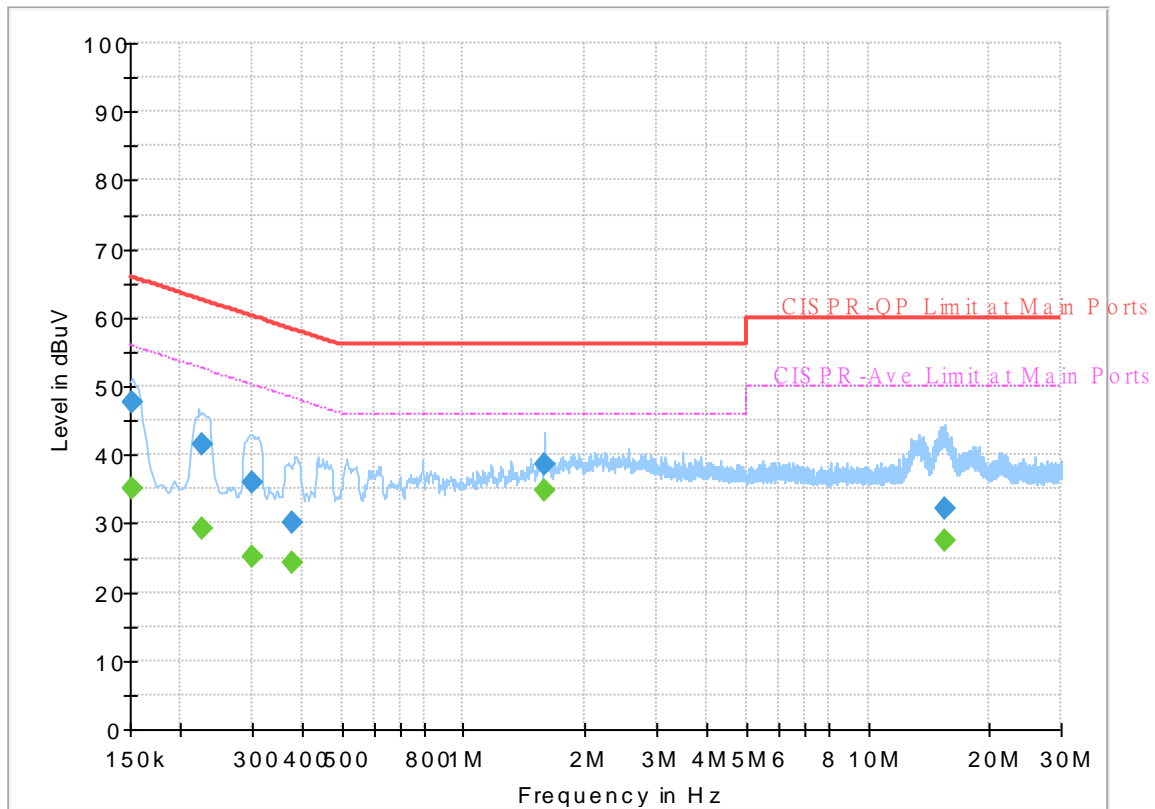

Final Result

Frequency (MHz)	QuasiPeak (dBuV)	CAverage (dBuV)	Limit (dBuV)	Margin (dB)	Line	Filter	Corr. (dB)
0.150878	---	35.14	55.95	20.81	L1	OFF	19.5
0.150878	47.61	---	65.95	18.34	L1	OFF	19.5
0.224970	---	29.16	52.63	23.47	L1	OFF	19.5
0.224970	41.40	---	62.63	21.23	L1	OFF	19.5
0.300750	---	25.12	50.22	25.10	L1	OFF	19.5
0.300750	35.94	---	60.22	24.28	L1	OFF	19.5
0.379500	---	24.29	48.29	24.00	L1	OFF	19.5
0.379500	30.06	---	58.29	28.23	L1	OFF	19.5
1.585320	---	34.77	46.00	11.23	L1	OFF	19.6
1.585320	38.73	---	56.00	17.27	L1	OFF	19.6
15.531000	---	27.45	50.00	22.55	L1	OFF	20.1
15.531000	32.23	---	60.00	27.77	L1	OFF	20.1

EUT Information

Report NO : 9O1542-02
 Test Mode : Mode 1
 Test Voltage : 120Vac/60Hz
 Phase : Neutral

Full Spectrum

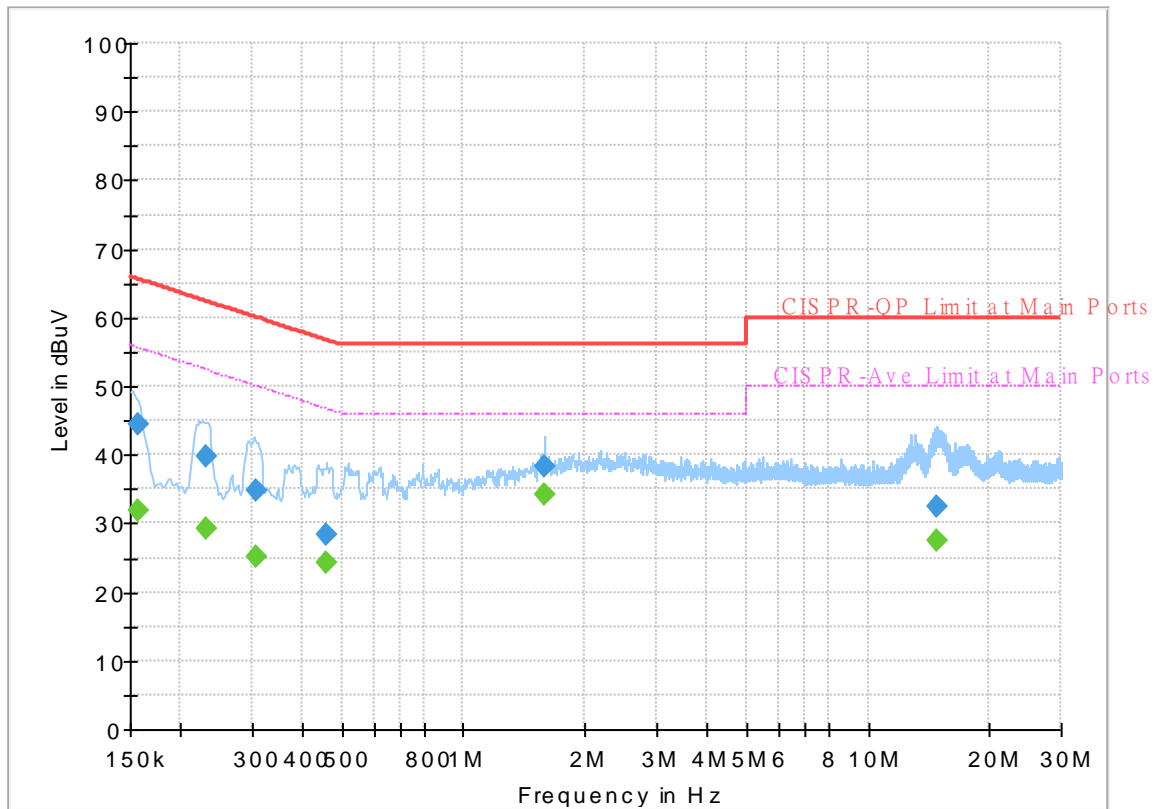

Final Result

Frequency (MHz)	QuasiPeak (dBuV)	CAverage (dBuV)	Limit (dBuV)	Margin (dB)	Line	Filter	Corr. (dB)
0.156750	---	31.87	55.63	23.76	N	OFF	19.5
0.156750	44.30	---	65.63	21.33	N	OFF	19.5
0.231000	---	29.33	52.41	23.08	N	OFF	19.5
0.231000	39.67	---	62.41	22.74	N	OFF	19.5
0.305880	---	25.13	50.08	24.95	N	OFF	19.5
0.305880	34.71	---	60.08	25.37	N	OFF	19.5
0.456000	---	24.28	46.77	22.49	N	OFF	19.5
0.456000	28.50	---	56.77	28.27	N	OFF	19.5
1.585050	---	34.32	46.00	11.68	N	OFF	19.6
1.585050	38.41	---	56.00	17.59	N	OFF	19.6
14.820000	---	27.35	50.00	22.65	N	OFF	20.1
14.820000	32.54	---	60.00	27.46	N	OFF	20.1

EUT Information

Report NO : 9O1542-02
 Test Mode : Mode 2
 Test Voltage : 120Vac/60Hz
 Phase : Line

Full Spectrum

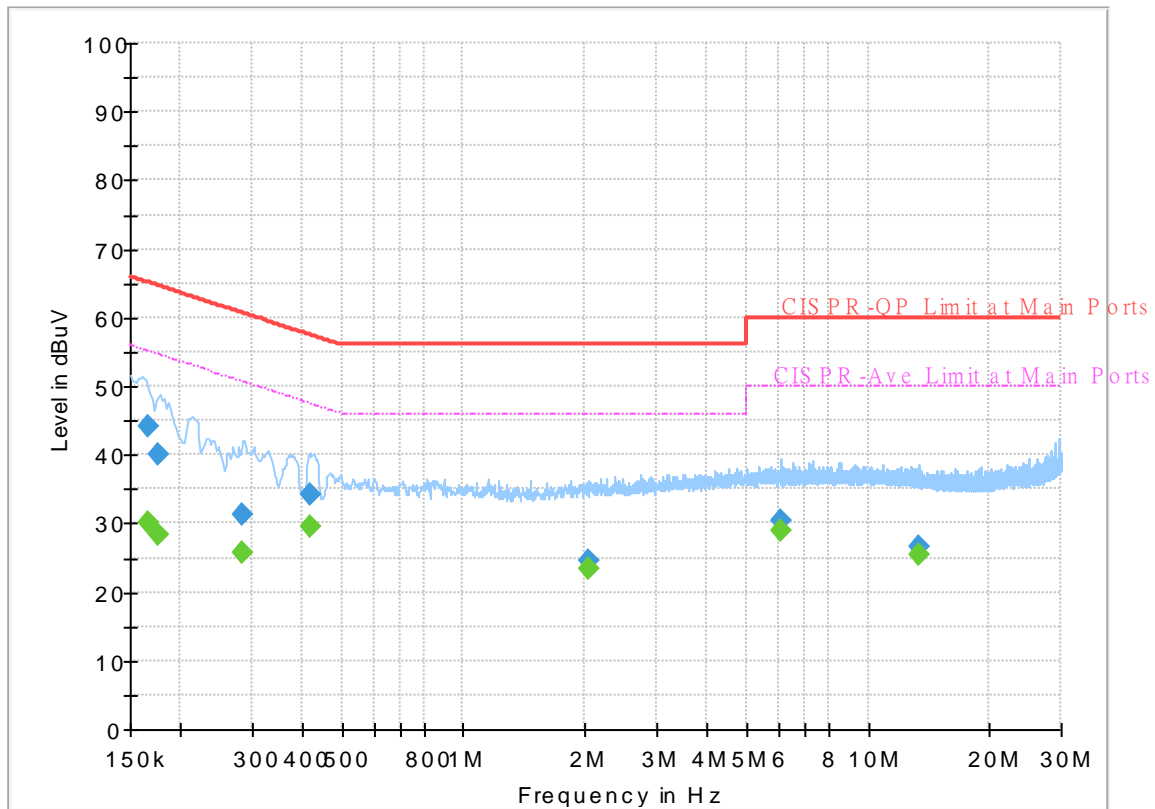

Final_Result

Frequency (MHz)	QuasiPeak (dBuV)	CAverage (dBuV)	Limit (dBuV)	Margin (dB)	Line	Filter	Corr. (dB)
0.165750	---	30.16	55.17	25.01	L1	OFF	19.5
0.165750	44.10	---	65.17	21.07	L1	OFF	19.5
0.176100	---	28.25	54.67	26.42	L1	OFF	19.5
0.176100	39.96	---	64.67	24.71	L1	OFF	19.5
0.285090	---	25.60	50.67	25.07	L1	OFF	19.5
0.285090	31.36	---	60.67	29.31	L1	OFF	19.5
0.419460	---	29.56	47.46	17.90	L1	OFF	19.5
0.419460	34.30	---	57.46	23.16	L1	OFF	19.5
2.036310	---	23.25	46.00	22.75	L1	OFF	19.7
2.036310	24.48	---	56.00	31.52	L1	OFF	19.7
6.056520	---	28.81	50.00	21.19	L1	OFF	19.8
6.056520	30.28	---	60.00	29.72	L1	OFF	19.8
13.328250	---	25.37	50.00	24.63	L1	OFF	20.1
13.328250	26.61	---	60.00	33.39	L1	OFF	20.1

EUT Information

Report NO : 901542-02
 Test Mode : Mode 2
 Test Voltage : 120Vac/60Hz
 Phase : Neutral

Full Spectrum

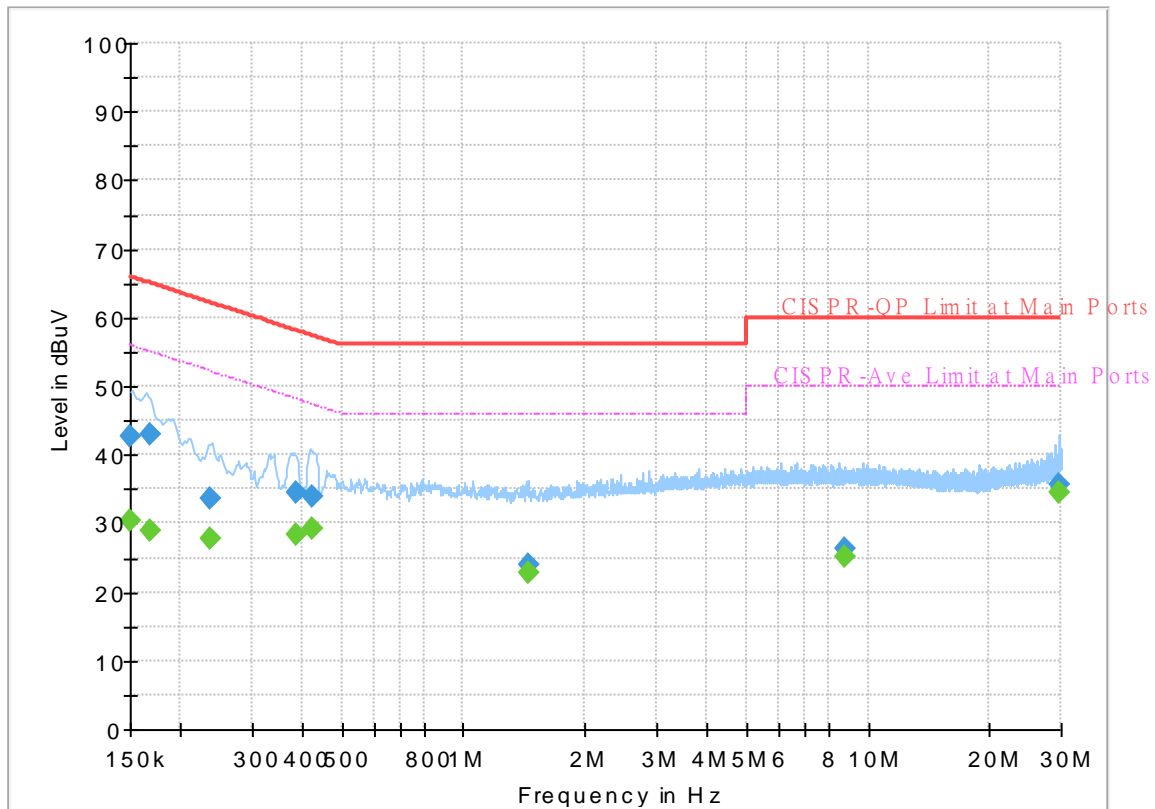

Final Result

Frequency (MHz)	QuasiPeak (dBuV)	CAverage (dBuV)	Limit (dBuV)	Margin (dB)	Line	Filter	Corr. (dB)
0.150000	---	30.28	56.00	25.72	N	OFF	19.6
0.150000	42.55	---	66.00	23.45	N	OFF	19.6
0.168000	---	28.87	55.06	26.19	N	OFF	19.6
0.168000	42.85	---	65.06	22.21	N	OFF	19.6
0.235500	---	27.84	52.25	24.41	N	OFF	19.6
0.235500	33.54	---	62.25	28.71	N	OFF	19.6
0.385890	---	28.48	48.15	19.67	N	OFF	19.6
0.385890	34.42	---	58.15	23.73	N	OFF	19.6
0.422250	---	29.25	47.40	18.15	N	OFF	19.6
0.422250	33.93	---	57.40	23.47	N	OFF	19.6
1.448070	---	22.72	46.00	23.28	N	OFF	19.6
1.448070	23.85	---	56.00	32.15	N	OFF	19.6
8.797290	---	25.13	50.00	24.87	N	OFF	20.0
8.797290	26.28	---	60.00	33.72	N	OFF	20.0
29.674860	---	34.49	50.00	15.51	N	OFF	20.7
29.674860	35.67	---	60.00	24.33	N	OFF	20.7



Appendix C. Radiated Spurious Emission

Test Engineer :	Jacky Hung, Andy Yang, and CR Liao	Temperature :	20~25°C
		Relative Humidity :	50~60%

<1Mbps>

2.4GHz 2400~2483.5MHz

BT (Band Edge @ 3m)

BT	Note	Frequency	Level	Over	Limit	Read	Antenna	Path	Preamp	Ant	Table	Peak	Pol.	
		(MHz)	(dBμV/m)	(dB)	Limit	Level	Factor	Loss	Factor	Pos	Pos	Avg.		
		(MHz)	(dBμV/m)	(dB)	(dBμV/m)	(dBμV)	(dB/m)	(dB)	(dB)	(cm)	(deg)	(P/A)	(H/V)	
BT CH00 2402MHz		2318.61	47.03	-26.97	74	40.79	27.93	8.06	29.75	110	350	P	H	
		2318.61	22.24	-31.76	54	-	-	-	-	-	-	A	H	
	*	2402	106.58	-	-	100.58	27.6	8.19	29.79	110	350	P	H	
	*	2402	81.79	-	-	-	-	-	-	-	-	A	H	
													H	
			2333.73	47.28	-26.72	74	41.09	27.87	8.08	29.76	400	91	P	V
			2333.73	22.49	-31.51	54	-	-	-	-	-	-	A	V
	*		2402	104.51	-	-	98.51	27.6	8.19	29.79	400	91	P	V
	*		2402	79.72	-	-	-	-	-	-	-	-	A	V
														V
BT CH 39 2441MHz		2333.1	48.46	-25.54	74	42.27	27.87	8.08	29.76	162	351	P	H	
		2333.1	23.67	-30.33	54	-	-	-	-	-	-	A	H	
	*	2441	108.51	-	-	102.46	27.6	8.26	29.81	162	351	P	H	
	*	2441	83.72	-	-	-	-	-	-	-	-	A	H	
			2493.21	47.36	-26.64	74	41.34	27.51	8.34	29.83	162	351	P	H
			2493.21	22.57	-31.43	54	-	-	-	-	-	-	A	H
			2328.76	46.55	-27.45	74	40.36	27.88	8.07	29.76	395	107	P	V
			2328.76	21.76	-32.24	54	-	-	-	-	-	-	A	V
	*		2441	106.35	-	-	100.3	27.6	8.26	29.81	395	107	P	V
	*		2441	81.56	-	-	-	-	-	-	-	-	A	V
			2494.26	47.16	-26.84	74	41.14	27.51	8.34	29.83	395	107	P	V
			2494.26	22.37	-31.63	54	-	-	-	-	-	-	A	V



BT CH 78 2480MHz	*	2480	106.17	-	-	100.13	27.54	8.32	29.82	100	351	P	H
	*	2480	81.38	-	-	-	-	-	-	-	-	A	H
		2483.8	50.26	-23.74	74	44.23	27.53	8.32	29.82	100	351	P	H
		2483.8	25.47	-28.53	54	-	-	-	-	-	-	A	H
													H
													H
	*	2480	103.56	-	-	97.52	27.54	8.32	29.82	384	106	P	V
	*	2480	78.77	-	-	-	-	-	-	-	-	A	V
		2483.56	49.25	-24.75	74	43.22	27.53	8.32	29.82	384	106	P	V
		2483.56	24.46	-29.54	54	-	-	-	-	-	-	A	V
													V
													V
Remark	1. No other spurious found. 2. All results are PASS against Peak and Average limit line.												



2.4GHz 2400~2483.5MHz
BT (Harmonic @ 3m)

BT	Note	Frequency (MHz)	Level (dBμV/m)	Over Limit (dB)	Limit Line (dBμV/m)	Read Level (dBμV)	Antenna Factor (dB/m)	Path Loss (dB)	Preamp Factor (dB)	Ant Pos (cm)	Table Pos (deg)	Peak Avg. (P/A)	Pol. (H/V)	
BT CH 00 2402MHz		4804	37.46	-36.54	74	52.03	31.11	12.43	58.11	100	0	P	H	
		4804	12.67	-41.33	54	-	-	-	-	-	-	A	H	
													H	
													H	
		4804	39.37	-34.63	74	53.94	31.11	12.43	58.11	100	0	P	V	
		4804	14.58	-39.42	54	-	-	-	-	-	-	-	A	H
													V	
													V	
BT CH 39 2441MHz		4882	37.4	-36.6	74	51.96	31.07	12.5	58.13	100	0	P	H	
		4882	12.61	-41.39	54	-	-	-	-	-	-	A	H	
		7323	42.52	-31.48	74	47.92	36.49	15.6	57.49	100	0	P	H	
		7323	17.73	-36.27	54	-	-	-	-	-	-	A	H	
		4882	38.91	-35.09	74	53.47	31.07	12.5	58.13	100	0	P	V	
		4882	14.12	-39.88	54	-	-	-	-	-	-	A	V	
		7323	42.7	-31.3	74	48.1	36.49	15.6	57.49	100	0	P	V	
		7323	17.91	-36.09	54	-	-	-	-	-	-	A	V	
BT CH 78 2480MHz		4960	38.97	-35.03	74	53.29	31.26	12.56	58.14	100	0	P	H	
		4960	14.18	-39.82	54	-	-	-	-	-	-	A	H	
		7440	42.59	-31.41	74	47.62	36.58	15.72	57.33	100	0	P	H	
		7440	17.8	-36.20	54	-	-	-	-	-	-	A	H	
		4960	39.89	-34.11	74	54.21	31.26	12.56	58.14	100	0	P	V	
		4960	15.1	-38.90	54	-	-	-	-	-	-	A	V	
		7440	42.97	-31.03	74	48	36.58	15.72	57.33	100	0	P	V	
		7440	18.18	-35.82	54	-	-	-	-	-	-	A	V	
Remark	1. No other spurious found. 2. All results are PASS against Peak and Average limit line.													



<2Mbps>

2.4GHz 2400~2483.5MHz

BT (Band Edge @ 3m)

BT	Note	Frequency	Level	Over Limit	Limit Line	Read Level	Antenna Factor	Path Loss	Preamp Factor	Ant Pos	Table Pos	Peak Avg.	Pol.	
		(MHz)	(dBμV/m)	(dB)	(dBμV/m)	(dBμV)	(dB/m)	(dB)	(dB)	(cm)	(deg)	(P/A)	(H/V)	
BT CH00 2402MHz		2312.625	47.44	-26.56	74	41.19	27.95	8.05	29.75	144	24	P	H	
		2312.625	22.65	-31.35	54	-	-	-	-	-	-	A	H	
	*	2402	107.8	-	-	101.8	27.6	8.19	29.79	144	24	P	H	
	*	2402	83.01	-	-	-	-	-	-	-	-	A	H	
													H	
													H	
			2381.085	47.11	-26.89	74	41.05	27.68	8.16	29.78	400	90	P	V
			2381.085	22.32	-31.68	54	-	-	-	-	-	-	A	V
	*	2402	106.75	-	-	100.75	27.6	8.19	29.79	400	90	P	V	
	*	2402	81.96	-	-	-	-	-	-	-	-	-	A	V
													V	
													V	
BT CH 39 2441MHz		2331.28	46.8	-27.2	74	40.61	27.87	8.08	29.76	109	23	P	H	
		2331.28	22.01	-31.99	54	-	-	-	-	-	-	A	H	
	*	2441	109.91	-	-	103.86	27.6	8.26	29.81	109	23	P	H	
	*	2441	85.12	-	-	-	-	-	-	-	-	A	H	
			2486.28	47.48	-26.52	74	41.44	27.53	8.33	29.82	109	23	P	H
			2486.28	22.69	-31.31	54	-	-	-	-	-	-	A	H
			2351.58	46.86	-27.14	74	40.73	27.79	8.11	29.77	388	89	P	V
			2351.58	22.07	-31.93	54	-	-	-	-	-	-	A	V
	*	2441	108.7	-	-	102.65	27.6	8.26	29.81	388	89	P	V	
	*	2441	83.91	-	-	-	-	-	-	-	-	-	A	V
			2492.37	47.37	-26.63	74	41.34	27.52	8.34	29.83	388	89	P	V
			2492.37	22.58	-31.42	54	-	-	-	-	-	-	A	V



BT CH 78 2480MHz	*	2480	107.48	-	-	101.44	27.54	8.32	29.82	129	23	P	H	
	*	2480	82.69	-	-	-	-	-	-	-	-	A	H	
		2486.84	49.49	-24.51	74	43.45	27.53	8.33	29.82	129	23	P	H	
		2486.84	24.7	-29.3	54	-	-	-	-	-	-	A	H	
													H	
													H	
	*	2480	104.62	-	-	98.58	27.54	8.32	29.82	384	107	P	V	
	*	2480	79.83	-	-	-	-	-	-	-	-	-	A	V
		2483.56	48.11	-25.89	74	42.08	27.53	8.32	29.82	384	107	P	V	
		2483.56	23.32	-30.68	54	-	-	-	-	-	-	A	V	
													V	
													V	
Remark	<ol style="list-style-type: none"> 1. No other spurious found. 2. All results are PASS against Peak and Average limit line. 													



2.4GHz 2400~2483.5MHz
BT (Harmonic @ 3m)

BT	Note	Frequency (MHz)	Level (dBμV/m)	Over Limit (dB)	Limit Line (dBμV/m)	Read Level (dBμV)	Antenna Factor (dB/m)	Path Loss (dB)	Preamp Factor (dB)	Ant Pos (cm)	Table Pos (deg)	Peak Avg. (P/A)	Pol. (H/V)
BT CH 00 2402MHz		4804	37.73	-36.27	74	52.3	31.11	12.43	58.11	100	0	P	H
		4804	12.94	-41.06	54	-	-	-	-	-	-	A	H
													H
													H
		4804	39.59	-34.41	74	54.16	31.11	12.43	58.11	100	0	P	V
		4804	14.8	-39.2	54	-	-	-	-	-	-	A	V
													V
													V
BT CH 39 2441MHz		4882	37.18	-36.82	74	51.74	31.07	12.5	58.13	100	0	P	H
		4882	12.39	-41.61	54	-	-	-	-	-	-	A	H
		7323	42.26	-31.74	74	47.66	36.49	15.6	57.49	100	0	P	H
		7323	17.47	-36.53	54	-	-	-	-	-	-	A	H
		4882	38.88	-35.12	74	53.44	31.07	12.5	58.13	100	0	P	V
		4882	14.09	-39.91	54	-	-	-	-	-	-	A	V
		7323	42.38	-31.62	74	47.78	36.49	15.6	57.49	100	0	P	V
		7323	17.59	-36.41	54	-	-	-	-	-	-	A	V
BT CH 78 2480MHz		4960	38.41	-35.59	74	52.73	31.26	12.56	58.14	100	0	P	H
		4960	13.62	-40.38	54	-	-	-	-	-	-	A	H
		7440	42.68	-31.32	74	47.71	36.58	15.72	57.33	100	0	P	H
		7440	17.89	-36.11	54	-	-	-	-	-	-	A	H
		4960	39.94	-34.06	74	54.26	31.26	12.56	58.14	100	0	P	V
		4960	15.15	-38.85	54	-	-	-	-	-	-	A	V
		7440	42.14	-31.86	74	47.17	36.58	15.72	57.33	100	0	P	V
		7440	17.35	-36.65	54	-	-	-	-	-	-	A	V
Remark	1. No other spurious found. 2. All results are PASS against Peak and Average limit line.												



<3Mbps>

2.4GHz 2400~2483.5MHz

BT (Band Edge @ 3m)

BT	Note	Frequency	Level	Over Limit	Limit Line	Read Level	Antenna Factor	Path Loss	Preamp Factor	Ant Pos	Table Pos	Peak Avg.	Pol.	
		(MHz)	(dBμV/m)	(dB)	(dBμV/m)	(dBμV)	(dB/m)	(dB)	(dB)	(cm)	(deg)	(P/A)	(H/V)	
BT CH00 2402MHz		2368.065	47.1	-26.9	74	41	27.73	8.14	29.77	141	72	P	H	
		2368.065	22.31	-31.69	54	-	-	-	-	-	-	A	H	
	*	2402	107.73	-	-	101.73	27.6	8.19	29.79	141	72	P	H	
	*	2402	82.94	-	-	-	-	-	-	-	-	A	H	
													H	
														H
			2372.475	47.47	-26.53	74	41.4	27.71	8.14	29.78	400	92	P	V
			2372.475	22.68	-31.32	54	-	-	-	-	-	-	A	V
	*		2402	106.37	-	-	100.37	27.6	8.19	29.79	400	92	P	V
	*		2402	81.58	-	-	-	-	-	-	-	-	A	V
														V
														V
BT CH 39 2441MHz		2347.24	47.7	-26.3	74	41.56	27.81	8.1	29.77	166	29	P	H	
		2347.24	22.91	-31.09	54	-	-	-	-	-	-	A	H	
	*	2441	109.66	-	-	103.61	27.6	8.26	29.81	166	29	P	H	
	*	2441	84.87	-	-	-	-	-	-	-	-	A	H	
			2484.11	47.27	-26.73	74	41.24	27.53	8.32	29.82	166	29	P	H
			2484.11	22.48	-31.52	54	-	-	-	-	-	-	A	H
			2389.66	46.72	-27.28	74	40.69	27.64	8.17	29.78	398	108	P	V
			2389.66	21.93	-32.07	54	-	-	-	-	-	-	A	V
	*		2441	107.62	-	-	101.57	27.6	8.26	29.81	398	108	P	V
	*		2441	82.83	-	-	-	-	-	-	-	-	A	V
			2496.57	48.13	-25.87	74	42.11	27.51	8.34	29.83	398	108	P	V
			2496.57	23.34	-30.66	54	-	-	-	-	-	-	A	V



BT CH 78 2480MHz	*	2480	107.19	-	-	101.15	27.54	8.32	29.82	103	26	P	H
	*	2480	82.4	-	-	-	-	-	-	-	-	A	H
		2483.72	51.34	-22.66	74	45.31	27.53	8.32	29.82	103	26	P	H
		2483.72	26.55	-27.45	54	-	-	-	-	-	-	A	H
													H
													H
	*	2480	102.78	-	-	96.74	27.54	8.32	29.82	385	128	P	V
	*	2480	77.99	-	-	-	-	-	-	-	-	A	V
		2483.6	49.19	-24.81	74	43.16	27.53	8.32	29.82	385	128	P	V
		2483.6	24.4	-29.6	54	-	-	-	-	-	-	A	V
													V
													V
Remark	1. No other spurious found. 2. All results are PASS against Peak and Average limit line.												



2.4GHz 2400~2483.5MHz
BT (Harmonic @ 3m)

BT	Note	Frequency (MHz)	Level (dBμV/m)	Over Limit (dB)	Limit Line (dBμV/m)	Read Level (dBμV)	Antenna Factor (dB/m)	Path Loss (dB)	Preamp Factor (dB)	Ant Pos (cm)	Table Pos (deg)	Peak Avg. (P/A)	Pol. (H/V)
BT CH 00 2402MHz		4804	37.7	-36.3	74	52.27	31.11	12.43	58.11	100	0	P	H
		4804	12.91	-41.09	54	-	-	-	-	-	-	A	H
													H
													H
		4804	40.4	-33.6	74	54.97	31.11	12.43	58.11	100	0	P	V
		4804	15.61	-38.39	54	-	-	-	-	-	-	A	V
													V
													V
BT CH 39 2441MHz		4882	37.71	-36.29	74	52.27	31.07	12.5	58.13	100	0	P	H
		4882	12.92	-41.08	54	-	-	-	-	-	-	A	H
		7323	42.89	-31.11	74	48.29	36.49	15.6	57.49	100	0	P	H
		7323	18.1	-35.9	54	-	-	-	-	-	-	A	H
		4882	41.71	-32.29	74	56.27	31.07	12.5	58.13	100	0	P	V
		4882	16.92	-37.08	54	-	-	-	-	-	-	A	V
		7323	43.52	-30.48	74	48.92	36.49	15.6	57.49	100	0	P	V
		7323	18.73	-35.27	54	-	-	-	-	-	-	A	V
BT CH 78 2480MHz		4960	40.54	-33.46	74	54.86	31.26	12.56	58.14	100	0	P	H
		4960	15.75	-38.25	54	-	-	-	-	-	-	A	H
		7440	43.86	-30.14	74	48.89	36.58	15.72	57.33	100	0	P	H
		7440	19.07	-34.93	54	-	-	-	-	-	-	A	H
		4960	41.61	-32.39	74	55.93	31.26	12.56	58.14	100	0	P	V
		4960	16.82	-37.18	54	-	-	-	-	-	-	A	V
		7440	43.77	-30.23	74	48.8	36.58	15.72	57.33	100	0	P	V
		7440	18.98	-35.02	54	-	-	-	-	-	-	A	V
Remark	1. No other spurious found. 2. All results are PASS against Peak and Average limit line.												



Emission above 18GHz

2.4GHz BT (SHF)

BT	Note	Frequency	Level	Over	Limit	Read	Antenna	Path	Preamp	Ant	Table	Peak	Pol.	
		(MHz)	(dBμV/m)	(dB)	(dBμV/m)	(dBμV)	(dB/m)	(dB)	(dB)	(cm)	(deg)	(P/A)	(H/V)	
2.4GHz BT SHF		21444	40.17	-33.83	74	43.29	38.04	13.33	53.49	150	0	P	H	
													H	
													H	
													H	
													H	
													H	
			21325	39.98	-34.02	74	43.05	38.14	12.26	53.47	150	0	P	V
														V
														V
														V
Remark	1. No other spurious found. 2. All results are PASS against limit line.													



Emission below 1GHz

2.4GHz BT (LF)

BT	Note	Frequency	Level	Over	Limit	Read	Antenna	Path	Preamp	Ant	Table	Peak	Pol.	
		(MHz)	(dBμV/m)	(dB)	(dBμV/m)	(dBμV)	(dB/m)	(dB)	(dB)	(cm)	(deg)	(P/A)	(H/V)	
2.4GHz BT LF		37.76	30.61	-9.39	40	41.32	20.55	1.03	32.29	100	0	P	H	
		181.32	26.6	-16.9	43.5	41.72	14.84	2.35	32.31	-	-	P	H	
		386.96	22.64	-23.36	46	30.18	21.32	3.36	32.22	-	-	P	H	
		555.74	27.63	-18.37	46	29.66	25.93	4.04	32	-	-	P	H	
		766.23	32.77	-13.23	46	32.19	28.12	4.76	32.3	-	-	P	H	
		915.61	32.76	-13.24	46	29.95	29.35	5.2	31.74	-	-	P	H	
														H
														H
														H
														H
														H
														H
			182.29	33.27	-10.23	43.5	48.43	14.8	2.35	32.31	-	-	P	V
			405.39	23.34	-22.66	46	30.02	22.05	3.46	32.19	-	-	P	V
			561.56	27.92	-18.08	46	29.68	26.17	4.06	31.99	-	-	P	V
			684.75	29.99	-16.01	46	31.21	26.41	4.48	32.11	-	-	P	V
			755.56	30.9	-15.1	46	30.39	28.06	4.72	32.27	-	-	P	V
			952.47	36.32	-9.68	46	31.5	30.8	5.32	31.3	100	0	P	V
														V
														V
													V	
													V	
													V	
													V	
Remark	1. No other spurious found. 2. All results are PASS against limit line.													



<WPC Mode>

2.4GHz 2400~2483.5MHz

BT (Band Edge @ 3m)

BT	Note	Frequency	Level	Over Limit	Limit Line	Read Level	Antenna Factor	Path Loss	Preamp Factor	Ant Pos	Table Pos	Peak Avg.	Pol.	
		(MHz)	(dBμV/m)	(dB)	(dBμV/m)	(dBμV)	(dB/m)	(dB)	(dB)	(cm)	(deg)	(P/A)	(H/V)	
BT CH 78 2480MHz	*	2480	105.78	-	-	99.74	27.54	8.32	29.82	104	71	P	H	
		2480	80.99			-	-	-	-	-	-	A	H	
		2483.64	48.18	-25.82	74	42.15	27.53	8.32	29.82	104	71	P	H	
		2483.64	23.39	-30.61	54	-	-	-	-	-	-	A	H	
													H	
													H	
	*	2480	102.93	-	-	96.89	27.54	8.32	29.82	255	90	P	V	
		2480	78.14			-	-	-	-	-	-	-	A	V
		2483.6	46.98	-27.02	74	40.95	27.53	8.32	29.82	255	90	P	V	
		2483.6	22.19	-31.81	54	-	-	-	-	-	-	A	V	
													V	
													V	
Remark	1. No other spurious found. 2. All results are PASS against Peak and Average limit line.													



2.4GHz 2400~2483.5MHz

BT (Harmonic @ 3m)

BT	Note	Frequency (MHz)	Level (dBμV/m)	Over Limit (dB)	Limit Line (dBμV/m)	Read Level (dBμV)	Antenna Factor (dB/m)	Path Loss (dB)	Preamp Factor (dB)	Ant Pos (cm)	Table Pos (deg)	Peak Avg. (P/A)	Pol. (H/V)
BT CH 78 2480MHz		4960	40.75	-33.25	74	55.07	31.26	12.56	58.14	100	0	P	H
		4960	15.96	-38.04	54	-	-	-	-	-	-	A	H
		7440	44.5	-29.5	74	49.47	36.58	15.78	57.33	100	0	P	H
		7440	19.71	-34.29	54	-	-	-	-	-	-	A	H
		4960	44.31	-29.69	74	58.63	31.26	12.56	58.14	100	0	P	V
		4960	19.52	-34.48	54	-	-	-	-	-	-	A	V
		7440	43.97	-30.03	74	48.94	36.58	15.78	57.33	100	0	P	V
		7440	19.18	-34.82	54	-	-	-	-	-	-	A	V
Remark	1. No other spurious found. 2. All results are PASS against Peak and Average limit line.												



Emission below 1GHz

2.4GHz BT (LF)

BT	Note	Frequency	Level	Over	Limit	Read	Antenna	Path	Preamp	Ant	Table	Peak	Pol.	
		(MHz)	(dBμV/m)	(dB)	(dBμV/m)	(dBμV)	(dB/m)	(dB)	(dB)	(cm)	(deg)	(P/A)	(H/V)	
2.4GHz BT LF		31.94	22.24	-17.76	40	30.1	23.41	0.93	32.22	-	-	P	H	
		73.65	21.65	-18.35	40	40.1	12.45	1.42	32.34	-	-	P	H	
		147.37	25.78	-17.72	43.5	38.9	17.02	2.06	32.28	-	-	P	H	
		211.39	26.35	-17.15	43.5	40.96	15.2	2.45	32.32	-	-	P	H	
		772.05	31.49	-14.51	46	30.88	28.14	4.64	32.31	-	-	P	H	
		932.1	34.49	-11.51	46	30.87	29.9	5.09	31.54	100	0	P	H	
													H	
													H	
													H	
													H	
													H	
													H	
			32.91	32.78	-7.22	40	41.06	22.99	0.95	32.23	100	0	P	V
			36.79	31.73	-8.27	40	42.11	20.88	1.01	32.27	-	-	P	V
			73.65	28.47	-11.53	40	46.92	12.45	1.42	32.34	-	-	P	V
			186.17	26.89	-16.61	43.5	42.07	14.76	2.29	32.31	-	-	P	V
			431.58	25.59	-20.41	46	31.36	22.85	3.5	32.17	-	-	P	V
			921.43	33.67	-12.33	46	30.63	29.5	5.05	31.67	-	-	P	V
														V
														V
													V	
													V	
													V	
													V	
Remark	1. No other spurious found. 2. All results are PASS against limit line.													



Note symbol

*	Fundamental Frequency which can be ignored. However, the level of any unwanted emissions shall not exceed the level of the fundamental frequency.
!	Test result is over limit line.
P/A	Peak or Average
H/V	Horizontal or Vertical



A calculation example for radiated spurious emission is shown as below:

BT	Note	Frequency	Level	Over	Limit	Read	Antenna	Path	Preamp	Ant	Table	Peak	Pol.
		(MHz)	(dBμV/m)	(dB)	Line	Level	Factor	Loss	Factor	Pos	Pos	Avg.	
					(dBμV/m)	(dBμV)	(dB/m)	(dB)	(dB)	(cm)	(deg)	(P/A)	(H/V)
BT		2390	55.45	-18.55	74	54.51	32.22	4.58	35.86	103	308	P	H
CH 00		2390	43.54	-10.46	54	42.6	32.22	4.58	35.86	103	308	A	H
2402MHz													

1. Path Loss(dB) = Cable loss(dB) + Filter loss(dB) + Attenuator loss(dB)
2. Level(dBμV/m) =
Antenna Factor(dB/m) + Path Loss(dB) + Read Level(dBμV) - Preamp Factor(dB)
3. Over Limit(dB) = Level(dBμV/m) – Limit Line(dBμV/m)

For Peak Limit @ 2390MHz:

1. Level(dBμV/m)
= Antenna Factor(dB/m) + Path Loss(dB) + Read Level(dBμV) - Preamp Factor(dB)
= 32.22(dB/m) + 4.58(dB) + 54.51(dBμV) – 35.86 (dB)
= 55.45 (dBμV/m)
2. Over Limit(dB)
= Level(dBμV/m) – Limit Line(dBμV/m)
= 55.45(dBμV/m) – 74(dBμV/m)
= -18.55(dB)

For Average Limit @ 2390MHz:

1. Level(dBμV/m)
= Antenna Factor(dB/m) + Path Loss(dB) + Read Level(dBμV) - Preamp Factor(dB)
= 32.22(dB/m) + 4.58(dB) + 42.6(dBμV) – 35.86 (dB)
= 43.54 (dBμV/m)
2. Over Limit(dB)
= Level(dBμV/m) – Limit Line(dBμV/m)
= 43.54(dBμV/m) – 54(dBμV/m)
= -10.46(dB)

Both peak and average measured complies with the limit line, so test result is “PASS”.



Appendix D. Radiated Spurious Emission Plots

Test Engineer :	Jacky Hung, Andy Yang, and CR Liao	Temperature :	20~25°C
		Relative Humidity :	50~60%

Note symbol

-L	Low channel location
-R	High channel location



<1Mbps>

2.4GHz 2400~2483.5MHz

BT (Band Edge @ 3m)

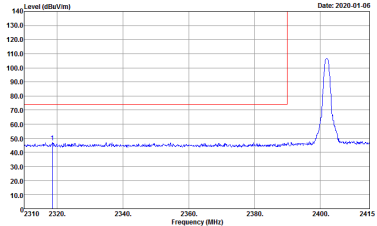
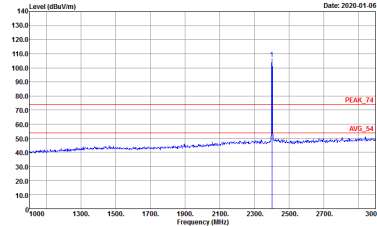
BT	2.4GHz 2400~2483.5MHz Band Edge @ 3m	
	BT CH00 2402MHz	
	Horizontal	Fundamental
Peak	 <p>Date: 2020-01-06</p> <p>Site : 03CH15-1FV Condition : PEAK_BE_74 3m 91200_1522 HORIZONTAL : RBW:1000.000KHz VBW:3000.000KHz SWT:Auto Detector : Peak Project : 901542-02</p>	 <p>Date: 2020-01-06</p> <p>Site : 03CH15-1FV Condition : PEAK_74 3m 91200_1522 HORIZONTAL : RBW:1000.000KHz VBW:3000.000KHz SWT:Auto Detector : Peak Project : 901542-02</p>



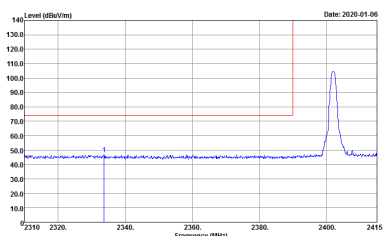
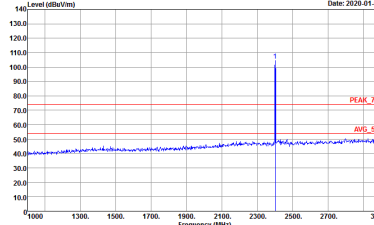

BT	2.4GHz 2400~2483.5MHz Band Edge @ 3m	
BT CH00 2402MHz		
	Vertical	Fundamental
Peak	 <p>Date: 2020-01-06</p> <p>Site : 03CH16-HY Condition : PEAK_8E_74 3m 91200_1522 VERTICAL RBW:1000.000KHz VBW:3000.000KHz SWT:Auto Detector : Peak Project : 901542-02</p>	 <p>Date: 2020-01-06</p> <p>Site : 03CH16-HY Condition : PEAK_74 3m 91200_1522 VERTICAL RBW:1000.000KHz VBW:3000.000KHz SWT:Auto Detector : Peak Project : 901542-02</p>

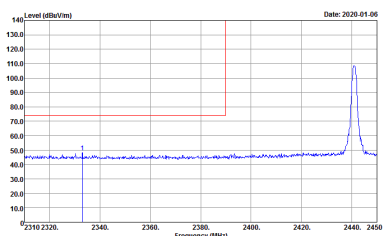
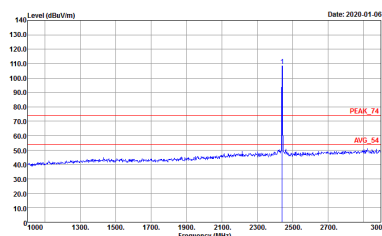
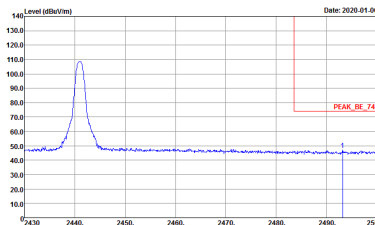

BT	2.4GHz 2400~2483.5MHz Band Edge @ 3m	
BT CH39 2441MHz		
	Horizontal	Fundamental
Peak	 <p>Site : 03CH16-HY Condition : PEAK_BE_74 3m 91200_1522 HORIZONTAL RBW:1000.000KHz VBW:3000.000KHz SWT:Auto Detector : Peak Project : 901542-02</p>	 <p>Site : 03CH16-HY Condition : PEAK_74 3m 91200_1522 HORIZONTAL RBW:1000.000KHz VBW:3000.000KHz SWT:Auto Detector : Peak Project : 901542-02</p>
Peak	 <p>Site : 03CH16-HY Condition : PEAK_BE_74 3m 91200_1522 HORIZONTAL RBW:1000.000KHz VBW:3000.000KHz SWT:Auto Detector : Peak Project : 901542-02</p>	Left blank

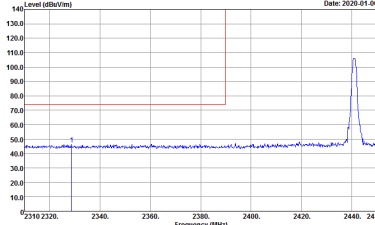
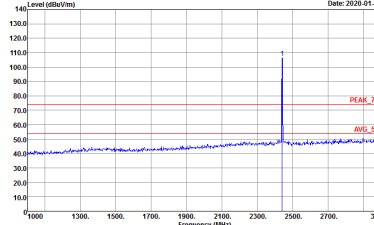

BT	2.4GHz 2400~2483.5MHz Band Edge @ 3m	
BT CH39 2441MHz		
	Vertical	Fundamental
Peak	 <p> Site : 03CH16-HY Condition : PEAK_BE_74 3m 91200_1522 VERTICAL RBW:1000.000KHz VBW:3000.000KHz SWT:Auto Detector : Peak Project : 901542-02 </p>	 <p> Site : 03CH16-HY Condition : PEAK_74 3m 91200_1522 VERTICAL RBW:1000.000KHz VBW:3000.000KHz SWT:Auto Detector : Peak Project : 901542-02 </p>
Peak	 <p> Site : 03CH16-HY Condition : PEAK_BE_74 3m 91200_1522 VERTICAL RBW:1000.000KHz VBW:3000.000KHz SWT:Auto Detector : Peak Project : 901542-02 </p>	Left blank

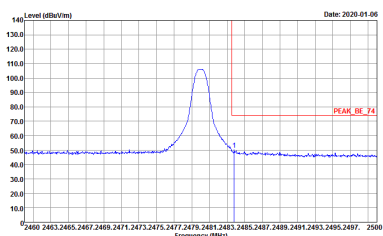
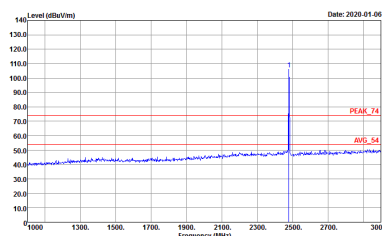

BT	2.4GHz 2400~2483.5MHz Band Edge @ 3m	
BT CH78 2480MHz		
	Horizontal	Fundamental
Peak	 <p data-bbox="430 705 813 772">Site : 03CH16-HY Condition : PEAK_BE_74 3m 91200_1522 HORIZONTAL RBW:1000.000KHz VBW:3000.000KHz SWT:Auto Detector : Peak Project : 901542-02</p>	 <p data-bbox="901 705 1284 772">Site : 03CH16-HY Condition : PEAK_74 3m 91200_1522 HORIZONTAL RBW:1000.000KHz VBW:3000.000KHz SWT:Auto Detector : Peak Project : 901542-02</p>

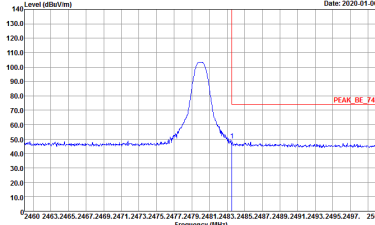
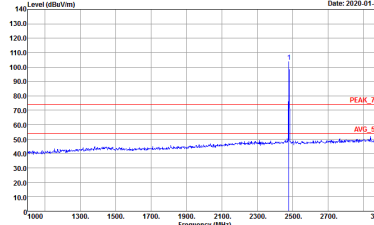

BT	2.4GHz 2400~2483.5MHz Band Edge @ 3m	
BT CH78 2480MHz		
	Vertical	Fundamental
Peak	 <p>Date: 2020-01-06</p> <p>Site : 03CH16-HY Condition : PEAK_BE_74 3m 91200_1522 VERTICAL RBW:1000.000KHz VBW:3000.000KHz SWT:Auto Detector : Peak Project : 901542-02</p>	 <p>Date: 2020-01-06</p> <p>Site : 03CH16-HY Condition : PEAK_74 3m 91200_1522 VERTICAL RBW:1000.000KHz VBW:3000.000KHz SWT:Auto Detector : Peak Project : 901542-02</p>



2.4GHz 2400~2483.5MHz

BT (Harmonic @ 3m)

BT	2.4GHz 2400~2483.5MHz Harmonic @ 3m	
	BT CH00 2402MHz	
	Horizontal	Vertical
Peak Avg.	<p>Site : 03CH16-1FY Condition : PEAK_74 3m 91200_1522 HORIZONTAL Detector : Peak Project : 901542-02</p>	<p>Site : 03CH16-1FY Condition : PEAK_74 3m 91200_1522 VERTICAL Detector : Peak Project : 901542-02</p>

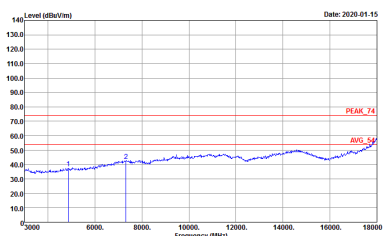
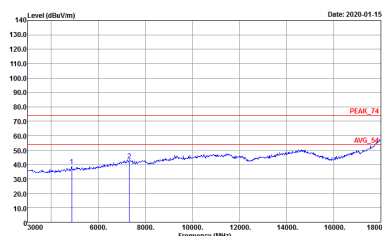

BT	2.4GHz 2400~2483.5MHz Harmonic @ 3m	
BT CH39 2441MHz		
Horizontal		Vertical
Peak Avg.	 <p data-bbox="430 712 670 761">Site : 03CH16-HY Condition : PEAK_74 3m 91200_1522 HORIZONTAL Detector : Peak Project : 901542-02</p>	 <p data-bbox="901 712 1141 761">Site : 03CH16-HY Condition : PEAK_74 3m 91200_1522 VERTICAL Detector : Peak Project : 901542-02</p>

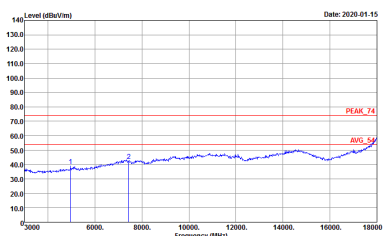
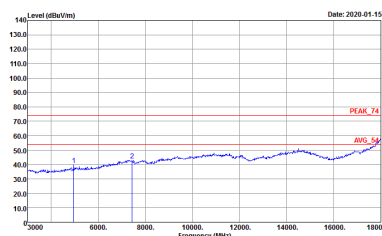

BT	2.4GHz 2400~2483.5MHz Harmonic @ 3m	
BT CH78 2480MHz		
Horizontal		Vertical
Peak Avg.	 <p data-bbox="430 705 670 761">Site : 03CH16-HY Condition : PEAK_74 3m 91200_1522 HORIZONTAL Detector : Peak Project : 901542-02</p>	 <p data-bbox="901 705 1141 761">Site : 03CH16-HY Condition : PEAK_74 3m 91200_1522 VERTICAL Detector : Peak Project : 901542-02</p>



<2Mbps>

2.4GHz 2400~2483.5MHz

BT (Band Edge @ 3m)

BT	2.4GHz 2400~2483.5MHz Band Edge @ 3m	
	BT CH00 2402MHz	
	Horizontal	Fundamental
Peak	<p>Site : 03CH15-1Y Condition : PEAK_BE_74 3m 91200_1522 HORIZONTAL Detector : Peak Project : 901542-02</p>	<p>Site : 03CH15-1Y Condition : PEAK_74 3m 91200_1522 HORIZONTAL Detector : Peak Project : 901542-02</p>

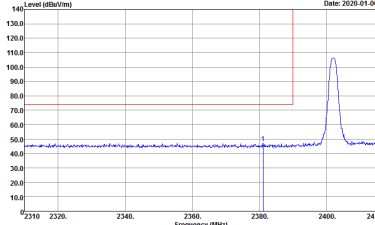
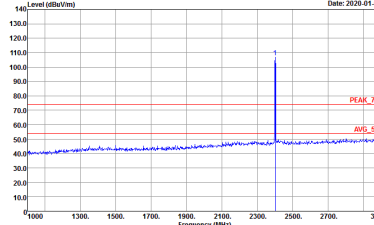

BT	2.4GHz 2400~2483.5MHz Band Edge @ 3m	
BT CH00 2402MHz		
	Vertical	Fundamental
Peak	 <p>Date: 2020-01-06</p> <p>Site : 03CH16-HY Condition : PEAK_8E_74 3m 91200_1522 VERTICAL RBW:1000.000KHz VBW:3000.000KHz SWT:Auto Detector : Peak Project : 901542-02</p>	 <p>Date: 2020-01-06</p> <p>Site : 03CH16-HY Condition : PEAK_74 3m 91200_1522 VERTICAL RBW:1000.000KHz VBW:3000.000KHz SWT:Auto Detector : Peak Project : 901542-02</p>

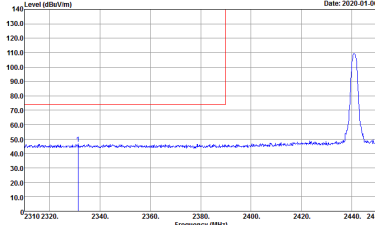
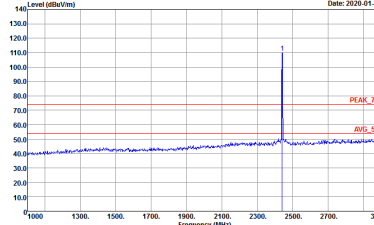
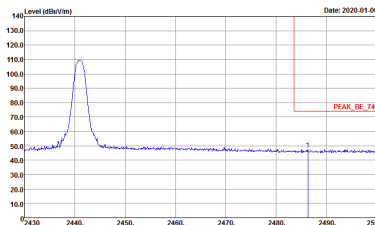

BT	2.4GHz 2400~2483.5MHz Band Edge @ 3m	
BT CH39 2441MHz		
	Horizontal	Fundamental
<p>Peak</p>	 <p>Site : 03CH16-HY Condition : PEAK_BE_74 3m 91200_1522 HORIZONTAL RBW:1000.000KHz VBW:3000.000KHz SWT:Auto Detector : Peak Project : 901542-02</p>	 <p>Site : 03CH16-HY Condition : PEAK_74 3m 91200_1522 HORIZONTAL RBW:1000.000KHz VBW:3000.000KHz SWT:Auto Detector : Peak Project : 901542-02</p>
<p>Peak</p>	 <p>Site : 03CH16-HY Condition : PEAK_BE_74 3m 91200_1522 HORIZONTAL RBW:1000.000KHz VBW:3000.000KHz SWT:Auto Detector : Peak Project : 901542-02</p>	<p>Left blank</p>

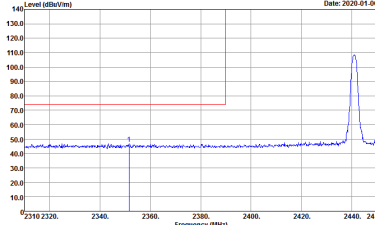
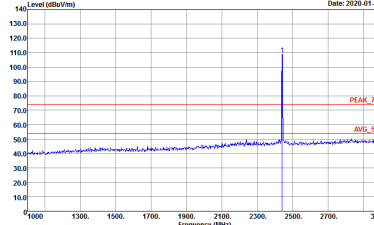
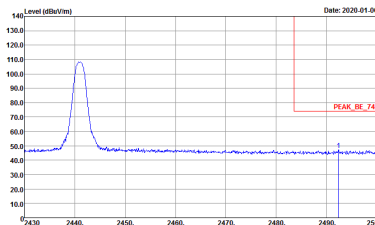

BT	2.4GHz 2400~2483.5MHz Band Edge @ 3m	
BT CH39 2441MHz		
	Vertical	Fundamental
Peak	 <p>Date: 2020-01-06</p> <p>Site : 03CH16-HY Condition : PEAK_BE_74 3m 91200_1522 VERTICAL RBW:1000.000KHz VBW:3000.000KHz SWT:Auto Detector : Peak Project : 901542-02</p>	 <p>Date: 2020-01-06</p> <p>Site : 03CH16-HY Condition : PEAK_74 3m 91200_1522 VERTICAL RBW:1000.000KHz VBW:3000.000KHz SWT:Auto Detector : Peak Project : 901542-02</p>
Peak	 <p>Date: 2020-01-06</p> <p>Site : 03CH16-HY Condition : PEAK_BE_74 3m 91200_1522 VERTICAL RBW:1000.000KHz VBW:3000.000KHz SWT:Auto Detector : Peak Project : 901542-02</p>	Left blank

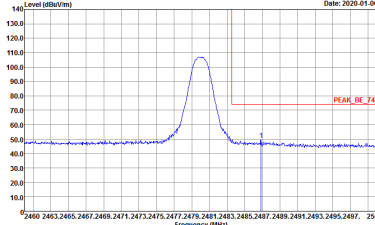
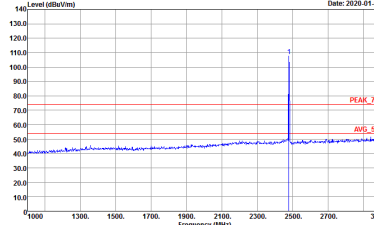

BT	2.4GHz 2400~2483.5MHz Band Edge @ 3m	
BT CH78 2480MHz		
	Horizontal	Fundamental
<p>Peak</p>	 <p>Date: 2020-01-06</p> <p>PEAK_BE_74</p> <p>Site : 03CH16-HY Condition : PEAK_BE_74 3m 91200_1522 HORIZONTAL RBW:1000.000KHz VBW:3000.000KHz SWT:Auto Detector : Peak Project : 901542-02</p>	 <p>Date: 2020-01-06</p> <p>PEAK_74</p> <p>Site : 03CH16-HY Condition : PEAK_74 3m 91200_1522 HORIZONTAL RBW:1000.000KHz VBW:3000.000KHz SWT:Auto Detector : Peak Project : 901542-02</p>

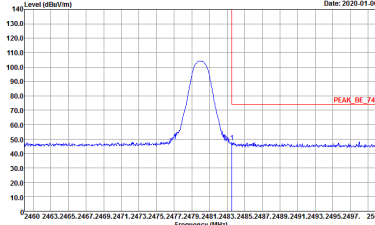
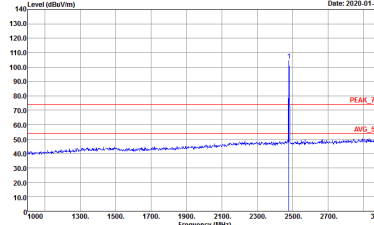

BT	2.4GHz 2400~2483.5MHz Band Edge @ 3m	
BT CH78 2480MHz		
	Vertical	Fundamental
<p>Peak</p>	 <p>Date: 2020-01-06</p> <p>Site : 03CH16-HY Condition : PEAK_BE_74 3m 91200_1522 VERTICAL RBW:1000.000KHz VBW:3000.000KHz SWT:Auto Detector : Peak Project : 901542-02</p>	 <p>Date: 2020-01-06</p> <p>Site : 03CH16-HY Condition : PEAK_74 3m 91200_1522 VERTICAL RBW:1000.000KHz VBW:3000.000KHz SWT:Auto Detector : Peak Project : 901542-02</p>



2.4GHz 2400~2483.5MHz

BT (Harmonic @ 3m)

BT	2.4GHz 2400~2483.5MHz Harmonic @ 3m	
	BT CH00 2402MHz	
	Horizontal	Vertical
Peak Avg.	<p>Site : 03CH16-1FY Condition : PEAK_74 3m 91200_1522 HORIZONTAL Detector : Peak Project : 901542-02</p>	<p>Site : 03CH16-1FY Condition : PEAK_74 3m 91200_1522 VERTICAL Detector : Peak Project : 901542-02</p>

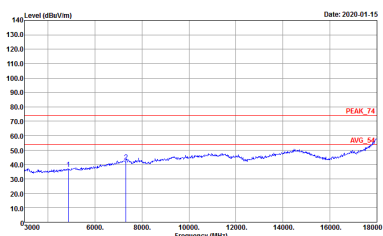
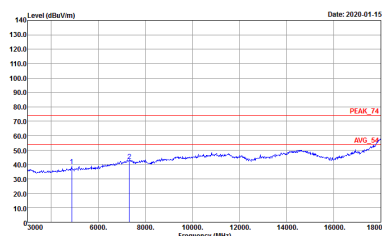

BT	2.4GHz 2400~2483.5MHz Harmonic @ 3m	
	BT CH39 2441MHz	
	Horizontal	Vertical
Peak Avg.	 <p>Site : 03CH16-HY Condition : PEAK_74 3m 91200_1522 HORIZONTAL Detector : Peak Project : 901542-02</p>	 <p>Site : 03CH16-HY Condition : PEAK_74 3m 91200_1522 VERTICAL Detector : Peak Project : 901542-02</p>

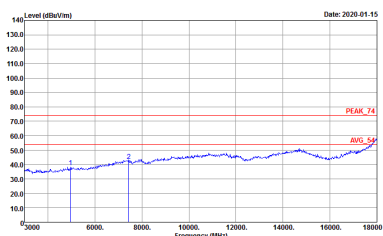
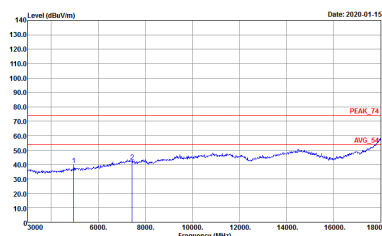

BT	2.4GHz 2400~2483.5MHz Harmonic @ 3m	
BT CH78 2480MHz		
Horizontal		Vertical
Peak Avg.	 <p data-bbox="430 712 670 761">Site : 03CH16-HY Condition : PEAK_74 3m 91200_1522 HORIZONTAL Detector : Peak Project : 901542-02</p>	 <p data-bbox="901 712 1141 761">Site : 03CH16-HY Condition : PEAK_74 3m 91200_1522 VERTICAL Detector : Peak Project : 901542-02</p>



<3Mbps>

2.4GHz 2400~2483.5MHz

BT (Band Edge @ 3m)

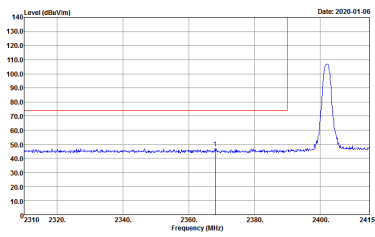
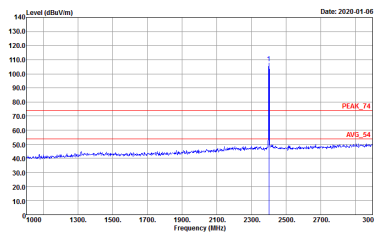
BT	2.4GHz 2400~2483.5MHz Band Edge @ 3m	
	BT CH00 2402MHz	
	Horizontal	Fundamental
Peak	 <p>Date: 2020-01-06</p> <p>Site : 03CH15-1FV Condition : PEAK_BE_74 3m 91200_1522 HORIZONTAL : RBW:1000.000KHz VBW:3000.000KHz SWT:Auto Detector : Peak Project : 901542-02</p>	 <p>Date: 2020-01-06</p> <p>Site : 03CH15-1FV Condition : PEAK_74 3m 91200_1522 HORIZONTAL : RBW:1000.000KHz VBW:3000.000KHz SWT:Auto Detector : Peak Project : 901542-02</p>

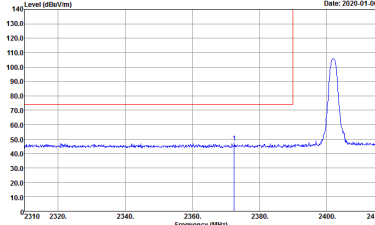
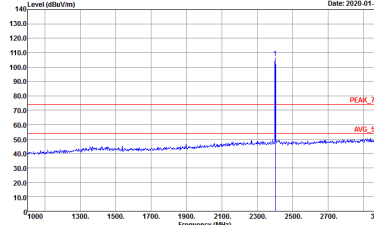

BT	2.4GHz 2400~2483.5MHz Band Edge @ 3m	
BT CH00 2402MHz		
	Vertical	Fundamental
Peak	 <p>Date: 2020-01-06</p> <p>Site : 03CH16-HY Condition : PEAK_8E_74 3m 91200_1522 VERTICAL RBW:1000.000KHz VBW:3000.000KHz SWT:Auto Detector : Peak Project : 901542-02</p>	 <p>Date: 2020-01-06</p> <p>Site : 03CH16-HY Condition : PEAK_74 3m 91200_1522 VERTICAL RBW:1000.000KHz VBW:3000.000KHz SWT:Auto Detector : Peak Project : 901542-02</p>

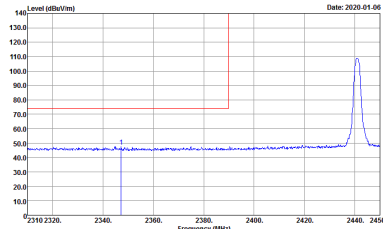
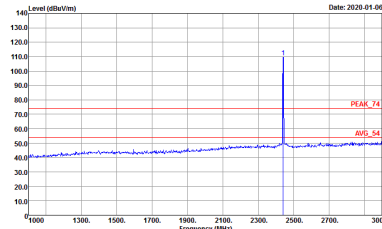
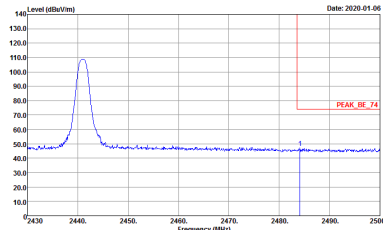

BT	2.4GHz 2400~2483.5MHz Band Edge @ 3m	
BT CH39 2441MHz		
	Horizontal	Fundamental
Peak	 <p>Site : 03CH16-HY Condition : PEAK_BE_74 3m 91200_1522 HORIZONTAL RBW:1000.000KHz VBW:3000.000KHz SWT:Auto Detector : Peak Project : 901542-02</p>	 <p>Site : 03CH16-HY Condition : PEAK_74 3m 91200_1522 HORIZONTAL RBW:1000.000KHz VBW:3000.000KHz SWT:Auto Detector : Peak Project : 901542-02</p>
Peak	 <p>Site : 03CH16-HY Condition : PEAK_BE_74 3m 91200_1522 HORIZONTAL RBW:1000.000KHz VBW:3000.000KHz SWT:Auto Detector : Peak Project : 901542-02</p>	Left blank



BT	2.4GHz 2400~2483.5MHz Band Edge @ 3m	
BT CH39 2441MHz		
	Vertical	Fundamental
Peak	<p> Site : 03CH16-HY Condition : PEAK_BE_74 3m 91200_1522 VERTICAL RBW:1000.000KHz VBW:3000.000KHz SWT:Auto Detector : Peak Project : 901542-02 </p>	<p> Site : 03CH16-HY Condition : PEAK_74 3m 91200_1522 VERTICAL RBW:1000.000KHz VBW:3000.000KHz SWT:Auto Detector : Peak Project : 901542-02 </p>
Peak	<p> Site : 03CH16-HY Condition : PEAK_BE_74 3m 91200_1522 VERTICAL RBW:1000.000KHz VBW:3000.000KHz SWT:Auto Detector : Peak Project : 901542-02 </p>	Left blank

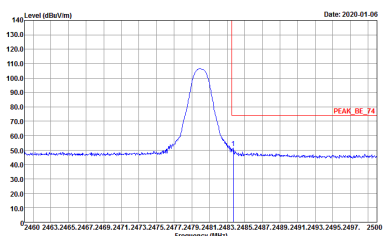
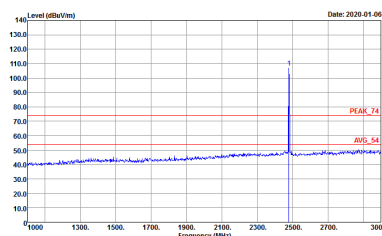

BT	2.4GHz 2400~2483.5MHz Band Edge @ 3m	
BT CH78 2480MHz		
Horizontal		Fundamental
Peak	 <p>Date: 2020-01-06</p> <p>Site : 03CH16-HY Condition : PEAK_BE_74 3m 91200_1522 HORIZONTAL RBW:1000.000KHz VBW:3000.000KHz SWT:Auto Detector : Peak Project : 901542-02</p>	 <p>Date: 2020-01-06</p> <p>Site : 03CH16-HY Condition : PEAK_74 3m 91200_1522 HORIZONTAL RBW:1000.000KHz VBW:3000.000KHz SWT:Auto Detector : Peak Project : 901542-02</p>

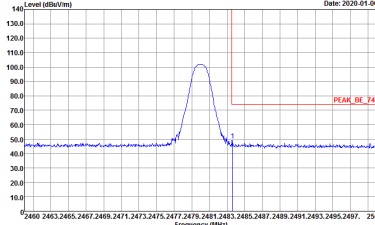
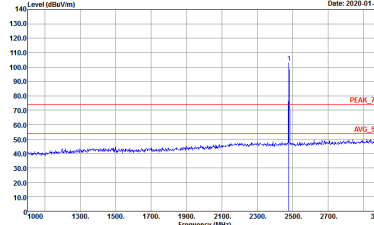

BT	2.4GHz 2400~2483.5MHz Band Edge @ 3m	
BT CH78 2480MHz		
	Vertical	Fundamental
Peak	 <p>Date: 2020-01-06</p> <p>Site : 03CH16-HY Condition : PEAK_BE_74 3m 91200_1522 VERTICAL RBW:1000.000KHz VBW:3000.000KHz SWT:Auto Detector : Peak Project : 901542-02</p>	 <p>Date: 2020-01-06</p> <p>Site : 03CH16-HY Condition : PEAK_74 3m 91200_1522 VERTICAL RBW:1000.000KHz VBW:3000.000KHz SWT:Auto Detector : Peak Project : 901542-02</p>



2.4GHz 2400~2483.5MHz

BT (Harmonic @ 3m)

BT	2.4GHz 2400~2483.5MHz Harmonic @ 3m	
	BT CH00 2402MHz	
	Horizontal	Vertical
Peak Avg.	<p>Site : 03CH16-1FY Condition : PEAK_74 3m 91200_1522 HORIZONTAL Detector : Peak Project : 901542-02</p>	<p>Site : 03CH16-1FY Condition : PEAK_74 3m 91200_1522 VERTICAL Detector : Peak Project : 901542-02</p>

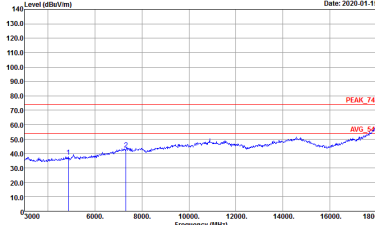
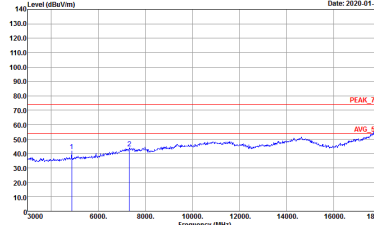

BT	2.4GHz 2400~2483.5MHz Harmonic @ 3m	
BT CH39 2441MHz		
Horizontal		Vertical
Peak Avg.	 <p data-bbox="432 712 670 763">Site : 03CH16-HY Condition : PEAK_74 3m 91200_1522 HORIZONTAL Detector : Peak Project : 901542-02</p>	 <p data-bbox="906 712 1144 763">Site : 03CH16-HY Condition : PEAK_74 3m 91200_1522 VERTICAL Detector : Peak Project : 901542-02</p>

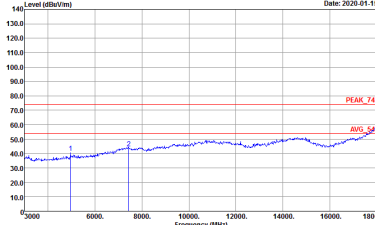
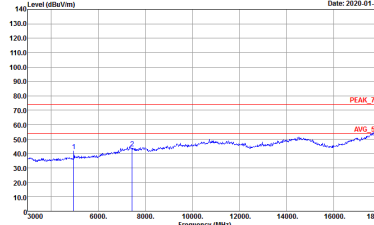

BT	2.4GHz 2400~2483.5MHz Harmonic @ 3m	
BT CH78 2480MHz		
Horizontal		Vertical
Peak Avg.	 <p data-bbox="430 712 670 761">Site : 03CH16-HY Condition : PEAK_74 3m 91200_1522 HORIZONTAL Detector : Peak Project : 901542-02</p>	 <p data-bbox="901 712 1141 761">Site : 03CH16-HY Condition : PEAK_74 3m 91200_1522 VERTICAL Detector : Peak Project : 901542-02</p>

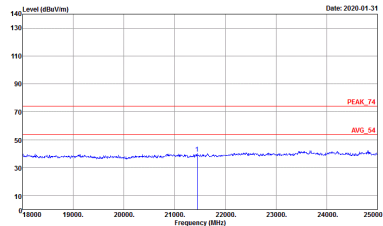
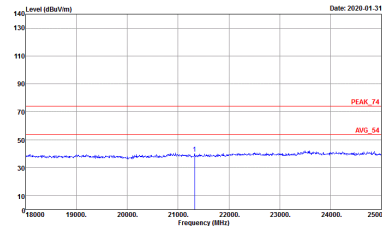

Emission above 18GHz
BT (Harmonic SHF)

BT	2.4GHz 2400~2483.5MHz Harmonic @ 3m	
BT SHF		
Horizontal		Vertical
<p>Peak Avg.</p>	 <p>Site : 03CH16-4Y Condition : PEAK_74 3m 91200_1522 HORIZONTAL Detector : Peak Project : 901542-02</p>	 <p>Site : 03CH16-4Y Condition : PEAK_74 3m 91200_1522 VERTICAL Detector : Peak Project : 901542-02</p>



Emission below 1GHz

2.4GHz BT (LF)

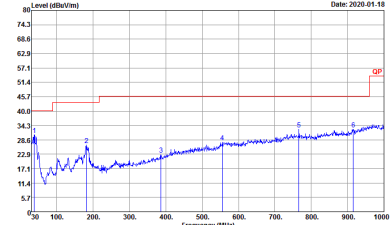
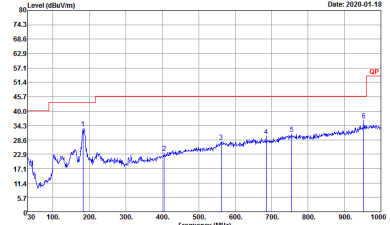
BT	2.4GHz 2400~2483.5MHz	
BT LF		
Horizontal		Vertical
QP / Peak	 <p data-bbox="422 817 670 884">Site : 03CH16-1FY Condition : QP 3m BTLOG_47020406 HORIZONTAL Detector : Peak Project : 901542-02</p>	 <p data-bbox="901 817 1149 884">Site : 03CH16-1FY Condition : QP 3m BTLOG_47020406 VERTICAL Detector : Peak Project : 901542-02</p>



<WPC Mode>

2.4GHz 2400~2483.5MHz

BT (Band Edge @ 3m)

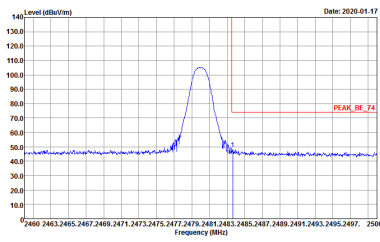
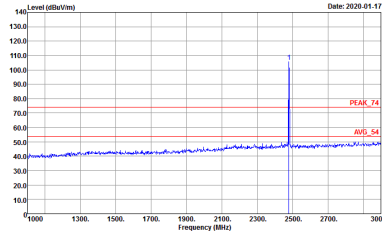
BT	2.4GHz 2400~2483.5MHz Band Edge @ 3m	
BT CH78 2480MHz		
	Horizontal	Fundamental
Peak	 <p>Site : 03CH16-1FY Condition : PEAK_BE_74 3m 91200_1522 HORIZONTAL RBW:1000.000KHz VBW:3000.000KHz SWT:Auto Detector : Peak Project : 901542-02</p>	 <p>Site : 03CH16-1FY Condition : PEAK_74 3m 91200_1522 HORIZONTAL RBW:1000.000KHz VBW:3000.000KHz SWT:Auto Detector : Peak Project : 901542-02</p>

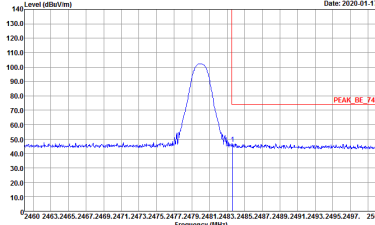
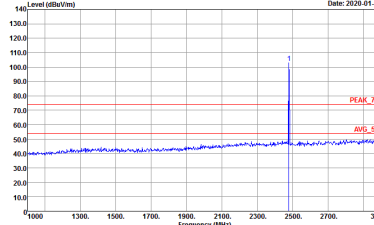

BT	2.4GHz 2400~2483.5MHz Band Edge @ 3m	
BT CH78 2480MHz		
	Vertical	Fundamental
Peak	 <p data-bbox="430 712 805 772">Date: 2020-01-17 Site : 03CH16-HY Condition : PEAK_BE_74 3m 91200_1522 VERTICAL RBW:1000.000KHz VBW:3000.000KHz SWT:Auto Detector : Peak Project : 901542-02</p>	 <p data-bbox="901 712 1276 772">Date: 2020-01-17 Site : 03CH16-HY Condition : PEAK_74 3m 91200_1522 VERTICAL RBW:1000.000KHz VBW:3000.000KHz SWT:Auto Detector : Peak Project : 901542-02</p>



2.4GHz 2400~2483.5MHz

BT (Harmonic @ 3m)

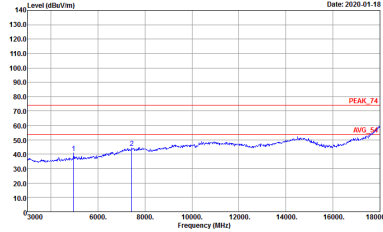
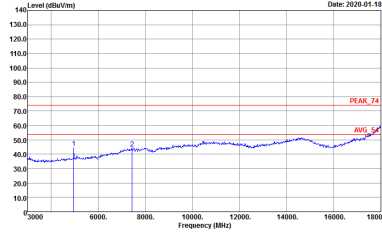
BT	2.4GHz 2400~2483.5MHz Harmonic @ 3m	
BT CH78 2480MHz		
Horizontal		Vertical
Peak Avg.	 <p>Site : 03CH16-1FY Condition : PEAK_74 3m 91200_1522 HORIZONTAL Detector : Peak Project : 901542-02</p>	 <p>Site : 03CH16-1FY Condition : PEAK_74 3m 91200_1522 VERTICAL Detector : Peak Project : 901542-02</p>

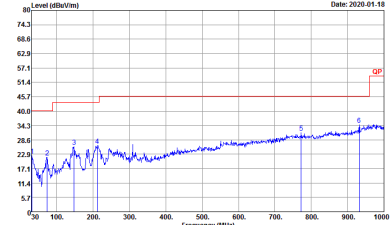
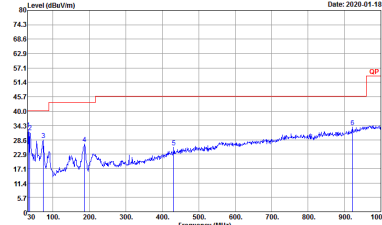

Emission below 1GHz
2.4GHz BT (LF)

BT	2.4GHz 2400~2483.5MHz	
	BT LF	
	Horizontal	Vertical
QP / Peak	 <p>Site : 03CH16-1FY Condition : QP 3m BTLOG_47020406 HORIZONTAL Detector : Peak Project : 901542-02</p>	 <p>Site : 03CH16-1FY Condition : QP 3m BTLOG_47020406 VERTICAL Detector : Peak Project : 901542-02</p>



Appendix E. Duty Cycle Plots

<1Mbps>

DH5 on time (One Pulse) Plot on Channel 39



on time (Count Pulses) Plot on Channel 39

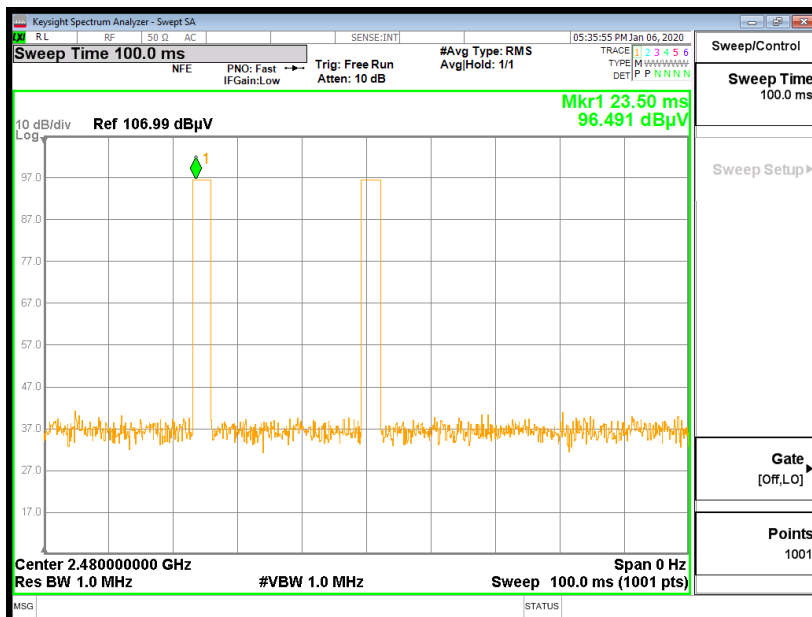

Note:

1. Worst case Duty cycle = on time/100 milliseconds = 2 * 2.88 / 100 = 5.76 %
2. Worst case Duty cycle correction factor = 20*log(Duty cycle) = -24.79 dB
3. DH5 has the highest duty cycle worst case and is reported.



<2Mbps>

2DH5 on time (One Pulse) Plot on Channel 39

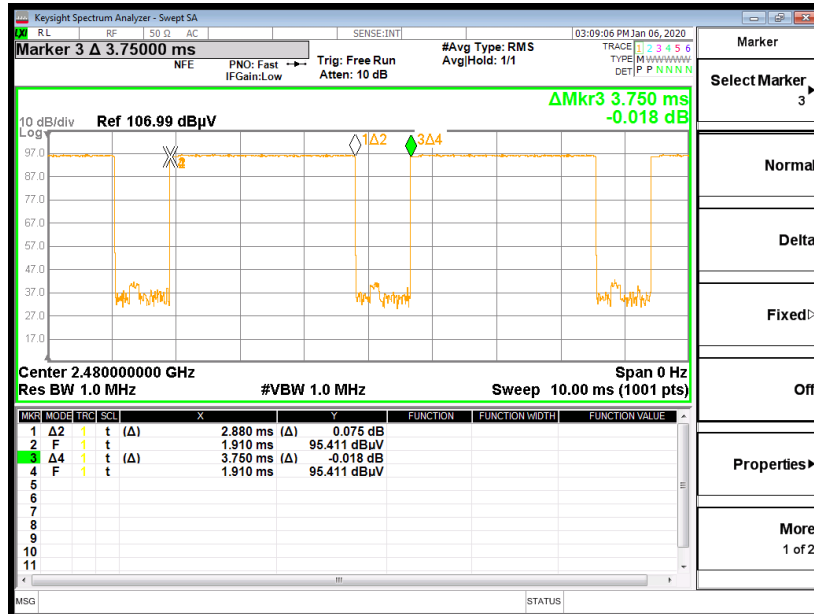

on time (Count Pulses) Plot on Channel 39

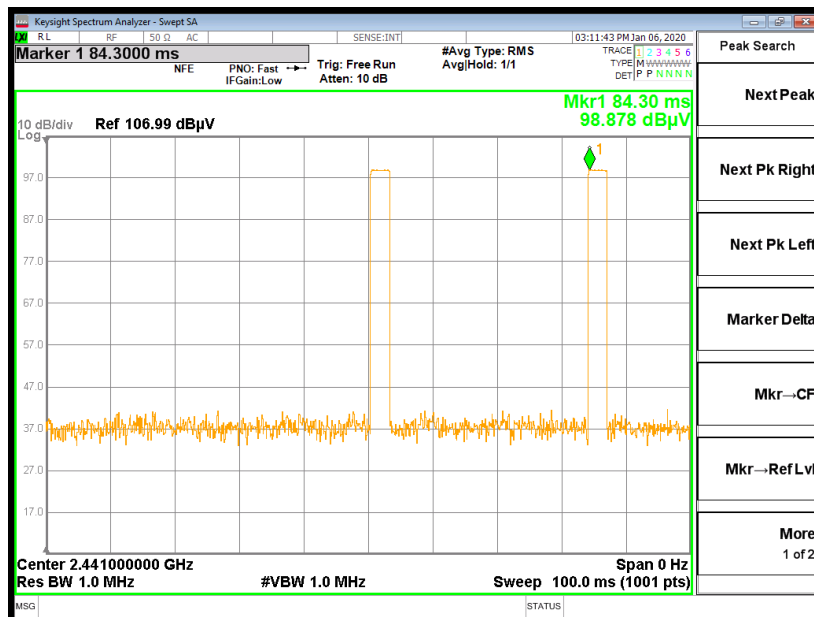

Note:

1. Worst case Duty cycle = on time/100 milliseconds = $2 * 2.88 / 100 = 5.76\%$
2. Worst case Duty cycle correction factor = $20 * \log(\text{Duty cycle}) = -24.79 \text{ dB}$
3. 2DH5 has the highest duty cycle worst case and is reported.



<3Mbps>

3DH5 on time (One Pulse) Plot on Channel 39

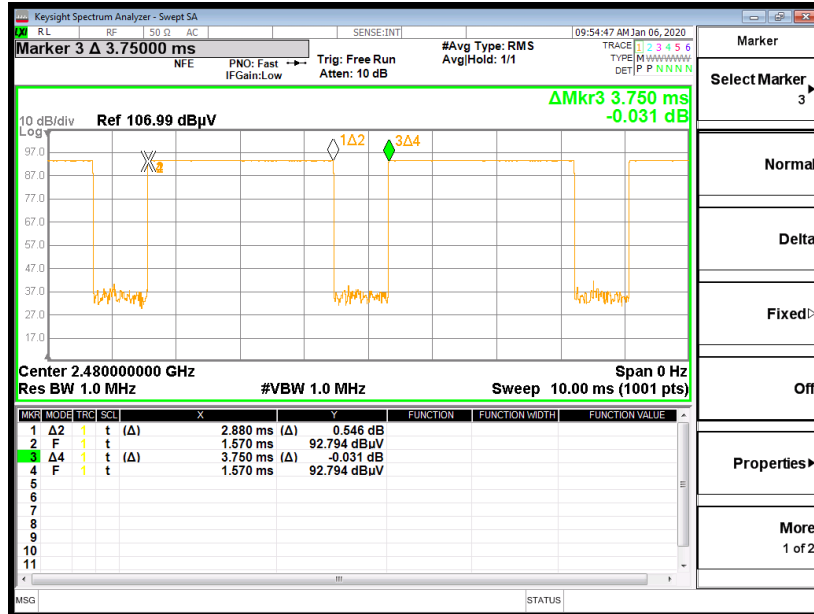

on time (Count Pulses) Plot on Channel 39

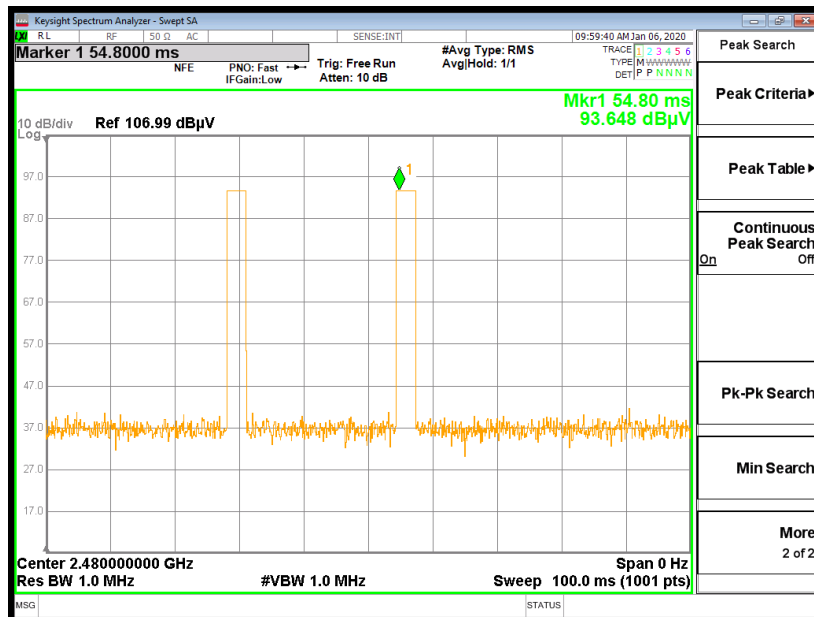

Note:

1. Worst case Duty cycle = on time/100 milliseconds = 2 * 2.88 / 100 = 5.76%
2. Worst case Duty cycle correction factor = 20*log(Duty cycle) = -24.79 dB
3. 3DH5 has the highest duty cycle worst case and is reported.



Duty Cycle Correction Factor Consideration for AFH mode:

Bluetooth normal hopping rate is 1600Hz and reduced to 800Hz in AFH mode; due to the reduced number of hopping frequencies, with the same packet configuration the dwell time in each channel frequency within 100msec period is longer in AFH mode than normal mode.

In AFH mode, the minimum hopping frequencies are 20, to get the longest dwell time DH5 packet is observed; the period to have DH5 packet completing one hopping sequence is

$$2.88 \text{ ms} \times 20 \text{ channels} = 57.6 \text{ ms}$$

There cannot be 2 complete hopping sequences within 100ms period, considering the random hopping behavior, maximum 2 hops can be possibly observed within the period. $[100\text{ms} / 57.6\text{ms}] = 2$ hops

Thus, the maximum possible ON time:

$$2.88 \text{ ms} \times 2 = 5.76 \text{ ms}$$

Worst case Duty Cycle Correction factor, which is derived from the maximum possible ON time,

$$20 \times \log(5.76 \text{ ms}/100\text{ms}) = -24.79 \text{ dB}$$

—————THE END—————