



FCC CO-LOCATION RADIO TEST REPORT

FCC ID : PY7-60551T
Equipment : GSM/WCDMA/LTE/5G Phone with BT, DTS/UNII
a/b/g/n/ac/ax, GPS and NFC
Brand Name : Sony
Applicant : Sony Corporation
1-7-1 Konan Minato-ku Tokyo, 108-0075 Japan
Manufacturer : Sony Corporation
1-7-1 Konan Minato-ku Tokyo, 108-0075 Japan
Standard : FCC Part 15 Subpart E §15.407

The product was received on Apr. 09, 2021 and testing was started from Apr. 30, 2021 and completed on May 18, 2021. We, Sporton International Inc. Wensan Laboratory, would like to declare that the tested sample has been evaluated in accordance with the test procedures and has been in compliance with the applicable technical standards.

The test results in this report apply exclusively to the tested model / sample. Without written approval of Sporton International Inc. Wensan Laboratory, the test report shall not be reproduced except in full.

Louis Wu

Approved by: Louis Wu

Sporton International Inc. Wensan Laboratory

No.58, Aly. 75, Ln. 564, Wenhua 3rd, Rd., Guishan Dist., Taoyuan City 333010, Taiwan (R.O.C.)



Table of Contents

History of this test report..... 3

Summary of Test Result..... 4

1 General Description 5

 1.1 Product Feature of Equipment Under Test..... 5

 1.2 Modification of EUT 5

 1.3 Testing Location 6

 1.4 Applicable Standards..... 6

2 Test Configuration of Equipment Under Test 7

 2.1 Carrier Frequency and Channel 7

 2.2 Connection Diagram of Test System..... 8

 2.3 Support Unit used in test configuration and system 8

 2.4 EUT Operation Test Setup 8

3 Test Result 9

 3.1 Unwanted Emissions Measurement..... 9

 3.2 Antenna Requirements..... 14

4 List of Measuring Equipment..... 15

5 Uncertainty of Evaluation 17

Appendix A. Radiated Spurious Emission

Appendix B. Radiated Spurious Emission Plots

Appendix C. Duty Cycle Plots



History of this test report

Report No.	Version	Description	Issued Date
FR133117	01	Initial issue of report	May 18, 2021



Summary of Test Result

Report Clause	Ref Std. Clause	Test Items	Result (PASS/FAIL)	Remark
3.1	15.407(b)	Unwanted Emissions	Pass	Under limit 3.77 dB at 17988.900 MHz
3.2	15.203 15.407(a)	Antenna Requirement	Pass	-

Declaration of Conformity:
The test results with all measurement uncertainty excluded are presented in accordance with the regulation limits or requirements declared by manufacturers.

Comments and Explanations:
The declared of product specification for EUT presented in the report are provided by the manufacturer, and the manufacturer takes all the responsibilities for the accuracy of product specification.

Reviewed by: Wii Chang
Report Producer: Lucy Wu



1 General Description

1.1 Product Feature of Equipment Under Test

GSM/WCDMA/LTE/5G NR, Bluetooth, DTS/UNII a/b/g/n/ac/ax, NFC, and GNSS.

Product Specification subjective to this standard	
Antenna Type	Bluetooth: <Ant. 0>: Loop Antenna WLAN (2.4GHz) <Chain 0>: Loop Antenna <Chain 1>: Loop Antenna WLAN (5GHz) <Chain 0>: Loop Antenna <Chain 1>: Monopole Antenna

Remark: The above EUT's information was declared by manufacturer. Please refer to Comments and Explanations in report summary.

EUT Information List			
HW Version	SW Version	S/N	Performed Test Item
A	0.747	QV7200A07E	Radiated Spurious Emission

Accessory List	
AC Adapter	Model Name : XQZ-UC1
	S/N: 0020W51300039
Earphone	Model Name : MH750
	S/N : N/A
USB Cable	Model Name : XQZ-UB1
	S/N : N/A

Note:

1. Above EUT list used are electrically identical per declared by manufacturer.
2. Above the accessories list are used to exercise the EUT during test, and the serial number of each type of accessories is listed in each section of this report.
3. For other wireless features of this EUT, test report will be issued separately.

1.2 Modification of EUT

No modifications are made to the EUT during all test items.



1.3 Testing Location

Test Site	Sporton International Inc. Wensan Laboratory
Test Site Location	No.58, Aly. 75, Ln. 564, Wenhua 3rd, Rd., Guishan Dist., Taoyuan City 333010, Taiwan (R.O.C.) TEL: +886-3-327-0868 FAX: +886-3-327-0855
Test Site No.	Sporton Site No. 03CH15-HY

Note: The test site complies with ANSI C63.4 2014 requirement.

FCC Designation No.: TW3786

1.4 Applicable Standards

According to the specifications of the manufacturer, the EUT must comply with the requirements of the following standards:

- ♦ FCC Part 15 Subpart C §15.247
- ♦ FCC Part 15 Subpart E
- ♦ FCC KDB 789033 D02 General UNII Test Procedures New Rules v02r01.
- ♦ FCC KDB 414788 D01 Radiated Test Site v01r01.
- ♦ FCC KDB 662911 D01 Multiple Transmitter Output v02r01.
- ♦ FCC KDB 971168 D01 Power Meas. License Digital Systems v03r01
- ♦ ANSI C63.10-2013

Remark:

1. All test items were verified and recorded according to the standards and without any deviation during the test.
2. The TAF code is not including all the FCC KDB listed without accreditation.
3. This EUT has also been tested and complied with the requirements of FCC Part 15, Subpart B, recorded in a separate test report.



2 Test Configuration of Equipment Under Test

- a. The EUT has been associated with peripherals and configuration operated in a manner tended to maximize its emission characteristics in a typical application. Frequency range investigated: radiation emission (9 kHz to the 10th harmonic of the highest fundamental frequency or to 40 GHz, whichever is lower). For radiated measurement, pre-scanned in three orthogonal panels, X, Y, Z. The worst cases were recorded in this report.

2.1 Carrier Frequency and Channel

<Ant. 0>

2400-2483.5 MHz	
Bluetooth	
Channel	Freq. (MHz)
39	2441

MIMO <Chain 0+1>

2400-2483.5 MHz		5150-5350 MHz	
802.11b		802.11a	
Channel	Freq. (MHz)	Channel	Freq. (MHz)
01	2412	36	5180

Remark: During the Radiated Spurious Emission test, the EUT turn on the WWAN functions simultaneously.

<Co-Location>

Modulation	Plane	Data Rate
2.4GHz 802.11b for MIMO Chain 0+1 + LTE Band 41	Y	1 Mbps + QPSK
5GHz 802.11a for MIMO Chain 0+1 + Bluetooth for Ant. 0 + LTE Band 41	X	MCS0 + GFSK + QPSK
2.4GHz 802.11b for MIMO Chain 0+1 + 5GHz 802.11a for MIMO Chain 0+1 + LTE Band 41	X	1 Mbps + MCS0 + QPSK

2.2 Connection Diagram of Test System

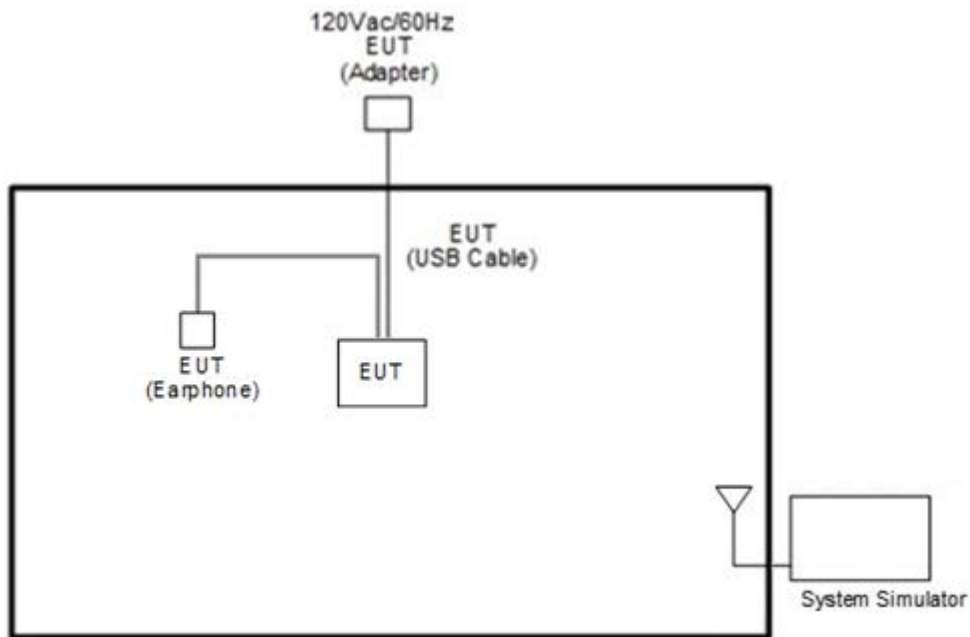

2.3 Support Unit used in test configuration and system

Item	Equipment	Brand Name	Model Name	FCC ID	Data Cable	Power Cord
1.	System Simulator	Anritsu	MT8820C	N/A	N/A	Unshielded,1.8m

2.4 EUT Operation Test Setup

The RF test items, utility "FTMC_V0.39" was installed in Notebook which was programmed in order to make the EUT get into the engineering modes to provide channel selection, power level, data rate and the application type and for continuous transmitting signals.



3 Test Result

3.1 Unwanted Emissions Measurement

This section is to measure unwanted emissions through radiated measurement for band edge spurious emissions and out of band emissions measurement.

3.1.1 Limit of Unwanted Emissions

(1) Unwanted spurious emissions fallen in restricted bands shall comply with the general field strength limits as below table:

Frequency (MHz)	Field Strength (microvolts/meter)	Measurement Distance (meters)
0.009 – 0.490	2400/F(kHz)	300
0.490 – 1.705	24000/F(kHz)	30
1.705 – 30.0	30	30
30 – 88	100	3
88 – 216	150	3
216 - 960	200	3
Above 960	500	3

Note: The following formula is used to convert the EIRP to field strength.

$$E = \frac{1000000\sqrt{30P}}{3} \text{ } \mu\text{V/m, where P is the eirp (Watts)}$$

EIRP (dBm)	Field Strength at 3m (dBμV/m)
- 27	68.3

(2) KDB789033 D02 v02r01 G)2)c)

(i) Sections 15.407(b)(1-3) specifies the unwanted emissions limit for the U-NII-1 and U-NII-2 bands. As specified, emissions above 1000 MHz that are outside of the restricted bands are subject to a peak emission limit of -27 dBm/MHz.

(ii) Section 15.407(b)(4) specifies the unwanted emissions limit for the U-NII-3 band. A band emissions mask is specified in Section 15.407(b)(4)(i). The emission limits are based on the use of a peak detector.

3.1.2 Measuring Instruments

See list of measuring equipment of this test report.



3.1.3 Test Procedures

1. The testing follows FCC KDB 789033 D02 General UNII Test Procedures New Rules v02r01. Section G) Unwanted emissions measurement.
 - (1) Procedure for Unwanted Emissions Measurements Below 1000 MHz
 - RBW = 120 kHz
 - VBW = 300 kHz
 - Detector = Peak
 - Trace mode = max hold
 - (2) Procedure for Peak Unwanted Emissions Measurements Above 1000 MHz
 - RBW = 1 MHz
 - VBW \geq 3 MHz
 - Detector = Peak
 - Sweep time = auto
 - Trace mode = max hold
 - (3) Procedures for Average Unwanted Emissions Measurements Above 1000 MHz
 - RBW = 1 MHz
 - VBW = 10 Hz, when duty cycle is no less than 98 percent.
 - VBW \geq 1/T, when duty cycle is less than 98 percent where T is the minimum transmission duration over which the transmitter is on and is transmitting at its maximum power control level for the tested mode of operation.
2. The EUT was placed on a turntable with 0.8 meter for frequency below 1 GHz and 1.5 meter for frequency above 1 GHz respectively above ground.
3. The EUT was set 3 meters from the interference receiving antenna which was mounted on the top of a variable height antenna tower.
4. The antenna is a broadband antenna and its height is adjusted between one meter and four meters above ground to find the maximum value of the field strength for both horizontal polarization and vertical polarization of the antenna.
5. For each suspected emission, the EUT was arranged to its worst case and then adjust the antenna tower (from 1 m to 4 m) and turntable (from 0 degree to 360 degrees) to find the maximum reading.
6. For testing below 1 GHz, if the emission level of the EUT in peak mode was 3 dB lower than the limit specified, then peak values of EUT will be reported, otherwise, the emissions will be repeated one by one using the CISPR quasi-peak method and reported.
7. For testing above 1 GHz, the emission level of the EUT in peak mode was 20 dB lower than average limit (that means the emission level in average mode also complies with the limit in average mode), then peak values of EUT will be reported, otherwise, the emissions will be measured in average mode again and reported.

3.1.4 Test Setup

For radiated emissions below 30MHz

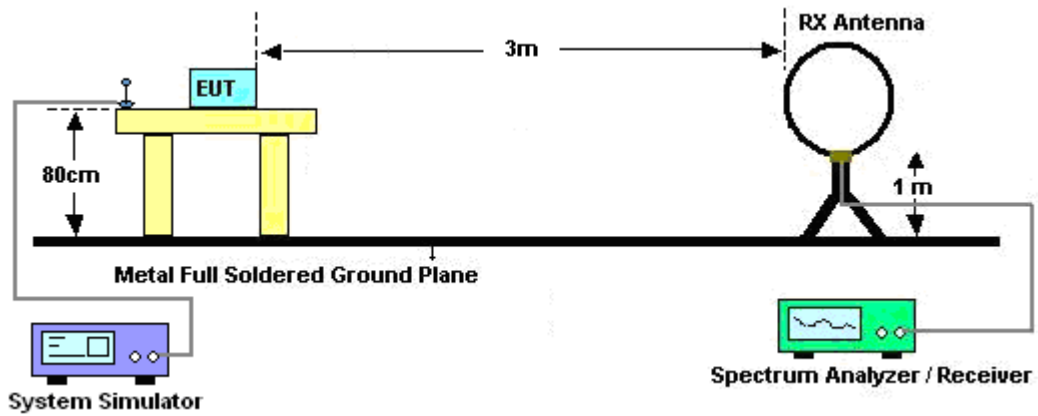

For radiated emissions from 30MHz to 1GHz

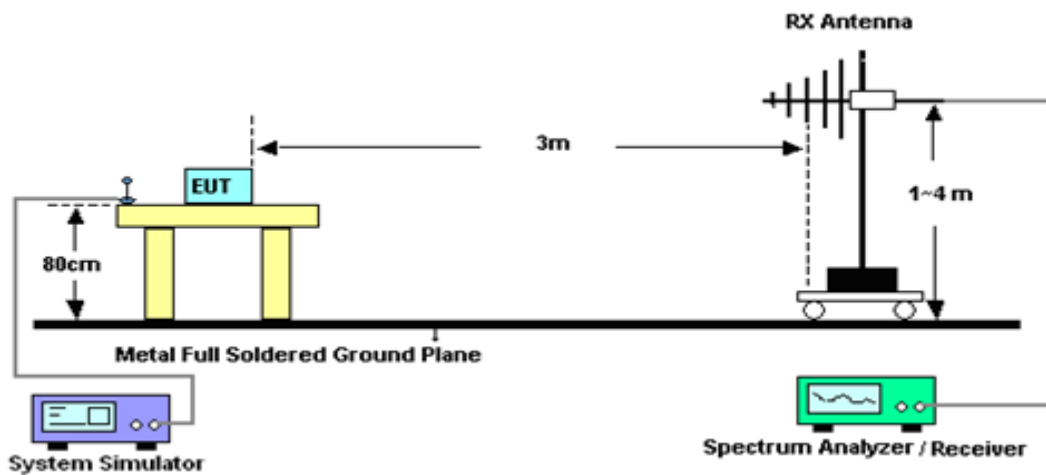

For radiated emissions from 1GHz to 18GHz

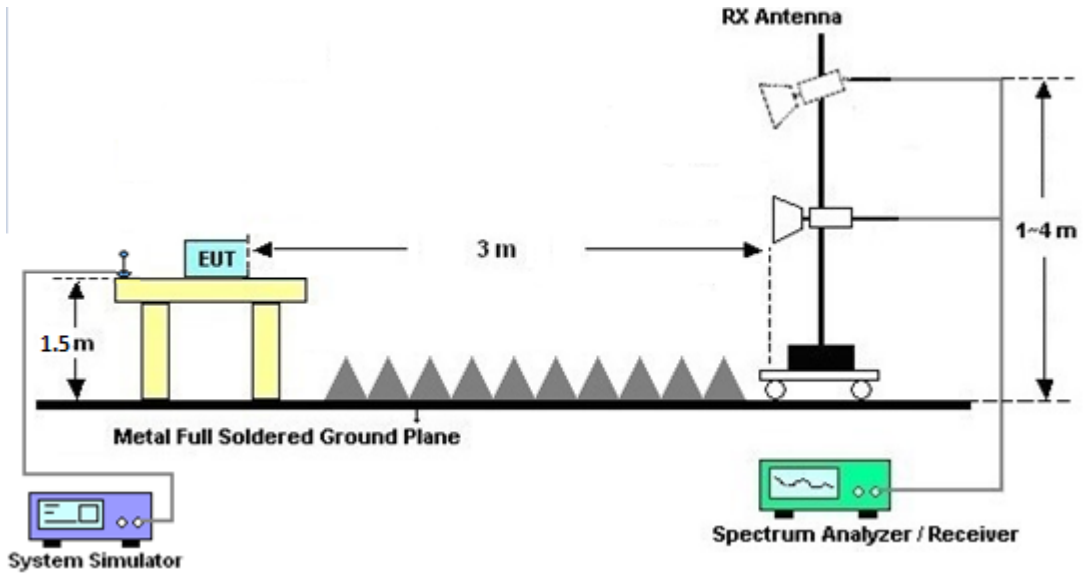

For radiated emissions above 18GHz

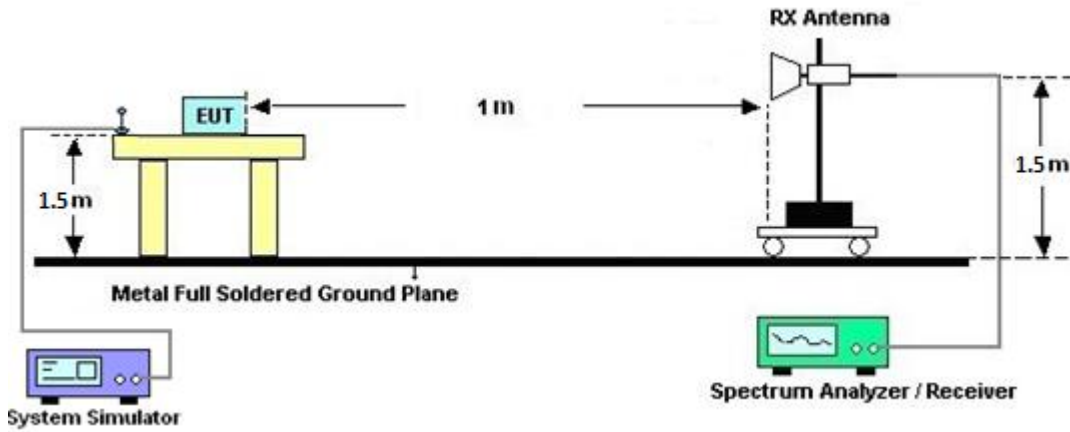



3.1.5 Test Results of Radiated Spurious Emissions (9 kHz ~ 30 MHz)

The low frequency, which started from 9 kHz to 30MHz, was pre-scanned and the result which was 20dB lower than the limit line was not reported.

There is a comparison data of both open-field test site and alternative test site - semi-Anechoic chamber according to 414788 D01 Radiated Test Site v01r01, and the result came out very similar.

3.1.6 Test Result of Radiated Spurious at Band Edges

Please refer to Appendix A and B.

3.1.7 Duty Cycle

Please refer to Appendix C.

3.1.8 Test Result of Radiated Spurious Emissions

Please refer to Appendix A and B.



3.2 Antenna Requirements

3.2.1 Standard Applicable

If transmitting antenna directional gain is greater than 6 dBi, both the peak transmit power and the peak power spectral density shall be reduced by the amount in dB that the directional gain of the antenna exceeds 6 dBi.

3.2.2 Antenna Anti-Replacement Construction

An embedded-in antenna design is used.

3.2.3 Antenna Gain

The antenna peak gain of EUT is less than 6 dBi. Therefore, it is not necessary to reduce maximum peak output power limit.



4 List of Measuring Equipment

Instrument	Brand Name	Model No.	Serial No.	Characteristics	Calibration Date	Test Date	Due Date	Remark
Loop Antenna	Rohde & Schwarz	HFH2-Z2	100488	9 kHz~30 MHz	Jul. 14, 2020	Apr. 30, 2021~ May 18, 2021	Jul. 13, 2021	Radiation (03CH15-HY)
Bilog Antenna	TESEQ	CBL 6111D & 00800N1D01N- 06	41912 & 05	30MHz~1GHz	Feb. 08, 2021	Apr. 30, 2021~ May 18, 2021	Feb. 07, 2022	Radiation (03CH15-HY)
Amplifier	SONOMA	310N	363440	9kHz~1GHz	Dec. 28, 2020	Apr. 30, 2021~ May 18, 2021	Dec. 27, 2021	Radiation (03CH15-HY)
Horn Antenna	SCHWARZB ECK	BBHA 9120 D	9120D-01620	1GHz~18GHz	Nov. 03, 2020	Apr. 30, 2021~ May 18, 2021	Nov. 02, 2021	Radiation (03CH15-HY)
SHF-EHF Horn Antenna	SCHWARZB ECK	BBHA 9170	BBHA917025 1	18GHz~40GHz	Dec. 02, 2020	Apr. 30, 2021~ May 18, 2021	Dec. 01, 2021	Radiation (03CH15-HY)
Preamplifier	Jet-Power	JPA0118-55-30 3	1710001800 055006	1GHz~18GHz	May 07, 2020	Apr. 30, 2021~ May 05, 2021	May 06, 2021	Radiation (03CH15-HY)
Preamplifier	Jet-Power	JPA0118-55-30 3	1710001800 055006	1GHz~18GHz	May 06, 2021	May 06, 2021~ May 18, 2021	May 05, 2022	Radiation (03CH15-HY)
Amplifier	EMCI	EMC118A45SE	980791	1GHz-18GHz	Nov. 16, 2020	May 05, 2021~ May 06, 2021	Nov. 15, 2021	Radiation (03CH15-HY)
Preamplifier	Keysight	83017A	MY53270195	1GHz~26.5GHz	Aug. 21, 2020	Apr. 30, 2021~ May 18, 2021	Aug. 20, 2021	Radiation (03CH15-HY)
Preamplifier	EMEC	EM18G40G	0600789	18-40GHz	Oct. 27, 2020	Apr. 30, 2021~ May 18, 2021	Oct. 26, 2021	Radiation (03CH15-HY)
EMI Test Receiver	Keysight	N9038A(MXE)	MY54130085	20MHz~8.4GHz	Nov. 02, 2020	Apr. 30, 2021~ May 18, 2021	Nov. 01, 2021	Radiation (03CH15-HY)
Spectrum Analyzer	Agilent	N9010A	MY53470118	10Hz~44GHz	Jan. 15, 2021	Apr. 30, 2021~ May 18, 2021	Jan. 14, 2022	Radiation (03CH15-HY)
Spectrum Analyzer	Agilent	E4446A	MY50180136	3Hz~44GHz	May 04, 2020	Apr. 30, 2021~ May 02, 2021	May 03, 2021	Radiation (03CH15-HY)
Spectrum Analyzer	Keysight	N9010A	MY54200485	10Hz~44GHz	Mar. 05, 2021	May 02, 2021~ May 18, 2021	Mar. 04, 2022	Radiation (03CH15-HY)
Antenna Mast	ChainTek	MBS-520-1	N/A	1m~4m	N/A	Apr. 30, 2021~ May 18, 2021	N/A	Radiation (03CH15-HY)
Turn Table	ChainTek	T-200-S-1	N/A	0~360 Degree	N/A	Apr. 30, 2021~ May 18, 2021	N/A	Radiation (03CH15-HY)
Software	Audix	E3 6.2009-8-24(k5)	RK-000451	N/A	N/A	Apr. 30, 2021~ May 18, 2021	N/A	Radiation (03CH15-HY)
RF Cable	HUBER + SUHNER	SUCOFLEX 104, 102E	MY36980/4, MY9838/4PE ,508405/2E	30MHz~18G	Nov. 16, 2020	Apr. 30, 2021~ May 18, 2021	Nov. 15, 2021	Radiation (03CH15-HY)
RF Cable	HUBER + SUHNER	SUCOFLEX 102	505134/2	30MHz-40GHz	Feb. 22, 2021	Apr. 30, 2021~ May 18, 2021	Feb. 21, 2022	Radiation (03CH15-HY)
RF Cable	HUBER + SUHNER	SUCOFLEX 102	800740/2	30MHz-40GHz	Feb. 22, 2021	Apr. 30, 2021~ May 18, 2021	Feb. 21, 2022	Radiation (03CH15-HY)
RF Cable	HUBER + SUHNER	SUCOFLEX 104	MY9837/4PE	9kHz~30MHz	Mar. 11, 2021	Apr. 30, 2021~ May 18, 2021	Mar. 10, 2022	Radiation (03CH15-HY)



Instrument	Brand Name	Model No.	Serial No.	Characteristics	Calibration Date	Test Date	Due Date	Remark
Filter	Wainwright	WLJ4-1000-1530-6000-40ST	SN4	1.53GHz Low Pass Filter	Jul. 03, 2020	Apr. 30, 2021~ May 18 , 2021	Jul. 02, 2021	Radiation (03CH15-HY)
Filter	Wainwright	WHKX12-2700-3000-18000-60ST	SN4	3GHz High Pass Filter	Sep. 16, 2020	Apr. 30, 2021~ May 18 , 2021	Sep. 15, 2021	Radiation (03CH15-HY)
Filter	Wainwright	WHKX12-1080-1200-15000-60ST	SN5	1.2GHz High Pass Filter	Jul. 01, 2020	Apr. 30, 2021~ May 18 , 2021	Jun. 30, 2021	Radiation (03CH15-HY)
Filter	Wainwright	WHKX8-5872.5-6750-18000-40ST	SN6	6.75GHz High Pass Filter	Jul. 01, 2020	Apr. 30, 2021~ May 18 , 2021	Jun. 30, 2021	Radiation (03CH15-HY)



5 Uncertainty of Evaluation

Uncertainty of Radiated Emission Measurement (30 MHz ~ 1000 MHz)

Measuring Uncertainty for a Level of Confidence of 95% ($U = 2Uc(y)$)	4.7
---	-----

Uncertainty of Radiated Emission Measurement (1000 MHz ~ 18000 MHz)

Measuring Uncertainty for a Level of Confidence of 95% ($U = 2Uc(y)$)	5.3
---	-----

Uncertainty of Radiated Emission Measurement (18000 MHz ~ 40000 MHz)

Measuring Uncertainty for a Level of Confidence of 95% ($U = 2Uc(y)$)	4.9
---	-----



Appendix A. Radiated Spurious Emission

Test Engineer :	Leo Lee, Mancy Chou and Bigshow Wang	Temperature :	21.2~25.6°C
		Relative Humidity :	44~68%

WLAN 802.11b_Tx_Ch01 + WWAN LTE Band 41 CH39750 Link

2.4GHz 2400~2483.5MHz

WIFI 802.11b (Band Edge @ 3m)

WIFI Chain. 0+1	Note	Frequency (MHz)	Level (dBμV/m)	Over Limit (dB)	Limit Line (dBμV/m)	Read Level (dBμV)	Antenna Factor (dB/m)	Path Loss (dB)	Preamp Factor (dB)	Chain Pos (cm)	Table Pos (deg)	Peak Avg. (P/A)	Pol. (H/V)	
802.11b CH 01 2412MHz		2372.37	53.8	-20.2	74	40.58	27.61	16.53	30.92	400	349	P	H	
		2310.735	42.71	-11.29	54	29.45	27.78	16.43	30.95	400	349	A	H	
	*	2412	100.57	-	-	87.38	27.5	16.6	30.91	400	349	P	H	
	*	2412	97.32	-	-	84.13	27.5	16.6	30.91	400	349	A	H	
													H	
													H	
			2340.135	54.73	-19.27	74	41.47	27.72	16.48	30.94	359	8	P	V
			2344.335	42.68	-11.32	54	29.42	27.71	16.49	30.94	359	8	A	V
	*		2412	103.26	-	-	90.07	27.5	16.6	30.91	359	8	P	V
	*		2412	100.16	-	-	86.97	27.5	16.6	30.91	359	8	A	V
														V
														V



WLAN 802.11b_Tx_Ch01 + WWAN LTE Band 41 CH39750 Link

WIFI 802.11b (Harmonic @ 3m)

WIFI Chain 0+1	Note	Frequency (MHz)	Level (dBμV/m)	Over Limit (dB)	Limit Line (dBμV/m)	Read Level (dBμV)	Antenna Factor (dB/m)	Path Loss (dB)	Preamp Factor (dB)	Chain Pos (cm)	Table Pos (deg)	Peak Avg. (P/A)	Pol. (H/V)	
802.11b CH 01 2412MHz		4804	39.92	-34.08	74	57.62	31.1	10.05	58.85	100	0	P	H	
		18000	59.94	-14.06	74	49.29	49	18.89	57.24	100	33	P	H	
		18000	49.98	-4.02	54	39.33	49	18.89	57.24	100	33	A	H	
													H	
													H	
													H	
			4800	39.14	-34.86	74	56.83	31.1	10.05	58.84	100	0	P	V
			17985	59.59	-14.41	74	49.25	48.73	18.88	57.27	100	21	P	V
			17985	49.7	-4.3	54	39.36	48.73	18.88	57.27	100	21	A	V
														V



WLAN 802.11b_Tx_Ch01 + WWAN LTE Band 41 CH39750 Link

Emission above 18GHz (SHF@ 3m)

WLAN	Note	Frequency	Level	Over	Limit	Read	Antenna	Path	Preamp	Chain	Table	Peak	Pol.	
				Limit	Line	Level	Factor	Loss	Factor	Pos	Pos	Avg.		
0+1		(MHz)	(dBμV/m)	(dB)	(dBμV/m)	(dBμV)	(dB/m)	(dB)	(dB)	(cm)	(deg)	(P/A)	(H/V)	
802.11b CH 01 2412MHz		21576	39.83	-34.17	74	44.45	38.32	11.76	54.7	150	0	P	H	
													H	
													H	
													H	
													H	
													H	
			20824	39	-35	74	44.1	38.45	11.22	54.77	150	0	P	V
														V
														V
														V



WLAN 802.11b_Tx_Ch01 + WWAN LTE Band 41 CH39750 Link

Emission below 1GHz (LF@ 3m)

WLAN	Note	Frequency	Level	Over Limit	Limit Line	Read Level	Chainenn a Factor	Path Loss	Preamp Factor	Chain Pos	Table Pos	Peak Avg.	Pol.
0+1		(MHz)	(dBµV/m)	(dB)	(dBµV/m)	(dBµV)	(dB/m)	(dB)	(dB)	(cm)	(deg)	(P/A)	(H/V)
11b_Ch01		46.49	25.32	-14.68	40	41.06	15.99	0.86	32.59	100	0	P	H
		181.32	28.38	-15.12	43.5	44	14.9	1.96	32.48	-	-	P	H
		336.52	23.73	-22.27	46	33.73	20.01	2.52	32.53	-	-	P	H
		430.61	25.09	-20.91	46	31.79	22.91	2.8	32.41	-	-	P	H
		581.93	26.43	-19.57	46	29.94	25.68	3.33	32.52	-	-	P	H
		845.77	30.95	-15.05	46	29.95	28.87	4.03	31.9	-	-	P	H
		45.52	33.85	-6.15	40	48.99	16.6	0.85	32.59	100	0	P	V
		151.25	22.82	-20.68	43.5	36.58	16.98	1.76	32.5	-	-	P	V
		264.74	20.37	-25.63	46	30.51	19.97	2.32	32.43	-	-	P	V
		562.53	26.45	-19.55	46	29.67	26.11	3.26	32.59	-	-	P	V
		685.72	27.98	-18.02	46	30.48	26.36	3.56	32.42	-	-	P	V
		763.32	30.45	-15.55	46	30.96	28.09	3.77	32.37	-	-	P	V



WLAN 802.11a_Tx_Ch36 + BT (1M) CH 39_Tx + WWAN LTE Band 41 CH39750 Link

Band 1 - 5150~5250MHz

WIFI 802.11a (Band Edge @ 3m)

WIFI Chain	Note	Frequency	Level	Over Limit	Limit Line	Read Level	Antenna Factor	Path Loss	Preamp Factor	Chain Pos	Table Pos	Peak Avg.	Pol.	
0+1		(MHz)	(dBμV/m)	(dB)	(dBμV/m)	(dBμV)	(dB/m)	(dB)	(dB)	(cm)	(deg)	(P/A)	(H/V)	
802.11a CH 36 5180MHz		5052.26	50.61	-23.39	74	38.63	31.7	10.3	30.02	100	235	P	H	
		5150	40.6	-13.4	54	28.3	31.8	10.51	30.01	100	235	A	H	
	*	5180	108.29	-	-	96.11	31.62	10.57	30.01	100	235	P	H	
	*	5180	100.75	-	-	88.57	31.62	10.57	30.01	100	235	A	H	
													H	
													H	
			5111.02	50.56	-23.44	74	38.34	31.8	10.43	30.01	100	27	P	V
			5150	39.97	-14.03	54	27.67	31.8	10.51	30.01	100	27	A	V
	*		5180	103.85	-	-	91.67	31.62	10.57	30.01	100	27	P	V
	*		5180	96.45	-	-	84.27	31.62	10.57	30.01	100	27	A	V
													V	
													V	



2.4GHz 2400~2483.5MHz

BT (Band Edge @ 3m)

BT	Note	Frequency	Level	Over	Limit	Read	Antenna	Path	Preamp	Chain	Table	Peak	Pol.
Chain.				Limit	Line	Level	Factor	Loss	Factor	Pos	Pos	Avg.	
0		(MHz)	(dBμV/m)	(dB)	(dBμV/m)	(dBμV)	(dB/m)	(dB)	(dB)	(cm)	(deg)	(P/A)	(H/V)
BT CH 39 2441MHz		2341.5	52.08	-21.92	74	48.74	27.72	6.56	30.94	110	210	P	H
		2341.5	27.29	-26.71	54	-	-	-	-	-	-	A	H
	*	2440	108.52	-	-	105.2	27.5	6.72	30.9	110	210	P	H
	*	2440	83.73	-	-	-	-	-	-	-	-	A	H
		2493.84	47.66	-26.34	74	44.31	27.41	6.81	30.87	110	210	P	H
		2493.84	22.87	-31.13	54	-	-	-	-	-	-	A	H
		2341.08	46.8	-27.2	74	43.46	27.72	6.56	30.94	289	295	P	V
		2341.08	22.01	-31.99	54	-	-	-	-	-	-	A	V
	*	2440	103.95	-	-	100.63	27.5	6.72	30.9	289	295	P	V
	*	2440	79.16	-	-	-	-	-	-	-	-	A	V
		2490.83	48.03	-25.97	74	44.68	27.42	6.8	30.87	289	295	P	V
		2490.83	23.24	-30.76	54	-	-	-	-	-	-	A	V



WLAN 802.11a_Tx_Ch36 + BT (1M) CH 39_Tx + WWAN LTE Band 41 CH39750 Link

(Harmonic @ 3m)

WIFI	Note	Frequency	Level	Over	Limit	Read	Antenna	Path	Preamp	Chain	Table	Peak	Pol.	
Chain				Limit	Line	Level	Factor	Loss	Factor	Pos	Pos	Avg.		
0+1		(MHz)	(dBμV/m)	(dB)	(dBμV/m)	(dBμV)	(dB/m)	(dB)	(dB)	(cm)	(deg)	(P/A)	(H/V)	
11a_Ch36+		2341	54.24	-19.76	74	50.9	27.72	6.56	30.94	196	260	P	H	
		2341	48.56	-5.44	54	45.22	27.72	6.56	30.94	196	260	A	H	
		2739	51.7	-22.3	74	47.4	27.98	7.17	30.85	100	234	P	H	
		2739	41.9	-12.1	54	37.6	27.98	7.17	30.85	100	234	A	H	
		4882	46.4	-27.6	74	35.3	31.04	10.11	30.05	100	0	P	H	
		4882	21.61	-32.39	54	-	-	-	-	-	-	-	A	H
		7323	42.71	-31.29	74	52.19	36.3	12.63	58.41	100	0	P	H	
		7323	17.92	-36.08	54	-	-	-	-	-	-	-	A	H
		10360	52.2	-16	68.2	59.1	39.44	14.46	60.8	100	0	P	H	
		15540	46.52	-27.48	74	53.77	37.82	17.29	62.36	100	0	P	H	
BT_Ch39+		18000	59.98	-14.02	74	49.18	49	19.04	57.24	100	134	P	H	
LTE Band		18000	50.19	-3.81	54	39.39	49	19.04	57.24	100	134	A	H	
41 Link		2341	45.43	-28.57	74	42.09	27.72	6.56	30.94	100	0	P	V	
		2739	45.96	-28.04	74	41.66	27.98	7.17	30.85	100	0	A	V	
		4882	47.19	-26.81	74	36.09	31.04	10.11	30.05	100	0	P	V	
		4882	22.4	-31.6	54	-	-	-	-	-	-	A	V	
		7323	43.03	-30.97	74	52.51	36.3	12.63	58.41	100	0	P	V	
		7323	18.24	-35.76	54	-	-	-	-	-	-	A	V	
		10360	58.45	-9.75	68.2	65.35	39.44	14.46	60.8	100	0	P	V	
		15540	46.71	-27.29	74	53.96	37.82	17.29	62.36	100	0	P	V	
		17988.9	59.79	-14.21	74	49.23	48.8	19.03	57.27	300	246	P	V	
		17988.9	49.98	-4.02	54	39.42	48.8	19.03	57.27	300	246	A	V	



WLAN 802.11a_Tx_Ch36 + BT (1M) CH 39_Tx + WWAN LTE Band 41 CH39750 Link

Emission above 18GHz (SHF@ 3m)

WIFI	Note	Frequency	Level	Over	Limit	Read	Antenna	Path	Preamp	Chain	Table	Peak	Pol.	
Chain.				Limit	Line	Level	Factor	Loss	Factor	Pos	Pos	Avg.		
0+1/0		(MHz)	(dBμV/m)	(dB)	(dBμV/m)	(dBμV)	(dB/m)	(dB)	(dB)	(cm)	(deg)	(P/A)	(H/V)	
11a_Ch36+ BT_Ch39+ LTE Band 41 Link		19738	38.64	-35.36	74	44.34	38.1	11.15	54.95	150	0	P	H	
		28912	41.24	-26.96	68.2	40.66	39.86	15.13	54.41	150	0	P	H	
													H	
													H	
													H	
													H	
													H	
													H	
			26448	40.46	-27.74	68.2	39.47	39.77	14.52	53.3	150	0	P	V
			36370	46.3	-21.9	68.2	43.07	42.99	18.72	58.48	150	0	P	V
														V
														V
														V
														V
Remark	1. No other spurious found. 2. All results are PASS against limit line.													



WLAN 802.11a_Tx_Ch36 + BT (1M) CH 39_Tx + WWAN LTE Band 41 CH39750 Link

Emission below 1GHz (LF@ 3m)

WIFI	Note	Frequency	Level	Over	Limit	Read	Antenna	Path	Preamp	Chain	Table	Peak	Pol.	
Chain.				Limit	Line	Level	Factor	Loss	Factor	Pos	Pos	Avg.		
0+1		(MHz)	(dBμV/m)	(dB)	(dBμV/m)	(dBμV)	(dB/m)	(dB)	(dB)	(cm)	(deg)	(P/A)	(H/V)	
11a_Ch36+ BT_Ch39+ LTE B41 Link		84.32	25.2	-14.8	40	42.55	13.84	1.3	32.49	-	-	P	H	
		146.4	28.75	-14.75	43.5	42.33	17.19	1.73	32.5	100	0	P	H	
		329.73	24.53	-21.47	46	34.79	19.76	2.5	32.52	-	-	P	H	
		561.56	26.93	-19.07	46	30.19	26.09	3.25	32.6	-	-	P	H	
		752.65	29.45	-16.55	46	30.2	27.95	3.73	32.43	-	-	P	H	
		865.17	30.7	-15.3	46	29.42	29	4.08	31.8	-	-	P	H	
														H
														H
														H
														H
														H
														H
														H
														H
														H
														H
														H
			46.49	33.87	-6.13	40	49.61	15.99	0.86	32.59	100	0	P	V
			83.35	24.14	-15.86	40	41.6	13.74	1.29	32.49	-	-	P	V
		150.28	23.31	-20.19	43.5	37.06	16.99	1.76	32.5	-	-	P	V	
		262.8	19.76	-26.24	46	29.93	19.94	2.31	32.42	-	-	P	V	
		579.02	26.68	-19.32	46	30.17	25.72	3.32	32.53	-	-	P	V	
		863.23	31.09	-14.91	46	29.81	29.02	4.07	31.81	-	-	P	V	
													V	
													V	
													V	
													V	
													V	
													V	
													V	
Remark	<ol style="list-style-type: none"> No other spurious found. All results are PASS against limit line. 													



WLAN 802.11a_Tx_Ch36 + 802.11b_Tx_Ch01 + WWAN LTE Band 41 CH39750 Link

2.4GHz 2400~2483.5MHz

WIFI 802.11b (Band Edge @ 3m)

WIFI Chain	Note	Frequency	Level	Over Limit	Limit Line	Read Level	Antenna Factor	Path Loss	Preamp Factor	Chain Pos	Table Pos	Peak Avg.	Pol.	
0+1		(MHz)	(dBμV/m)	(dB)	(dBμV/m)	(dBμV)	(dB/m)	(dB)	(dB)	(cm)	(deg)	(P/A)	(H/V)	
802.11b CH 01 2412MHz		2376.15	54.58	-19.42	74	41.36	27.6	16.54	30.92	105	165	P	H	
		2340.24	42.78	-11.22	54	29.52	27.72	16.48	30.94	105	165	A	H	
	*	2412	102.42	-	-	89.23	27.5	16.6	30.91	105	165	P	H	
	*	2412	99.21	-	-	86.02	27.5	16.6	30.91	105	165	A	H	
													H	
													H	
			2345.49	53.73	-20.27	74	40.46	27.71	16.49	30.93	373	31	P	V
			2334.15	42.8	-11.2	54	29.54	27.73	16.47	30.94	373	31	A	V
	*		2412	100.48	-	-	87.29	27.5	16.6	30.91	373	31	P	V
	*		2412	97.32	-	-	84.13	27.5	16.6	30.91	373	31	A	V
													V	
													V	



Band 1 - 5150~5250MHz
WIFI 802.11a (Band Edge @ 3m)

WIFI	Note	Frequency	Level	Over	Limit	Read	Antenna	Path	Preamp	Chain	Table	Peak	Pol.	
Chain				Limit	Line	Level	Factor	Loss	Factor	Pos	Pos	Avg.		
0+1		(MHz)	(dBμV/m)	(dB)	(dBμV/m)	(dBμV)	(dB/m)	(dB)	(dB)	(cm)	(deg)	(P/A)	(H/V)	
802.11a CH 36 5180MHz		5100.1	50.75	-23.25	74	38.55	31.8	10.41	30.01	100	235	P	H	
		5105.56	40.16	-13.84	54	27.95	31.8	10.42	30.01	100	235	A	H	
	*	5180	107	-	-	94.82	31.62	10.57	30.01	100	235	P	H	
	*	5180	99.6	-	-	87.42	31.62	10.57	30.01	100	235	A	H	
													H	
														H
														V
			5145.34	50.44	-23.56	74	38.15	31.8	10.5	30.01	103	26	P	V
			5106.34	39.7	-14.3	54	27.49	31.8	10.42	30.01	103	26	A	V
	*		5180	102.07	-	-	89.89	31.62	10.57	30.01	103	26	P	V
	*		5180	94.77	-	-	82.59	31.62	10.57	30.01	103	26	A	V
														V



WLAN 802.11a_Tx_Ch36 + 802.11b_Tx_Ch01 + WWAN LTE Band 41 CH39750 Link

(Harmonic @ 3m)

WIFI	Note	Frequency	Level	Over	Limit	Read	Antenna	Path	Preamp	Chain	Table	Peak	Pol.	
Chain				Limit	Line	Level	Factor	Loss	Factor	Pos	Pos	Avg.		
0+1		(MHz)	(dBμV/m)	(dB)	(dBμV/m)	(dBμV)	(dB/m)	(dB)	(dB)	(cm)	(deg)	(P/A)	(H/V)	
11b_Ch01+ 11a_Ch36+ LTE Band 41 Link		4824	51.41	-22.59	74	40.31	31.1	10.07	30.07	100	35	P	H	
		4824	39.07	-14.93	54	27.97	31.1	10.07	30.07	100	35	A	H	
		10360	51.32	-16.88	68.2	58.22	39.44	14.46	60.8	100	0	P	H	
		15540	46.58	-27.42	74	53.83	37.82	17.29	62.36	100	0	P	H	
		18000	59.57	-14.43	74	48.77	49	19.04	57.24	100	17	P	H	
		18000	49.75	-4.25	54	38.95	49	19.04	57.24	100	17	A	H	
														H
														H
			4824	50.96	-23.04	74	39.86	31.1	10.07	30.07	100	230	P	V
			4824	39.47	-14.53	54	28.37	31.1	10.07	30.07	100	230	A	V
			10360	48.23	-19.97	68.2	55.13	39.44	14.46	60.8	100	0	P	V
			15540	47.26	-26.74	74	54.51	37.82	17.29	62.36	100	0	P	V
			17988.9	60.1	-13.9	74	49.54	48.8	19.03	57.27	100	22	P	V
			17988.9	50.23	-3.77	54	39.67	48.8	19.03	57.27	100	22	A	V
													V	
													V	



WLAN 802.11a_Tx_Ch36 + 802.11g_Tx_Ch01 + WWAN LTE Band 41 CH39750 Link

Emission above 18GHz (SHF @ 3m)

WIFI	Note	Frequency	Level	Over	Limit	Read	Antenna	Path	Preamp	Chain	Table	Peak	Pol.	
Chain.				Limit	Line	Level	Factor	Loss	Factor	Pos	Pos	Avg.		
0+1		(MHz)	(dBμV/m)	(dB)	(dBμV/m)	(dBμV)	(dB/m)	(dB)	(dB)	(cm)	(deg)	(P/A)	(H/V)	
11b_Ch01+		27614	41.25	-26.95	68.2	39.54	39.72	15.58	53.59	150	0	P	H	
		34566	44.18	-24.02	68.2	42.96	41.33	18.3	58.41	150	0	P	H	
													H	
													H	
													H	
													H	
													H	
													H	
	11a_Ch36+													H
														H
LTE Band 41 Link			20156	37.44	-36.56	74	42.77	38.35	11.22	54.9	150	0	P	V
			31024	41.85	-26.35	68.2	40.75	40.4	16.44	55.74	150	0	P	V
														V
														V
														V
														V
													V	
													V	
Remark	1. No other spurious found.													
	2. All results are PASS against limit line.													



WLAN 802.11a_Tx_Ch36 + 802.11g_Tx_Ch01 + WWAN LTE Band 41 CH39750 Link

Emission below 1GHz (LF @ 3m)

WIFI	Note	Frequency	Level	Over	Limit	Read	Antenna	Path	Preamp	Chain	Table	Peak	Pol.	
Chain.				Limit	Line	Level	Factor	Loss	Factor	Pos	Pos	Avg.		
0+1		(MHz)	(dBμV/m)	(dB)	(dBμV/m)	(dBμV)	(dB/m)	(dB)	(dB)	(cm)	(deg)	(P/A)	(H/V)	
11b_Ch01+ 11a_Ch36+ LTE Band 41 Link		83.35	28.14	-11.86	40	45.6	13.74	1.29	32.49	100	0	P	H	
		182.29	29.99	-13.51	43.5	45.63	14.88	1.96	32.48	-	-	P	H	
		287.05	22.19	-23.81	46	33.39	18.9	2.37	32.47	-	-	P	H	
		331.67	23.58	-22.42	46	33.77	19.83	2.5	32.52	-	-	P	H	
		571.26	26.64	-19.36	46	30.04	25.88	3.28	32.56	-	-	P	H	
		841.89	31.9	-14.1	46	31.04	28.77	4.02	31.93	-	-	P	H	
														H
														H
														H
														H
														H
														H
			46.49	31.76	-8.24	40	47.5	15.99	0.86	32.59	100	76	P	V
			83.35	25.99	-14.01	40	43.45	13.74	1.29	32.49	-	-	P	V
			179.38	24.22	-19.28	43.5	39.78	14.97	1.95	32.48	-	-	P	V
			256.98	20.4	-25.6	46	31.09	19.42	2.3	32.41	-	-	P	V
			558.65	26.84	-19.16	46	30.26	25.94	3.25	32.61	-	-	P	V
			825.4	30.52	-15.48	46	30.49	28.08	3.97	32.02	-	-	P	V
														V
													V	
													V	
													V	
													V	
													V	
Remark	<ol style="list-style-type: none"> No other spurious found. All results are PASS against limit line. 													



Note symbol

*	Fundamental Frequency which can be ignored. However, the level of any unwanted emissions shall not exceed the level of the fundamental frequency.
-	The signal is Unintentional Radiators .
P/A	Peak or Average
H/V	Horizontal or Vertical



A calculation example for radiated spurious emission is shown as below:

WIFI	Note	Frequency	Level	Over	Limit	Read	Antenna	Path	Preamp	Chain	Table	Peak	Pol.
Chain				Limit	Line	Level	Factor	Loss	Factor	Pos	Pos	Avg.	
0+1		(MHz)	(dBμV/m)	(dB)	(dBμV/m)	(dBμV)	(dB/m)	(dB)	(dB)	(cm)	(deg)	(P/A)	(H/V)
802.11b		2390	55.45	-18.55	74	54.51	32.22	4.58	35.86	103	308	P	H
CH 01													
2412MHz		2390	43.54	-10.46	54	42.6	32.22	4.58	35.86	103	308	A	H

1. Path Loss(dB) = Cable loss(dB) + Filter loss(dB) + Attenuator loss(dB)
2. Level(dBμV/m) = Antenna Factor(dB/m) + Path Loss(dB) + Read Level(dBμV) - Preamp Factor(dB)
3. Over Limit(dB) = Level(dBμV/m) – Limit Line(dBμV/m)

For Peak Limit @ 2390MHz:

1. Level(dBμV/m)
= Antenna Factor(dB/m) + Path Loss(dB) + Read Level(dBμV) - Preamp Factor(dB)
= 32.22(dB/m) + 4.58(dB) + 54.51(dBμV) – 35.86 (dB)
= 55.45 (dBμV/m)
2. Over Limit(dB)
= Level(dBμV/m) – Limit Line(dBμV/m)
= 55.45(dBμV/m) – 74(dBμV/m)
= -18.55(dB)

For Average Limit @ 2390MHz:

1. Level(dBμV/m)
= Antenna Factor(dB/m) + Path Loss(dB) + Read Level(dBμV) - Preamp Factor(dB)
= 32.22(dB/m) + 4.58(dB) + 42.6(dBμV) – 35.86 (dB)
= 43.54 (dBμV/m)
2. Over Limit(dB) = Level(dBμV/m) – Limit Line(dBμV/m)
= 43.54(dBμV/m) – 54(dBμV/m)
= -10.46(dB)

Both peak and average measured complies with the limit line, so test result is “PASS”.



Appendix B. Radiated Spurious Emission

Test Engineer :	Leo Lee, Mancy Chou and Bigshow Wang	Temperature :	21.2~25.6°C
		Relative Humidity :	44~68%



WLAN 802.11b_Tx_Ch01 + WWAN LTE Band 41 CH39750 Link

2.4GHz 2400~2483.5MHz

WIFI 802.11b (Band Edge @ 3m)

WIFI	2.4GHz 2400~2483.5MHz Band Edge @ 3m	
Chain	802.11b CH01 2412MHz	
0+1	Horizontal	Fundamental
Peak	<p>Site : 03CH15-HY Condition : PEAK_BE_74 3m 91200_15_1620 HORIZONTAL : RBW:1000.000KHz VBW:3000.000KHz SWT:Auto Detector : Peak Project : 133117 Mode : 11b_Tx_CH01-LTE Band 41 20M</p>	<p>Site : 03CH15-HY Condition : PEAK_74 3m 91200_15_1620 HORIZONTAL : RBW:1000.000KHz VBW:3000.000KHz SWT:Auto Detector : Peak Project : 133117 Mode : 11b_Tx_CH01-LTE Band 41 20M</p>
Avg.	<p>Site : 03CH15-HY Condition : AVG_BE_54 3m 91200_15_1620 HORIZONTAL : RBW:1000.000KHz VBW:3000.000KHz SWT:Auto Detector : Peak Project : 133117 Mode : 11b_Tx_CH01-LTE Band 41 20M</p>	<p>Site : 03CH15-HY Condition : AVG_54 3m 91200_15_1620 HORIZONTAL : RBW:1000.000KHz VBW:3000.000KHz SWT:Auto Detector : Peak Project : 133117 Mode : 11b_Tx_CH01-LTE Band 41 20M</p>



WIFI	2.4GHz 2400~2483.5MHz Band Edge @ 3m	
Chain	802.11b CH01 2412MHz	
0+1	Vertical	Fundamental
Peak	<p> Site : 03CH15-HY Condition : PEAK_BE_74 3m 91200_15_1620 VERTICAL Detector : Peak Project : 133117 Mode : 11b_Tx_CH01-LTE Band 41 20M </p>	<p> Site : 03CH15-HY Condition : PEAK_74 3m 91200_15_1620 VERTICAL Detector : Peak Project : 133117 Mode : 11b_Tx_CH01-LTE Band 41 20M </p>
Avg.	<p> Site : 03CH15-HY Condition : AVG_BE_54 3m 91200_15_1620 VERTICAL Detector : Peak Project : 133117 Mode : 11b_Tx_CH01-LTE Band 41 20M </p>	<p> Site : 03CH15-HY Condition : AVG_54 3m 91200_15_1620 VERTICAL Detector : Peak Project : 133117 Mode : 11b_Tx_CH01-LTE Band 41 20M </p>



WLAN 802.11b_Tx_Ch01 + WWAN LTE Band 41 CH39750 Link
(Harmonic @ 3m)

Chain	WLAN 802.11b_Tx_Ch01+ WWAN LTE Band 41 CH39750 Link	
0+1	Horizontal	Vertical
<p>Peak</p> <p>Avg.</p>	<p>Site : 03CH15-HY Condition : PEAK_74 3m 91200_15_1620 HORIZONTAL Detector : Peak Project : 133117 Mode : 11b_Tx_Ch01+LTE Band 41 20M</p>	<p>Site : 03CH15-HY Condition : PEAK_74 3m 91200_15_1620 VERTICAL Detector : Peak Project : 133117 Mode : 11b_Tx_Ch01+LTE Band 41 20M</p>



WLAN 802.11b_Tx_Ch01 + WWAN LTE Band 41 CH39750 Link

Emission above 18GHz (SHF @ 3m)

Chain	WLAN 802.11b_Tx_Ch01+ WWAN LTE Band 41 CH39750 Link	
0+1	Horizontal	Vertical
Peak Avg.	<p>Site : 03CH16-HY Condition : PEAK_74_IM 1m SHF HORN BBH49170576 HORIZONTAL Detector : Peak Project : 133117</p>	<p>Site : 03CH16-HY Condition : PEAK_74_IM 1m SHF HORN BBH49170576 VERTICAL Detector : Peak Project : 133117</p>



WLAN 802.11b_Tx_Ch01 + WWAN LTE Band 41 CH39750 Link

Emission below 1GHz (LF @ 3m)

Chain	WLAN 802.11b_Tx_Ch01+ WWAN LTE Band 41 CH39750 Link	
0+1	Horizontal	Vertical
<p>Peak</p> <p>Avg.</p>	<p>Site : 03CH15-HY Condition : QP 3m BIL06_41912_20210208 HORIZONTAL Detector : Peak Project : 133117 Mode : 11b_Tx_Ch01+LTE Band 41 20M</p>	<p>Site : 03CH15-HY Condition : QP 3m BIL06_41912_20210208 VERTICAL Detector : Peak Project : 133117 Mode : 11b_Tx_Ch01+LTE Band 41 20M</p>



WLAN 802.11a_Tx_Ch36 + BT (1M) CH 39_Tx + WWAN LTE Band 41 CH39750 Link

Band 1 - 5150~5250MHz

WIFI 802.11a (Band Edge @ 3m)

WIFI	Band 1 5150~5250MHz Band Edge @ 3m	
Chain	802.11a CH36 5180MHz	
0+1	Horizontal	Fundamental
Peak	<p>Site : 03CH15-HY Condition : PEAK_BE_74 3m 91200_15_1620 HORIZONTAL Detector : Peak Project : 133117 Mode : 11a_Tx_Ch36+BT_IM_Ch39+LTE Band 41 20M</p>	<p>Site : 03CH15-HY Condition : PEAK(LINII) 3m 91200_15_1620 HORIZONTAL Detector : Peak Project : 133117 Mode : 11a_Tx_Ch36+BT_IM_Ch39+LTE Band 41 20M</p>
Avg.	<p>Site : 03CH15-HY Condition : AVG_BE_54 3m 91200_15_1620 HORIZONTAL Detector : Peak Project : 133117 Mode : 11a_Tx_Ch36+BT_IM_Ch39+LTE Band 41 20M</p>	Left blank



WIFI	Band 1 5150~5250MHz Band Edge @ 3m	
Chain	802.11a CH36 5180MHz	
0+1	Vertical	Fundamental
Peak	<p>Site : 03CH15-HY Condition : PEAK_BE_74 3m 91200_15_1620 VERTICAL Detector : Peak Project : 133117 Mode : 11a_Tx_Ch36+8T_IM_Ch39-LTE Band 41 20M</p>	<p>Site : 03CH15-HY Condition : PEAK(UNII) 3m 91200_15_1620 VERTICAL Detector : Peak Project : 133117 Mode : 11a_Tx_Ch36+8T_IM_Ch39-LTE Band 41 20M</p>
Avg.	<p>Site : 03CH15-HY Condition : AVG_BE_54 3m 91200_15_1620 VERTICAL Detector : Peak Project : 133117 Mode : 11a_Tx_Ch36+8T_IM_Ch39-LTE Band 41 20M</p>	Left blank



2.4GHz 2400~2483.5MHz

BT (Band Edge @ 3m)

BT	2.4GHz 2400~2483.5MHz Band Edge @ 3m	
ANT	BT CH39 2441MHz	
0	Horizontal	Fundamental
Peak	<p>Site : 03CH15-HY Condition : PEAK_BE_74 3m 91200_15_1620 HORIZONTAL : RBW:1000.000KHz VBW:3000.000KHz SWT:Auto Detector : Peak Project : 133117 Mode : 11a_Tx_Ch36-BT_IM_Ch39-LTE Band 41 20M</p>	<p>Site : 03CH15-HY Condition : PEAK_74 3m 91200_15_1620 HORIZONTAL : RBW:1000.000KHz VBW:3000.000KHz SWT:Auto Detector : Peak Project : 133117 Mode : 11a_Tx_Ch36-BT_IM_Ch39-LTE Band 41 20M</p>
Peak	<p>Site : 03CH15-HY Condition : PEAK_BE_74 3m 91200_15_1620 HORIZONTAL : RBW:1000.000KHz VBW:3000.000KHz SWT:Auto Detector : Peak Project : 133117 Mode : 11a_Tx_Ch36-BT_IM_Ch39-LTE Band 41 20M</p>	Left blank

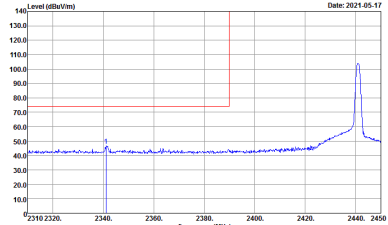
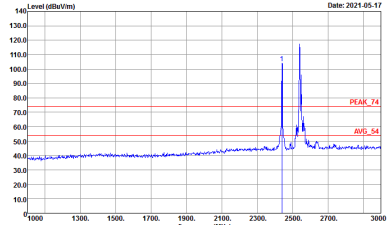
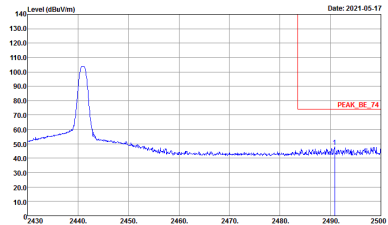

BT	2.4GHz 2400~2483.5MHz Band Edge @ 3m	
ANT	BT CH39 2441MHz	
0	Vertical	Fundamental
Peak	 <p>Date: 2021-05-17</p> <p>Site : 03CH15-HY Condition : PEAK_BE_74 3m 91200_15_1620 VERTICAL Detector : Peak Project : 133117 Mode : 11a_Tx_Ch36+8T_IM_Ch39-LTE Band 41 20M</p>	 <p>Date: 2021-05-17</p> <p>Site : 03CH15-HY Condition : PEAK_74 3m 91200_15_1620 VERTICAL Detector : Peak Project : 133117 Mode : 11a_Tx_Ch36+8T_IM_Ch39-LTE Band 41 20M</p>
Peak	 <p>Date: 2021-05-17</p> <p>Site : 03CH15-HY Condition : PEAK_BE_74 3m 91200_15_1620 VERTICAL Detector : Peak Project : 133117 Mode : 11a_Tx_Ch36+8T_IM_Ch39-LTE Band 41 20M</p>	Left blank



WLAN 802.11a_Tx_Ch36 + BT (1M) CH 39_Tx + WWAN LTE Band 41 CH39750 Link

(Harmonic @ 3m)

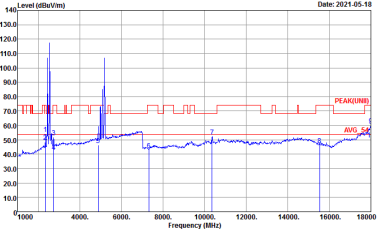
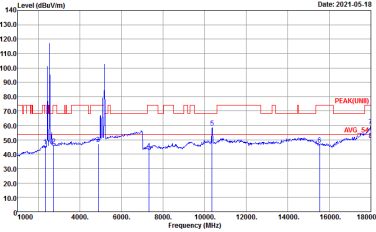
Chain	WLAN 802.11a_Tx_Ch36 + BT (1M) CH 39_Tx + WWAN LTE Band 41 CH39750 Link	
0+1	Horizontal	Vertical
Peak Avg.	 <p>Site : 03CH15-HY Condition : PEAK(UNIT) 3m 91200_15_1620 HORIZONTAL Detector : Peak Project : 133117 Mode : 11a_Tx_Ch36+BT_1M_Ch39-LTE Band 41 20M</p>	 <p>Site : 03CH15-HY Condition : PEAK(UNIT) 3m 91200_15_1620 VERTICAL Detector : Peak Project : 133117 Mode : 11a_Tx_Ch36+BT_1M_Ch39-LTE Band 41 20M</p>



WLAN 802.11a_Tx_Ch36 + BT (1M) CH 39_Tx + WWAN LTE Band 41 CH39750 Link

Emission above 18GHz (SHF @ 3m)

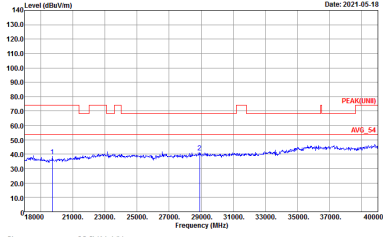
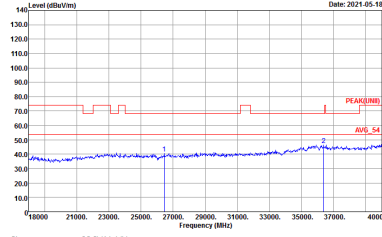
Chain	WLAN 802.11a_Tx_Ch36 + BT (1M) CH 39_Tx + WWAN LTE Band 41 CH39750 Link	
0+1	Horizontal	Vertical
QP / Peak	 <p>Site : 03CH16-HY Condition : PEAK(UM) 1m SHF HORN BBHA9170576 HORIZONTAL Detector : Peak Project : 133117</p>	 <p>Site : 03CH16-HY Condition : PEAK(UM) 1m SHF HORN BBHA9170576 VERTICAL Detector : Peak Project : 133117</p>



WLAN 802.11a_Tx_Ch36 + BT (1M) CH 39_Tx + WWAN LTE Band 41 CH39750 Link

Emission below 1GHz (LF @ 3m)

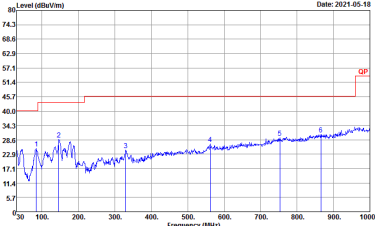
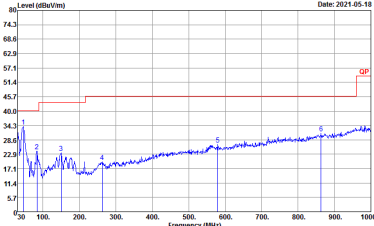
Chain	WLAN 802.11a_Tx_Ch36 + BT (1M) CH 39_Tx + WWAN LTE Band 41 CH39750 Link	
0+1	Horizontal	Vertical
QP / Peak	 <p>Site : 03CH15-HY Condition : QP 3m BTL06_41912_20210208 HORIZONTAL Detector : Peak Project : 133117 Mode : 11a_Tx_Ch36+8T_1M_Ch39-LTE Band 41 20M</p>	 <p>Site : 03CH15-HY Condition : QP 3m BTL06_41912_20210208 VERTICAL Detector : Peak Project : 133117 Mode : 11a_Tx_Ch36+8T_1M_Ch39-LTE Band 41 20M</p>



WLAN 802.11a_Tx_Ch36 + 802.11b_Tx_Ch01 + WWAN LTE Band 41 CH39750 Link

2.4GHz 2400~2483.5MHz

WIFI 802.11b (Band Edge @ 3m)

WIFI	2.4GHz 2400~2483.5MHz Band Edge @ 3m	
Chain	802.11b CH01 2412MHz	
0+1	Horizontal	Fundamental
Peak	<p>Site : 03CH15-HY Condition : PEAK_BE_74 3m 91200_15_1620 HORIZONTAL : RBW:1000.000KHz VBW:3000.000KHz SWT:Auto Detector : Peak Project : 133117 Mode : 11b_Tx_Ch01+11a_Tx_Ch36-LTE Band 41 20M</p>	<p>Site : 03CH15-HY Condition : PEAK_74 3m 91200_15_1620 HORIZONTAL : RBW:1000.000KHz VBW:3000.000KHz SWT:Auto Detector : Peak Project : 133117 Mode : 11b_Tx_Ch01+11a_Tx_Ch36-LTE Band 41 20M</p>
Avg.	<p>Site : 03CH15-HY Condition : AVG_BE_54 3m 91200_15_1620 HORIZONTAL : RBW:1000.000KHz VBW:3000.000KHz SWT:Auto Detector : Peak Project : 133117 Mode : 11b_Tx_Ch01+11a_Tx_Ch36-LTE Band 41 20M</p>	<p>Site : 03CH15-HY Condition : AVG_54 3m 91200_15_1620 HORIZONTAL : RBW:1000.000KHz VBW:3000.000KHz SWT:Auto Detector : Peak Project : 133117 Mode : 11b_Tx_Ch01+11a_Tx_Ch36-LTE Band 41 20M</p>

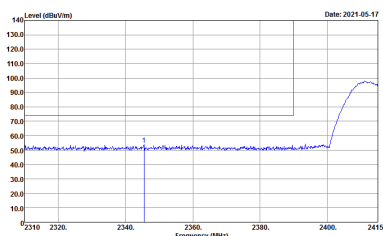
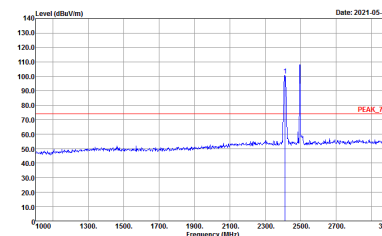
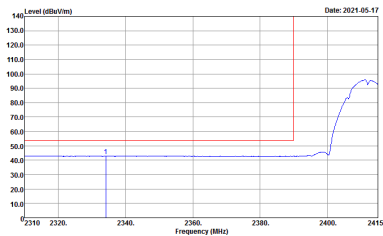
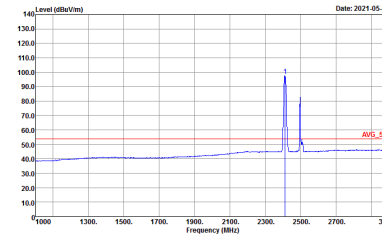

WIFI	2.4GHz 2400~2483.5MHz Band Edge @ 3m	
Chain	802.11b CH01 2412MHz	
0+1	Vertical	Fundamental
Peak	 <p>Site : 03CH15-HY Condition : PEAK_BE_74 3m 91200_15_1620 VERTICAL Detector : Peak Project : 133117 Mode : 11b_Tx_CH01+11a_Tx_Ch36-LTE Band 41 20M</p>	 <p>Site : 03CH15-HY Condition : PEAK_F4 3m 91200_15_1620 VERTICAL Detector : Peak Project : 133117 Mode : 11b_Tx_CH01+11a_Tx_Ch36-LTE Band 41 20M</p>
Avg.	 <p>Site : 03CH15-HY Condition : AVG_BE_54 3m 91200_15_1620 VERTICAL Detector : Peak Project : 133117 Mode : 11b_Tx_CH01+11a_Tx_Ch36-LTE Band 41 20M</p>	 <p>Site : 03CH15-HY Condition : AVG_F4 3m 91200_15_1620 VERTICAL Detector : Peak Project : 133117 Mode : 11b_Tx_CH01+11a_Tx_Ch36-LTE Band 41 20M</p>



Band 1 - 5150~5250MHz
WIFI 802.11a (Band Edge @ 3m)

WIFI	Band 1 5150~5250MHz Band Edge @ 3m	
Chain	802.11a CH36 5180MHz	
0+1	Horizontal	Fundamental
Peak	<p>Site : 03CH15-HY Condition : PEAK_BE_74 3m 9120D_15_1620 HORIZONTAL RBW:1000.000KHz VBW:3000.000KHz SWT:Auto Detector : Peak Project : 133117 Mode : 11b_Tx_CH01+11a_Tx_Ch36-LTE Band 41 20M</p>	<p>Site : 03CH15-HY Condition : PEAK(LINII) 3m 9120D_15_1620 HORIZONTAL RBW:1000.000KHz VBW:3000.000KHz SWT:Auto Detector : Peak Project : 133117 Mode : 11b_Tx_CH01+11a_Tx_Ch36-LTE Band 41 20M</p>
Avg.	<p>Site : 03CH15-HY Condition : AVG_BE_54 3m 9120D_15_1620 HORIZONTAL RBW:1000.000KHz VBW:3000.000KHz SWT:Auto Detector : Peak Project : 133117 Mode : 11b_Tx_CH01+11a_Tx_Ch36-LTE Band 41 20M</p>	Left blank



WIFI	Band 1 5150~5250MHz Band Edge @ 3m	
Chain	802.11a CH36 5180MHz	
0+1	Vertical	Fundamental
Peak	<p>Site : 03CH15-HY Condition : PEAK_BE_74 3m 91200_15_1620 VERTICAL Detector : Peak Project : 133117 Mode : 11b_Tx_Ch01+11a_Tx_Ch36-LTE Band 41 20M</p>	<p>Site : 03CH15-HY Condition : PEAK(UNII) 3m 91200_15_1620 VERTICAL Detector : Peak Project : 133117 Mode : 11b_Tx_Ch01+11a_Tx_Ch36-LTE Band 41 20M</p>
Avg.	<p>Site : 03CH15-HY Condition : AVG_BE_54 3m 91200_15_1620 VERTICAL Detector : Peak Project : 133117 Mode : 11b_Tx_Ch01+11a_Tx_Ch36-LTE Band 41 20M</p>	Left blank

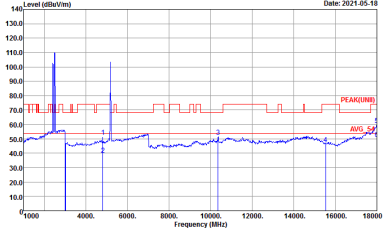
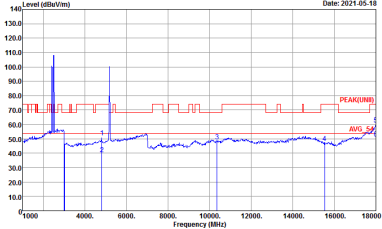

WLAN 802.11a_Tx_Ch36 + 802.11b_Tx_Ch01 + WWAN LTE Band 41 CH39750 Link
(Harmonic @ 3m)

Chain	WLAN 802.11a_Tx_Ch36 + 802.11b_Tx_Ch01 + WWAN LTE Band 41 CH39750 Link	
0+1	Horizontal	Vertical
<p>Peak</p> <p>Avg.</p>	 <p>Site : 03CH15-HY Condition : PEAK(UNIT) 3m 91200_15_1620 HORIZONTAL Detector : Peak Project : 133117 Mode : 11b_Tx_Ch01+11a_Tx_Ch36-LTE Band 41 20M</p>	 <p>Site : 03CH15-HY Condition : PEAK(UNIT) 3m 91200_15_1620 VERTICAL Detector : Peak Project : 133117 Mode : 11b_Tx_Ch01+11a_Tx_Ch36-LTE Band 41 20M</p>



WLAN 802.11a_Tx_Ch36 + 802.11b_Tx_Ch01 + WWAN LTE Band 41 CH39750 Link

Emission above 18GHz (SHF @ 3m)

Chain	WLAN 802.11a_Tx_Ch36 + 802.11b_Tx_Ch01 + WWAN LTE Band 41 CH39750 Link	
0+1	Horizontal	Vertical
QP / Peak	<p>Site : 03CH16-HY Condition : PEAK(UNIT) 1m SHF HORN BBH49170576 HORIZONTAL Detector : Peak Project : 133117</p>	<p>Site : 03CH16-HY Condition : PEAK(UNIT) 1m SHF HORN BBH49170576 VERTICAL Detector : Peak Project : 133117</p>



WLAN 802.11a_Tx_Ch36 + 802.11b_Tx_Ch01 + WWAN LTE Band 41 CH39750 Link

Emission below 1GHz (LF @ 3m)

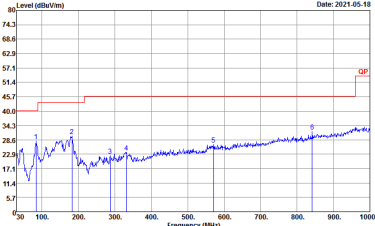
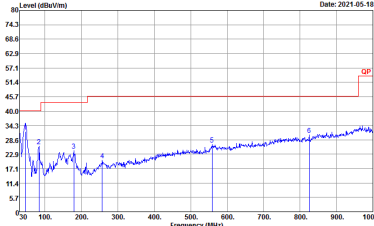
Chain	WLAN 802.11a_Tx_Ch36 + 802.11b_Tx_Ch01 + WWAN LTE Band 41 CH39750 Link	
0+1	Horizontal	Vertical
QP / Peak	 <p>Site : 03CH15-HY Condition : QP 3m BIL06_41912_20210208 HORIZONTAL Detector : Peak Project : 133117 Mode : 11b_Tx_Ch01+11a_Tx_Ch36-LTE Band 41 20M</p>	 <p>Site : 03CH15-HY Condition : QP 3m BIL06_41912_20210208 VERTICAL Detector : Peak Project : 133117 Mode : 11b_Tx_Ch01+11a_Tx_Ch36-LTE Band 41 20M</p>

Appendix C. Duty Cycle Plots

<Ant. 0>

<1Mbps>

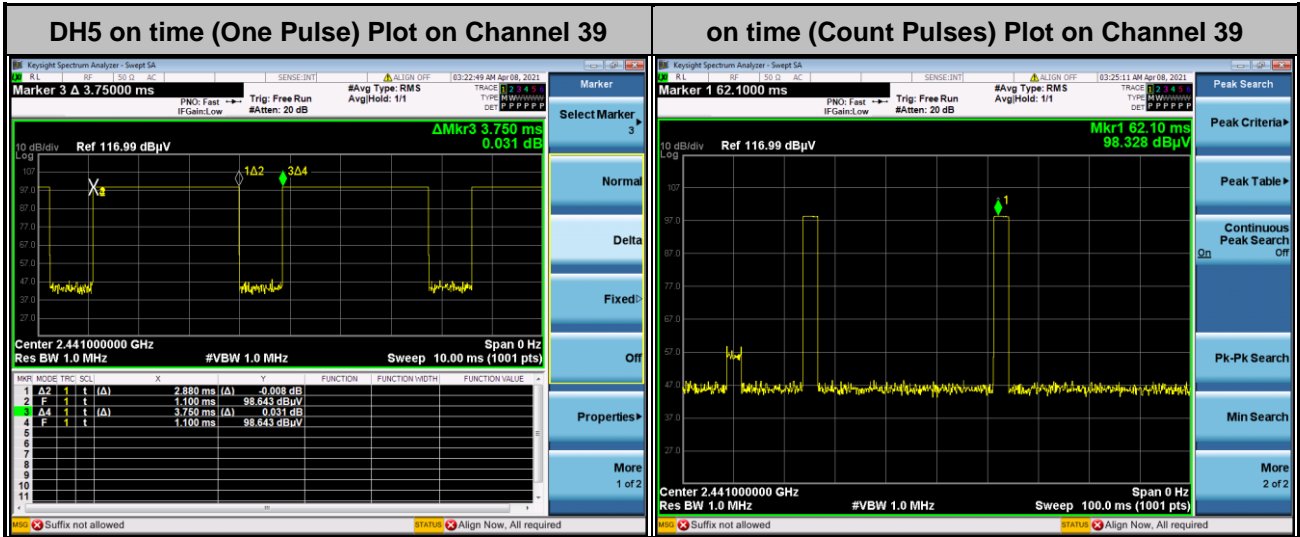

Note:

1. Worst case Duty cycle = on time/100 milliseconds = $2 * 2.88 / 100 = 5.76 \%$
2. Worst case Duty cycle correction factor = $20 * \log(\text{Duty cycle}) = -24.79 \text{ dB}$
3. DH5 has the highest duty cycle worst case and is reported.

Duty Cycle Correction Factor Consideration for AFH mode:

Bluetooth normal hopping rate is 1600Hz and reduced to 800Hz in AFH mode; due to the reduced number of hopping frequencies, with the same packet configuration the dwell time in each channel frequency within 100msec period is longer in AFH mode than normal mode.

In AFH mode, the minimum hopping frequencies are 20, to get the longest dwell time DH5 packet is observed; the period to have DH5 packet completing one hopping sequence is

$$2.88 \text{ ms} \times 20 \text{ channels} = 57.6 \text{ ms}$$

There cannot be 2 complete hopping sequences within 100ms period, considering the random hopping behavior, maximum 2 hops can be possibly observed within the period. $[100 \text{ ms} / 57.6 \text{ ms}] = 2 \text{ hops}$

Thus, the maximum possible ON time:

$$2.88 \text{ ms} \times 2 = 5.76 \text{ ms}$$

Worst case Duty Cycle Correction factor, which is derived from the maximum possible ON time,

$$20 \times \log(5.76 \text{ ms}/100 \text{ ms}) = -24.79 \text{ dB}$$



Chain	Band	Duty Cycle(%)	T(us)	1/T(kHz)	VBW Setting	Duty Factor(dB)
0+1	2.4GHz 802.11b	100	-	-	10Hz	0.00
0+1	5GHz 802.11a	99.05	-	-	10Hz	0.04

MIMO <Chain 0+1>

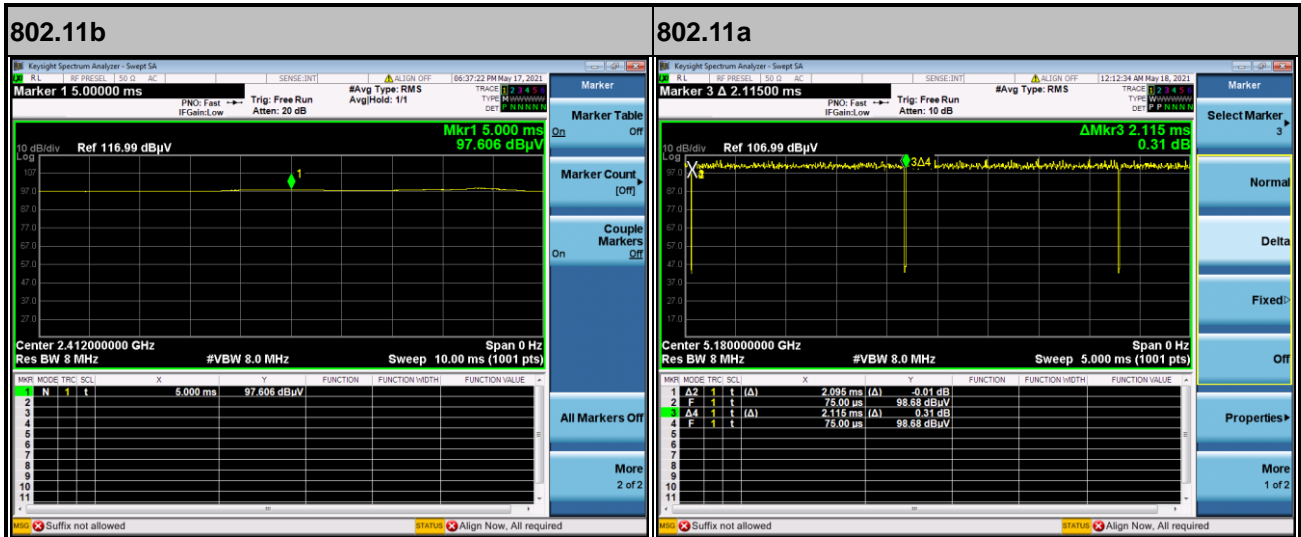

— THE END —