



FCC RADIO TEST REPORT

FCC ID : PY7-45077R
Equipment : GSM/WCDMA/LTE Phone with BT, DTS/UNII
a/b/g/n/ac, GPS and NFC
Brand Name : Sony
Applicant : Sony Mobile Communications Inc.
4-12-3 Higashi-Shinagawa, Shinagawa-ku,
Tokyo, 140-0002, Japan
Manufacturer : Sony Mobile Communications Inc.
4-12-3 Higashi-Shinagawa, Shinagawa-ku,
Tokyo, 140-0002, Japan
Standard : 47 CFR Part 2, 22(H), 24(E)

The product was received on Nov. 13, 2019 and testing was started from Dec. 10, 2019 and completed on Jan. 02, 2020. We, SPORTON INTERNATIONAL INC. EMC & Wireless Communications Laboratory, would like to declare that the tested sample has been evaluated in accordance with the test procedures given in ANSI / TIA-603-E and has been in compliance with the applicable technical standards.

The report must not be used by the client to claim product certification, approval, or endorsement by TAF or any agency of government.

The test results in this report apply exclusively to the tested model / sample. Without written approval of SPORTON INTERNATIONAL INC. EMC & Wireless Communications Laboratory, the test report shall not be reproduced except in full.

Louis Wu

Approved by: Louis Wu

SPORTON INTERNATIONAL INC. EMC & Wireless Communications Laboratory

No. 52, Huaya 1st Rd., Guishan Dist., Taoyuan City, Taiwan (R.O.C.)



Table of Contents

History of this test report 3

Summary of Test Result 4

1 General Description..... 5

 1.1 Product Feature of Equipment Under Test..... 5

 1.2 Modification of EUT 5

 1.3 Maximum ERP/EIRP Power, Frequency Tolerance, and Emission Designator 6

 1.4 Testing Location..... 7

 1.5 Applicable Standards 7

2 Test Configuration of Equipment Under Test 8

 2.1 Test Mode 8

 2.2 Connection Diagram of Test System..... 9

 2.3 Support Unit used in test configuration 9

 2.4 Measurement Results Explanation Example..... 9

 2.5 Frequency List of Low/Middle/High Channels 10

3 Conducted Test Result..... 11

 3.1 Measuring Instruments..... 11

 3.2 Conducted Output Power and ERP/EIRP 12

 3.3 Peak-to-Average Ratio..... 13

 3.4 99% Occupied Bandwidth and 26dB Bandwidth Measurement 14

 3.5 Conducted Band Edge 15

 3.6 Conducted Spurious Emission 16

 3.7 Frequency Stability..... 17

4 Radiated Test Items 18

 4.1 Measuring Instruments..... 18

 4.2 Test Setup..... 18

 4.3 Test Result of Radiated Test..... 18

 4.4 Field Strength of Spurious Radiation Measurement..... 19

5 List of Measuring Equipment..... 20

6 Uncertainty of Evaluation..... 22

Appendix A. Test Results of Conducted Test

Appendix B. Test Results of ERP/EIRP and Radiated Test



History of this test report

| Report No. | Version | Description | Issued Date |
|--------------|---------|-------------------------|---------------|
| FG901524-02A | 01 | Initial issue of report | Jan. 30, 2020 |
| | | | |
| | | | |
| | | | |
| | | | |
| | | | |
| | | | |
| | | | |
| | | | |
| | | | |
| | | | |
| | | | |
| | | | |
| | | | |
| | | | |
| | | | |
| | | | |
| | | | |
| | | | |
| | | | |



Summary of Test Result

| Report Clause | Ref Std. Clause | Test Items | Result (PASS/FAIL) | Remark |
|---------------|---------------------------------------|--|--------------------|--|
| 3.2 | §2.1046 | Conducted Output Power | Pass | - |
| | §22.913 (a)(2) | Effective Radiated Power (GSM850) (WCDMA Band V) | | |
| | §24.232 (c) | Equivalent Isotropic Radiated Power (GSM1900) | | |
| 3.3 | §24.232 (d) | Peak-to-Average Ratio | Pass | |
| 3.4 | §2.1049 | Occupied Bandwidth (GSM850) (WCDMA Band V) (GSM1900) | Pass | - |
| | §22.917 (b) | | | |
| | §24.238 (b) | | | |
| 3.5 | §2.1051 | Band Edge Measurement (GSM850) (WCDMA Band V) (GSM1900) | Pass | - |
| | §22.917 (a) | | | |
| | §24.238 (a) | | | |
| 3.6 | §2.1051 | Conducted Emission (GSM850) (WCDMA Band V) (GSM1900) | Pass | - |
| | §22.917 (a) | | | |
| | §24.238 (a) | | | |
| 3.7 | §2.1055 | Frequency Stability Temperature & Voltage | Pass | - |
| | §22.355 | | | |
| | §24.235 | | | |
| 4.4 | §2.1053 §22.917 (a) §24.238 (a) | Field Strength of Spurious Radiation (GSM850) (WCDMA Band V) (GSM1900) | Pass | Under limit 30.43 dB at 7403.000 MHz |

Declaration of Conformity:

The test results with all measurement uncertainty excluded are presented in accordance with the regulation limits or requirements declared by manufacturers.

Comments and Explanations:

The declared of product specification for EUT presented in the report are provided by the manufacturer, and the manufacturer takes all the responsibilities for the accuracy of product specification.

Reviewed by: Wii Chang

Report Producer: Ann Lee



1 General Description

1.1 Product Feature of Equipment Under Test

GSM/WCDMA/LTE, Bluetooth, DTS/UNII a/b/g/n/ac, NFC, and GNSS.

| Product Specification subjective to this standard | |
|---|-------------------------|
| Antenna Type | Inverted-F Type Antenna |

| EUT Information List | | | |
|----------------------|------------|------------|----------------------------|
| HW Version | SW Version | S/N | Performed Test Item |
| A | 0.89 | BH950052JB | Conducted Measurement |
| | 2.2 | BH950060JL | Radiated Spurious Emission |
| | 0.89 | BH95004WJB | ERP/EIRP Test |

| Accessory List | |
|----------------|---------------------|
| AC Adapter | Model Name : UCH20 |
| | S/N: 3515W45302495 |
| Earphone | Model Name : STH40D |
| | S/N : N/A |
| USB Cable | Model Name : UCB20 |
| | S/N : N/A |

Note:

1. Above EUT list used are electrically identical per declared by manufacturer.
2. Above the accessories list are used to exercise the EUT during test, and the serial number of each type of accessories is listed in each section of this report.
3. For other wireless features of this EUT, test report will be issued separately.

1.2 Modification of EUT

No modifications are made to the EUT during all test items.



1.3 Maximum ERP/EIRP Power, Frequency Tolerance, and Emission Designator

| FCC Rule | Frequency Range (MHz) | System | Type of Modulation | Maximum ERP/EIRP (W) | Frequency Tolerance (ppm) | Emission Designator |
|----------|-----------------------|------------------------------|--------------------|----------------------|---------------------------|---------------------|
| Part 22 | 824.2 ~848.8 | GSM850 GPRS class 8 | GMSK | 0.5821 | 0.0430 ppm | 249KGXW |
| Part 22 | 824.2 ~848.8 | GSM850 EDGE class 8 | 8PSK | 0.1409 | 0.0108 ppm | 246KG7W |
| Part 22 | 826.4 ~846.6 | WCDMA Band V RMC 12.2Kbps | BPSK | 0.0653 | 0.0203 ppm | 4M14F9W |
| Part 24 | 1850.2 ~1909.8 | GSM1900 GPRS class 8 | GMSK | 0.1611 | 0.0138 ppm | 245KGXW |
| Part 24 | 1850.2 ~1909.8 | GSM1900 EDGE class 8 | 8PSK | 0.1560 | 0.0069 ppm | 245KG7W |



1.4 Testing Location

| | |
|---------------------------|---|
| Test Site | SPORTON INTERNATIONAL INC. EMC & Wireless Communications Laboratory |
| Test Site Location | No.52, Huaya 1st Rd., Guishan Dist., Taoyuan City, Taiwan (R.O.C.) TEL: +886-3-327-3456 FAX: +886-3-328-4978 |
| Test Site No. | Sporton Site No. |
| | TH03-HY |
| Test Engineer | Louis Chung |
| Temperature | 21~23.9 °C |
| Relative Humidity | 46.6~55.8 % |

Note: The test site complies with ANSI C63.4 2014 requirement.

| | |
|---------------------------|---|
| Test Site | SPORTON INTERNATIONAL INC. EMC & Wireless Communications Laboratory |
| Test Site Location | No.58, Aly. 75, Ln. 564, Wenhua 3rd, Rd., Guishan Dist., Taoyuan City, Taiwan (R.O.C.) TEL: +886-3-327-0868 FAX: +886-3-327-0855 |
| Test Site No. | Sporton Site No. |
| | 03CH12-HY |
| Test Engineer | Jack Cheng, Lance Chiang, and Chuan Chu |
| Temperature | 22.3~25.3 °C |
| Relative Humidity | 55.7~61.9 % |

Note: The test site complies with ANSI C63.4 2014 requirement.

FCC Designation No.: TW1190 and TW0007

1.5 Applicable Standards

According to the specifications of the manufacturer, the EUT must comply with the requirements of the following standards:

- ♦ ANSI C63.26-2015
- ♦ ANSI / TIA-603-E
- ♦ 47 CFR Part 2, 22(H), 24(E)
- ♦ FCC KDB 971168 D01 Power Meas. License Digital Systems v03r01
- ♦ FCC KDB 412172 D01 Determining ERP and EIRP v01r01

Remark: All test items were verified and recorded according to the standards and without any deviation during the test.



2 Test Configuration of Equipment Under Test

2.1 Test Mode

Antenna port conducted and radiated test items were performed according to KDB 971168 D01 Power Meas. License Digital Systems v03r01 with maximum output power.

For radiated measurement, pre-scanned in three orthogonal panels, X, Y, Z. The worst cases (X plane for Cellular Band; Y Plane for PCS Band) were recorded in this report.

Radiated emissions were investigated as following frequency range:

1. 30 MHz to 9000 MHz for GSM850 and WCDMA Band V
2. 30 MHz to 19100 MHz for GSM1900

All modes and data rates and positions were investigated.

Test modes are chosen to be reported as the worst case configuration below:

| Test Modes | | |
|--------------|---|---|
| Band | Radiated TCs | Conducted TCs |
| GSM850 | <ul style="list-style-type: none">■ GPRS Class 8 Link■ EDGE Class 8 Link | <ul style="list-style-type: none">■ GPRS Class 8 Link■ EDGE Class 8 Link |
| GSM1900 | <ul style="list-style-type: none">■ GPRS Class 8 Link■ EDGE Class 8 Link | <ul style="list-style-type: none">■ GPRS Class 8 Link■ EDGE Class 8 Link |
| WCDMA Band V | <ul style="list-style-type: none">■ RMC 12.2Kbps Link | <ul style="list-style-type: none">■ RMC 12.2Kbps Link |

2.2 Connection Diagram of Test System

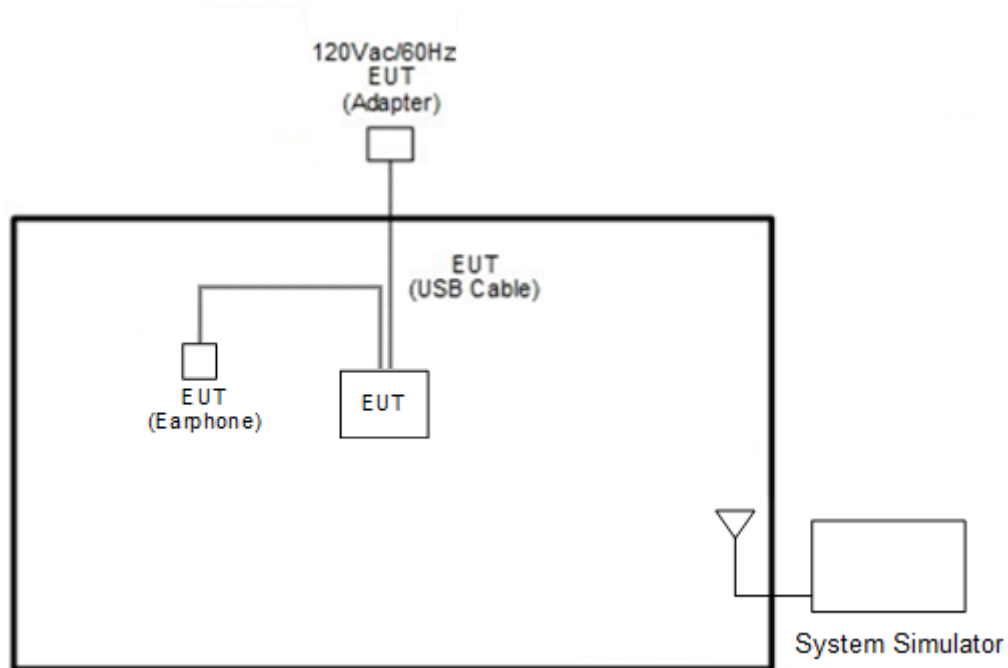

2.3 Support Unit used in test configuration

| Item | Equipment | Trade Name | Model No. | FCC ID | Data Cable | Power Cord |
|------|------------------|------------|-----------|--------|------------|-------------------|
| 1. | System Simulator | R&S | CMU 200 | N/A | N/A | Unshielded, 1.8 m |

2.4 Measurement Results Explanation Example

For all conducted test items:

The offset level is set in the spectrum analyzer to compensate the RF cable loss and attenuator factor between RF conducted output port and spectrum analyzer. With the offset compensation, the spectrum analyzer reading level will be exactly the RF output level.

The spectrum analyzer offset is derived from RF cable loss and attenuator factor.

Offset = RF cable loss + attenuator factor.

The following shows an offset computation example with RF cable loss 4.2 dB and a 10dB attenuator.

Example:

$$\begin{aligned} \text{Offset(dB)} &= \text{RF cable loss(dB)} + \text{attenuator factor(dB)} \\ &= 4.2 + 10 = 14.2 \text{ (dB)} \end{aligned}$$



2.5 Frequency List of Low/Middle/High Channels

| Frequency List | | | | |
|-----------------|------------------------|--------|--------|---------|
| Band | Channel/Frequency(MHz) | Lowest | Middle | Highest |
| GSM850 | Channel | 128 | 189 | 251 |
| | Frequency | 824.2 | 836.4 | 848.8 |
| WCDMA Band V | Channel | 4132 | 4182 | 4233 |
| | Frequency | 826.4 | 836.4 | 846.6 |
| GSM1900 | Channel | 512 | 661 | 810 |
| | Frequency | 1850.2 | 1880.0 | 1909.8 |

3 Conducted Test Result

3.1 Measuring Instruments

See list of measuring instruments of this test report.

3.1.1 Test Setup

3.1.2 Conducted Output Power

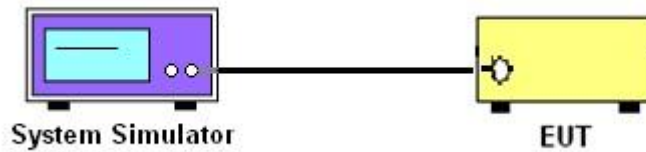

3.1.3 Peak-to-Average Ratio, Occupied Bandwidth, Conducted Band-Edge and Conducted Spurious Emission

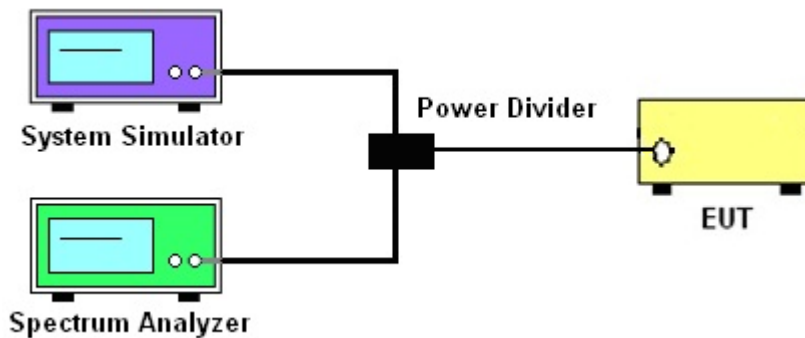

3.1.4 Frequency Stability

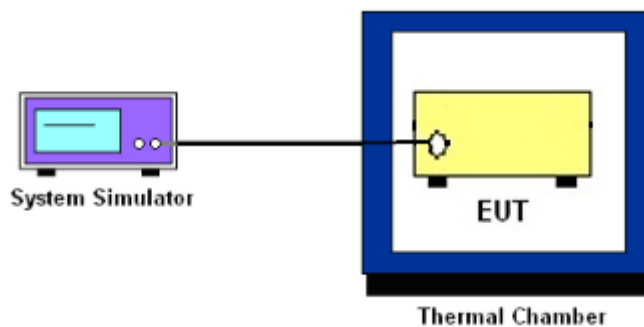

3.1.5 Test Result of Conducted Test

Please refer to Appendix A.



3.2 Conducted Output Power and ERP/EIRP

3.2.1 Description of the Conducted Output Power and ERP/EIRP

A system simulator was used to establish communication with the EUT. Its parameters were set to enforce EUT transmitting at the maximum power. The measured power in the radio frequency on the transmitter output terminals shall be reported.

The ERP of mobile transmitters must not exceed 7 Watts for GSM850 and WCDMA Band V

The EIRP of mobile transmitters must not exceed 2 Watts for GSM1900

According to KDB 412172 D01 Power Approach,

$EIRP = P_T + G_T - L_C$, $ERP = EIRP - 2.15$, where

P_T = transmitter output power in dBm

G_T = gain of the transmitting antenna in dBi

L_C = signal attenuation in the connecting cable between the transmitter and antenna in dB

3.2.2 Test Procedures

1. The transmitter output port was connected to the system simulator.
2. Set EUT at maximum power through system simulator.
3. Select lowest, middle, and highest channels for each band and different modulation.
4. Measure the maximum burst average power for GSM and maximum average power for other modulation signal.



3.3 Peak-to-Average Ratio

3.3.1 Description of the PAR Measurement

The peak-to-average ratio (PAR) of the transmission may not exceed 13 dB.

3.3.2 Test Procedures

The testing follows ANSI C63.26-2015 Section 5.2.6

1. The EUT was connected to spectrum analyzer and system simulator via a power divider.
2. Set EUT to transmit at maximum output power.
3. When the duty cycle is less than 98%, then signal gating will be implemented on the spectrum analyzer by triggering from the system simulator.
4. Set the CCDF (Complementary Cumulative Distribution Function) option of the spectrum analyzer.
5. Record the maximum PAPR level associated with a probability of 0.1%.



3.4 99% Occupied Bandwidth and 26dB Bandwidth Measurement

3.4.1 Description of 99% Occupied Bandwidth and 26dB Bandwidth Measurement

The occupied bandwidth is the width of a frequency band such that, below the lower and above the upper frequency limits, the mean powers emitted are each equal to a specified percentage 0.5% of the total mean transmitted power.

The 26 dB emission bandwidth is defined as the frequency range between two points, one above and one below the carrier frequency, at which the spectral density of the emission is attenuated 26 dB below the maximum in-band spectral density of the modulated signal. Spectral density (power per unit bandwidth) is to be measured with a detector of resolution bandwidth equal to approximately 1.0% of the emission bandwidth.

3.4.2 Test Procedures

The testing follows ANSI C63.26-2015 Section 5.4.3 (26dB) and Section 5.4.4 (99OB)

1. The EUT was connected to spectrum analyzer and system simulator via a power divider.
2. The spectrum analyzer center frequency is set to the nominal EUT channel center frequency. The span range for the spectrum analyzer shall be between two and five times the anticipated OBW.
3. The nominal resolution bandwidth (RBW) shall be in the range of 1 to 5 % of the anticipated OBW, and the VBW shall be at least 3 times the RBW.
4. Set the detection mode to peak, and the trace mode to max hold.
5. Determine the reference value: Set the EUT to transmit a modulated signal. Allow the trace to stabilize. Set the spectrum analyzer marker to the highest level of the displayed trace.
(this is the reference value)
6. Determine the “-26 dB down amplitude” as equal to (Reference Value – X).
7. Place two markers, one at the lowest and the other at the highest frequency of the envelope of the spectral display such that each marker is at or slightly below the “-X dB down amplitude” determined in step 6. If a marker is below this “-X dB down amplitude” value it shall be placed as close as possible to this value. The OBW is the positive frequency difference between the two markers.
8. Use the 99 % power bandwidth function of the spectrum analyzer and report the measured bandwidth.



3.5 Conducted Band Edge

3.5.1 Description of Conducted Band Edge Measurement

The power of any emission outside of the authorized operating frequency ranges must be lower than the transmitter power (P) by a factor of at least $43 + 10 \log (P)$ dB.

3.5.2 Test Procedures

The testing follows FCC KDB 971168 D01 v03r01 Section 6.1.

1. The EUT was connected to the spectrum analyzer and system simulator via a power divider.
2. The RF output of EUT was connected to the spectrum analyzer by an RF cable and attenuator. The path loss was compensated to the results for each measurement.
3. The band edges of low and high channels for the highest RF powers were measured.
4. The RF fundamental frequency should be excluded against the limit line in the operating frequency band.
5. The limit line is derived from $43 + 10\log(P)$ dB below the transmitter power P(Watts)



3.6 Conducted Spurious Emission

3.6.1 Description of Conducted Spurious Emission Measurement

The power of any emission outside of the authorized operating frequency ranges must be lower than the transmitter power (P) by a factor of at least $43 + 10 \log (P)$ dB.

It is measured by means of a calibrated spectrum analyzer and scanned from 30 MHz up to a frequency including its 10th harmonic.

3.6.2 Test Procedures

The testing follows FCC KDB 971168 D01 v03r01 Section 6.1.

1. The EUT was connected to the spectrum analyzer and system simulator via a power divider.
2. The RF output of EUT was connected to the spectrum analyzer by an RF cable and attenuator.
The path loss was compensated to the results for each measurement.
3. The middle channel for the highest RF power within the transmitting frequency was measured.
4. The conducted spurious emission for the whole frequency range was taken.
5. The RF fundamental frequency should be excluded against the limit line in the operating frequency band.
6. The limit line is derived from $43 + 10\log(P)$ dB below the transmitter power P(Watts)



3.7 Frequency Stability

3.7.1 Description of Frequency Stability Measurement

22.355

The frequency stability shall be measured by variation of ambient temperature and variation of primary supply voltage to ensure that the fundamental emission stays within the authorized frequency block. The frequency stability of the transmitter shall be maintained within $\pm 0.00025\%$ ($\pm 2.5\text{ppm}$) of the center frequency.

24.235

The frequency stability shall be sufficient to ensure that the fundamental emission stays within the authorized frequency block.

3.7.2 Test Procedures for Temperature Variation

The testing follows FCC KDB 971168 D01 v03r01 Section 9.0.

1. The EUT was set up in the thermal chamber and connected with the system simulator.
2. With power OFF, the temperature was decreased to -30°C and the EUT was stabilized before testing. Power was applied and the maximum change in frequency was recorded within one minute.
3. With power OFF, the temperature was raised in 10°C steps up to 50°C . The EUT was stabilized at each step for at least half an hour. Power was applied and the maximum frequency change was recorded within one minute.

3.7.3 Test Procedures for Voltage Variation

The testing follows FCC KDB 971168 D01 v03r01 Section 9.0.

1. The EUT was placed in a temperature chamber at $20\pm 5^{\circ}\text{C}$ and connected with the system simulator.
2. The power supply voltage to the EUT was varied from 85% to 115% of the nominal value measured at the input to the EUT.
3. The variation in frequency was measured for the worst case.

4 Radiated Test Items

4.1 Measuring Instruments

See list of measuring instruments of this test report.

4.2 Test Setup

For radiated test from 30MHz to 1GHz

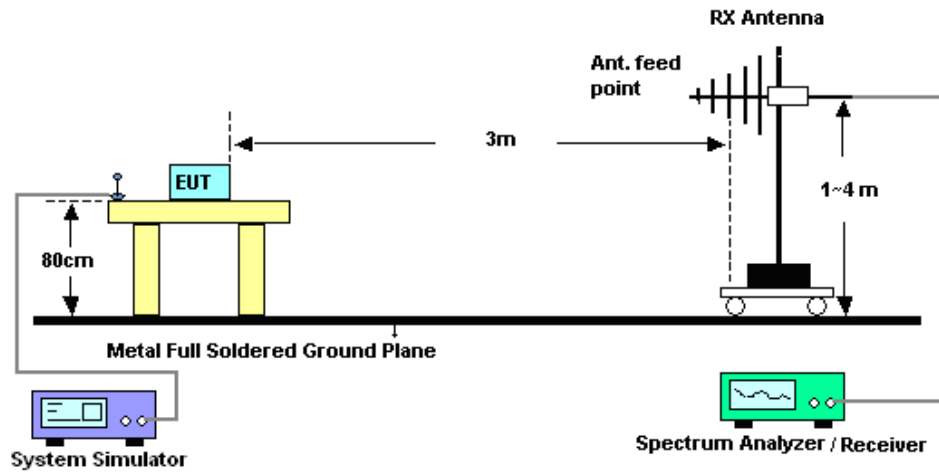

For radiated test above 1GHz

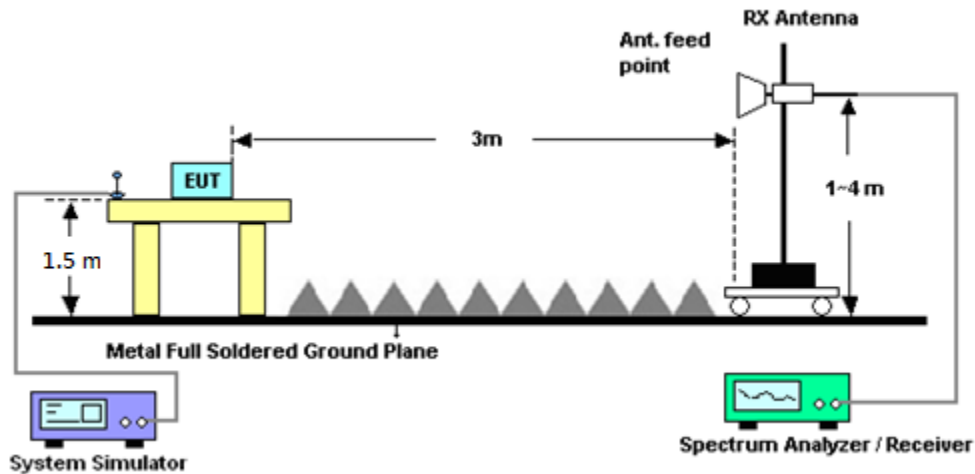

4.3 Test Result of Radiated Test

Please refer to Appendix B.



4.4 Field Strength of Spurious Radiation Measurement

4.4.1 Description of Field Strength of Spurious Radiated Measurement

The power of any emission outside of the authorized operating frequency ranges must be attenuated below the transmitter power (P) by a factor of at least $43 + 10 \log (P)$ dB. The spectrum is scanned from 30 MHz up to a frequency including its 10th harmonic.

4.4.2 Test Procedures

The testing follows FCC KDB 971168 D01 v03r01 Section 7 and ANSI / TIA-603-E Section 2.2.12.

1. The EUT was placed on a rotatable wooden table 0.8 meters for frequency below 1GHz and 1.5 meter for frequency above 1GHz above the ground.
2. The EUT was set 3 meters from the receiving antenna, which was mounted on the antenna tower.
3. The table was rotated 360 degrees to determine the position of the highest spurious emission.
4. The height of the receiving antenna is varied between one meter and four meters to search for the maximum spurious emission for both horizontal and vertical polarizations.
5. Make the measurement with the spectrum analyzer's RBW = 1MHz, VBW = 3MHz, taking record of maximum spurious emission.
6. A horn antenna was substituted in place of the EUT and was driven by a signal generator.
7. Tune the output power of signal generator to the same emission level with EUT maximum spurious emission.
8. Taking the record of output power at antenna port.
9. Repeat step 7 to step 8 for another polarization.
10. $EIRP (dBm) = S.G. Power - Tx Cable Loss + Tx Antenna Gain$
 $ERP (dBm) = EIRP - 2.15$
11. The RF fundamental frequency should be excluded against the limit line in the operating frequency band.
12. The limit line is derived from $43 + 10\log(P)$ dB below the transmitter power P(Watts)



5 List of Measuring Equipment

| Instrument | Manufacturer | Model No. | Serial No. | Characteristics | Calibration Date | Test Date | Due Date | Remark |
|---------------------------|-----------------|----------------------------|-------------|---------------------------|------------------|------------------------------|---------------|-----------------------|
| Base Station (Measure) | Rohde & Schwarz | CMU200 | 117995 | GSM / GPRS / WCDMA / CDMA | Aug. 23, 2019 | Dec. 10, 2019~ Dec. 11, 2019 | Aug. 22, 2020 | Conducted (TH03-HY) |
| Spectrum Analyzer | Rohde & Schwarz | FSP30 | 101329 | 9kHz~30GHz | Sep. 04, 2019 | Dec. 10, 2019~ Dec. 11, 2019 | Sep. 03, 2020 | Conducted (TH03-HY) |
| Temperature Chamber | ESPEC | SU-641 | 92013721 | -30°C ~70°C | Nov. 26, 2019 | Dec. 10, 2019~ Dec. 11, 2019 | Nov. 25, 2020 | Conducted (TH03-HY) |
| Programmable Power Supply | GW Instek | PSS-2005 | EL890001 | 1V~20V 0.5A~4A | Oct. 09, 2019 | Dec. 10, 2019~ Dec. 11, 2019 | Oct. 08, 2020 | Conducted (TH03-HY) |
| Power Divider | Warison | WCOU-0.4-26.5S-20 | #A | N/A | Nov. 06, 2019 | Dec. 10, 2019~ Dec. 11, 2019 | Nov. 05, 2020 | Conducted (TH03-HY) |
| Hygrometer | Testo | 608-H1 | 34893241 | N/A | Mar. 06, 2019 | Dec. 10, 2019~ Dec. 11, 2019 | Mar. 05, 2020 | Conducted (TH03-HY) |
| Loop Antenna | Rohde & Schwarz | HFH2-Z2 | 100488 | 9 kHz~30 MHz | Jan. 07, 2019 | Dec. 31, 2019~ Jan. 02, 2020 | Jan. 06, 2020 | Radiation (03CH12-HY) |
| Bilog Antenna | TESEQ | CBL 6111D & 00800N1D01N-06 | 41912 & 05 | 30MHz~1GHz | Feb. 12, 2019 | Dec. 31, 2019~ Jan. 02, 2020 | Feb. 11, 2020 | Radiation (03CH12-HY) |
| Horn Antenna | SCHWARZBECK | BBHA 9120D | 9120D-1328 | 1GHz ~ 18GHz | Nov. 14, 2019 | Dec. 31, 2019~ Jan. 02, 2020 | Nov. 13, 2020 | Radiation (03CH12-HY) |
| Horn Antenna | SCHWARZBECK | BBHA 9120D | 9120D-1522 | 1GHz ~ 18GHz | Sep. 19, 2019 | Dec. 31, 2019~ Jan. 02, 2020 | Sep. 18, 2020 | Radiation (03CH12-HY) |
| SHF-EHF Horn Antenna | SCHWARZBECK | BBHA 9170 | BBHA9170584 | 18GHz ~ 40GHz | Dec. 10, 2019 | Dec. 31, 2019~ Jan. 02, 2020 | Dec. 09, 2020 | Radiation (03CH12-HY) |
| Preamplifier | COM-POWER | PA-103 | 161075 | 10MHz~1GHz | Mar. 25, 2019 | Dec. 31, 2019~ Jan. 02, 2020 | Mar. 24, 2020 | Radiation (03CH12-HY) |
| Preamplifier | Jet-Power | JPA00101800-30-10P | 1601180002 | 1GHz~18GHz | Aug. 01, 2019 | Dec. 31, 2019~ Jan. 02, 2020 | Jul. 01, 2020 | Radiation (03CH12-HY) |
| Preamplifier | EMEC | EM18G40G | 060715 | 18GHz ~ 40GHz | Dec. 13, 2019 | Dec. 31, 2019~ Jan. 02, 2020 | Dec. 12, 2020 | Radiation (03CH12-HY) |
| Preamplifier | Agilent | 8449B | 3008A02375 | 1GHz~26.5GHz | May 27, 2019 | Dec. 31, 2019~ Jan. 02, 2020 | May 26, 2020 | Radiation (03CH12-HY) |
| EMI Test Receiver | Agilent | N9038A(MXE) | MY53290045 | 20MHz~8.4GHz | Jan. 19, 2019 | Dec. 31, 2019~ Jan. 02, 2020 | Jan. 18, 2020 | Radiation (03CH12-HY) |
| Spectrum Analyzer | Keysight | N9010A | MY55370526 | 10Hz~44GHz | Mar. 19, 2019 | Dec. 31, 2019~ Jan. 02, 2020 | Mar. 18, 2020 | Radiation (03CH12-HY) |
| Signal Generator | Rohde & Schwarz | SMB100A | 101107 | 100kHz~40GHz | Aug. 27, 2019 | Dec. 31, 2019~ Jan. 02, 2020 | Aug. 26, 2020 | Radiation (03CH12-HY) |
| Hygrometer | TECPEL | DTM-303B | TP161243 | N/A | May 11, 2019 | Dec. 31, 2019~ Jan. 02, 2020 | May 10, 2020 | Radiation (03CH12-HY) |



| Instrument | Manufacturer | Model No. | Serial No. | Characteristics | Calibration Date | Test Date | Due Date | Remark |
|--------------|----------------|--------------------------------|------------|-------------------------------|------------------|-----------------------------|---------------|-----------------------|
| Notch Filter | Wainwright | WRCG1710/1755-1690/1775-45/7SS | SN2 | AWS Band | Nov. 05, 2019 | Dec. 31, 2019~Jan. 02, 2020 | Nov. 04, 2020 | Radiation (03CH12-HY) |
| Notch Filter | Wainwright | WRCT2500/2570-10/40-10SS K | SN1 R | LTE Band 7 | Aug. 22, 2019 | Dec. 31, 2019~Jan. 02, 2020 | Aug. 21, 2020 | Radiation (03CH12-HY) |
| Filter | Wainwright | WLKS1200-12SS | SN2 | 1.2GHz Low Pass | Mar. 22, 2019 | Dec. 31, 2019~Jan. 02, 2020 | Mar. 21, 2020 | Radiation (03CH12-HY) |
| Filter | Wainwright | WHKX12-1080-1200-1500-60ST | SN1 | 1.2G High Pass | Mar. 19, 2019 | Dec. 31, 2019~Jan. 02, 2020 | Mar. 18, 2020 | Radiation (03CH12-HY) |
| Filter | Wainwright | WHKX12-2700-3000-18000-60ST | SN2 | 3G High Pass | Jul. 15, 2019 | Dec. 31, 2019~Jan. 02, 2020 | Jul. 14, 2020 | Radiation (03CH12-HY) |
| Filter | Wainwright | WHKX12-2700-3000-18000-60ST | SN2 | 3G High Pass | Jul. 15, 2019 | Dec. 31, 2019~Jan. 02, 2020 | Jul. 14, 2020 | Radiation (03CH12-HY) |
| RF Cable | HUBER + SUHNER | SUCOFLEX 126E | 0058/126E | 30M-18G | Mar. 13, 2019 | Dec. 31, 2019~Jan. 02, 2020 | Mar. 12, 2020 | Radiation (03CH12-HY) |
| RF Cable | HUBER + SUHNER | SUCOFLEX 102 | 505134/2 | 30M~40GHz | Feb. 26, 2019 | Dec. 31, 2019~Jan. 02, 2020 | Feb. 25, 2020 | Radiation (03CH12-HY) |
| RF Cable | HUBER + SUHNER | SUCOFLEX 102 | 800740/2 | 30M~40GHz | Feb. 26, 2019 | Dec. 31, 2019~Jan. 02, 2020 | Feb. 25, 2020 | Radiation (03CH12-HY) |
| Controller | EMEC | EM1000 | N/A | Control Turn table & Ant Mast | N/A | Dec. 31, 2019~Jan. 02, 2020 | N/A | Radiation (03CH12-HY) |
| Antenna Mast | EMEC | AM-BS-4500-B | N/A | 1m~4m | N/A | Dec. 31, 2019~Jan. 02, 2020 | N/A | Radiation (03CH12-HY) |
| Turn Table | EMEC | TT2000 | N/A | 0~360 Degree | N/A | Dec. 31, 2019~Jan. 02, 2020 | N/A | Radiation (03CH12-HY) |
| Software | Audix | E3 6.2009-8-24 | RK-000989 | N/A | N/A | Dec. 31, 2019~Jan. 02, 2020 | N/A | Radiation (03CH12-HY) |



6 Uncertainty of Evaluation

Uncertainty of Radiated Emission Measurement (30 MHz ~ 1000 MHz)

| | |
|---|------|
| Measuring Uncertainty for a Level of Confidence of 95% ($U = 2Uc(y)$) | 3.24 |
|---|------|

Uncertainty of Radiated Emission Measurement (1 GHz ~ 18 GHz)

| | |
|---|------|
| Measuring Uncertainty for a Level of Confidence of 95% ($U = 2Uc(y)$) | 3.62 |
|---|------|

Uncertainty of Radiated Emission Measurement (18 GHz ~ 40 GHz)

| | |
|---|------|
| Measuring Uncertainty for a Level of Confidence of 95% ($U = 2Uc(y)$) | 4.06 |
|---|------|



Appendix A. Test Results of Conducted Test

Conducted Output Power(Average power)

| Conducted Power (*Unit: dBm) | | | | | | |
|------------------------------|--------|-------|-------|---------|-------|--------|
| Band | GSM850 | | | GSM1900 | | |
| Channel | 128 | 189 | 251 | 512 | 661 | 810 |
| Frequency | 824.2 | 836.4 | 848.8 | 1850.2 | 1880 | 1909.8 |
| GSM | 33.12 | 33.15 | 33.16 | 24.98 | 24.90 | 25.05 |
| GPRS class 8 | 33.16 | 33.18 | 33.19 | 25.00 | 24.89 | 25.06 |
| GPRS class 10 | 29.93 | 29.83 | 29.78 | 24.30 | 24.20 | 24.38 |
| GPRS class 11 | 28.57 | 28.60 | 28.57 | 22.35 | 22.32 | 22.51 |
| GPRS class 12 | 26.85 | 26.98 | 27.03 | 21.35 | 21.32 | 21.51 |
| EGPRS class 8 | 27.03 | 26.94 | 26.96 | 24.84 | 24.81 | 24.92 |
| EGPRS class 10 | 25.85 | 25.65 | 25.65 | 23.76 | 23.66 | 23.74 |
| EGPRS class 11 | 24.14 | 23.95 | 23.93 | 21.80 | 21.79 | 21.89 |
| EGPRS class 12 | 22.30 | 22.38 | 22.47 | 20.44 | 20.43 | 20.53 |

| Conducted Power (*Unit: dBm) | | | |
|------------------------------|--------------|-------|-------|
| Band | WCDMA Band V | | |
| Channel | 4132 | 4182 | 4233 |
| Frequency | 826.4 | 836.4 | 846.6 |
| RMC 12.2K | 23.69 | 23.64 | 23.55 |
| HSDPA Subtest-1 | 22.79 | 22.74 | 22.63 |
| HSDPA Subtest-2 | 22.82 | 22.78 | 22.73 |
| HSDPA Subtest-3 | 22.34 | 22.30 | 22.18 |
| HSDPA Subtest-4 | 22.34 | 22.26 | 22.15 |
| HSUPA Subtest-1 | 22.82 | 22.73 | 22.71 |
| HSUPA Subtest-2 | 20.78 | 20.72 | 20.64 |
| HSUPA Subtest-3 | 21.78 | 21.74 | 21.65 |
| HSUPA Subtest-4 | 20.84 | 20.72 | 20.64 |
| HSUPA Subtest-5 | 22.80 | 22.70 | 22.70 |



A2. GSM

Peak-to-Average Ratio

| Mode | GSM850 | | Limit: 13dB |
|------------|--------------|--------------|-------------|
| Mod. | GPRS class 8 | EDGE class 8 | Result |
| Lowest CH | 0.72 | 3.44 | PASS |
| Middle CH | 0.72 | 3.52 | |
| Highest CH | 0.72 | 3.48 | |

| Mode | GSM1900 | | Limit: 13dB |
|------------|--------------|--------------|-------------|
| Mod. | GPRS class 8 | EDGE class 8 | Result |
| Lowest CH | 0.44 | 3.44 | PASS |
| Middle CH | 0.40 | 3.44 | |
| Highest CH | 0.40 | 3.28 | |



| GSM850 (GPRS class 8) | GSM850 (EDGE class 8) | | | | | | | | | | | | | | | | | | | | | | | | | | | | |
|---|-----------------------|-----------|------|-----------|-------|---------|------|---------|-----|---------|------|---------|-------|---------|---|------|-----------|------|-----------|-------|---------|------|---------|-----|---------|------|---------|-------|---------|
| <p align="center">Lowest Channel</p> <p>Ref: 35 dBm, Att: 30 dB, AQT: 3.125 ms, RBW: 10 MHz, Offset: 16.4 dB</p> <p>Center: 824.2 MHz, 2 dB, Mean Pwr: +20 dB</p> <p>Complementary Cumulative Distribution Function (100000 samples)</p> <p>Trace 1</p> <table border="1"> <tr><td>Mean</td><td>33.50 dBm</td></tr> <tr><td>Peak</td><td>34.26 dBm</td></tr> <tr><td>Crest</td><td>0.76 dB</td></tr> </table> <table border="1"> <tr><td>10 %</td><td>0.52 dB</td></tr> <tr><td>1 %</td><td>0.68 dB</td></tr> <tr><td>.1 %</td><td>0.72 dB</td></tr> <tr><td>.01 %</td><td>0.76 dB</td></tr> </table> <p>Date: 11.DEC.2019 09:41:26</p> | Mean | 33.50 dBm | Peak | 34.26 dBm | Crest | 0.76 dB | 10 % | 0.52 dB | 1 % | 0.68 dB | .1 % | 0.72 dB | .01 % | 0.76 dB | <p align="center">Lowest Channel</p> <p>Ref: 35 dBm, Att: 30 dB, AQT: 3.125 ms, RBW: 10 MHz, Offset: 16.4 dB</p> <p>Center: 824.2 MHz, 2 dB, Mean Pwr: +20 dB</p> <p>Complementary Cumulative Distribution Function (100000 samples)</p> <p>Trace 1</p> <table border="1"> <tr><td>Mean</td><td>27.83 dBm</td></tr> <tr><td>Peak</td><td>31.37 dBm</td></tr> <tr><td>Crest</td><td>3.55 dB</td></tr> </table> <table border="1"> <tr><td>10 %</td><td>2.56 dB</td></tr> <tr><td>1 %</td><td>3.20 dB</td></tr> <tr><td>.1 %</td><td>3.44 dB</td></tr> <tr><td>.01 %</td><td>3.48 dB</td></tr> </table> <p>Date: 10.DEC.2019 17:39:37</p> | Mean | 27.83 dBm | Peak | 31.37 dBm | Crest | 3.55 dB | 10 % | 2.56 dB | 1 % | 3.20 dB | .1 % | 3.44 dB | .01 % | 3.48 dB |
| Mean | 33.50 dBm | | | | | | | | | | | | | | | | | | | | | | | | | | | | |
| Peak | 34.26 dBm | | | | | | | | | | | | | | | | | | | | | | | | | | | | |
| Crest | 0.76 dB | | | | | | | | | | | | | | | | | | | | | | | | | | | | |
| 10 % | 0.52 dB | | | | | | | | | | | | | | | | | | | | | | | | | | | | |
| 1 % | 0.68 dB | | | | | | | | | | | | | | | | | | | | | | | | | | | | |
| .1 % | 0.72 dB | | | | | | | | | | | | | | | | | | | | | | | | | | | | |
| .01 % | 0.76 dB | | | | | | | | | | | | | | | | | | | | | | | | | | | | |
| Mean | 27.83 dBm | | | | | | | | | | | | | | | | | | | | | | | | | | | | |
| Peak | 31.37 dBm | | | | | | | | | | | | | | | | | | | | | | | | | | | | |
| Crest | 3.55 dB | | | | | | | | | | | | | | | | | | | | | | | | | | | | |
| 10 % | 2.56 dB | | | | | | | | | | | | | | | | | | | | | | | | | | | | |
| 1 % | 3.20 dB | | | | | | | | | | | | | | | | | | | | | | | | | | | | |
| .1 % | 3.44 dB | | | | | | | | | | | | | | | | | | | | | | | | | | | | |
| .01 % | 3.48 dB | | | | | | | | | | | | | | | | | | | | | | | | | | | | |
| <p align="center">Middle Channel</p> <p>Ref: 35 dBm, Att: 30 dB, AQT: 3.125 ms, RBW: 10 MHz, Offset: 16.4 dB</p> <p>Center: 836.4 MHz, 2 dB, Mean Pwr: +20 dB</p> <p>Complementary Cumulative Distribution Function (100000 samples)</p> <p>Trace 1</p> <table border="1"> <tr><td>Mean</td><td>33.63 dBm</td></tr> <tr><td>Peak</td><td>34.33 dBm</td></tr> <tr><td>Crest</td><td>0.70 dB</td></tr> </table> <table border="1"> <tr><td>10 %</td><td>0.48 dB</td></tr> <tr><td>1 %</td><td>0.68 dB</td></tr> <tr><td>.1 %</td><td>0.72 dB</td></tr> <tr><td>.01 %</td><td>0.72 dB</td></tr> </table> <p>Date: 11.DEC.2019 09:41:46</p> | Mean | 33.63 dBm | Peak | 34.33 dBm | Crest | 0.70 dB | 10 % | 0.48 dB | 1 % | 0.68 dB | .1 % | 0.72 dB | .01 % | 0.72 dB | <p align="center">Middle Channel</p> <p>Ref: 35 dBm, Att: 30 dB, AQT: 3.125 ms, RBW: 10 MHz, Offset: 16.4 dB</p> <p>Center: 836.4 MHz, 2 dB, Mean Pwr: +20 dB</p> <p>Complementary Cumulative Distribution Function (100000 samples)</p> <p>Trace 1</p> <table border="1"> <tr><td>Mean</td><td>27.57 dBm</td></tr> <tr><td>Peak</td><td>31.16 dBm</td></tr> <tr><td>Crest</td><td>3.59 dB</td></tr> </table> <table border="1"> <tr><td>10 %</td><td>2.56 dB</td></tr> <tr><td>1 %</td><td>3.36 dB</td></tr> <tr><td>.1 %</td><td>3.52 dB</td></tr> <tr><td>.01 %</td><td>3.60 dB</td></tr> </table> <p>Date: 10.DEC.2019 17:39:49</p> | Mean | 27.57 dBm | Peak | 31.16 dBm | Crest | 3.59 dB | 10 % | 2.56 dB | 1 % | 3.36 dB | .1 % | 3.52 dB | .01 % | 3.60 dB |
| Mean | 33.63 dBm | | | | | | | | | | | | | | | | | | | | | | | | | | | | |
| Peak | 34.33 dBm | | | | | | | | | | | | | | | | | | | | | | | | | | | | |
| Crest | 0.70 dB | | | | | | | | | | | | | | | | | | | | | | | | | | | | |
| 10 % | 0.48 dB | | | | | | | | | | | | | | | | | | | | | | | | | | | | |
| 1 % | 0.68 dB | | | | | | | | | | | | | | | | | | | | | | | | | | | | |
| .1 % | 0.72 dB | | | | | | | | | | | | | | | | | | | | | | | | | | | | |
| .01 % | 0.72 dB | | | | | | | | | | | | | | | | | | | | | | | | | | | | |
| Mean | 27.57 dBm | | | | | | | | | | | | | | | | | | | | | | | | | | | | |
| Peak | 31.16 dBm | | | | | | | | | | | | | | | | | | | | | | | | | | | | |
| Crest | 3.59 dB | | | | | | | | | | | | | | | | | | | | | | | | | | | | |
| 10 % | 2.56 dB | | | | | | | | | | | | | | | | | | | | | | | | | | | | |
| 1 % | 3.36 dB | | | | | | | | | | | | | | | | | | | | | | | | | | | | |
| .1 % | 3.52 dB | | | | | | | | | | | | | | | | | | | | | | | | | | | | |
| .01 % | 3.60 dB | | | | | | | | | | | | | | | | | | | | | | | | | | | | |
| <p align="center">Highest Channel</p> <p>Ref: 35 dBm, Att: 30 dB, AQT: 3.125 ms, RBW: 10 MHz, Offset: 16.4 dB</p> <p>Center: 848.8 MHz, 2 dB, Mean Pwr: +20 dB</p> <p>Complementary Cumulative Distribution Function (100000 samples)</p> <p>Trace 1</p> <table border="1"> <tr><td>Mean</td><td>33.78 dBm</td></tr> <tr><td>Peak</td><td>34.48 dBm</td></tr> <tr><td>Crest</td><td>0.70 dB</td></tr> </table> <table border="1"> <tr><td>10 %</td><td>0.48 dB</td></tr> <tr><td>1 %</td><td>0.64 dB</td></tr> <tr><td>.1 %</td><td>0.72 dB</td></tr> <tr><td>.01 %</td><td>0.72 dB</td></tr> </table> <p>Date: 11.DEC.2019 09:42:06</p> | Mean | 33.78 dBm | Peak | 34.48 dBm | Crest | 0.70 dB | 10 % | 0.48 dB | 1 % | 0.64 dB | .1 % | 0.72 dB | .01 % | 0.72 dB | <p align="center">Highest Channel</p> <p>Ref: 35 dBm, Att: 30 dB, AQT: 3.125 ms, RBW: 10 MHz, Offset: 16.4 dB</p> <p>Center: 848.8 MHz, 2 dB, Mean Pwr: +20 dB</p> <p>Complementary Cumulative Distribution Function (100000 samples)</p> <p>Trace 1</p> <table border="1"> <tr><td>Mean</td><td>27.83 dBm</td></tr> <tr><td>Peak</td><td>31.44 dBm</td></tr> <tr><td>Crest</td><td>3.62 dB</td></tr> </table> <table border="1"> <tr><td>10 %</td><td>2.60 dB</td></tr> <tr><td>1 %</td><td>3.24 dB</td></tr> <tr><td>.1 %</td><td>3.48 dB</td></tr> <tr><td>.01 %</td><td>3.56 dB</td></tr> </table> <p>Date: 10.DEC.2019 17:40:02</p> | Mean | 27.83 dBm | Peak | 31.44 dBm | Crest | 3.62 dB | 10 % | 2.60 dB | 1 % | 3.24 dB | .1 % | 3.48 dB | .01 % | 3.56 dB |
| Mean | 33.78 dBm | | | | | | | | | | | | | | | | | | | | | | | | | | | | |
| Peak | 34.48 dBm | | | | | | | | | | | | | | | | | | | | | | | | | | | | |
| Crest | 0.70 dB | | | | | | | | | | | | | | | | | | | | | | | | | | | | |
| 10 % | 0.48 dB | | | | | | | | | | | | | | | | | | | | | | | | | | | | |
| 1 % | 0.64 dB | | | | | | | | | | | | | | | | | | | | | | | | | | | | |
| .1 % | 0.72 dB | | | | | | | | | | | | | | | | | | | | | | | | | | | | |
| .01 % | 0.72 dB | | | | | | | | | | | | | | | | | | | | | | | | | | | | |
| Mean | 27.83 dBm | | | | | | | | | | | | | | | | | | | | | | | | | | | | |
| Peak | 31.44 dBm | | | | | | | | | | | | | | | | | | | | | | | | | | | | |
| Crest | 3.62 dB | | | | | | | | | | | | | | | | | | | | | | | | | | | | |
| 10 % | 2.60 dB | | | | | | | | | | | | | | | | | | | | | | | | | | | | |
| 1 % | 3.24 dB | | | | | | | | | | | | | | | | | | | | | | | | | | | | |
| .1 % | 3.48 dB | | | | | | | | | | | | | | | | | | | | | | | | | | | | |
| .01 % | 3.56 dB | | | | | | | | | | | | | | | | | | | | | | | | | | | | |



| GSM1900 (GPRS class 8) | GSM1900 (EDGE class 8) |
|---|---|
| <p align="center">Lowest Channel</p> <p align="center">Date: 11.DEC.2019 09:23:41</p> | <p align="center">Lowest Channel</p> <p align="center">Date: 10.DEC.2019 17:26:55</p> |
| <p align="center">Middle Channel</p> <p align="center">Date: 11.DEC.2019 09:24:04</p> | <p align="center">Middle Channel</p> <p align="center">Date: 10.DEC.2019 17:27:09</p> |
| <p align="center">Highest Channel</p> <p align="center">Date: 11.DEC.2019 09:24:17</p> | <p align="center">Highest Channel</p> <p align="center">Date: 10.DEC.2019 17:27:23</p> |



26dB Bandwidth

| Mode | GSM850: 26dB BW (MHz) | |
|------------|-----------------------|--------------|
| Mod. | GPRS class 8 | EDGE class 8 |
| Lowest CH | 0.303 | 0.295 |
| Middle CH | 0.316 | 0.299 |
| Highest CH | 0.312 | 0.304 |

| Mode | GSM1900: 26dB BW (MHz) | |
|------------|------------------------|--------------|
| Mod. | GPRS class 8 | EDGE class 8 |
| Lowest CH | 0.307 | 0.311 |
| Middle CH | 0.314 | 0.301 |
| Highest CH | 0.315 | 0.305 |

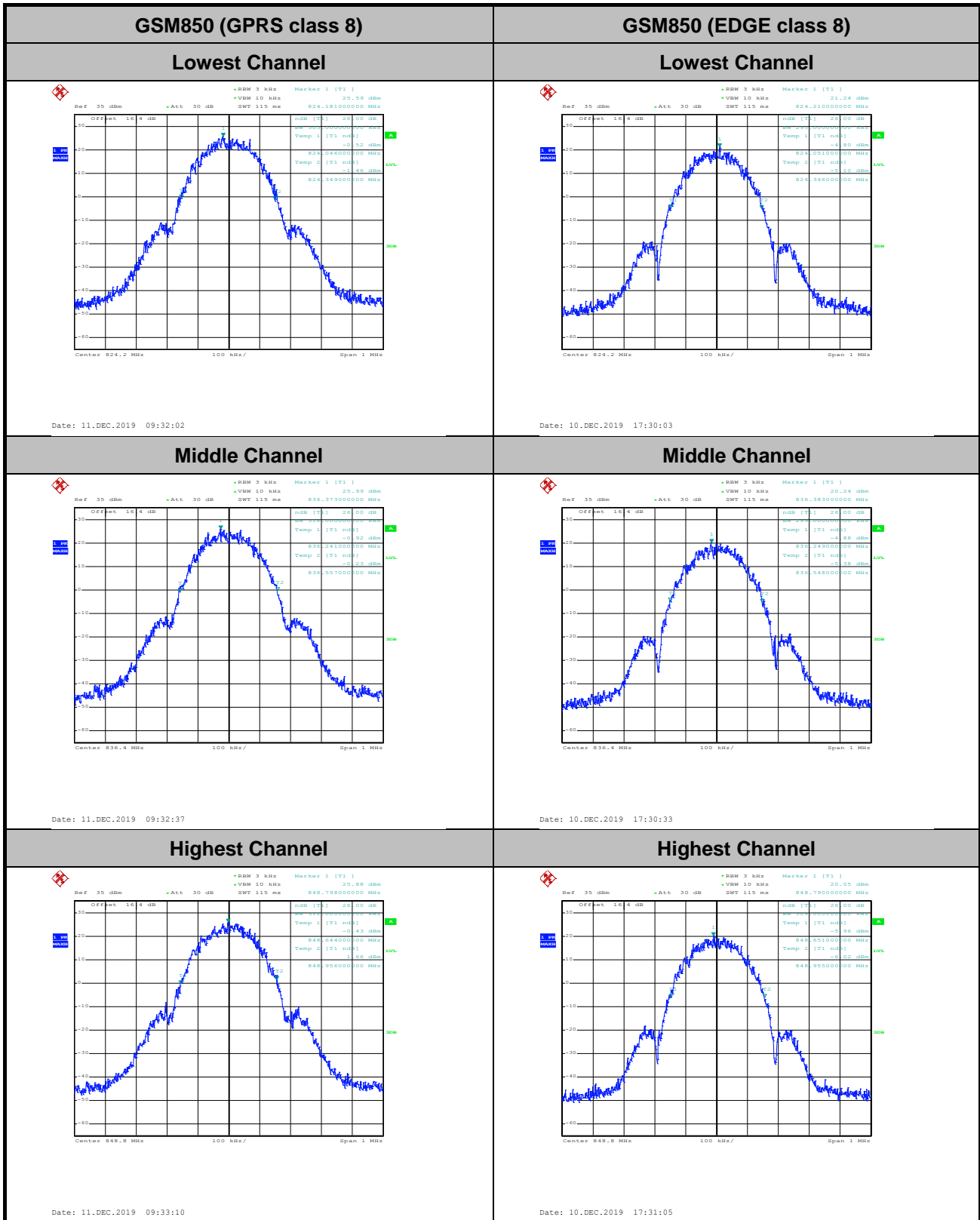



GSM1900 (GPRS class 8)

Lowest Channel

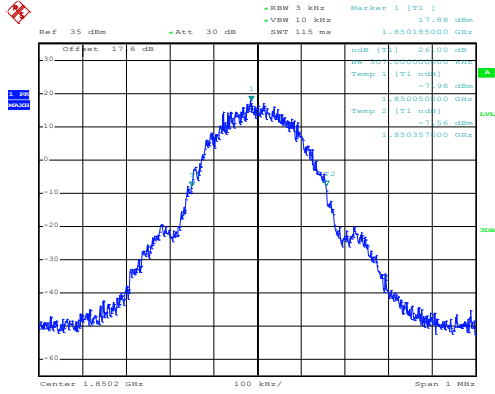

Date: 11.DEC.2019 09:13:07

GSM1900 (EDGE class 8)

Lowest Channel

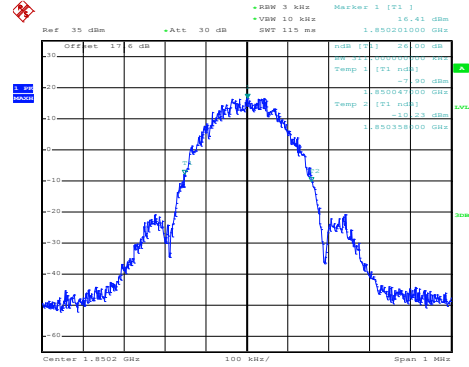

Date: 10.DEC.2019 17:17:42

Middle Channel

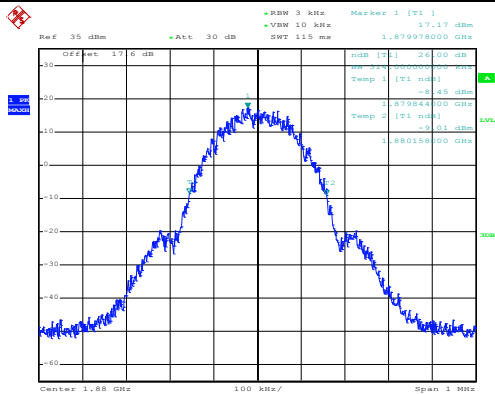

Date: 11.DEC.2019 09:15:07

Middle Channel

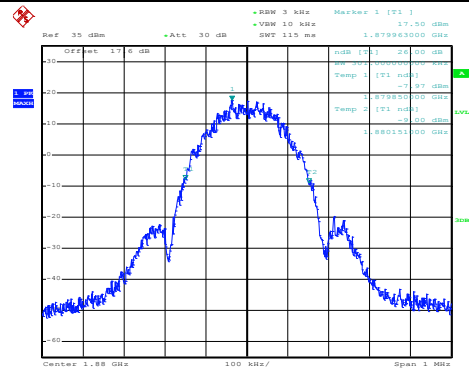

Date: 10.DEC.2019 17:18:17

Highest Channel

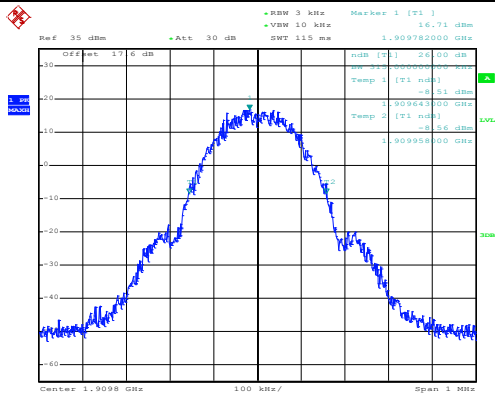

Date: 11.DEC.2019 09:15:40

Highest Channel

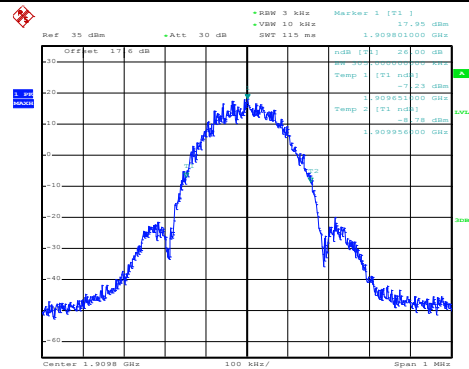

Date: 10.DEC.2019 17:18:50



Occupied Bandwidth

| Mode | GSM850: 99% OBW (MHz) | |
|------------|-----------------------|--------------|
| Mod. | GPRS class 8 | EDGE class 8 |
| Lowest CH | 0.249 | 0.245 |
| Middle CH | 0.245 | 0.245 |
| Highest CH | 0.244 | 0.246 |

| Mode | GSM1900: 99% OBW (MHz) | |
|------------|------------------------|--------------|
| Mod. | GPRS class 8 | EDGE class 8 |
| Lowest CH | 0.245 | 0.243 |
| Middle CH | 0.244 | 0.244 |
| Highest CH | 0.244 | 0.245 |

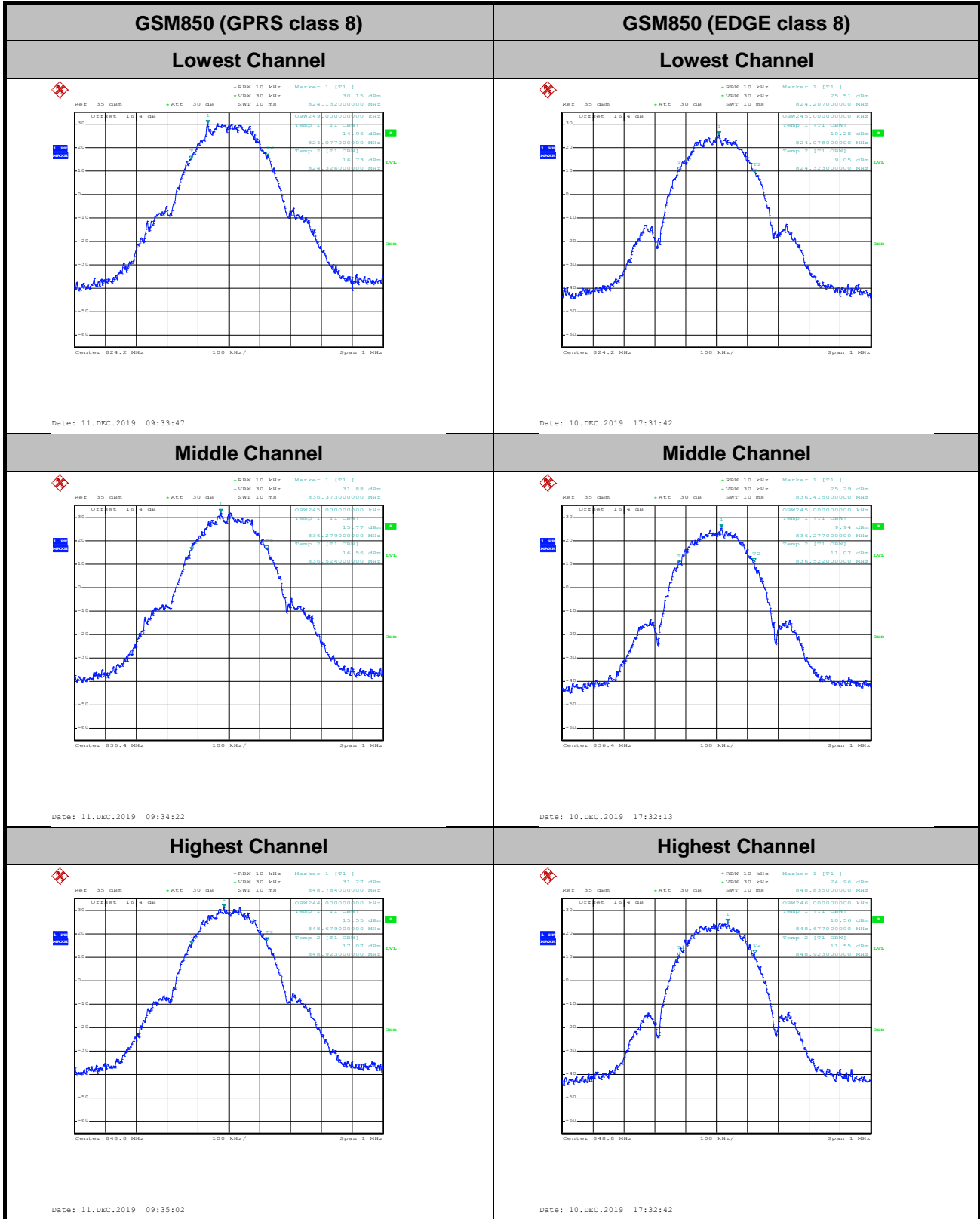

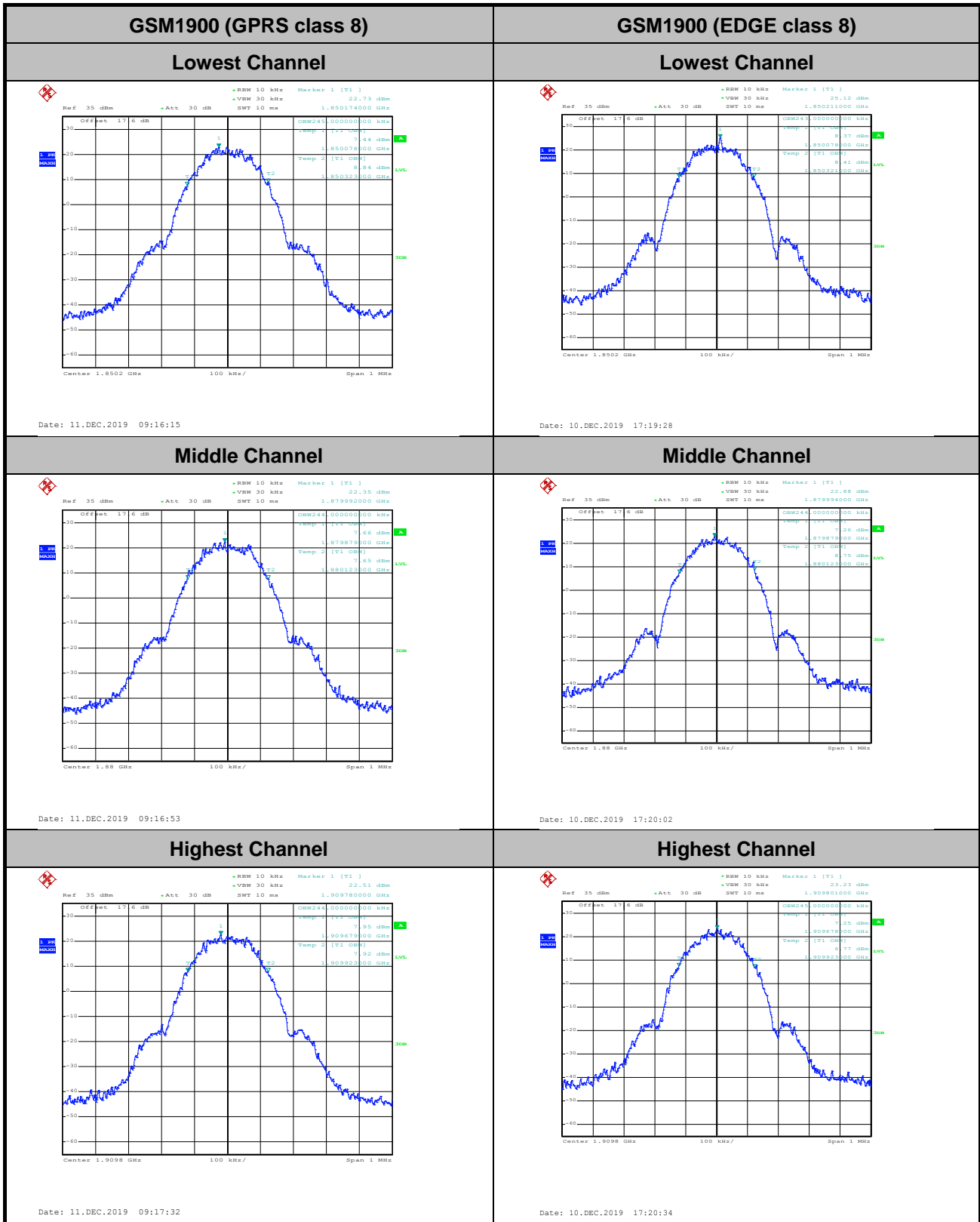



Conducted Band Edge

GSM850 (GPRS class 8)

Lowest Band Edge

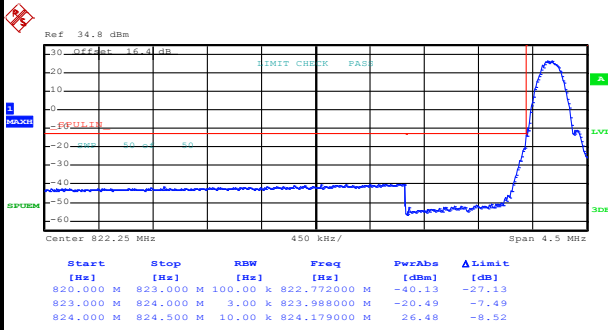

Date: 11.DEC.2019 09:36:41

Highest Band Edge

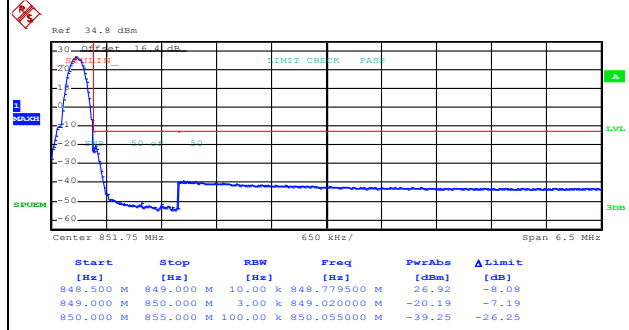

Date: 11.DEC.2019 09:38:16

GSM850 (EDGE class 8)

Lowest Band Edge

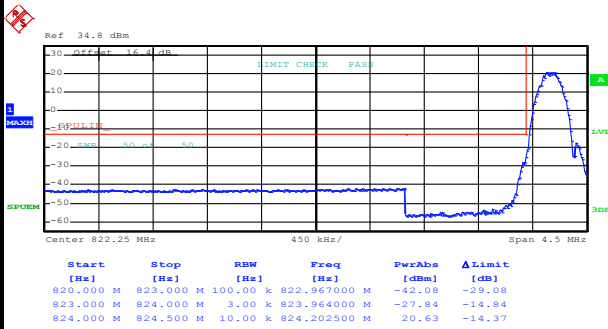

Date: 10.DEC.2019 17:34:14

Highest Band Edge

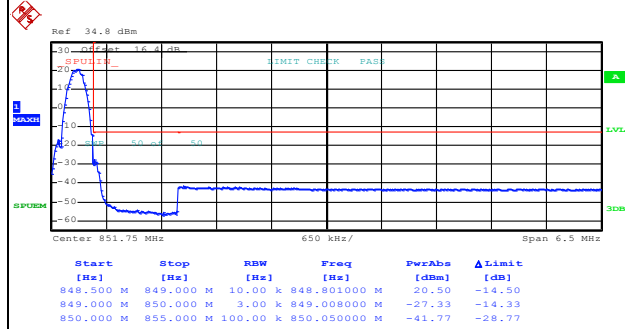

Date: 10.DEC.2019 17:36:46



GSM1900 (GPRS class 8)

Lowest Band Edge

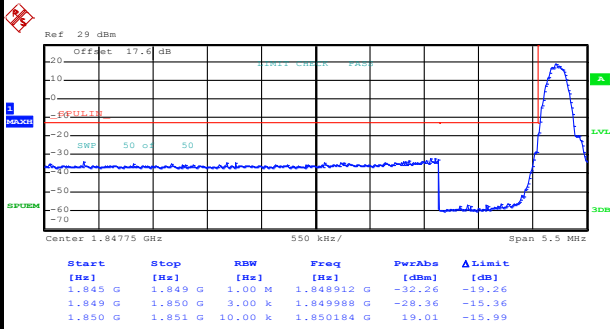

Date: 11.DEC.2019 09:19:06

Highest Band Edge

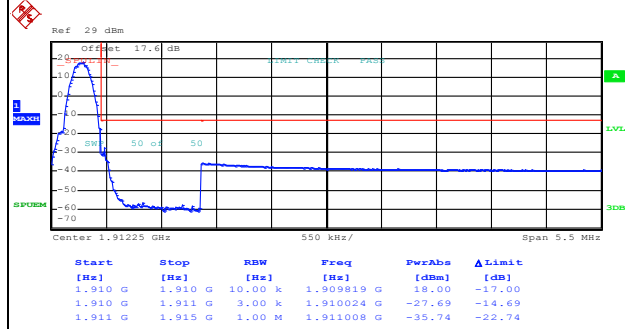

Date: 11.DEC.2019 09:20:40

GSM1900 (EDGE class 8)

Lowest Band Edge

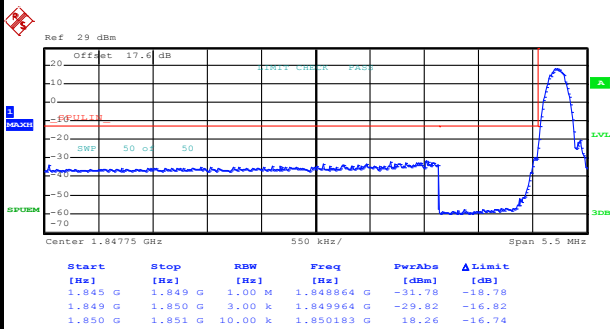

Date: 10.DEC.2019 17:22:08

Highest Band Edge

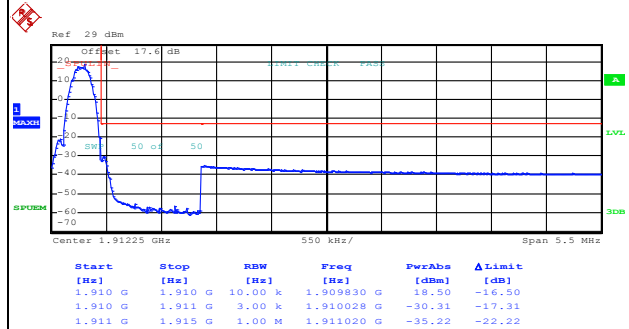

Date: 10.DEC.2019 17:23:41

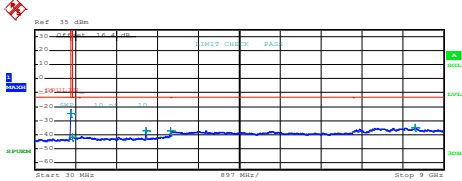
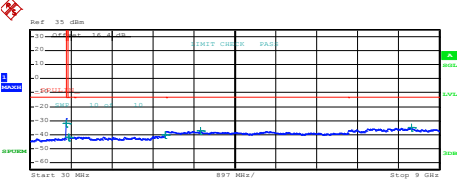
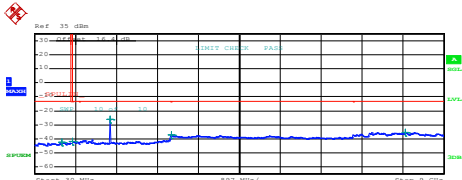
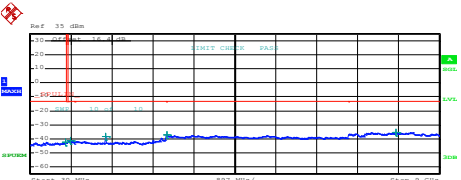
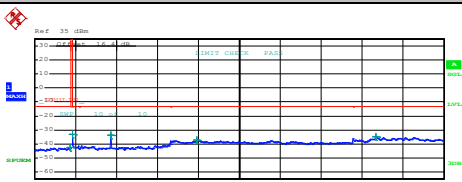
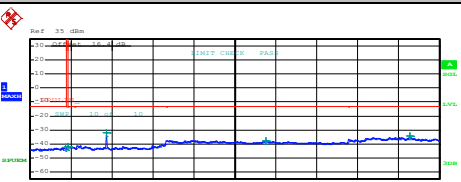

Conducted Spurious Emission

| GSM850 (GPRS class 8) | GSM850 (EDGE class 8) | | | | | | | | | | | | | | | | | | | | | | | | | | | | | | | | | | | | | | | | | | | | | | | | | | | | | | | | | | | | | | | | | | | | | | | | | | | | | | | | | | | | |
|--|-----------------------|---------|--------------|--------|--------|--------|------|------|------|------|-------|------|----------|-----------|---------|--------------|--------|--------|-----------|---------|---------|--------------|--------|--------|---------|---------|---------|------------|--------|--------|---------|---------|---------|------------|--------|--------|---------|---------|---------|------------|--------|--------|---|-------|------|-----|------|--------|--------|------|------|------|------|-------|------|----------|-----------|---------|--------------|--------|--------|-----------|---------|---------|--------------|--------|--------|---------|---------|---------|------------|--------|--------|---------|---------|---------|------------|--------|--------|---------|---------|---------|------------|--------|--------|
| <p align="center">Lowest Channel</p>  <table border="1"> <thead> <tr> <th>Start</th> <th>Stop</th> <th>RBW</th> <th>Freq</th> <th>PwrAve</th> <th>ΔLimit</th> </tr> <tr> <th>[Hz]</th> <th>[Hz]</th> <th>[Hz]</th> <th>[Hz]</th> <th>[dBm]</th> <th>[dB]</th> </tr> </thead> <tbody> <tr> <td>30,000 M</td> <td>820,000 M</td> <td>1,000 M</td> <td>819,802500 M</td> <td>-24.66</td> <td>-11.66</td> </tr> <tr> <td>855,000 M</td> <td>1,000 G</td> <td>1,000 M</td> <td>855,688750 M</td> <td>-42.02</td> <td>-29.02</td> </tr> <tr> <td>1,000 G</td> <td>3,000 G</td> <td>1,000 M</td> <td>2,473000 G</td> <td>-37.13</td> <td>-24.13</td> </tr> <tr> <td>3,000 G</td> <td>7,000 G</td> <td>1,000 M</td> <td>3,002000 G</td> <td>-37.40</td> <td>-24.40</td> </tr> <tr> <td>7,000 G</td> <td>9,000 G</td> <td>1,000 M</td> <td>8,376500 G</td> <td>-35.17</td> <td>-22.17</td> </tr> </tbody> </table> <p>Date: 11.DEC.2019 09:39:12</p> | Start | Stop | RBW | Freq | PwrAve | ΔLimit | [Hz] | [Hz] | [Hz] | [Hz] | [dBm] | [dB] | 30,000 M | 820,000 M | 1,000 M | 819,802500 M | -24.66 | -11.66 | 855,000 M | 1,000 G | 1,000 M | 855,688750 M | -42.02 | -29.02 | 1,000 G | 3,000 G | 1,000 M | 2,473000 G | -37.13 | -24.13 | 3,000 G | 7,000 G | 1,000 M | 3,002000 G | -37.40 | -24.40 | 7,000 G | 9,000 G | 1,000 M | 8,376500 G | -35.17 | -22.17 | <p align="center">Lowest Channel</p>  <table border="1"> <thead> <tr> <th>Start</th> <th>Stop</th> <th>RBW</th> <th>Freq</th> <th>PwrAve</th> <th>ΔLimit</th> </tr> <tr> <th>[Hz]</th> <th>[Hz]</th> <th>[Hz]</th> <th>[Hz]</th> <th>[dBm]</th> <th>[dB]</th> </tr> </thead> <tbody> <tr> <td>30,000 M</td> <td>820,000 M</td> <td>1,000 M</td> <td>819,605000 M</td> <td>-31.72</td> <td>-18.72</td> </tr> <tr> <td>855,000 M</td> <td>1,000 G</td> <td>1,000 M</td> <td>877,982502 M</td> <td>-41.98</td> <td>-28.98</td> </tr> <tr> <td>1,000 G</td> <td>3,000 G</td> <td>1,000 M</td> <td>2,990000 G</td> <td>-39.96</td> <td>-26.96</td> </tr> <tr> <td>3,000 G</td> <td>7,000 G</td> <td>1,000 M</td> <td>3,757000 G</td> <td>-37.46</td> <td>-24.46</td> </tr> <tr> <td>7,000 G</td> <td>9,000 G</td> <td>1,000 M</td> <td>8,392000 G</td> <td>-35.04</td> <td>-22.04</td> </tr> </tbody> </table> <p>Date: 10.DEC.2019 17:37:40</p> | Start | Stop | RBW | Freq | PwrAve | ΔLimit | [Hz] | [Hz] | [Hz] | [Hz] | [dBm] | [dB] | 30,000 M | 820,000 M | 1,000 M | 819,605000 M | -31.72 | -18.72 | 855,000 M | 1,000 G | 1,000 M | 877,982502 M | -41.98 | -28.98 | 1,000 G | 3,000 G | 1,000 M | 2,990000 G | -39.96 | -26.96 | 3,000 G | 7,000 G | 1,000 M | 3,757000 G | -37.46 | -24.46 | 7,000 G | 9,000 G | 1,000 M | 8,392000 G | -35.04 | -22.04 |
| Start | Stop | RBW | Freq | PwrAve | ΔLimit | | | | | | | | | | | | | | | | | | | | | | | | | | | | | | | | | | | | | | | | | | | | | | | | | | | | | | | | | | | | | | | | | | | | | | | | | | | | | | | | |
| [Hz] | [Hz] | [Hz] | [Hz] | [dBm] | [dB] | | | | | | | | | | | | | | | | | | | | | | | | | | | | | | | | | | | | | | | | | | | | | | | | | | | | | | | | | | | | | | | | | | | | | | | | | | | | | | | | |
| 30,000 M | 820,000 M | 1,000 M | 819,802500 M | -24.66 | -11.66 | | | | | | | | | | | | | | | | | | | | | | | | | | | | | | | | | | | | | | | | | | | | | | | | | | | | | | | | | | | | | | | | | | | | | | | | | | | | | | | | |
| 855,000 M | 1,000 G | 1,000 M | 855,688750 M | -42.02 | -29.02 | | | | | | | | | | | | | | | | | | | | | | | | | | | | | | | | | | | | | | | | | | | | | | | | | | | | | | | | | | | | | | | | | | | | | | | | | | | | | | | | |
| 1,000 G | 3,000 G | 1,000 M | 2,473000 G | -37.13 | -24.13 | | | | | | | | | | | | | | | | | | | | | | | | | | | | | | | | | | | | | | | | | | | | | | | | | | | | | | | | | | | | | | | | | | | | | | | | | | | | | | | | |
| 3,000 G | 7,000 G | 1,000 M | 3,002000 G | -37.40 | -24.40 | | | | | | | | | | | | | | | | | | | | | | | | | | | | | | | | | | | | | | | | | | | | | | | | | | | | | | | | | | | | | | | | | | | | | | | | | | | | | | | | |
| 7,000 G | 9,000 G | 1,000 M | 8,376500 G | -35.17 | -22.17 | | | | | | | | | | | | | | | | | | | | | | | | | | | | | | | | | | | | | | | | | | | | | | | | | | | | | | | | | | | | | | | | | | | | | | | | | | | | | | | | |
| Start | Stop | RBW | Freq | PwrAve | ΔLimit | | | | | | | | | | | | | | | | | | | | | | | | | | | | | | | | | | | | | | | | | | | | | | | | | | | | | | | | | | | | | | | | | | | | | | | | | | | | | | | | |
| [Hz] | [Hz] | [Hz] | [Hz] | [dBm] | [dB] | | | | | | | | | | | | | | | | | | | | | | | | | | | | | | | | | | | | | | | | | | | | | | | | | | | | | | | | | | | | | | | | | | | | | | | | | | | | | | | | |
| 30,000 M | 820,000 M | 1,000 M | 819,605000 M | -31.72 | -18.72 | | | | | | | | | | | | | | | | | | | | | | | | | | | | | | | | | | | | | | | | | | | | | | | | | | | | | | | | | | | | | | | | | | | | | | | | | | | | | | | | |
| 855,000 M | 1,000 G | 1,000 M | 877,982502 M | -41.98 | -28.98 | | | | | | | | | | | | | | | | | | | | | | | | | | | | | | | | | | | | | | | | | | | | | | | | | | | | | | | | | | | | | | | | | | | | | | | | | | | | | | | | |
| 1,000 G | 3,000 G | 1,000 M | 2,990000 G | -39.96 | -26.96 | | | | | | | | | | | | | | | | | | | | | | | | | | | | | | | | | | | | | | | | | | | | | | | | | | | | | | | | | | | | | | | | | | | | | | | | | | | | | | | | |
| 3,000 G | 7,000 G | 1,000 M | 3,757000 G | -37.46 | -24.46 | | | | | | | | | | | | | | | | | | | | | | | | | | | | | | | | | | | | | | | | | | | | | | | | | | | | | | | | | | | | | | | | | | | | | | | | | | | | | | | | |
| 7,000 G | 9,000 G | 1,000 M | 8,392000 G | -35.04 | -22.04 | | | | | | | | | | | | | | | | | | | | | | | | | | | | | | | | | | | | | | | | | | | | | | | | | | | | | | | | | | | | | | | | | | | | | | | | | | | | | | | | |
| <p align="center">Middle Channel</p>  <table border="1"> <thead> <tr> <th>Start</th> <th>Stop</th> <th>RBW</th> <th>Freq</th> <th>PwrAve</th> <th>ΔLimit</th> </tr> <tr> <th>[Hz]</th> <th>[Hz]</th> <th>[Hz]</th> <th>[Hz]</th> <th>[dBm]</th> <th>[dB]</th> </tr> </thead> <tbody> <tr> <td>30,000 M</td> <td>820,000 M</td> <td>1,000 M</td> <td>818,150000 M</td> <td>-42.05</td> <td>-29.05</td> </tr> <tr> <td>855,000 M</td> <td>1,000 G</td> <td>1,000 M</td> <td>856,232500 M</td> <td>-42.74</td> <td>-29.74</td> </tr> <tr> <td>1,000 G</td> <td>3,000 G</td> <td>1,000 M</td> <td>1,673000 G</td> <td>-26.11</td> <td>-13.11</td> </tr> <tr> <td>3,000 G</td> <td>7,000 G</td> <td>1,000 M</td> <td>3,019000 G</td> <td>-37.43</td> <td>-24.43</td> </tr> <tr> <td>7,000 G</td> <td>9,000 G</td> <td>1,000 M</td> <td>8,103500 G</td> <td>-35.28</td> <td>-22.28</td> </tr> </tbody> </table> <p>Date: 11.DEC.2019 09:40:08</p> | Start | Stop | RBW | Freq | PwrAve | ΔLimit | [Hz] | [Hz] | [Hz] | [Hz] | [dBm] | [dB] | 30,000 M | 820,000 M | 1,000 M | 818,150000 M | -42.05 | -29.05 | 855,000 M | 1,000 G | 1,000 M | 856,232500 M | -42.74 | -29.74 | 1,000 G | 3,000 G | 1,000 M | 1,673000 G | -26.11 | -13.11 | 3,000 G | 7,000 G | 1,000 M | 3,019000 G | -37.43 | -24.43 | 7,000 G | 9,000 G | 1,000 M | 8,103500 G | -35.28 | -22.28 | <p align="center">Middle Channel</p>  <table border="1"> <thead> <tr> <th>Start</th> <th>Stop</th> <th>RBW</th> <th>Freq</th> <th>PwrAve</th> <th>ΔLimit</th> </tr> <tr> <th>[Hz]</th> <th>[Hz]</th> <th>[Hz]</th> <th>[Hz]</th> <th>[dBm]</th> <th>[dB]</th> </tr> </thead> <tbody> <tr> <td>30,000 M</td> <td>820,000 M</td> <td>1,000 M</td> <td>779,287500 M</td> <td>-42.39</td> <td>-29.39</td> </tr> <tr> <td>855,000 M</td> <td>1,000 G</td> <td>1,000 M</td> <td>915,261254 M</td> <td>-41.38</td> <td>-28.38</td> </tr> <tr> <td>1,000 G</td> <td>3,000 G</td> <td>1,000 M</td> <td>1,672000 G</td> <td>-38.41</td> <td>-25.41</td> </tr> <tr> <td>3,000 G</td> <td>7,000 G</td> <td>1,000 M</td> <td>3,022000 G</td> <td>-37.49</td> <td>-24.49</td> </tr> <tr> <td>7,000 G</td> <td>9,000 G</td> <td>1,000 M</td> <td>8,043500 G</td> <td>-35.58</td> <td>-22.58</td> </tr> </tbody> </table> <p>Date: 10.DEC.2019 17:38:27</p> | Start | Stop | RBW | Freq | PwrAve | ΔLimit | [Hz] | [Hz] | [Hz] | [Hz] | [dBm] | [dB] | 30,000 M | 820,000 M | 1,000 M | 779,287500 M | -42.39 | -29.39 | 855,000 M | 1,000 G | 1,000 M | 915,261254 M | -41.38 | -28.38 | 1,000 G | 3,000 G | 1,000 M | 1,672000 G | -38.41 | -25.41 | 3,000 G | 7,000 G | 1,000 M | 3,022000 G | -37.49 | -24.49 | 7,000 G | 9,000 G | 1,000 M | 8,043500 G | -35.58 | -22.58 |
| Start | Stop | RBW | Freq | PwrAve | ΔLimit | | | | | | | | | | | | | | | | | | | | | | | | | | | | | | | | | | | | | | | | | | | | | | | | | | | | | | | | | | | | | | | | | | | | | | | | | | | | | | | | |
| [Hz] | [Hz] | [Hz] | [Hz] | [dBm] | [dB] | | | | | | | | | | | | | | | | | | | | | | | | | | | | | | | | | | | | | | | | | | | | | | | | | | | | | | | | | | | | | | | | | | | | | | | | | | | | | | | | |
| 30,000 M | 820,000 M | 1,000 M | 818,150000 M | -42.05 | -29.05 | | | | | | | | | | | | | | | | | | | | | | | | | | | | | | | | | | | | | | | | | | | | | | | | | | | | | | | | | | | | | | | | | | | | | | | | | | | | | | | | |
| 855,000 M | 1,000 G | 1,000 M | 856,232500 M | -42.74 | -29.74 | | | | | | | | | | | | | | | | | | | | | | | | | | | | | | | | | | | | | | | | | | | | | | | | | | | | | | | | | | | | | | | | | | | | | | | | | | | | | | | | |
| 1,000 G | 3,000 G | 1,000 M | 1,673000 G | -26.11 | -13.11 | | | | | | | | | | | | | | | | | | | | | | | | | | | | | | | | | | | | | | | | | | | | | | | | | | | | | | | | | | | | | | | | | | | | | | | | | | | | | | | | |
| 3,000 G | 7,000 G | 1,000 M | 3,019000 G | -37.43 | -24.43 | | | | | | | | | | | | | | | | | | | | | | | | | | | | | | | | | | | | | | | | | | | | | | | | | | | | | | | | | | | | | | | | | | | | | | | | | | | | | | | | |
| 7,000 G | 9,000 G | 1,000 M | 8,103500 G | -35.28 | -22.28 | | | | | | | | | | | | | | | | | | | | | | | | | | | | | | | | | | | | | | | | | | | | | | | | | | | | | | | | | | | | | | | | | | | | | | | | | | | | | | | | |
| Start | Stop | RBW | Freq | PwrAve | ΔLimit | | | | | | | | | | | | | | | | | | | | | | | | | | | | | | | | | | | | | | | | | | | | | | | | | | | | | | | | | | | | | | | | | | | | | | | | | | | | | | | | |
| [Hz] | [Hz] | [Hz] | [Hz] | [dBm] | [dB] | | | | | | | | | | | | | | | | | | | | | | | | | | | | | | | | | | | | | | | | | | | | | | | | | | | | | | | | | | | | | | | | | | | | | | | | | | | | | | | | |
| 30,000 M | 820,000 M | 1,000 M | 779,287500 M | -42.39 | -29.39 | | | | | | | | | | | | | | | | | | | | | | | | | | | | | | | | | | | | | | | | | | | | | | | | | | | | | | | | | | | | | | | | | | | | | | | | | | | | | | | | |
| 855,000 M | 1,000 G | 1,000 M | 915,261254 M | -41.38 | -28.38 | | | | | | | | | | | | | | | | | | | | | | | | | | | | | | | | | | | | | | | | | | | | | | | | | | | | | | | | | | | | | | | | | | | | | | | | | | | | | | | | |
| 1,000 G | 3,000 G | 1,000 M | 1,672000 G | -38.41 | -25.41 | | | | | | | | | | | | | | | | | | | | | | | | | | | | | | | | | | | | | | | | | | | | | | | | | | | | | | | | | | | | | | | | | | | | | | | | | | | | | | | | |
| 3,000 G | 7,000 G | 1,000 M | 3,022000 G | -37.49 | -24.49 | | | | | | | | | | | | | | | | | | | | | | | | | | | | | | | | | | | | | | | | | | | | | | | | | | | | | | | | | | | | | | | | | | | | | | | | | | | | | | | | |
| 7,000 G | 9,000 G | 1,000 M | 8,043500 G | -35.58 | -22.58 | | | | | | | | | | | | | | | | | | | | | | | | | | | | | | | | | | | | | | | | | | | | | | | | | | | | | | | | | | | | | | | | | | | | | | | | | | | | | | | | |
| <p align="center">Highest Channel</p>  <table border="1"> <thead> <tr> <th>Start</th> <th>Stop</th> <th>RBW</th> <th>Freq</th> <th>PwrAve</th> <th>ΔLimit</th> </tr> <tr> <th>[Hz]</th> <th>[Hz]</th> <th>[Hz]</th> <th>[Hz]</th> <th>[dBm]</th> <th>[dB]</th> </tr> </thead> <tbody> <tr> <td>30,000 M</td> <td>820,000 M</td> <td>1,000 M</td> <td>808,150000 M</td> <td>-42.30</td> <td>-29.30</td> </tr> <tr> <td>855,000 M</td> <td>1,000 G</td> <td>1,000 M</td> <td>855,036250 M</td> <td>-33.00</td> <td>-20.00</td> </tr> <tr> <td>1,000 G</td> <td>3,000 G</td> <td>1,000 M</td> <td>1,697000 G</td> <td>-33.88</td> <td>-20.88</td> </tr> <tr> <td>3,000 G</td> <td>7,000 G</td> <td>1,000 M</td> <td>3,576000 G</td> <td>-37.39</td> <td>-24.39</td> </tr> <tr> <td>7,000 G</td> <td>9,000 G</td> <td>1,000 M</td> <td>7,515000 G</td> <td>-35.13</td> <td>-22.13</td> </tr> </tbody> </table> <p>Date: 11.DEC.2019 09:40:59</p> | Start | Stop | RBW | Freq | PwrAve | ΔLimit | [Hz] | [Hz] | [Hz] | [Hz] | [dBm] | [dB] | 30,000 M | 820,000 M | 1,000 M | 808,150000 M | -42.30 | -29.30 | 855,000 M | 1,000 G | 1,000 M | 855,036250 M | -33.00 | -20.00 | 1,000 G | 3,000 G | 1,000 M | 1,697000 G | -33.88 | -20.88 | 3,000 G | 7,000 G | 1,000 M | 3,576000 G | -37.39 | -24.39 | 7,000 G | 9,000 G | 1,000 M | 7,515000 G | -35.13 | -22.13 | <p align="center">Highest Channel</p>  <table border="1"> <thead> <tr> <th>Start</th> <th>Stop</th> <th>RBW</th> <th>Freq</th> <th>PwrAve</th> <th>ΔLimit</th> </tr> <tr> <th>[Hz]</th> <th>[Hz]</th> <th>[Hz]</th> <th>[Hz]</th> <th>[dBm]</th> <th>[dB]</th> </tr> </thead> <tbody> <tr> <td>30,000 M</td> <td>820,000 M</td> <td>1,000 M</td> <td>794,957500 M</td> <td>-42.44</td> <td>-29.44</td> </tr> <tr> <td>855,000 M</td> <td>1,000 G</td> <td>1,000 M</td> <td>857,392500 M</td> <td>-42.13</td> <td>-29.13</td> </tr> <tr> <td>1,000 G</td> <td>3,000 G</td> <td>1,000 M</td> <td>1,697500 G</td> <td>-33.84</td> <td>-20.84</td> </tr> <tr> <td>3,000 G</td> <td>7,000 G</td> <td>1,000 M</td> <td>3,191000 G</td> <td>-37.63</td> <td>-24.63</td> </tr> <tr> <td>7,000 G</td> <td>9,000 G</td> <td>1,000 M</td> <td>8,358500 G</td> <td>-34.58</td> <td>-21.58</td> </tr> </tbody> </table> <p>Date: 10.DEC.2019 17:39:17</p> | Start | Stop | RBW | Freq | PwrAve | ΔLimit | [Hz] | [Hz] | [Hz] | [Hz] | [dBm] | [dB] | 30,000 M | 820,000 M | 1,000 M | 794,957500 M | -42.44 | -29.44 | 855,000 M | 1,000 G | 1,000 M | 857,392500 M | -42.13 | -29.13 | 1,000 G | 3,000 G | 1,000 M | 1,697500 G | -33.84 | -20.84 | 3,000 G | 7,000 G | 1,000 M | 3,191000 G | -37.63 | -24.63 | 7,000 G | 9,000 G | 1,000 M | 8,358500 G | -34.58 | -21.58 |
| Start | Stop | RBW | Freq | PwrAve | ΔLimit | | | | | | | | | | | | | | | | | | | | | | | | | | | | | | | | | | | | | | | | | | | | | | | | | | | | | | | | | | | | | | | | | | | | | | | | | | | | | | | | |
| [Hz] | [Hz] | [Hz] | [Hz] | [dBm] | [dB] | | | | | | | | | | | | | | | | | | | | | | | | | | | | | | | | | | | | | | | | | | | | | | | | | | | | | | | | | | | | | | | | | | | | | | | | | | | | | | | | |
| 30,000 M | 820,000 M | 1,000 M | 808,150000 M | -42.30 | -29.30 | | | | | | | | | | | | | | | | | | | | | | | | | | | | | | | | | | | | | | | | | | | | | | | | | | | | | | | | | | | | | | | | | | | | | | | | | | | | | | | | |
| 855,000 M | 1,000 G | 1,000 M | 855,036250 M | -33.00 | -20.00 | | | | | | | | | | | | | | | | | | | | | | | | | | | | | | | | | | | | | | | | | | | | | | | | | | | | | | | | | | | | | | | | | | | | | | | | | | | | | | | | |
| 1,000 G | 3,000 G | 1,000 M | 1,697000 G | -33.88 | -20.88 | | | | | | | | | | | | | | | | | | | | | | | | | | | | | | | | | | | | | | | | | | | | | | | | | | | | | | | | | | | | | | | | | | | | | | | | | | | | | | | | |
| 3,000 G | 7,000 G | 1,000 M | 3,576000 G | -37.39 | -24.39 | | | | | | | | | | | | | | | | | | | | | | | | | | | | | | | | | | | | | | | | | | | | | | | | | | | | | | | | | | | | | | | | | | | | | | | | | | | | | | | | |
| 7,000 G | 9,000 G | 1,000 M | 7,515000 G | -35.13 | -22.13 | | | | | | | | | | | | | | | | | | | | | | | | | | | | | | | | | | | | | | | | | | | | | | | | | | | | | | | | | | | | | | | | | | | | | | | | | | | | | | | | |
| Start | Stop | RBW | Freq | PwrAve | ΔLimit | | | | | | | | | | | | | | | | | | | | | | | | | | | | | | | | | | | | | | | | | | | | | | | | | | | | | | | | | | | | | | | | | | | | | | | | | | | | | | | | |
| [Hz] | [Hz] | [Hz] | [Hz] | [dBm] | [dB] | | | | | | | | | | | | | | | | | | | | | | | | | | | | | | | | | | | | | | | | | | | | | | | | | | | | | | | | | | | | | | | | | | | | | | | | | | | | | | | | |
| 30,000 M | 820,000 M | 1,000 M | 794,957500 M | -42.44 | -29.44 | | | | | | | | | | | | | | | | | | | | | | | | | | | | | | | | | | | | | | | | | | | | | | | | | | | | | | | | | | | | | | | | | | | | | | | | | | | | | | | | |
| 855,000 M | 1,000 G | 1,000 M | 857,392500 M | -42.13 | -29.13 | | | | | | | | | | | | | | | | | | | | | | | | | | | | | | | | | | | | | | | | | | | | | | | | | | | | | | | | | | | | | | | | | | | | | | | | | | | | | | | | |
| 1,000 G | 3,000 G | 1,000 M | 1,697500 G | -33.84 | -20.84 | | | | | | | | | | | | | | | | | | | | | | | | | | | | | | | | | | | | | | | | | | | | | | | | | | | | | | | | | | | | | | | | | | | | | | | | | | | | | | | | |
| 3,000 G | 7,000 G | 1,000 M | 3,191000 G | -37.63 | -24.63 | | | | | | | | | | | | | | | | | | | | | | | | | | | | | | | | | | | | | | | | | | | | | | | | | | | | | | | | | | | | | | | | | | | | | | | | | | | | | | | | |
| 7,000 G | 9,000 G | 1,000 M | 8,358500 G | -34.58 | -21.58 | | | | | | | | | | | | | | | | | | | | | | | | | | | | | | | | | | | | | | | | | | | | | | | | | | | | | | | | | | | | | | | | | | | | | | | | | | | | | | | | |



GSM1900 (GPRS class 8)

Lowest Channel

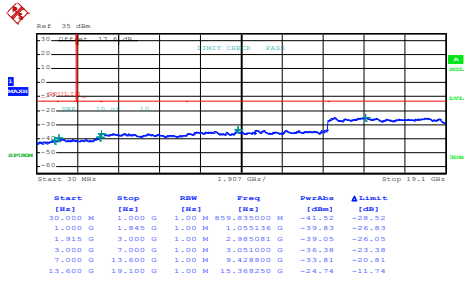

Date: 11.DEC.2019 09:21:35

GSM1900 (EDGE class 8)

Lowest Channel

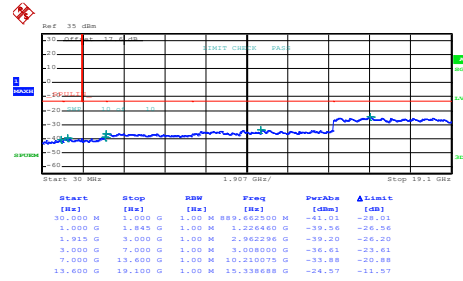

Date: 10.DEC.2019 17:24:39

Middle Channel

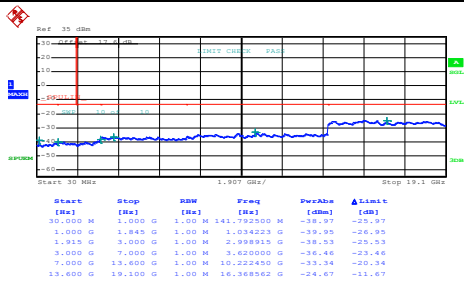

Date: 11.DEC.2019 09:22:26

Middle Channel

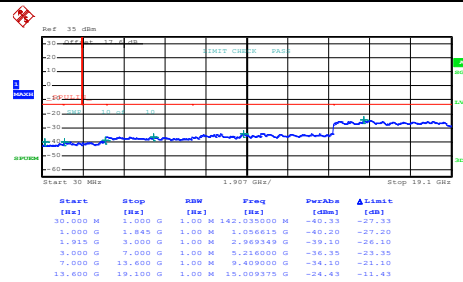

Date: 10.DEC.2019 17:25:39

Highest Channel

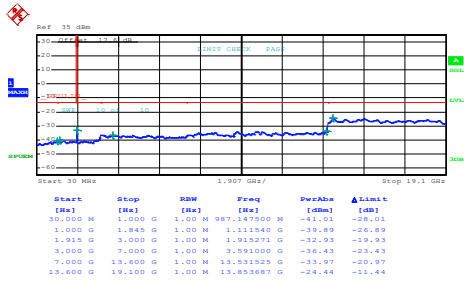

Date: 11.DEC.2019 09:23:16

Highest Channel

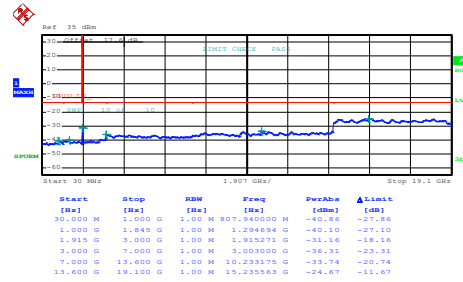

Date: 10.DEC.2019 17:26:31



Frequency Stability

| Test Conditions | Middle Channel | GSM850 (GPRS class 8) | GSM850 (EDGE class 8) | Limit 2.5ppm |
|------------------|-------------------|--------------------------|--------------------------|-----------------|
| Temperature (°C) | Voltage (Volt) | Deviation (ppm) | | Result |
| 50 | Normal Voltage | 0.0430 | 0.0012 | PASS |
| 40 | Normal Voltage | 0.0120 | 0.0012 | |
| 30 | Normal Voltage | 0.0060 | 0.0000 | |
| 20(Ref.) | Normal Voltage | 0.0000 | 0.0000 | |
| 10 | Normal Voltage | 0.0012 | 0.0096 | |
| 0 | Normal Voltage | 0.0084 | 0.0096 | |
| -10 | Normal Voltage | 0.0048 | 0.0096 | |
| -20 | Normal Voltage | 0.0096 | 0.0072 | |
| -30 | Normal Voltage | 0.0143 | 0.0108 | |
| 20 | Maximum Voltage | 0.0024 | 0.0012 | |
| 20 | Normal Voltage | 0.0000 | 0.0000 | |
| 20 | Battery End Point | 0.0024 | 0.0012 | |



| Test Conditions | Middle Channel | GSM1900 (GPRS class 8) | GSM1900 (EDGE class 8) | Limit Note 2. |
|------------------|-------------------|---------------------------|---------------------------|------------------|
| Temperature (°C) | Voltage (Volt) | Deviation (ppm) | | Result |
| 50 | Normal Voltage | 0.0106 | 0.0059 | PASS |
| 40 | Normal Voltage | 0.0085 | 0.0027 | |
| 30 | Normal Voltage | 0.0080 | 0.0021 | |
| 20(Ref.) | Normal Voltage | 0.0000 | 0.0000 | |
| 10 | Normal Voltage | 0.0011 | 0.0011 | |
| 0 | Normal Voltage | 0.0138 | 0.0021 | |
| -10 | Normal Voltage | 0.0027 | 0.0069 | |
| -20 | Normal Voltage | 0.0090 | 0.0027 | |
| -30 | Normal Voltage | 0.0090 | 0.0005 | |
| 20 | Maximum Voltage | 0.0112 | 0.0016 | |
| 20 | Normal Voltage | 0.0000 | 0.0000 | |
| 20 | Battery End Point | 0.0096 | 0.0005 | |

Note:

1. Normal Voltage = 3.85V. ; Battery End Point (BEP) = 3.65 V. ; Maximum Voltage =4.25 V
2. The frequency fundamental emissions stay within the authorized frequency block..



A3. WCDMA

Peak-to-Average Ratio

| Mode | WCDMA Band V | Limit: 13dB |
|------------|--------------|----------------|
| Mod. | RMC 12.2Kbps | Result |
| Lowest CH | 3.12 | PASS |
| Middle CH | 3.20 | |
| Highest CH | 3.28 | |



WCDMA Band V (RMC 12.2Kbps)

Lowest Channel

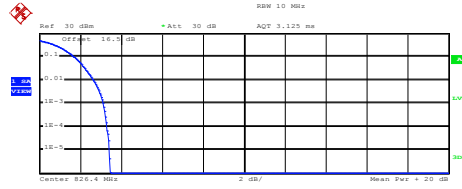

Complementary Cumulative Distribution Function (100000 samples)

Trace 1
 Mean 23.49 dBm
 Peak 26.94 dBm
 Crest 3.44 dB

10 % 1.72 dB
 1 % 2.64 dB
 .1 % 3.12 dB
 .01 % 3.32 dB

Date: 10.DEC.2019 17:08:14

Middle Channel

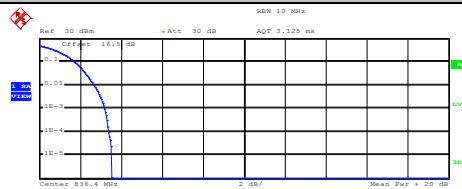

Complementary Cumulative Distribution Function (100000 samples)

Trace 1
 Mean 23.31 dBm
 Peak 26.87 dBm
 Crest 3.55 dB

10 % 1.76 dB
 1 % 2.68 dB
 .1 % 3.20 dB
 .01 % 3.40 dB

Date: 10.DEC.2019 17:08:25

Highest Channel

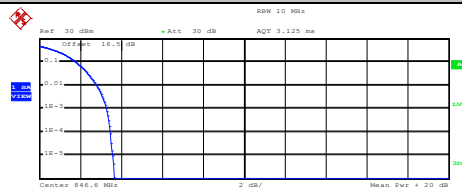

Complementary Cumulative Distribution Function (100000 samples)

Trace 1
 Mean 23.34 dBm
 Peak 27.01 dBm
 Crest 3.66 dB

10 % 1.80 dB
 1 % 2.80 dB
 .1 % 3.28 dB
 .01 % 3.48 dB

Date: 10.DEC.2019 17:08:34



26dB Bandwidth

| Mode | WCDMA Band V 26dB BW(MHz) |
|------------|------------------------------|
| Mod. | RMC 12.2Kbps |
| Lowest CH | 4.71 |
| Middle CH | 4.7 |
| Highest CH | 4.69 |

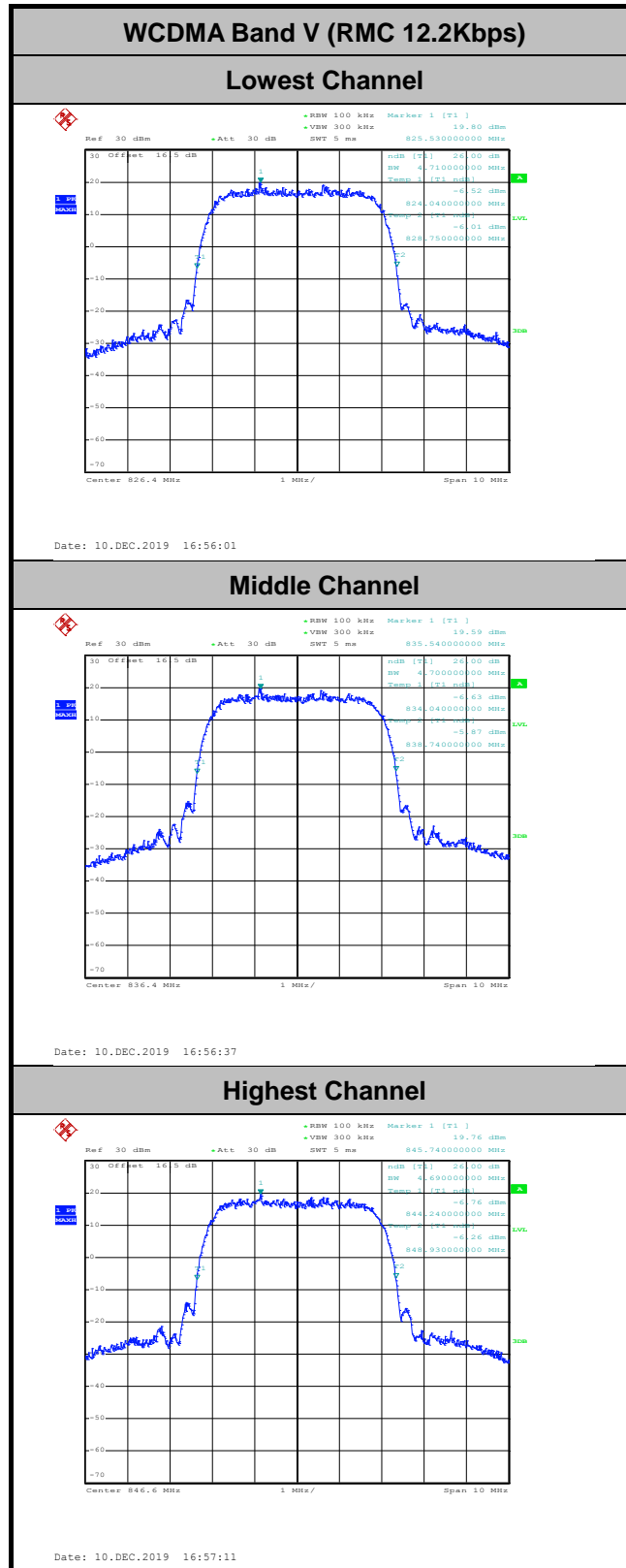



Occupied Bandwidth

| Mode | WCDMA Band V 99% OBW(MHz) |
|------------|------------------------------|
| Mod. | RMC 12.2Kbps |
| Lowest CH | 4.13 |
| Middle CH | 4.14 |
| Highest CH | 4.13 |

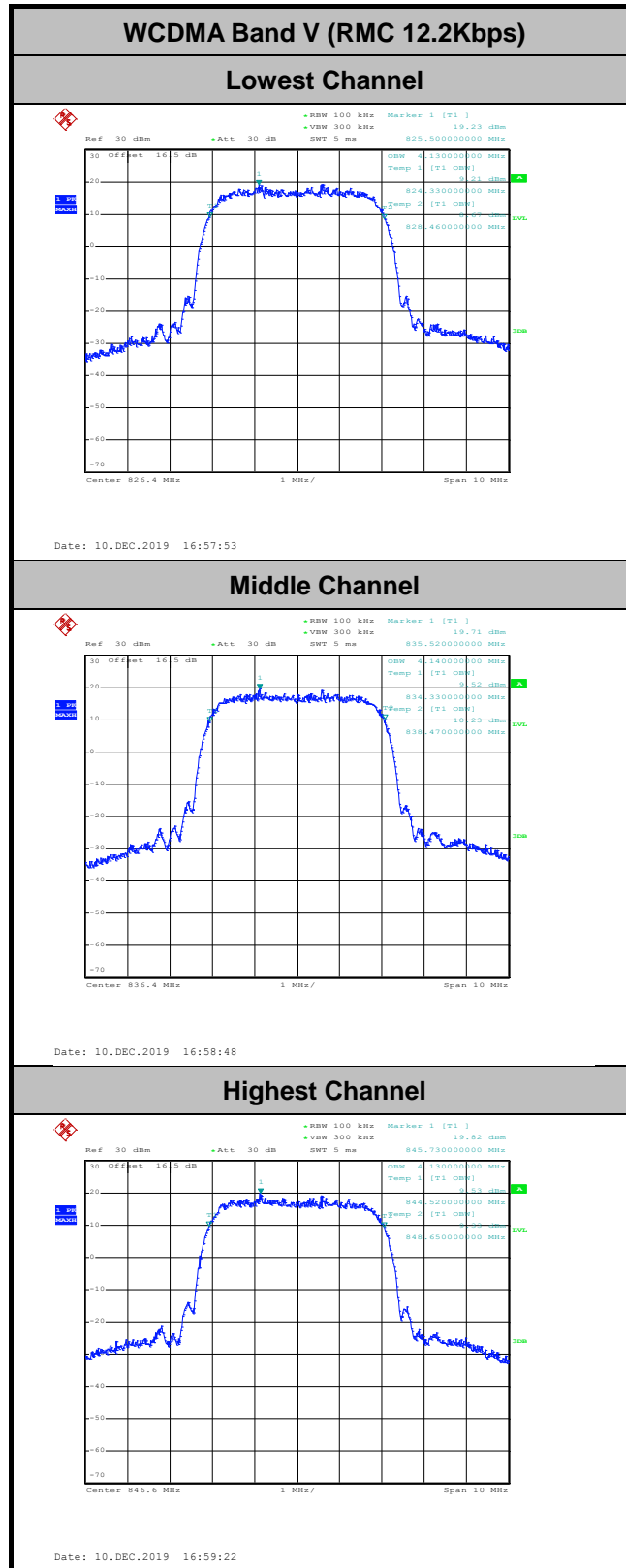



Conducted Band Edge

WCDMA Band V (RMC 12.2Kbps)

Lowest Band Edge

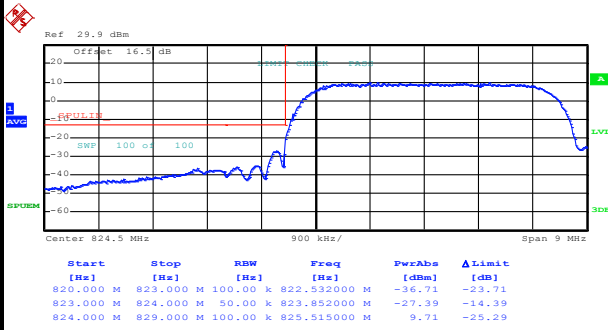

Date: 10.DEC.2019 17:02:12

Highest Band Edge

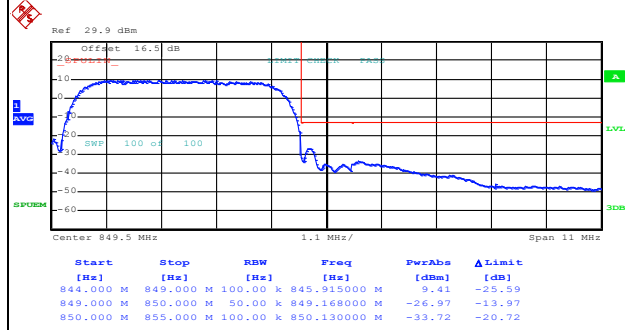

Date: 10.DEC.2019 17:05:02



Conducted Spurious Emission

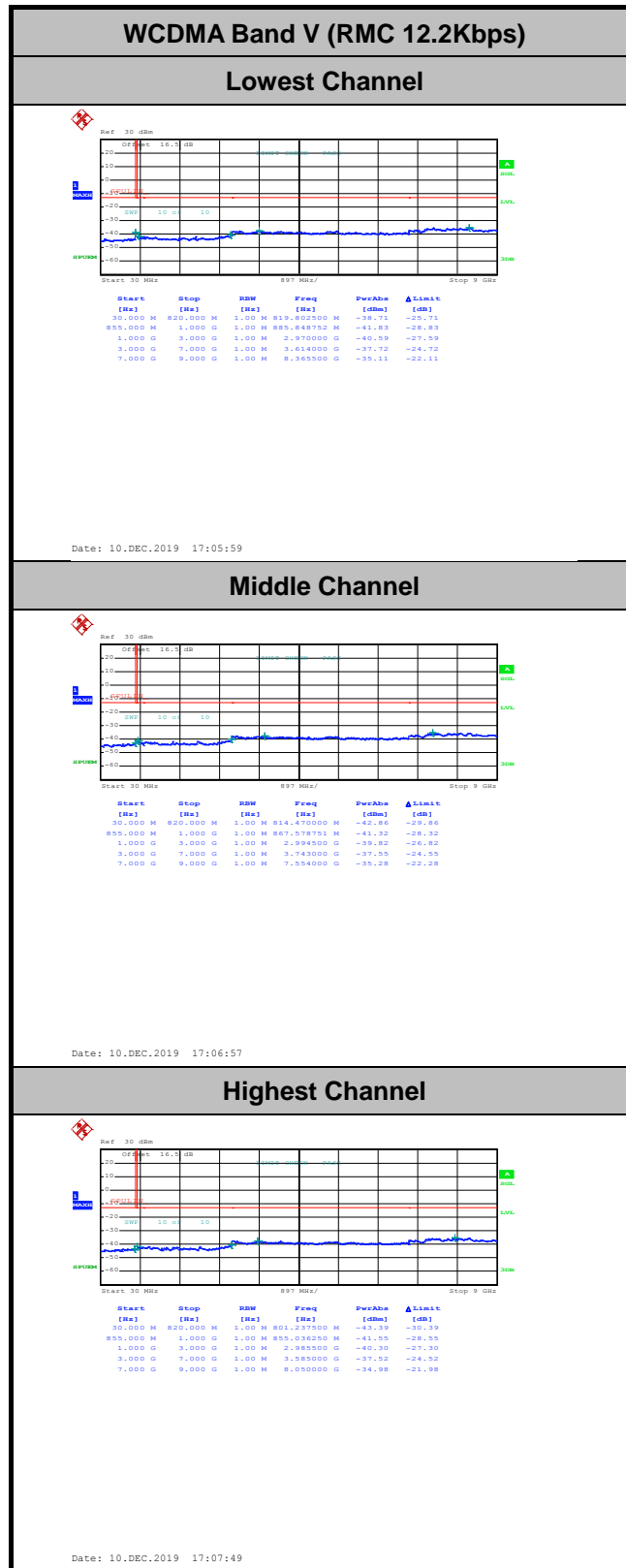



Frequency Stability

| Test Conditions | Middle Channel | WCDMA Band V (RMC 12.2Kbps) | Limit 2.5ppm |
|------------------|-------------------|--------------------------------|-----------------|
| Temperature (°C) | Voltage (Volt) | Deviation (ppm) | Result |
| 50 | Normal Voltage | 0.0024 | PASS |
| 40 | Normal Voltage | 0.0000 | |
| 30 | Normal Voltage | 0.0012 | |
| 20(Ref.) | Normal Voltage | 0.0000 | |
| 10 | Normal Voltage | 0.0191 | |
| 0 | Normal Voltage | 0.0179 | |
| -10 | Normal Voltage | 0.0203 | |
| -20 | Normal Voltage | 0.0179 | |
| -30 | Normal Voltage | 0.0179 | |
| 20 | Maximum Voltage | 0.0012 | |
| 20 | Normal Voltage | 0.0000 | |
| 20 | Battery End Point | 0.0000 | |

Note:

- 1. Normal Voltage = 3.85V. ; Battery End Point (BEP) = 3.65 V. ; Maximum Voltage =4.25 V
- 2. The frequency fundamental emissions stay within the authorized frequency block.



Appendix B. Test Results of ERP/EIRP and Radiated Test

ERP/EIRP

| Channel | Mode | Conducted | | ERP | |
|---------|--------------------|-------------|---------------|----------|--------|
| | | Power (dBm) | Power (Watts) | ERP(dBm) | ERP(W) |
| Lowest | GSM850 | 33.16 | 2.0701 | 27.62 | 0.5781 |
| Middle | GPRS class 8 | 33.18 | 2.0797 | 27.64 | 0.5808 |
| Highest | GT - LC = -3.39 dB | 33.19 | 2.0845 | 27.65 | 0.5821 |
| Lowest | GSM850 | 27.03 | 0.5047 | 21.49 | 0.1409 |
| Middle | EDGE class 8 | 26.94 | 0.4943 | 21.40 | 0.1380 |
| Highest | GT - LC = -3.39 dB | 26.96 | 0.4966 | 21.42 | 0.1387 |
| Lowest | WCDMA Band V | 23.69 | 0.2339 | 18.15 | 0.0653 |
| Middle | RMC 12.2Kbps | 23.64 | 0.2312 | 18.10 | 0.0646 |
| Highest | GT - LC = -3.39 dB | 23.55 | 0.2265 | 18.01 | 0.0632 |
| Limit | ERP < 7W | Result | | PASS | |

| Channel | Mode | Conducted | | EIRP | |
|---------|--------------------|-------------|---------------|-----------|---------|
| | | Power (dBm) | Power (Watts) | EIRP(dBm) | EIRP(W) |
| Lowest | GSM1900 | 25.00 | 0.3162 | 22.01 | 0.1589 |
| Middle | GPRS class 8 | 24.89 | 0.3083 | 21.90 | 0.1549 |
| Highest | GT - LC = -2.99 dB | 25.06 | 0.3206 | 22.07 | 0.1611 |
| Lowest | GSM1900 | 24.84 | 0.3048 | 21.85 | 0.1531 |
| Middle | EDGE class 8 | 24.81 | 0.3027 | 21.82 | 0.1521 |
| Highest | GT - LC = -2.99 dB | 24.92 | 0.3105 | 21.93 | 0.1560 |
| Limit | EIRP < 2W | Result | | PASS | |



Radiated Spurious Emission

GPRS850

| GPRS 850 | | | | | | | | | |
|----------|-------------------|-------------|---------------|-------------------|-------------------|--------------------|----------------------|-----------------------|--------------------|
| Channel | Frequency (MHz) | ERP (dBm) | Limit (dBm) | Over Limit (dB) | SPA Reading (dBm) | S.G. Power (dBm) | TX Cable loss (dB) | TX Antenna Gain (dBi) | Polarization (H/V) |
| Lowest | 1648 | -47.32 | -13 | -34.32 | -57.41 | -52.91 | 0.92 | 8.66 | H |
| | 2472 | -51.16 | -13 | -38.16 | -65.47 | -58.53 | 1.14 | 10.66 | H |
| | 3296 | -55.75 | -13 | -42.75 | -71.43 | -64.29 | 1.32 | 12.01 | H |
| | | | | | | | | | H |
| | | | | | | | | | H |
| | | | | | | | | | H |
| | 1648 | -46.02 | -13 | -33.02 | -55.58 | -51.61 | 0.92 | 8.66 | V |
| | 2472 | -52.60 | -13 | -39.60 | -67.06 | -59.97 | 1.14 | 10.66 | V |
| | 3296 | -55.15 | -13 | -42.15 | -71.3 | -63.69 | 1.32 | 12.01 | V |
| | | | | | | | | | V |
| | | | | | | | | | V |
| | | | | | | | | | V |
| Middle | 1672 | -48.61 | -13 | -35.61 | -58.77 | -54.29 | 0.93 | 8.75 | H |
| | 2509 | -57.05 | -13 | -44.05 | -71.34 | -64.46 | 1.15 | 10.71 | H |
| | 3344 | -55.66 | -13 | -42.66 | -71.21 | -64.30 | 1.33 | 12.13 | H |
| | | | | | | | | | H |
| | | | | | | | | | H |
| | | | | | | | | | H |
| | 1672 | -46.68 | -13 | -33.68 | -56.21 | -52.36 | 0.93 | 8.75 | V |
| | 2509 | -54.77 | -13 | -41.77 | -69.26 | -62.18 | 1.15 | 10.71 | V |
| | 3344 | -55.08 | -13 | -42.08 | -71.08 | -63.72 | 1.33 | 12.13 | V |
| | | | | | | | | | V |
| | | | | | | | | | V |
| | | | | | | | | | V |



| | | | | | | | | | |
|---------|------|--------|-----|--------|--------|--------|------|-------|---|
| Highest | 1697 | -52.04 | -13 | -39.04 | -62.28 | -57.80 | 0.94 | 8.85 | H |
| | 2546 | -55.82 | -13 | -42.82 | -70.09 | -63.26 | 1.16 | 10.76 | H |
| | 3395 | -55.55 | -13 | -42.55 | -70.98 | -64.31 | 1.34 | 12.25 | H |
| | | | | | | | | | H |
| | | | | | | | | | H |
| | | | | | | | | | H |
| | | | | | | | | | H |
| | 1697 | -49.99 | -13 | -36.99 | -59.51 | -55.75 | 0.94 | 8.85 | V |
| | 2546 | -54.60 | -13 | -41.60 | -68.97 | -62.04 | 1.16 | 10.76 | V |
| | 3395 | -55.17 | -13 | -42.17 | -71.03 | -63.93 | 1.34 | 12.25 | V |
| | | | | | | | | | V |
| | | | | | | | | | V |
| | | | | | | | | | V |
| | | | | | | | | | V |

Remark: Spurious emissions within 30-1000MHz were found more than 20dB below limit line.



EDGE 850

| EDGE 850 | | | | | | | | | |
|----------|-------------------|-------------|---------------|-------------------|-------------------|--------------------|----------------------|-----------------------|--------------------|
| Channel | Frequency (MHz) | ERP (dBm) | Limit (dBm) | Over Limit (dB) | SPA Reading (dBm) | S.G. Power (dBm) | TX Cable loss (dB) | TX Antenna Gain (dBi) | Polarization (H/V) |
| Lowest | 1648 | -59.64 | -13 | -46.64 | -69.73 | -65.23 | 0.92 | 8.66 | H |
| | 2472 | -56.76 | -13 | -43.76 | -71.07 | -64.13 | 1.14 | 10.66 | H |
| | 3296 | -55.81 | -13 | -42.81 | -71.49 | -64.35 | 1.32 | 12.01 | H |
| | | | | | | | | | H |
| | | | | | | | | | H |
| | | | | | | | | | H |
| | 1648 | -60.13 | -13 | -47.13 | -69.69 | -65.72 | 0.92 | 8.66 | V |
| | 2472 | -56.51 | -13 | -43.51 | -70.97 | -63.88 | 1.14 | 10.66 | V |
| | 3296 | -55.63 | -13 | -42.63 | -71.78 | -64.17 | 1.32 | 12.01 | V |
| | | | | | | | | | V |
| | | | | | | | | | V |
| | | | | | | | | | V |
| Middle | 1672 | -59.31 | -13 | -46.31 | -69.47 | -64.99 | 0.93 | 8.75 | H |
| | 2509 | -50.52 | -13 | -37.52 | -64.81 | -57.93 | 1.15 | 10.71 | H |
| | 3344 | -55.93 | -13 | -42.93 | -71.48 | -64.57 | 1.33 | 12.13 | H |
| | | | | | | | | | H |
| | | | | | | | | | H |
| | | | | | | | | | H |
| | 1672 | -61.39 | -13 | -48.39 | -70.92 | -67.07 | 0.93 | 8.75 | V |
| | 2509 | -57.19 | -13 | -44.19 | -71.68 | -64.60 | 1.15 | 10.71 | V |
| | 3344 | -55.51 | -13 | -42.51 | -71.51 | -64.15 | 1.33 | 12.13 | V |
| | | | | | | | | | V |
| | | | | | | | | | V |
| | | | | | | | | | V |



| | | | | | | | | | |
|---------|------|--------|-----|--------|--------|--------|------|-------|---|
| Highest | 1696 | -55.55 | -13 | -42.55 | -65.79 | -61.31 | 0.94 | 8.84 | H |
| | 2536 | -56.58 | -13 | -43.58 | -70.85 | -64.01 | 1.16 | 10.74 | H |
| | 3384 | -55.73 | -13 | -42.73 | -71.18 | -64.46 | 1.34 | 12.22 | H |
| | | | | | | | | | H |
| | | | | | | | | | H |
| | | | | | | | | | H |
| | | | | | | | | | H |
| | 1696 | -60.32 | -13 | -47.32 | -69.85 | -66.08 | 0.94 | 8.84 | V |
| | 2536 | -56.88 | -13 | -43.88 | -71.28 | -64.31 | 1.16 | 10.74 | V |
| | 3384 | -55.09 | -13 | -42.09 | -70.98 | -63.82 | 1.34 | 12.22 | V |
| | | | | | | | | | V |
| | | | | | | | | | V |
| | | | | | | | | | V |
| | | | | | | | | | V |

Remark: Spurious emissions within 30-1000MHz were found more than 20dB below limit line.



WCDMA 850

| WCDMA 850 | | | | | | | | | |
|-----------|-------------------|-------------|---------------|-------------------|-------------------|--------------------|----------------------|-----------------------|--------------------|
| Channel | Frequency (MHz) | ERP (dBm) | Limit (dBm) | Over Limit (dB) | SPA Reading (dBm) | S.G. Power (dBm) | TX Cable loss (dB) | TX Antenna Gain (dBi) | Polarization (H/V) |
| Lowest | 1656 | -61.20 | -13 | -48.20 | -71.32 | -66.82 | 0.92 | 8.69 | H |
| | 2480 | -57.54 | -13 | -44.54 | -71.85 | -64.92 | 1.15 | 10.67 | H |
| | 3304 | -56.46 | -13 | -43.46 | -72.11 | -65.01 | 1.32 | 12.03 | H |
| | | | | | | | | | H |
| | | | | | | | | | H |
| | | | | | | | | | H |
| | 1656 | -61.61 | -13 | -48.61 | -71.16 | -67.23 | 0.92 | 8.69 | V |
| | 2480 | -57.18 | -13 | -44.18 | -71.66 | -64.56 | 1.15 | 10.67 | V |
| | 3304 | -55.89 | -13 | -42.89 | -72.01 | -64.44 | 1.32 | 12.03 | V |
| | | | | | | | | | V |
| | | | | | | | | | V |
| | | | | | | | | | V |
| Middle | 1672 | -60.70 | -13 | -47.70 | -70.86 | -66.38 | 0.93 | 8.75 | H |
| | 2512 | -57.95 | -13 | -44.95 | -72.24 | -65.36 | 1.15 | 10.71 | H |
| | 3344 | -56.31 | -13 | -43.31 | -71.86 | -64.95 | 1.33 | 12.13 | H |
| | | | | | | | | | H |
| | | | | | | | | | H |
| | | | | | | | | | H |
| | 1672 | -61.91 | -13 | -48.91 | -71.44 | -67.59 | 0.93 | 8.75 | V |
| | 2512 | -57.55 | -13 | -44.55 | -72.03 | -64.96 | 1.15 | 10.71 | V |
| | 3344 | -55.81 | -13 | -42.81 | -71.81 | -64.45 | 1.33 | 12.13 | V |
| | | | | | | | | | V |
| | | | | | | | | | V |
| | | | | | | | | | V |



| | | | | | | | | | |
|---------|------|--------|-----|--------|--------|--------|------|-------|---|
| Highest | 1696 | -61.34 | -13 | -48.34 | -71.58 | -67.10 | 0.94 | 8.84 | H |
| | 2536 | -57.66 | -13 | -44.66 | -71.93 | -65.09 | 1.16 | 10.74 | H |
| | 3384 | -56.45 | -13 | -43.45 | -71.9 | -65.18 | 1.34 | 12.22 | H |
| | | | | | | | | | H |
| | | | | | | | | | H |
| | | | | | | | | | H |
| | | | | | | | | | H |
| | 1696 | -62.38 | -13 | -49.38 | -71.91 | -68.14 | 0.94 | 8.84 | V |
| | 2536 | -57.39 | -13 | -44.39 | -71.79 | -64.82 | 1.16 | 10.74 | V |
| | 3384 | -56.03 | -13 | -43.03 | -71.92 | -64.76 | 1.34 | 12.22 | V |
| | | | | | | | | | V |
| | | | | | | | | | V |
| | | | | | | | | | V |
| | | | | | | | | | V |

Remark: Spurious emissions within 30-1000MHz were found more than 20dB below limit line.



GPRS 1900

| GPRS 1900 | | | | | | | | | |
|-----------|-------------------|--------------|---------------|-------------------|-------------------|--------------------|----------------------|-----------------------|--------------------|
| Channel | Frequency (MHz) | EIRP (dBm) | Limit (dBm) | Over Limit (dB) | SPA Reading (dBm) | S.G. Power (dBm) | TX Cable loss (dB) | TX Antenna Gain (dBi) | Polarization (H/V) |
| Lowest | 3700 | -53.47 | -13 | -40.47 | -71.68 | -64.68 | 1.41 | 12.62 | H |
| | 5548 | -48.73 | -13 | -35.73 | -71.8 | -60.29 | 1.74 | 13.30 | H |
| | 7403 | -43.61 | -13 | -30.61 | -70.68 | -52.93 | 1.94 | 11.26 | H |
| | | | | | | | | | H |
| | | | | | | | | | H |
| | | | | | | | | | H |
| | 3700 | -53.08 | -13 | -40.08 | -71.43 | -64.29 | 1.41 | 12.62 | V |
| | 5548 | -48.92 | -13 | -35.92 | -71.5 | -60.48 | 1.74 | 13.30 | V |
| | 7403 | -43.49 | -13 | -30.49 | -70.4 | -52.81 | 1.94 | 11.26 | V |
| | | | | | | | | | V |
| | | | | | | | | | V |
| | | | | | | | | | V |
| Middle | 3763 | -53.02 | -13 | -40.02 | -71.45 | -64.25 | 1.43 | 12.66 | H |
| | 5639 | -48.40 | -13 | -35.40 | -71.49 | -59.97 | 1.73 | 13.30 | H |
| | 7522 | -46.14 | -13 | -33.14 | -72.64 | -55.25 | 1.99 | 11.10 | H |
| | | | | | | | | | H |
| | | | | | | | | | H |
| | | | | | | | | | H |
| | 3763 | -52.85 | -13 | -39.85 | -71.5 | -64.08 | 1.43 | 12.66 | V |
| | 5639 | -49.06 | -13 | -36.06 | -71.75 | -60.63 | 1.73 | 13.30 | V |
| | 7522 | -45.71 | -13 | -32.71 | -72.17 | -54.82 | 1.99 | 11.10 | V |
| | | | | | | | | | V |
| | | | | | | | | | V |
| | | | | | | | | | V |



| | | | | | | | | | |
|---------|------|--------|-----|--------|--------|--------|------|-------|---|
| Highest | 3819 | -52.70 | -13 | -39.70 | -71.3 | -63.95 | 1.44 | 12.69 | H |
| | 5730 | -48.46 | -13 | -35.46 | -71.99 | -60.03 | 1.73 | 13.30 | H |
| | 7641 | -46.70 | -13 | -33.70 | -72.75 | -55.82 | 2.01 | 11.13 | H |
| | | | | | | | | | H |
| | | | | | | | | | H |
| | | | | | | | | | H |
| | | | | | | | | | H |
| | 3819 | -52.60 | -13 | -39.60 | -71.44 | -63.85 | 1.44 | 12.69 | V |
| | 5730 | -48.83 | -13 | -35.83 | -71.72 | -60.40 | 1.73 | 13.30 | V |
| | 7641 | -46.76 | -13 | -33.76 | -72.71 | -55.88 | 2.01 | 11.13 | V |
| | | | | | | | | | V |
| | | | | | | | | | V |
| | | | | | | | | | V |
| | | | | | | | | | V |

Remark: Spurious emissions within 30-1000MHz were found more than 20dB below limit line.



EDGE1900

| EDGE 1900 | | | | | | | | | |
|-----------|-------------------|--------------|---------------|-------------------|-------------------|--------------------|----------------------|-----------------------|--------------------|
| Channel | Frequency (MHz) | EIRP (dBm) | Limit (dBm) | Over Limit (dB) | SPA Reading (dBm) | S.G. Power (dBm) | TX Cable loss (dB) | TX Antenna Gain (dBi) | Polarization (H/V) |
| Lowest | 3700 | -53.23 | -13 | -40.23 | -71.44 | -64.44 | 1.41 | 12.62 | H |
| | 5550 | -48.74 | -13 | -35.74 | -71.81 | -60.30 | 1.74 | 13.30 | H |
| | 7403 | -43.43 | -13 | -30.43 | -70.5 | -52.75 | 1.94 | 11.26 | H |
| | | | | | | | | | H |
| | | | | | | | | | H |
| | | | | | | | | | H |
| | 3700 | -52.39 | -13 | -39.39 | -70.74 | -63.60 | 1.41 | 12.62 | V |
| | 5550 | -49.22 | -13 | -36.22 | -71.8 | -60.78 | 1.74 | 13.30 | V |
| | 7403 | -43.85 | -13 | -30.85 | -70.76 | -53.17 | 1.94 | 11.26 | V |
| | | | | | | | | | V |
| | | | | | | | | | V |
| | | | | | | | | | V |
| Middle | 3763 | -52.85 | -13 | -39.85 | -71.28 | -64.08 | 1.43 | 12.66 | H |
| | 5639 | -48.46 | -13 | -35.46 | -71.55 | -60.03 | 1.73 | 13.30 | H |
| | 7522 | -45.90 | -13 | -32.90 | -72.4 | -55.01 | 1.99 | 11.10 | H |
| | | | | | | | | | H |
| | | | | | | | | | H |
| | | | | | | | | | H |
| | 3763 | -52.95 | -13 | -39.95 | -71.6 | -64.18 | 1.43 | 12.66 | V |
| | 5639 | -48.78 | -13 | -35.78 | -71.47 | -60.35 | 1.73 | 13.30 | V |
| | 7522 | -45.99 | -13 | -32.99 | -72.45 | -55.10 | 1.99 | 11.10 | V |
| | | | | | | | | | V |
| | | | | | | | | | V |
| | | | | | | | | | V |



| | | | | | | | | | |
|---------|------|--------|-----|--------|--------|--------|------|-------|---|
| Highest | 3819 | -52.89 | -13 | -39.89 | -71.49 | -64.14 | 1.44 | 12.69 | H |
| | 5730 | -48.09 | -13 | -35.09 | -71.62 | -59.66 | 1.73 | 13.30 | H |
| | 7641 | -46.72 | -13 | -33.72 | -72.77 | -55.84 | 2.01 | 11.13 | H |
| | | | | | | | | | H |
| | | | | | | | | | H |
| | | | | | | | | | H |
| | | | | | | | | | H |
| | 3819 | -52.60 | -13 | -39.60 | -71.44 | -63.85 | 1.44 | 12.69 | V |
| | 5730 | -48.96 | -13 | -35.96 | -71.85 | -60.53 | 1.73 | 13.30 | V |
| | 7641 | -46.83 | -13 | -33.83 | -72.78 | -55.95 | 2.01 | 11.13 | V |
| | | | | | | | | | V |
| | | | | | | | | | V |
| | | | | | | | | | V |
| | | | | | | | | | V |

Remark: Spurious emissions within 30-1000MHz were found more than 20dB below limit line.