



FCC RADIO TEST REPORT

FCC ID : PY7-07452G
Equipment : GSM/WCDMA/LTE/5G Phone with BT, DTS/UNII a/b/g/n/ac/ax, GPS, WPC and NFC
Brand Name : Sony
Applicant : Sony Corporation
1-7-1 Konan Minato-ku Tokyo, 108-0075 Japan
Manufacturer : Sony Corporation
1-7-1 Konan Minato-ku Tokyo, 108-0075 Japan
Standard : FCC 47 CFR Part 2, and 90(S)

The product was received on Dec. 31, 2020 and testing was started from Feb. 22, 2021 and completed on Mar. 15, 2021. We, Sporton International Inc. EMC & Wireless Communications Laboratory, would like to declare that the tested sample has been evaluated in accordance with the test procedures given in ANSI / TIA-603-E and has been in compliance with the applicable technical standards.

The test results in this report apply exclusively to the tested model / sample. Without written approval of Sporton International Inc. EMC & Wireless Communications Laboratory, the test report shall not be reproduced except in full.

Louis Wu

Approved by: Louis Wu

Sporton International Inc. EMC & Wireless Communications Laboratory

No. 52, Huaya 1st Rd., Guishan Dist., Taoyuan City 333, Taiwan (R.O.C.)



Table of Contents

History of this test report..... 3
Summary of Test Result..... 4
1 General Description 5
1.1 Feature of Equipment Under Test..... 5
1.2 Modification of EUT 5
1.3 Emission Designator 6
1.4 Testing Site..... 7
1.5 Applied Standards 8
2 Test Configuration of Equipment Under Test 9
2.1 Test Mode..... 9
2.2 Connection Diagram of Test System 10
2.3 Support Unit used in test configuration and system..... 10
2.4 Measurement Results Explanation Example 10
2.5 Frequency List of Low/Middle/High Channels..... 11
3 Conducted Test Items..... 12
3.1 Measuring Instruments..... 12
3.2 Conducted Output Power Measurement and ERP Measurement 13
3.3 Peak-to-Average Ratio 14
3.4 99% Occupied Bandwidth and 26dB Bandwidth Measurement..... 15
3.5 Emissions Mask Measurement 16
3.6 Emissions Mask – Out Of Band Emissions Measurement..... 17
3.7 Frequency Stability Measurement..... 18
3.8 Field Strength of Spurious Radiation Measurement 19
4 List of Measuring Equipment..... 22
5 Uncertainty of Evaluation 24
Appendix A. Test Results of Conducted Test
Appendix B. Test Results of Radiated Test



History of this test report

| Report No. | Version | Description | Issued Date |
|------------|---------|-------------------------|---------------|
| FG0D2212C | 01 | Initial issue of report | Apr. 09, 2021 |
| | | | |
| | | | |
| | | | |
| | | | |
| | | | |
| | | | |
| | | | |
| | | | |
| | | | |
| | | | |
| | | | |
| | | | |
| | | | |
| | | | |
| | | | |
| | | | |
| | | | |
| | | | |



Summary of Test Result

| Report Clause | Ref Std. Clause | Test Items | Result (PASS/FAIL) | Remark |
|---------------|--------------------|---|--------------------|--|
| 3.2 | §2.1046 §90.635 | Conducted Output Power and Effective Radiated Power | Pass | - |
| 3.3 | - | Peak-to-Average Ratio | Reporting only | - |
| 3.4 | §2.1049 §90.209 | Occupied Bandwidth and 26dB Bandwidth | Reporting only | - |
| 3.5 | §2.1051 §90.691 | Emission masks – In-band emissions | Pass | - |
| 3.6 | §2.1051 §90.691 | Emission masks – Out of band emissions | Pass | - |
| 3.7 | §2.1055 §90.213 | Frequency Stability for Temperature & Voltage | Pass | - |
| 3.8 | §2.1053 §90.691 | Field Strength of Spurious Radiation | Pass | Under limit 36.72 dB at 2448.000 MHz |

Declaration of Conformity:

The test results with all measurement uncertainty excluded are presented in accordance with the regulation limits or requirements declared by manufacturers.

Comments and Explanations:

The declared of product specification for EUT presented in the report are provided by the manufacturer, and the manufacturer takes all the responsibilities for the accuracy of product specification.

Reviewed by: Wii Chang

Report Producer: Lucy Wu



1 General Description

1.1 Feature of Equipment Under Test

GSM/WCDMA/LTE, Bluetooth, DTS/UNII a/b/g/n/ac/ax, NFC, WPC/WPT, and GNSS.

| Product Specification subjective to this standard | |
|---|--------------|
| Antenna Type | Loop Antenna |
| Antenna Gain | -2.07 dBi |

Remark: The above EUT's information was declared by manufacturer. Please refer to Comments and Explanations in report summary.

| EUT Information List | | | |
|----------------------|------------|------------|----------------------------|
| HW Version | SW Version | S/N | Performed Test Item |
| A | 0.325 | QV72004N5Z | Conducted Measurement |
| | | | ERP Test |
| | 0.550 | QV72004K6T | Radiated Spurious Emission |

| Accessory List | |
|----------------|----------------------|
| AC Adapter | Model Name : XQZ-UC1 |
| | S/N: 0020W51300095 |
| Earphone | Model Name : MH750 |
| | S/N : N/A |
| USB Cable | Model Name : XQZ-UB1 |
| | S/N : N/A |

Note:

1. Above EUT list used are electrically identical per declared by manufacturer.
2. Above the accessories list are used to exercise the EUT during test, and the serial number of each type of accessories is listed in each section of this report. .
3. For other wireless features of this EUT, test report will be issued separately.

1.2 Modification of EUT

No modifications are made to the EUT during all test items.



1.3 Emission Designator

| LTE Band 26 | | QPSK | | | 16QAM | | | 64QAM | | |
|-------------|-----------------------|------------------------------|---------------------------|---------------------|------------------------------|---------------------------|---------------------|------------------------------|---------------------------|---------------------|
| BW (MHz) | Frequency Range (MHz) | Emission Designator (99%OBW) | Frequency Tolerance (ppm) | Conducted Power (W) | Emission Designator (99%OBW) | Frequency Tolerance (ppm) | Conducted Power (W) | Emission Designator (99%OBW) | Frequency Tolerance (ppm) | Conducted Power (W) |
| 1.4 | 814.7~823.3 | 1M08G7D | - | 0.0991 | 1M09W7D | - | 0.0782 | 1M09W7D | - | 0.0782 |
| 3 | 815.5~822.5 | 2M72G7D | - | 0.0991 | 2M70W7D | - | 0.0794 | 2M73W7D | - | 0.0794 |
| 5 | 816.5~821.5 | 4M49G7D | - | 0.0993 | 4M48W7D | - | 0.0794 | 4M51W7D | - | 0.0624 |
| 10 | 819.0 | 9M07G7D | 0.0089 | 0.0979 | 8M99W7D | - | 0.0776 | 9M05W7D | - | 0.0604 |
| 15 | 821.5 | 13M4G7D | 0.0185 | 0.0995 | 13M4W7D | - | 0.0760 | 13M4W7D | - | 0.0585 |
| LTE Band 26 | | QPSK | | | 16QAM | | | 64QAM | | |
| BW (MHz) | Frequency Range (MHz) | Emission Designator (99%OBW) | Frequency Tolerance (ppm) | Conducted Power (W) | Emission Designator (99%OBW) | Frequency Tolerance (ppm) | Conducted Power (W) | Emission Designator (99%OBW) | Frequency Tolerance (ppm) | Conducted Power (W) |
| 1.4 | 824 | 1M09G7D | - | 0.0951 | 1M09W7D | - | 0.0746 | 1M09W7D | - | 0.0581 |
| 3 | 824 | 2M72G7D | - | 0.0953 | 2M73W7D | - | 0.0764 | 2M73W7D | - | 0.0590 |
| 5 | 824 | 4M50G7D | - | 0.0962 | 4M51W7D | - | 0.0708 | 4M47W7D | - | 0.0564 |
| 10 | 824 | 8M97G7D | - | 0.0946 | 9M01W7D | - | 0.0703 | 8M99W7D | - | 0.0585 |
| 15 | 824 | 13M4G7D | - | 0.0944 | 13M5W7D | - | 0.0735 | 13M4W7D | - | 0.0570 |



1.4 Testing Site

| | |
|---------------------------|--|
| Test Site | Sporton International Inc. EMC & Wireless Communications Laboratory |
| Test Site Location | No.52, Huaya 1st Rd., Guishan Dist., Taoyuan City 333, Taiwan (R.O.C.) TEL: +886-3-327-3456 FAX: +886-3-328-4978 |
| Test Site No. | Sporton Site No. TH05-HY |
| Test Engineer | Luffy LiN |
| Temperature | 23~25°C |
| Relative Humidity | 52~55% |
| Test Site | Sporton International Inc. Wensan Laboratory |
| Test Site Location | No.58, Aly. 75, Ln. 564, Wenhua 3rd, Rd., Guishan Dist., Taoyuan City 333010, Taiwan (R.O.C.) TEL: +886-3-327-0868 FAX: +886-3-327-0855 |
| Test Site No. | Sporton Site No. 03CH12-HY (TAF Code: 3786) |
| Test Engineer | Jack Cheng, Lance Chiang and Chuan Chu |
| Temperature | 21.8~26.2°C |
| Relative Humidity | 58.7~66.8% |
| Remark | The Radiated Spurious Emission test item subcontracted to Sporton International Inc. Wensan Laboratory |

Note: The test site complies with ANSI C63.4 2014 requirement.

FCC Designation No.: TW1190 and TW0007



1.5 Applied Standards

According to the specifications of the manufacturer, the EUT must comply with the requirements of the following standards:

- ♦ FCC 47 CFR Part 2, 90
- ♦ ANSI / TIA-603-E
- ♦ ANSI C63.26-2015
- ♦ FCC KDB 971168 D01 Power Meas. License Digital Systems v03r01
- ♦ FCC KDB 412172 D01 Determining ERP and EIRP v01r01
- ♦ FCC KDB 414788 D01 Radiated Test Site v01r01
- ♦ Interim Guidance for Equipment Authorization of Devices with Channel Bandwidths Combined Across Two Contiguous Service Rule Allocations OET/Lab/EACB, June 6, 2013

Remark:

1. All test items were verified and recorded according to the standards and without any deviation during the test.
2. This EUT has also been tested and complied with the requirements of FCC Part 15, Subpart B, recorded in a separate test report.
3. The TAF code is not including all the FCC KDB listed without accreditation.



2 Test Configuration of Equipment Under Test

2.1 Test Mode

During all testing, EUT is in link mode with base station emulator at maximum power level.

For radiated measurement, pre-scanned in three orthogonal panels, X, Y, Z. The worst cases (Z plane) were recorded in this report.

Frequency range investigated for radiated emission is 30 MHz to 9000 MHz.

| Conducted Test Cases | Band | Bandwidth (MHz) | | | | | | Modulation | | | RB # | | | Test Channel | | |
|--|--|-----------------|---|---|----|----|----|------------|-------|-------|-----------|------|------|--------------|---|---|
| | | 1.4 | 3 | 5 | 10 | 15 | 20 | QPSK | 16QAM | 64QAM | 1 | Half | Full | L | M | H |
| Max. Output Power | 26 | v | v | v | v | v | - | v | v | v | v | v | v | v | v | v |
| Peak-to-Average Ratio | 26 | | | | v | | - | v | v | v | | | v | | v | |
| 26dB and 99% Bandwidth | 26 | v | v | v | v | v | - | v | v | v | | | v | v | v | |
| Emission masks In-band emissions | 26 | v | v | v | v | v | - | v | v | v | v | | v | v | | v |
| Emission masks – Out of band emissions | 26 | v | v | v | v | v | - | v | | | v | | | v | v | v |
| Frequency Stability | 26 | | | | v | v | - | v | | | | | v | v | v | |
| E.R.P. | 26 | v | v | v | v | v | - | v | v | v | Max Power | | | | | |
| Radiated Spurious Emission | 26 | Worst Case | | | | | | | | | | | v | v | v | |
| Remark | <ol style="list-style-type: none"> The mark "v " means that this configuration is chosen for testing The mark "- " means that this bandwidth is not supported. LTE Band26 transmit frequency for part22 rule is 824MHz-849MHz, for part90 rule is 814MHz-824MHz. ERP over 15MHz bandwidth complies the ERP limit line of part22 rule, therefore ERP of the partial frequency spectrum which falls within part 22 also complies. Since the output power worst case in other WWAN function, after assessing, WPC charging mode test data will be issued in other report. | | | | | | | | | | | | | | | |

2.2 Connection Diagram of Test System

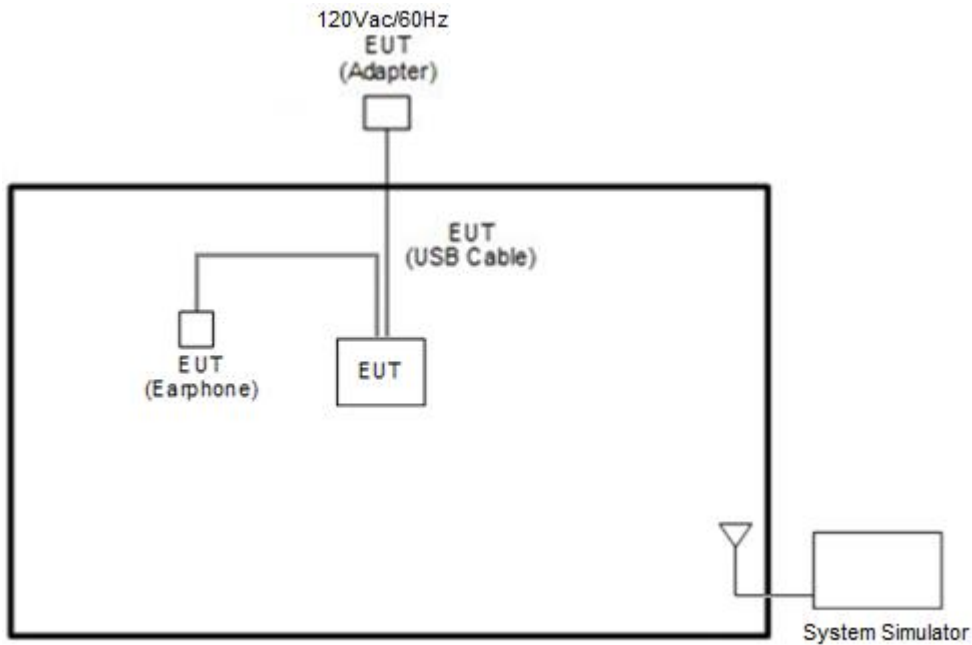

2.3 Support Unit used in test configuration and system

| Item | Equipment | Brand Name | Model No. | FCC ID | Data Cable | Power Cord |
|------|------------------|------------|-----------|--------|------------|-------------------|
| 1. | System Simulator | Anritsu | MT8821C | N/A | N/A | Unshielded, 1.8 m |

2.4 Measurement Results Explanation Example

For all conducted test items:

The offset level is set in the spectrum analyzer to compensate the RF cable loss and attenuator factor between RF conducted output port and spectrum analyzer. With the offset compensation, the spectrum analyzer reading level will be exactly the RF output level.

The spectrum analyzer offset is derived from RF cable loss and attenuator factor.

Offset = RF cable loss + attenuator factor.

The following shows an offset computation example with RF cable loss 4.2 dB and a 10dB attenuator.

Example :

$$\begin{aligned} \text{Offset(dB)} &= \text{RF cable loss(dB)} + \text{attenuator factor(dB)} \\ &= 4.2 + 10 = 14.2 \text{ (dB)} \end{aligned}$$



2.5 Frequency List of Low/Middle/High Channels

| LTE Band 26 Channel and Frequency List | | | | |
|--|------------------------|--------|--------|---------|
| BW [MHz] | Channel/Frequency(MHz) | Lowest | Middle | Highest |
| 15 | Channel | 26765 | - | - |
| | Frequency | 821.5 | - | - |
| 10 | Channel | - | 26740 | - |
| | Frequency | - | 819 | - |
| 5 | Channel | 26715 | 26740 | 26765 |
| | Frequency | 816.5 | 819 | 821.5 |
| 3 | Channel | 26705 | 26740 | 26775 |
| | Frequency | 815.5 | 819 | 822.5 |
| 1.4 | Channel | 26697 | 26740 | 26783 |
| | Frequency | 814.7 | 819 | 823.3 |

3 Conducted Test Items

3.1 Measuring Instruments

See list of measuring instruments of this test report.

3.1.1 Test Setup

3.1.2 Conducted Output Power

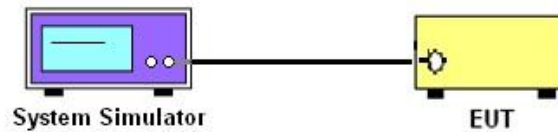

3.1.3 Peak-to-Average Ratio, Occupied Bandwidth, Conducted Band-Edge, Emission Mask, Emissions Mask – Out Of Band Emissions, and Conducted Spurious Emission

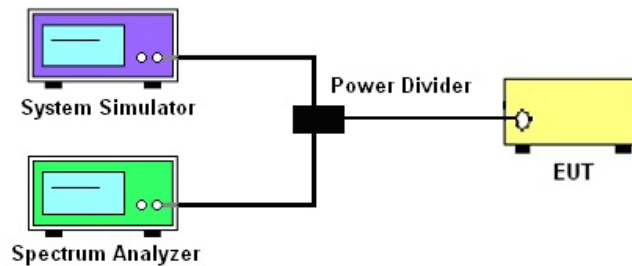

3.1.4 Frequency Stability

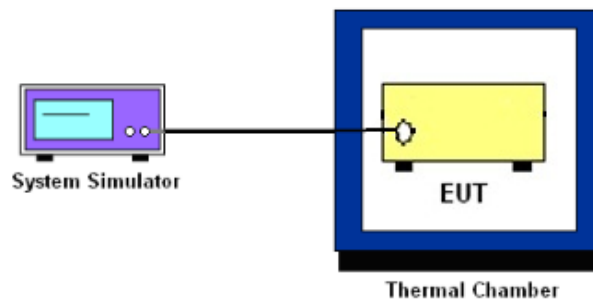

3.1.5 Test Result of Conducted Test

Please refer to Appendix A.



3.2 Conducted Output Power Measurement and ERP Measurement

3.2.1 Description of the Conducted Output Power Measurement and ERP Measurement

A system simulator was used to establish communication with the EUT. Its parameters were set to enforce EUT transmitting at the maximum power. The measured power in the radio frequency on the transmitter output terminals shall be reported.

The ERP of mobile transmitters must not exceed 7 Watts for LTE Band 26.

According to KDB 412172 D01 Power Approach,

$EIRP = P_T + G_T - L_C$, where

P_T = transmitter output power in dBm

G_T = gain of the transmitting antenna in dBi

L_C = signal attenuation in the connecting cable between the transmitter and antenna in dB

3.2.2 Test Procedures

1. The transmitter output port was connected to the system simulator.
2. Set EUT at maximum power through system simulator.
3. Select lowest, middle, and highest channels for each band and different modulation.
4. Measure and record the power level from the system simulator.



3.3 Peak-to-Average Ratio

3.3.1 Description of the PAR Measurement

Reporting only

3.3.2 Test Procedures

1. The EUT was connected to spectrum and system simulator via a power divider.
2. Set the CCDF (Complementary Cumulative Distribution Function) option in spectrum analyzer.
3. The highest RF powers were measured and recorded the maximum PAPR level associated with a probability of 0.1 %.
4. Record the deviation as Peak to Average Ratio.



3.4 99% Occupied Bandwidth and 26dB Bandwidth Measurement

3.4.1 Description of (Occupied) Bandwidth Limitations Measurement

The 99% occupied bandwidth is the width of a frequency band such that, below the lower and above the upper frequency limits, the mean powers emitted are each equal to a specified percentage 0.5% of the total mean transmitted power.

The emission bandwidth is defined as the width of the signal between two points, located at the 2 sides of the carrier frequency, outside of which all emissions are attenuated at least 26 dB below the transmitter power.

3.4.2 Test Procedures

1. The EUT was connected to spectrum analyzer and system simulator via a power divider.
2. The 26dB and 99% occupied bandwidth (BW) of the middle channel for the highest RF power with full RB sizes were measured.



3.5 Emissions Mask Measurement

3.5.1 Description of Emissions Mask Measurement

Equipment used in this licensed to EA or non-EA systems shall comply with the emission mask provisions of FCC Part 90.691.(a)

(a) Out-of-band emission requirement shall apply only to the “outer” channels included in an EA license and to spectrum adjacent to interior channels used by incumbent licensees. The emission limits are as follows:

(1) For any frequency removed from the EA licensee's frequency block by up to and including 37.5 kHz, the power of any emission shall be attenuated below the transmitter power (P) in watts by at least $116 \text{ Log}_{10}(f/6.1)$ decibels or $50 + 10 \text{ Log}_{10}(P)$ decibels or 80 decibels, whichever is the lesser attenuation, where f is the frequency removed from the center of the outer channel in the block in kilohertz and where f is greater than 12.5 kHz.

(2) For any frequency removed from the EA licensee's frequency block greater than 37.5 kHz, the power of any emission shall be attenuated below the transmitter power (P) in watts by at least $43 + 10 \text{ Log}_{10}(P)$ decibels or 80 decibels, whichever is the lesser attenuation, where f is the frequency removed from the center of the outer channel in the block in kilohertz and where f is greater than 37.5 kHz.

3.5.2 Test Procedures

1. The EUT was connected to spectrum analyzer and base station via power divider.
2. The emissions mask of low and high channels for the highest RF powers were measured.
3. Set RBW and VBW 3 times of RBW to make the measurement with the spectrum analyzer's, and according to KDB 971168 D02 Misc Rev Approve License Devices v02r01 standards, set RBW = 300 Hz to make offsets less than 37.5 kHz from a channel edge , RBW = 100 kHz to make offsets greater than 37.5 kHz, that is allowed.
4. The test results were shown below plots with a correction offset factor including cable loss, insertion loss of power divider.



3.6 Emissions Mask – Out Of Band Emissions Measurement

3.6.1 Description of Conducted Emissions Out of band emissions measurement

The power of any emission FCC Part 90.691 (a)(2) on any frequency removed from the assigned frequency by out of the authorized bandwidth at least $43 + 10 \log (P)$ dB. It is measured by means of a calibrated spectrum analyzer and scanned from 30 MHz up to a frequency including its 10th harmonic.

3.6.2 Test Procedures

1. The EUT was connected to spectrum analyzer and system simulator via a power divider.
2. The RF output of EUT was connected to the spectrum analyzer by RF cable and attenuator. The path loss was compensated to the results for each measurement.
3. The middle channel for the highest RF power within the transmitting frequency was measured.
4. The conducted spurious emission for the whole frequency range was taken.
5. For testing below 1GHz, make the measurement with the spectrum analyzer's RBW = 100 kHz, VBW = 3MHz, taking the record of maximum spurious emission.
6. For testing above 1GHz, make the measurement with the spectrum analyzer's RBW = 1MHz, VBW = 3MHz, taking the record of maximum spurious emission.
7. The RF fundamental frequency should be excluded against the limit line in the operating frequency band.
8. The limit line is derived from $43 + 10\log(P)$ dB below the transmitter power P(Watts)



3.7 Frequency Stability Measurement

3.7.1 Description of Frequency Stability Measurement

The frequency stability shall be sufficient to ensure that the fundamental emission stays within the authorized frequency block.

3.7.2 Measuring Instruments

The measuring equipment is listed in the section 4 of this test report.

3.7.3 Test Procedures for Temperature Variation

1. The EUT was set up in the thermal chamber and connected with the base station.
2. With power OFF, the temperature was decreased to -30°C and the EUT was stabilized for three hours. Power was applied and the maximum change in frequency was recorded within one minute.
3. With power OFF, the temperature was raised in 10°C step up to 50°C. The EUT was stabilized at each step for at least half an hour. Power was applied and the maximum frequency change was recorded within one minute.

3.7.4 Test Procedures for Voltage Variation

1. The EUT was placed in a temperature chamber at 20±5° C and connected with the base station.
2. The power supply voltage to the EUT was varied from BEP to 115% of the nominal value measured at the input to the EUT.
3. The variation in frequency was measured for the worst case.



3.8 Field Strength of Spurious Radiation Measurement

3.8.1 Description of Field Strength of Spurious Radiated Measurement

The radiated spurious emission was measured by substitution method according to ANSI / TIA-603-E. The power of any emission FCC Part 90.691 on any frequency removed from the assigned frequency by more than 250 percent of the authorized bandwidth at least $43 + 10 \log (P)$ dB. The spectrum is scanned from 30 MHz up to a frequency including its 10th harmonic.

The power of any emission outside of the authorized operating frequency ranges must be attenuated below the transmitter power (P) by a factor of at least $43+10\log_{10}(P[\text{Watts}])$ dB. The spectrum is scanned from 30 MHz up to a frequency including its 10th harmonic.

3.8.2 Test Procedures

1. The EUT was placed on a turntable with 0.8 meter for frequency below 1GHz and 1.5 meter for frequency above 1GHz respectively above ground.
2. The EUT was set 3 meters from the receiving antenna, which was mounted on the antenna tower.
3. The table was rotated 360 degrees to determine the position of the highest spurious emission.
4. The height of the receiving antenna is varied between one meter and four meters to search the maximum spurious emission for both horizontal and vertical polarizations.
5. For testing below 1GHz, make the measurement with the spectrum analyzer's RBW = 100 kHz, VBW = 3MHz, Sweep = 500ms, Taking the record of maximum spurious emission.
6. For testing above 1GHz, make the measurement with the spectrum analyzer's RBW = 1MHz, VBW = 3MHz, Sweep = 500ms, Taking the record of maximum spurious emission.
7. A horn antenna was substituted in place of the EUT and was driven by a signal generator.
8. Tune the output power of signal generator to the same emission level with EUT maximum spurious emission.
9. Taking the record of output power at antenna port.
10. Repeat step 7 to step 8 for another polarization.
11. $\text{EIRP (dBm)} = \text{S.G. Power} - \text{Tx Cable Loss} + \text{Tx Antenna Gain}$
12. $\text{ERP (dBm)} = \text{EIRP} - 2.15$
13. The RF fundamental frequency should be excluded against the limit line in the operating frequency band.
14. The limit line is derived from $43 + 10\log(P)$ dB below the transmitter power P(Watts)

3.8.3 Test Setup

For radiated test below 30MHz

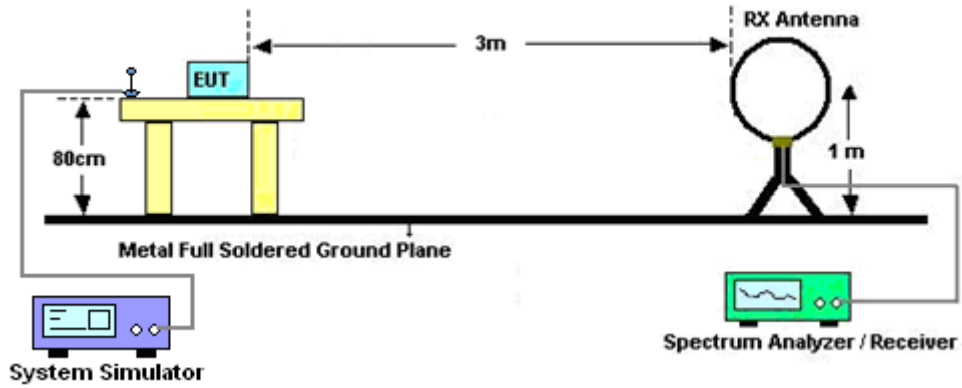

For radiated test from 30MHz to 1GHz

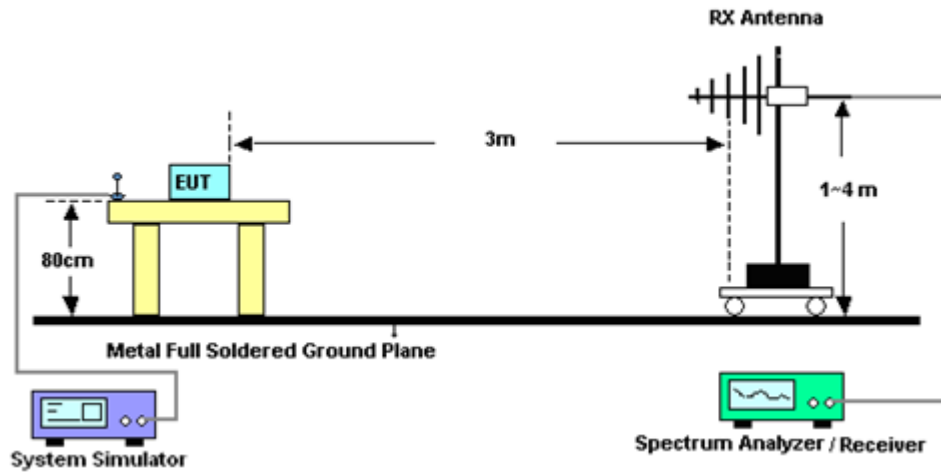

For radiated test above 1GHz

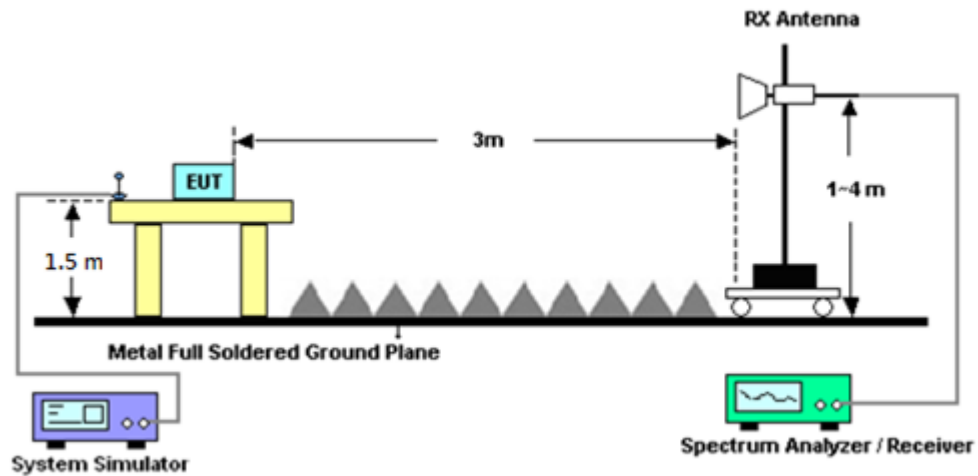

3.8.4 Test Result of Field Strength of Spurious Radiated

Please refer to Appendix B.

Note:

The low frequency, which started from 9 kHz to 30MHz, was pre-scanned and the result which was 20dB lower than the limit line was not reported.

There is a comparison data of both open-field test site and alternative test site - semi-Anechoic chamber according to 414788 D01 Radiated Test Site v01r01, and the result came out very similar.



4 List of Measuring Equipment

| Instrument | Brand Name | Model No. | Serial No. | Characteristics | Calibration Date | Test Date | Due Date | Remark |
|-------------------|-------------------------------|-------------------------------------|----------------|----------------------------------|------------------|---------------------------------|---------------|--------------------------|
| Loop Antenna | Rohde & Schwarz | HFH2-Z2 | 100315 | 9 kHz~30 MHz | Jan. 04, 2021 | Mar. 12, 2021~ Mar. 15, 2021 | Jan. 03, 2022 | Radiation (03CH12-HY) |
| Bilog Antenna | TESEQ | CBL 6111D & 00800N1D01N -06 | 40103 & 07 | 30MHz~1GHz | Apr. 29, 2020 | Mar. 12, 2021~ Mar. 15, 2021 | Apr. 28, 2021 | Radiation (03CH12-HY) |
| Horn Antenna | SCHWARZBE CK | BBHA 9120 D | 9120D-132 8 | 1GHz~18GHz | Nov. 23, 2020 | Mar. 12, 2021~ Mar. 15, 2021 | Nov. 22, 2021 | Radiation (03CH12-HY) |
| Horn Antenna | SCHWARZBE CK | BBHA 9120 D | 9120D-121 2 | 1GHz~18GHz | May 20, 2020 | Mar. 12, 2021~ Mar. 15, 2021 | May 19, 2021 | Radiation (03CH12-HY) |
| Preamplifier | COM-POWER | PA-103 | 161075 | 10MHz~1GHz | Mar. 25, 2020 | Mar. 12, 2021~ Mar. 15, 2021 | Mar. 24, 2021 | Radiation (03CH12-HY) |
| Preamplifier | Keysight | 83017A | MY572801 20 | 1GHz~26.5GHz | Jul. 20, 2020 | Mar. 12, 2021~ Mar. 15, 2021 | Jul. 19, 2021 | Radiation (03CH12-HY) |
| Preamplifier | E-INSTRUME NT TECH LTD. | ERA-100M-18 G-56-01-A70 | EC190024 9 | 1GHz-18GHz | Dec. 05, 2020 | Mar. 12, 2021~ Mar. 15, 2021 | Dec. 04, 2021 | Radiation (03CH12-HY) |
| Spectrum Analyzer | Agilent | N9010A | MY534701 18 | 10Hz~44GHz | Jan. 15, 2021 | Mar. 12, 2021~ Mar. 15, 2021 | Jan. 14, 2022 | Radiation (03CH12-HY) |
| Signal Generator | Rohde & Schwarz | SMB100A | 101107 | 100kHz~40GHz | Dec. 04, 2020 | Mar. 12, 2021~ Mar. 15, 2021 | Dec. 03, 2021 | Radiation (03CH12-HY) |
| RF Cable | HUBER + SUHNER | SUCOFLEX 104 | MY9837/4 PE | 9kHz~30MHz | Mar. 11, 2021 | Mar. 12, 2021~ Mar. 15, 2021 | Mar. 10, 2022 | Radiation (03CH12-HY) |
| RF Cable | HUBER + SUHNER | SUCOFLEX 126E | 0058/126E | 30MHz~18GHz | Dec. 11, 2020 | Mar. 12, 2021~ Mar. 15, 2021 | Dec. 10, 2021 | Radiation (03CH12-HY) |
| RF Cable | HUBER + SUHNER | SUCOFLEX 102 | 505134/2 | 30MHz~40GHz | Feb. 22, 2021 | Mar. 12, 2021~ Mar. 15, 2021 | Feb. 21, 2022 | Radiation (03CH12-HY) |
| RF Cable | HUBER + SUHNER | SUCOFLEX 102 | 800740/2 | 30MHz~40GHz | Feb. 22, 2021 | Mar. 12, 2021~ Mar. 15, 2021 | Feb. 21, 2022 | Radiation (03CH12-HY) |
| Filter | Wainwright | WHKX12-1080 -1200-15000-6 0SS | SN1 | 1.2GHz High Pass Filter | Mar. 18, 2020 | Mar. 12, 2021~ Mar. 15, 2021 | Mar. 17, 2021 | Radiation (03CH12-HY) |
| Filter | Wainwright | WHKX12-2700 -3000-18000-6 0ST | SN2 | 3GHz High Pass Filter | Jul. 14, 2020 | Mar. 12, 2021~ Mar. 15, 2021 | Jul. 13, 2021 | Radiation (03CH12-HY) |
| Antenna Mast | EMEC | AM-BS-4500-B | N/A | 1m~4m | N/A | Mar. 12, 2021~ Mar. 15, 2021 | N/A | Radiation (03CH12-HY) |
| Turn Table | EMEC | TT2000 | N/A | 0~360 Degree | N/A | Mar. 12, 2021~ Mar. 15, 2021 | N/A | Radiation (03CH12-HY) |
| Controller | EMEC | EM1000 | N/A | Control Turn table & Ant Mast | N/A | Mar. 12, 2021~ Mar. 15, 2021 | N/A | Radiation (03CH12-HY) |
| Hygrometer | TECPEL | DTM-303B | TP140349 | N/A | Oct. 02, 2020 | Mar. 12, 2021~ Mar. 15, 2021 | Oct. 01, 2021 | Radiation (03CH12-HY) |
| Software | Audix | E3 6.2009-8-24 | RK-00098 9 | N/A | N/A | Mar. 12, 2021~ Mar. 15, 2021 | N/A | Radiation (03CH12-HY) |



| Instrument | Brand Name | Model No. | Serial No. | Characteristics | Calibration Date | Test Date | Due Date | Remark |
|------------------------------|--------------------|---|-----------------|-----------------------------|------------------|---------------------------------|---------------|--------------------------|
| Filter | Wainwright | WLKS1200-12 SS | SN2 | 1.2GHz Low Pass Filter | Mar. 21, 2020 | Mar. 12, 2021~ Mar. 15, 2021 | Mar. 20, 2021 | Radiation (03CH12-HY) |
| Filter | Wainwright | WHKX12-2700 -3000-18000-6 0ST | SN2 | 3GHz High Pass Filter | Jul. 14, 2020 | Mar. 12, 2021~ Mar. 15, 2021 | Jul. 13, 2021 | Radiation (03CH12-HY) |
| Filter | Wainwright | WHKX8-5872. 5-6750-18000- 40ST | SN2 | 6.75GHz High Pass Filter | Mar. 18, 2020 | Mar. 12, 2021~ Mar. 15, 2021 | Mar. 17, 2021 | Radiation (03CH12-HY) |
| Base Station (Measure) | Anritsu | MT8821C | 626200253 41 | N/A | Oct. 06, 2020 | Feb. 22, 2021~ Feb. 26, 2021 | Oct. 05, 2021 | Conducted (TH05-HY) |
| Spectrum Analyzer | Rohde & Schwarz | FSV40 | 101397 | 10Hz~40GHz | Nov. 27, 2020 | Feb. 22, 2021~ Feb. 26, 2021 | Nov. 26, 2021 | Conducted (TH05-HY) |
| Temperature Chamber | ESPEC | SH-641 | 92013720 | -40℃ ~90℃ | Sep. 14, 2020 | Feb. 22, 2021~ Feb. 26, 2021 | Sep. 13, 2021 | Conducted (TH05-HY) |
| Programmable Power Supply | GW Instek | PSS-2005 | EL890094 | 1V~20V 0.5A~5A | Oct. 05, 2020 | Feb. 22, 2021~ Feb. 26, 2021 | Oct. 04, 2021 | Conducted (TH05-HY) |
| Coupler | Warison | 20dB 25W SMA Directional Coupler | #B | 1-18GHz | Jan. 09, 2021 | Feb. 22, 2021~ Feb. 26, 2021 | Jan. 08, 2022 | Conducted (TH05-HY) |



5 Uncertainty of Evaluation

Uncertainty of Radiated Emission Measurement (30 MHz ~ 1000 MHz)

| | |
|---|------|
| Measuring Uncertainty for a Level of Confidence of 95% ($U = 2Uc(y)$) | 3.07 |
|---|------|

Uncertainty of Radiated Emission Measurement (1 GHz ~ 18 GHz)

| | |
|---|------|
| Measuring Uncertainty for a Level of Confidence of 95% ($U = 2Uc(y)$) | 3.21 |
|---|------|



Appendix A. Test Results of Conducted Test

Conducted Output Power(Average power & ERP)

| LTE Band 26 Maximum Average Power [dBm] (GT - LC = -2.07 dB) | | | | | | | | |
|--|------------|-----------|--------|--------|--------|---------|-----------|---------|
| BW [MHz] | RB Size | RB Offset | Mod | Lowest | Middle | Highest | ERP (dBm) | ERP (W) |
| 15 | 1 | 0 | QPSK | 24.20 | - | - | 19.98 | 0.0995 |
| 15 | 1 | 37 | | 24.06 | - | - | | |
| 15 | 1 | 74 | | 24.04 | - | - | | |
| 15 | 36 | 0 | | 23.20 | - | - | | |
| 15 | 36 | 20 | | 23.24 | - | - | | |
| 15 | 36 | 39 | | 23.23 | - | - | | |
| 15 | 75 | 0 | | 23.24 | - | - | | |
| 15 | 1 | 0 | 16-QAM | 23.03 | - | - | 18.81 | 0.0760 |
| 15 | 1 | 37 | | 22.98 | - | - | | |
| 15 | 1 | 74 | | 22.98 | - | - | | |
| 15 | 36 | 0 | | 21.81 | - | - | | |
| 15 | 36 | 20 | | 21.85 | - | - | | |
| 15 | 36 | 39 | | 21.87 | - | - | | |
| 15 | 75 | 0 | | 21.86 | - | - | | |
| 15 | 1 | 0 | 64-QAM | 21.85 | - | - | 17.67 | 0.0585 |
| 15 | 1 | 37 | | 21.89 | - | - | | |
| 15 | 1 | 74 | | 21.86 | - | - | | |
| 15 | 36 | 0 | | 20.87 | - | - | | |
| 15 | 36 | 20 | | 20.88 | - | - | | |
| 15 | 36 | 39 | | 20.89 | - | - | | |
| 15 | 75 | 0 | | 20.85 | - | - | | |
| Limit | ERP < 100W | | | Result | | | Pass | |



| LTE Band 26 Maximum Average Power [dBm] (GT - LC = -2.07 dB) | | | | | | | | |
|--|------------|-----------|--------|--------|--------|---------|-----------|---------|
| BW [MHz] | RB Size | RB Offset | Mod | Lowest | Middle | Highest | ERP (dBm) | ERP (W) |
| 10 | 1 | 0 | QPSK | - | 24.12 | - | 19.91 | 0.0979 |
| 10 | 1 | 25 | | - | 24.09 | - | | |
| 10 | 1 | 49 | | - | 24.13 | - | | |
| 10 | 25 | 0 | | - | 23.19 | - | | |
| 10 | 25 | 12 | | - | 23.28 | - | | |
| 10 | 25 | 25 | | - | 23.16 | - | | |
| 10 | 50 | 0 | | - | 23.22 | - | | |
| 10 | 1 | 0 | 16-QAM | - | 23.08 | - | 18.90 | 0.0776 |
| 10 | 1 | 25 | | - | 23.09 | - | | |
| 10 | 1 | 49 | | - | 23.12 | - | | |
| 10 | 25 | 0 | | - | 21.78 | - | | |
| 10 | 25 | 12 | | - | 21.87 | - | | |
| 10 | 25 | 25 | | - | 21.74 | - | | |
| 10 | 50 | 0 | | - | 21.84 | - | | |
| 10 | 1 | 0 | 64-QAM | - | 21.96 | - | 17.81 | 0.0604 |
| 10 | 1 | 25 | | - | 22.01 | - | | |
| 10 | 1 | 49 | | - | 22.03 | - | | |
| 10 | 25 | 0 | | - | 20.81 | - | | |
| 10 | 25 | 12 | | - | 20.90 | - | | |
| 10 | 25 | 25 | | - | 20.83 | - | | |
| 10 | 50 | 0 | | - | 20.87 | - | | |
| Limit | ERP < 100W | | | Result | | | Pass | |



| LTE Band 26 Maximum Average Power [dBm] (GT - LC = -2.07 dB) | | | | | | | | |
|--|------------|-----------|--------|--------|--------|---------|-----------|---------|
| BW [MHz] | RB Size | RB Offset | Mod | Lowest | Middle | Highest | ERP (dBm) | ERP (W) |
| 5 | 1 | 0 | QPSK | 24.19 | 24.10 | 24.15 | 19.97 | 0.0993 |
| 5 | 1 | 12 | | 24.18 | 24.15 | 24.16 | | |
| 5 | 1 | 24 | | 24.08 | 24.14 | 24.14 | | |
| 5 | 12 | 0 | | 23.31 | 23.21 | 23.32 | | |
| 5 | 12 | 7 | | 23.30 | 23.23 | 23.27 | | |
| 5 | 12 | 13 | | 23.22 | 23.20 | 23.19 | | |
| 5 | 25 | 0 | | 23.25 | 23.21 | 23.26 | | |
| 5 | 1 | 0 | 16-QAM | 23.22 | 23.04 | 23.20 | 19.00 | 0.0794 |
| 5 | 1 | 12 | | 23.15 | 23.06 | 23.12 | | |
| 5 | 1 | 24 | | 23.04 | 23.10 | 23.08 | | |
| 5 | 12 | 0 | | 21.95 | 21.80 | 21.93 | | |
| 5 | 12 | 7 | | 21.90 | 21.83 | 21.91 | | |
| 5 | 12 | 13 | | 21.84 | 21.80 | 21.79 | | |
| 5 | 25 | 0 | | 21.87 | 21.86 | 21.88 | | |
| 5 | 1 | 0 | 64-QAM | 22.17 | 21.97 | 22.11 | 17.95 | 0.0624 |
| 5 | 1 | 12 | | 22.08 | 21.99 | 22.01 | | |
| 5 | 1 | 24 | | 21.96 | 21.99 | 22.00 | | |
| 5 | 12 | 0 | | 21.00 | 20.85 | 20.95 | | |
| 5 | 12 | 7 | | 20.96 | 20.92 | 20.95 | | |
| 5 | 12 | 13 | | 20.86 | 20.88 | 20.85 | | |
| 5 | 25 | 0 | | 20.88 | 20.83 | 20.90 | | |
| Limit | ERP < 100W | | | Result | | | Pass | |



| LTE Band 26 Maximum Average Power [dBm] (GT - LC = -2.07 dB) | | | | | | | | |
|--|------------|-----------|--------|--------|--------|---------|-----------|---------|
| BW [MHz] | RB Size | RB Offset | Mod | Lowest | Middle | Highest | ERP (dBm) | ERP (W) |
| 3 | 1 | 0 | QPSK | 24.17 | 24.10 | 24.18 | 19.96 | 0.0991 |
| 3 | 1 | 8 | | 24.17 | 24.15 | 24.18 | | |
| 3 | 1 | 14 | | 24.11 | 24.13 | 24.09 | | |
| 3 | 8 | 0 | | 23.32 | 23.20 | 23.26 | | |
| 3 | 8 | 4 | | 23.32 | 23.26 | 23.25 | | |
| 3 | 8 | 7 | | 23.24 | 23.17 | 23.17 | | |
| 3 | 15 | 0 | | 23.29 | 23.19 | 23.23 | | |
| 3 | 1 | 0 | 16-QAM | 23.19 | 23.01 | 23.13 | 19.00 | 0.0794 |
| 3 | 1 | 8 | | 23.22 | 23.17 | 23.13 | | |
| 3 | 1 | 14 | | 23.04 | 23.09 | 23.01 | | |
| 3 | 8 | 0 | | 21.96 | 21.83 | 21.93 | | |
| 3 | 8 | 4 | | 21.99 | 21.89 | 21.90 | | |
| 3 | 8 | 7 | | 21.88 | 21.85 | 21.84 | | |
| 3 | 15 | 0 | | 21.92 | 21.82 | 21.88 | | |
| 3 | 1 | 0 | 64-QAM | 23.19 | 23.01 | 23.13 | 19.00 | 0.0794 |
| 3 | 1 | 8 | | 23.22 | 23.17 | 23.13 | | |
| 3 | 1 | 14 | | 23.04 | 23.09 | 23.01 | | |
| 3 | 8 | 0 | | 21.96 | 21.83 | 21.93 | | |
| 3 | 8 | 4 | | 21.99 | 21.89 | 21.90 | | |
| 3 | 8 | 7 | | 21.88 | 21.85 | 21.84 | | |
| 3 | 15 | 0 | | 21.92 | 21.82 | 21.88 | | |
| Limit | ERP < 100W | | | Result | | | Pass | |



| LTE Band 26 Maximum Average Power [dBm] (GT - LC = -2.07 dB) | | | | | | | | |
|--|------------|-----------|--------|--------|--------|---------|-----------|---------|
| BW [MHz] | RB Size | RB Offset | Mod | Lowest | Middle | Highest | ERP (dBm) | ERP (W) |
| 1.4 | 1 | 0 | QPSK | 24.16 | 24.04 | 24.07 | 19.96 | 0.0991 |
| 1.4 | 1 | 3 | | 24.16 | 24.12 | 24.10 | | |
| 1.4 | 1 | 5 | | 24.10 | 24.04 | 24.02 | | |
| 1.4 | 3 | 0 | | 24.18 | 24.05 | 24.10 | | |
| 1.4 | 3 | 1 | | 24.18 | 24.09 | 24.13 | | |
| 1.4 | 3 | 3 | | 24.16 | 24.08 | 24.05 | | |
| 1.4 | 6 | 0 | | 23.24 | 23.15 | 23.13 | | |
| 1.4 | 1 | 0 | 16-QAM | 23.11 | 22.95 | 23.01 | 18.93 | 0.0782 |
| 1.4 | 1 | 3 | | 23.15 | 23.05 | 23.06 | | |
| 1.4 | 1 | 5 | | 23.03 | 22.97 | 22.95 | | |
| 1.4 | 3 | 0 | | 22.89 | 22.76 | 22.79 | | |
| 1.4 | 3 | 1 | | 22.93 | 22.80 | 22.83 | | |
| 1.4 | 3 | 3 | | 22.85 | 22.74 | 22.75 | | |
| 1.4 | 6 | 0 | | 21.90 | 21.84 | 21.79 | | |
| 1.4 | 1 | 0 | 64-QAM | 23.11 | 22.95 | 23.01 | 18.93 | 0.0782 |
| 1.4 | 1 | 3 | | 23.15 | 23.05 | 23.06 | | |
| 1.4 | 1 | 5 | | 23.03 | 22.97 | 22.95 | | |
| 1.4 | 3 | 0 | | 22.89 | 22.76 | 22.79 | | |
| 1.4 | 3 | 1 | | 22.93 | 22.80 | 22.83 | | |
| 1.4 | 3 | 3 | | 22.85 | 22.74 | 22.75 | | |
| 1.4 | 6 | 0 | | 21.90 | 21.84 | 21.79 | | |
| Limit | ERP < 100W | | | Result | | | Pass | |



| LTE Band 26 Maximum Average Power [dBm] (GT - LC = -2.07 dB) | | | | | | | | |
|--|------------|-----------|--------|--------|--------|---|-----------|---------|
| BW [MHz] | RB Size | RB Offset | Mod | - | 824MHz | - | ERP (dBm) | ERP (W) |
| 15 | 1 | 0 | QPSK | - | 23.97 | - | 19.75 | 0.0944 |
| 15 | 1 | 37 | | - | 23.94 | - | | |
| 15 | 1 | 74 | | - | 23.93 | - | | |
| 15 | 36 | 0 | | - | 23.07 | - | | |
| 15 | 36 | 20 | | - | 23.14 | - | | |
| 15 | 36 | 39 | | - | 23.05 | - | | |
| 15 | 75 | 0 | | - | 23.11 | - | | |
| 15 | 1 | 0 | 16-QAM | - | 22.88 | - | 18.66 | 0.0735 |
| 15 | 1 | 37 | | - | 22.85 | - | | |
| 15 | 1 | 74 | | - | 22.83 | - | | |
| 15 | 36 | 0 | | - | 21.70 | - | | |
| 15 | 36 | 20 | | - | 21.71 | - | | |
| 15 | 36 | 39 | | - | 21.65 | - | | |
| 15 | 75 | 0 | | - | 21.72 | - | | |
| 15 | 1 | 0 | 64-QAM | - | 21.72 | - | 17.56 | 0.0570 |
| 15 | 1 | 37 | | - | 21.78 | - | | |
| 15 | 1 | 74 | | - | 21.68 | - | | |
| 15 | 36 | 0 | | - | 20.72 | - | | |
| 15 | 36 | 20 | | - | 20.75 | - | | |
| 15 | 36 | 39 | | - | 20.73 | - | | |
| 15 | 75 | 0 | | - | 20.74 | - | | |
| Limit | ERP < 100W | | | Result | | | Pass | |



| LTE Band 26 Maximum Average Power [dBm] (GT - LC = -2.07 dB) | | | | | | | | |
|--|------------|-----------|--------|--------|--------|---|-----------|---------|
| BW [MHz] | RB Size | RB Offset | Mod | - | 824MHz | - | ERP (dBm) | ERP (W) |
| 10 | 1 | 0 | QPSK | - | 23.98 | - | 19.76 | 0.0946 |
| 10 | 1 | 25 | | - | 23.93 | - | | |
| 10 | 1 | 49 | | - | 23.91 | - | | |
| 10 | 25 | 0 | | - | 22.83 | - | | |
| 10 | 25 | 12 | | - | 22.83 | - | | |
| 10 | 25 | 25 | | - | 22.76 | - | | |
| 10 | 50 | 0 | | - | 22.94 | - | | |
| 10 | 1 | 0 | 16-QAM | - | 22.65 | - | 18.47 | 0.0703 |
| 10 | 1 | 25 | | - | 22.69 | - | | |
| 10 | 1 | 49 | | - | 22.62 | - | | |
| 10 | 25 | 0 | | - | 21.42 | - | | |
| 10 | 25 | 12 | | - | 21.53 | - | | |
| 10 | 25 | 25 | | - | 21.38 | - | | |
| 10 | 50 | 0 | | - | 21.44 | - | | |
| 10 | 1 | 0 | 64-QAM | - | 21.89 | - | 17.67 | 0.0585 |
| 10 | 1 | 25 | | - | 21.85 | - | | |
| 10 | 1 | 49 | | - | 21.80 | - | | |
| 10 | 25 | 0 | | - | 20.70 | - | | |
| 10 | 25 | 12 | | - | 20.75 | - | | |
| 10 | 25 | 25 | | - | 20.67 | - | | |
| 10 | 50 | 0 | | - | 20.72 | - | | |
| Limit | ERP < 100W | | | Result | | | Pass | |



| LTE Band 26 Maximum Average Power [dBm] (GT - LC = -2.07 dB) | | | | | | | | |
|--|------------|-----------|--------|--------|--------|---|-----------|---------|
| BW [MHz] | RB Size | RB Offset | Mod | - | 824MHz | - | ERP (dBm) | ERP (W) |
| 5 | 1 | 0 | QPSK | - | 24.00 | - | 19.83 | 0.0962 |
| 5 | 1 | 12 | | - | 24.05 | - | | |
| 5 | 1 | 24 | | - | 23.98 | - | | |
| 5 | 12 | 0 | | - | 22.79 | - | | |
| 5 | 12 | 7 | | - | 22.84 | - | | |
| 5 | 12 | 13 | | - | 22.78 | - | | |
| 5 | 25 | 0 | | - | 22.82 | - | | |
| 5 | 1 | 0 | 16-QAM | - | 22.66 | - | 18.50 | 0.0708 |
| 5 | 1 | 12 | | - | 22.71 | - | | |
| 5 | 1 | 24 | | - | 22.72 | - | | |
| 5 | 12 | 0 | | - | 21.46 | - | | |
| 5 | 12 | 7 | | - | 21.50 | - | | |
| 5 | 12 | 13 | | - | 21.44 | - | | |
| 5 | 25 | 0 | | - | 21.49 | - | | |
| 5 | 1 | 0 | 64-QAM | - | 21.70 | - | 17.51 | 0.0564 |
| 5 | 1 | 12 | | - | 21.72 | - | | |
| 5 | 1 | 24 | | - | 21.73 | - | | |
| 5 | 12 | 0 | | - | 20.60 | - | | |
| 5 | 12 | 7 | | - | 20.60 | - | | |
| 5 | 12 | 13 | | - | 20.56 | - | | |
| 5 | 25 | 0 | | - | 20.56 | - | | |
| Limit | ERP < 100W | | | Result | | | Pass | |



| LTE Band 26 Maximum Average Power [dBm] (GT - LC = -2.07 dB) | | | | | | | | |
|--|------------|-----------|--------|--------|--------|---|-----------|---------|
| BW [MHz] | RB Size | RB Offset | Mod | - | 824MHz | - | ERP (dBm) | ERP (W) |
| 3 | 1 | 0 | QPSK | - | 23.72 | - | 19.79 | 0.0953 |
| 3 | 1 | 8 | | - | 23.79 | - | | |
| 3 | 1 | 14 | | - | 24.01 | - | | |
| 3 | 8 | 0 | | - | 23.02 | - | | |
| 3 | 8 | 4 | | - | 23.08 | - | | |
| 3 | 8 | 7 | | - | 23.05 | - | | |
| 3 | 15 | 0 | | - | 23.09 | - | | |
| 3 | 1 | 0 | 16-QAM | - | 22.90 | - | 18.83 | 0.0764 |
| 3 | 1 | 8 | | - | 23.05 | - | | |
| 3 | 1 | 14 | | - | 22.93 | - | | |
| 3 | 8 | 0 | | - | 21.74 | - | | |
| 3 | 8 | 4 | | - | 21.79 | - | | |
| 3 | 8 | 7 | | - | 21.70 | - | | |
| 3 | 15 | 0 | | - | 21.75 | - | | |
| 3 | 1 | 0 | 64-QAM | - | 21.83 | - | 17.71 | 0.0590 |
| 3 | 1 | 8 | | - | 21.93 | - | | |
| 3 | 1 | 14 | | - | 21.91 | - | | |
| 3 | 8 | 0 | | - | 20.76 | - | | |
| 3 | 8 | 4 | | - | 20.79 | - | | |
| 3 | 8 | 7 | | - | 20.71 | - | | |
| 3 | 15 | 0 | | - | 20.69 | - | | |
| Limit | ERP < 100W | | | Result | | | Pass | |



| LTE Band 26 Maximum Average Power [dBm] (GT - LC = -2.07 dB) | | | | | | | | |
|--|------------|-----------|--------|--------|--------|---|-----------|---------|
| BW [MHz] | RB Size | RB Offset | Mod | - | 824MHz | - | ERP (dBm) | ERP (W) |
| 1.4 | 1 | 0 | QPSK | - | 23.90 | - | 19.78 | 0.0951 |
| 1.4 | 1 | 3 | | - | 23.97 | - | | |
| 1.4 | 1 | 5 | | - | 23.89 | - | | |
| 1.4 | 3 | 0 | | - | 24.00 | - | | |
| 1.4 | 3 | 1 | | - | 24.00 | - | | |
| 1.4 | 3 | 3 | | - | 23.96 | - | | |
| 1.4 | 6 | 0 | | - | 23.02 | - | | |
| 1.4 | 1 | 0 | 16-QAM | - | 22.80 | - | 18.73 | 0.0746 |
| 1.4 | 1 | 3 | | - | 22.95 | - | | |
| 1.4 | 1 | 5 | | - | 22.84 | - | | |
| 1.4 | 3 | 0 | | - | 22.68 | - | | |
| 1.4 | 3 | 1 | | - | 22.69 | - | | |
| 1.4 | 3 | 3 | | - | 22.64 | - | | |
| 1.4 | 6 | 0 | | - | 21.70 | - | | |
| 1.4 | 1 | 0 | 64-QAM | - | 21.77 | - | 17.64 | 0.0581 |
| 1.4 | 1 | 3 | | - | 21.86 | - | | |
| 1.4 | 1 | 5 | | - | 21.78 | - | | |
| 1.4 | 3 | 0 | | - | 21.74 | - | | |
| 1.4 | 3 | 1 | | - | 21.83 | - | | |
| 1.4 | 3 | 3 | | - | 21.76 | - | | |
| 1.4 | 6 | 0 | | - | 20.64 | - | | |
| Limit | ERP < 100W | | | Result | | | Pass | |



LTE Band 26

Peak-to-Average Ratio

| Mode | LTE Band 26 / 10MHz | | | | |
|-----------|---------------------|---------|---------|---------|-------------|
| Mod. | QPSK | 16QAM | 64QAM | 256QAM | Limit: 13dB |
| RB Size | Full RB | Full RB | Full RB | Full RB | Result |
| Middle CH | 4.93 | 5.68 | 6.52 | - | PASS |



LTE Band 26 / 10MHz / QPSK

Middle Channel / Full RB

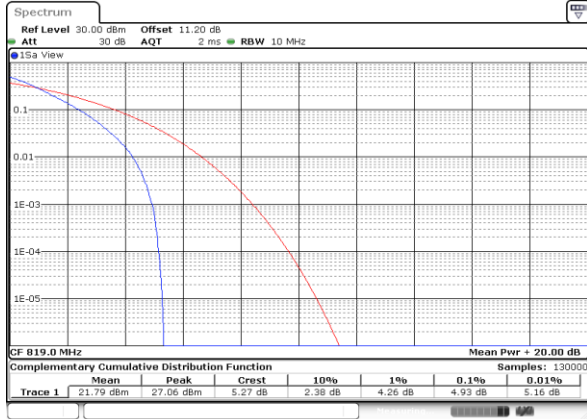

Date: 24 FEB 2021 19:48:52

LTE Band 26 / 10MHz / 16QAM

Middle Channel / Full RB

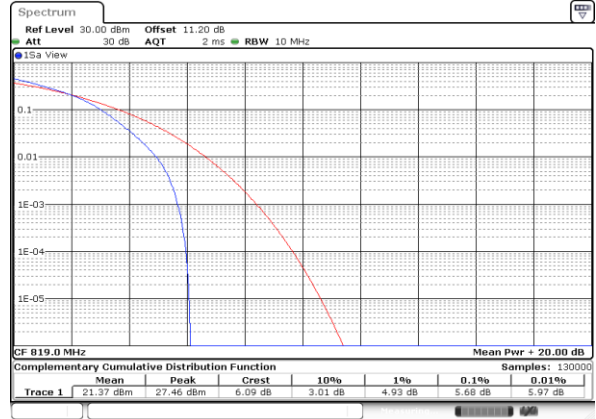

Date: 24 FEB 2021 19:48:26

LTE Band 26 / 10MHz / 64QAM

Middle Channel / Full RB

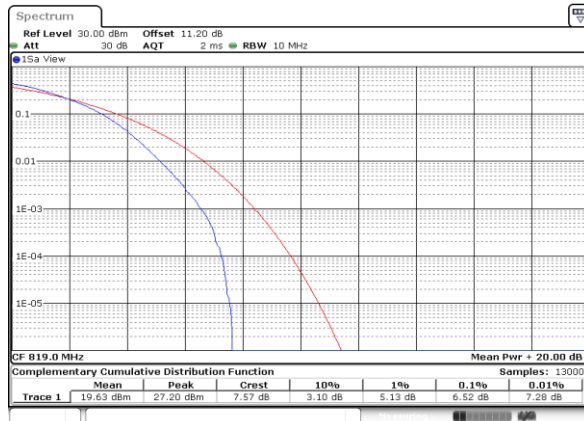

Date: 24 FEB 2021 19:49:18



26dB Bandwidth

| Mode | LTE Band 26 : 26dB BW(MHz) | | | | | | | | | | | |
|-----------|----------------------------|---------|-------|---------|-------|---------|-------|---------|-------|---------|-------|---------|
| BW | 1.4MHz | | 3MHz | | 5MHz | | 10MHz | | 15MHz | | 20MHz | |
| Mod. | QPSK | 16QAM | QPSK | 16QAM | QPSK | 16QAM | QPSK | 16QAM | QPSK | 16QAM | QPSK | 16QAM |
| Middle CH | 1.23 | 1.24 | 3.05 | 3.03 | 4.92 | 4.80 | 9.71 | 9.67 | - | - | - | - |
| Low CH | - | - | - | - | - | - | - | - | 14.18 | 14.45 | - | - |
| Mode | LTE Band 26 : 26dB BW(MHz) | | | | | | | | | | | |
| BW | 1.4MHz | | 3MHz | | 5MHz | | 10MHz | | 15MHz | | 20MHz | |
| Mod. | 64QAM | 256 QAM | 64QAM | 256 QAM | 64QAM | 256 QAM | 64QAM | 256 QAM | 64QAM | 256 QAM | 64QAM | 256 QAM |
| Middle CH | 1.23 | - | 2.97 | - | 4.89 | - | 9.71 | - | - | - | - | - |
| Low CH | - | - | - | - | - | - | - | - | 14.33 | - | - | - |



LTE Band 26

Middle Channel / 1.4MHz / QPSK

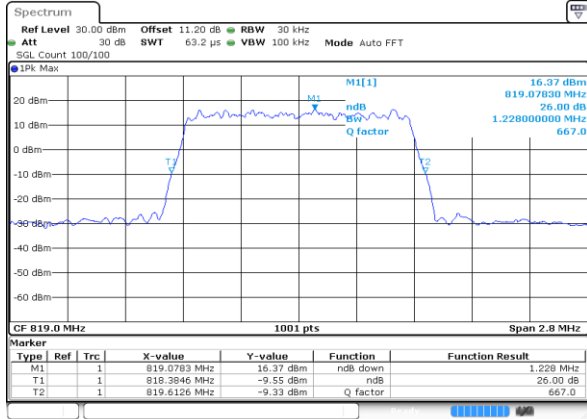

Date: 24 FEB 2021 18:36:16

Middle Channel / 1.4MHz / 16QAM

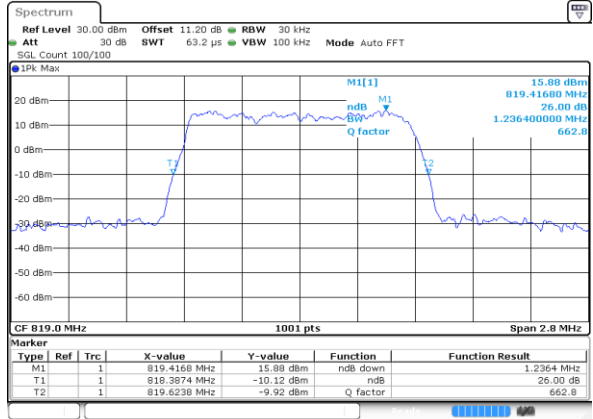

Date: 24 FEB 2021 18:36:39

Middle Channel / 3MHz / QPSK

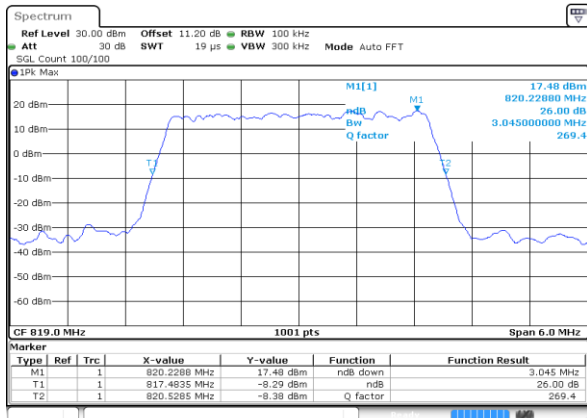

Date: 24 FEB 2021 19:32:31

Middle Channel / 3MHz / 16QAM

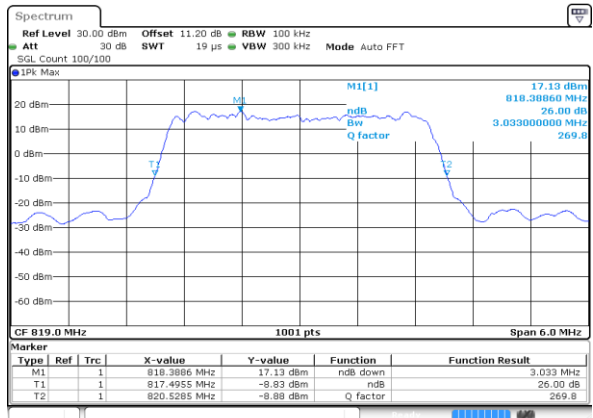

Date: 24 FEB 2021 19:32:55

Middle Channel / 5MHz / QPSK

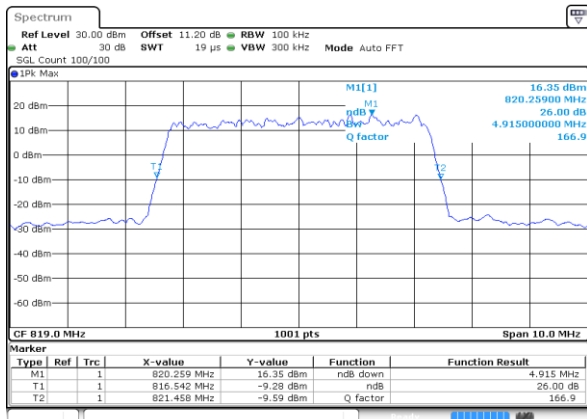

Date: 24 FEB 2021 19:38:22

Middle Channel / 5MHz / 16QAM

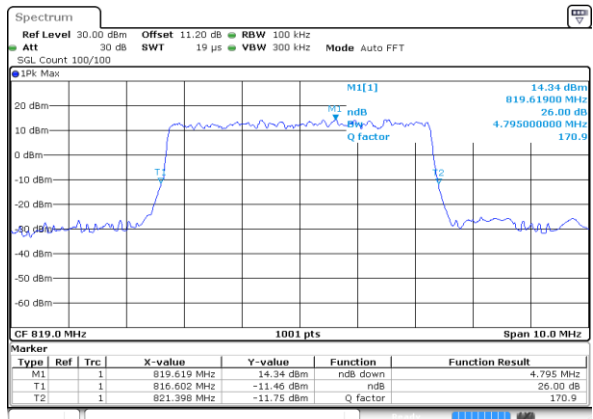

Date: 24 FEB 2021 19:38:45



LTE Band 26

Middle Channel / 10MHz / QPSK

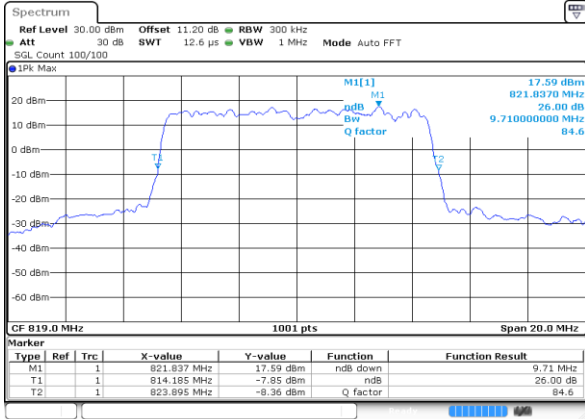

Date: 24 FEB 2021 19:42:48

Middle Channel / 10MHz / 16QAM

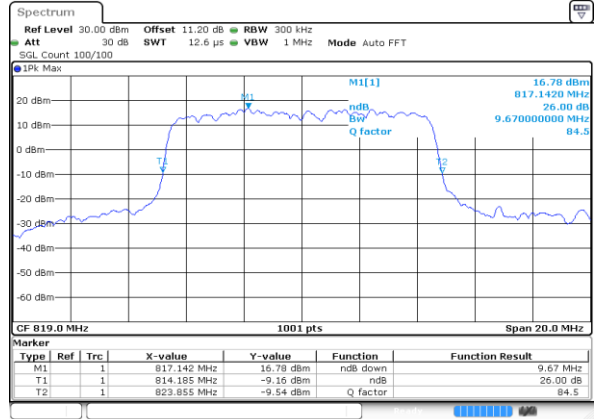

Date: 24 FEB 2021 19:43:11

LTE Band 26

Middle Channel / 1.4MHz / 64QAM

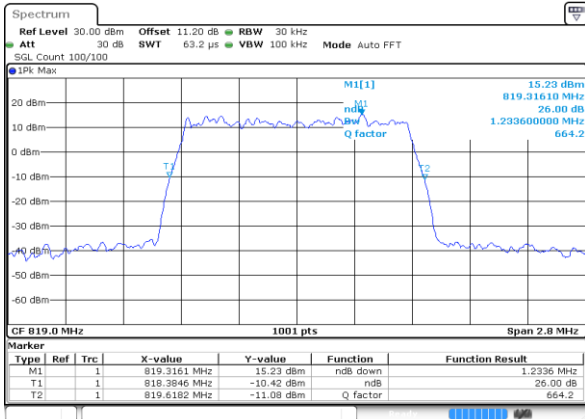

Date: 24 FEB 2021 18:33:38

Middle Channel / 3MHz / 64QAM

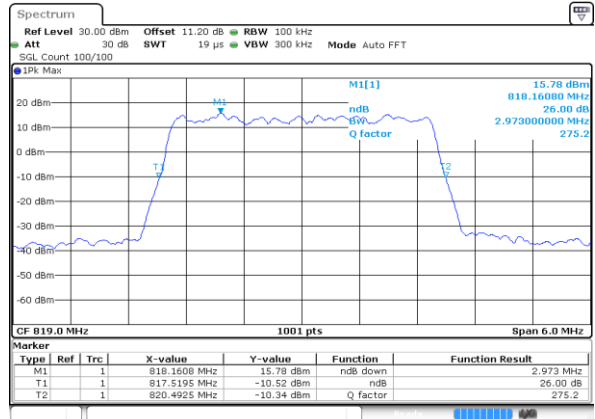

Date: 24 FEB 2021 19:28:32

Middle Channel / 5MHz / 64QAM

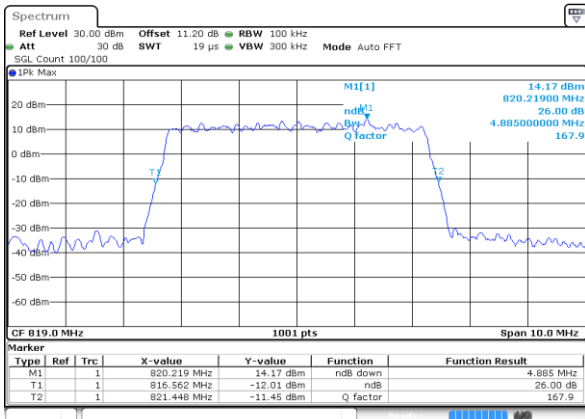

Date: 24 FEB 2021 19:29:12

Middle Channel / 10MHz / 64QAM

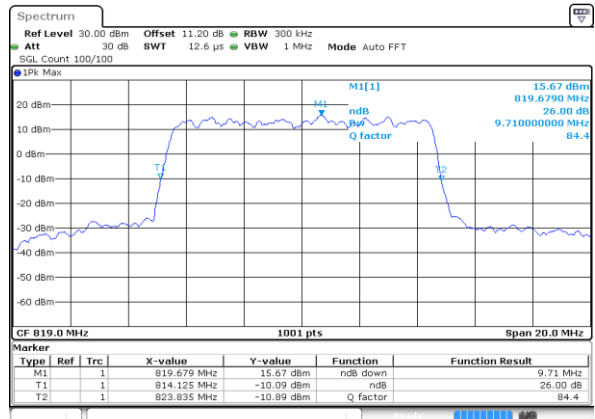

Date: 24 FEB 2021 19:29:53



LTE Band 26

Low Channel / 15MHz / QPSK

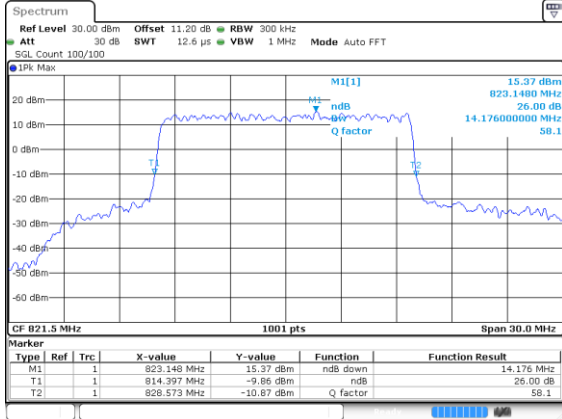

Date: 26 FEB 2021 19:31:14

Low Channel / 15MHz / 16QAM

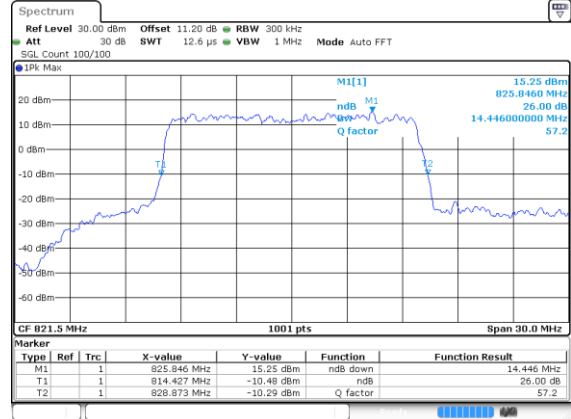

Date: 26 FEB 2021 19:31:42

Low Channel / 15MHz / 64QAM

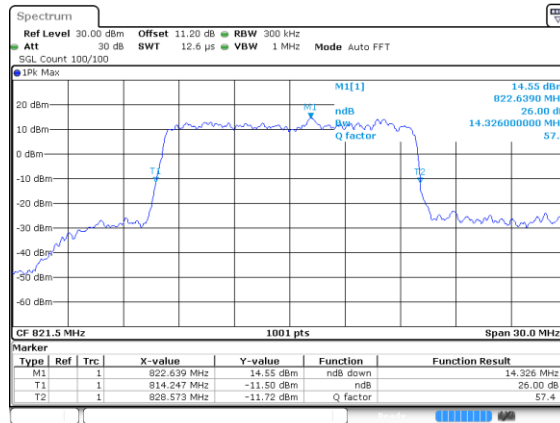

Date: 24 FEB 2021 19:27:52



Occupied Bandwidth

| Mode | LTE Band 26 : 99%OBW(MHz) | | | | | | | | | | | |
|-----------|---------------------------|---------|-------|---------|-------|---------|-------|---------|-------|---------|-------|---------|
| BW | 1.4MHz | | 3MHz | | 5MHz | | 10MHz | | 15MHz | | 20MHz | |
| Mod. | QPSK | 16QAM | QPSK | 16QAM | QPSK | 16QAM | QPSK | 16QAM | QPSK | 16QAM | QPSK | 16QAM |
| Middle CH | 1.08 | 1.09 | 2.72 | 2.70 | 4.49 | 4.48 | 9.07 | 8.99 | - | - | - | - |
| Low CH | - | - | - | - | - | - | - | - | 13.43 | 13.37 | - | - |
| Mode | LTE Band 26 : 99%OBW(MHz) | | | | | | | | | | | |
| BW | 1.4MHz | | 3MHz | | 5MHz | | 10MHz | | 15MHz | | 20MHz | |
| Mod. | 64QAM | 256 QAM | 64QAM | 256 QAM | 64QAM | 256 QAM | 64QAM | 256 QAM | 64QAM | 256 QAM | 64QAM | 256 QAM |
| Middle CH | 1.09 | - | 2.73 | - | 4.51 | - | 9.05 | - | - | - | - | - |
| Low CH | - | - | - | - | - | - | - | - | 13.40 | - | - | - |



LTE Band 26

Middle Channel / 1.4MHz / QPSK

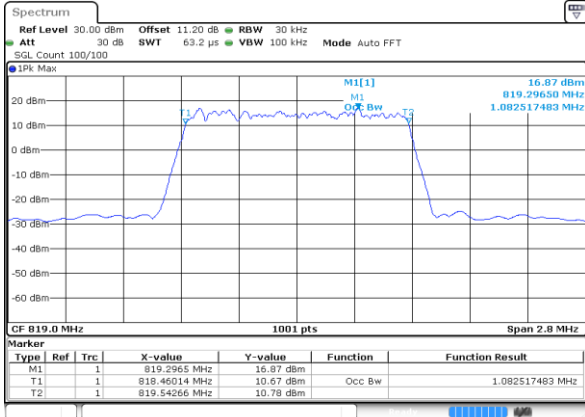

Date: 24 FEB 2021 18:35:26

Middle Channel / 1.4MHz / 16QAM

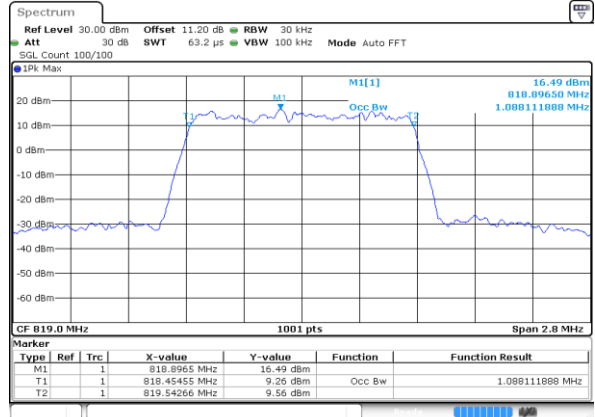

Date: 24 FEB 2021 18:35:51

Middle Channel / 3MHz / QPSK

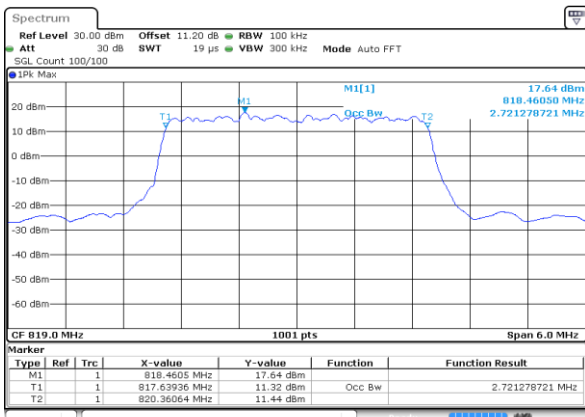

Date: 24 FEB 2021 19:31:41

Middle Channel / 3MHz / 16QAM

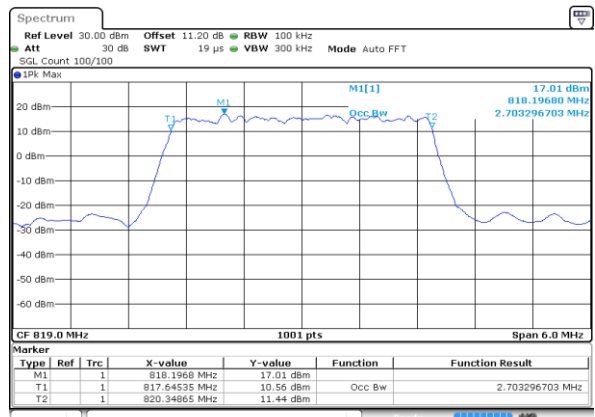

Date: 24 FEB 2021 19:32:06

Middle Channel / 5MHz / QPSK

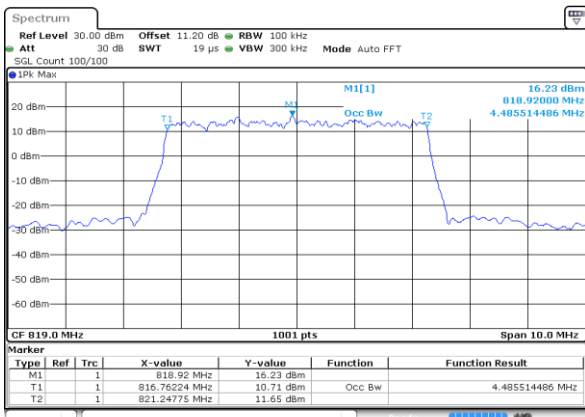

Date: 24 FEB 2021 19:37:32

Middle Channel / 5MHz / 16QAM

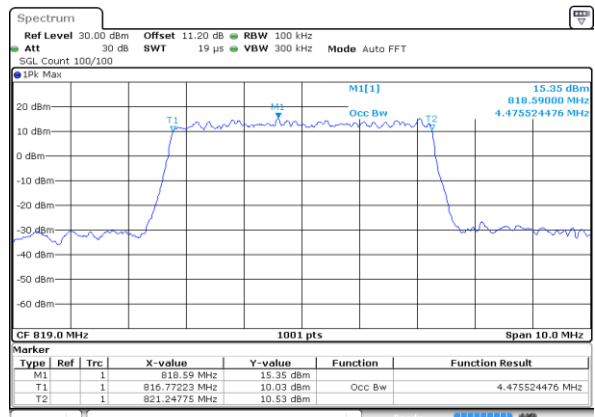

Date: 24 FEB 2021 19:37:57



LTE Band 26

Middle Channel / 10MHz / QPSK

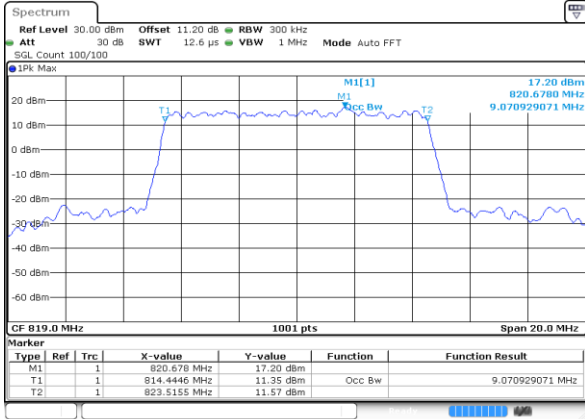

Date: 24 FEB 2021 19:41:58

Middle Channel / 10MHz / 16QAM

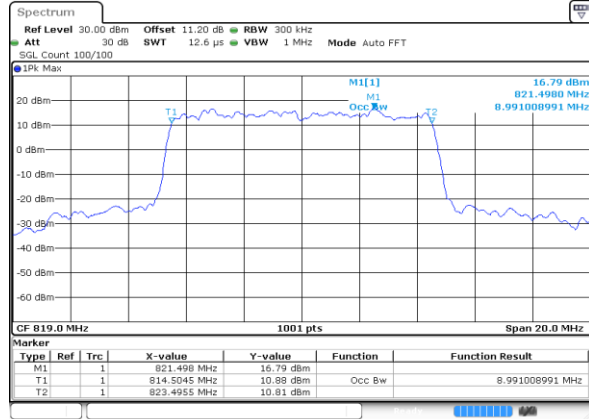

Date: 24 FEB 2021 19:42:23

LTE Band 26

Middle Channel / 1.4MHz / 64QAM

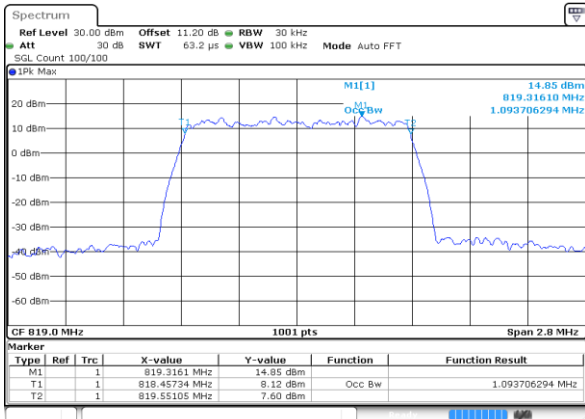

Date: 24 FEB 2021 18:33:22

Middle Channel / 3MHz / 64QAM

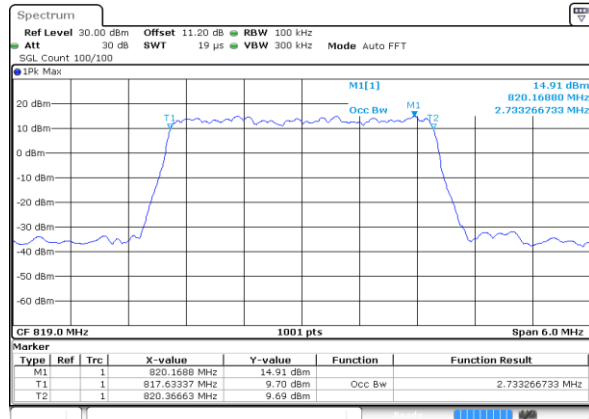

Date: 24 FEB 2021 19:28:16

Middle Channel / 5MHz / 64QAM

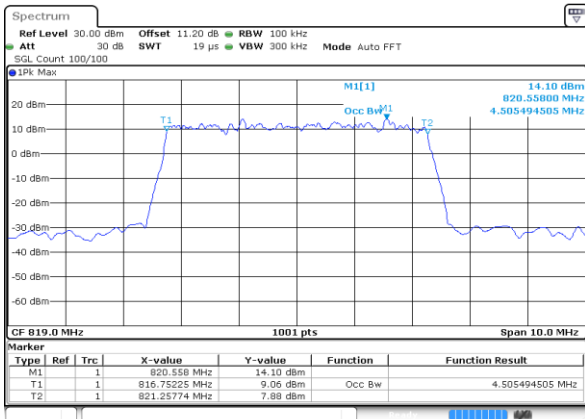

Date: 24 FEB 2021 19:28:56

Middle Channel / 10MHz / 64QAM

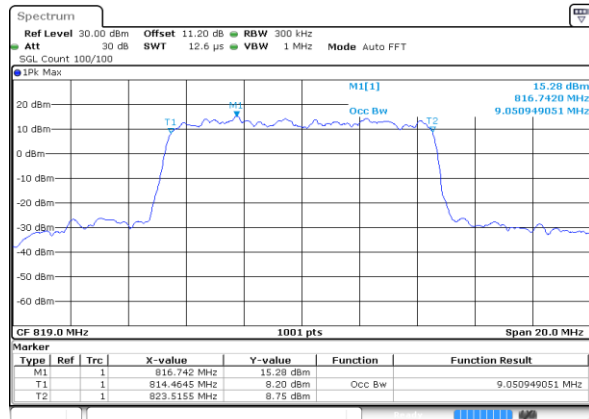

Date: 24 FEB 2021 19:29:36



LTE Band 26

Low Channel / 15MHz / QPSK

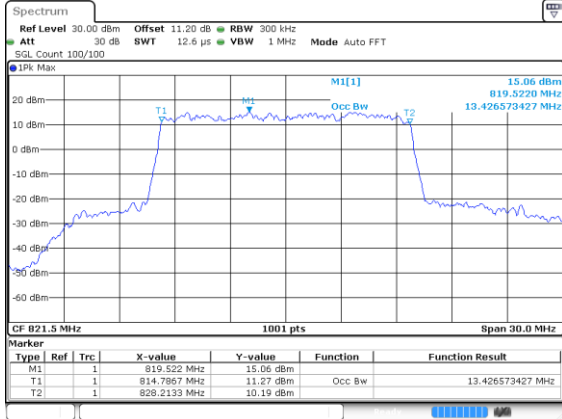

Date: 26 FEB 2021 19:33:11

Low Channel / 15MHz / 16QAM

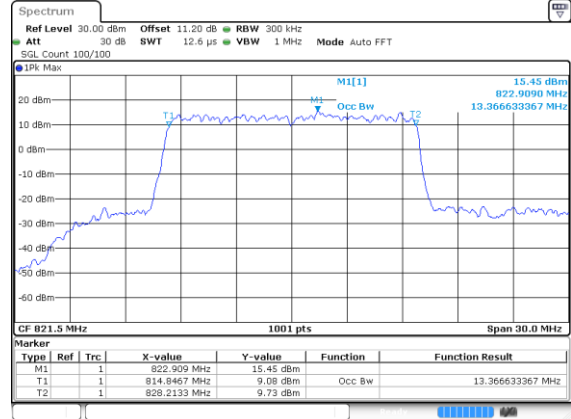

Date: 26 FEB 2021 19:32:05

Low Channel / 15MHz / 64QAM

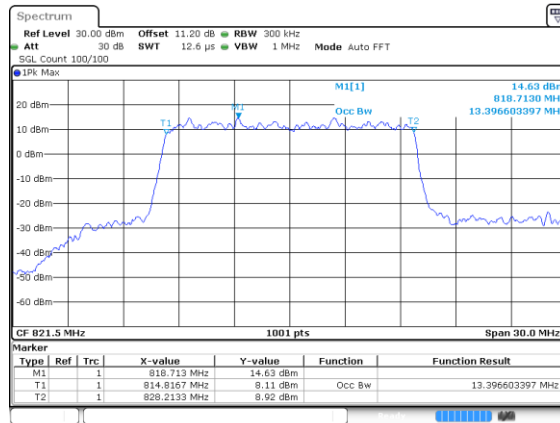

Date: 24 FEB 2021 19:27:35



Emission masks – In-band emissions

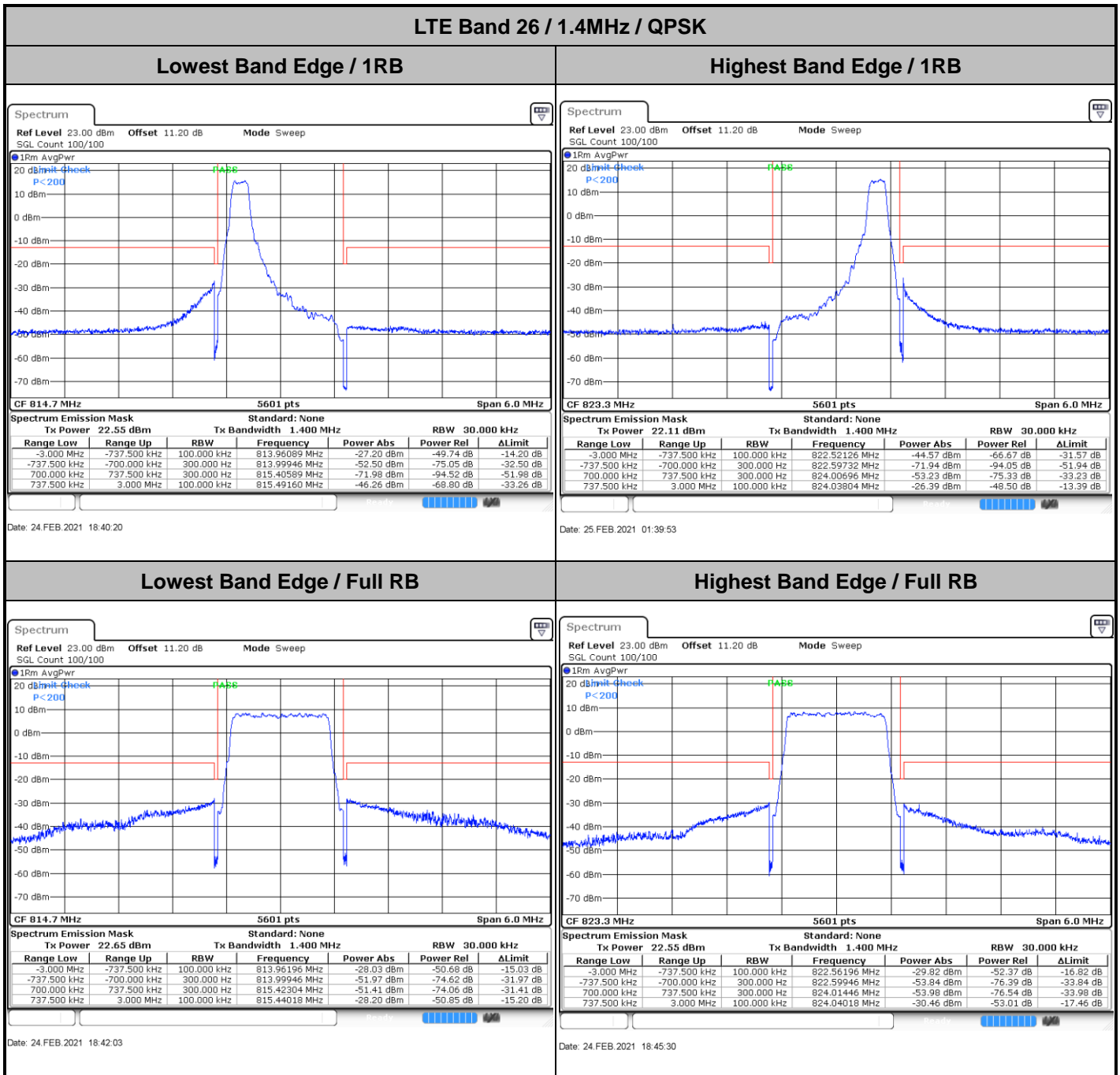



LTE Band 26 / 1.4MHz / 16QAM

Lowest Band Edge / 1 RB

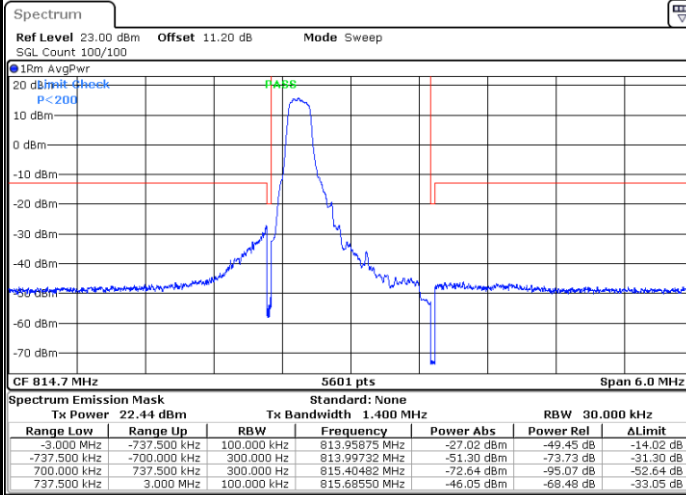

Date: 24 FEB 2021 18:41:11

Highest Band Edge / 1 RB

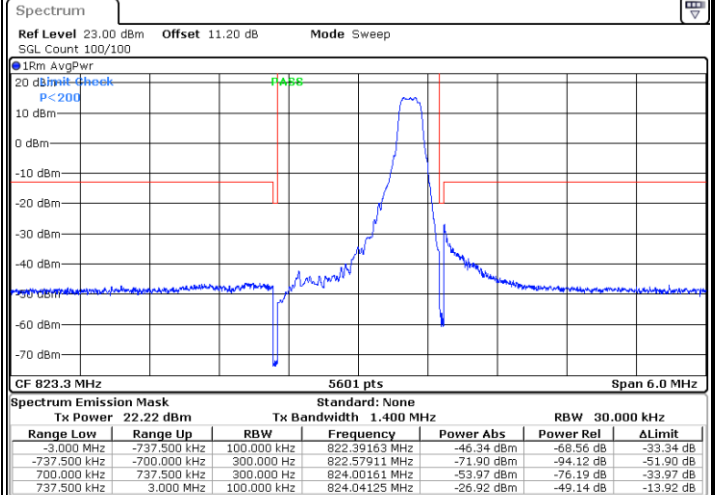

Date: 24 FEB 2021 18:44:38

Lowest Band Edge / Full RB

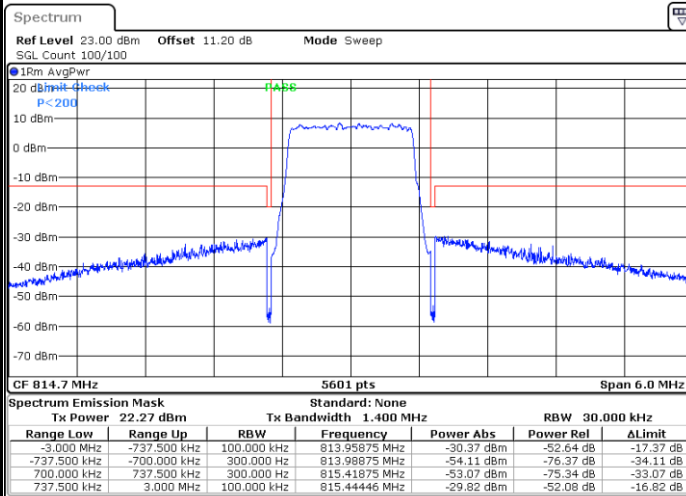

Date: 24 FEB 2021 18:42:54

Highest Band Edge / Full RB

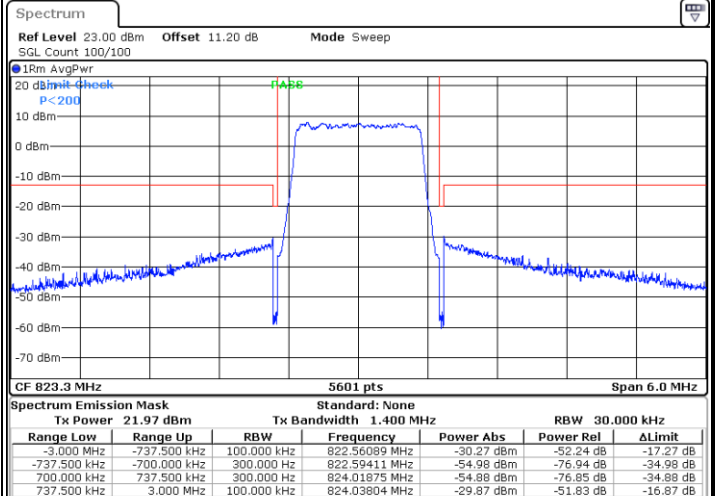

Date: 24 FEB 2021 18:46:21



LTE Band 26 / 1.4MHz / 64QAM

Lowest Band Edge / 1 RB

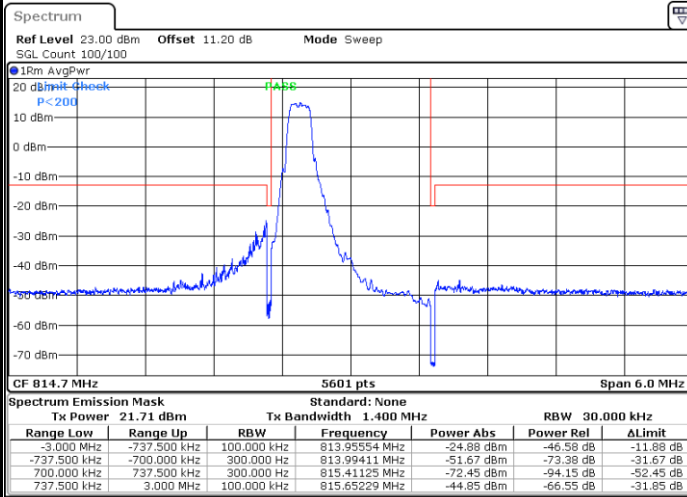

Date: 24 FEB 2021 18:47:13

Highest Band Edge / 1 RB

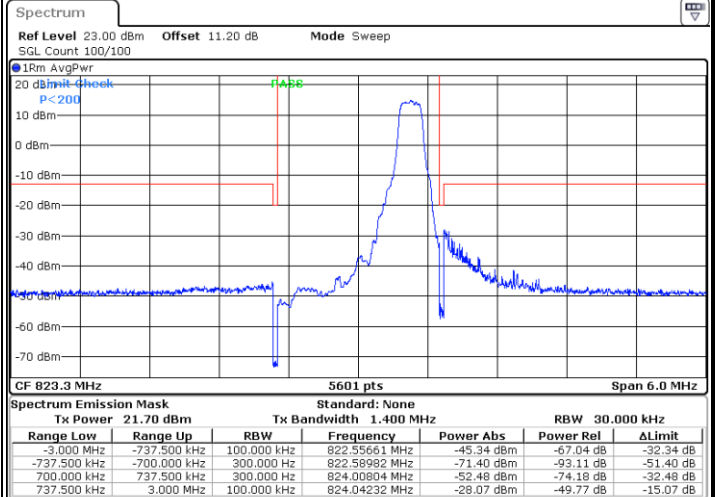

Date: 25 FEB 2021 01:38:44

Lowest Band Edge / Full RB

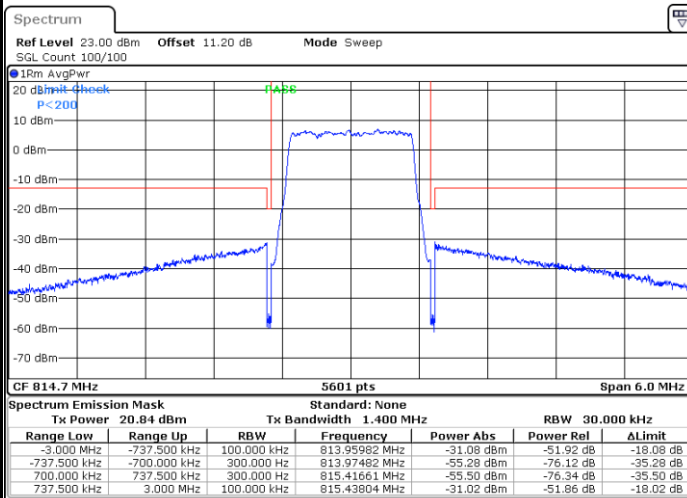

Date: 24 FEB 2021 18:48:05

Highest Band Edge / Full RB

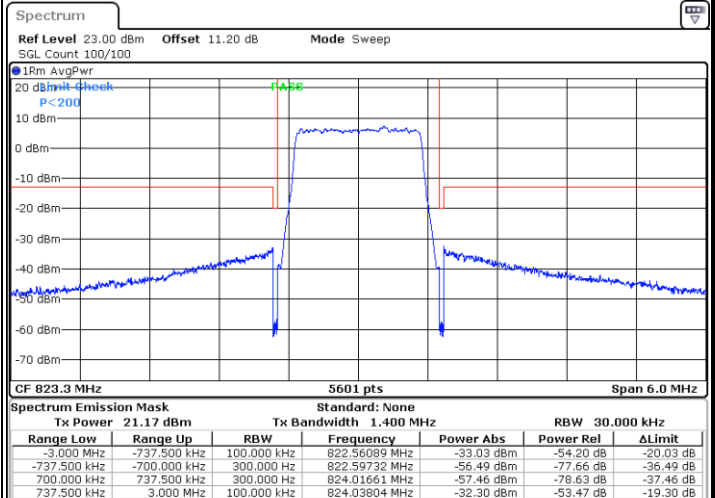

Date: 24 FEB 2021 18:49:49



LTE Band 26 / 3MHz / QPSK

Lowest Band Edge / 1RB

Highest Band Edge / 1 RB

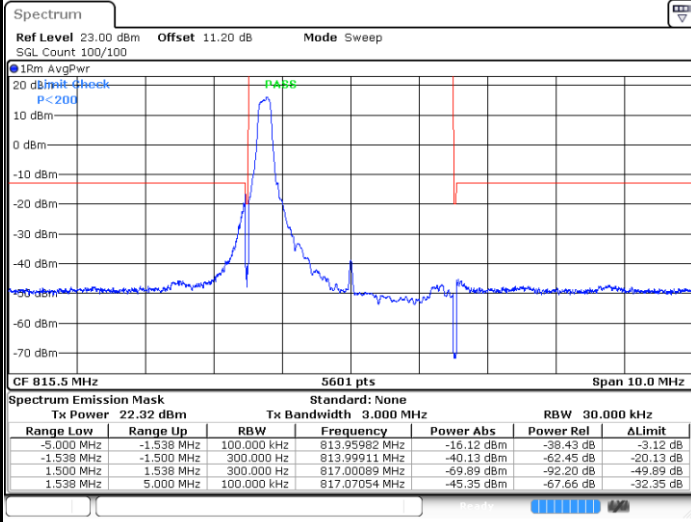

Date: 24 FEB 2021 18:50:41

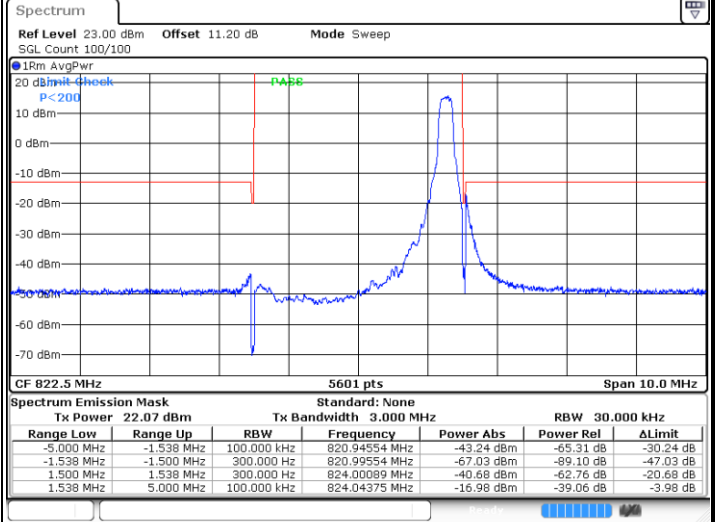

Date: 24 FEB 2021 18:54:09

Lowest Band Edge / Full RB

Highest Band Edge / Full RB

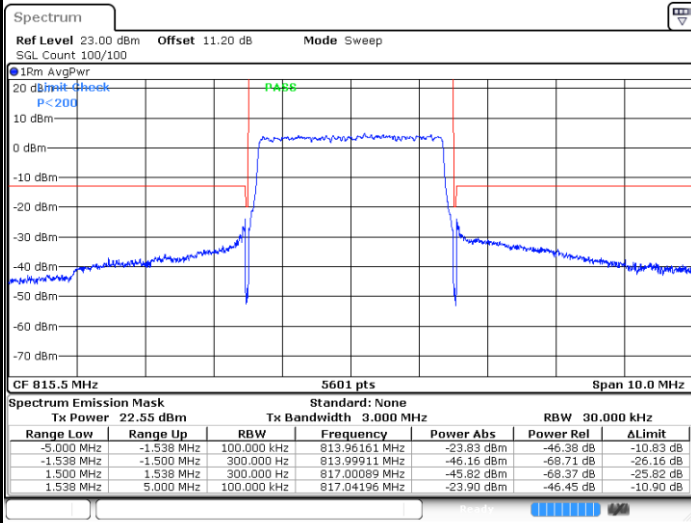

Date: 24 FEB 2021 18:52:25

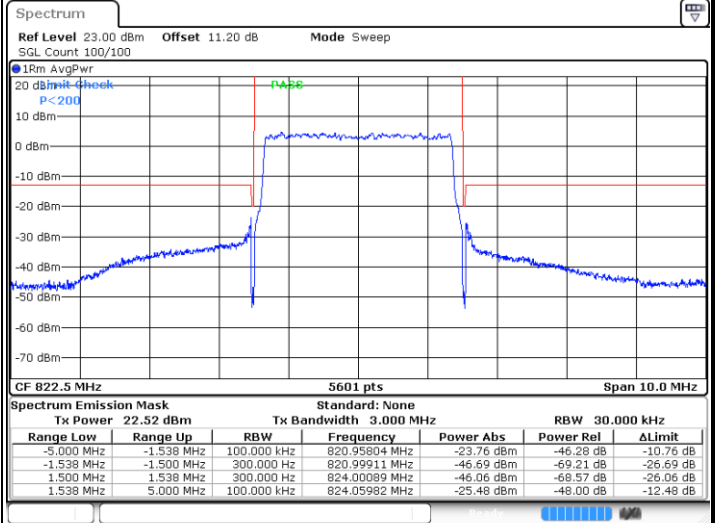

Date: 24 FEB 2021 18:55:53



LTE Band 26 / 3MHz / 16QAM

Lowest Band Edge / 1 RB

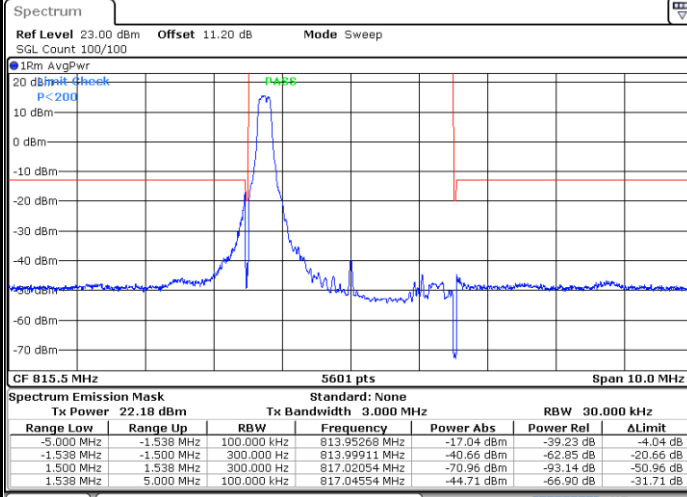

Date: 24 FEB 2021 18:51:33

Highest Band Edge / 1 RB

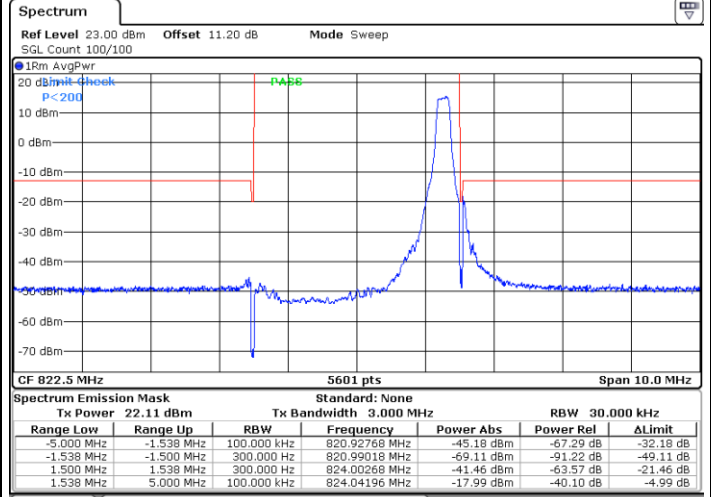

Date: 26 FEB 2021 03:16:27

Lowest Band Edge / Full RB

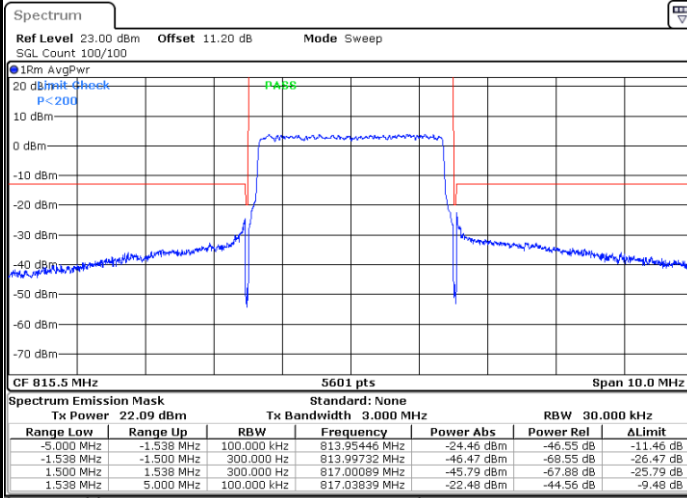

Date: 24 FEB 2021 18:53:17

Highest Band Edge / Full RB

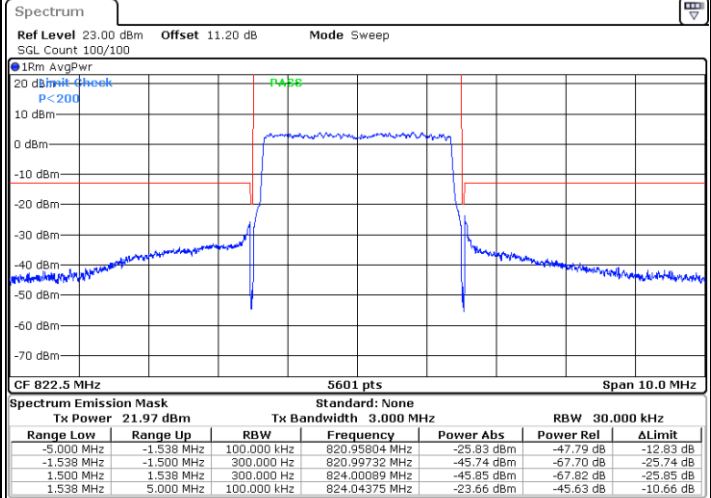

Date: 24 FEB 2021 18:56:45



LTE Band 26 / 3MHz / 64QAM

Lowest Band Edge / 1 RB

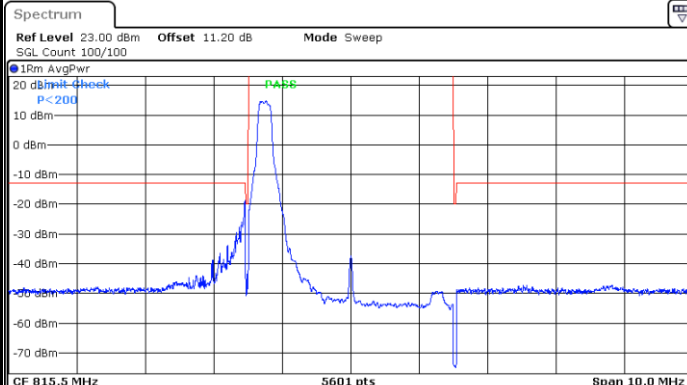

Date: 24 FEB 2021 19:15:29

Highest Band Edge / 1 RB

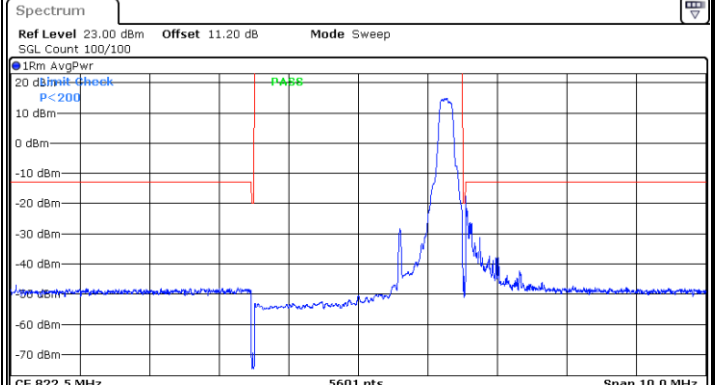

Date: 24 FEB 2021 19:17:13

Lowest Band Edge / Full RB

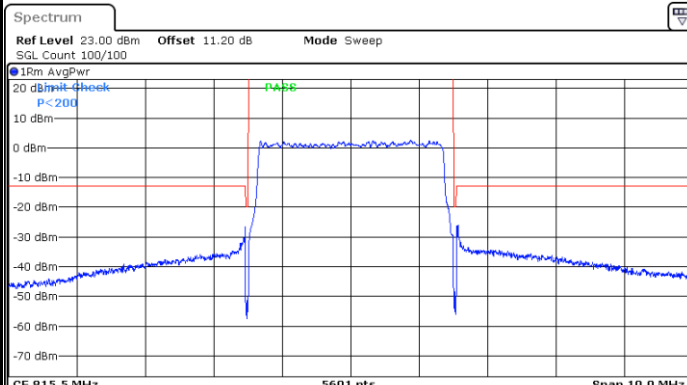

Date: 24 FEB 2021 19:16:21

Highest Band Edge / Full RB

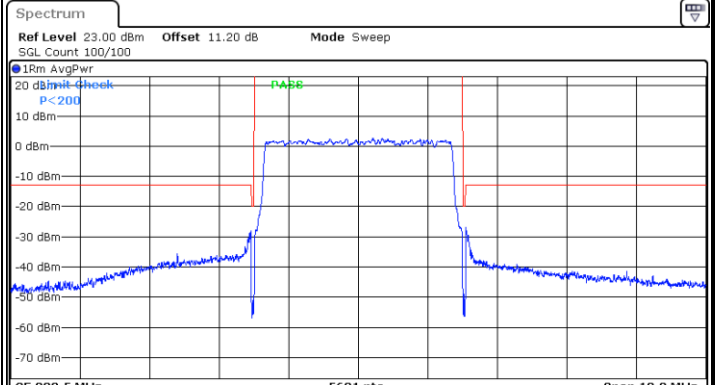

Date: 24 FEB 2021 19:18:05



LTE Band 26 / 5MHz / QPSK

Lowest Band Edge / 1 RB

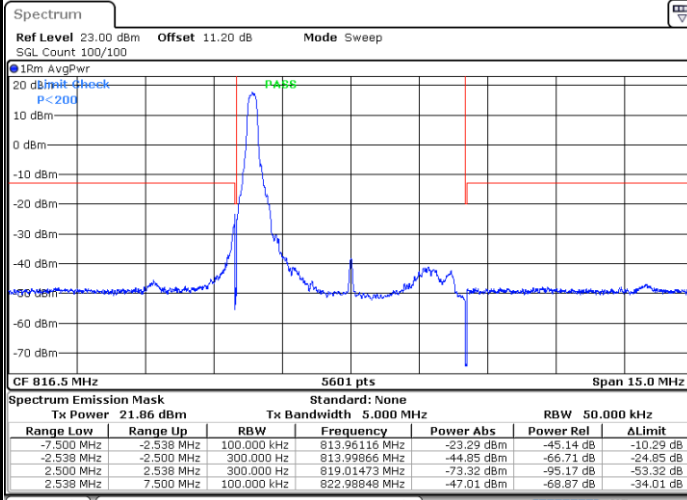

Date: 24 FEB 2021 18:57:38

Highest Band Edge / 1 RB

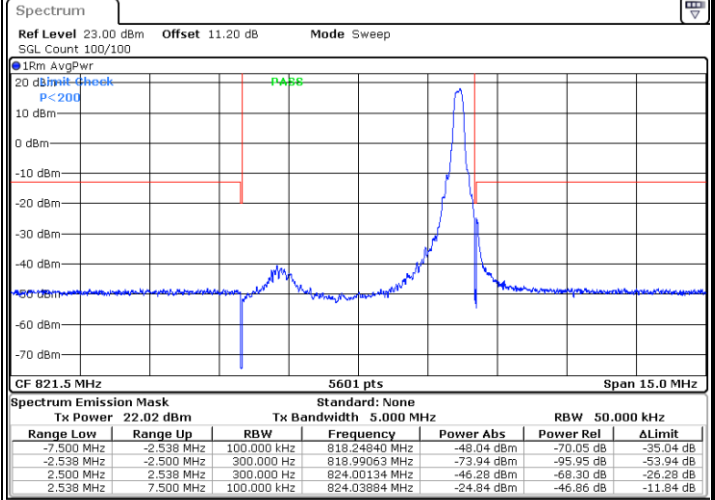

Date: 24 FEB 2021 19:01:04

Lowest Band Edge / Full RB

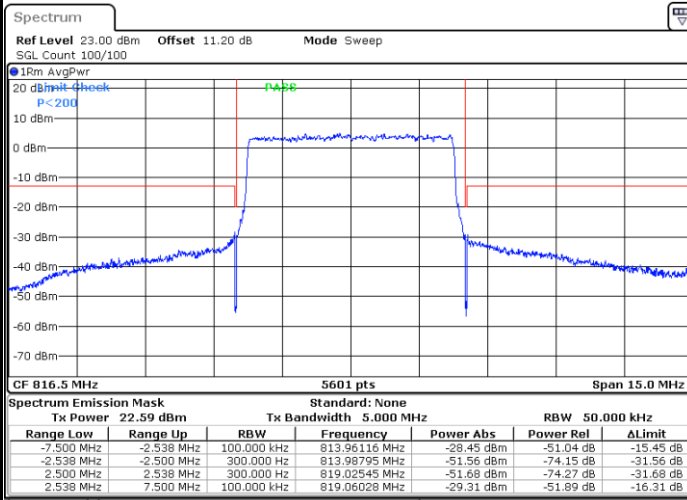

Date: 24 FEB 2021 18:59:21

Highest Band Edge / Full RB

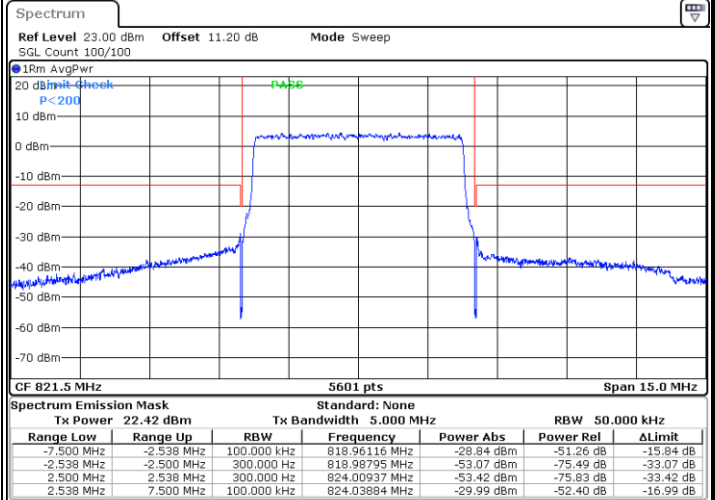

Date: 24 FEB 2021 19:02:47



LTE Band 26 / 5MHz / 16QAM

Lowest Band Edge / 1RB

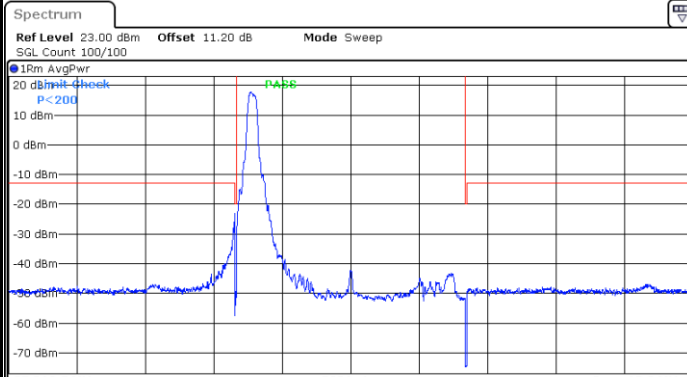

| Spectrum Emission Mask | | Standard: None | | RBW 50.000 kHz | | |
|------------------------|------------|----------------|---------------|----------------|-----------|-----------|
| Range Low | Range Up | RBW | Frequency | Power Abs | Power Rel | ALimit |
| -7.500 MHz | -2.538 MHz | 100.000 kHz | 813.96116 MHz | -23.19 dBm | -45.23 dB | -10.19 dB |
| -2.538 MHz | -2.500 MHz | 300.000 Hz | 813.98795 MHz | -47.10 dBm | -69.15 dB | -27.10 dB |
| 2.500 MHz | 2.538 MHz | 300.000 Hz | 819.01473 MHz | -73.90 dBm | -95.95 dB | -53.80 dB |
| 2.538 MHz | 7.500 MHz | 100.000 kHz | 823.00187 MHz | -46.98 dBm | -69.02 dB | -33.98 dB |

Date: 24 FEB 2021 18:58:29

Highest Band Edge / 1 RB

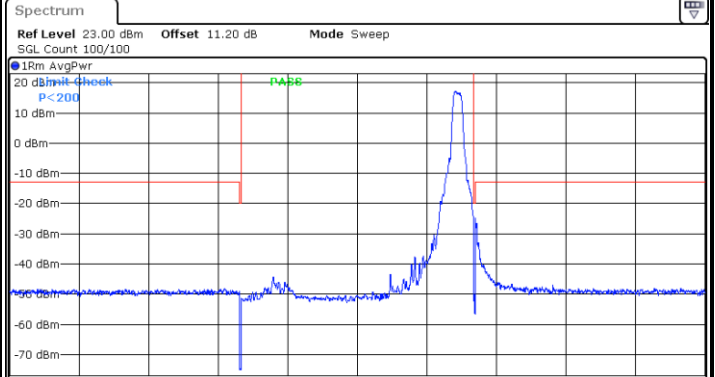

| Spectrum Emission Mask | | Standard: None | | RBW 50.000 kHz | | |
|------------------------|------------|----------------|---------------|----------------|-----------|-----------|
| Range Low | Range Up | RBW | Frequency | Power Abs | Power Rel | ALimit |
| -7.500 MHz | -2.538 MHz | 100.000 kHz | 818.62890 MHz | -48.18 dBm | -69.93 dB | -35.18 dB |
| -2.538 MHz | -2.500 MHz | 300.000 Hz | 818.99866 MHz | -74.11 dBm | -95.86 dB | -54.11 dB |
| 2.500 MHz | 2.538 MHz | 300.000 Hz | 824.00134 MHz | -47.33 dBm | -69.08 dB | -27.33 dB |
| 2.538 MHz | 7.500 MHz | 100.000 kHz | 824.03884 MHz | -24.70 dBm | -46.46 dB | -11.70 dB |

Date: 24 FEB 2021 19:01:56

Lowest Band Edge / Full RB

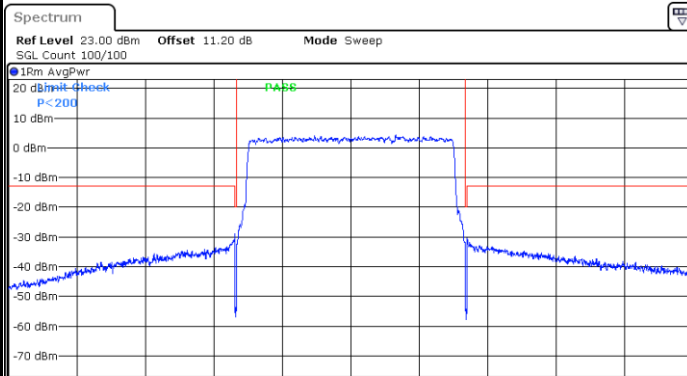

| Spectrum Emission Mask | | Standard: None | | RBW 50.000 kHz | | |
|------------------------|------------|----------------|---------------|----------------|-----------|-----------|
| Range Low | Range Up | RBW | Frequency | Power Abs | Power Rel | ALimit |
| -7.500 MHz | -2.538 MHz | 100.000 kHz | 813.96116 MHz | -28.79 dBm | -50.81 dB | -15.79 dB |
| -2.538 MHz | -2.500 MHz | 300.000 Hz | 813.99866 MHz | -52.99 dBm | -75.01 dB | -32.99 dB |
| 2.500 MHz | 2.538 MHz | 300.000 Hz | 819.00937 MHz | -52.75 dBm | -74.77 dB | -32.75 dB |
| 2.538 MHz | 7.500 MHz | 100.000 kHz | 819.03884 MHz | -30.44 dBm | -52.46 dB | -17.44 dB |

Date: 24 FEB 2021 19:00:12

Highest Band Edge / Full RB

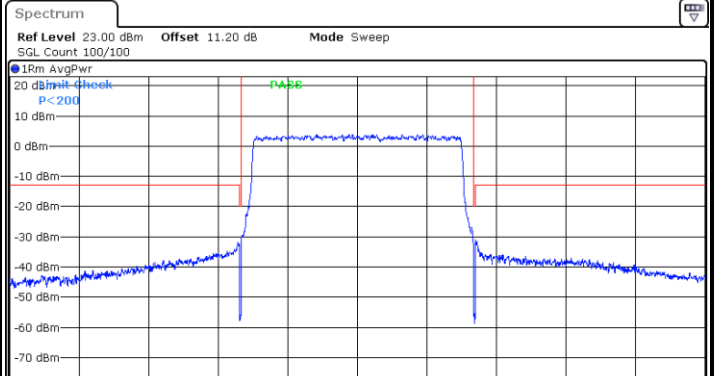

| Spectrum Emission Mask | | Standard: None | | RBW 50.000 kHz | | |
|------------------------|------------|----------------|---------------|----------------|-----------|-----------|
| Range Low | Range Up | RBW | Frequency | Power Abs | Power Rel | ALimit |
| -7.500 MHz | -2.538 MHz | 100.000 kHz | 818.92097 MHz | -31.94 dBm | -53.93 dB | -18.94 dB |
| -2.538 MHz | -2.500 MHz | 300.000 Hz | 818.99053 MHz | -53.45 dBm | -75.44 dB | -33.45 dB |
| 2.500 MHz | 2.538 MHz | 300.000 Hz | 824.00134 MHz | -54.09 dBm | -76.08 dB | -34.09 dB |
| 2.538 MHz | 7.500 MHz | 100.000 kHz | 824.03884 MHz | -30.99 dBm | -52.98 dB | -17.99 dB |

Date: 24 FEB 2021 19:03:39



LTE Band 26 / 5MHz / 64QAM

Lowest Band Edge / 1RB

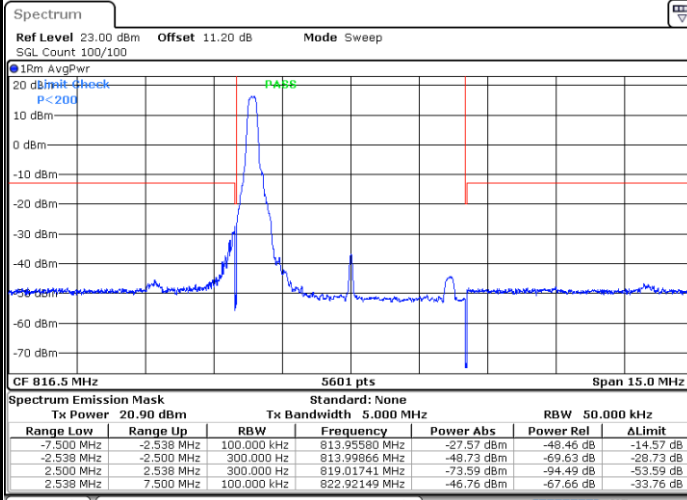

Date: 24 FEB 2021 19:18:58

Highest Band Edge / 1 RB

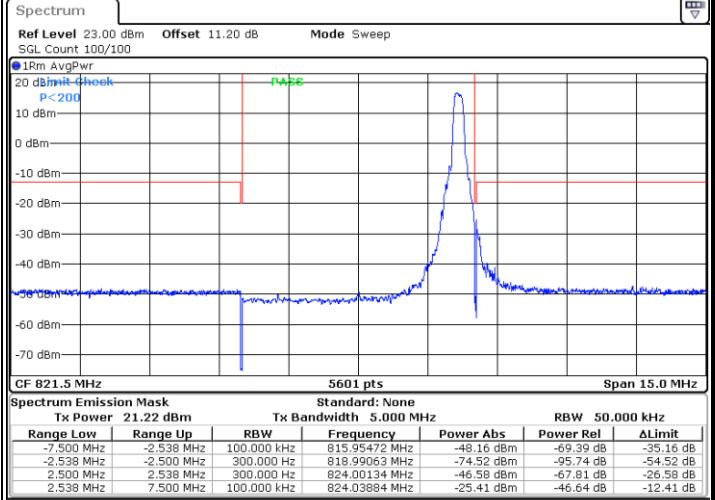

Date: 24 FEB 2021 19:20:41

Lowest Band Edge / Full RB

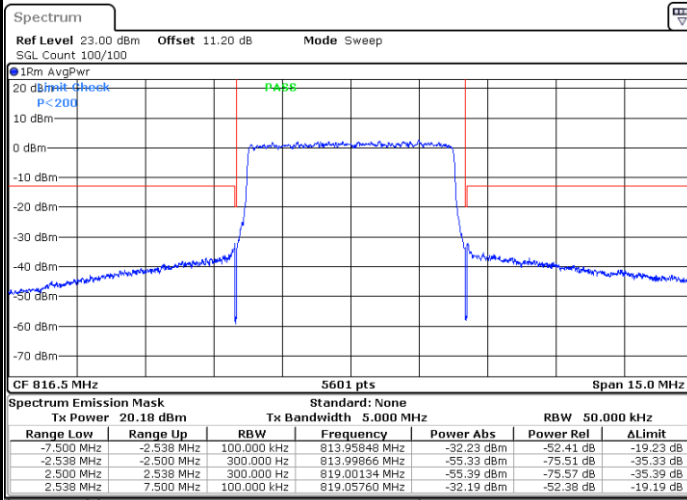

Date: 24 FEB 2021 19:19:49

Highest Band Edge / Full RB

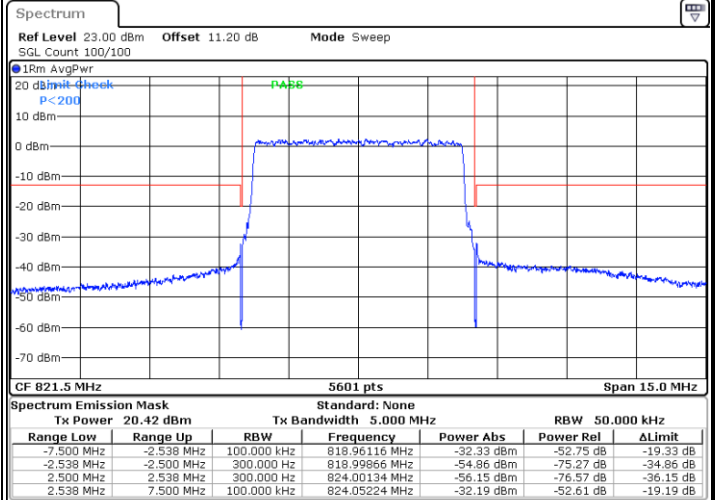

Date: 24 FEB 2021 19:21:33



LTE Band 26 / 10MHz / QPSK

Lowest Band Edge / 1 RB

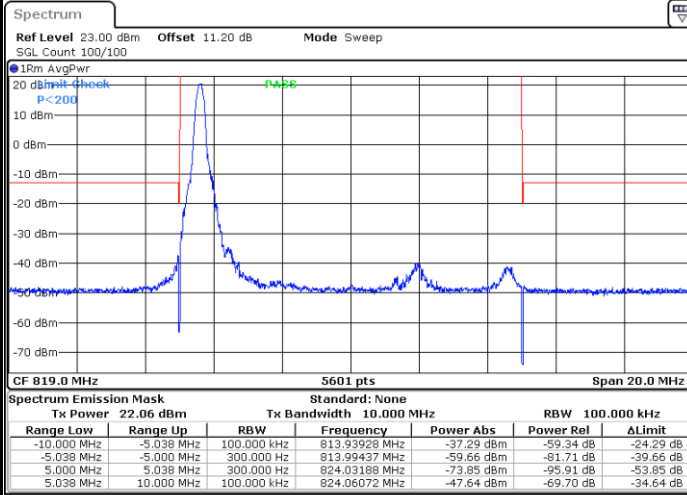

Date: 24.FEB.2021 19:04:32

Highest Band Edge / 1 RB

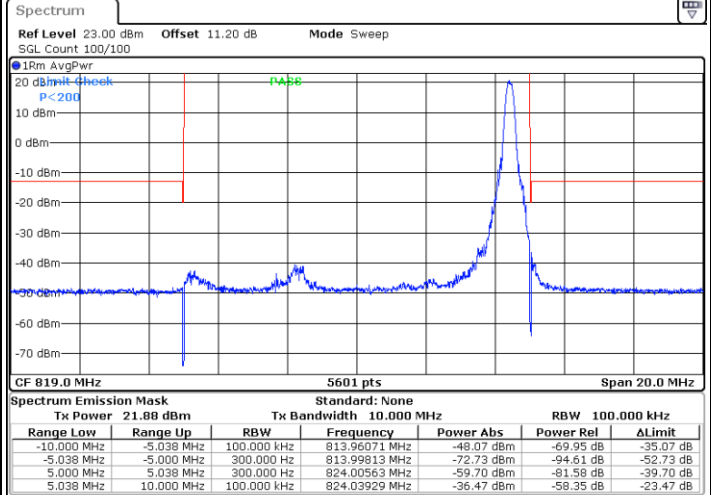

Date: 24.FEB.2021 19:06:15

Lowest Band Edge / Full RB

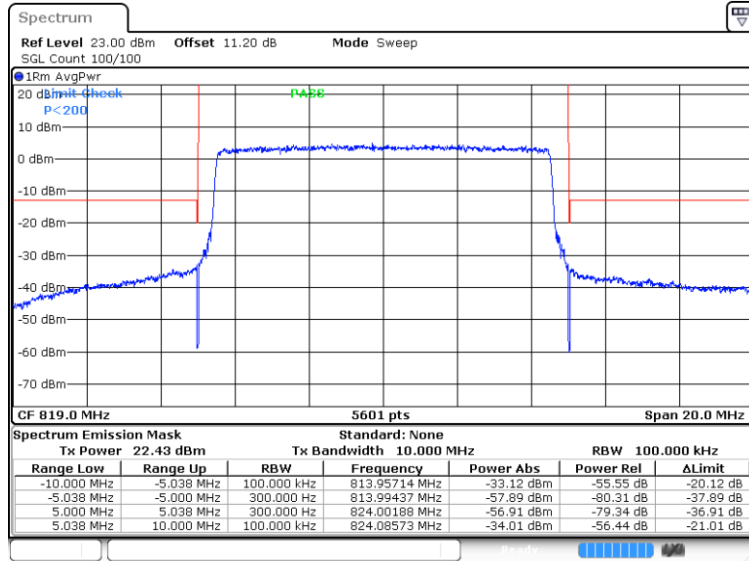

Date: 24.FEB.2021 19:07:58



LTE Band 26 / 10MHz / 16QAM

Lowest Band Edge / 1 RB

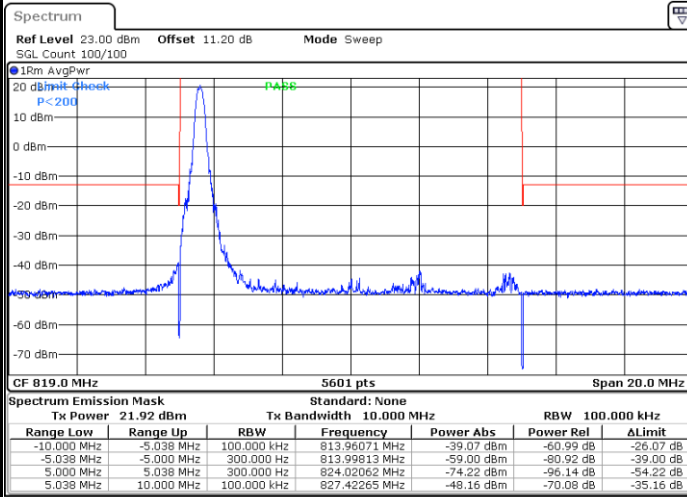

Date: 24.FEB.2021 19:05:23

Highest Band Edge / 1 RB

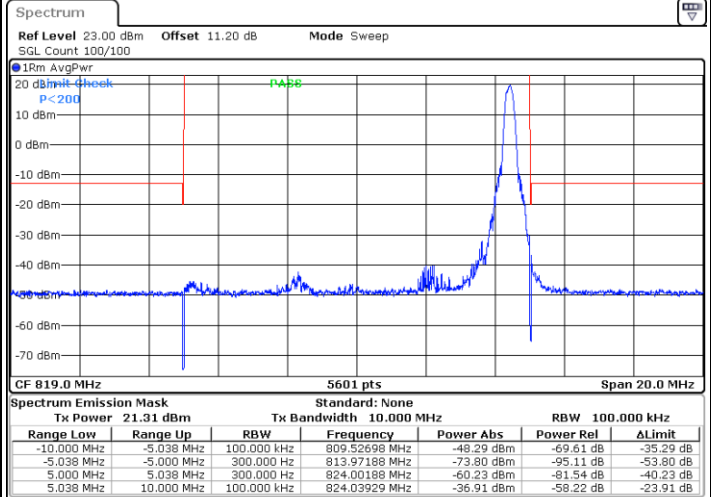

Date: 24.FEB.2021 19:07:06

Lowest Band Edge / Full RB

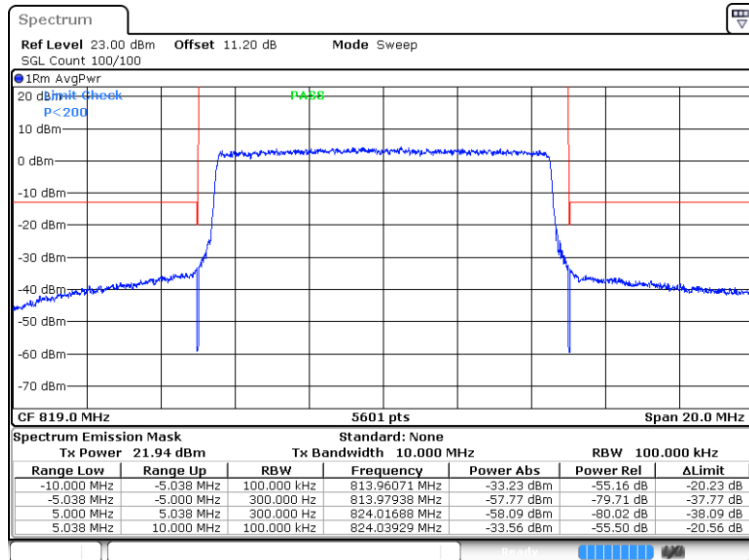

Date: 24.FEB.2021 19:08:49



LTE Band 26 / 10MHz / 64QAM

Lowest Band Edge / 1 RB

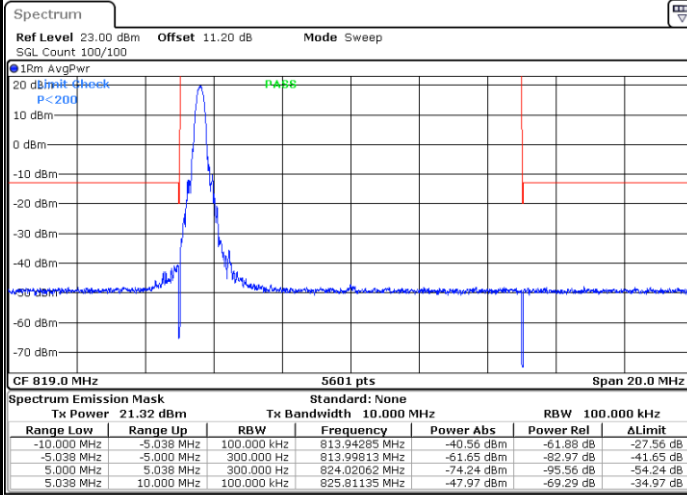

Date: 24.FEB.2021 19:22:26

Highest Band Edge / 1 RB

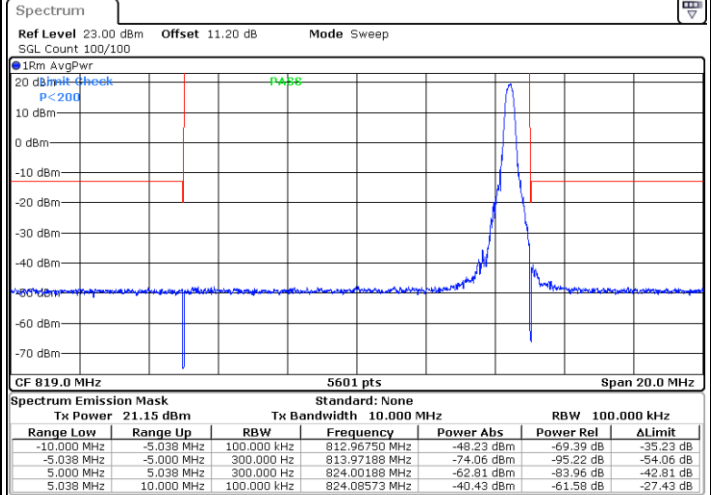

Date: 24.FEB.2021 19:23:17

Lowest Band Edge / Full RB

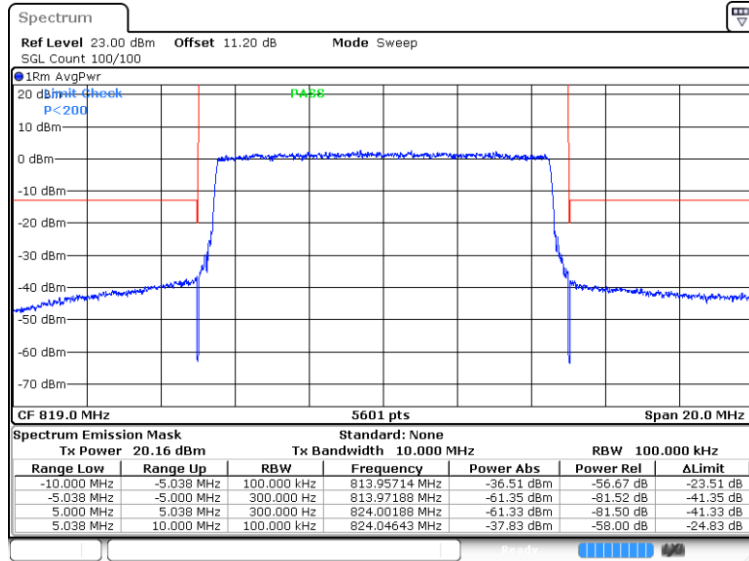

Date: 24.FEB.2021 19:24:09



LTE Band 26 / 15MHz / QPSK

Lowest Band Edge / 1 RB

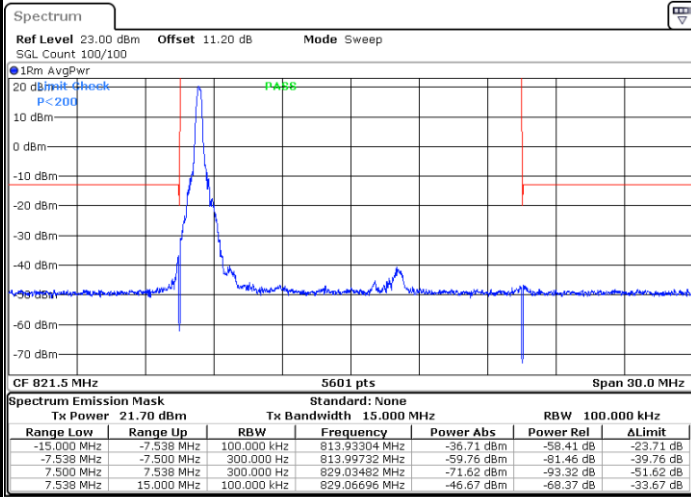

Date: 24.FEB.2021 19:10:18

Highest Band Edge / 1 RB

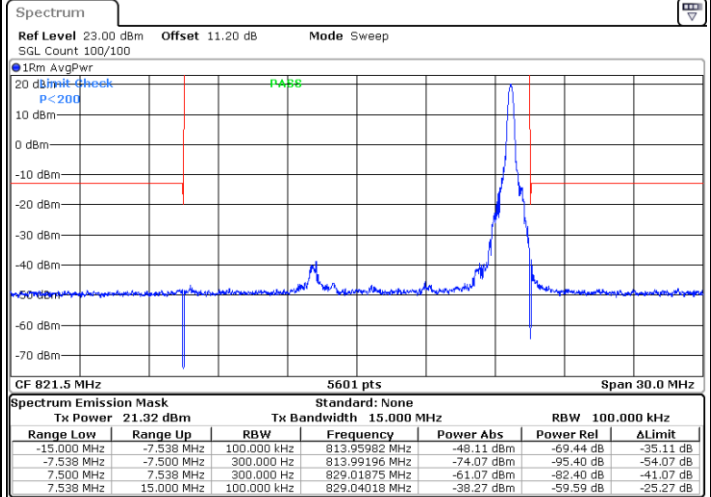

Date: 24.FEB.2021 19:12:01

Lowest Band Edge / Full RB

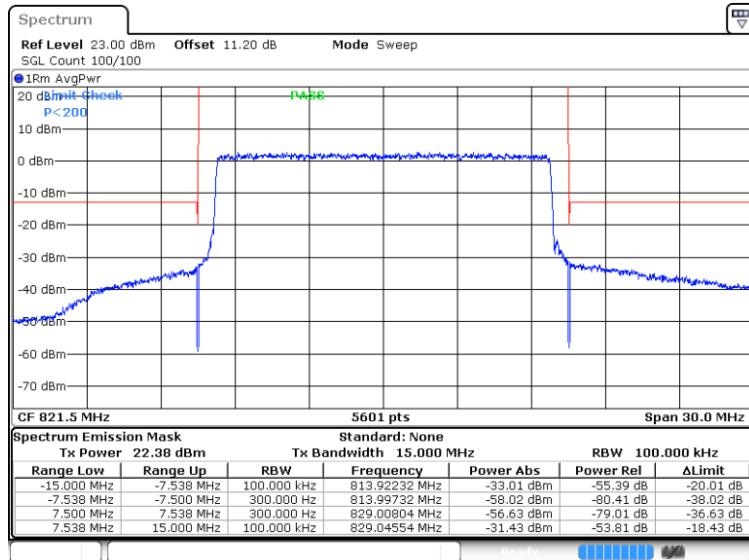

Date: 24.FEB.2021 19:13:44



LTE Band 26 / 15MHz / 16QAM

Lowest Band Edge / 1 RB

Highest Band Edge / 1 RB

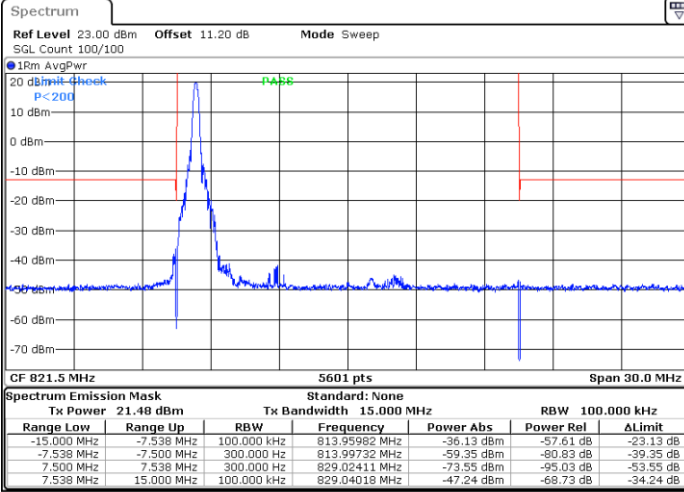

Date: 24.FEB.2021 19:11:10

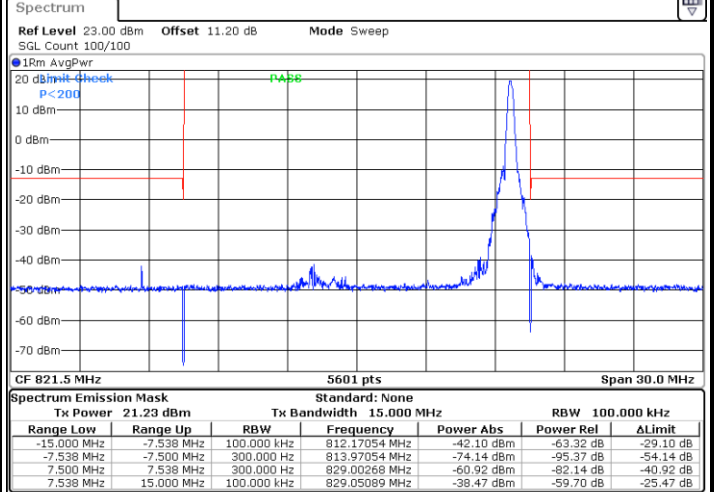

Date: 24.FEB.2021 19:12:53

Lowest Band Edge / Full RB

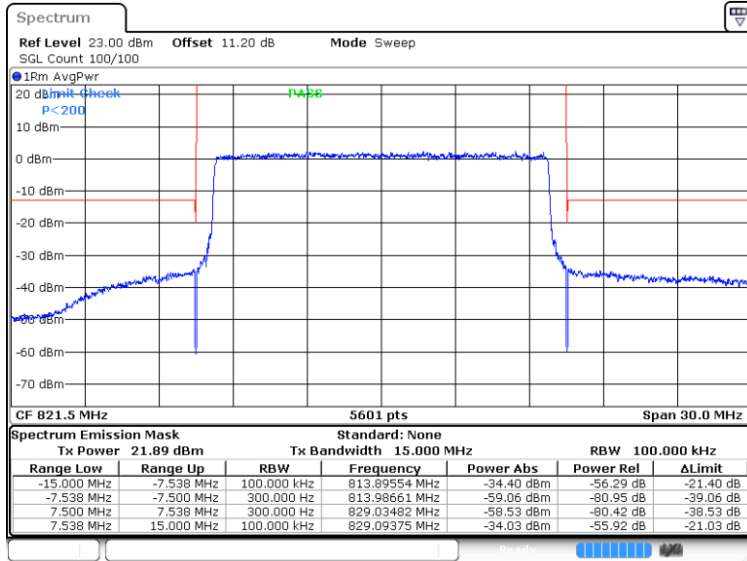

Date: 24.FEB.2021 19:14:36



LTE Band 26 / 15MHz / 64QAM

Lowest Band Edge / 1 RB

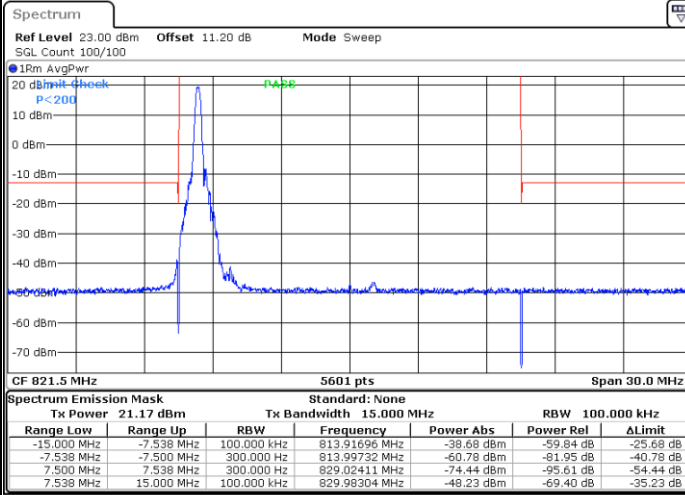

Date: 24.FEB.2021 19:25:38

Highest Band Edge / 1 RB

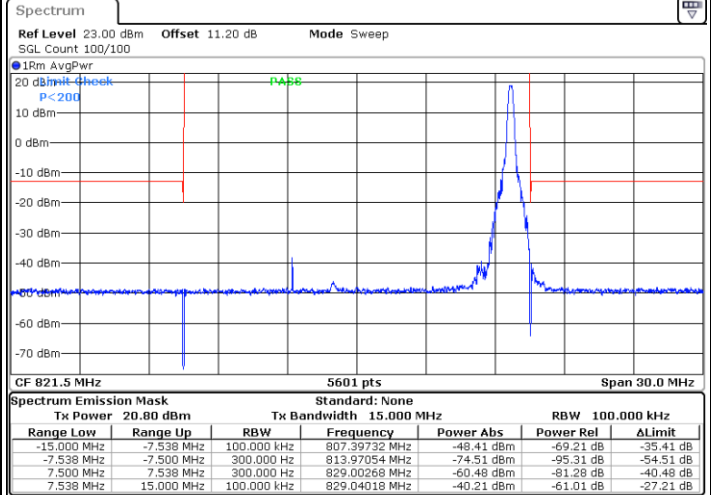

Date: 24.FEB.2021 19:26:29

Lowest Band Edge / Full RB

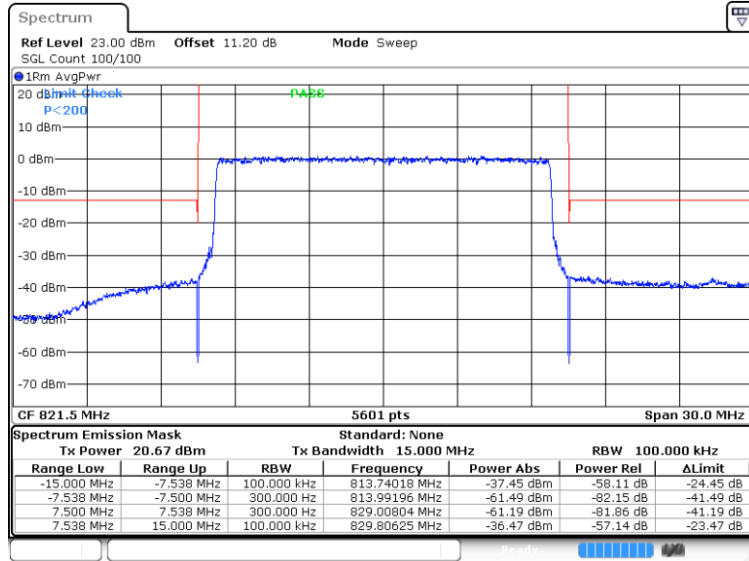

Date: 24.FEB.2021 19:27:21