



SETUP PHOTO EXHIBIT

Report Number: R14634918-EP2

Applicant : Sony Corporation
1-7-1 Konan Minat-Ku
Tokyo, 108-0075, Japan

FCC ID : PY7-12907W

EUT Description : GSM/WCDMA/LTE/5G Phone with BT, DTS/UNII a/b/g/n/ac/ax, GPS,
WPT & NFC

Test Standard(s) : FCC 47 CFR Part 15 Subpart C

Date Of Issue:
2023-02-24

Prepared by:
UL LLC
12 Laboratory Dr.
Research Triangle Park, NC 27709 U.S.A.
TEL: (919) 549-1400



REPORT REVISION HISTORY

Rev.	Issue Date	Revisions	Revised By
V1	2023-02-24	Initial Issue	Charles Moody

TABLE OF CONTENTS

REPORT REVISION HISTORY	2
TABLE OF CONTENTS	3
1. SETUP DIAGRAMS	4
2. SETUP PHOTOS.....	5
END OF TEST REPORT	12

1. SETUP DIAGRAMS

Conducted:

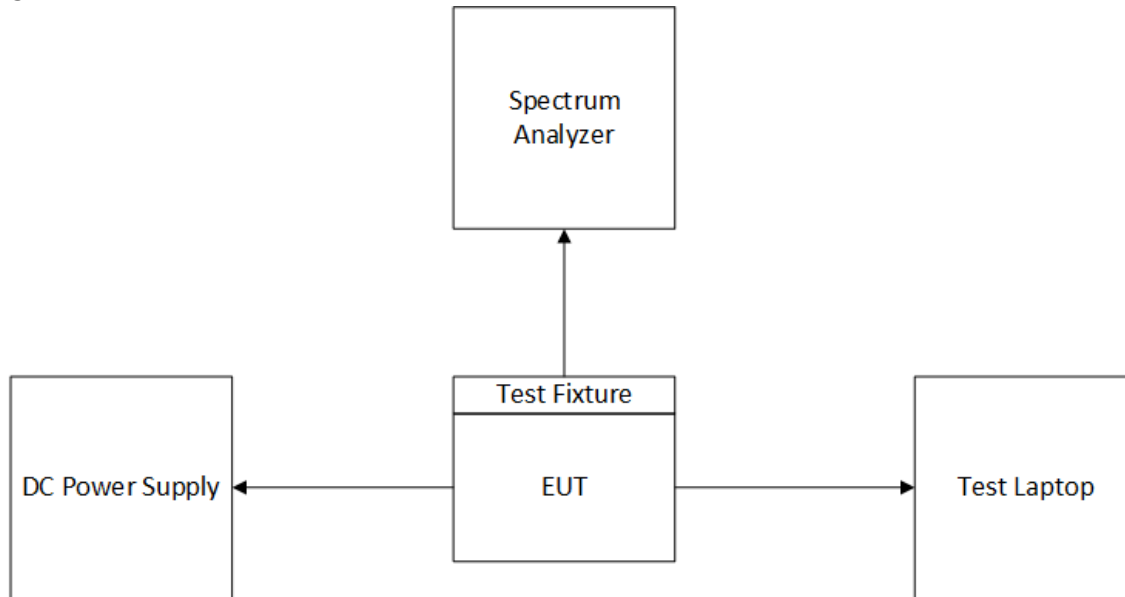

Radiated:

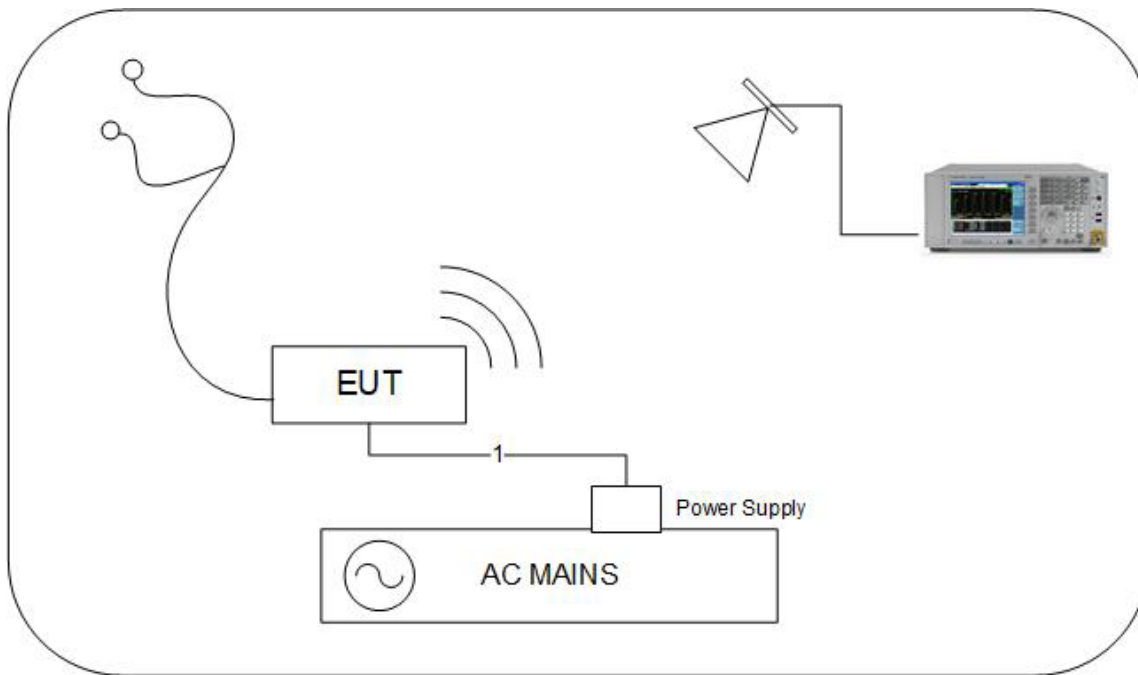

2. SETUP PHOTOS

CONDUCTED MEASUREMENT SETUP

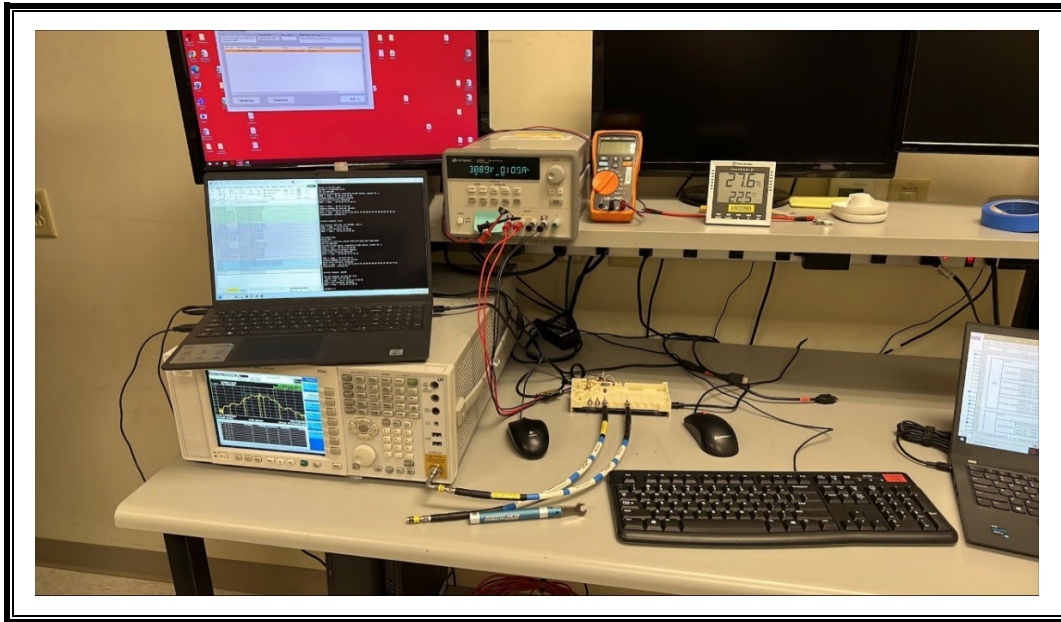

RADIATED RF MEASUREMENT SETUP

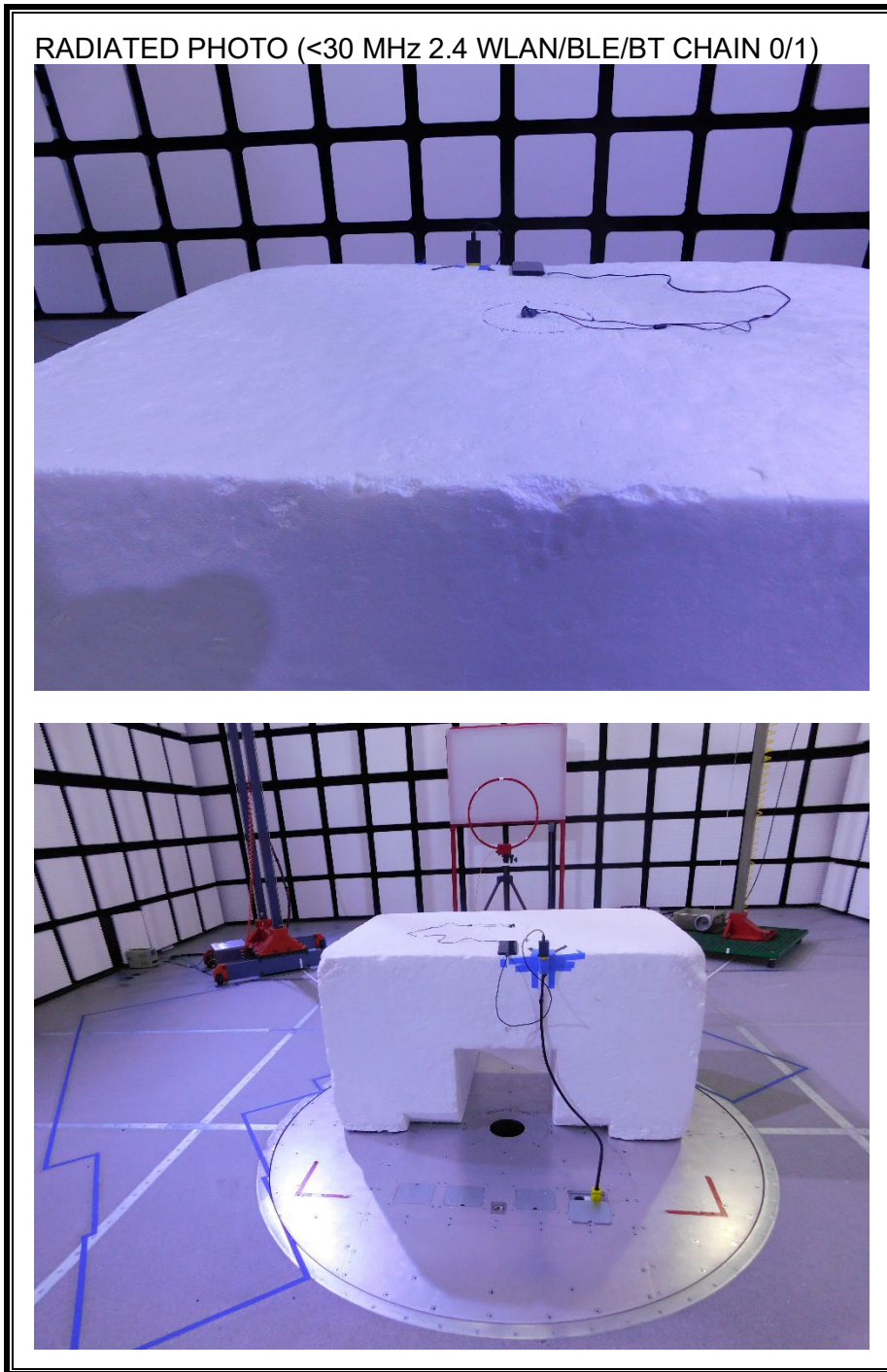

RADIATED PHOTO (<30 MHz 2.4 WLAN/BLE/BT CHAIN 0/1)

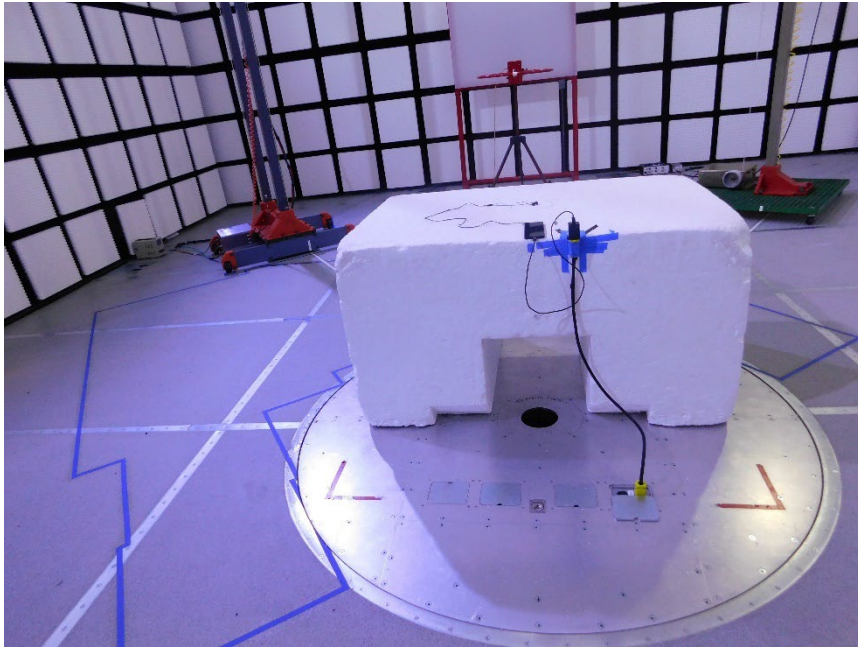
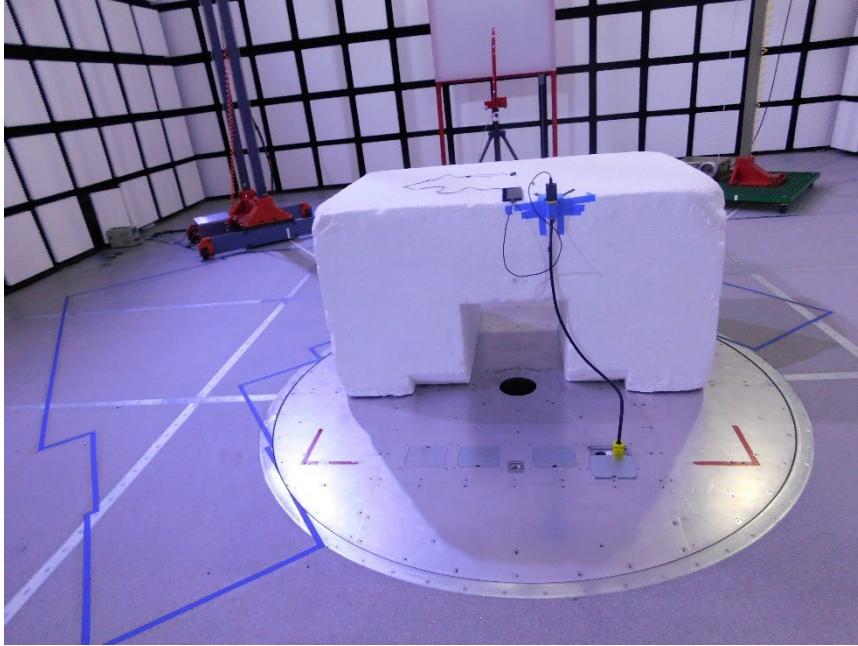

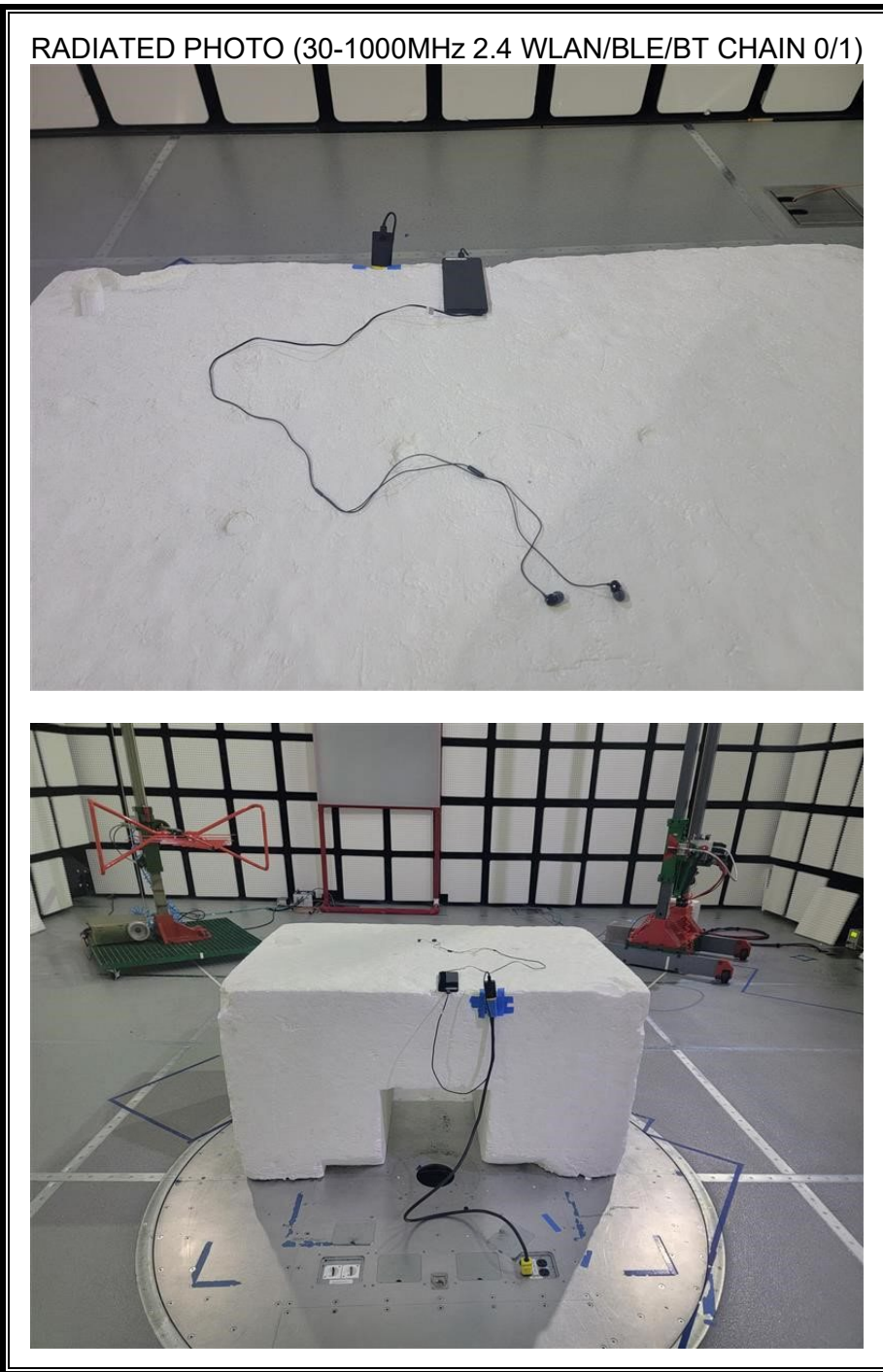

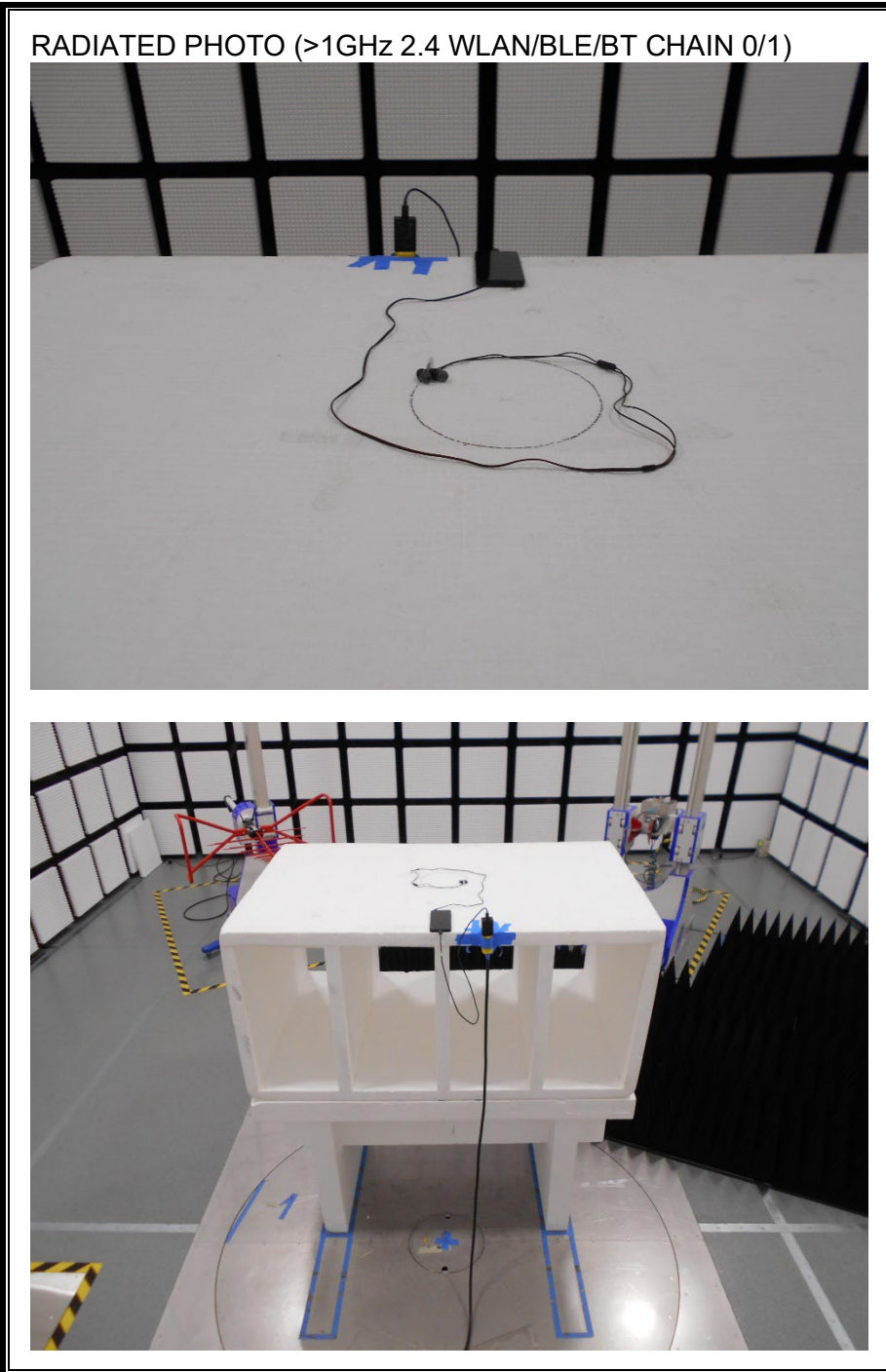

XYZ SETUP PHOTOS

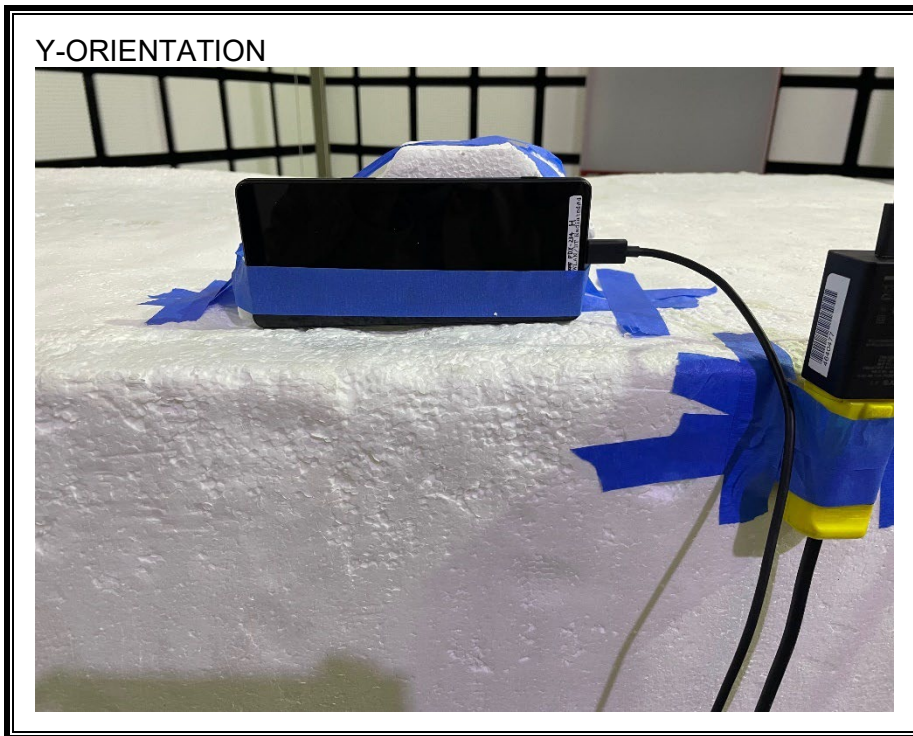
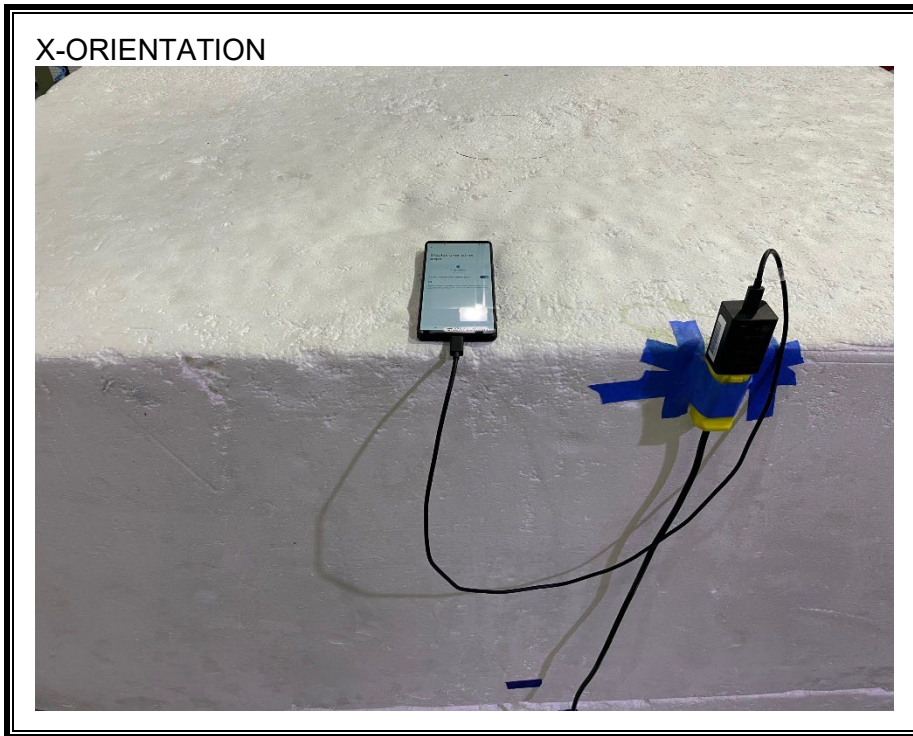

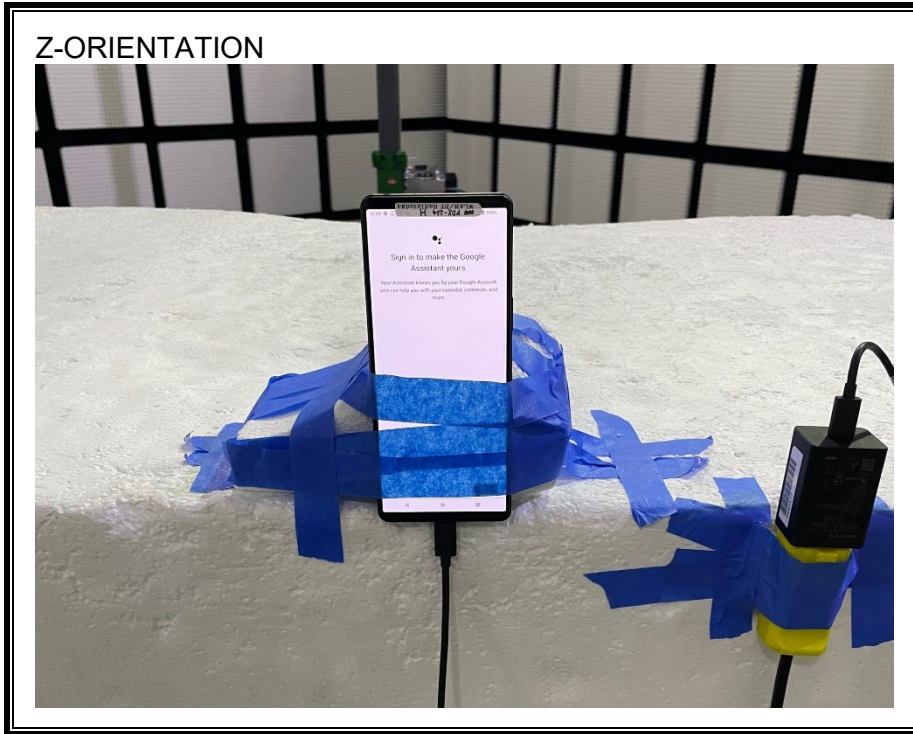

AC MAINS LINE CONDUCTED MEASUREMENT SETUP

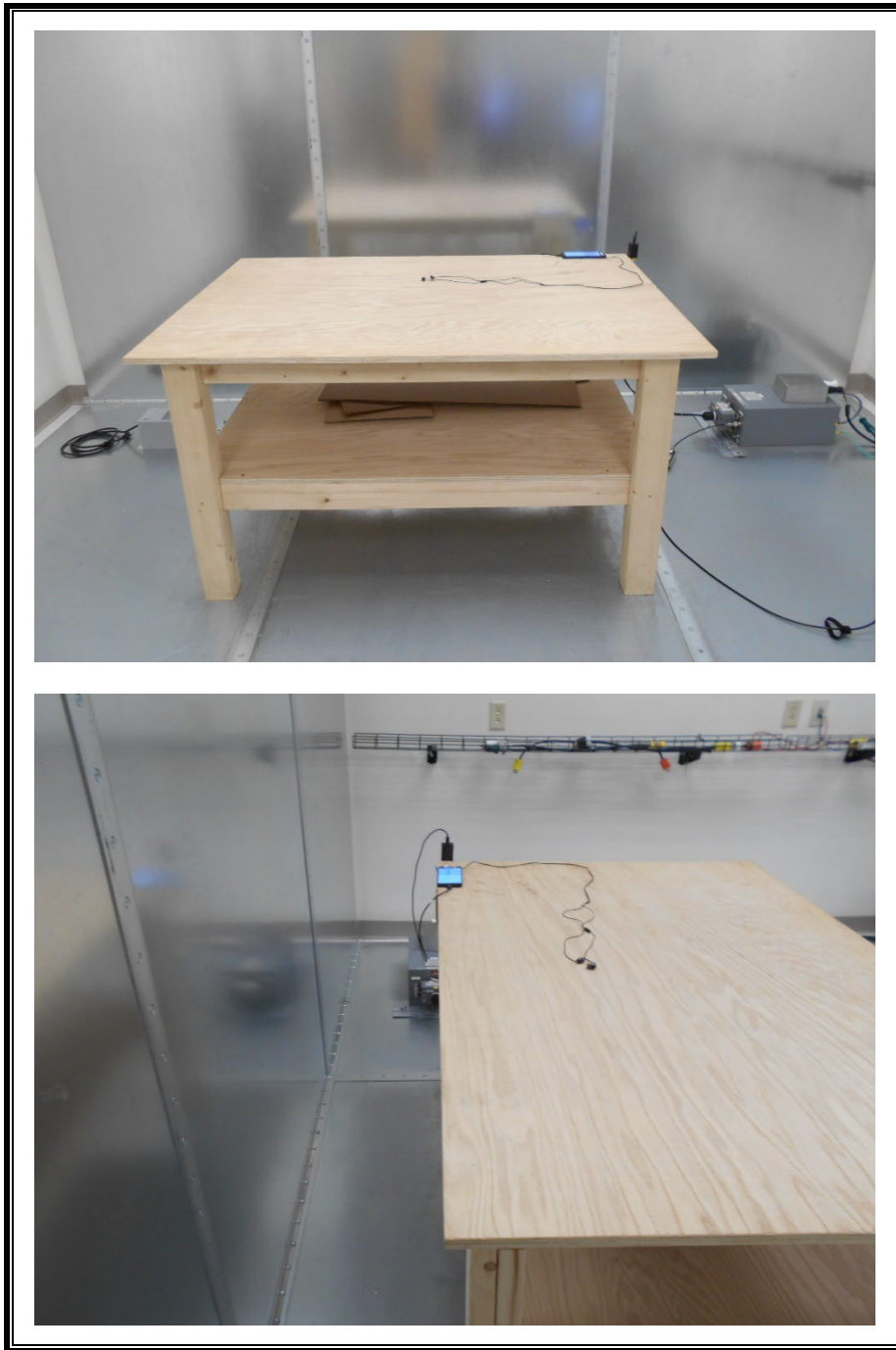

END OF TEST REPORT