

FCC Test Report

FCC ID : Z64-2564N
Equipment : CC2564 Bluetooth HCI Module
Model No. : CC2564MODN
Brand Name : Texas Instruments
Applicant : Texas Instruments Inc
Address : 12500 TI Blvd, Dallas USA 75243
Standard : 47 CFR FCC Part 15.247
Received Date : Dec. 04, 2013
Tested Date : Dec. 18, 2013 ~ Feb. 27, 2014

We, International Certification Corp., would like to declare that the tested sample has been evaluated and in compliance with the requirement of the above standards. The test results contained in this report refer exclusively to the product. It may be duplicated completely for legal use with the approval of the applicant. It shall not be reproduced except in full without the written approval of our laboratory.

Approved & Reviewed by:



Gary Chang / Manager



Table of Contents

1	GENERAL DESCRIPTION	5
1.1	Information.....	5
1.2	Local Support Equipment List	7
1.3	Test Setup Chart	7
1.4	Test Equipment List and Calibration Data.....	8
1.5	Test Standards	9
1.6	Measurement Uncertainty	10
2	TEST CONFIGURATION	11
2.1	Testing Condition	11
2.2	The Worst Test Modes and Channel Details	11
3	TRANSMITTER TEST RESULTS.....	12
3.1	AC Power Line Conducted Emissions	12
3.2	6dB and Occupied Bandwidth	15
3.3	RF Output Power.....	18
3.4	Power Spectral Density	20
3.5	Emissions in Restricted Frequency Bands.....	22
3.6	Emissions in non-restricted Frequency Bands.....	32
4	TEST LABORATORY INFORMATION	35

Release Record

Report No.	Version	Description	Issued Date
FR3D0402AE	Rev. 01	Initial issue	Mar. 26, 2014

Summary of Test Results

FCC Rules	Test Items	Measured	Result
15.207	AC Power Line Conducted Emissions	[dBuV]: 0.303MHz 36.74 (Margin -13.41dB) - AV	Pass
15.247(d) 15.209	Radiated Emissions	[dBuV/m at 3m]: 4804.00MHz 51.97 (Margin -2.03dB) - AV	Pass
15.247(b)(3)	Fundamental Emission Output Power	Power [dBm]: 11.36	Pass
15.247(a)(2)	6dB Bandwidth	Meet the requirement of limit	Pass
15.247(e)	Power Spectral Density	Meet the requirement of limit	Pass
15.203	Antenna Requirement	Meet the requirement of limit	Pass

1 General Description

1.1 Information

1.1.1 Specification of the Equipment under Test (EUT)

RF General Information				
Frequency Range (MHz)	Bluetooth Mode	Ch. Frequency (MHz)	Channel Number	Data Rate
2400-2483.5	V4.0 LE	2402-2480	0-39 [40]	1 Mbps
Note 1: Bluetooth LE (Low energy) uses GFSK modulation.				

1.1.2 Antenna Details

Ant. No.	Type	Gain (dBi)	Brand	Model
1	Chip antenna	-1.38	MAG.LAYERS	LTA-5320-2G4S3-A1

1.1.3 EUT Operational Condition

Type of Power Supply	3.3Vdc from host
----------------------	------------------

1.1.4 Accessories

N/A

1.1.5 Channel List

Frequency band (MHz)				2400~2483.5			
Channel	Frequency (MHz)	Channel	Frequency (MHz)	Channel	Frequency (MHz)	Channel	Frequency (MHz)
37	2402	9	2422	18	2442	28	2462
0	2404	10	2424	19	2444	29	2464
1	2406	38	2426	20	2446	30	2466
2	2408	11	2428	21	2448	31	2468
3	2410	12	2430	22	2450	32	2470
4	2412	13	2432	23	2452	33	2472
5	2414	14	2434	24	2454	34	2474
6	2416	15	2436	25	2456	35	2476
7	2418	16	2438	26	2458	36	2478
8	2420	17	2440	27	2460	39	2480

1.1.6 Test Tool

Test tool	HCI Tester V.3.0.0.24
-----------	-----------------------

1.1.7 Power Setting

Modulation Mode	Test Frequency (MHz)		
	2402	2440	2480
GFSK/1Mbps	0x10	0x10	0x10

1.2 Local Support Equipment List

Support Equipment List						
No.	Equipment	Brand	Model	S/N	FCC ID	Signal cable / Length (m)
1	Notebook	DELL	E5420	---	DoC	RS232, 3m non-shielded
2	Fixture	Ampak	GT966X_EVB_IO BOARD_V00	---	---	---
3	Adapter for fixture	LINKSYS	KSAFB0500100W 1US	---	---	---

1.3 Test Setup Chart

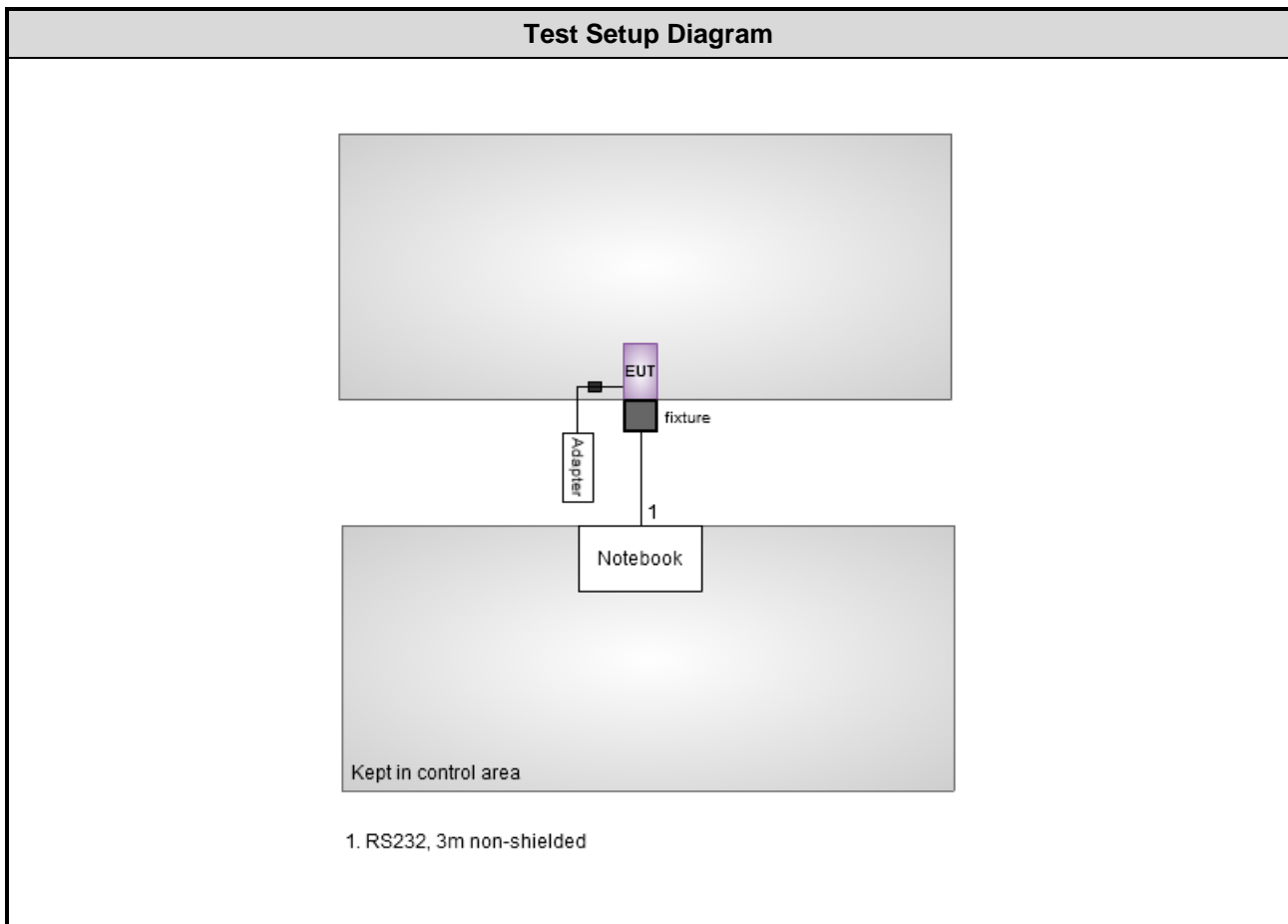

1.4 Test Equipment List and Calibration Data

Test Item	Conducted Emission				
Test Site	Conduction room 1 / (CO01-WS)				
Tested date	Dec. 18, 2013				
Instrument	Manufacturer	Model No.	Serial No.	Calibration Date	Calibration Until
EMC Receiver	R&S	ESCS 30	100169	Oct. 15, 2013	Oct. 14, 2014
LISN	SCHWARZBECK MESS-ELEKTRONIK	Schwarzbeck 8127	8127-667	Nov. 23, 2013	Nov. 22, 2014
LISN (Support Unit)	SCHWARZBECK MESS-ELEKTRONIK	Schwarzbeck 8127	8127-666	Dec. 04, 2013	Dec. 03, 2014
RF Cable-CON	Woken	CFD200-NL	CFD200-NL-001	Apr. 24, 2013	Apr. 23, 2014
50 ohm terminal (Support Unit)	NA	50	04	Apr. 22, 2013	Apr. 21, 2014
Note: Calibration Interval of instruments listed above is one year.					

Test Item	RF Conducted				
Test Site	(TH01-WS)				
Tested date	Feb. 26, 2014				
Instrument	Manufacturer	Model No.	Serial No.	Calibration Date	Calibration Until
Spectrum Analyzer	R&S	FSV40	101063	Feb. 17, 2014	Feb. 16, 2015
Power Meter	Anritsu	ML2495A	1241002	Oct. 24, 2013	Oct. 23, 2014
Power Sensor	Anritsu	MA2411B	1207366	Oct. 24, 2013	Oct. 23, 2014
Note: Calibration Interval of instruments listed above is one year.					

Test Item	Radiated Emission				
Test Site	966 chamber 2 / (03CH02-WS)				
Tested date	Feb. 11, 2014				
Instrument	Manufacturer	Model No.	Serial No.	Calibration Date	Calibration Until
Spectrum Analyzer	R&S	FSV40	101499	Feb. 08, 2014	Feb. 07, 2015
Receiver	R&S	ESR3	101657	Jan. 18, 2014	Jan. 17, 2015
Bilog Antenna	SCHWARZBECK	VULB9168	VULB9168-524	Jan. 08, 2014	Jan. 07, 2015
Horn Antenna 1G-18G	SCHWARZBECK	BBHA 9120D	BBHA 9120 D 1095	Jan. 07, 2014	Jan. 06, 2015
Horn Antenna 18G-40G	SCHWARZBECK	BBHA 9170	BBHA 9170517	Dec. 27, 2013	Dec. 26, 2014
Amplifier	Burgeon	BPA-530	100218	Dec. 09, 2013	Dec. 08, 2014
Amplifier	Agilent	83017A	MY39501309	Dec. 09, 2013	Dec. 08, 2014
RF Cable	HUBER+SUHNER	SUCOFLEX104	MY16140/4	Dec. 17, 2013	Dec. 16, 2014
RF Cable	HUBER+SUHNER	SUCOFLEX104	MY16018/4	Dec. 17, 2013	Dec. 16, 2014
RF Cable	HUBER+SUHNER	SUCOFLEX104	MY16015/4	Dec. 17, 2013	Dec. 16, 2014
RF Cable-R03m	Woken	CFD400NL-LW	CFD400NL-003	Dec. 17, 2013	Dec. 16, 2014
RF Cable-R10m	Woken	CFD400NL-LW	CFD400NL-004	Dec. 17, 2013	Dec. 16, 2014
control	EM Electronics	EM1000	060608	N/A	N/A
Note: Calibration Interval of instruments listed above is one year.					

Loop Antenna	R&S	HFH2-Z2	100330	Nov. 15, 2012	Nov. 14, 2014
Amplifier	EM	EM18G40G	060572	Jun. 20, 2013	Jun. 19, 2015
Note: Calibration Interval of instruments listed above is two year.					

1.5 Test Standards

According to the specification of EUT, the EUT must comply with following standards and KDB documents.

47 CFR FCC Part 15.247

ANSI C63.10-2009

FCC KDB 558074 D01 DTS Meas Guidance v03r01

Note: The EUT has been tested and complied with FCC part 15B requirement. FCC Part 15B test results are issued to another report.

1.6 Measurement Uncertainty

ISO/IEC 17025 requires that an estimate of the measurement uncertainties associated with the emissions test results be included in the report. The measurement uncertainties given below are based on a 95% confidence level (based on a coverage factor (k=2))

Measurement Uncertainty	
Parameters	Uncertainty
Bandwidth	± 35.286 Hz
Conducted power	± 0.536 dB
Frequency error	± 35.286 Hz
Temperature	± 0.3 °C
Conducted emission	± 2.946 dB
AC conducted emission	± 2.43 dB
Radiated emission	± 2.49 dB

2 Test Configuration

2.1 Testing Condition

Test Item	Test Site	Ambient Condition	Tested By
AC Conduction	CO01-WS	21°C / 60%	Skys Huang
Radiated Emissions	03CH02-WS	18°C / 66%	Aska Huang
RF Conducted	TH01-WS	21°C / 61%	Felix Sung

➤ FCC site registration No.: 657002

➤ IC site registration No.: 10807A-2

2.2 The Worst Test Modes and Channel Details

Test item	Mode	Test Frequency (MHz)	Data Rate (Mbps)	Test Configuration
AC Power Line Conducted Emissions	BT LE	2402	1Mbps	-
Radiated Emissions ≤ 1GHz	BT LE	2402	1Mbps	-
Radiated Emissions > 1GHz	BT LE	2402, 2440, 2480	1Mbps	-
Fundamental Emission Output Power	BT LE	2402, 2440, 2480	1Mbps	-
6dB bandwidth				
Power spectral density				

NOTE:

- The EUT was pretested with 3 orientations placed on the table for the radiated emission measurement – X, Y, and Z-plane. The **Z-plane** results were found as the worst case and were shown in this report.

3 Transmitter Test Results

3.1 AC Power Line Conducted Emissions

3.1.1 Limit of AC Power Line Conducted Emissions

Conducted Emissions Limit		
Frequency Emission (MHz)	Quasi-Peak	Average
0.15-0.5	66 - 56 *	56 - 46 *
0.5-5	56	46
5-30	60	50

Note 1: * Decreases with the logarithm of the frequency.

3.1.2 Test Procedures

1. The device is placed on a test table, raised 80 cm above the reference ground plane. The vertical conducting plane is located 40 cm to the rear of the device.
2. The device is connected to line impedance stabilization network (LISN) and other accessories are connected to other LISN. Measured levels of AC power line conducted emission are across the 50 Ω LISN port.
3. AC conducted emission measurements is made over frequency range from 150 kHz to 30 MHz.
4. This measurement was performed with AC 120V/60Hz

3.1.3 Test Setup

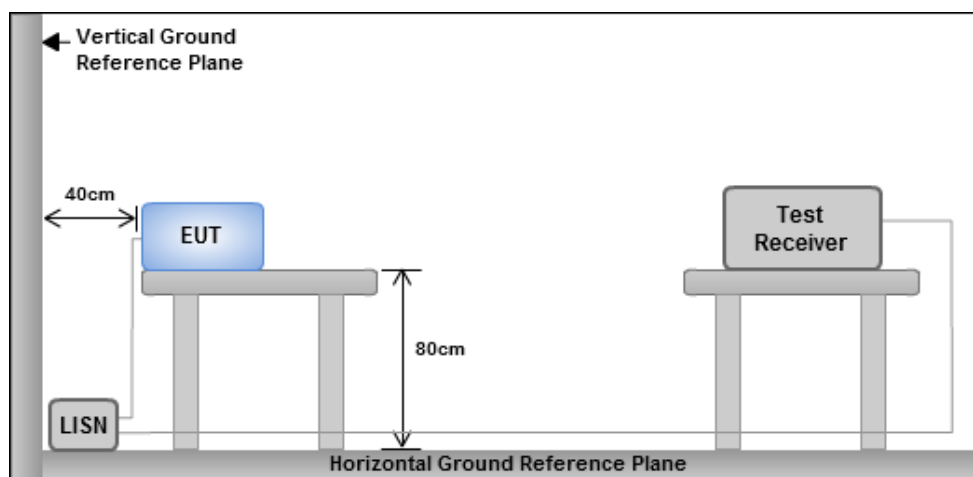

- Note: 1. Support units were connected to second LISN.
 2. Both of LISNs (AMN) are 80 cm from EUT and at least 80 cm from other units and other metal planes

3.1.4 Test Result of Conducted Emissions

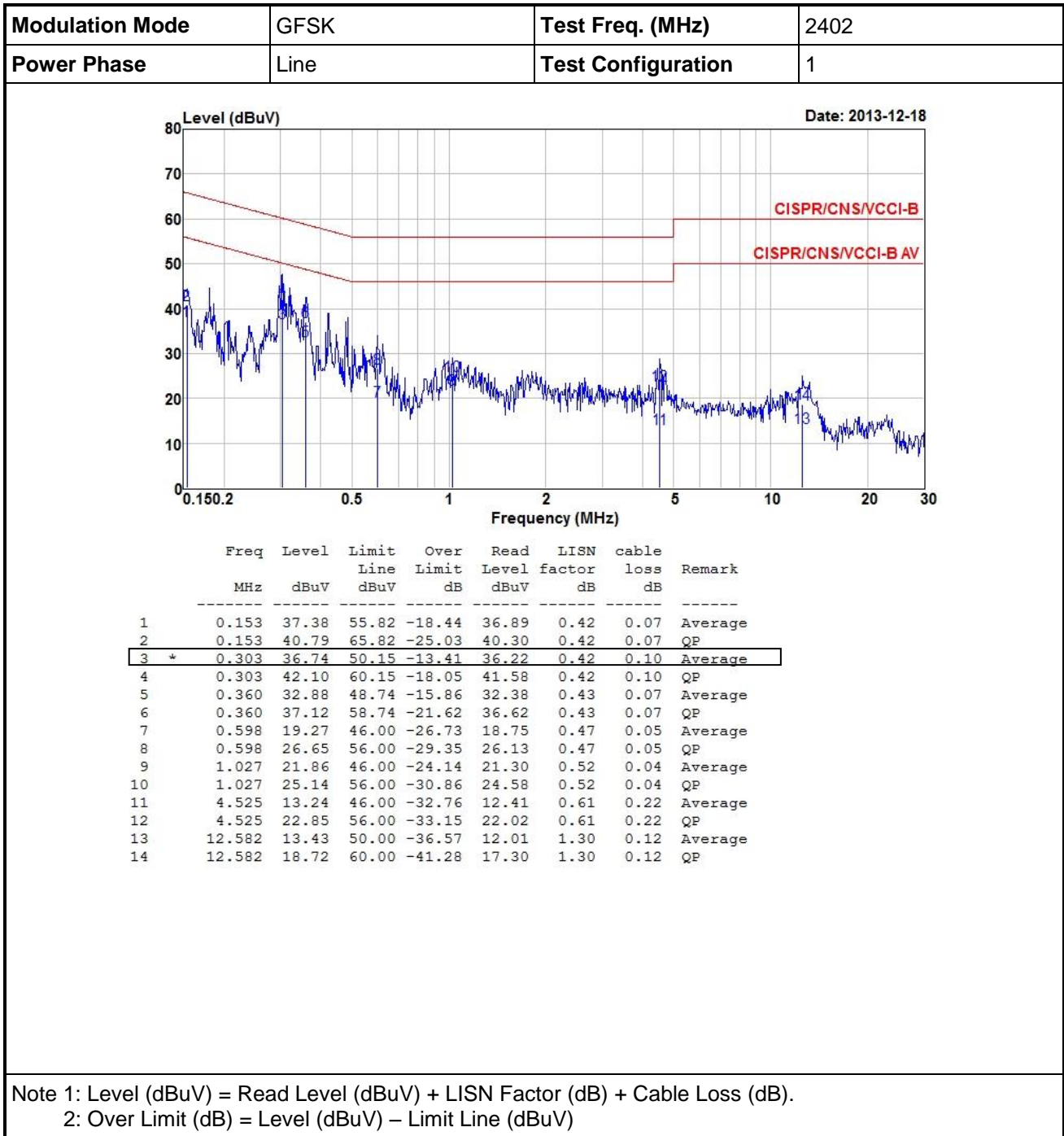

Modulation Mode	GFSK	Test Freq. (MHz)	2402
Power Phase	Neutral	Test Configuration	1

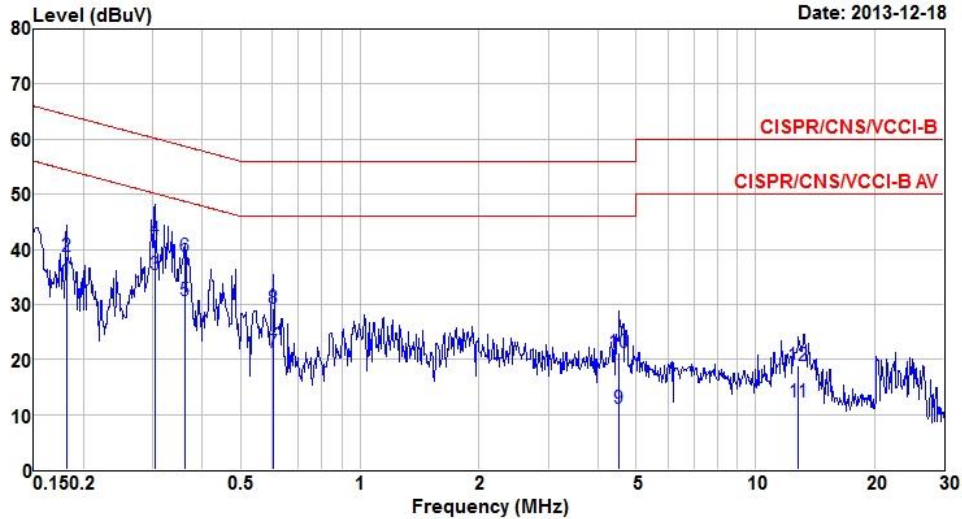

	Freq	Level	Limit	Over	Read	LISN	cable	Remark
	MHz	dBuV	Line	Limit	Level	factor	loss	
			dBuV	dB	dBuV	dB	dB	
1	0.182	34.54	54.42	-19.88	33.90	0.50	0.14	Average
2	0.182	38.66	64.42	-25.76	38.02	0.50	0.14	QP
3	0.303	35.32	50.15	-14.83	34.71	0.51	0.10	Average
4	0.303	41.66	60.15	-18.49	41.05	0.51	0.10	QP
5	0.361	30.71	48.69	-17.98	30.12	0.52	0.07	Average
6	0.361	38.81	58.69	-19.88	38.22	0.52	0.07	QP
7	0.604	21.22	46.00	-24.78	20.61	0.56	0.05	Average
8	0.604	29.23	56.00	-26.77	28.62	0.56	0.05	QP
9	4.525	11.21	46.00	-34.79	10.34	0.65	0.22	Average
10	4.525	21.29	56.00	-34.71	20.42	0.65	0.22	QP
11	12.852	12.17	50.00	-37.83	10.70	1.35	0.12	Average
12	12.852	18.82	60.00	-41.18	17.35	1.35	0.12	QP

Note 1: Level (dBuV) = Read Level (dBuV) + LISN Factor (dB) + Cable Loss (dB).
 2: Over Limit (dB) = Level (dBuV) – Limit Line (dBuV)

3.2 6dB and Occupied Bandwidth

3.2.1 Limit of 6dB Bandwidth

The minimum 6dB bandwidth shall be at least 500 kHz.

3.2.2 Test Procedures

1. Set resolution bandwidth (RBW) = 100 kHz, Video bandwidth = 300 kHz.
2. Detector = Peak, Trace mode = max hold.
3. Sweep = auto couple, Allow the trace to stabilize.
4. Measure the maximum width of the emission that is constrained by the frequencies associated with the two outermost amplitude points (upper and lower) that are attenuated by 6dB relative to the maximum level measured in the fundamental emission.

3.2.3 Test Setup

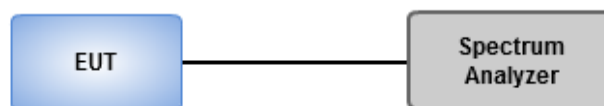

3.2.4 Test Result of 6dB and Occupied Bandwidth

Freq. (MHz)	6dB Bandwidth (kHz)	Limit (kHz)
2402	669.570	500
2440	665.220	500
2480	665.220	500

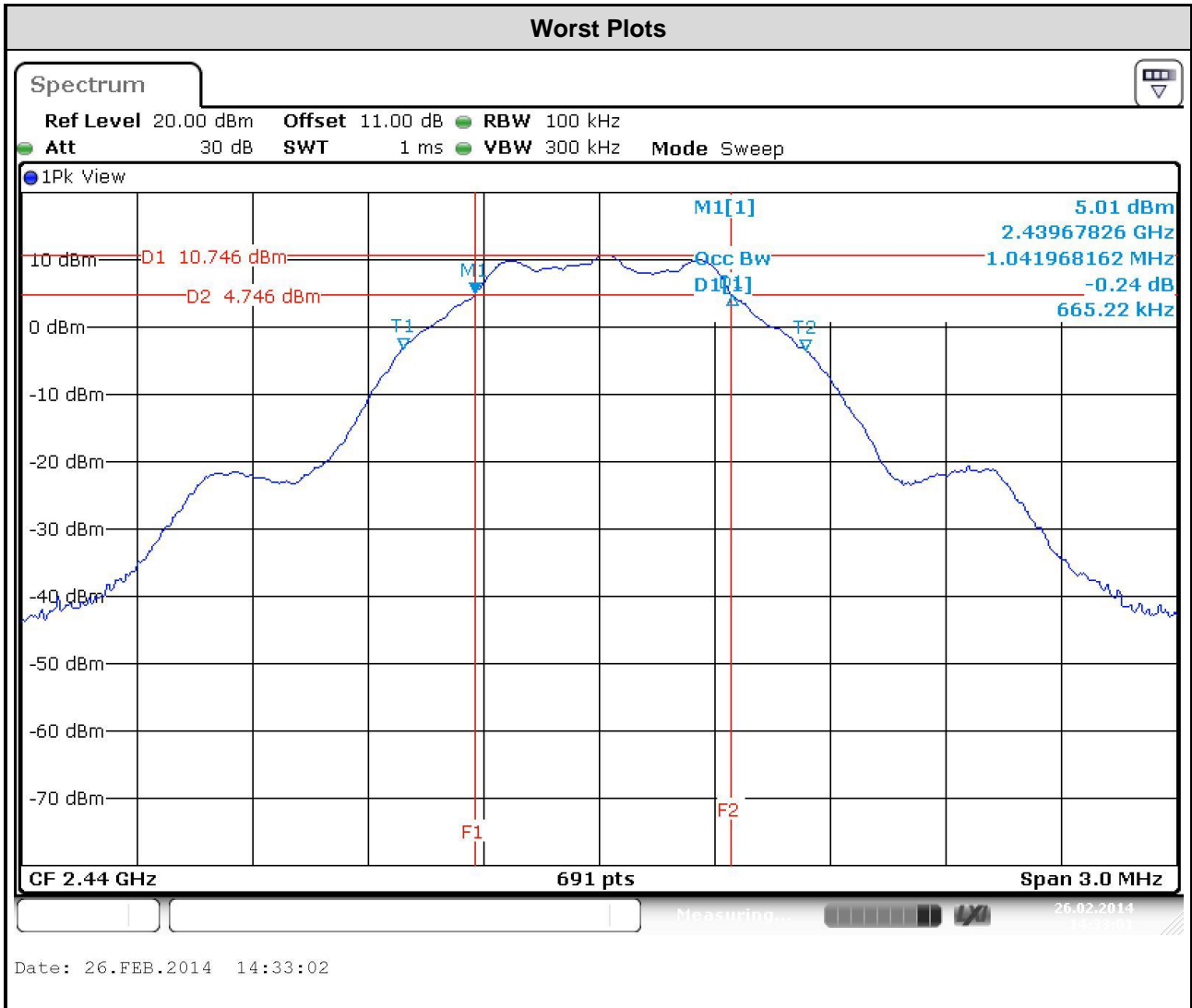

Freq. (MHz)	99% Occupied Bandwidth (MHz)
2402	1.0094
2440	1.0094
2480	1.0094

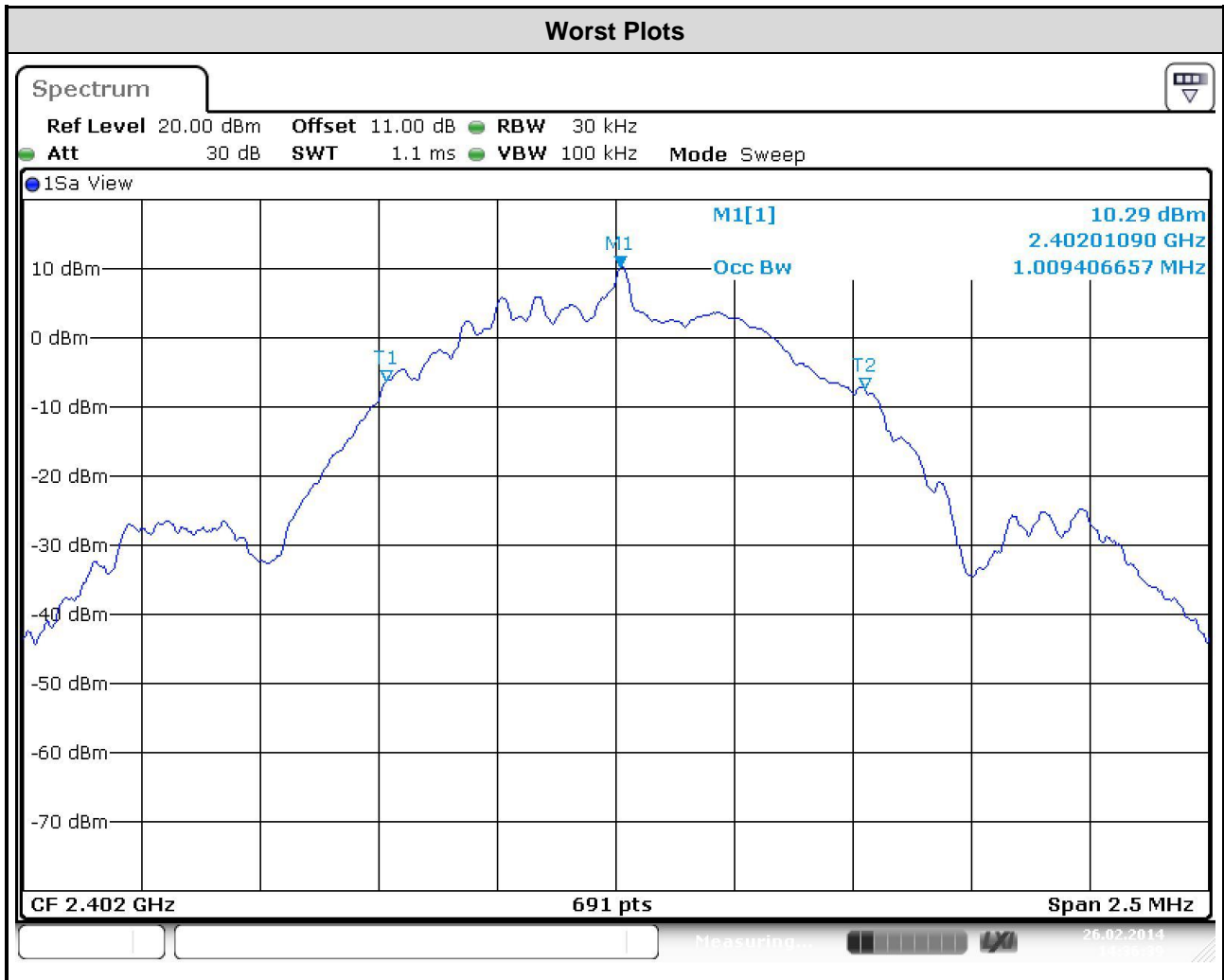

3.3 RF Output Power

3.3.1 Limit of RF Output Power

Conducted power shall not exceed 1Watt.

- Antenna gain \leq 6dBi, no any corresponding reduction is in output power limit.
- Antenna gain $>$ 6dBi
 - Non Fixed, point to point operations.
The conducted output power from the intentional radiator shall be reduced by the amount in dB that the directional gain of the antenna exceeds 6 dB
 - Fixed, point to point operations
Systems operating in the 2400–2483.5 MHz band that are used exclusively for fixed, point-to-point Operations, maximum peak output power of the intentional radiator is reduced by 1 dB for every 3 dB that the directional gain of the antenna exceeds 6 dBi.

Systems operating in the 5725–5850 MHz band that are used exclusively for fixed, point-to-point operations ,no any corresponding reduction is in transmitter peak output power

3.3.2 Test Procedures

- Maximum Peak Conducted Output Power
 - Spectrum analyzer**
 1. Set RBW = 1MHz, VBW = 3MHz, Detector = Peak.
 2. Sweep time = auto, Trace mode = max hold, Allow trace to fully stabilize.
 3. Use the spectrum analyzer channel power measurement function with the band limits set equal to the DTS bandwidth edges.
 - Power meter**
 1. A broadband Peak RF power meter is used for output power measurement. The video bandwidth of power meter is greater than DTS bandwidth of EUT. If duty cycle of test signal is not 100 %, trigger and gating function of power meter will be enabled to capture transmission burst for measuring output power.
- Maximum Conducted Average Output Power (For reference only)
 - Spectrum analyzer**
 1. Set RBW = 1MHz, VBW = 3MHz, Detector = RMS.
 2. Set the sweep time to: $\geq 10 \times$ (number of measurement points in sweep) \times (maximum data rate per stream).
 3. Perform the measurement over a single sweep.
 4. Use the spectrum analyzer's band power measurement function with band limits set equal to the EBW(26dBc) band edges.
 - Power meter**
 1. A broadband Average RF power meter is used for output power measurement. The video bandwidth of power meter is greater than DTS bandwidth of EUT. If duty cycle of test signal is not 100 %, trigger and gating function of power meter will be enabled to capture transmission burst for measuring output power.

3.3.3 Test Setup



3.3.4 Test Result of Maximum Output Power

Freq. (MHz)	Peak Conducted Power (dBm)	Limit (dBm)
2402	11.30	30
2440	11.36	30
2480	11.25	30

Freq. (MHz)	Average Conducted Power (dBm)	Limit (dBm)
2402	11.20	30
2440	11.25	30
2480	11.13	30

Note: Average power is for reference only.

3.4 Power Spectral Density

3.4.1 Limit of Power Spectral Density

Power spectral density shall not be greater than 8 dBm in any 3 kHz band.

3.4.2 Test Procedures

- Maximum peak conducted output power was used to demonstrate compliance to the fundamental output power limit.
 1. Set the RBW = 3kHz, VBW = 10kHz.
 2. Detector = Peak, Sweep time = auto couple.
 3. Trace mode = max hold, allow trace to fully stabilize.
 4. Use the peak marker function to determine the maximum amplitude level.
- Maximum (average) conducted output power was used to demonstrate compliance to the fundamental output power limit.
 1. Set the RBW = 100kHz, VBW = 300 kHz.
 2. Detector = RMS, Sweep time = auto couple.
 3. Set the sweep time to: $\geq 10 \times (\text{number of measurement points in sweep}) \times (\text{maximum data rate per stream})$.
 4. Perform the measurement over a single sweep.
 5. Use the peak marker function to determine the maximum amplitude level.\

3.4.3 Test Setup

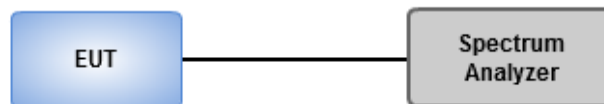

3.4.4 Test Result of Power Spectral Density

Freq. (MHz)	Power Spectral Density (dBm / 3kHz)	Limit (dBm)
2402	-3.93	8
2440	-4.69	8
2480	-3.86	8

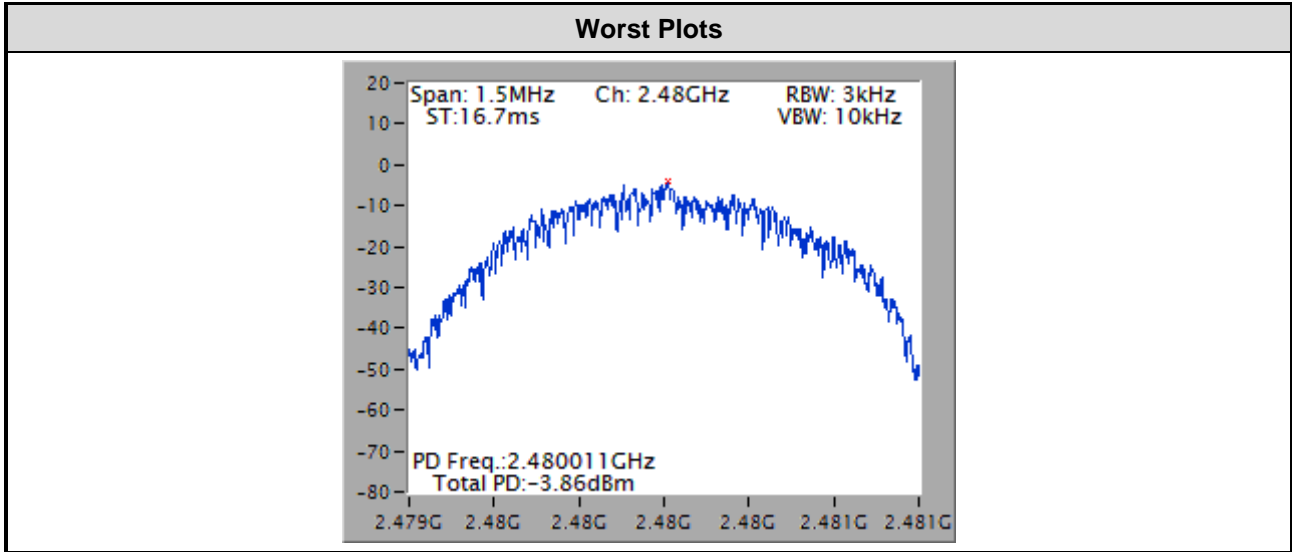

3.5 Emissions in Restricted Frequency Bands

3.5.1 Limit of Emissions in Restricted Frequency Bands

Restricted Band Emissions Limit			
Frequency Range (MHz)	Field Strength (uV/m)	Field Strength (dBuV/m)	Measure Distance (m)
0.009~0.490	2400/F(kHz)	48.5 - 13.8	300
0.490~1.705	24000/F(kHz)	33.8 - 23	30
1.705~30.0	30	29	30
30~88	100	40	3
88~216	150	43.5	3
216~960	200	46	3
Above 960	500	54	3

Note 1:
Quasi-Peak value is measured for frequency below 1GHz except for 9–90 kHz, 110–490 kHz frequency band. Peak and average value are measured for frequency above 1GHz. The limit on average radio frequency emission is as above table. The limit on peak radio frequency emissions is 20 dB above the maximum permitted average emission limit

Note 2:
Measurements may be performed at a distance other than what is specified provided. When performing measurements at a distance other than that specified, the results shall be extrapolated to the specified distance using an extrapolation factor as below, Frequency at or above 30 MHz: 20 dB/decade Frequency below 30 MHz: 40 dB/decade.

3.5.2 Test Procedures

1. Measurement is made at a semi-anechoic chamber that incorporates a turntable allowing a EUT rotation of 360°. A continuously-rotating, remotely-controlled turntable is installed at the test site to support the EUT and facilitate determination of the direction of maximum radiation for each EUT emission frequency. The EUT is placed at a height of 0.8 m test table above the ground plane.
2. Measurement is made with the antenna positioned in both the horizontal and vertical planes of polarization. The measurement antenna is varied in height (1m ~ 4m) above the reference ground plane to obtain the maximum signal strength. Distance between EUT and antenna is 3 m.
3. This investigation is performed with the EUT rotated 360°, the antenna height scanned between 1 m and 4 m, and the antenna rotated to repeat the measurements for both the horizontal and vertical antenna polarizations.

Note:

1. 120kHz measurement bandwidth of test receiver and Quasi-peak detector is for radiated emission below 1GHz.
2. RBW=1MHz, VBW=3MHz and Peak detector is for peak measured value of radiated emission above 1GHz.
3. RBW=1MHz, VBW=1/T and Peak detector is for average measured value of radiated emission above 1GHz.

3.5.3 Test Setup

Radiated Emissions below 1 GHz

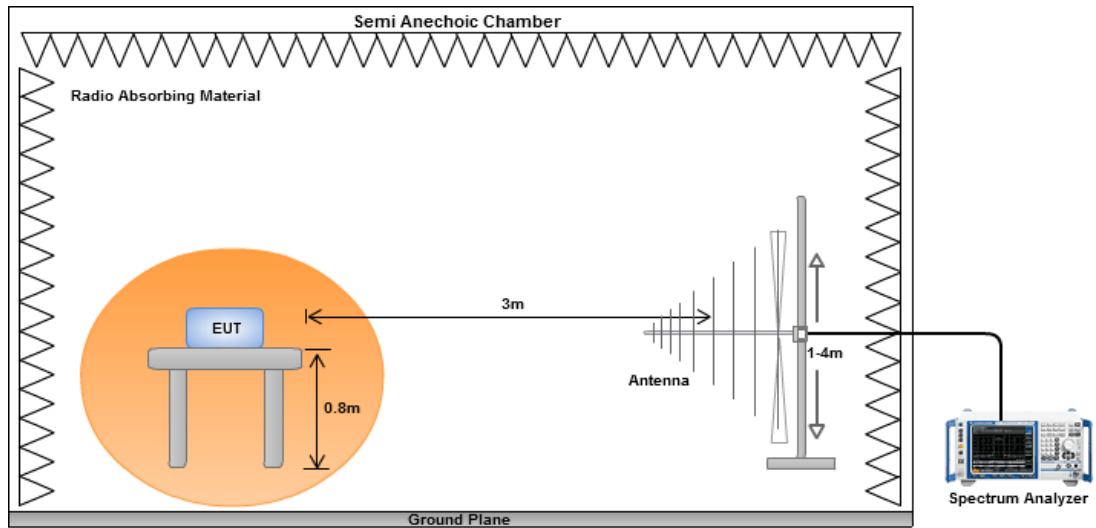

Radiated Emissions above 1 GHz

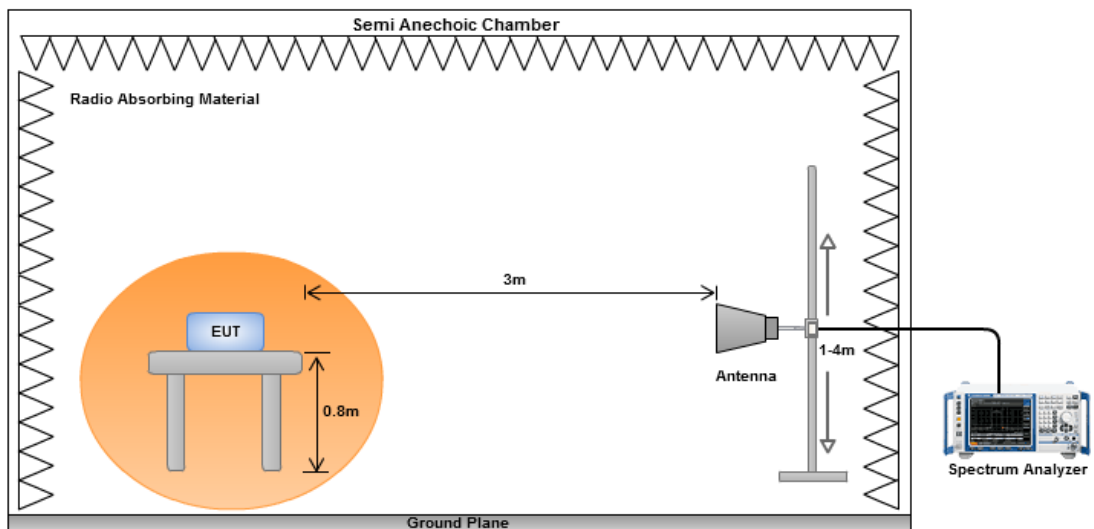

3.5.4 Transmitter Radiated Unwanted Emissions (Below 1GHz)

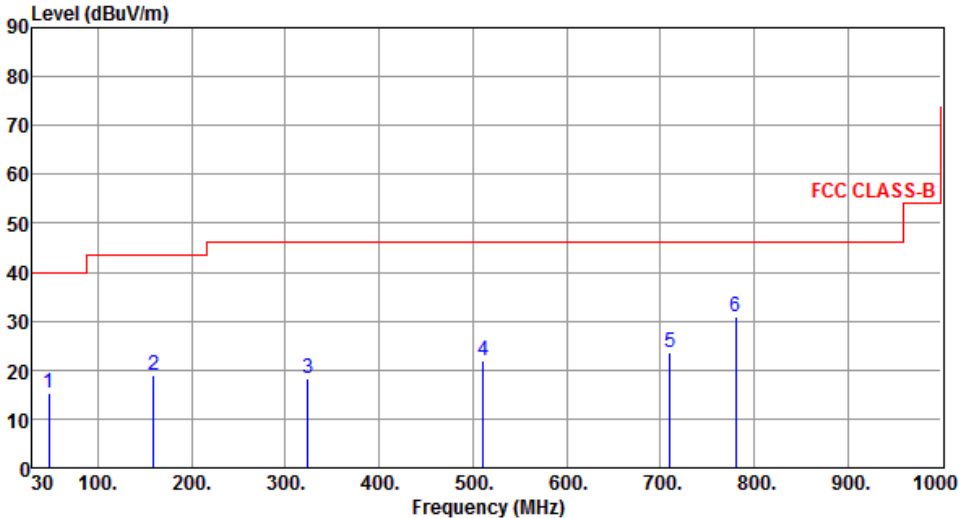
Modulation	GFSK	Test Freq. (MHz)	2402						
Polarization	Horizontal								
									
	Freq.	Emission level	Limit	Margin	SA reading	Factor	Remark	ANT High	Turn Table
	MHz	dBuV/m	dBuV/m	dB	dBuV	dB		cm	deg
1	47.46	15.18	40.00	-24.82	31.16	-15.98	Peak	---	---
2	159.01	18.88	43.50	-24.62	35.28	-16.40	Peak	---	---
3	323.91	18.19	46.00	-27.81	33.33	-15.14	Peak	---	---
4	511.12	21.98	46.00	-24.02	32.87	-10.89	Peak	---	---
5	709.97	23.52	46.00	-22.48	31.03	-7.51	Peak	---	---
6	780.78	30.94	46.00	-15.06	37.38	-6.44	Peak	---	---

Note 1: Emission Level (dBuV/m) = SA Reading (dBuV/m) + Factor* (dB)
*Factor includes antenna factor , cable loss and amplifier gain
Note 2: Margin (dB) = Emission level (dBuV/m) – Limit (dBuV/m).
Note 3: All spurious emissions below 30MHz are more than 20 dB below the limit.

Modulation	GFSK	Test Freq. (MHz)	2402
Polarization	Vertical		

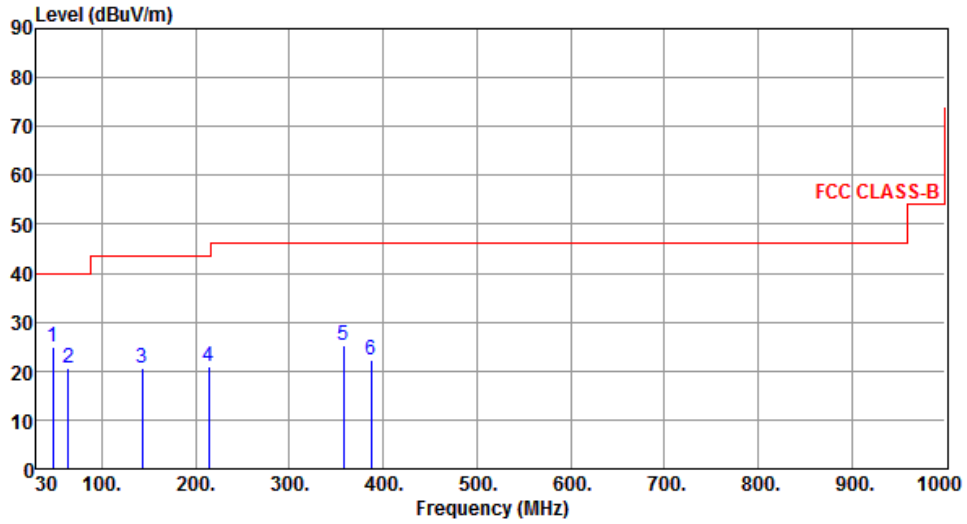

	Freq. MHz	Emission level dBuV/m	Limit dBuV/m	Margin dB	SA reading dBuV	Factor dB	Remark	ANT High cm	Turn Table deg
1	47.46	24.87	40.00	-15.13	40.85	-15.98	Peak	---	---
2	63.95	20.61	40.00	-19.39	38.08	-17.47	Peak	---	---
3	142.52	20.42	43.50	-23.08	37.07	-16.65	Peak	---	---
4	214.30	21.01	43.50	-22.49	39.80	-18.79	Peak	---	---
5	357.86	25.13	46.00	-20.87	39.43	-14.30	Peak	---	---
6	386.96	22.27	46.00	-23.73	35.75	-13.48	Peak	---	---

Note 1: Emission Level (dBuV/m) = SA Reading (dBuV/m) + Factor* (dB)

*Factor includes antenna factor , cable loss and amplifier gain

Note 2: Margin (dB) = Emission level (dBuV/m) – Limit (dBuV/m).

Note 3: All spurious emissions below 30MHz are more than 20 dB below the limit.

3.5.5 Transmitter Radiated Unwanted Emissions (Above 1GHz) for GFSK

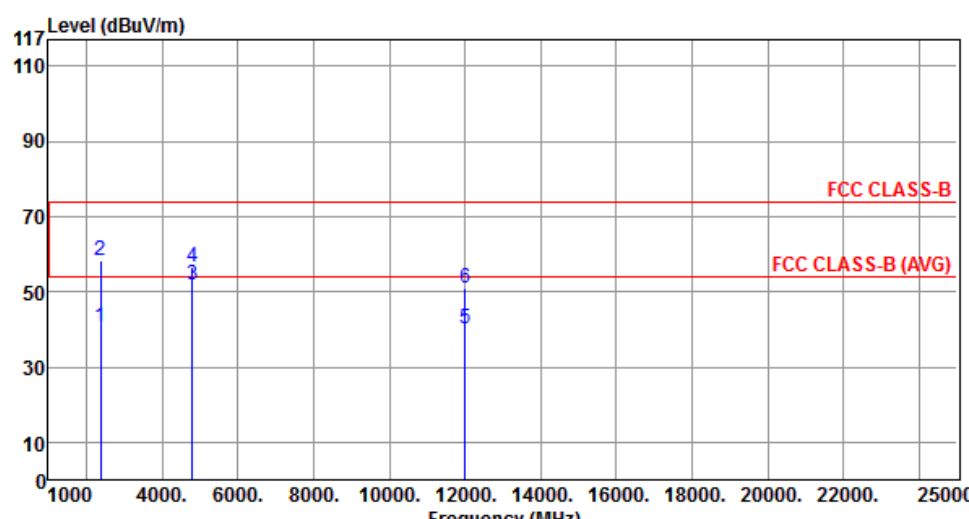
Modulation	GFSK	Test Freq. (MHz)	2402																																																																						
Polarization	Horizontal																																																																								
																																																																									
<table border="1"> <thead> <tr> <th></th> <th>Freq. MHz</th> <th>Emission level dBuV/m</th> <th>Limit dBuV/m</th> <th>Margin dB</th> <th>SA reading dBuV</th> <th>Factor dB</th> <th>Remark</th> <th>ANT High cm</th> <th>Turn Table deg</th> </tr> </thead> <tbody> <tr> <td>1</td> <td>2390.00</td> <td>40.69</td> <td>54.00</td> <td>-13.31</td> <td>42.69</td> <td>-2.00</td> <td>Average</td> <td>---</td> <td>---</td> </tr> <tr> <td>2</td> <td>2390.00</td> <td>58.19</td> <td>74.00</td> <td>-15.81</td> <td>60.19</td> <td>-2.00</td> <td>Peak</td> <td>---</td> <td>---</td> </tr> <tr> <td>3</td> <td>4804.00</td> <td>51.97</td> <td>54.00</td> <td>-2.03</td> <td>45.86</td> <td>6.11</td> <td>Average</td> <td>---</td> <td>---</td> </tr> <tr> <td>4</td> <td>4804.00</td> <td>56.57</td> <td>74.00</td> <td>-17.43</td> <td>50.46</td> <td>6.11</td> <td>Peak</td> <td>---</td> <td>---</td> </tr> <tr> <td>5</td> <td>12010.00</td> <td>39.97</td> <td>54.00</td> <td>-14.03</td> <td>25.67</td> <td>14.30</td> <td>Average</td> <td>---</td> <td>---</td> </tr> <tr> <td>6</td> <td>12010.00</td> <td>51.15</td> <td>74.00</td> <td>-22.85</td> <td>36.85</td> <td>14.30</td> <td>Peak</td> <td>---</td> <td>---</td> </tr> </tbody> </table>					Freq. MHz	Emission level dBuV/m	Limit dBuV/m	Margin dB	SA reading dBuV	Factor dB	Remark	ANT High cm	Turn Table deg	1	2390.00	40.69	54.00	-13.31	42.69	-2.00	Average	---	---	2	2390.00	58.19	74.00	-15.81	60.19	-2.00	Peak	---	---	3	4804.00	51.97	54.00	-2.03	45.86	6.11	Average	---	---	4	4804.00	56.57	74.00	-17.43	50.46	6.11	Peak	---	---	5	12010.00	39.97	54.00	-14.03	25.67	14.30	Average	---	---	6	12010.00	51.15	74.00	-22.85	36.85	14.30	Peak	---	---
	Freq. MHz	Emission level dBuV/m	Limit dBuV/m	Margin dB	SA reading dBuV	Factor dB	Remark	ANT High cm	Turn Table deg																																																																
1	2390.00	40.69	54.00	-13.31	42.69	-2.00	Average	---	---																																																																
2	2390.00	58.19	74.00	-15.81	60.19	-2.00	Peak	---	---																																																																
3	4804.00	51.97	54.00	-2.03	45.86	6.11	Average	---	---																																																																
4	4804.00	56.57	74.00	-17.43	50.46	6.11	Peak	---	---																																																																
5	12010.00	39.97	54.00	-14.03	25.67	14.30	Average	---	---																																																																
6	12010.00	51.15	74.00	-22.85	36.85	14.30	Peak	---	---																																																																
<p>Note 1: Emission Level (dBuV/m) = SA Reading (dBuV/m) + Factor* (dB) *Factor includes antenna factor , cable loss and amplifier gain Note 2: Margin (dB) = Emission level (dBuV/m) – Limit (dBuV/m).</p>																																																																									

Modulation	GFSK	Test Freq. (MHz)	2402
Polarization	Vertical		

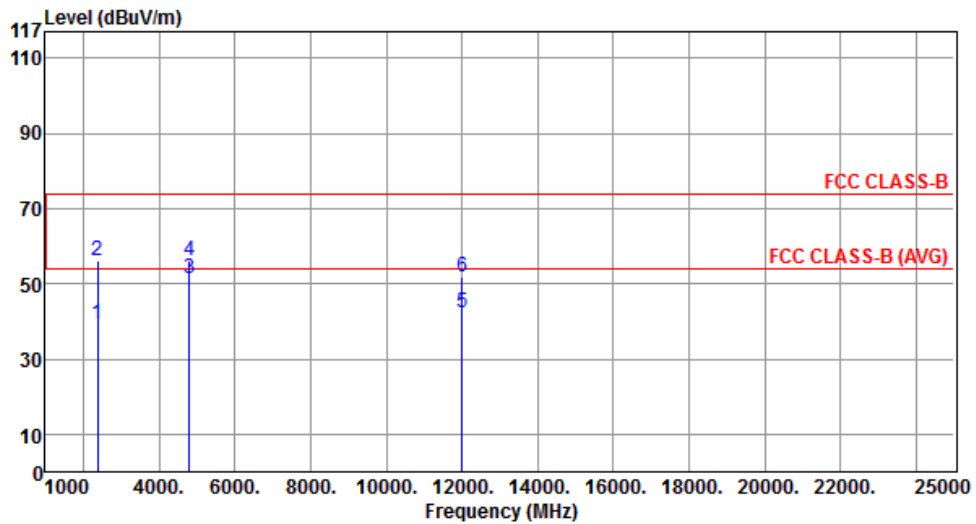

	Freq. MHz	Emission level dBuV/m	Limit dBuV/m	Margin dB	SA reading dBuV	Factor dB	Remark	ANT High cm	Turn Table deg
1	2390.00	39.30	54.00	-14.70	41.30	-2.00	Average	---	---
2	2390.00	56.18	74.00	-17.82	58.18	-2.00	Peak	---	---
3	4804.00	51.44	54.00	-2.56	45.33	6.11	Average	---	---
4	4804.00	55.99	74.00	-18.01	49.88	6.11	Peak	---	---
5	12010.00	42.17	54.00	-11.83	27.87	14.30	Average	---	---
6	12010.00	51.72	74.00	-22.28	37.42	14.30	Peak	---	---

Note 1: Emission Level (dBuV/m) = SA Reading (dBuV/m) + Factor* (dB)

*Factor includes antenna factor , cable loss and amplifier gain

Note 2: Margin (dB) = Emission level (dBuV/m) – Limit (dBuV/m).

Modulation	GFSK	Test Freq. (MHz)	2440
Polarization	Horizontal		

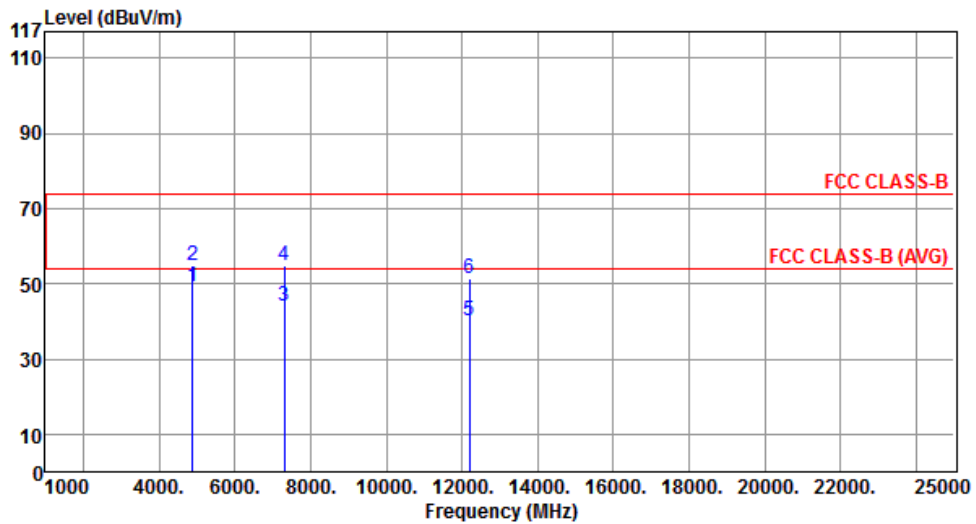

	Freq. MHz	Emission level dBuV/m	Limit dBuV/m	Margin dB	SA reading dBuV	Factor dB	Remark	ANT High cm	Turn Table deg
1	4880.00	49.11	54.00	-4.89	42.85	6.26	Average	---	---
2	4880.00	54.64	74.00	-19.36	48.38	6.26	Peak	---	---
3	7320.00	43.96	54.00	-10.04	31.97	11.99	Average	---	---
4	7320.00	54.68	74.00	-19.32	42.69	11.99	Peak	---	---
5	12200.00	40.36	54.00	-13.64	26.15	14.21	Average	---	---
6	12200.00	51.57	74.00	-22.43	37.36	14.21	Peak	---	---

Note 1: Emission Level (dBuV/m) = SA Reading (dBuV/m) + Factor* (dB)

*Factor includes antenna factor , cable loss and amplifier gain

Note 2: Margin (dB) = Emission level (dBuV/m) – Limit (dBuV/m).

Modulation	GFSK	Test Freq. (MHz)	2440
Polarization	Vertical		

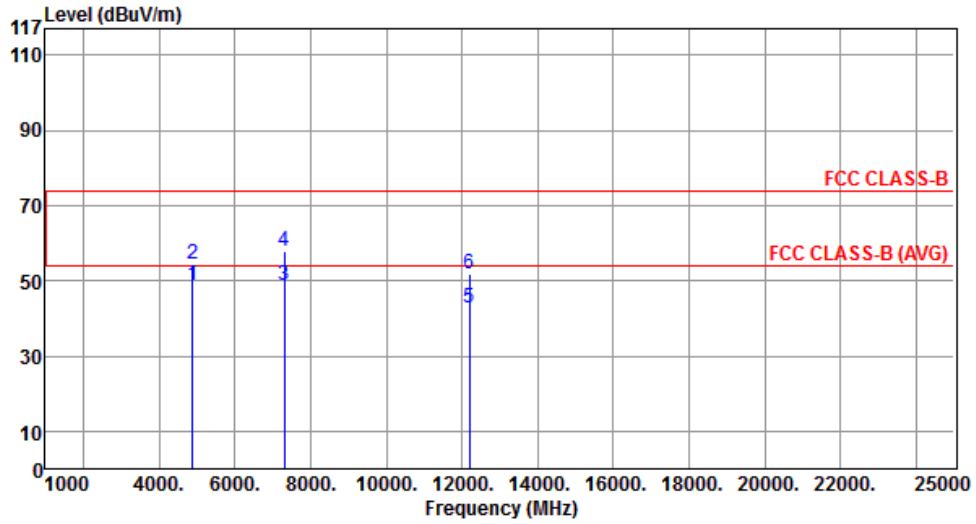

	Freq. MHz	Emission level dBuV/m	Limit dBuV/m	Margin dB	SA reading dBuV	Factor dB	Remark	ANT High cm	Turn Table deg
1	4880.00	48.61	54.00	-5.39	42.35	6.26	Average	---	---
2	4880.00	54.44	74.00	-19.56	48.18	6.26	Peak	---	---
3	7320.00	48.73	54.00	-5.27	36.74	11.99	Average	---	---
4	7320.00	57.85	74.00	-16.15	45.86	11.99	Peak	---	---
5	12200.00	42.75	54.00	-11.25	28.54	14.21	Average	---	---
6	12200.00	51.94	74.00	-22.06	37.73	14.21	Peak	---	---

Note 1: Emission Level (dBuV/m) = SA Reading (dBuV/m) + Factor* (dB)

*Factor includes antenna factor , cable loss and amplifier gain

Note 2: Margin (dB) = Emission level (dBuV/m) – Limit (dBuV/m).

Modulation	GFSK	Test Freq. (MHz)	2480
Polarization	Horizontal		

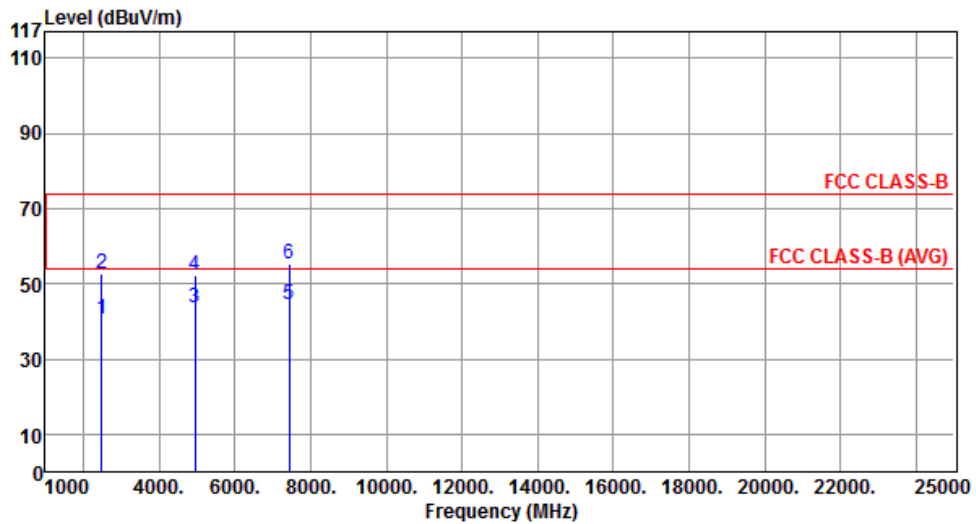

	Freq. MHz	Emission level dBuV/m	Limit dBuV/m	Margin dB	SA reading dBuV	Factor dB	Remark	ANT High cm	Turn Table deg
1	2483.50	40.62	54.00	-13.38	42.55	-1.93	Average	---	---
2	2483.50	52.72	74.00	-21.28	54.65	-1.93	Peak	---	---
3	4960.00	43.81	54.00	-10.19	37.38	6.43	Average	---	---
4	4960.00	52.03	74.00	-21.97	45.60	6.43	Peak	---	---
5	7440.00	44.39	54.00	-9.61	32.31	12.08	Average	---	---
6	7440.00	55.05	74.00	-18.95	42.97	12.08	Peak	---	---

Note 1: Emission Level (dBuV/m) = SA Reading (dBuV/m) + Factor* (dB)

*Factor includes antenna factor , cable loss and amplifier gain

Note 2: Margin (dB) = Emission level (dBuV/m) – Limit (dBuV/m).

Modulation	GFSK	Test Freq. (MHz)	2480
Polarization	Vertical		

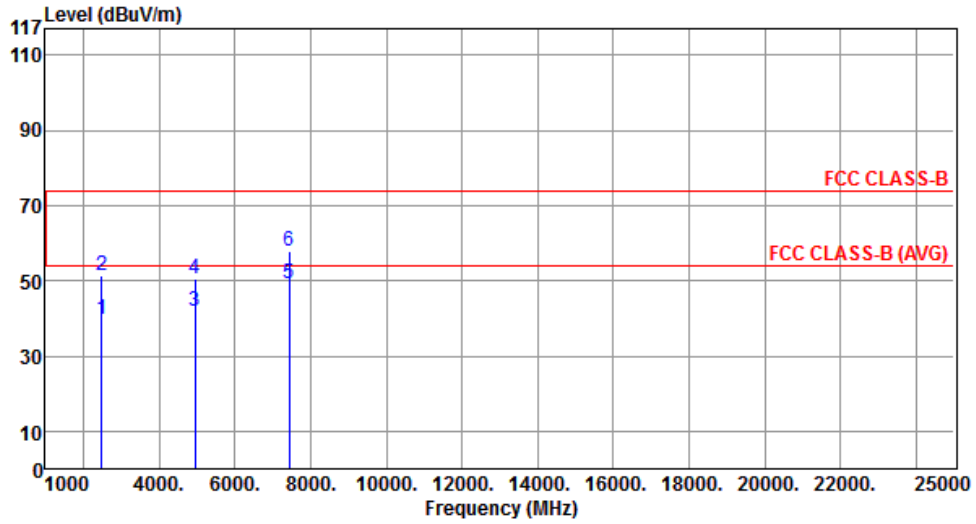

	Freq. MHz	Emission level dBuV/m	Limit dBuV/m	Margin dB	SA reading dBuV	Factor dB	Remark	ANT High cm	Turn Table deg
1	2483.50	39.83	54.00	-14.17	41.76	-1.93	Average	---	---
2	2483.50	51.40	74.00	-22.60	53.33	-1.93	Peak	---	---
3	4960.00	42.07	54.00	-11.93	35.64	6.43	Average	---	---
4	4960.00	50.61	74.00	-23.39	44.18	6.43	Peak	---	---
5	7440.00	49.23	54.00	-4.77	37.15	12.08	Average	---	---
6	7440.00	57.89	74.00	-16.11	45.81	12.08	Peak	---	---

Note 1: Emission Level (dBuV/m) = SA Reading (dBuV/m) + Factor* (dB)

*Factor includes antenna factor , cable loss and amplifier gain

Note 2: Margin (dB) = Emission level (dBuV/m) – Limit (dBuV/m).

3.6 Emissions in non-restricted Frequency Bands

3.6.1 Emissions in non-restricted frequency bands limit

Peak power in any 100 kHz bandwidth outside of the authorized frequency band shall be attenuated by at least 20 dB relative to the maximum in-band peak PSD level in 100 kHz

3.6.2 Measuring Instruments

Refer a test equipment and calibration data table in this test report.

3.6.3 Test Procedures

Reference level measurement

1. Set RBW=100kHz, VBW = 300kHz , Detector = Peak, Sweep time = Auto
2. Trace = max hold , Allow Trace to fully stabilize
3. Use the peak marker function to determine the maximum PSD level

Emission level measurement

1. Set RBW=100kHz, VBW = 300kHz , Detector = Peak, Sweep time = Auto
2. Trace = max hold , Allow Trace to fully stabilize
3. Scan Frequency range is up to 25GHz
4. Use the peak marker function to determine the maximum amplitude level

3.6.4 Test Setup

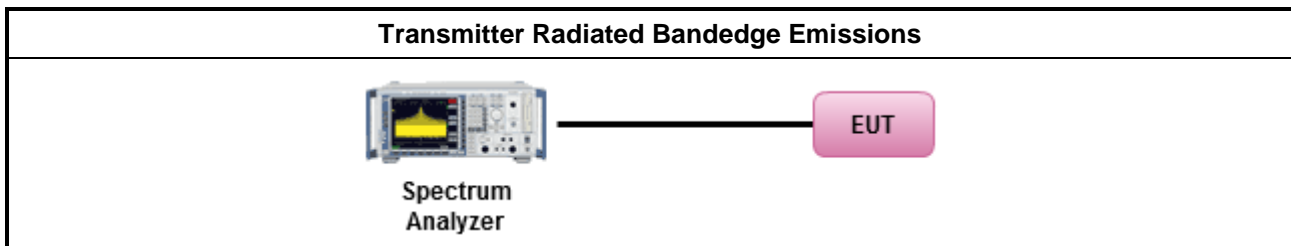

3.6.5 Test Result of Emissions in non-restricted Frequency Bands

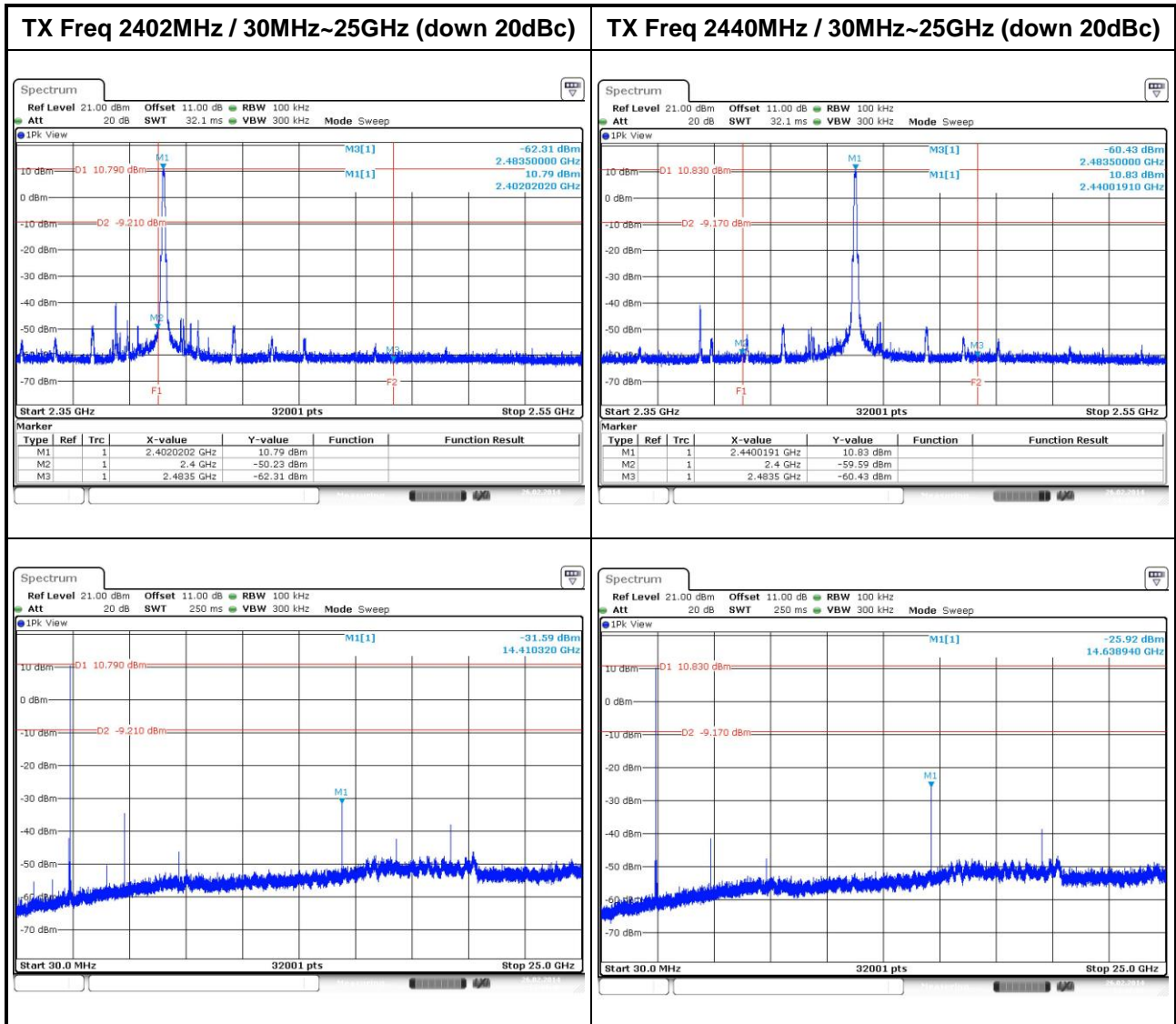

TX Freq 2480MHz / 30MHz~25GHz (down 20dBc)

--

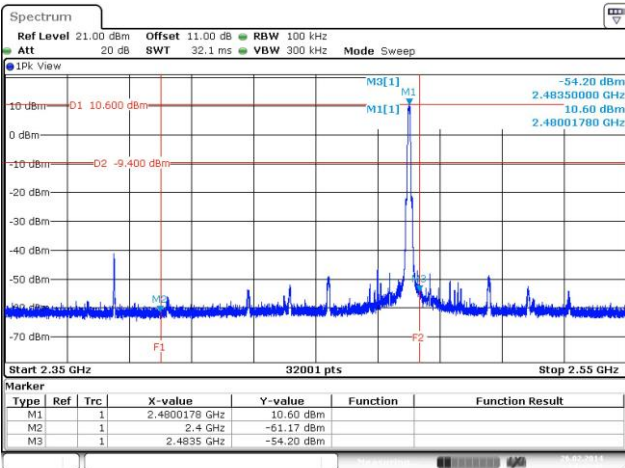

--

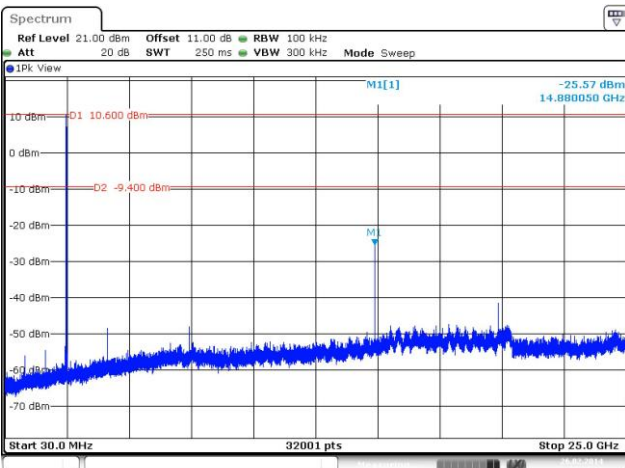

--

4 Test laboratory information

Established in 2012, ICC provides foremost EMC & RF Testing and advisory consultation services by our skilled engineers and technicians. Our services employ a wide variety of advanced edge test equipment and one of the widest certification extents in the business.

International Certification Corp, it is our definitive objective is to institute long term, trust-based associations with our clients. The expectation we set up with our clients is based on outstanding service, practical expertise and devotion to a certified value structure. Our passion is to grant our clients with best EMC / RF services by oriented knowledgeable and accommodating staff.

Our Test sites are located at Linkou District and Kwei Shan Hsiang. Location map can be found on our website <http://www.icertifi.com.tw>.

Linkou

Tel: 886-2-2601-1640

No. 30-2, Ding Fwu Tsuen, Lin Kou District, New Taipei City, Taiwan, R.O.C.

Kwei Shan

Tel: 886-3-271-8666

No. 3-1, Lane 6, Wen San 3rd St., Kwei Shan Hsiang, Tao Yuan Hsien 333, Taiwan, R.O.C.

If you have any suggestion, please feel free to contact us as below information

Tel: 886-3-271-8666

Fax: 886-3-318-0155

Email: ICC_Service@icertifi.com.tw

==END==