

**FCC ID: PX9M101S**  
**IC: 9911A-M101S**  
**Model: M101S**

## **Rugged Windows Tablet**

Intel® Apollo Lake Pentium N4200

Windows 10 IoT Enterprise



# **User Guide**

---

## Contents

<b>CHAPTER 1: READ ME FIRST</b> .....	<b>4</b>
1.1 ADVISORY CONVENTIONS.....	4
1.2 SAFETY INFORMATION .....	5
1.3 HANDLING AND MAINTENANCE.....	7
1.4 DECLARATION OF CONFORMITY (DOC).....	8
<b>CHAPTER 2: GETTING STARTED</b> .....	<b>9</b>
2.1 INTRODUCTION .....	9
2.2 UNPACKING .....	10
2.3 DESCRIPTION OF PARTS .....	11
2.4 HOTKEY FOR SPECIFIC FUNCTIONS .....	13
2.5 FIRST-TIME OPERATION.....	14
2.5.1 <i>Installing SIM Card (For 3G/LTE Equipped Devices)</i> .....	14
2.5.2 <i>Installing a Micro SD Card</i> .....	15
2.5.3 <i>Installing Battery</i> .....	15
2.5.4 <i>Charging Your Tablet</i> .....	16
2.5.5 <i>Starting the Tablet</i> .....	16
<b>CHAPTER 3: SETTING UP WINDOWS FOR THE FIRST TIME</b> .....	<b>17</b>
3.1 INTRODUCTION .....	17
3.2 SETTING UP WINDOWS 10 IOT ENTERPRISE .....	17
<b>CHAPTER 4: OPERATING THE DEVICE</b> .....	<b>20</b>
4.1 HOTTAB INTRODUCTION .....	20
4.2 SHORTCUTS.....	21
4.2.1 <i>Set up On-screen Software Shortcuts</i> .....	21
4.3 USING CAMERA .....	22
4.4 BUILT-IN DEVICES ON/OFF .....	23
4.4.1 <i>Using the Wireless LAN (Wi-Fi)</i> .....	23
4.4.2 <i>Using the Wireless WAN (3G/LTE)</i> .....	24
4.4.3 <i>Using the GPS</i> .....	25
4.4.4 <i>Using the Bluetooth</i> .....	25
4.4.5 <i>Turning On/Off LED Indicators</i> .....	26
4.4.6 <i>Using the Barcode Reader</i> .....	27
4.4.7 <i>Using the HF RFID Reader</i> .....	35
4.4.8 <i>Turn on/off the GPS External Antenna</i> .....	40
4.4.9 <i>Turn on/off the Light Sensor</i> .....	40
4.4.10 <i>Changing Touchscreen Modes</i> .....	41
4.4.11 <i>Using the Expansion Module</i> .....	43
4.4.12 <i>UHF RFID Reader Module</i> .....	44
4.4.3 SETTINGS.....	49
4.4.3.1 <i>PC Information</i> .....	49
4.4.3.2 <i>Battery Information</i> .....	49
4.4.3.3 <i>Using the Physical Function Keys (Hotkeys)</i> .....	50
<b>CHAPTER 5: FREQUENTLY USED SETTINGS</b> .....	<b>51</b>
5.1 SCREEN RESOLUTION SCALING AND SETTING.....	51
5.1.1 <i>Changing Display Scaling (Recommended)</i> .....	51
5.1.2 <i>Changing Screen Resolution</i> .....	52
5.2 REPLACING BATTERY .....	54
5.3 USING RECOVERY WIZARD TO RESTORE COMPUTER.....	55
5.4 DOCKING CONNECTOR PIN DEFINITION .....	57
5.5 EXPANSION PORT PIN DEFINITION .....	57
5.6 COM PORT DEFINITION .....	58
5.7 PAIRING WITH A WIRELESS BLUETOOTH BARCODE SCANNER.....	60
5.7.1 <i>Setup Computer for Bluetooth Pairing</i> .....	60

5.7.2 Set up the Barcode Scanner for Bluetooth Pairing .....	64
5.7.3 Perform Bluetooth Pairing.....	64
<b>CHAPTER 6: TROUBLESHOOTING .....</b>	<b>66</b>
6.1 BASIC TROUBLESHOOTING.....	66
<b>APPENDIX A: ORDER INFORMATION .....</b>	<b>68</b>

# Chapter 1: Read Me First

## 1.1 Advisory Conventions

Four types of advisories are used throughout the user manual to provide helpful information or to alert you to the potential for hardware damage or personal injury. These are Notes, Important, Cautions, and Warnings. The following is an example of each type of advisory.

**Note:**

A note is used to emphasize helpful information

**Important:**

An important note indicates information that is important for you to know.

**Caution/ Attention**

A Caution alert indicates potential damage to hardware and explains how to avoid the potential problem.

Une alerte d'attention indique un dommage possible à l'équipement et explique comment éviter le problème potentiel.

**Warning! Avertissement!**

An Electrical Shock Warning indicates the potential harm from electrical hazards and how to avoid the potential problem.

Un Avertissement de Choc Électrique indique le potentiel de choc sur des emplacements électriques et comment éviter ces problèmes.

## 1.2 Safety Information



### Precaution on Battery Pack *Précaution avec le bloc-pile*

Do Not Disassemble, Modify, or Insert Sharp Objects Into the Battery Pack. Electrolyte leakage, generation of heat, ignition or rupture may result.

*[FR] Ne pas démonter, modifier, ou insérer des objets pointus à l'intérieur du bloc-pile. Une fuite d'électrolyte, la génération de chaleur, l'amorçage ou la rupture peuvent être occasionnés.*

Do Not Short the Positive (+) and Negative (-) Terminals of the Battery. Generation of heat, ignition or rupture may result. When carrying or storing the device, do not place the battery pack together with articles that may contact electricity.

*[FR] Ne pas court-circuiter les bornes Positive (+) et Négative (-) de la pile, la génération de chaleur, l'amorçage ou la rupture peuvent être occasionnés. Lors du transport et du rangement de l'appareil, ne pas placer le bloc-pile en même temps que des articles pouvant créer un contact électrique.*

Do Not Apply Shocks to the Battery by Dropping It or Applying Strong Pressure to It. Electrolyte leakage, generation of heat, ignition or rupture of battery may occurs.

*[FR] Ne pas faire subir de choc à la pile en la laissant tomber ou en appliquant une forte pression dessus. Une fuite d'électrolyte, la génération de chaleur, l'amorçage ou la rupture peuvent être occasionnés.*

Do Not Charge the Battery Other Than Methods Those Specified In This Manual. If the battery is not charged using one of the specified methods, electrolyte leakage, generation of heat, ignition or rupture may result.

*[FR] Ne pas charger la pile par d'autres méthodes que celles spécifiées dans ce manuel. Si la pile n'est pas chargée en utilisant l'une des méthodes spécifiées, une fuite d'électrolyte, la génération de chaleur, l'amorçage ou la rupture peuvent être occasionnés.*

When the Battery Pack Has Deteriorated, Replace It with a New Battery. Continued use of a damaged battery pack may result in heat generation, ignition or battery rupture.

*[FR] Lorsque la pile est détériorée, la remplacer par une nouvelle pile. L'utilisation continue d'une pile endommagée peut occasionner une génération de chaleur, l'amorçage ou la rupture de la pile.*

Do Not Expose the Battery Pack to Excessive Heat, or Extreme Heat (Near Fire, in Direct Sunlight for example) Generation of heat, ignition or rupture may result

*[FR] Ne pas exposer le bloc-pile à une Chaleur Excessive, ou une Chaleur Extrême (Près d'un feu, sous la lumière du soleil par exemple) Une production de chaleur, l'amorçage ou la rupture peuvent être occasionnés*

Do Not Use the Battery Pack With Any Other Products. The battery pack is rechargeable and is only designed for this specific product. If it is used with a product other than the specified product, electrolyte leakage, generation of heat, ignition or rupture may result.

*[FR] Ne pas utiliser avec un autre produit La batterie est rechargeable et a été conçue pour un produit spécifique. Si elle est utilisée sur un produit différent de celui pour lequel elle a été conçue, des pertes d'électrolytes et une production de chaleur sont possibles, elle risque également de prendre feu ou de casser.*

Do Not Use This Product With Battery Other Than the One Specified.

*[FR] Ne pas utiliser ce produit avec une batterie autre que celle spécifiée*

Discontinue using device immediately if you notice the battery is swelling, or looks puffy or misshapen. Do not attempt to charge or use the device. Do not handle a damaged or leaking battery. Do not let leaking battery fluid come into contact with your eyes, skin or clothing.

*[FR] Si vous remarquez une pile gonflée, élargie ou anormale, cesser l'utilisation de l'appareil immédiatement. N'essayez pas de recharger l'appareil ou de l'utiliser. Ne pas manipuler une pile qui fuit ou qui est endommagée. Ne laissez pas de liquide qui fuit entrer en contact avec vos yeux, votre peau ou vos vêtements.*



**General Product Safety**  
**Sécurité générale des produits**

- Do not block any ventilation openings. Do not place the product against a wall or in an enclosed space as doing so might impede the flow of cooling air.

- [FR] Ne pas bloquer les ouvertures de ventilation. Ne pas placer le produit contre un mur ou dans un espace clos de façon à entraver la circulation de l'air de refroidissement.*

- Do not place the product near any heat sources such as radiators, warm air intakes, stoves or other heat-generating devices (including amplifiers or other heat producing equipment).

- [FR] Ne pas placer le produit près d'une source de chaleur comme des radiateurs, les arrivées d'air chaud, poêles ou autres produits générant de la chaleur (y compris les amplificateurs ou autre équipement produisant de la chaleur.)*

- Protect the power cord from being crushed or pinched, particularly in the area of the plugs, any receptacles used, and the point of exit from the apparatus. Do not break off the ground pin of the power cord.

- [FR] Empêcher le cordon d'alimentation d'être écrasé ou pincé, en particulier dans les zones de prises, des containers utilisés, et du point de sortie de l'appareil. Ne pas casser la broche de terre du cordon d'alimentation.*

- Do not disregard the safety that a polarized or grounded connection can provide. A polarized connection consists of two plugs, one of which is larger than the other. A grounded connection has two blades and a third one that is grounded. If the main plug provided cannot be inserted into your outlet, consult an electrician to replace your obsolete outlet.

- [FR] Ne pas ignorer la sécurité qu'une prise polarisée ou une prise de terre peut prévoir. Une prise polarisée se compose de deux fiches, dont l'une est plus large que l'autre. Une prise de terre possède deux lames et une troisième qui est la terre. Si la fiche principale fournie ne peut être insérée dans votre prise, consultez un électricien pour remplacer votre prise obsolète.*

- Use only accessories specified by the manufacturer.  
*[FR] Utiliser uniquement les accessoires spécifiés par le fabricant.*

- This product should not be used near water such as bathtubs, sinks, swimming pools, wet basement, etc.

- [FR] Ce produit ne doit pas être utilisé près de l'eau comme les baignoires, les évier, les piscines, les sous-sols humides, etc.*

- Use only with its transport carriage, stand, tripod, console or table specified by the manufacturer or sold with the product. When using a carriage, move the carriage assembly with the product carefully to avoid damage from falling over.

- [FR] Utiliser uniquement avec son chariot de transport, support, trépied, console ou table spécifiés par le fabricant ou vendu avec le produit. Lors de l'utilisation d'un charriot, déplacez l'ensemble chariot avec le produit avec soin pour éviter tout dommage de chute.*

- Unplug this apparatus during lightning storms or when it is not being used for long periods.

- [FR] Débrancher cet appareil durant les orages ou lorsqu'il n'est pas utilisé pendant de longues périodes.*

- Refer all servicing to qualified service personnel. A technical intervention is required when the apparatus has been damaged in any way, for example if the power cord or plug is damaged, liquid has been spilled or objects have fallen inside the unit, if the product has been exposed to rain or moisture, if it does not operate normally or if it has been dropped.

- [FR] Confier toute réparation à du personnel qualifié. Une intervention technique est nécessaire lorsque l'appareil a été endommagé de quelque façon, par exemple si le cordon d'alimentation ou la fiche est endommagé, du liquide a été renversé ou des objets sont tombés à l'intérieur de l'unité, si le produit a été exposé à la pluie ou à l'humidité, s'il ne fonctionne pas normalement ou s'il a été jeté.*

## 1.3 Handling and Maintenance



### General Guideline Guide Général

Keep the product at least 13 cm (5 inches) away from electrical appliances that can generate a strong magnetic field such as TV, refrigerator, motor, or a large audio speaker.  
*[FR] Garder le produit au moins à 13 cm (5 pouces) de distance des appareils électriques qui peuvent générer un fort champ magnétique comme une télévision, un réfrigérateur, un moteur, ou un important haut-parleur.*

Do not place heavy objects on top of the tablet computer as this may damage the display.  
*[FR] Ne pas placer d'objets lourds sur le dessus de l'ordinateur tablette cela peut endommager l'écran.*

The screen surface can be easily scratched. Use with care. Do not use paper towels to clean the display but use the included cleaning cloth. Avoid touching it with a pen or pencil.  
*[FR] La surface de l'écran peut être facilement rayée. Utiliser avec précaution. Ne pas utiliser de serviette en papier pour nettoyer l'écran mais utiliser le chiffon de nettoyage inclus. Éviter de toucher avec un stylo ou un crayon.*

To maximize the life of the backlight in the display, allow backlight to automatically turn off as a result of power management. Avoid using a screen saver or other software that prevents the power management from working.  
*[FR] Pour maximiser la durée de vie du rétroéclairage de l'écran, autoriser le rétroéclairage résultant de la gestion de l'alimentation. Éviter d'utiliser un économiseur d'écran ou un autre logiciel empêchant la gestion de l'alimentation de fonctionner.*



### Cleaning Guideline Guide de nettoyage

Use a soft cloth moistened with water or a non-alkaline detergent to wipe the exterior of the product.  
*[FR] Utiliser un chiffon doux humidifié avec de l'eau ou un détergeant non alcalin pour essuyer l'extérieur du produit.*

Gently wipe the display with a soft, lint-free cloth. Do not use alcohol or detergent on the product.

*[FR] Essuyer délicatement l'écran avec un chiffon doux non pelucheux. Ne pas utiliser d'alcool ou un détergent sur le produit.*



### Touchscreen Guideline Guide de l'écran tactile

Use your finger or the stylus on the display. Using sharp or metallic object may cause scratches and damage the display, thereby causing errors.

*[FR] Utiliser votre doigt ou le stylet sur l'écran. L'utilisation d'un objet pointu ou métallique peut provoquer des rayures.*

Use a soft cloth to remove dirt on the display. The touchscreen surface has a special protective coating that prevents dirt from sticking to it. Not using a soft cloth may cause damage to the special protective coating on the touchscreen surface. To clean off hard to remove dirt, blow some steam on the particular area and gently wipe away using a soft cloth.

*[FR] Utiliser un chiffon doux pour enlever la poussière sur l'écran. La surface de l'écran tactile a un revêtement protecteur spécial empêchant la saleté de se coller à lui. Ne pas utiliser un chiffon doux peut endommager le revêtement spécial sur la surface de l'écran tactile. Pour nettoyer les saletés plus difficiles à enlever, souffler de la buée sur la zone particulière et essuyer doucement avec un chiffon doux.*

Do not use excessive force on the display. Avoid placing objects on top of the display as this may cause the glass to break.

*[FR] Ne pas utiliser une force excessive sur l'écran. Éviter de placer des objets au dessus de l'écran cela pourrait provoquer une cassure du verre.*

When there is a noticeable discrepancy in the operation of the touchscreen function (your touch does not correlate to the proper location on the screen), recalibrate the touchscreen display.

*[FR] Lorsqu'il y a un écart sensible dans le fonctionnement de l'écran tactile (votre contact ne correspond pas à la bonne position sur l'écran), recalibrer l'écran tactile.*

## 1.4 Declaration of Conformity (DoC)

### FCC Statement

This device complies with part 15 FCC rules.



Operation is subject to the following two conditions:

- This device may not cause harmful interference.
- This device must accept any interference received including interference that may cause undesired operation

This equipment has been tested and found to comply with the limits for a class "B" digital device, pursuant to part 15 of the FCC rules. These limits are designed to provide reasonable protection against harmful interference when the equipment is operated in a commercial environment. This equipment generates, uses, and can radiate radio frequency energy and, if not installed and used in accordance with the instruction manual, may cause harmful interference to radio communications. Operation of this equipment in a residential area is likely to cause harmful interference in which case the user will be required to correct the interference at his own expense.

### CE Notice (European Union)



Electromagnetic Compatibility Directive (2014/30/EU)

- EN55024: 2010/ A1: 2015
  - IEC61000-4-2: 2009
  - IEC61000-4-3: 2006+A1: 2007+A2: 2010
  - IEC61000-4-4: 2012
  - IEC61000-4-5: 2014
  - IEC61000-4-6: 2014
  - IEC61000-4-8: 2010
  - IEC61000-4-11: 2004
- EN55032: 2012/AC:2013
- EN61000-3-2:2014
- EN61000-3-3:2013

Low Voltage Directive (2014/35/EU)

- EN 60950-1:2006/A11:2009/A1:2010/A12:2011/ A2:2013

This equipment is in conformity with the requirement of the following EU legislations and harmonized standards. Product also complies with the Council directions.



## Chapter 2: Getting Started

This chapter tells you step by step how to get the Tablet Computer up and running.

### 2.1 Introduction

Thank you for purchasing 10.1-inch Rugged Windows Tablet Computer M101S. The M101S is a rugged tablet PC with robust set of features designed to withstand industrial use while providing high tech solutions that increase productivity, improve safety, and reduce operational costs. The processing power comes from Intel's Apollo Lake processor paired with genuine Intel graphics for high performance. The tablet features a brilliant, in-plane switching with direct optical bonding, projective capacitive touch screen, which is outdoor viewable and offers 1920 x 1200 pixel resolution. Weighing at just 2.7 pounds (approx. 1200 grams) the M101S delivers lightweight mobility in a rugged tablet.

#### Highlights

- Intel® Apollo Lake Pentium N4200 Processor
- 10.1" 1920 x 1200 IPS LED Panel with direct optical bonding
- Optional 1D/2D Barcode Reader and HF RFID for data collection
- Hot-swappable battery design with optional high capacity battery pack
- IP65 waterproof and dustproof
- Rated for extreme temperature use
- Optional Expansion port for USB / RS232 connection

## 2.2 Unpacking

Check and identify the standard supplied accessories.

### Standard factory shipment list:

- Tablet Computer

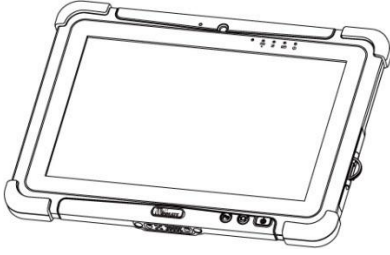

- Standard Battery



- Power Adapter



- Power Cord and Plugs



- Capacitive Touch Stylus

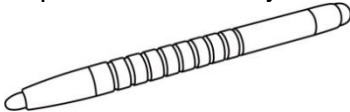

- Quick Start Guide & Driver CD

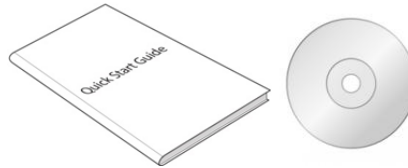

### Your package may include other optional accessories based on your order.

- Desk Dock
- Vehicle Dock
- Battery Charger
- Active Pen
- High Capacity Battery
- Hand Strap
- VESA Mount Kit
- Shoulder Strap
- Carry Bag
- Micro HDMI Cable
- Vehicle Charger
- Mobile Printer MX20/MX30

## 2.3 Description of Parts

Front:

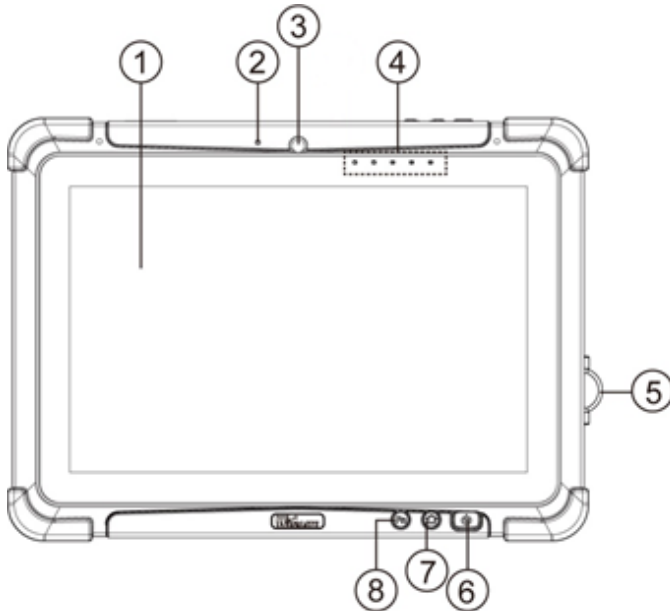

Right:

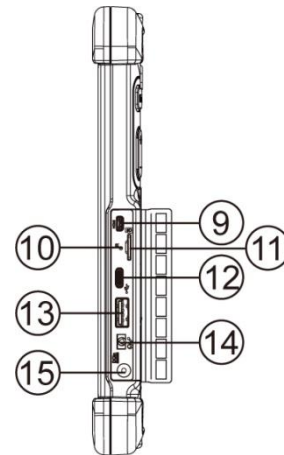

No	Item	Description
1	10.1" Touch Screen	Display and act as one of the inputs for the Tablet Computer
2	Digital Mic with noise cancellation	Use during video recordings and communications.
3	Front Camera	2 Megapixel Webcam
4	Light Sensor and LED Indicators	Show the current status of the Tablet Computer. RF communications, storage, battery status, power status.
5	I/O Cover	Protect I/O ports
6	Power Button	Power on/off tablet
7	Menu Button	Hottab Quick Access
8	Fn1 Button	Programmable function key configured by Hottab Utility

Front LED Indicator Details:

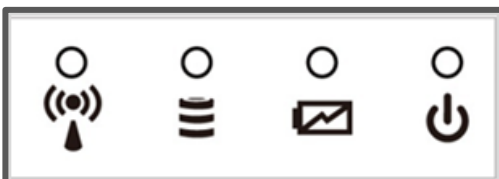

No	Item	Description
9	Micro HDMI	HDMI output to external display
10	Reset Button	Hardware reset button
11	MicroSD Card Reader	Memory card reader port for MicroSD Card
12	USB 3.0 Type C	High speed USB port connects to USB devices, such as USB flash drive, mouse, keyboard, printer, etc. ※No ALT Support, Power Output 5V/0.9A
13	USB 3.0 Type A	USB 3.0 port connects to USB devices, such as USB flash drive, mouse, keyboard, printer, etc.
14	Mic In/Line Out	Headset or headphone can be connected (Mic is only supported with 3.5mm 4-pin headset)
15	Power Jack	DC power input jack.

**Rear:**

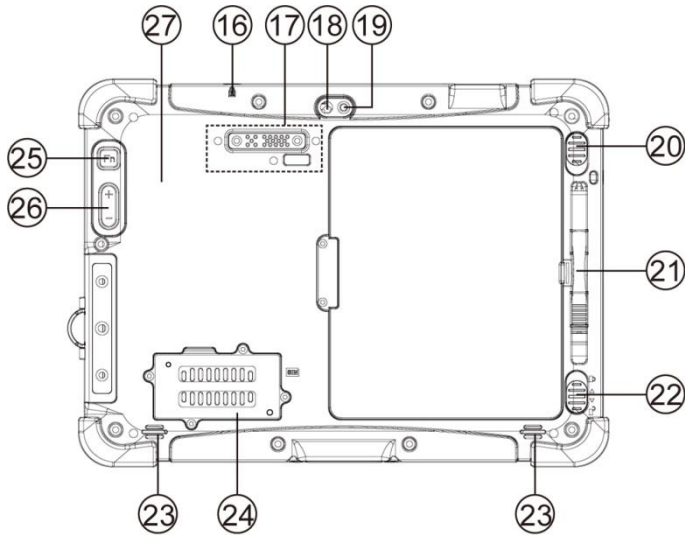

**Top:**

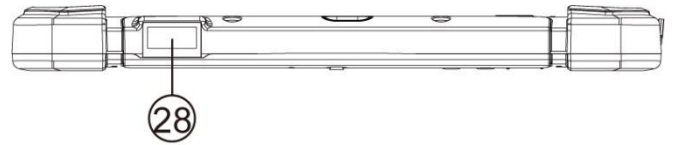

**Bottom:**

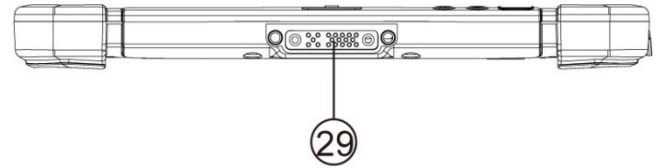

No	Item	Description
16	Kensington Lock Port	Provide lock access for Kensington Lock.
17	Optional Extension Port	Provides connectivity to custom modules for special applications (USB2.0 x 1, RS232 x 1).
18	Camera Flash	LED camera flash to provide flash lighting when use with camera.
19	Rear Camera	8MP Autofocus Camera. Captures photos and videos.
20	Battery Release Slider	Spring-loaded slider that latches the battery in.
21	Touch Pen Slot	Pen holder slot to store touch pen
22	Battery Lock Latch	Latch to lock the battery in place once battery is inserted. Not spring-loaded.
23	Speakers	Emit sounds.
24	3G / LTE Module / SIM card slot	Service window to insert Micro SIM card. Also provide access to 3G / LTE Module.
25	Fn Button	Programmable function key.
26	Volume Buttons	Volume Control. (+) Raise volume, (-) Lower volume.
27	Optional RFID Reader	RFID Reader for reading RFID tags.

No	Item	Description
28	Optional Barcode Scanner	Barcode Scanner for reading of 1D/2D barcode.
29	Docking Connector	Port to docking solutions such as vehicle docking to provide power and external antenna

## 2.4 Hotkey for Specific Functions

For the physical buttons on the tablet computer, in addition to its dedicated functions detailed in the previous section, it can also be used to emulate commonly used keyboard key strokes. Under different scenario, a single physical button or a combination of physical buttons provide different keyboard key strokes, which are specified below:

### In POST (before Windows boots up):

Buttons	Keystroke
<b>Fn1</b>	F6 to enter Recovery Menu
<b>Fn2</b>	F7 to enter BIOS setup screen
<b>Volume Up (+)</b>	Up
<b>Volume Down (-)</b>	Down
<b>Menu + Fn1</b>	Enter
<b>Menu + Volume Up (+)</b>	Right
<b>Menu + Volume Down (-)</b>	Left

### In Windows:

Buttons	Keystroke
<b>Menu</b>	Hottab Quick Access
<b>Fn1</b>	Default: Web Browser
<b>Fn2</b>	Default: Camera
<b>Volume UP (+)</b>	Raise volume
<b>Volume Down (-)</b>	Lower volume.
<b>Power</b>	Power ON/ OFF
<b>Volume Up (+) + Volume Down (-)</b>	Ctrl + Alt + Del

### LED Indicators:

Item		Description
<b>Power Indicator</b>		<b>Blue</b> – Tablet is ON <b>No light</b> – Tablet is OFF
<b>Battery Status</b>		<b>Orange</b> –AC adapter is plugged in and charging <b>Green</b> –AC adapter is plugged in and battery is full charged <b>Solid Red</b> - Low battery (<10%) <b>Blinking Red</b> – Battery is being hot swapped. <b>No light</b> – Battery is in use and more than 10%
<b>Disk Activity Indicator</b>		<b>Green</b> - Disk Activity <b>No light</b> - Disk Idling
<b>RF Communication</b>		<b>Green</b> - WiFi/BT/WWAN/GPS ON <b>No light</b> - WiFi/BT/WWAN/GPS are all OFF

## 2.5 First-Time Operation

To get started:

1. Install SIM card.
2. Install storage card.
3. Install the battery.
4. Charge your tablet.
5. Start the tablet.

### 2.5.1 Installing SIM Card (For 3G/LTE Equipped Devices)

The Tablet Computer supports 3G/LTE data connection and fits a Micro-SIM card.

To install the SIM card:

1. Unscrew four screws that secure the service window in the rear.
2. Remove the screw that secures the 3G/LTE module.
3. Carefully lift the module up. Do not to damage the connected cable!
4. Install SIM Card into slot with IC facing down the contact patch. Reposition the removed 3G/LTE module screw and service window screws to secure the service window.

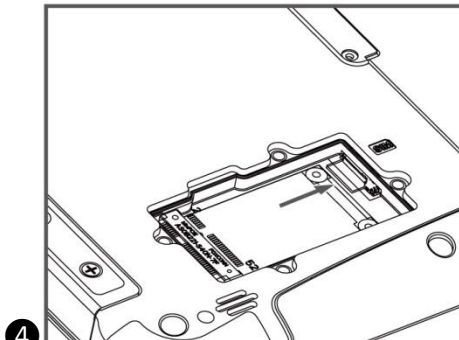
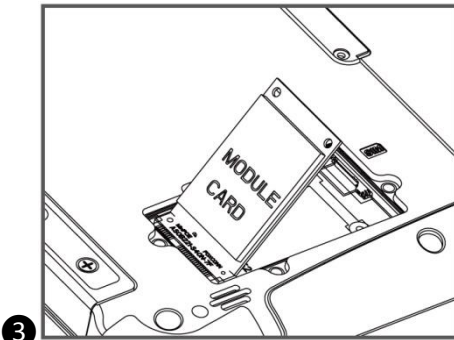
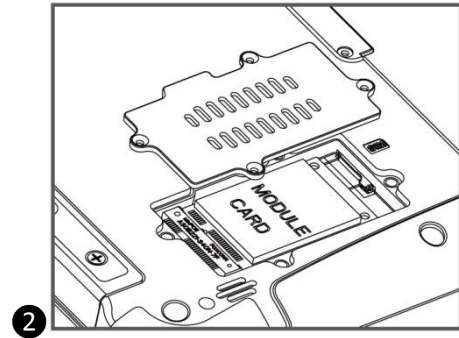
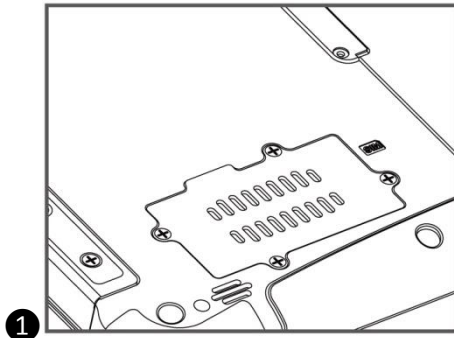

## 2.5.2 Installing a Micro SD Card

Your tablet supports up to 128GB additional storage with an optional microSD card slot.

*To install Micro SD Card:*

1. Open I/O protective cover by pulling out the latch.
2. Insert microSD card into slot with contacts facing down.
3. Press the card in to ensure that it is seated properly.
4. Close I/O protective cover.

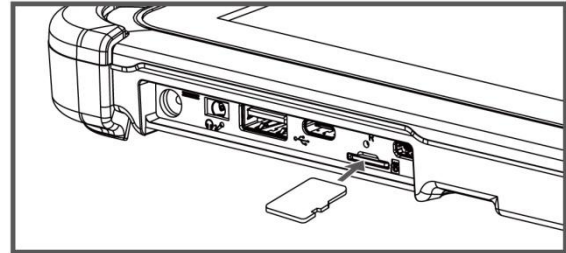
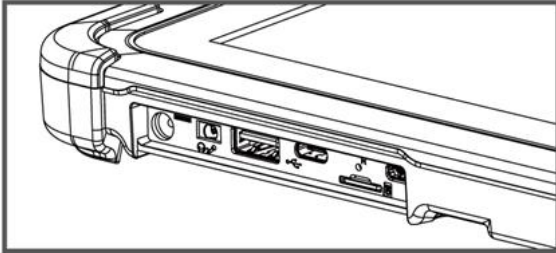

*To remove Micro SD Card:*

1. Open I/O protective cover by pulling out the latch.
2. Push and release the micro SD card to unlock it.
3. Pull out the micro SD card.

## 2.5.3 Installing Battery

*To install the standard battery pack:*

1. Disconnect any cords connected to the tablet computer.
2. Turn the tablet over, back facing up.
3. Locate the Battery Lock Latch and push it to the “Unlocked” position.
4. Locate the Battery Release Slider that is spring-loaded. Pull back and hold.
5. Insert the battery with the connector-pins side first, and then lower the battery into the battery compartment. Continue to hold the Battery Release Slider until the battery is fully inserted.
6. Make sure the battery is completely lowered into the compartment before letting go of the Battery Release Slider. Battery will be flat against the housing once fully inserted.

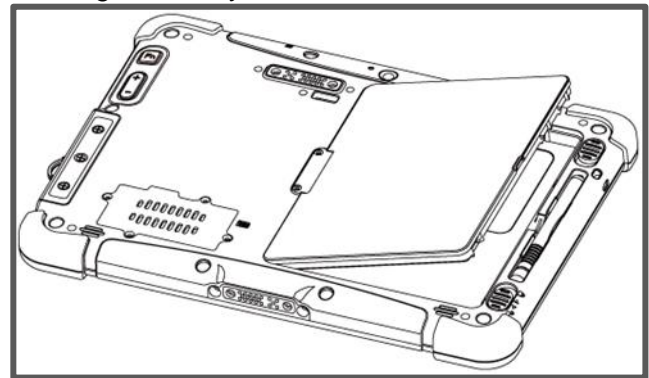
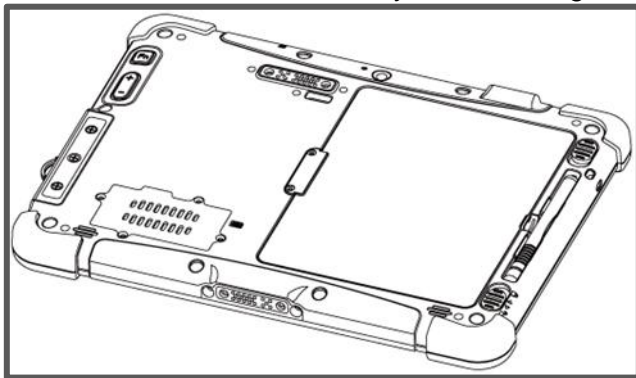

*To remove the battery pack:*

1. Shut down the tablet (or put into sleep mode). Disconnect any cords connected to the computer.
2. Turn the tablet computer over, back facing up.
3. Locate the Battery Lock Latch and push it to the “Unlocked” position.
4. Locate the Battery Release Slider that is spring-loaded. Pull back and hold.
5. Lift the battery out using the opening on the side of battery compartment.

## 2.5.4 Charging Your Tablet

The Tablet operates either on external AC power or internal battery power. It is recommended to use AC power when you start up the Tablet for the first time.



**Caution:** Use only the AC adapter included with your Tablet Computer. Using other AC adapters may damage the Tablet Computer and the Battery.

To connect a tablet to AC power:

1. Open I/O protective cover by pulling out the latch.
2. Plug the DC cord of the AC adapter into the power jack of the tablet computer.
3. Plug the AC power cord into the AC adapter.
4. Plug the AC power cord into the electrical outlet.

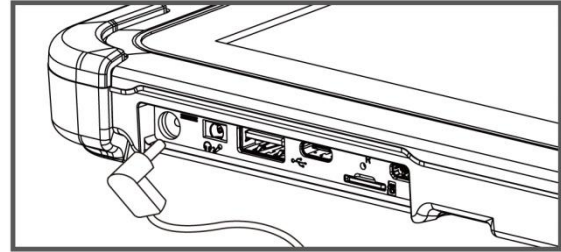
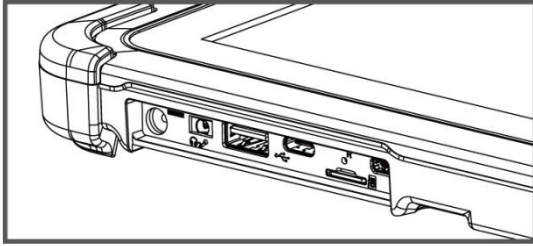

The battery LED indicator shows different battery states:

- Orange** - AC adapter is plugged in and battery is charging.
- Green** - AC adapter is plugged in and battery is fully charged.
- Solid Red** - Low battery level (<10%).
- Blinking Red** - Battery is being hot swapped.
- No light** - Battery is in use and charged (>10%).

Item	Battery Operation Time	Battery Charging Time
<b>Standard Battery (BS101)</b>	8 Hours	2.5 Hours
<b>High Capacity Battery (BL101)</b>	16 Hours	4.5 Hours

## 2.5.5 Starting the Tablet



**Important:** When powering on the device for the first time, please make sure there's no interruption during the Windows setting up process, for example, accidentally powering off. If it happened, please access the recovery menu by pressing **Fn1** button on the front bezel to initiate recovery process.

Press and hold the power button for **3 seconds** until the blue LED power indicator light up.



- Note:** Do not press the power button repeatedly.  
Do not perform the following operations until the Disk Activity Indicator off
- Connecting or disconnecting the AC adapter
  - Pressing the power button
  - Touching the tablet buttons, screen, or external keyboard/mouse

To power off the Tablet Computer:

1. Make sure you have closed any programs that are open on the Desktop. Start Screen apps don't need to be closed.
2. Tap on the **Settings** charm.
3. Tap on **Power**.
4. Tap on **Shut Down**.
5. Wait for Tablet Computer to power off.



**Note:** The computer will forcibly be powered off if the power button is pressed and held for **6 seconds or longer**.



## Chapter 3: Setting Up Windows for the First Time

This chapter details how to setup the Windows that may be installed on the tablet for the first time.

### 3.1 Introduction

The M101S Tablet Computer operates on Windows 10 IoT Enterprise operating system.



**Caution:** Make sure the battery is full charged before starting the Tablet Computer for the first time with internal battery power.

- **Public network:** Select this location if you do not recognize all the computers on the network. (For example, you are in a coffee shop or airport, or you have mobile broadband.) This is a public network and is *not* trusted. Select the location where you will most often use the computer.

### 3.2 Setting up Windows 10 IoT Enterprise

Follow the steps below to complete the Windows 10 IoT Enterprise setup process.

1. Press the power button to turn on the computer.
2. First, select your country/region, your preferred app language, your preferred keyboard layout, and your time zone, then tap **Next**.

Hi there

Let's get a few basic things out of the way.

What's your home country/region?

United States

What's your preferred app language?

English (United States)

What keyboard layout would you like to use?

US

What time zone are you in?

(UTC-08:00) Pacific Time (US & Canada)

Next

3. On the **Here's the legal stuff** screen, read through the disclosures, then tap **Accept**.

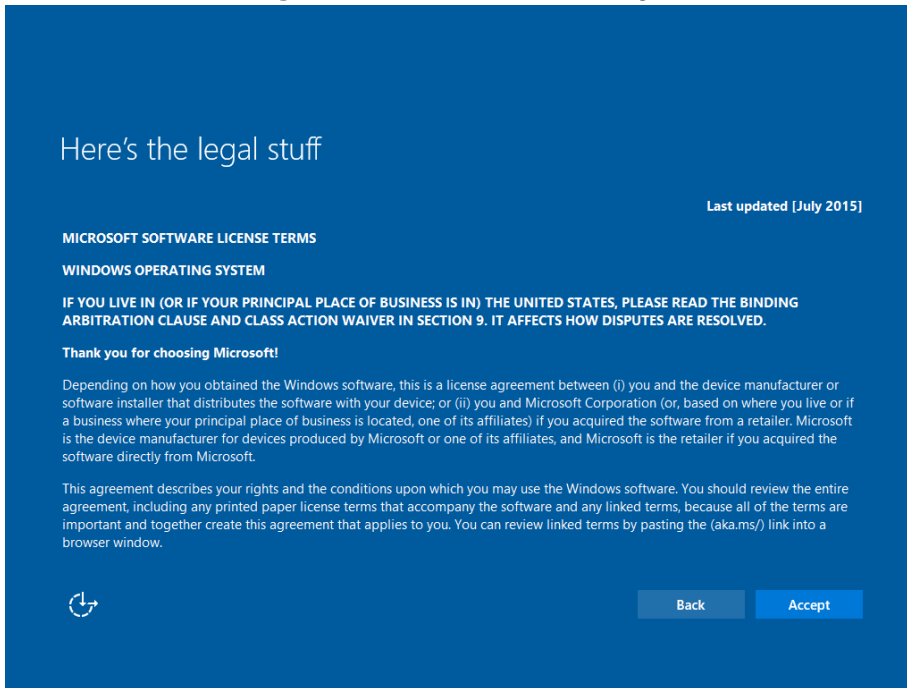

4. Windows will then try to connect to network. Tap **Skip this step** to continue without a wireless connection as you can then set up the network later.
5. On the **Get going fast** screen, click **Use Express settings** for the fastest setup. If you would like more information, tap **Learn more**, or if you would like to select your own options, click **Customize settings**.

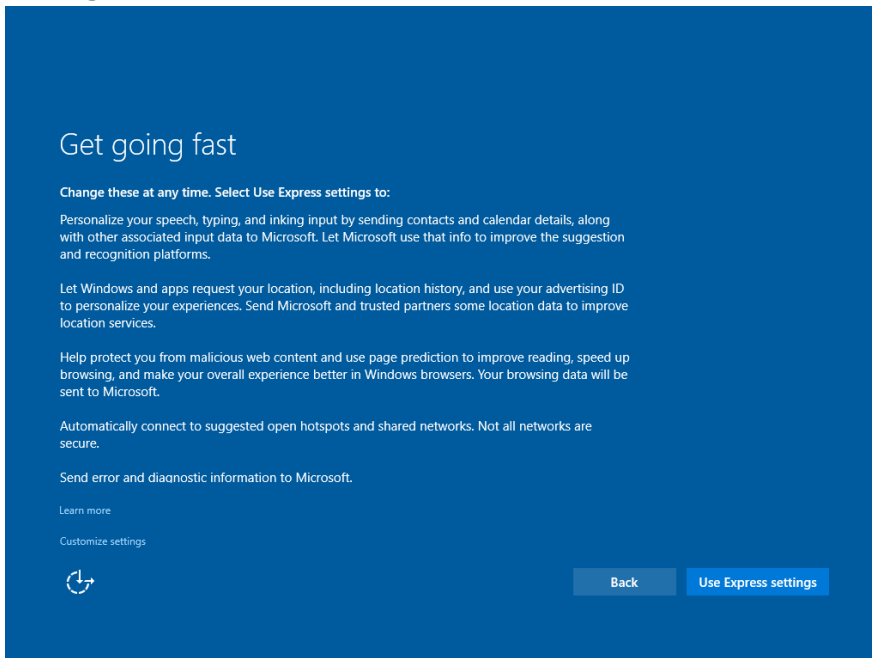

- To create a local account, type your User name, password, and Password hint in the fields provided, then tap **Next**.

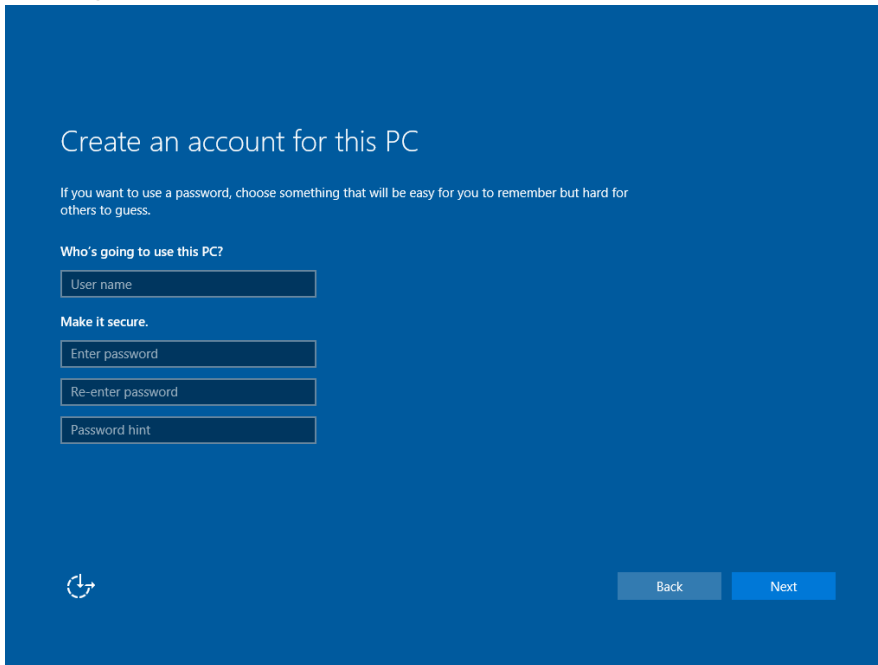

The screenshot shows the 'Create an account for this PC' screen. At the top, it says 'Create an account for this PC'. Below that, a note reads: 'If you want to use a password, choose something that will be easy for you to remember but hard for others to guess.' The screen is divided into two sections: 'Who's going to use this PC?' with a 'User name' input field, and 'Make it secure.' with three input fields: 'Enter password', 'Re-enter password', and 'Password hint'. At the bottom left is a refresh icon, and at the bottom right are 'Back' and 'Next' buttons.

- The initial setup screens are complete, and the desktop is displayed.
- Read any introductory screens describing features of your computer, and tap **Next** upon completing each. You are now done with the initial setup process.

## Chapter 4: Operating the Device

This chapter describes how to operate the M101S Tablet Computer, including camera, Hottab, barcode, RFID, WWAN, WLAN, GPS features.



### Note:

Please download the SDK from Winmate Download Center [here](#).

>> M101S >> Development Kit or check the Driver CD which is shipped with the tablet. Please notice that HF RFID reader, Barcode reader, and UHF RFID reader are optional module, please make sure user have ordered the module before using the SDK.

### 4.1 Hottab Introduction

Hottab provides quick access to the tablet's functions and features, such as setting up shortcuts, using camera, powering on/off built-in devices, programming function key, and changing power management.

As Windows starts up, Hottab starts and runs in the background. To display the Hottab control utility, press the  (Menu) Button located on the front panel, OR launching the Hottab Utility application.

 (Menu) Button on the Front Panel:

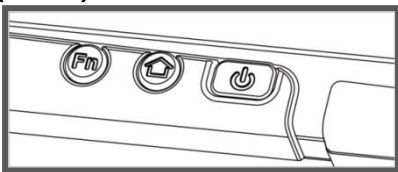





Hottab Utility Icon:

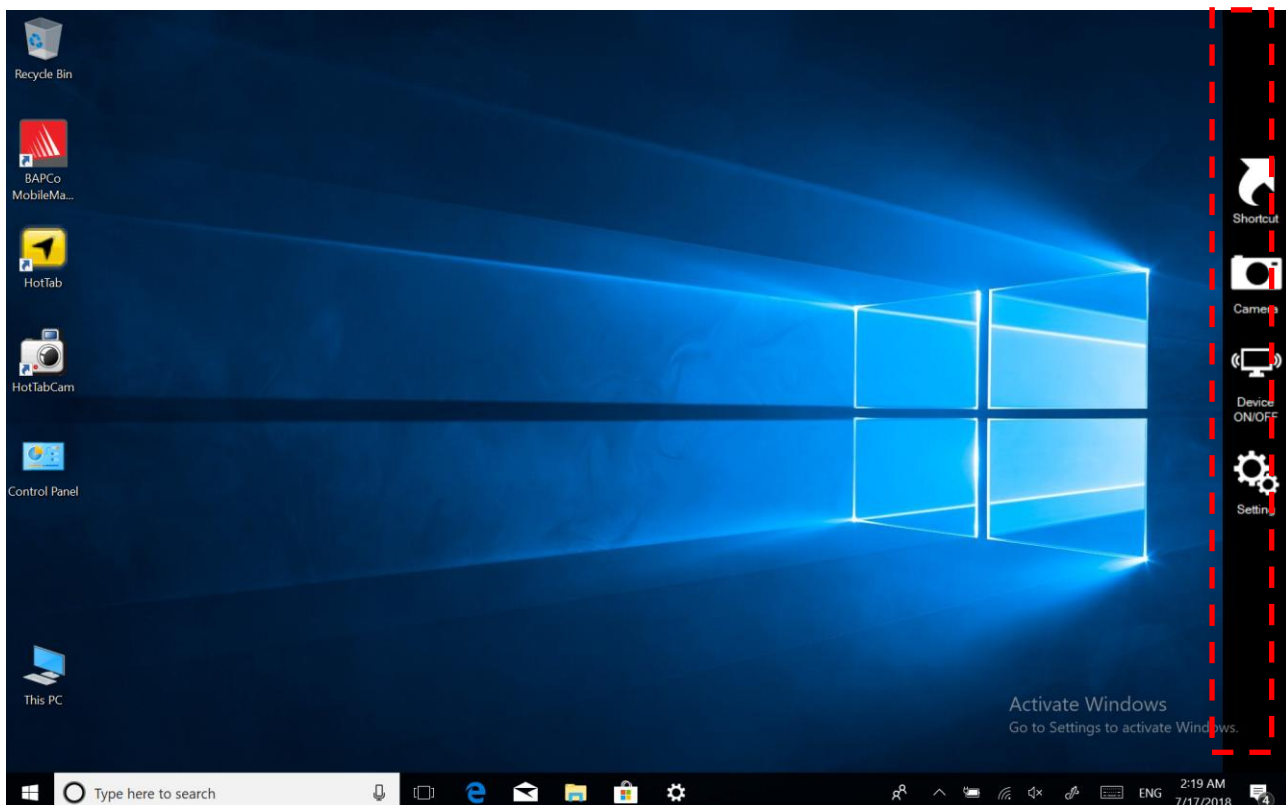

The main user interface is located on the right side of the screen. There are 4 main menu options: Shortcuts, Camera, Device ON/OFF, and Settings. Operations and functions on each menu options is explained in detail in the coming section.



Icon	Description
 Shortcuts	Allows users to configure short cut to quickly access programs with a few tabs.
 Camera	Allows users take a picture or record a video. User can also adjust setting related to camera in this menu option.
 Device ON/OFF	Enables/disables tablet computer's hardware functions. The configurable functions are Wi-Fi, WWAN (3G/4G/LTE), GPS, Bluetooth, Camera, LED indicators, Barcode Reader, RFID Reader, and GPS Antenna routing options.
 Settings	Provides users information such as PC Information, Battery status, and also device settings such as power managements setting, and function key mappings.

## 4.2 Shortcuts



### 4.2.1 Set up On-screen Software Shortcuts

Hottab Shortcuts Menu provides an user-friendly interface to configure on-screen software short cuts and allow users to quickly access programs with a few tabs. The Shortcuts menu offers 8 empty slots to store user's desired quick access. Shortcuts can be mapped to any of the executable files (.exe) installed on the tablet.

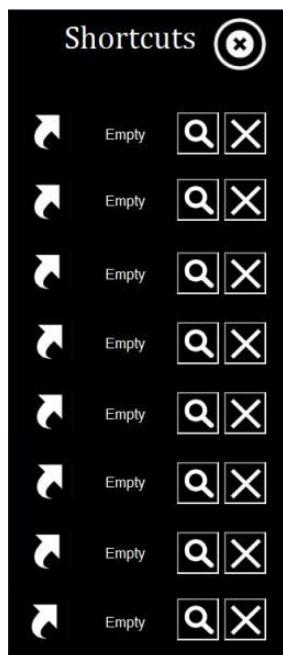

#### Short Cut Menu:



#### To store a new shortcut:

1. Open the Hottab utility by press the  (Menu) Button located on the front panel, OR launching the Hottab Utility application.
2. Tap on the **Shortcuts** button.
3. Tap on  button of any empty slot.
4. An on screen file browser will appear.
5. Browse to find the desired application to have shortcut.
6. Click "Open" to save the shortcut.

#### To remove an saved shortcut:

1. Open the Hottab utility by press the  (Menu) Button located on the front panel, OR launching the Hottab Utility application.
2. Tap on the **Shortcuts** button.
3. Tap on the  button of any saved slot to remove
4. Shortcut will be removed, and once again show "Empty" to indicate slot is empty.

Tap on the  button will hide the Hottab Utility Menu.

#### Using the Hottab shortcuts:

1. Open the Hottab utility by press the  (Menu) Button located on the front panel, OR launching the Hottab.
2. Tap on the **Shortcuts** button.
3. Tap on the saved shortcut items to access saved programs.

## 4.3 Using Camera

This Hottab menu option allows users take a picture or record a video. Before use, make sure the camera is powered on under Devices ON/OFF menu with the following scenarios.





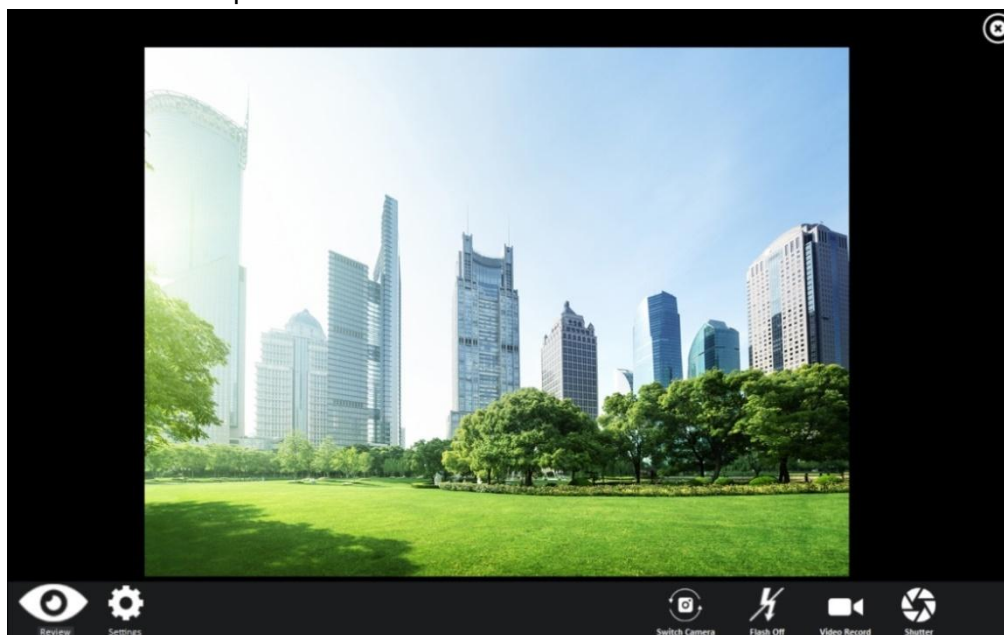

To open camera interface:

1. Press the  (Menu) button located on the front panel to open Hottab or launch the Hottab Utility.
2. Tap on "Device ON/OFF" button to check the built-in devices status.
3. Check the status color of the **Camera** icon:

Item	Status Color	Description
 <b>Camera</b>	Orange	Camera is enabled.
	White	Camera is disabled.

4. If the Camera is disabled (white), tap on the *Camera* icon to enable it (orange).
5. Go back to the Hottab main menu by pressing the  (Menu) Button OR click on the back arrow on top.
6. Tap on the *Camera* icon to open Camera menu.



No	Item	Description
1	Review 	Review
2	Settings 	Opens Camera settings page. Available Settings: <ul style="list-style-type: none"> <li>• <b>Picture Save:</b> modify/inspect saved location for pictures.</li> <li>• <b>Video Save Folder:</b> modify/inspect saved location for video recordings.</li> <li>• <b>Picture Quality:</b> Picture compression quality.</li> </ul>
3	Camera Switch 	Switch between front camera or rear camera.
4	Flash Control 	Enables/ Disables LED Flash when taking picture.
5	Video Record 	Tap to Start, and press again to stop recording.
6	Shutter Camera 	Camera Shutter Button. Tap to take picture.
7	Exit 	Exits the Camera and hide Hottab Utility.

## 4.4 Built-in Devices On/Off

This section describes how to get a quick access to set-up built-in devices, including turning on/off RF modules, setting up barcode reader, RFID reader, and expansion modules.

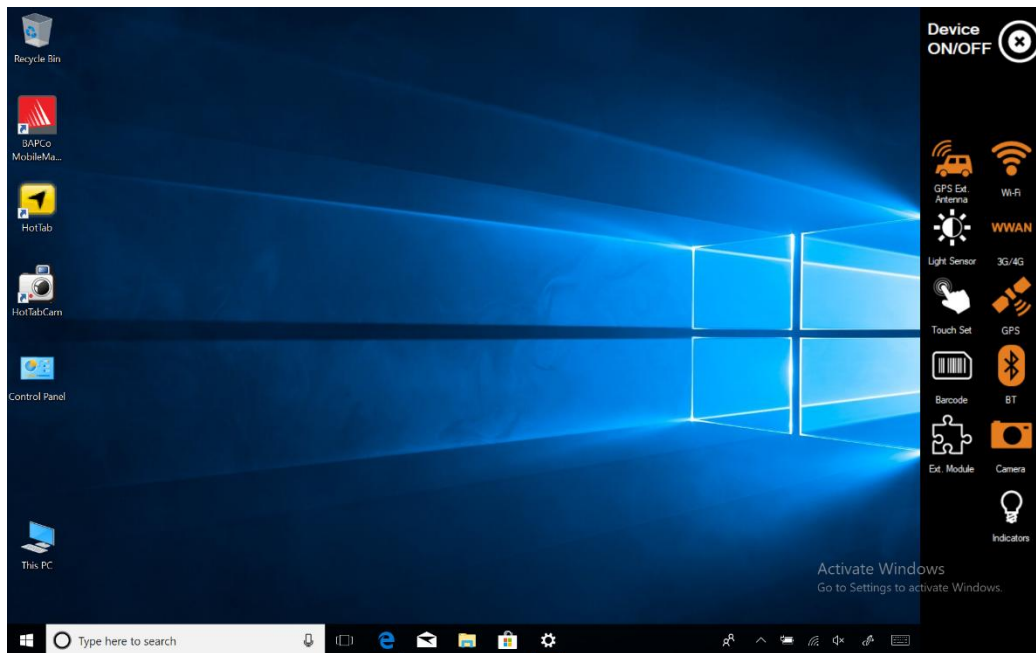

### 4.4.1 Using the Wireless LAN (Wi-Fi)

To use the wireless LAN (Wi-Fi) feature to connect to the network, perform the following procedure:

1. Open the Hottab utility by press the  (Menu) Button located on the front panel, OR launching the Hottab Utility application.
2. Tap on the **Device ON/OFF** button.
3. Check the status color of the **Wi-Fi** icon:

Item	Status Color	Description
	Orange	Wi-Fi is enabled.
	White	Wi-Fi is disabled.

4. If the Wi-Fi feature is disabled (white), tap on the Wi-Fi icon to enable it (orange).
5. Click the wireless network connection status icon in the Windows notification area. A list of available wireless networks is displayed.
6. Double-click a network to connect to it. Provide required authentication information if needed.
7. To check the connection status, observe wireless network connection status icon in the Windows notification area. The more bars the icon shows, the better the wireless LAN connection strength is.
8. Now wireless LAN connection is setup, try connection to the network with a internet browser such as Internet Explorer.

## 4.4.2 Using the Wireless WAN (3G/LTE)

The Tablet Computer supports data connection with 3G/LTE modules and fits Micro-SIM card. (**Note:** 3G/LTE feature is optional).

### 4.4.2.1 Installing a SIM card



#### Caution

Power off the tablet before installing the 3G/LTE module and Micro SIM card, or the tablet computer might be damaged by the incorrect installation behaviors.

To install the SIM card:

1. Unscrew four screws that secure the service window in the rear.
2. Remove the screw that secures the 3G/LTE module.
3. Carefully lift the module up. Do not to damage the connected cable!
4. Install SIM Card into slot with IC facing down the contact patch. Reposition the removed 3G/LTE module screw and service window screws to secure the service window.

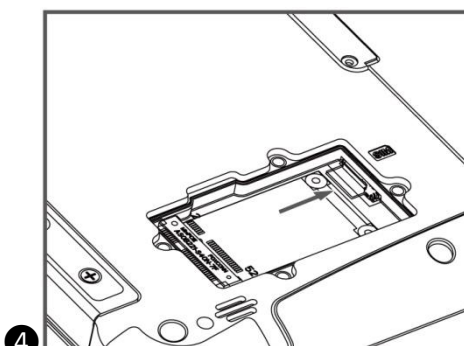
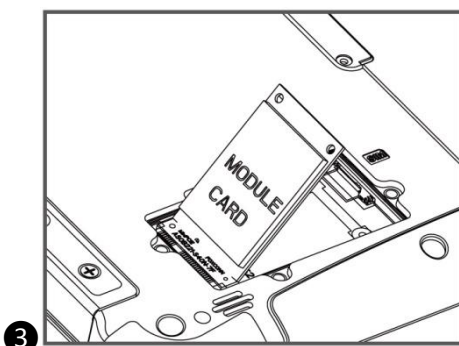
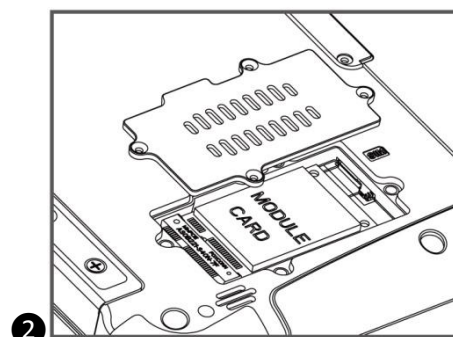
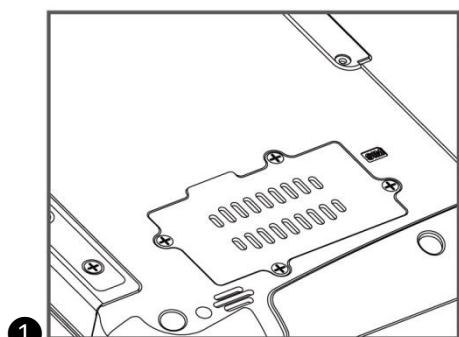

### 4.4.2.2 Using Wireless WAN Feature

To connect to the network using wireless WAN:

1. Open the Hottab utility by press the  (Menu) Button located on the front panel, OR launching the Hottab Utility application.
2. Tap on the **Device ON/OFF** button.
3. Check the status color of the **WWAN** icon:

Item	Status Color	Description
	Orange	WWAN (3G/4G) is enabled.
	White	WWAN (3G/4G) is disabled.

4. If the WWAN feature is disabled (white), tap on the WWAN icon to enable it (orange).



5. You can check the wireless WAN connection status through the wireless network connection status icon in the Windows notification area. The more bars encompassed, the better the signal is.

### 4.4.3 Using the GPS

To enable the GPS:

1. Open the Hottab utility by press the  (Menu) Button located on the front panel, OR launching the Hottab Utility application.
2. Tap on the **Device ON/OFF** button.
3. Check the status color of the **GPS** icon:

Item	Status Color	Description
	Orange	GPS is enabled.
	White	GPS is disabled.

4. If the GPS feature is disabled (white), tap on the GPS icon to enable it (orange).
5. Now the GPS feature is ready to be used with an application utilizing the GPS.

### 4.4.4 Using the Bluetooth

To enable the Bluetooth:

1. Open the Hottab utility by press the  (Menu) Button located on the front panel, OR launching the Hottab Utility application.
2. Tap on the **Device ON/OFF** button.
3. Check the status color of the **Bluetooth** icon:

Item	Status Color	Description
	Orange	Bluetooth is enabled.
	White	Bluetooth is disabled.

4. If the Bluetooth feature is disabled (white), tap on the Bluetooth icon to enable it (orange).
5. Click the Bluetooth icon in the Windows notification area. A contextual menu for Bluetooth is displayed.
6. To add a device, tap on *Add a Bluetooth Device*. Windows will search any Bluetooth device automatically
7. Choose the Bluetooth device to connect and follow onscreen prompt to continue the pair procedure and use the Bluetooth device.

#### 4.4.5 Turning On/Off LED Indicators

The LED Indicators for Power Status, Battery Status, and RF Communication can be turned on/off from Hottab menu.

To enable/disable the LED indicators:

1. Open the Hottab utility by pressing the  (Menu) Button located on the front, OR launching the Hottab Utility application.
2. Tap on the **Device ON/OFF** button.
3. Check the status color of the **Indicator** icon:

Item	Status Color	Description
	Orange	LED indicator is enabled.
	White	LED indicator is disabled.

4. If the indicator is disabled (white), tap on the Indicator icon to enable it (orange).

## 4.4.6 Using the Barcode Reader

The 2D/1D Barcode Reader is optional for M101S Tablet PC and is not re-workable by the end user. To use this feature, please make sure the tablet PC is built-in barcode reader before use, or contact our sales contact window for more details.



**Note:**

Download the SDK from Winmate Download center [here](#).  
 >> M101S >> Development Kit or check the Driver CD which is shipped with the tablet.

To enable the Barcode Reader:

1. Open Hottab utility by pressing  (Menu) Button located on the front panel or launching Hottab Utility application.
2. Tap on the **Device ON/OFF** button.
3. Check the status color of the **Barcode** icon.

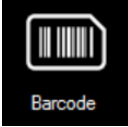
Item	Status Color	Description
	Orange	Barcode Reader is enabled. Reading will need to be triggered manually thru Fn button.
	White	Barcode Reader is disabled.

4. Open the application where barcode reader will be displaying the scanned barcode.
5. Trigger the barcode reader by pressing Fn2 function key.

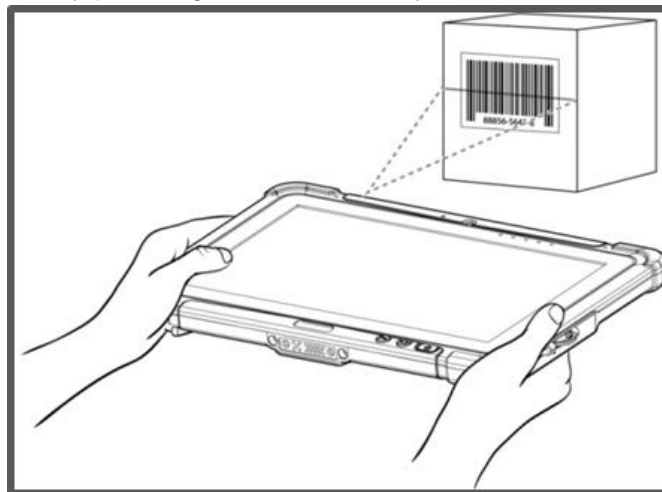

Tap **Disconnect** button to stop the connection with Barcode Reader.

*\*To recover the connection, please tap on the button again to re-connect with Barcode Reader.*

### 4.4.6.1 Device Configuring and Setting

1. Click on Windows  and search for **EZConfig-Scanning** from the Start menu.

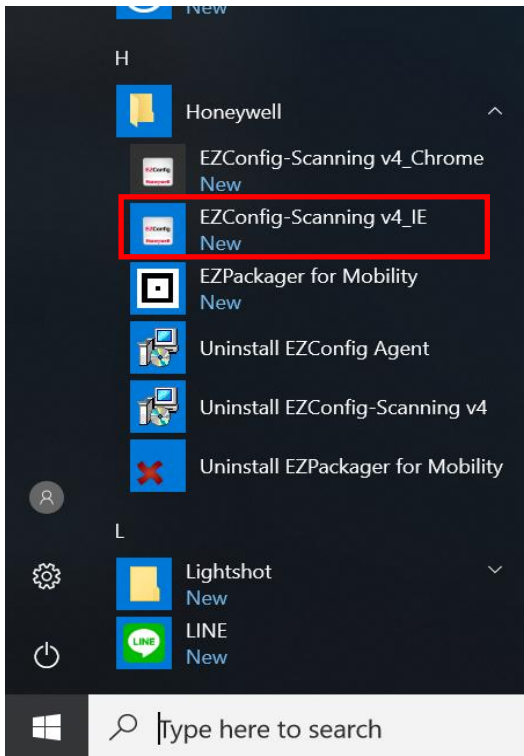

2. Click on **EZConfig-Scanning v4\_IE** and allow the blocked content if browser is blocking the content.

3. Click on “Connected Device” icon and wait for system to discover the device (Honeywell N660X).

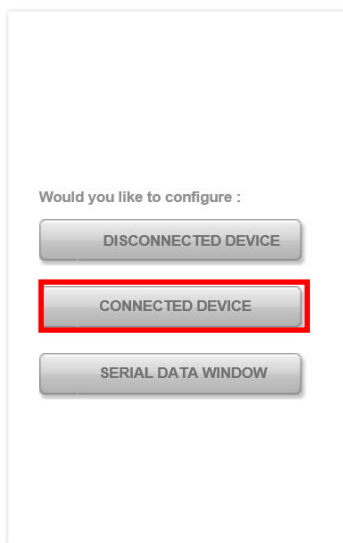

EZConfig-Scanning provides a wide range of programming functions that can be performed on a Honeywell scanning device connected to a computer. EZConfig-Scanning allows you to change programmed parameters, create and print programming bar codes and update device firmware.

Internet Explorer restricted this webpage from running scripts or ActiveX controls.

Allow blocked content

4. Once Honeywell N660X is discovered please click “**Configure Device**” button as shown.

**CONNECTED DEVICE**

Home ▶ Connected Device

Refresh



**Honeywell N660X Series  
Area Image Engine**

Model: **N660X**

Serial No: **18036B086F**

Firmware No: **BI000858HAC**

Connection: **USB HID KBD**

[Show License/Plug-in Info](#)

**Firmware is up to date**

**Note:** Click on the device to connect / disconnect

CONFIGURE DEVICE

UPDATE FIRMWARE

SCAN DATA WINDOW

#### 4.4.6.2 Scanning mode Settings

1. Click on Device Settings under the Input/Output settings section.

Honeywell N660X Series Area Image Engine

  
**1.SETTINGS**

  
 2.SYMBOLOGIES

  
 3.DATA FORMATTING

  
 4.IMAGING

  
 5.SCAN DATA WINDOW

  
 6.COMPARE

Input/Output Settings | Interfaces | Licenses / Plug-ins (Apps) |

Beeper Settings | Scanning Options | Device Settings

2. Select the desire scanning mode from the drop-down menu shown as below.

## Scanning Mode Modifiers

Scanning Mode **Host Notify Mode** *Default: 0*  
 Manual Trigger  
 Presentation Mode  
 Snap And Ship Mode  
 Streaming Presentation(TM) Mode

Presentation LED Behavior After Decode

Presentation Sensitivity  *Range: 0-20 Default: 1*

Presentation Mode Pre Aimer Delay **Off**  **On** *Default: 1*

TRGMMF  *Default: 0*

Trigger Pre Aimer Delay  *Range: 0-9999 Default: 0*

TRGOTO  *Range: 0-9999 Default: 2500*

3. After selecting a desire scanning mode, click on the “**Save to Device**” on the side bar.



Scanning mode	Description
Manual Trigger	When in manual trigger mode, the scanner scans until a bar code is read, or until the trigger is released. Two modes are available, <b>Normal</b> and <b>Enhanced</b> . Normal mode offers good scan speed and the longest working ranges (depth of field). Enhanced mode will give you the highest possible scan speed but slightly less range than Normal mode. Enhanced mode is best used when you require a very fast speed and don't require a long working range. Default = Manual Triger-Normal.
Presentation Mode	Presentation Mode uses ambient light and scan engine illumination to detect bar codes. When in Presentation Mode, the LEDs remain dim until a bar code is presented to the scan engine, then the aimer turns on and the LEDs turn up to read the code. If the light level in the room is not high enough, Presentation Mode may not work properly.
Streaming Presentation Mode	When in Streaming Presentation mode, the scan engine's aimer goes out after a short time, but the scan illumination remains on all the time to continuously search for bar codes. Two modes are available, <b>Normal</b> and <b>Enhanced</b> . Normal mode offers good scan speed and the longest working ranges (depth of field). Enhanced mode will give you the highest possible scan speed but slightly less range than Normal mode. Enhanced mode is best used when you require a very fast scan speed and don't require a long working range.
Host Notify	Host Notify Mode bypasses the decoder and notifies the host that there has been a

Mode	hardware trigger pull. When in Host Notify Mode, it is up to the host to initiate an Image Snap and/or an Image Ship command. It is also up to the host to switch to another trigger mode.
Snap and Ship Mode	Snap and Ship mode, allows you to bypass the decoder and ship an image directly to the host. In this mode, an image is taken and shipped upon each trigger pull, instead of being sent to the decoder. Snap and Ship is useful when you are using your own decoder.

#### 4.4.6.3 Setting the 1D/2D Barcode Scanner Symbologies

The barcode scanner is shipped with default settings shown below. If the default setting suits the usage requirement, setting symbologies is not necessary.

##### Symbologies Default Settings:

		Symbologies	Default setting
Linear		UPC-A	Enable
		UPC-E	Enable
		EAN/JAN-8	Enable
		EAN/JAN-13	Enable
		UPC-E1	Disable
		UPC-A/EAN-13 Extended Coupon Code	Disable
		GS1 DataBar Omni-Directional	Enable
		GS1 DataBar Limited	Enable
		GS1 DataBar Expanded	Enable
		Code 39	Enable
		Code 128	Enable
		ISBT 128	Disable
		GS1-128	Enable
		Interleaved 2 of 5	Enable
		Matrix 2 of 5	Disable
		NEC 2/5	Enable
		IATA 2/5	Disable
		Code 2/5	Disable
		Codabar	Enable
		Code 93	Enable
		Code 11	Disable
		MSI	Disable
		Telepen	Disable
		Trioptic Code	Disable
		Postal Code	Disable
		Planet Code	Disable
	Korea Post	Disable	
	China Post	Disable	
	Australian Post	Disable	
2D		Data Matrix	Enable
		PDF 417	Enable
		Micro PDF 417	Enable
		Codablock A	Disable
		Codablock F	Disable
		Maxicode	Disable
		QR Code	Enable
		Aztec	Enable
		Composite Code	Disable
		Han Xin	Disable

Changing default setting of symbologies or the advanced setting

There are two methods to change the default setting of symbologies or other advanced setting:



**Method (1).** Click on the Symbologies  on the top, then you can change the symbology to the default setting or make advanced setting by its category. After setting, click on the “Save to Device” on the side bar.

**Method (2).** Click on the reset to default button on the side as shown blow:



### ※Warning※

1. The reset to default button will change all setting to default.
2. N660X could disconnect with system after clicking the reset to default button.

If the Disconnection happened please scan barcodes below in the following steps.

Step 1. Frist please scan the USB HID barcode:

#### **USB HID**

Scan the following code to program the scan engine for USB HID.



TERMID131.

USB HID

Step 2. Then please scan the USB Keyboard barcode:

#### **USB PC or Macintosh Keyboard**

Scan one of the following codes to program the scan engine for USB PC Keyboard or USB Macintosh Keyboard. Scanning these codes also adds a CR suffix.



PAP124.

USB Keyboard (PC)

Step 3. Please run **EZConfig-Scanning** again by following **4.4.6.1 Device Configuring and Setting**

#### **1. Adding a Prefix or Suffix**

1. To add a Prefix or Suffix please click on “Data Formatting icon”.



**Honeywell N660X Series Area Image Engine**

1.SETTINGS

2.SYMBOLOGIES

3.DATA FORMATTING

4.IMAGING

5.SCAN DATA WINDOW

6.COMPARE

Prefix/Suffix
Data Formatter
Output Sequence Setting

[Quick Help](#) ▲

Prefix/Suffix

Prefix Enable  Off  On *Default: 1*

Suffix Enable  Off  On *Default: 1*

Prefix Command Value

Suffix Command Value

	Delete	Symbology	Prefix	Suffix
<input type="checkbox"/>	↑ ↓	All Symbologies	<input type="text"/>	[ CR] <input type="text"/>
<input type="checkbox"/>	↑ ↓	Australian Post	<input type="text"/>	<input type="text"/>

2. Click on Editor button under the Prefix or Suffix section and create Prefix/Suffix value by typing in the block or select desired characters in the Control chars, Printable chars, and Extended ASCII as shown below:

	Delete	Symbology	Prefix	Suffix
<input type="checkbox"/>	↑ ↓	All Symbologies	<input type="text"/>	[ CR] <input type="text"/>

**Prefix Value**

Please select from **Character Set** option below.

▲ Insert ASCII

**Control Chars**

Printable Chars

Extended ASCII

Hex	0	1	2	3	4	5	6	7	8	9	A	B	C	D	E	F
0	NUL 00	SOH 01	STX 02	ETX 03	EOT 04	ENQ 05	ACK 06	BEL 07	BS 08	HT 09	LF 10	VT 11	FF 12	CR 13	SO 14	SI 15
1	DLE 16	DC1 17	DC2 18	DC3 19	DC4 20	NAK 21	SYN 22	ETB 23	CAN 24	EM 25	SUB 26	ESC 27	FS 28	GS 29	RS 30	US 31

▼ Insert Keypress

- When you finish creating Prefix/Suffix, please click on **“Save to Device”** on the side bar.



- For checking the functionality of Prefix/Suffix, please click on **“Scan Data Window”** icon on the top. Then scan a barcode to verify if the Prefix/Suffix appear correctly.

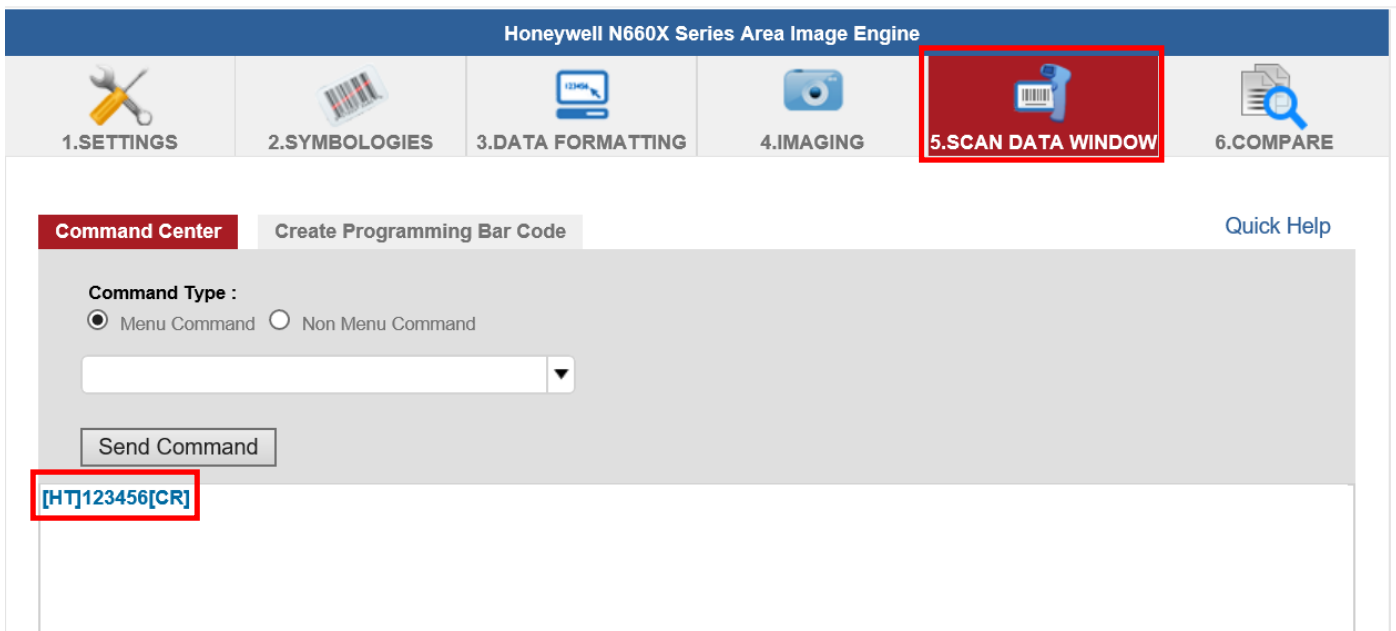

#### 4.4.7 Using the HF RFID Reader

The HF RFID Reader is optional for M101S Tablet PC and is not re-workable by the end user. To use this feature, please make sure the tablet PC is built-in HF RFID reader before use, or contact our sales contact window for more details.

To enable the HF RFID Reader feature:

1. Open the Hottab utility by press the  (Menu) Button located on the front panel, OR launching the Hottab Utility application.
2. Tap on the **Device ON/OFF** button.
3. Tap on **RFID**, and the setting utility will show up as below:

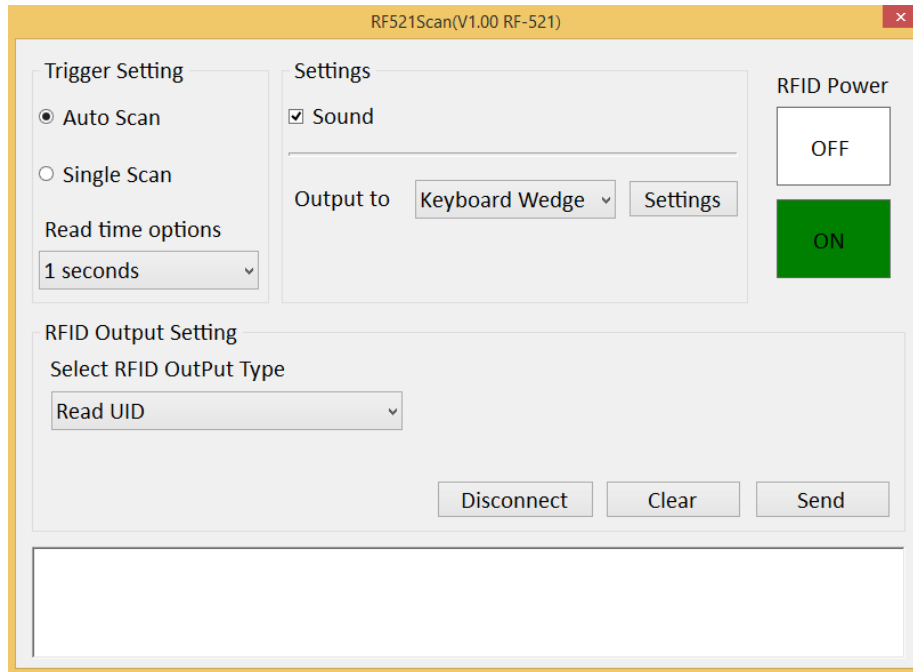

4. Tap on the **ON** button.
5. Check the status color of the ON icon is green, and the status color of the RFID icon on the Hottab menu is orange at the same time.

Item	Status Color	Description
	Orange	HF RFID Reader is enabled.
	White	HF RFID Reader is disabled.

## 4.4.7.1 RFID Trigger Setting

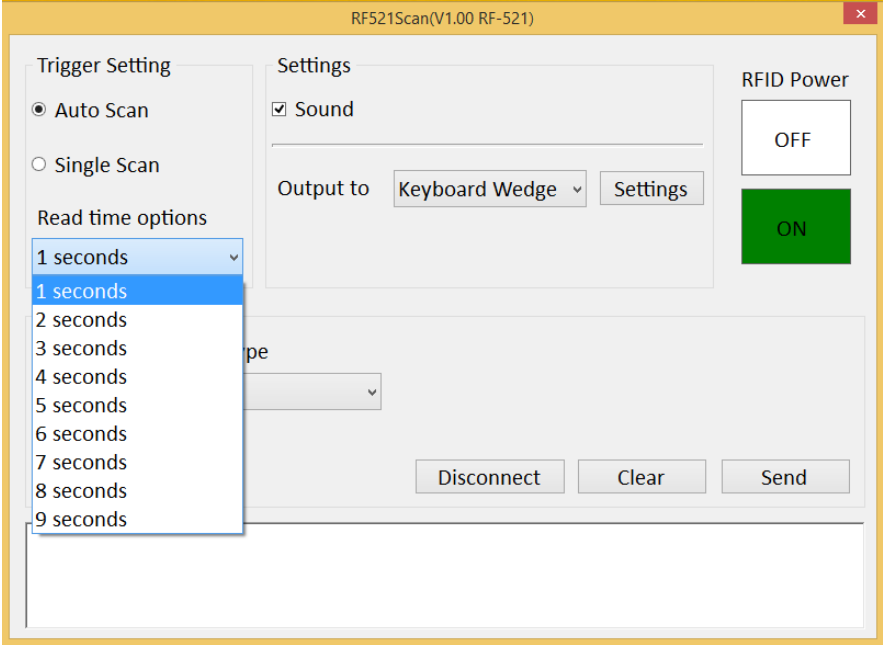
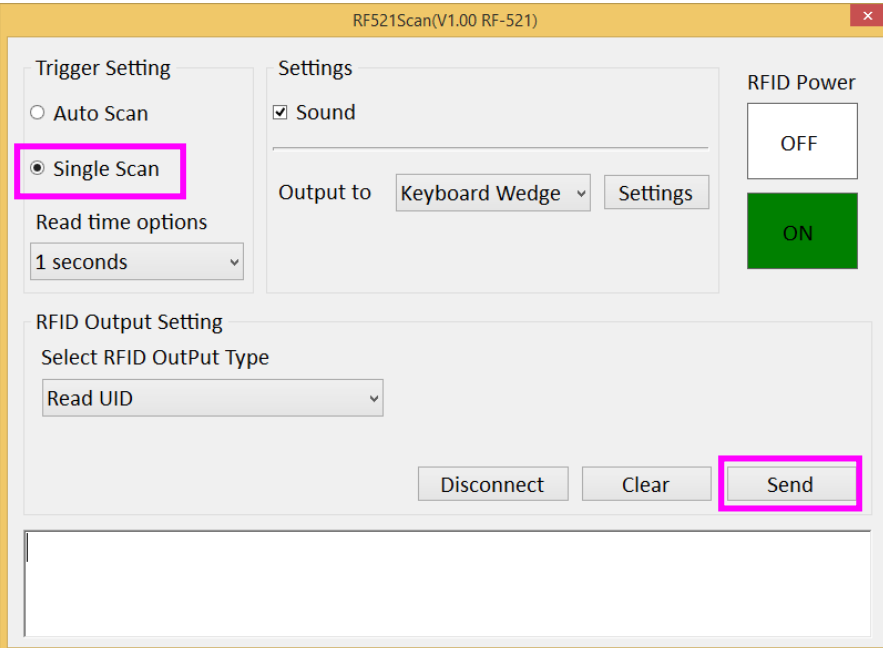
Item	Description
Auto Scan	<p>The default setting for RFID trigger is Auto Scan. Under this setting, the RFID Reader will always be ready to scan tags.</p> <ol style="list-style-type: none"> <li>When the RFID tag is detected from RFID antenna, the data will be read automatically.</li> <li>User can define the RFID scanning frequency from the drop-down menu shown as below. The frequency can be from 1 second to 9 seconds.</li> </ol> 
Single Scan	<p>User can also define the RFID Reader scanning as <b>Single Scan</b>. Under this setting, the RFID Reader will be triggered only when user click on “Send”.</p> 

### 4.4.7.2 Settings

Item	Description
Sound	The <b>Sound</b> check box defines whether a beep sound will come with the data scanning.

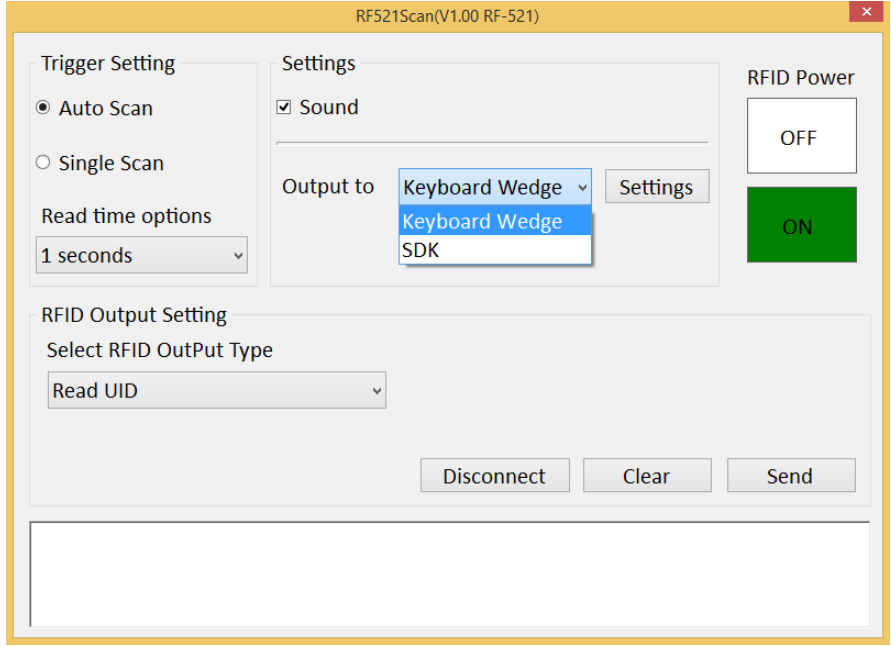
Output to	<p>This setting defines the output type of the scanned data. Two options are available:</p> 
-----------	---

#### Keyboard Wedge

Under this setting, the data scanned is sent like keyboard data. The scanned data can be output directly to the demo area below this window, or user can also open other utility, such as Office Word or Notepad files, for data input.

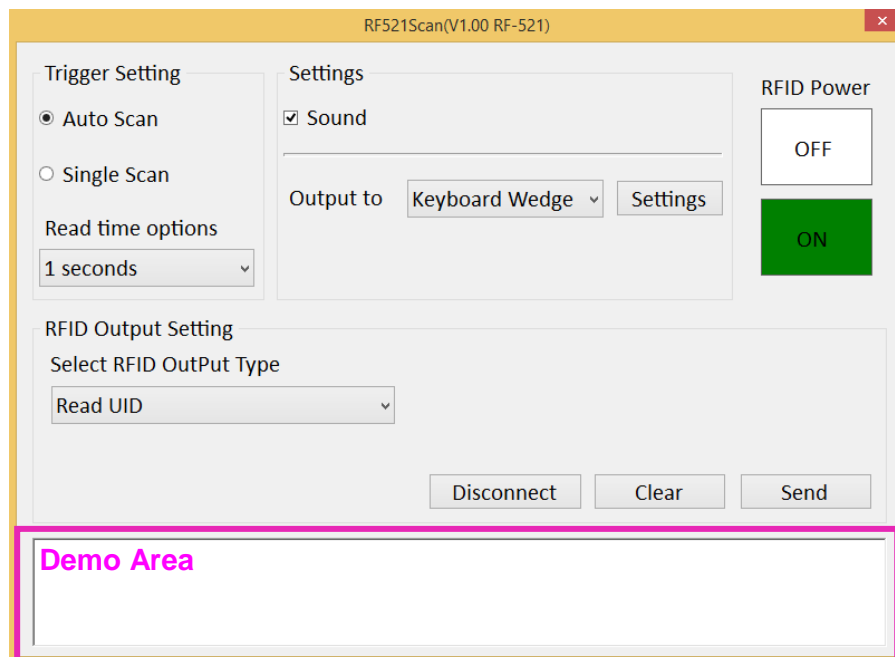

**Note:** notice that the input method should support the scanned character. User can also tap on the **Settings** button for further details settings.

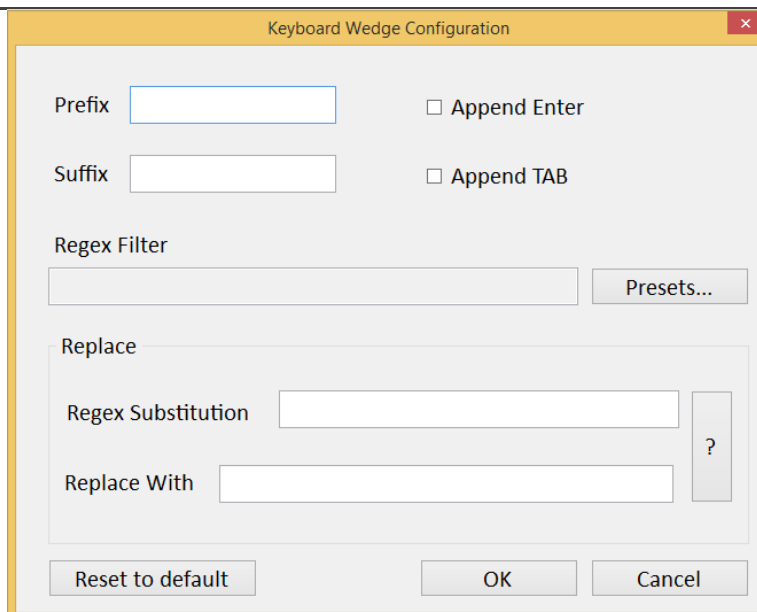

Item	Description
Prefix	User can type in this field to define the characters BEFORE the data scanned.
Suffix	User can type in this field to define the characters AFTER the data scanned.
Append Enter	The check box user can defines to append an “Enter” which is followed by the characters.
Append TAB	The check box user can defines to append an “TAB” which is followed by the characters.
Regex Filter	Press on “Presets...” button, user can define how many characters to show after the data scanned.
Replace	User can define specific characters to be replaced with preferred characters automatically. When the characters defined in <b>Regex Substitution</b> is scanned, the data will be replaced with the one filled in <b>Replace with</b> .
Reset to default	User can remove all the set up and back to default mode.

**SDK**

For users following SDK for software porting, the scanned data can also be output with the format needed.

**NOTE:**

User can download the SDK from Winmate Download center website >> M101S >> Development Kit or check the Driver CD which is shipped with the tablet.

<http://www.winmate.com/DownCenter/DownLoadCenter.asp?DownType=2207&OnlyContent=>

**4.4.7.3 RFID Output Setting**

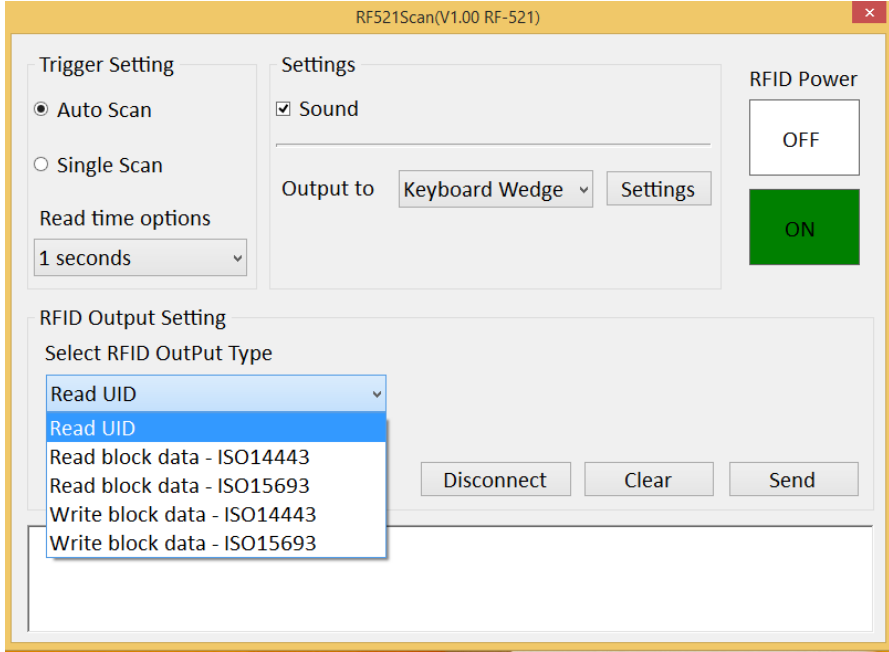
Item	Description
Select RFID Output Type	<p>The default setting for built-in HF RFID Reader is to <b>Read UID</b>. For some applications, user might need to read or write further block data; the drop-down menu under this section can do this change.</p> 
Disconnect	<p>User can tap on the <b>Disconnect</b> button to stop the connection with built-in HF RFID reader.</p> <p>*To recover the connection, please turn off the module from setting UI and then turn on the module again.</p>

#### 4.4.8 Turn on/off the GPS External Antenna

The vehicle dock of M101S Tablet PC supports external GPS antenna through standard SMA connector. To work with external GPS antenna, please make sure the tablet PC is well installed to vehicle dock, and the vehicle dock has connected with external GPS antenna.

When working with vehicle dock connecting to external antenna, user can switch GPS antenna from the internal one to the external one from Hottab menu.

To enable/disable the GPS Ext. Antenna:

1. Open the Hottab utility by press the  (Menu) Button located on the front panel, OR launching the Hottab Utility application.
2. Tap on the **Device ON/OFF** button.
3. Check the status color of the **GPS Ext. Antenna** icon:

Item	Status Color	Description
 GPS Ext. Antenna	Orange	GPS Ext. Antenna is enabled, and using external antenna if available
	White	GPS Ext. Antenna is disabled, and using built-in antenna

4. If the GPS Ext. Antenna is disabled (white), tap on the GPS Ext. Antenna icon to enable it (orange).

#### 4.4.9 Turn on/off the Light Sensor

The Light Sensor can be turned on/off from Hottab menu. To enable/disable the Light Sensor, perform the following procedure:



1. Open the Hottab utility by press the  (Menu) Button located on the front panel, OR launching the Hottab Utility application.
2. Tap on the **Device ON/OFF** button.
3. Check the status color of the **Light Sensor** icon:

Item	Status Color	Description
 Light Sensor	Orange	Light Sensor is enabled.
	White	Light Sensor is disabled.







## 4.4.10 Changing Touchscreen Modes

The tablet computer supports three built-in operating modes for different usage scenarios:

Mode	Usage Scenario
 Hand/Rain Mode (Default)	In <i>Hand/Rain</i> mode the touchscreen rejects false inputs from liquid drops. When the liquid is removed, the touchscreen accepts touch inputs from bare fingertips. <i>Supports input by:</i> <ul style="list-style-type: none"> <li>• <i>Active stylus with palm rejection</i></li> <li>• <i>Rubber tip passive stylus</i></li> <li>• <i>Bare fingertips</i></li> </ul>
 Stylus Mode	In <i>Stylus</i> mode, the touchscreen supports inputs from the fine-tip passive capacitive stylus (shipped with tablet). <i>Support input by:</i> <ul style="list-style-type: none"> <li>• <i>Fine-tip passive stylus with palm rejection</i></li> <li>• <i>Active stylus with palm rejection</i></li> <li>• <i>Rubber tip passive stylus</i></li> <li>• <i>Bare fingertips</i></li> </ul>
 Glove Mode	In <i>Glove</i> mode, the touchscreen supports inputs while the user is operating the touchscreen with gloves on. <i>Supports input by:</i> <ul style="list-style-type: none"> <li>• <i>Glove</i></li> <li>• <i>Rubber tip passive stylus</i></li> <li>• <i>Bare fingertips</i></li> </ul>

To change touch mode:

- (1) Shortly press Function Key 1 (To define the function key refer to User Manual, Chapter 4).
- (2) Press  (Menu) button on the front to open HotTab, or launch HotTab Utility application. Choose **“Device ON/OFF**, and then click **“Touch Set”** icon.  →  → 

### 4.4.10.1 Switch via Built-in HotTab Utility

To switch touchscreen mode via the HotTab:

1. Open HotTab utility by pressing  (Menu) Button located on the front panel, OR launching HotTab Utility application.
2. Choose **“Device ON/OFF”** and then click on **“Touch Set”** icon



3. The Touch Mode Select utility will be shown as below
4. Under the **“Touch Mode”**, select the desired touch modes by tapping on the radio button.
5. Here's also additional Touch related setting to switch the touchscreen input between mouse mode with cursor, or with multi-touch mode:  
*Mouse Mode:* Single touch point supported, with mouse cursor shown.  
*Multi-touch Mode:* The default setting of the touchscreen supports multi-touch mode (up to 10 points)

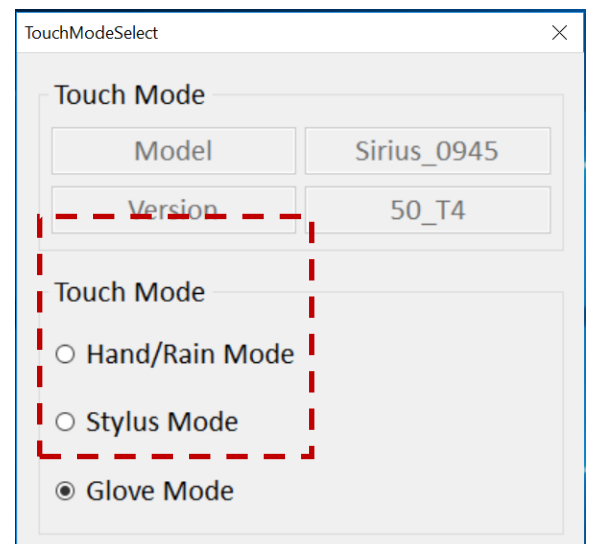

#### 4.4.10.2 Switch via Programmable Function Buttons:

To switch between the different touchscreen modes via the programmable function buttons, make sure the touchscreen mode switching is set to the programmable function buttons first.

1. Open HotTab utility by pressing  (Menu) Button located on the front panel, OR launching HotTab Utility application.
2. Tap on the **Setting** button.
3. Tap on **F1** icon.
4. Tap on the **Long Press** icon.
5. Change the Long Press function to “**Touch Mode**” as shown below:

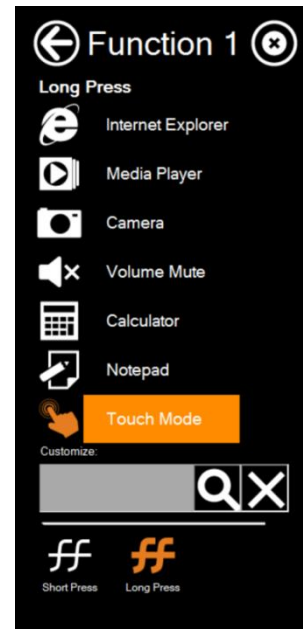

Once the touchscreen mode switching is set to the programmable function button, **Long Press** on “**F1**” function button to cycle through the different touchscreen modes. When touchscreen mode is switched, an icon will temporarily overlay on the lower center of the screen to indicate current touchscreen mode:

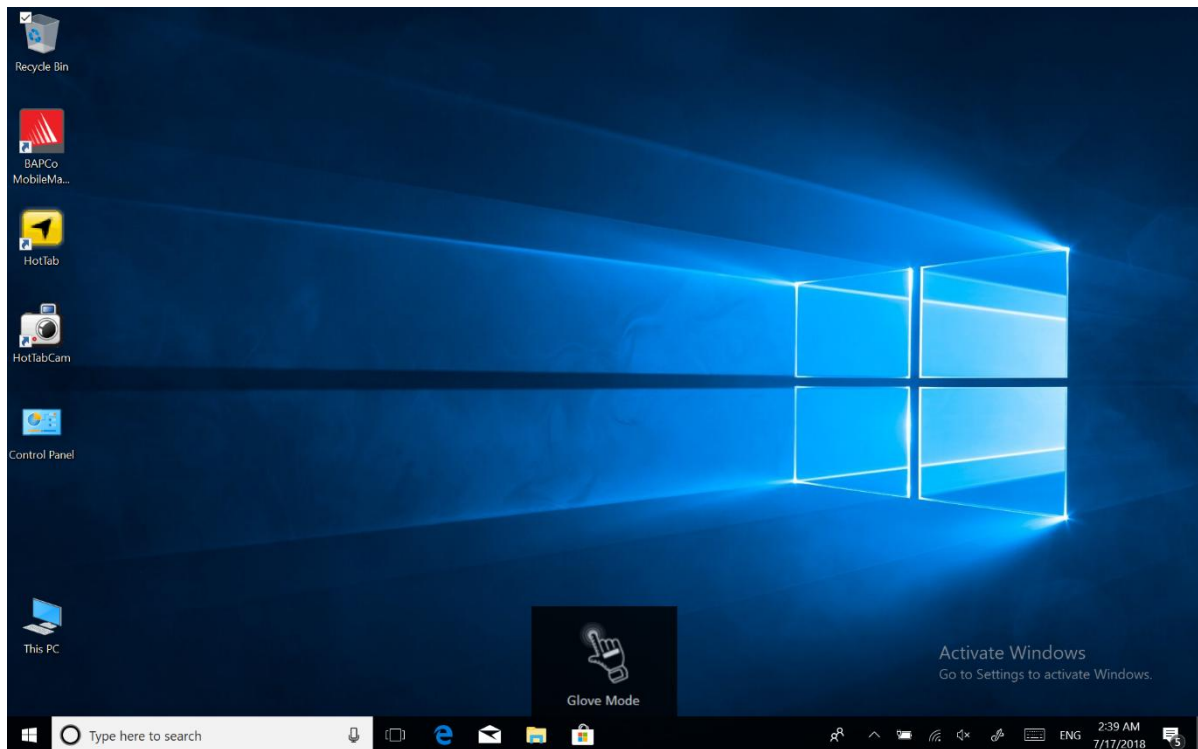

#### 4.4.11 Using the Expansion Module

The Expansion Port is optional for M101S Tablet PC and is not re-workable by the end user. To work with Add-on module, please make sure the tablet PC is built-in expansion port before use, or contact our sales contact window for more details.

The Ext. Module function allows users to choose either UHF RFID Reader or Smart Card Reader.

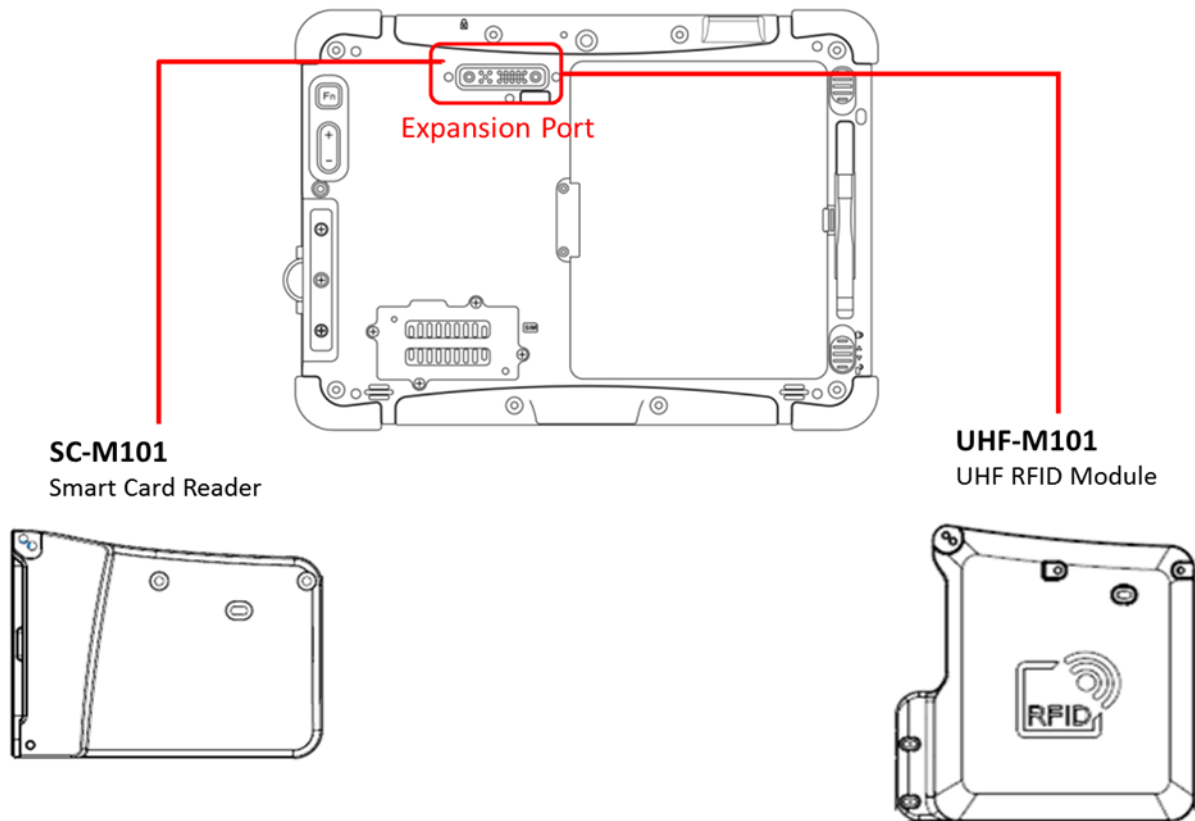

#### Caution

Do not open when the expansion port is not used

To enable the add-on module from expansion port:

1. Open the Hottab utility by press the  (Menu) Button located on the front panel, OR launching the Hottab Utility application.
2. Tap on the **Device ON/OFF** button.
3. Check the status color of the **Ext. Module** icon:

Item	Status Color	Description
	Orange	Expansion Module is enabled.
	White	Ext. Module is disabled.

## 4.4.12 UHF RFID Reader Module

The UHF RFID Reader is optional for M101S Tablet PC.



### Note:

Download the SDK from Winmate Download center [here](#).

>> M101S >> Development Kit or check the Driver CD which is shipped with the tablet.

### 4.4.12.1 How to Install

1. Remove expansion port cover from the rear side of Tablet PC.
2. Remove the top two screws of the I/O cover.
3. Align the pogo pin on UHF RFID module to the expansion port of Tablet PC; screw to fix the module on tablet.

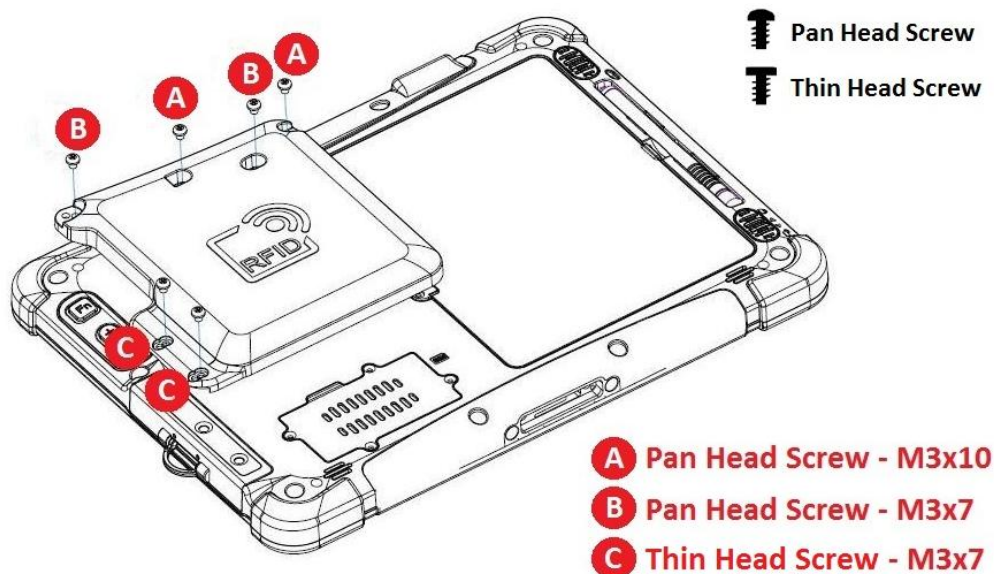

### 4.4.12.2 How to Use

1. Open Hottab utility by pressing (Menu) Button located on the front panel, OR launching Hottab Utility application.
2. Choose “**Device ON/OFF**” and click on “**Ext. Module**”, and the setting utility will show up as below:

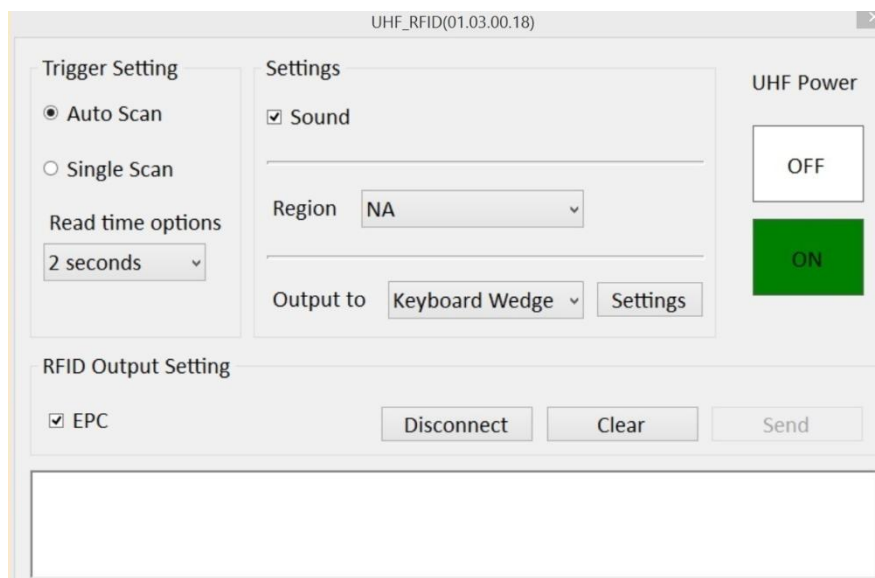

3. Tap on the **ON** button.
4. Check the status color of the ON icon is green.

## Trigger Setting

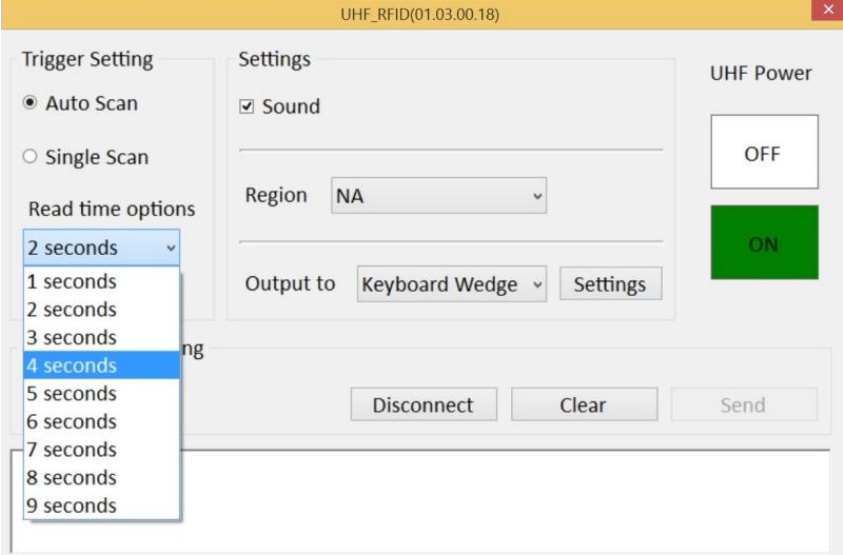
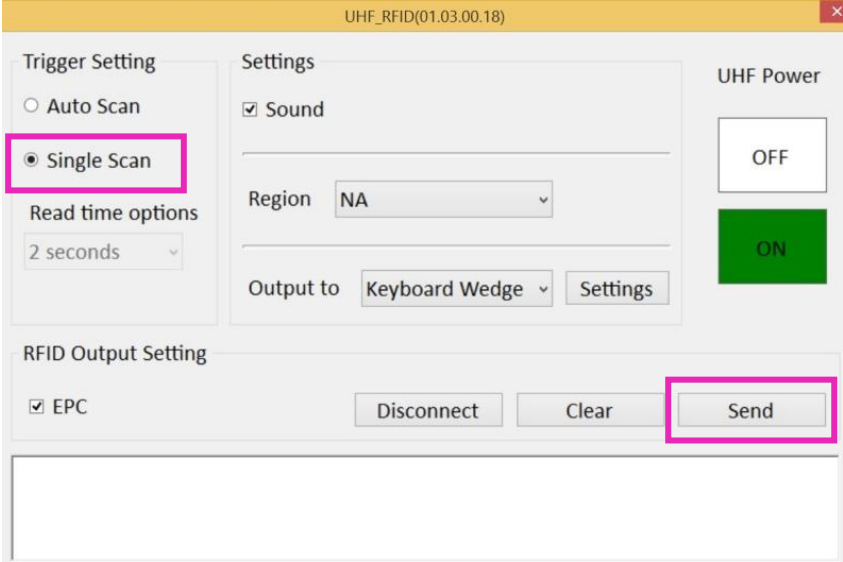
Item	Description
<b>Auto Scan</b>	<p>The default setting for UHF RFID trigger is Auto Scan. Under this setting, the UHF RFID Reader will always be ready to scan tags.</p> <ol style="list-style-type: none"> <li>When the UHF RFID tag is detected, the data will be read automatically.</li> <li>User can define the UHF RFID scanning frequency from the drop-down menu shown as below. The frequency can be from 1 second to 9 seconds.</li> </ol> 
<b>Single Scan</b>	<p>User can also define the UHF RFID Reader scanning as SINGLE SCAN. Under this setting, the UHF RFID Reader will be triggered only when user click on “Send”.</p> 

**Settings**

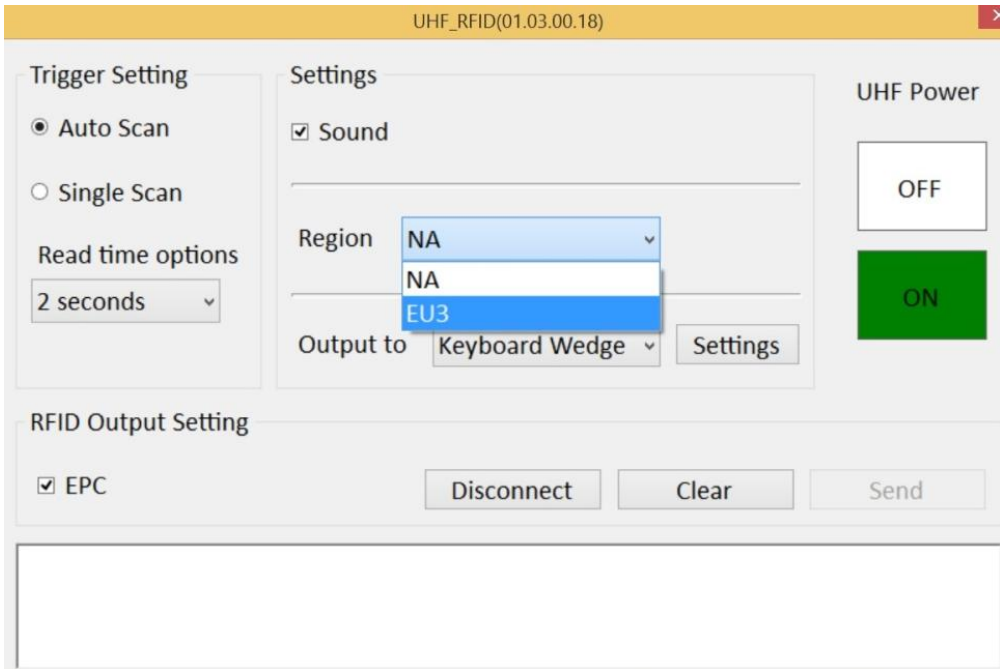
Item	Description
<b>Sound</b>	The <b>Sound</b> check box defines whether a beep sound will come with the data scanning.
<b>Region</b>	<p>Basing on different regional regulations about UHF RFID frequencies, user can switch frequency to NA (North America, 902-928 MHz) or EU3 (Europe, 865-868 MHz) from the drop-down menu shown as below.</p>  <p>The screenshot shows the 'UHF_RFID(01.03.00.18)' settings window. It has several sections: 'Trigger Setting' with radio buttons for 'Auto Scan' (selected) and 'Single Scan', and a 'Read time options' dropdown set to '2 seconds'. The 'Settings' section includes a checked 'Sound' checkbox, a 'Region' dropdown menu currently open showing 'NA' and 'EU3' options, and an 'Output to' dropdown set to 'Keyboard Wedge'. To the right is a 'UHF Power' section with 'OFF' and 'ON' buttons. The 'RFID Output Setting' section has a checked 'EPC' checkbox and 'Disconnect', 'Clear', and 'Send' buttons.</p>
<b>Output to</b>	<p><i>Keyboard Wedge</i>: Under this setting, the data scanned is sent like keyboard data.  <i>SDK</i>: For users following SDK for software porting, the scanned data can also be output with the format needed</p>

**RFID Output To**

This setting defines the output type of the scanned data. Two options are available:

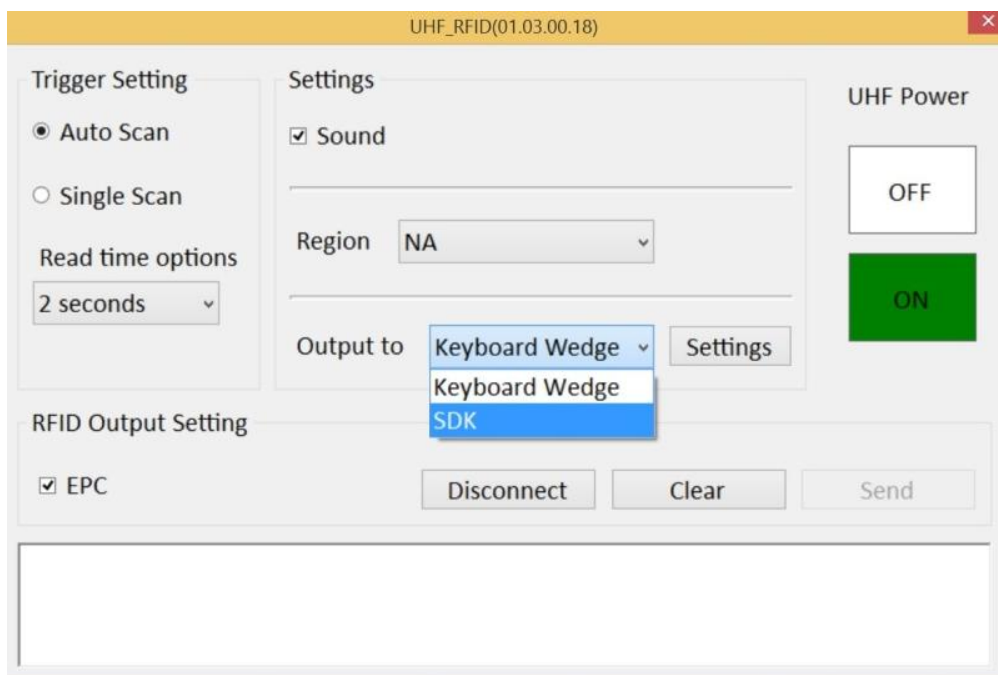

## Keyboard Wedge

Under this setting, the data scanned is sent like keyboard data.

The scanned data can be output directly to the demo area below this window, or user can also open other utility, such as Office Word or Notepad files, for data input.



### Important:

Please notice that the input method should support the scanned character.

Tap **Settings** button for further details settings.

Item	Description
Prefix	Type in this field to define the characters BEFORE the data scanned.
Suffix	Type in this field to define the characters AFTER the data scanned.
Append Enter	To define to append an “Enter” which is followed by the characters.
Append TAB	To define to append an “TAB” which is followed by the characters.
Regex Filter	Press on “Presets...” button, user can define how many characters to show after the data scanned. <div data-bbox="544 1469 1305 2000" data-label="Form"> </div>
Replace	To define specific characters to be replaced with preferred characters automatically. When the characters defined in <b>Regex Substitution</b> is scanned, the data will be replaced with the one filled in <b>Replace with</b> .

Reset to default	To remove all the set up and back to default mode.
------------------	--

## RFID Output Setting



### Note:

- For more information, please download “Universal Reader Assistant” UHF module configuration application from Thing Magic website.

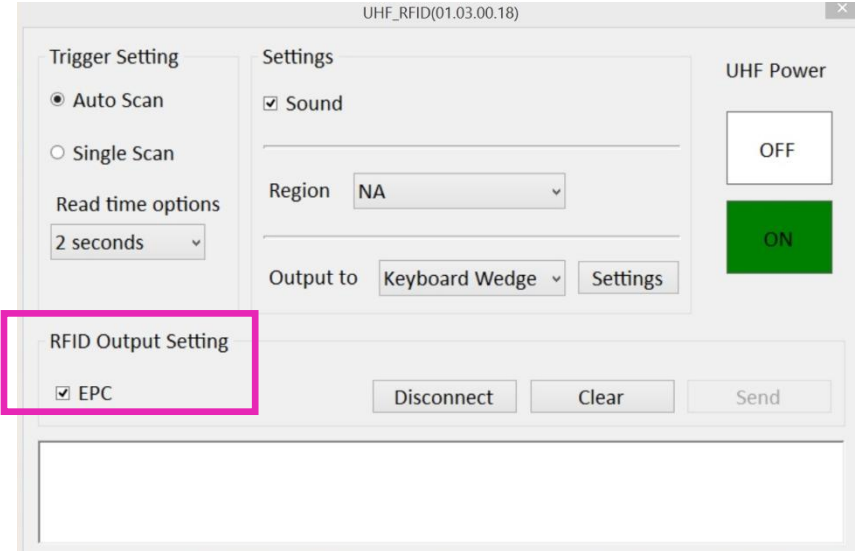
Item	Description
EPC	<p>The EPC check box defines whether to show the complete information of EPC (Electronic Product Code), including</p> <ol style="list-style-type: none"> <li>The identifiers of the object(s) or other entities that are the subject of the event.</li> <li>The date and time when the event took place, and the local time zone in effect.</li> <li>The identifier of the location at which the event occurred.</li> <li>The Information about the business context.</li> </ol> 
Disconnect / Connect	<p>User can tap on the <b>Disconnect</b> button to stop the connection with UHF RFID Reader. *To recover the connection, please turn off the module from setting UI and then turn on the module again.</p>



## 4.4.3 Settings

This Hottab menu option provides users information such as PC Information, Battery status, and also device settings such as power management setting, and function key mappings. Perform the following procedure to access the Hottab Setting menu:

1. Open the Hottab utility by press the  (Menu) Button located on the front panel, OR launching the Hottab Utility application.
2. Tap on the **Settings** button.
3. Below shows the items listed in Settings Menu.

### 4.4.3.1 PC Information

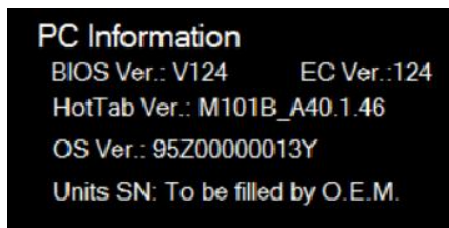

This section provides user device information in regards to BIOS Version, EC Versions, Hottab Versions, OS Versions, as well as Unit Serial Number, shown in the picture sample.

### 4.4.3.2 Battery Information

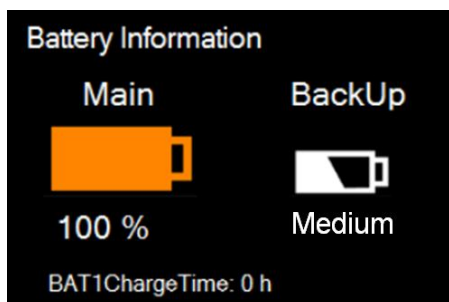

This section provides user battery Information.

#### Main Battery:

The main battery icon displays the battery level in percentages (0 to 100%).

#### Backup Battery: (For M101S)

The backup battery used for battery hot swapping displays its state in text with the following meanings.

Status	Description
<b>High</b>	Backup battery is fully charged, and can be used for hot swapping
<b>Medium</b>	Backup battery level is intermediate, but can be used for hot swapping
<b>Low</b>	Backup battery level is low, and hot swapping is not recommended.

#### Battery Charge Time:

The Battery Information also displays estimated time needed to fully charge the main battery when AC adapter is plugged in. Meanwhile, the backup battery is charged by the main battery.

### 4.4.3.3 Using the Physical Function Keys (Hotkeys)



The function key mapping menu option allows user to change the physical function buttons, Fn1 and Fn2. Users can change what application will be launched with short press or long press of keys.

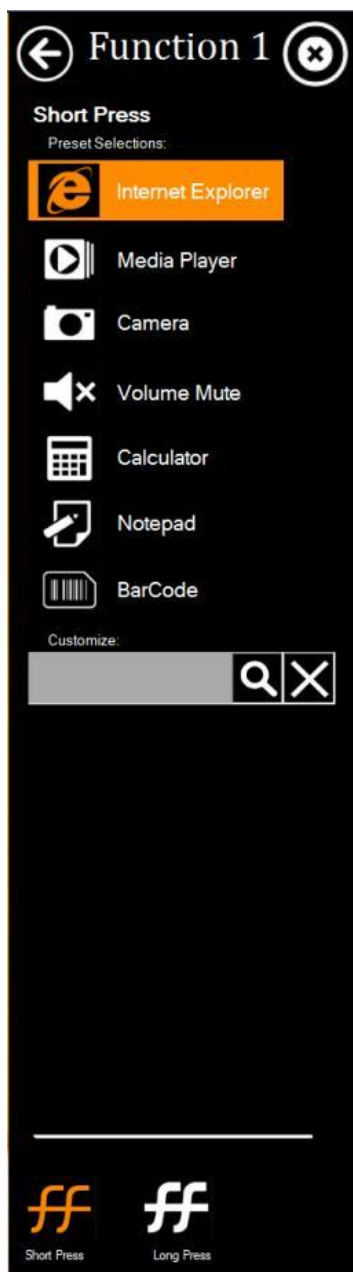



To configure function key mapping, perform the following:

1. Open the Hottab utility by press the  (Menu) Button located on the front panel, OR launching the Hottab Utility application.
2. Tap on the **Setting** button.
3. Tap on function key icon for the corresponding key that you want to change.
4. At top of utility, it will say “Short Press” or “Long Press” to indicate what type of press is being configured
5. You can switch what type of press you want to configure by tapping on the “Short Press” or “Long Press” icon at the bottom of the utility window.
6. Pick from list of preset applications by tapping on the application icons OR customize which application to execute using the picker.

**Using the Custom picker:**

1. Tap the  icon to reveal browser window
2. Navigate to the desired executable to map to function key
3. Tap on “Done” to save selection.

**To map the function key to another application:**

1. Tap on the  icon to remove connection to the original application, and pick again tapping on  icon.

**Using the physical function keys:**

1. While operating the tablet, click on the physical function keys to activate functions mapped via the setup in this section.

## Chapter 5: Frequently Used Settings

### 5.1 Screen Resolution Scaling and Setting

The M101's 1920 x 1200 high resolution display is perfect for viewing image, video, or other applications, however, Windows user interface (icons, buttons, and other user interface elements) may be too small to read and operate at the default Windows settings. By changing the display scaling or the display resolution setting of the device, you can adjust the size of the text and other items on the desktop for optimal viewing. Display scaling is the recommended method because it has the effect of adjusting user interface element without having to move away from the optimal resolution setting at 1920 x 1200. This section will explain how you can adjust the built-in windows display scaling setting and resolution setting.



#### Note:

- The Tablet computer is shipped with display scaling set at **Larger - 150%**. We recommend the users set the scaling to this setting for optimal text and image viewing.
- Before proceeding to change the scaling option, make sure any opened document is saved and close, and all running applications are closed before proceeding to change the display scaling, because this procedure requires users to log out of their account to apply display scaling change.

#### 5.1.1 Changing Display Scaling (Recommended)

Perform the following to change display scaling setting:

1. Tap and hold anywhere on the desktop for 3 seconds and release to bring up the context menu, and select "Display settings" option as shown below:

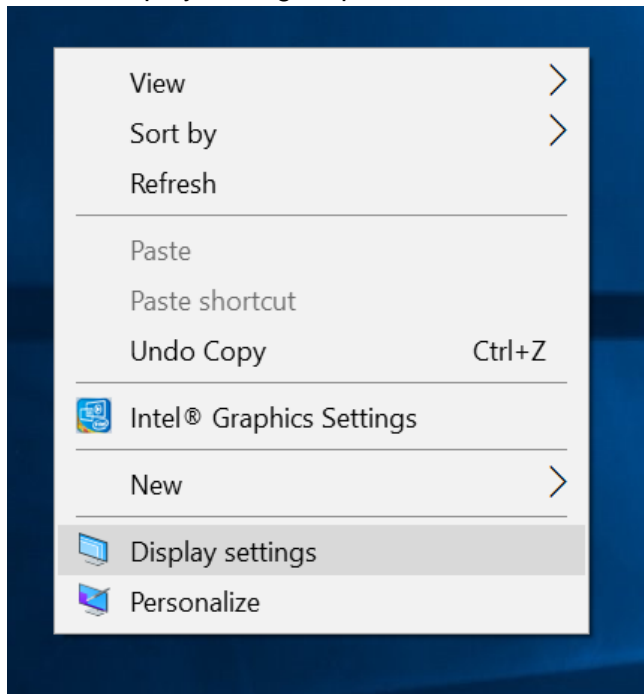

1. A “Display” Window will show up. Click on the dropdown option under the “**Scale and layout**” section and change the scaling option to “**150% (Recommended)**” or any other desired display scaling.

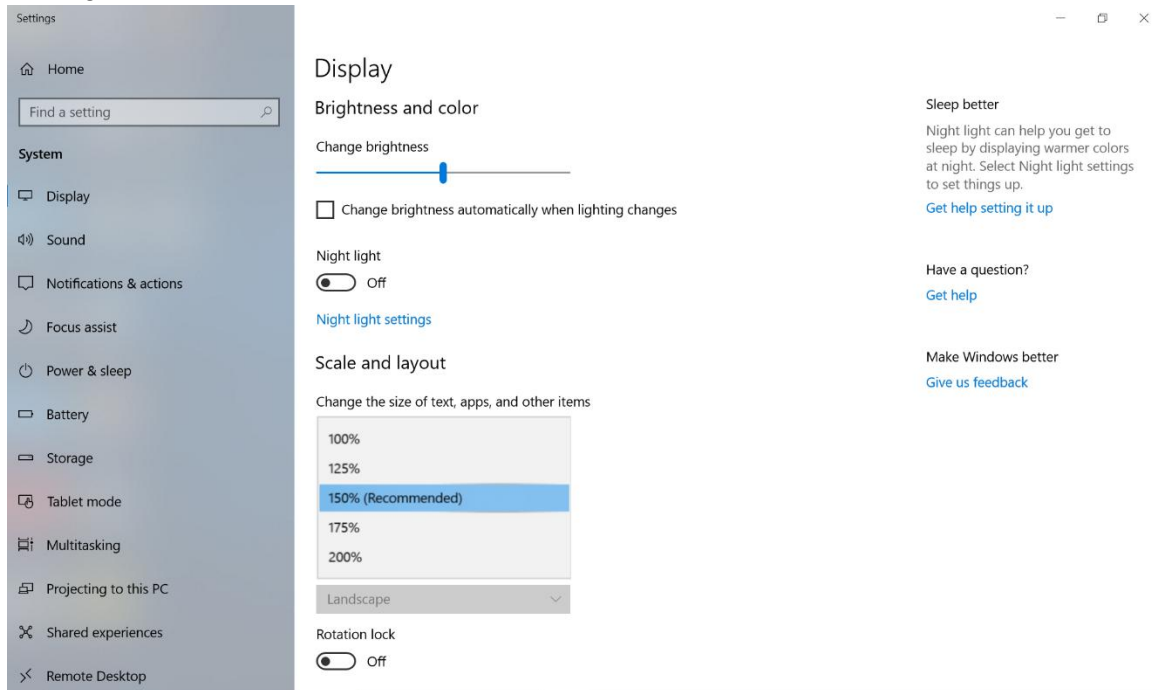

### 5.1.2 Changing Screen Resolution

Alternatively, instead of changing the display scaling setting, user may choose to change the overall resolution setting to make screen elements bigger.

1. Tap and hold anywhere on the desktop for 3 seconds and release to bring up the context menu, and select “**Display settings**” option as shown below:

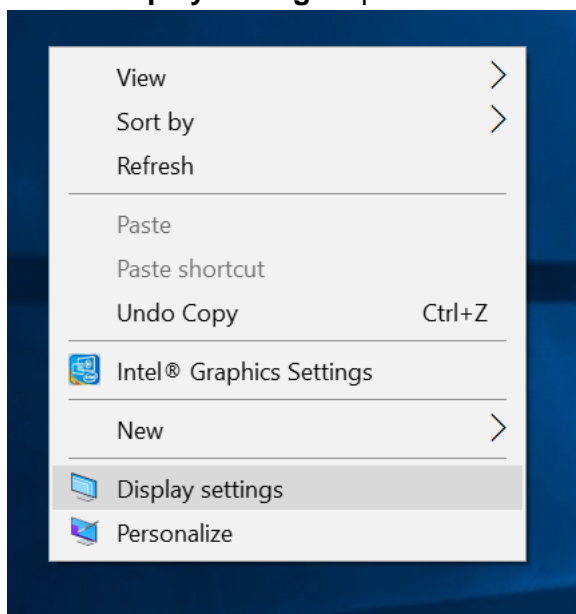

- Click on the dropdown option next to “**Resolution**” and select the desired resolution by tapping on the scale:

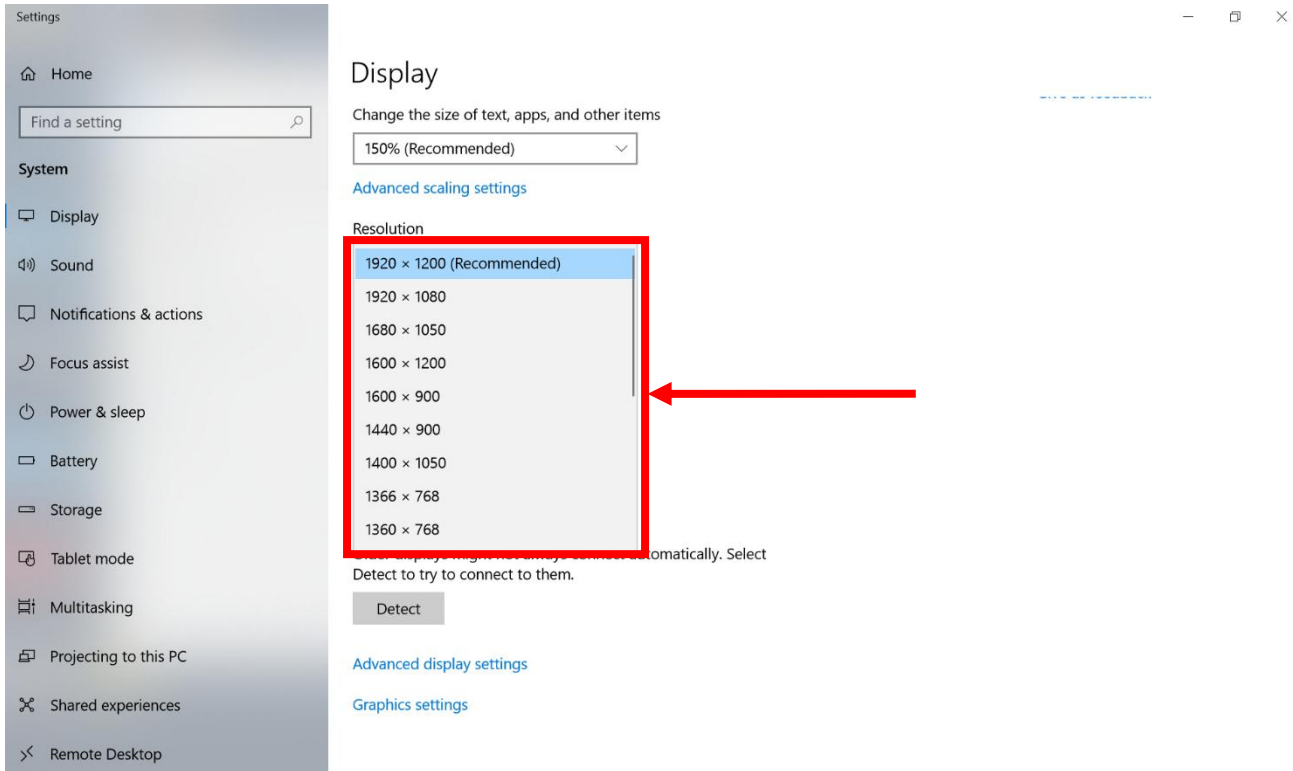

- Hit “**Apply**”. A prompt “**Display Settings**” prompt will show up to ask the user if the applied resolution is usable.
- If the new resolution is the desired display setting hit “**Keep changes**” and continue to next step. If the new resolution is not desirable, hit “**Revert**” and select a different resolution to change to, and start again from step 2.
- The user may now use the device with the new resolution setting.

## 5.2 Replacing Battery

The M101S Tablet supports hot-swap, meaning the tablet doesn't need to be powered off to replace the main battery. To support hotswap, there is a backup battery inside the tablet that is charged together with the main battery. This battery cannot be removed, and requires adequate power for main battery hot swapping. When the backup battery is fully charged, the tablet can sustain up to 5 minutes of runtime for battery hot-swapping.

*Perform the following to hot swap the batteries:*

1. Power on the tablet, open Hottab to check the power level of the Backup battery.
2. If the Backup battery level is "Low", please charge the tablet with AC Power until the Backup battery level is "Medium" or "High", and do not remove the main battery.
3. If the Backup battery level is at "Medium" or "High", you can remove the main battery.
4. Insert a new fully charged battery into the battery compartment.
5. Pen Hottab to check Main battery level. If the battery level is displayed incorrect, check if the new removable battery is inserted properly.
6. If the battery level displayed correct, continue using the tablet.



**Caution:** Charge the built-in back-up battery every two months to keep battery health and prevent possible issues from battery over-discharge.

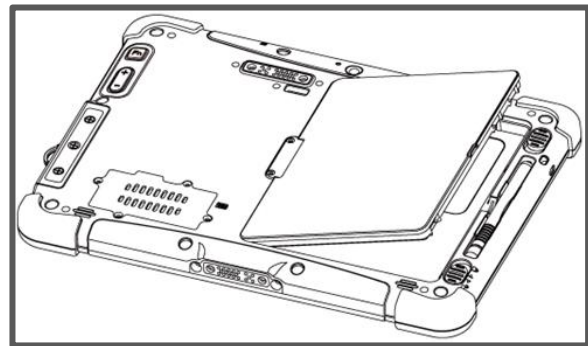
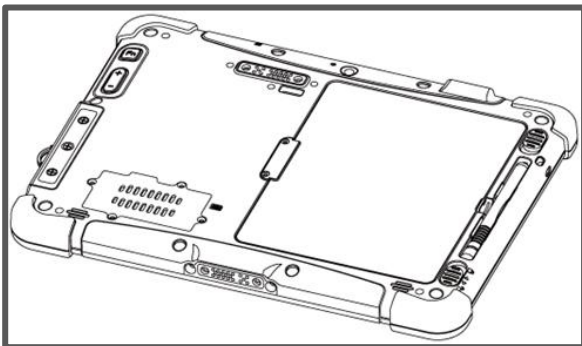

## 5.3 Using Recovery Wizard to Restore Computer

M101S tablet computer has a dedicate recovery partition stored on the hard drive of the tablet to enable quick one-key recovery process. This partition occupies about 11GB of the storage space, and comes built-in to each M101S tablet computer.



### Warning!

Before starting the recovery process, be sure to backup all user data, as all data will be lost after the recovery process.

To enable quick one-key recovery procedure:

1. Plug-in the AC adapter to the tablet computer. Make sure the tablet computer stays plugged in to power source during the recovery process.
2. Power on the tablet computer, and when the boot screen shows up, press the **Fn1** button (Recovery Key) on the front bezel OR press **F6** when using an external USB keyboard to initiate the Recovery Wizard.
3. The following screen shows the Recovery Wizard. Click on "Recovery" button to continue.



4. A warning message about data loss will show up. Make sure data is backed up before recovery, and click on "Yes" to continue.



5. Wait till the recovery process to complete. During the recovery process, a command prompt will show up to indicate the percent of recovery process.

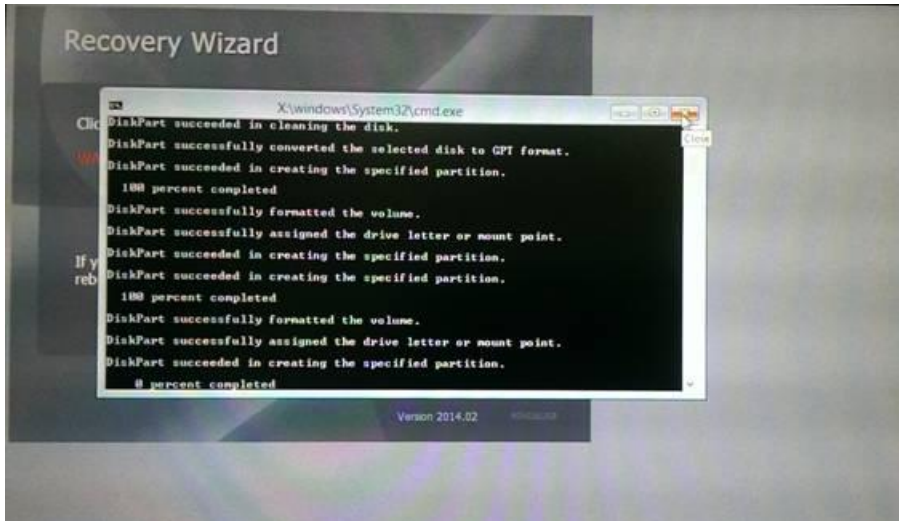

6. After recovery is completed, please press any key to continue, and the tablet computer will Shut down automatically.

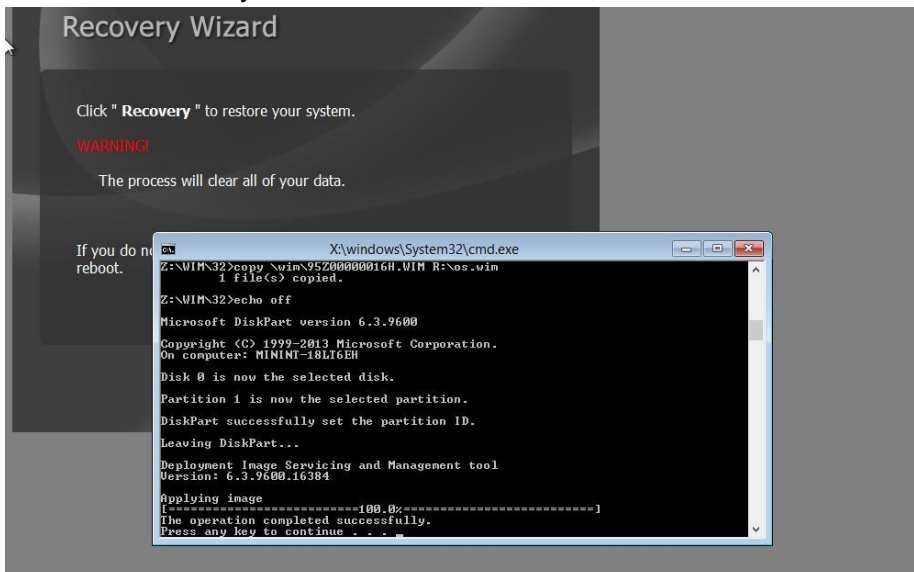



## 5.4 Docking Connector Pin Definition

M101S tablet computer supports one 19-pin docking connector at the bottom side. The pin definition is listed as the following table.

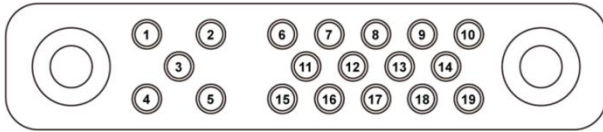

19 Pin Docking Connector			
Pin No.	Description	Pin No.	Description
1	RF_GND	11	NC
2	DOCK_DET#	12	NC
3	GPS ANT	13	GND
4	RF_GND	14	Power
5	RF_GND	15	USB+
6	NC	16	USB-
7	NC	17	GND
8	DETECT+	18	GND
9	Power	19	DETECT-
10	Power		

## 5.5 Expansion Port Pin Definition

M101S tablet computer supports one optional 19-pin expansion port at the rear side. The pin definition is listed as the following table

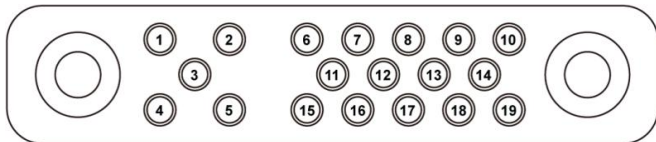

19 Pin Expansion Port			
Pin No.	Description	Pin No.	Description
1	NC	11	RIB#
2	NC	12	RTSB#
3	NC	13	DTRB#
4	NC	14	RXDB
5	NC	15	DM4_R
6	CTSB#	16	DP4_R
7	DSRB#	17	VEXT
8	TXDB	18	GND
9	DCDB#	19	GND
10	GND		



### Caution

Do not open when the expansion port is not used

## 5.6 COM Port Definition

M101S tablet computer uses Hottab utility for built-in peripherals control. All the COM port numbers have been defined in the OS image coming with the package.

COM Port	Device
COM 1	RS232 at I/O
COM 2	RS232 of Expansion Port (optional)
COM 3	HF RFID (optional)
COM 4	Bluetooth Auto Pairing
COM 9	GPS
COM 11	RS232 at Docking (optional)
COM 15	Barcode Reader (optional)
COM 20	UHF RFID (optional)

For some special applications, user might re-install OS and lose the COM port settings. To make sure the features works properly with Hottab utility, please follow the procedure below to re-define the COM port numbers:

1. Go to "Device Manager", right click on the COM number need to be changed, and tap on "Properties" to open the setting page.

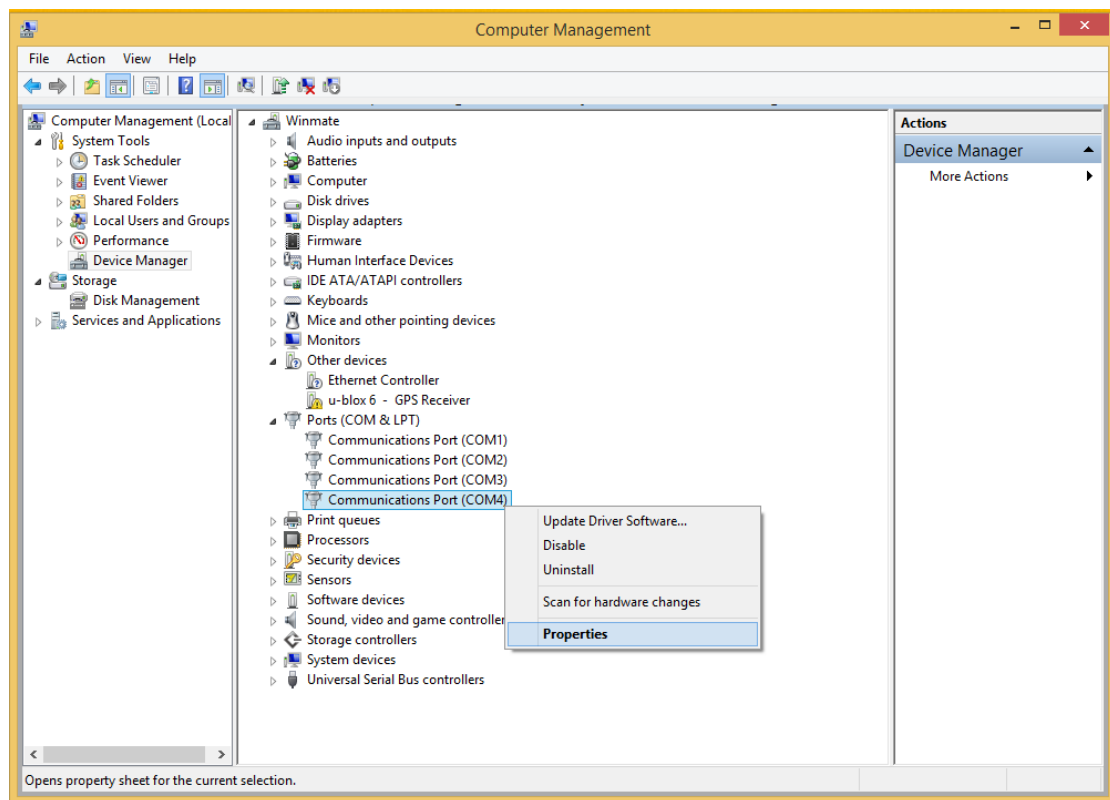

2. Tap on "**Port Setting**" tab and click on "**Advanced**" button.

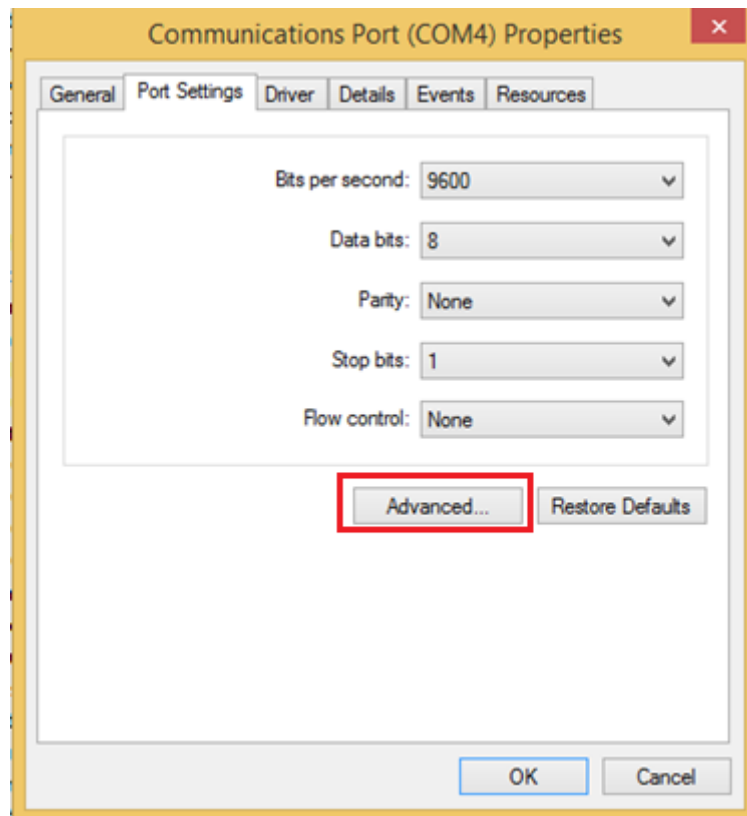

3. Tap on the dropdown list and choose the correct COM Port Number (refer to the COM Port Definition Table), and click "**OK**".

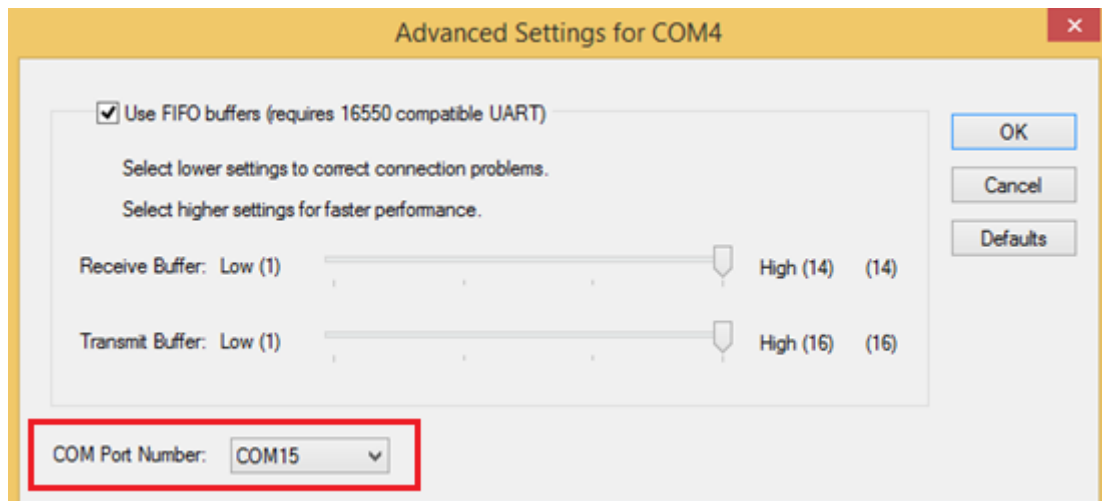

4. Double check "Device Manager" to make sure the COM Port number has been re-defined successfully, and then restart the system.

## 5.7 Pairing with a Wireless Bluetooth Barcode Scanner

The computer is affixed with a Bluetooth MAC (Media Access Control) address barcode label that enables wireless Bluetooth Barcode Scanner to quickly establish Bluetooth connection with the computer. It is encoded with leading characters to instruct the wireless Bluetooth barcode scanner to initial Bluetooth Serial Port Profile pairing request.

### 5.7.1 Setup Computer for Bluetooth Pairing

To start the pairing process, first perform the following steps to ensure the computer is properly setup for pairing:

1. Locate the **Bluetooth** icon in the Notification Area

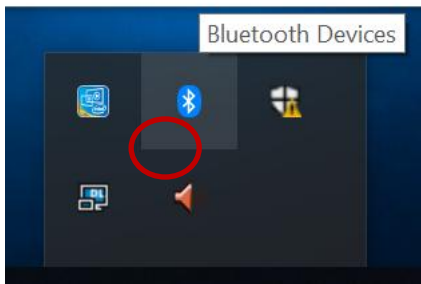

2. Bring up the Contextual Menu by performing long press on the icon with touchscreen or right-click on the icon with a mouse, and select **Open Settings**.

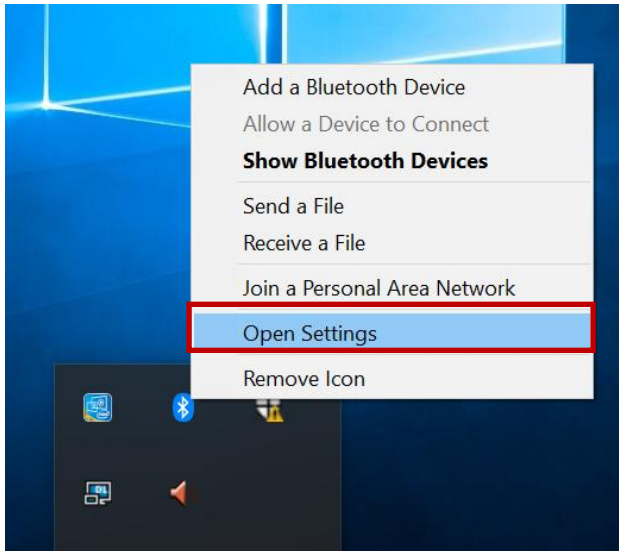

- Once the **Bluetooth & other devices** Menu appears, click **“More Bluetooth options”** under Related settings section as shown below.

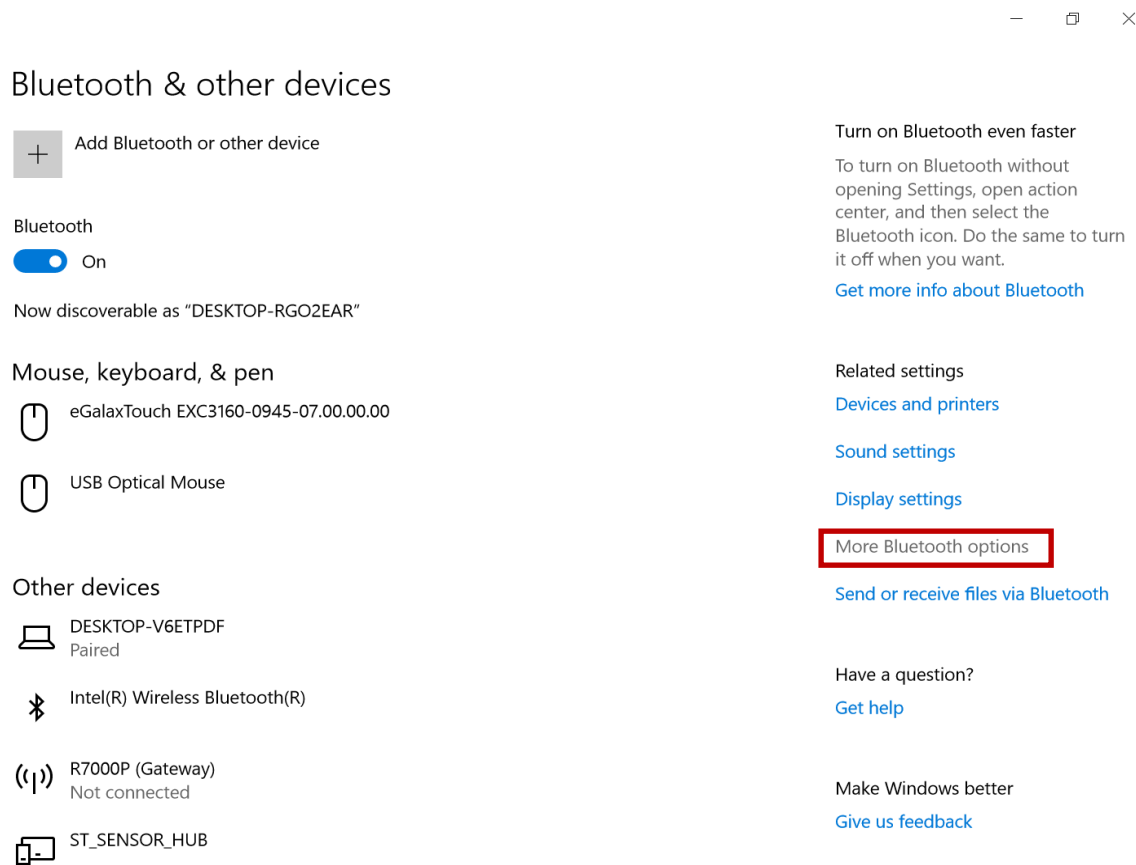

Click **OK** to continue.

- go to **“Options”** tab, and make sure that in the Discovery section, the computer is set to **“Allow Bluetooth devices to find this computer”**, as shown below:

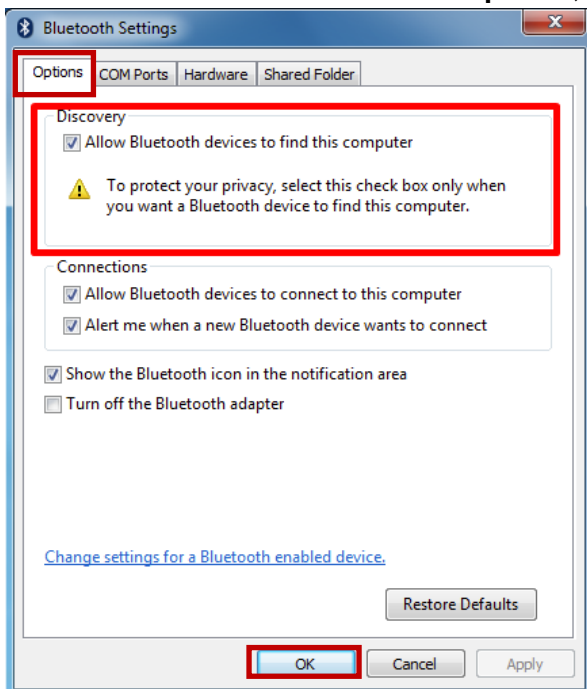

Click **OK** to continue.

- In the **Bluetooth Settings** menu, go to **“COM Ports”** tab. COM port has to be setup for the wireless Bluetooth Barcode Scanner to communicate via the Bluetooth Serial Port Profile. Click on the **“Add...”** button.

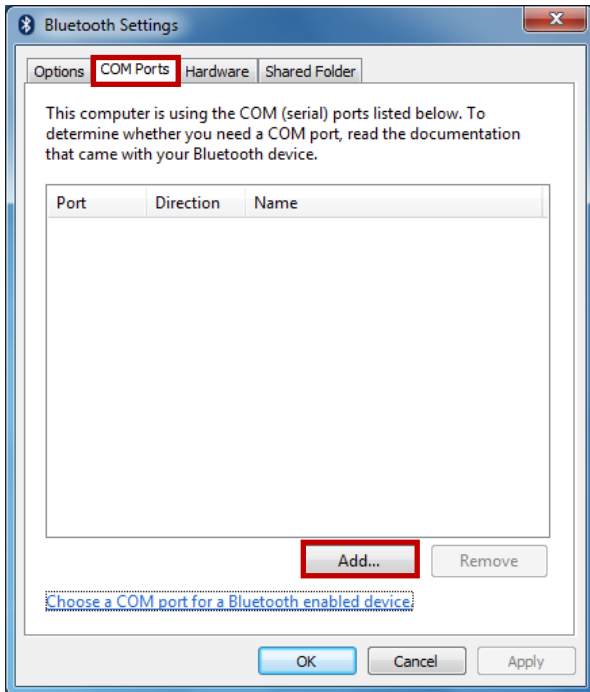

1. You are in “**Add COM Port**” window. Choose “**Incoming (device initiates the connection)**”, and click “**OK**”.

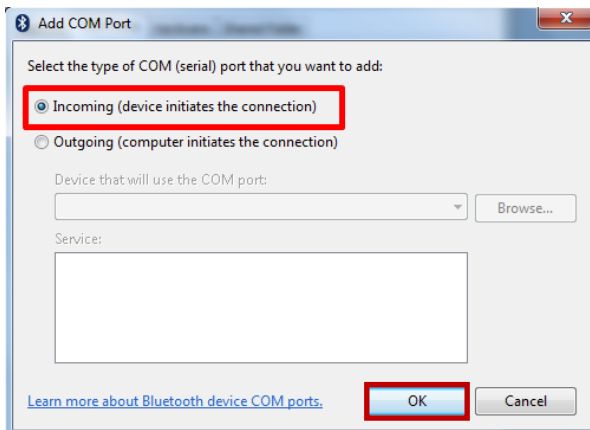

2. The computer will automatically assign COM Port to the Bluetooth connection. In the screenshot below, **COM4** is allocated.

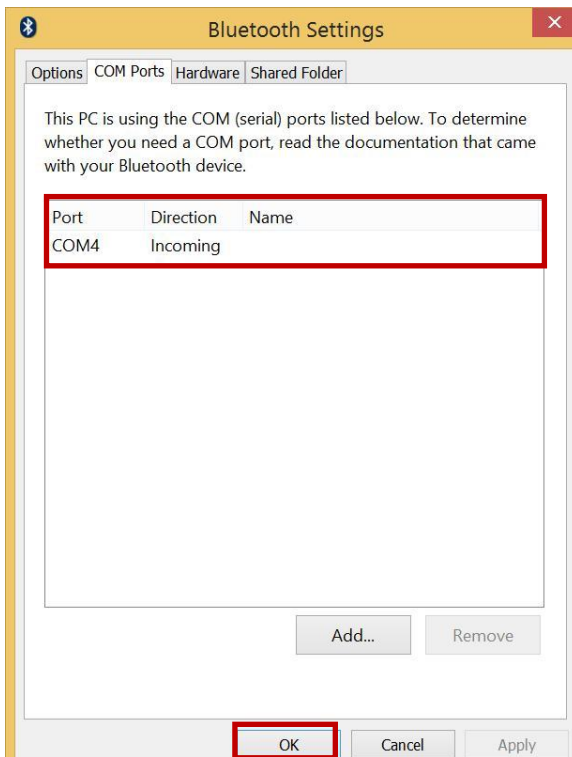

Click **OK** to continue.

- Next, the user has to configure the application that is used to accept the scanned data from the wireless Bluetooth Barcode Scanner. The application has to be configured to accept the same COM Port that has been assigned for the Bluetooth Serial Port Profile in the previous step.



**Important:**

Make sure the application stays open while pairing.

- Now the computer is ready for pairing process to start.

## 5.7.2 Set up the Barcode Scanner for Bluetooth Pairing



### Important

The wireless Bluetooth Barcode Scanner has to be configured as Bluetooth Serial Port Profile Master device to establish connection via Bluetooth MAC address barcode label. For a more detailed instruction, please refer to the User Guide for the wireless Bluetooth Barcode Scanner you are using for pairing.

Now the Barcode Scanner is ready for pairing process to start.

## 5.7.3 Perform Bluetooth Pairing

After you finish setting up both the Computer and Barcode Scanner you are ready to start pairing.

1. Open a program that is used for pairing.
2. Perform scanning procedures. A Bluetooth notification window pop-up on the right hand side of the desktop. **Left click** on the mouse to enter Add a device menu.
3. Locate the **Bluetooth** icon  in the Notification Area.

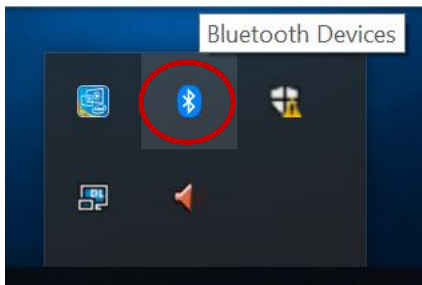

4. Click **Add Bluetooth Device**.

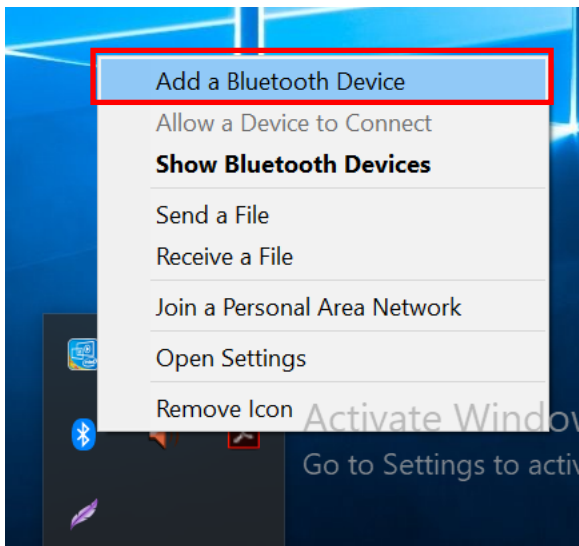

5. In **Add a Bluetooth Device** window, click **Next** to connect the Barcode Scanner to the Computer.



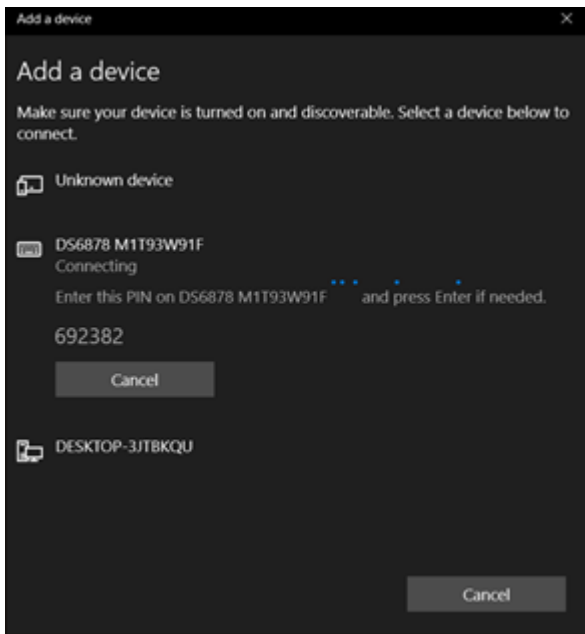

In order to ensure that Bluetooth Device is successfully paired to the Computer, follow the steps below:

1. Locate the **Bluetooth** icon in the Notification Area. Select **Show Bluetooth Devices**.

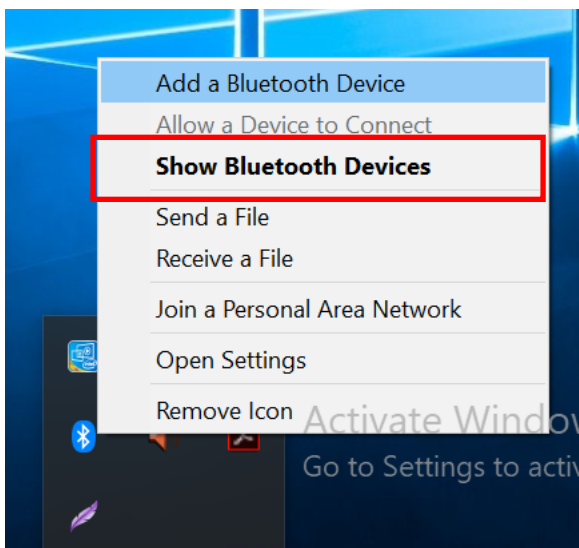

You can access this menu in the Control Panel:

Windows  → Control Panel → Devices and Printers → Bluetooth Devices

2. Make sure your device is connected to the Computer.

## Chapter 6: Troubleshooting

### 6.1 Basic Troubleshooting

Problem	Solution
The removable battery is not charging.	<ul style="list-style-type: none"> <li>Make sure the AC adapter is properly connected, and that the removable battery is properly inserted.</li> </ul>
Nothing appears on the screen.	<ul style="list-style-type: none"> <li>The tablet computer may be in sleep mode. Press the power button to wake up the display.</li> <li>The brightness level may be too low. Increase brightness.</li> </ul>
The screen suddenly turns blank and the power indicator goes off.	<ul style="list-style-type: none"> <li>Make sure that LED indicator is not powered off in Hottab.</li> <li>Make sure the AC adapter is properly connected.</li> <li>If running on battery power, the battery may be depleted, charge the battery.</li> </ul>
Wireless LAN signal quality is poor.	<ul style="list-style-type: none"> <li>The tablet computer may be out of range. Move the tablet computer closer to the access point or another wireless LAN device associated with it.</li> <li>Check if your surroundings have interferences, such as microwave ovens, cordless phones. Move the tablet computer away from objects causing interference.</li> </ul>
I cannot connect to another wireless LAN device.	<ul style="list-style-type: none"> <li>Make sure that wireless LAN feature is powered on.</li> <li>Make sure that the SSID setting is the same for every wireless LAN device in the network.</li> <li>Restart the tablet computer</li> <li>Make sure the IP address or subnet mask setting is correct.</li> </ul>
I cannot connect to another device with Bluetooth.	<ul style="list-style-type: none"> <li>Make sure that both devices have Bluetooth powered on (For the Tablet Computer, check Hottab to see if Bluetooth is powered on).</li> <li>Make sure that the distance between the two devices is within 10 meters and there are no walls or large obstructions between the devices.</li> <li>Make sure the both devices are powered on and configured to be discoverable.</li> <li>Make sure that both devices are compatible.</li> </ul>
The GPS application cannot find my location.	<ul style="list-style-type: none"> <li>Make sure that GPS is powered on in Hottab.</li> <li>Make sure that GPS receiver and the location sensor are enabled in Control Panel.</li> <li>The tablet computer may be out of coverage area. Move your tablet computer outdoors or closer to a window.</li> <li>Check if your surroundings have interferences, such as microwave ovens, cordless phones. Move the tablet computer away from objects causing interference.</li> </ul>
No sound is produced.	<ul style="list-style-type: none"> <li>Adjust volume of the tablet computer by pressing on the volume rocker.</li> <li>If using an external audio device, make sure that the cable is properly connected.</li> </ul>
I cannot project the tablet	<ul style="list-style-type: none"> <li>Make sure the VGA driver is installed.</li> </ul>

<b>computer display to another monitor.</b>	<ul style="list-style-type: none"> <li>• Make sure the output setting selected is correct.</li> </ul>
<b>Barcode scanner does not emit laser beam and does not seem to work.</b>	<ul style="list-style-type: none"> <li>• Make sure the Barcode scanner device is enabled in Hottab utility.</li> <li>• Make sure under Windows, the Barcode Reader is set to COM 15 port, so that Hottab can trigger the Barcode Reader hardware.</li> </ul>
<b>Barcode Scanner emits laser beam but does not read barcode presented to it.</b>	<ul style="list-style-type: none"> <li>• Adjust the distance between barcode scanner of the device and the barcode being scanned.</li> <li>• Make sure the barcode code type is enabled in the tablet. To enable/disable a specific barcode code type, go through the “Barcode Scanner Configuration” section.</li> </ul>
<b>I am having GPS accuracy issue</b>	<ul style="list-style-type: none"> <li>• When utilizing the GPS function, we recommend disabling the Barcode Reader in Hottab to reduce interference.</li> </ul>
<b>RFID scanner does not seem to work.</b>	<ul style="list-style-type: none"> <li>• Make sure under Windows, the RFID hardware is set to COM 3 port.</li> </ul>
<b>Battery leaking or swollen</b>	<ul style="list-style-type: none"> <li>• The lithium battery used in this tablet may swell after being charged/ discharged many times, but there is no problem regarding safety.</li> <li>• Continued use in such a state may result in the battery getting jammed, so please stop using the battery, and purchase a new one.</li> </ul>

## Appendix A: Order Information

M101S Series Tablet PC available for order in the following configurations:

Order Information				
	3G	4G	1D/2D Barcode Reader	HF RFID
M101S	N/A	N/A	N/A	N/A
M101S-HF	Optional	Optional	N/A	Default
M101S-BH	Optional	Optional	Default	N/A
M101S-H2	Optional	Optional	Default	Default
M101S-LA	N/A	4G/LTE for North America	Optional	Optional
M101S-LE	N/A	4G/LTE for Europe	Optional	Optional

# FCC Warning

This device complies with part 15 of the FCC Rules. Operation is subject to the condition that this device does not cause harmful interference..

Any Changes or modifications not expressly approved by the party responsible for compliance could void the user's authority to operate the equipment.

**Note:** This equipment has been tested and found to comply with the limits for a Class B digital device, pursuant to part 15 of the FCC Rules. These limits are designed to provide reasonable protection against harmful interference in a residential installation. This equipment generates uses and can radiate radio frequency energy and, if not installed and used in accordance with the instructions, may cause harmful interference to radio communications. However, there is no guarantee that interference will not occur in a particular installation. If this equipment does cause harmful interference to radio or television reception, which can be determined by turning the equipment off and on, the user is encouraged to try to correct the interference by one or more of the following measures:

- Reorient or relocate the receiving antenna.
- Increase the separation between the equipment and receiver.
- Connect the equipment into an outlet on a circuit different from that to which the receiver is connected.
- Consult the dealer or an experienced radio/TV technician for help.

## **Specific Absorption Rate (SAR) information:**

This Rugged Tablet PC meets the government's requirements for exposure to radio waves. The guidelines are based on standards that were developed by independent scientific organizations through periodic and thorough evaluation of scientific studies. The standards include a substantial safety margin designed to assure the safety of all persons regardless of age or health.

## **FCC RF Exposure Information and Statement**

The SAR limit of USA (FCC) is 1.6 W/kg averaged over one gram of tissue. Device types: Rugged Tablet PC (FCC ID: PX9M101S) has also been tested against this SAR limit. The highest SAR value reported under this standard during product certification when properly worn on the body is 1.578W/kg. This device was tested for typical body-worn operations with the back of the handset kept 0mm from the body. To maintain compliance with FCC RF exposure requirements, use accessories that maintain a 0mm separation distance between the user's body and the back of the handset. The use of belt clips, holsters and similar accessories should not contain metallic components in its assembly. The use of accessories that do not satisfy these requirements may not comply with FCC RF exposure requirements, and should be avoided.

# IC Warning

This device complies with Industry Canada licence-exempt RSS standard(s). Operation is subject to the following two conditions:

- (1) This device may not cause interference, and
- (2) This device must accept any interference, including interference that may cause undesired operation of the device.

## RF Exposure Information and Statement

The SAR limit of USA is 1.6 W/kg averaged over one gram of tissue. Device types: Mobile phone (IC: 9911A-M101S) has also been tested against this SAR limit. The highest SAR value reported under this standard during product certification when properly worn on the body is 1.578W/kg. This device was tested for typical body-worn operations with the back of the handset kept 0mm from the body. To maintain compliance with IC RF exposure requirements, use accessories that maintain a 0mm separation distance between the user's body and the back of the handset. The use of belt clips, holsters and similar accessories should not contain metallic components in its assembly. The use of accessories that do not satisfy these requirements may not comply with IC RF exposure requirements, and should be avoided.

## Body-worn Operation

Le présent appareil est conforme aux CNR d'Industrie Canada applicables aux appareils radio exempts de licence. L'exploitation est autorisée aux deux conditions suivantes:

- (1) l'appareil ne doit pas produire de brouillage, et
- (2) l'utilisateur de l'appareil doit accepter tout brouillage radioélectrique subi, même si le brouillage est susceptible d'en compromettre le fonctionnement

## RF exposition Information et Déclaration

La limite SAR des Etats-Unis est de 1,6 W / kg en moyenne par gramme de tissu. Types d'appareil: Mobile phone (IC: 9911A-M101S) a également été testé contre ces valeurs. La valeur SAR la plus élevée déclarée en vertu de cette norme lors de la certification de produit pour lorsqu'il est correctement porté sur le corps est 1.578W / kg. Ce dispositif a été testé pour les opérations typiques portés sur le corps avec le dos du combiné gardé 0mm du corps. Afin de maintenir la conformité aux exigences de la IC, utilisez des accessoires qui maintiennent une distance de séparation 0mm entre le corps de l'utilisateur et le dos du combiné. L'utilisation de pinces de ceinture, étuis et accessoires similaires ne doivent pas contenir de composants métalliques dans son ensemble. L'utilisation d'accessoires qui ne satisfont pas à ces exigences ne peuvent pas se conformer aux exigences de la IC, et devrait être évitée.

The device has been evaluated to meet general RF exposure requirement. The device can be used in portable exposure condition without restriction