

FCC 47 CFR PART 15 SUBPART C
CERTIFICATION TEST REPORT

For

Wireless Audio Transmitter/Receiver System

MODEL No.: WS-16, WS-16-T, AT2, WT-2

FCC ID: PSRWS-16-T

Trade Mark: Yung, Dayton Audio, Monacor, RSL

REPORT NO.: ES161031018E

ISSUE DATE: December 12, 2016

Prepared for

Yung International Inc

7/F, No.8, Lane 270, Pei Shen Road Sec. 3, Shen Keng Dist., 222, New
Taipei City, Taiwan

Prepared by

EMTEK(SHENZHEN) CO., LTD.

Bldg 69, Majialong Industry Zone, Nanshan District,
Shenzhen, Guangdong, China
TEL: 86-755-26954280
FAX: 86-755-26954282

TABLE OF CONTENTS

1 TEST RESULT CERTIFICATION.....3

2 EUT TECHNICAL DESCRIPTION 4

3 SUMMARY OF TEST RESULT5

4 TEST METHODOLOGY 6

4.1 GENERAL DESCRIPTION OF APPLIED STANDARDS 6

4.2 MEASUREMENT EQUIPMENT USED 6

4.3 DESCRIPTION OF TEST MODES..... 7

5 FACILITIES AND ACCREDITATIONS 8

5.1 FACILITIES 8

5.2 LABORATORY ACCREDITATIONS AND LISTINGS 8

6 TEST SYSTEM UNCERTAINTY 9

7 SETUP OF EQUIPMENT UNDER TEST 10

7.1 RADIO FREQUENCY TEST SETUP 1 10

7.2 RADIO FREQUENCY TEST SETUP 2 10

7.3 CONDUCTED EMISSION TEST SETUP 12

7.4 BLOCK DIAGRAM CONFIGURATION OF TEST SYSTEM 13

7.5 SUPPORT EQUIPMENT 13

8 TEST REQUIREMENTS..... 14

8.1 BANDWIDTH TEST 14

8.2 FREQUENCY STABILITY 17

8.3 RADIATED SPURIOUS EMISSION 18

8.4 CONDUCTED EMISSIONS TEST 32

8.5 ANTENNA APPLICATION 35

1 TEST RESULT CERTIFICATION

Applicant: Yung International Inc
7/F, No.8, Lane 270, Pei Shen Road Sec. 3, Shen Keng Dist., 222, New Taipei City, Taiwan

Manufacturer: Yung International Inc
Tianliao Village, Shizhou Road, Shipai Town, Dongguan City, Guangdong Province, China

EUT Description: Wireless Audio Transmitter/Receiver System

Model Number: WS-16, WS-16-T, AT2, WT-2
(Note: These models are identical in circuitry and electrical, mechanical and physical construction; the only difference is the model number. for trading purpose. We prepare WS-16-T for test.)

File Number: ES161031018E

Date of Test: October 31, 2016 to December 10, 2016

Measurement Procedure Used:

APPLICABLE STANDARDS	
STANDARD	TEST RESULT
FCC 47 CFR Part 2, Subpart J FCC 47 CFR Part 15, Subpart C	PASS

The above equipment was tested by EMTEK(SHENZHEN) CO., LTD. The test data, data evaluation, test procedures, and equipment configurations shown in this report were made in accordance with the procedures given in ANSI C63.10 (2013) and the energy emitted by the sample EUT tested as described in this report is in compliance with the requirements of FCC Rules Part 2 and Part 15.249

The test results of this report relate only to the tested sample identified in this report.

Date of Test : October 31, 2016 to December 10, 2016

Prepared by : 
Rui Zhou /Editor

Reviewer : 
Yaping Shen /Supervisor

Approve & Authorized Signer : 
Lisa Wang/Manager

2 EUT TECHNICAL DESCRIPTION

Characteristics	Description
Product Description:	Wireless Audio Transmitter/Receiver System
Modulation:	GFSK
Operating Frequency Range(s):	2406MHz-2472MHz
Number of Channels:	23 channels
Channel space:	3 MHz
Antenna Type :	PCB Antenna
Antenna Gain :	1.8 dBi
Power supply:	<input checked="" type="checkbox"/> DC supply: DC 5V from Adapter
	<input checked="" type="checkbox"/> Adapter : Model No: XHY050100UCC INPUT: AC 100-240~50/60Hz 0.5A MAX OUTPUT: DC 5V 1.0A

Note: for more details, please refer to the User's manual of the EUT.

3 SUMMARY OF TEST RESULT

FCC Part Clause	Test Parameter	Verdict	Remark
15.207	Conducted Emission	PASS	
15.209	Radiated Emission	PASS	
15.249	Radiated Spurious Emission	PASS	
15.249	Band edge test	PASS	
15.249	20dB Bandwidth	PASS	
15.203	Antenna Requirement	PASS	
NOTE1: N/A (Not Applicable) NOTE2: The report use radiated measurements in the restricted frequency bands. In addition, the radiated test is also performed to ensure the emissions emanating from the device cabinet also comply with the applicable limits.			

RELATED SUBMITTAL(S) / GRANT(S):

This submittal(s) (test report) is intended for FCC ID: PSRWS-16-T filing to comply with Section 15.249 of the FCC Part 15, Subpart C Rules.

4 TEST METHODOLOGY

4.1 GENERAL DESCRIPTION OF APPLIED STANDARDS

According to its specifications, the EUT must comply with the requirements of the following standards:
 FCC 47 CFR Part 2, Subpart J
 FCC 47 CFR Part 15, Subpart C

4.2 MEASUREMENT EQUIPMENT USED

4.2.1 Conducted Emission Test Equipment

EQUIPMENT TYPE	MFR	MODEL NUMBER	SERIAL NUMBER	LAST CAL.
Test Receiver	Rohde & Schwarz	ESCS30	828985/018	05/28/2016
L.I.S.N.	Schwarzbeck	NNLK8129	8129203	05/28/2016
50Ω Coaxial Switch	Anritsu	MP59B	M20531	N/A
Pulse Limiter	Rohde & Schwarz	ESH3-Z2	100006	05/29/2016
Voltage Probe	Rohde & Schwarz	TK9416	N/A	05/29/2016
I.S.N	Rohde & Schwarz	ENY22	1109.9508.02	05/29/2016

4.2.2 Radiated Emission Test Equipment

EQUIPMENT TYPE	MFR	MODEL NUMBER	SERIAL NUMBER	LAST CAL.
EMI Test Receiver	Rohde & Schwarz	ESU	1302.6005.26	05/29/2016
Pre-Amplifier	HP	8447D	2944A07999	05/28/2016
Bilog Antenna	Schwarzbeck	VULB9163	142	05/28/2016
Loop Antenna	ARA	PLA-1030/B	1029	05/29/2016
Horn Antenna	Schwarzbeck	BBHA 9170	BBHA9170399	05/29/2016
Horn Antenna	Schwarzbeck	BBHA 9120	D143	05/28/2016
Cable	Schwarzbeck	AK9513	ACRX1	05/29/2016
Cable	Rosenberger	N/A	FP2RX2	05/29/2016
Cable	Schwarzbeck	AK9513	CRPX1	05/29/2016
Cable	Schwarzbeck	AK9513	CRRX2	05/29/2016

4.2.3 Radio Frequency Test Equipment

EQUIPMENT TYPE	MFR	MODEL NUMBER	SERIAL NUMBER	LAST CAL.
Spectrum Analyzer	Agilent	E4407B	88156318	05/28/2016
Signal Analyzer	Agilent	N9010A	My53470879	05/28/2016
Power meter	Anritsu	ML2495A	0824006	05/28/2016
Power sensor	Anritsu	MA2411B	0738172	05/28/2016

Remark: Each piece of equipment is scheduled for calibration once a year.

4.3 DESCRIPTION OF TEST MODES

The EUT has been tested under its typical operating condition.

The EUT configuration for testing is installed on RF field strength measurement to meet the Commissions requirement and operating in a manner which intends to maximize its emission characteristics in a continuous normal application.

The Transmitter was operated in the normal operating mode. The TX frequency was fixed which was for the purpose of the measurements.

Test of channel included the lowest and middle and highest frequency to perform the test, then record on this report.

Those modulation GFSK were used for all test.

Pre-defined engineering program for regulatory testing used to control the EUT for staying in continuous transmitting and receiving mode is programmed.

Frequency and Channel list:

Channel	Frequency (MHz)	Channel	Frequency (MHz)	Channel	Frequency (MHz)
1	2406	12	2439
2	2409	13	2442	21	2466
3	2412	14	2445	22	2469
...	23	2472

Test Frequency and channel

Lowest Frequency		Middle Frequency		Highest Frequency	
Channel	Frequency (MHz)	Channel	Frequency (MHz)	Channel	Frequency (MHz)
1	2406	12	2439	23	2472

5 FACILITIES AND ACCREDITATIONS

5.1 FACILITIES

All measurement facilities used to collect the measurement data are located at

Bldg 69, Majialong Industry Zone District, Nanshan District, Shenzhen, China

The sites are constructed in conformance with the requirements of ANSI C63.7, ANSI C63.10 and CISPR Publication 22.

5.2 LABORATORY ACCREDITATIONS AND LISTINGS

Site Description

EMC Lab.

: Accredited by CNAS, 2016.10.24

The certificate is valid until 2022.10.28

The Laboratory has been assessed and proved to be in compliance with CNAS-CL01:2006 (identical to ISO/IEC 17025:2005)

The Certificate Registration Number is L2291.

Accredited by TUV Rheinland Shenzhen 2015.4

The Laboratory has been assessed according to the requirements ISO/IEC 17025.

Accredited by FCC, July 13, 2016

The Certificate Registration Number is 406365.

Accredited by Industry Canada, November 24, 2015

The Certificate Registration Number is 4480A-2.

Name of Firm

: EMTEK(SHENZHEN) CO., LTD.

Site Location

: Bldg 69, Majialong Industry Zone,
Nanshan District, Shenzhen, Guangdong, China

6 TEST SYSTEM UNCERTAINTY

The following measurement uncertainty levels have been estimated for tests performed on the apparatus:

Parameter	Uncertainty
Radio Frequency	$\pm 1 \times 10^{-5}$
Maximum Peak Output Power Test	$\pm 1.0\text{dB}$
Conducted Emissions Test	$\pm 2.0\text{dB}$
Radiated Emission Test	$\pm 2.0\text{dB}$
Power Density	$\pm 2.0\text{dB}$
Occupied Bandwidth Test	$\pm 1.0\text{dB}$
Band Edge Test	$\pm 3\text{dB}$
All emission, radiated	$\pm 3\text{dB}$
Antenna Port Emission	$\pm 3\text{dB}$
Temperature	$\pm 0.5^\circ\text{C}$
Humidity	$\pm 3\%$

Measurement Uncertainty for a level of Confidence of 95%

7 SETUP OF EQUIPMENT UNDER TEST

7.1 RADIO FREQUENCY TEST SETUP 1

The WLAN component's antenna ports(s) of the EUT are connected to the measurement instrument per an appropriate attenuator. The EUT is controlled by PC/software to emit the specified signals for the purpose of measurements.

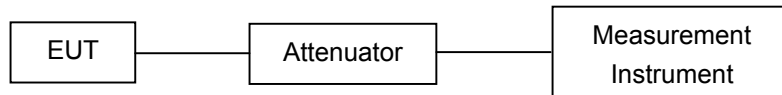

7.2 RADIO FREQUENCY TEST SETUP 2

The test site semi-anechoic chamber has met the requirement of NSA tolerance 4 dB according to the standards: ANSI C63.10. The test distance is 3m. The setup is according to the requirements in Section 13.1.4.1 of ANSI C63.10-2013 and CAN/CSA-CEI/IEC CISPR 22.

Below 30MHz:

The EUT is placed on a turntable 0.8 meters above the ground in the chamber, 3 meter away from the antenna (loop antenna). The Antenna should be positioned with its plane vertical at the specified distance from the EUT and rotated about its vertical axis for maximum response at each azimuth about the EUT. The center of the loop shall be 1 m above the ground. For certain applications, the loop antenna plane may also need to be positioned horizontally at the specified distance from the EUT.

Above 30MHz:

The EUT is placed on a turntable 0.8 meters above the ground in the chamber, 3 meter away from the antenna. The maximal emission value is acquired by adjusting the antenna height, polarisation and turntable azimuth. Normally, the height range of antenna is 1 m to 4 m, the azimuth range of turntable is 0° to 360°, and the receive antenna has two polarizations Vertical (V) and Horizontal (H).

Above 1GHz:

(Note: the FCC's permission to use 1.5m as an alternative per TCBC Conf call of Dec. 2, 2014.)

The EUT is placed on a turntable 1.5 meters above the ground in the chamber, 3 meter away from the antenna. The maximal emission value is acquired by adjusting the antenna height, polarisation and turntable azimuth. Normally, the height range of antenna is 1 m to 4 m, the azimuth range of turntable is 0° to 360°, and the receive antenna has two polarizations Vertical (V) and Horizontal (H).

(a) Radiated Emission Test Set-Up, Frequency Below 30MHz

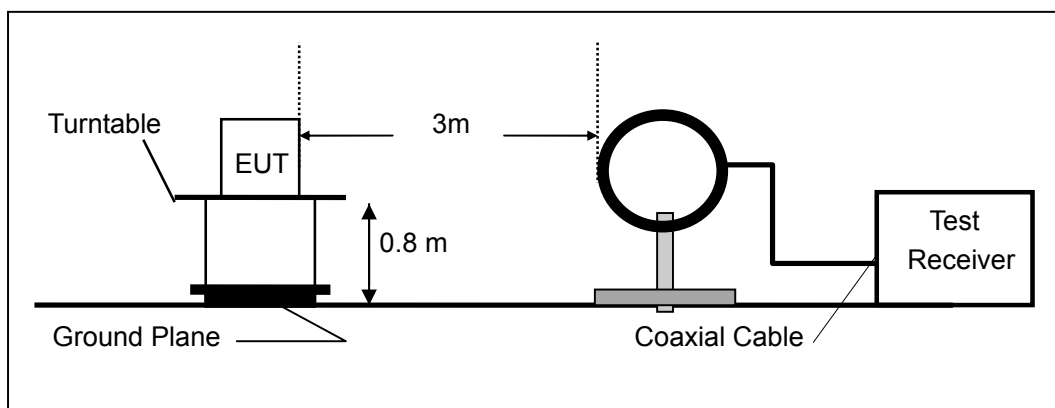

(b) Radiated Emission Test Set-Up, Frequency Below 1000MHz

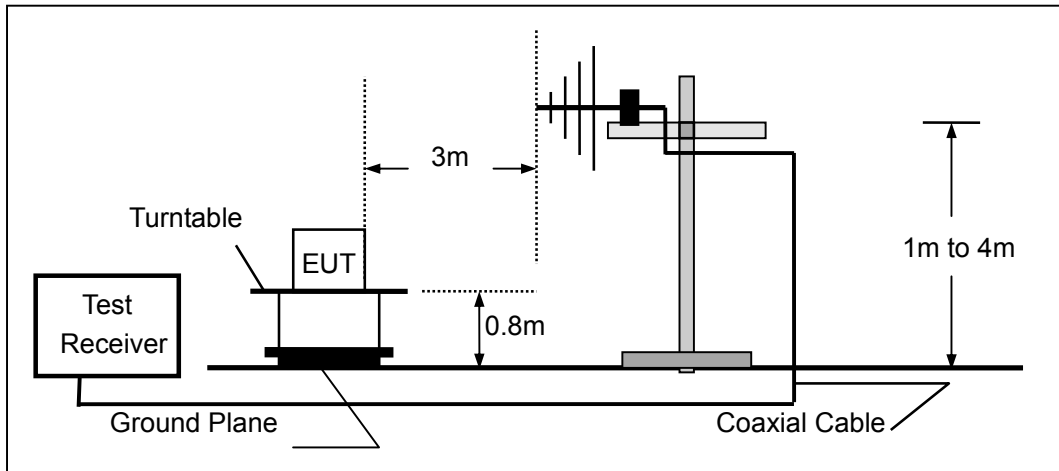

(c) Radiated Emission Test Set-Up, Frequency above 1000MHz

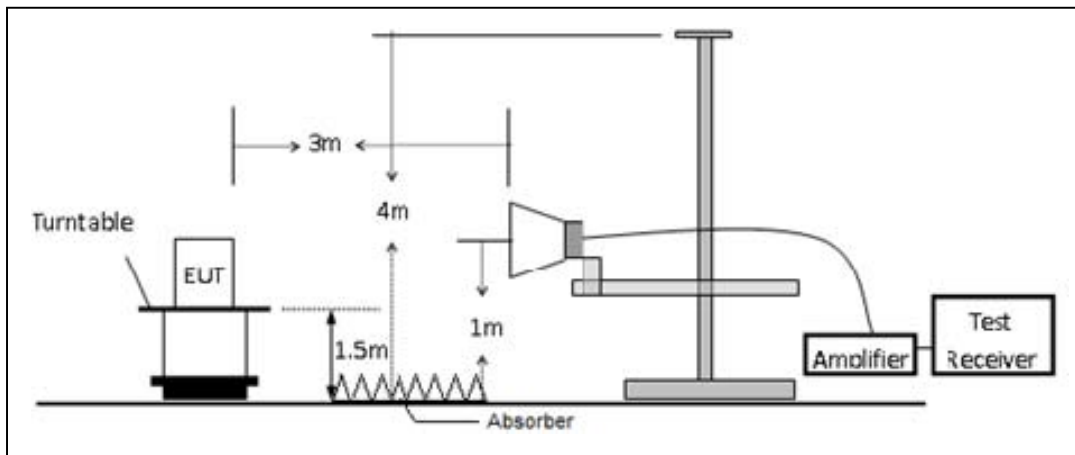

7.3 CONDUCTED EMISSION TEST SETUP

The mains cable of the EUT (maybe per AC/DC Adapter) must be connected to LISN. The LISN shall be placed 0.8 m from the boundary of EUT and bonded to a ground reference plane for LISN mounted on top of the ground reference plane. This distance is between the closest points of the LISN and the EUT. All other units of the EUT and associated equipment shall be at least 0.8m from the LISN.

Ground connections, where required for safety purposes, shall be connected to the reference ground point of the LISN and, where not otherwise provided or specified by the manufacturer, shall be of same length as the mains cable and run parallel to the mains connection at a separation distance of not more than 0.8 m.

According to the requirements in Section 13.1.4.1 of ANSI C63.10-2013 Conducted emissions from the EUT measured in the frequency range between 0.15 MHz and 30 MHz using CISPR Quasi-Peak and average detector mode.

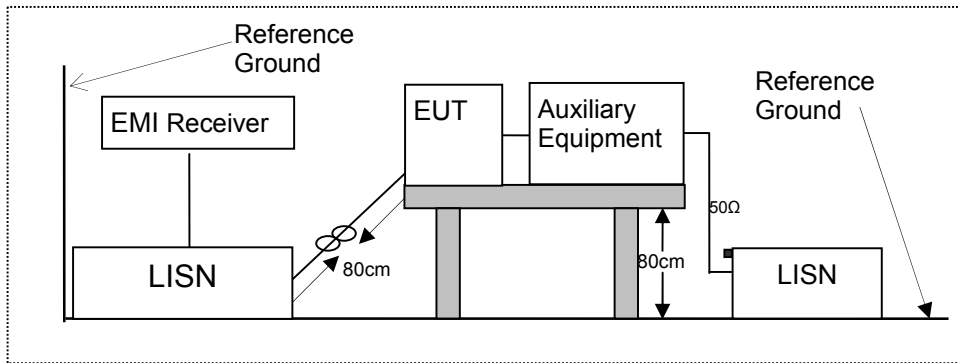

7.4 BLOCK DIAGRAM CONFIGURATION OF TEST SYSTEM

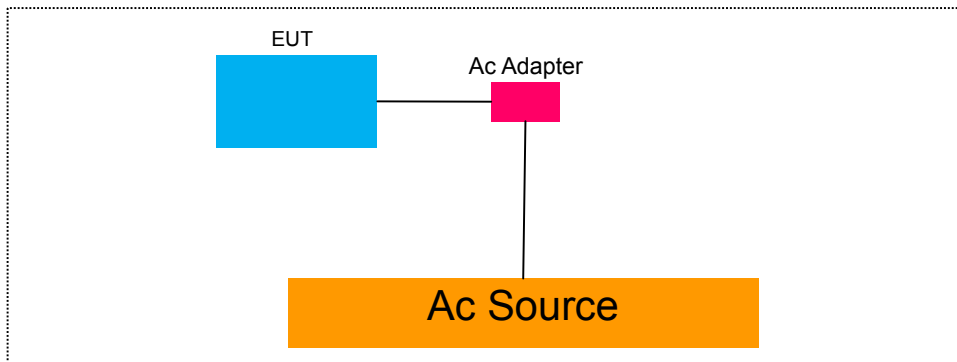

7.5 SUPPORT EQUIPMENT

Item	Equipment	Mfr/Brand	Model/Type No.	FCC ID	Series No.	Note
N/A	N/A	N/A	N/A	N/A	N/A	N/A

Notes:

1. All the equipment/cables were placed in the worst-case configuration to maximize the emission during the test.
2. Grounding was established in accordance with the manufacturer's requirements and conditions for the intended use.

8 TEST REQUIREMENTS

8.1 BANDWIDTH TEST

8.1.1 Applicable Standard

According to FCC Part 15.249

8.1.2 Conformance Limit

N/A

8.1.3 Test Configuration

Test according to clause 7.1 radio frequency test setup 1

8.1.4 Test Procedure

The EUT was operating in controlled its channel. Printed out the test result from the spectrum by hard copy function.

The RF output of EUT was connected to the spectrum analyzer by RF cable and attenuator. The path loss was compensated to the results for each measurement.

Set to the maximum power setting and enable the EUT transmit continuously

Set RBW = 10 kHz.

Set the video bandwidth (VBW) =30 kHz.

Set Span=2 times OBW

Set Detector = Peak.

Set Trace mode = max hold.

Set Sweep = auto couple.

Allow the trace to stabilize.

Measure the maximum width of the emission that is constrained by the frequencies associated with the two outermost amplitude points (upper and lower frequencies) that are attenuated by 20 dB relative to the maximum level measured in the fundamental emission.

Measure and record the results in the test report.

8.1.5 Test Results

Temperature :	28°C	Test Date :	December 6, 2016
Humidity :	65 %	Test By:	King Kong

Operation Mode	Channel Number	Channel Frequency (MHz)	Measurement Bandwidth (KHz)	Limit (kHz)	Verdict
GFSK	1	2406.0	37.77	N/A	PASS
	12	2439.0	37.52	N/A	PASS
	23	2472.0	37.59	N/A	PASS

Test Model	Bandwidth Test GFSK
------------	------------------------

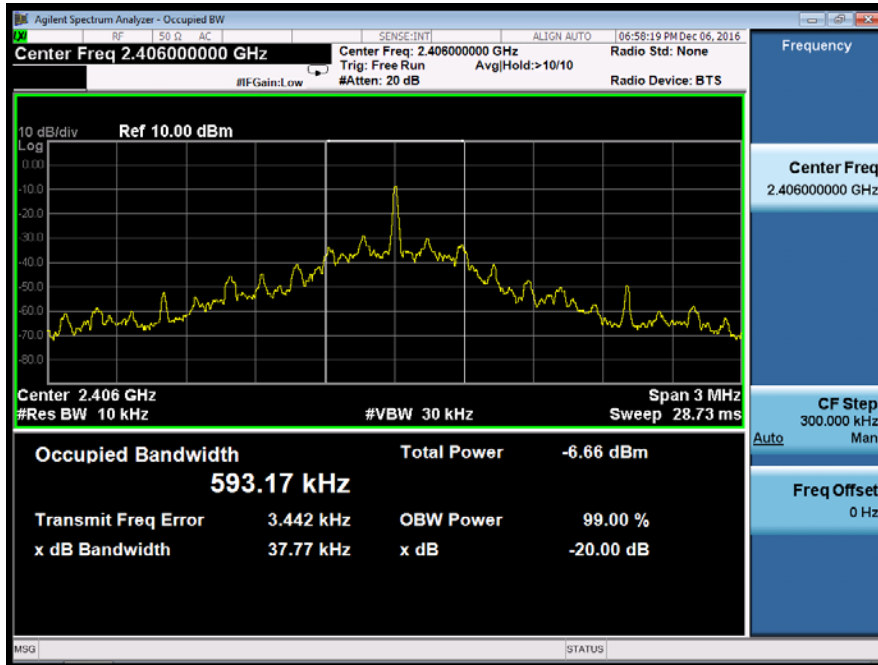

Test Model	Bandwidth Test GFSK
------------	------------------------

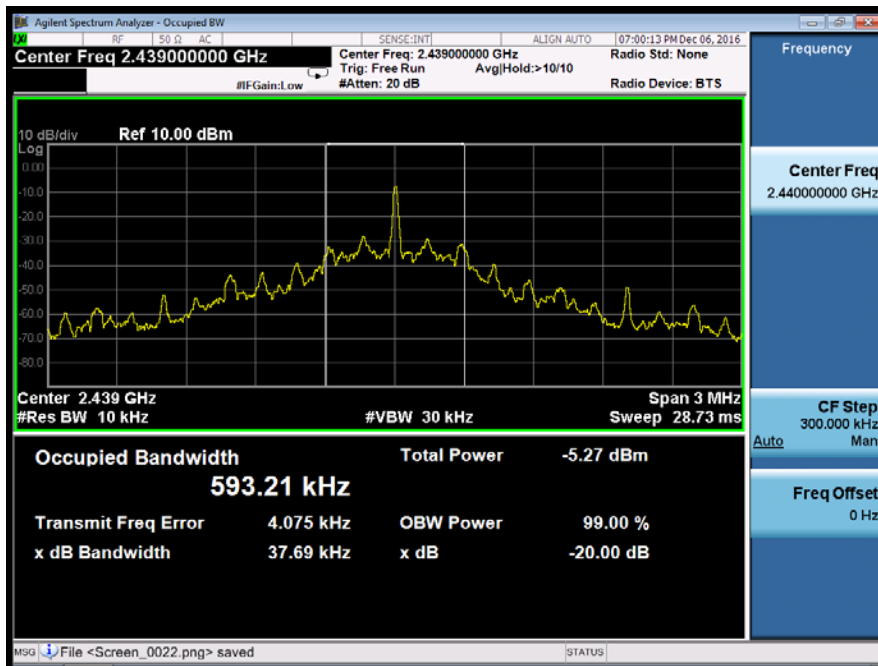

Test Model	Bandwidth Test GFSK
------------	------------------------

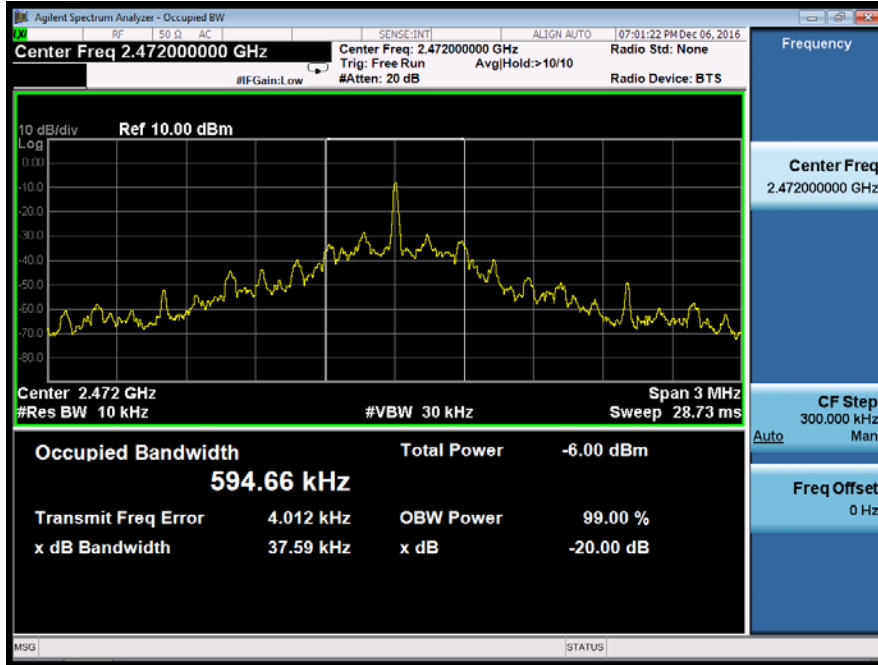

8.2 FREQUENCY STABILITY

8.2.1 Applicable Standard

According to FCC Part 15.249

8.2.2 Conformance Limit

The frequency tolerance of the carrier signal shall be maintained within ± 10 ppm of the operating frequency over a temperature variation of -20 degrees to + 50 degrees C at normal supply voltage, and for a variation in the primary supply voltage from 85% to 115% of the rated supply voltage at a temperature of 20 degrees C. For battery operated equipment, the equipment tests shall be performed using a new battery.

8.2.3 Test Configuration

Test according to clause 6.1 radio frequency test setup

8.2.4 Test Procedure

The RF output of EUT was connected to the spectrum analyzer by RF cable and attenuator. The path loss was compensated to the results for each measurement.

Set to the maximum power setting and enable the EUT transmit continuously

Set RBW = 10 kHz.

Set the video bandwidth (VBW) =30 kHz.

Set Span= Entire absence of modulation emissions bandwidth

Set Detector = Peak.

Set Trace mode = max hold.

Set Sweep = auto couple.

Allow the trace to stabilize.

The test extreme voltage is to change the primary supply voltage from 85 to 115 percent of the nominal value.

Beginning at each temperature level specified in user manual , the frequency shall be measured within one minute after application of primary power to the transmitter and at intervals of no more than one minute thereafter until ten minutes have elapsed or until sufficient measurements are obtained to indicate clearly that the frequency has stabilized within the applicable tolerance, whichever time period is greater. During each test, the ambient temperature shall not be allowed to rise more than 10° centigrade above the respective beginning ambient temperature level
Measure and record the results in the test report.

8.2.5 Test Results

N/A

8.3 RADIATED SPURIOUS EMISSION

8.3.1 Applicable Standard

According to FCC Part 15.249 and 15.209

8.3.2 Conformance Limit

According to FCC Part 15.249: radiated emissions which fall in the restricted bands, as defined in §15.205(a), must also comply with the radiated emission limits specified in §15.209(a) (see §15.205(c)).

According to FCC Part 15.205, Restricted bands

MHz	MHz	MHz	GHz
0.090-0.110	16.42-16.423	399.9-410	4.5-5.15
10.495-0.505	16.69475-16.69525	608-614	5.35-5.46
2.1735-2.1905	16.80425-16.80475	960-1240	7.25-7.75
4.125-4.128	25.5-25.67	1300-1427	8.025-8.5
4.17725-4.17775	37.5-38.25	1435-1626.5	9.0-9.2
4.20725-4.20775	73-74.6	1645.5-1646.5	9.3-9.5
6.215-6.218	74.8-75.2	1660-1710	10.6-12.7
6.26775-6.26825	123-138	2200-2300	14.47-14.5
8.291-8.294	149.9-150.05	2310-2390	15.35-16.2
8.362-8.366	156.52475-156.52525	2483.5-2500	17.7-21.4
8.37625-8.38675	156.7-156.9	2690-2900	22.01-23.12
8.41425-8.41475	162.0125-167.17	3260-3267	23.6-24.0
12.29-12.293	167.72-173.2	3332-3339	31.2-31.8
12.51975-12.52025	240-285	3345.8-3358	36.43-36.5
12.57675-12.57725	322-335.4	3600-4400	(2)
13.36-13.41			

According to FCC Part 15.205, the level of any transmitter spurious emission in Restricted bands shall not exceed the level of the emission specified in the following table

Restricted Frequency(MHz)	Field Strength ($\mu\text{V}/\text{m}$)	Field Strength ($\text{dB}\mu\text{V}/\text{m}$)	Measurement Distance
0.009-0.490	2400/F(KHz)	20 log ($\mu\text{V}/\text{m}$)	300
0.490-1.705	2400/F(KHz)	20 log ($\mu\text{V}/\text{m}$)	30
1.705-30	30	29.5	30
30-88	100	40	3
88-216	150	43.5	3
216-960	200	46	3
Above 960	500	54	3

Remark :1. Emission level in $\text{dB}\mu\text{V}/\text{m}=20 \log (\mu\text{V}/\text{m})$

2. Measurement was performed at an antenna to the closed point of EUT distance of meters.

3. Distance extrapolation factor = $40 \log (\text{Specific distance} / \text{test distance})$ (dB);

Limit line = Specific limits (dB μV) + distance extrapolation factor.

for the frequency ranges below 30 MHz, a narrower RBW is used for these ranges but the measured value should add a RBW correction factor (RBWCF) where $\text{RBWCF} [\text{dB}] = 10 \cdot \lg (100 [\text{kHz}] / \text{narrower RBW} [\text{kHz}])$. , the narrower RBW is 1 kHz and RBWCF is 20 dB for the frequency 9 kHz to 150 kHz, and the narrower RBW is 10 kHz and RBWCF is 10 dB for the frequency 150 kHz to 30 MHz.

Field strength of fundamental and Field strength of harmonics Limit:

Fundamental frequency	Field strength of fundamental (millivolts/meter)	Field strength of harmonics (microvolts/meter)
902-928 MHz	50(94 dBV/m)	500(54 dBV/m)
2400-2483.5 MHz	50(94 dBV/m)	500(54 dBV/m)
5725-5875 MHz	50(94 dBV/m)	500(54 dBV/m)
24.0-24.25 GHz	250(108 dBV/m)	2500(68 dBV/m)

8.3.3 Test Configuration

Test according to clause 7.2 radio frequency test setup 2

8.3.4 Test Procedure

This test is required for any spurious emission that falls in a Restricted Band, as defined in Section 15.205. It must be performed with the highest gain of each type of antenna proposed for use with the EUT. Use the following spectrum analyzer settings:

For Above 1GHz:

The EUT was placed on a turn table which is 1.5m above ground plane.

Maximum procedure was performed on the highest emissions to ensure EUT compliance.

Span = wide enough to fully capture the emission being measured

RBW = 1 MHz

VBW \geq RBW

Sweep = auto

Detector function = peak

Trace = max hold

For Below 1GHz:

The EUT was placed on a turn table which is 0.8m above ground plane.

Maximum procedure was performed on the highest emissions to ensure EUT compliance.

Span = wide enough to fully capture the emission being measured

RBW = 100 kHz for

VBW \geq RBW

Sweep = auto

Detector function = peak

Trace = max hold

For Below 30MHz:

The EUT was placed on a turn table which is 0.8m above ground plane.

Maximum procedure was performed on the highest emissions to ensure EUT compliance.

Span = wide enough to fully capture the emission being measured

RBW = 9kHz

VBW \geq RBW

Sweep = auto

Detector function = peak

Trace = max hold

For Below 150KHz:

The EUT was placed on a turn table which is 0.8m above ground plane.

Maximum procedure was performed on the highest emissions to ensure EUT compliance.

Span = wide enough to fully capture the emission being measured

RBW = 200Hz

VBW \geq RBW

Sweep = auto

Detector function = peak

Trace = max hold

Follow the guidelines in ANSI C63.10-2013 with respect to maximizing the emission by rotating the EUT,

measuring the emission while the EUT is situated in three orthogonal planes (if appropriate), adjusting the measurement antenna height and polarization, etc. A pre-amp and a high pass filter are required for this test, in order to provide the measuring system with sufficient sensitivity. Allow the trace to stabilize. The peak reading of the emission, after being corrected by the antenna factor, cable loss, pre-amp gain, etc., is the peak field strength, which must comply with the limit specified in Section 15.35(b). Submit this data. Now set the VBW to 10 Hz, while maintaining all of the other instrument settings. This peak level, once corrected, must comply with the limit specified in Section 15.209. If the dwell time per channel of the hopping signal is less than 100 ms, then the reading obtained with the 10 Hz VBW may be further adjusted by a “duty cycle correction factor”, derived from $20\log(\text{dwell time}/100 \text{ ms})$, in an effort to demonstrate compliance with the 15.209 limit. Submit this data.

Repeat above procedures until all frequency measured was complete.

8.3.5 Test Results

■ Spurious Emission below 30MHz (9KHz to 30MHz)

Temperature:	24°C	Test Date:	December 8, 2016
Humidity:	53 %	Test By:	King Kong
Test mode:	TX Mode		

Freq. (MHz)	Ant.Pol. H/V	Emission Level(dBuV/m)		Limit 3m(dBuV/m)		Over(dB)	
		PK	AV	PK	AV	PK	AV
--	--	--	--	--	--	--	--

Note: the amplitude of spurious emission that is attenuated by more than 20dB below the permissible limit has no need to be reported.

Distance extrapolation factor = $40\log(\text{Specific distance}/ \text{test distance})$ (dB);

Limit line=Specific limits(dBuV) + distance extrapolation factor

■ Spurious Emission Above 1GHz (1GHz to 25GHz)

Temperature :	28°C	Test Date :	December 8, 2016
Humidity :	65 %	Test By:	King Kong
Test mode:	GFSK	Frequency:	2406 MHZ

Freq. (MHz)	Ant.Pol. H/V	Emission Level(dBuV/m)		Limit 3m(dBuV/m)		Over(dB)	
		PK	AV	PK	AV	PK	AV
4807.66	V	43.54	30.22	74.00	54.00	-30.46	-23.78
7713.79	V	43.99	31.95	74.00	54.00	-30.01	-22.05
9785.31	V	47.89	34.83	74.00	54.00	-26.11	-19.17
--	--	--	--	--	--	--	--
--	--	--	--	--	--	--	--
--	--	--	--	--	--	--	--
4807.66	H	50.56	33.75	74.00	54.00	-23.44	-20.25
6081.79	H	47.62	30.72	74.00	54.00	-26.38	-23.28
9621.11	H	50.84	35.12	74.00	54.00	-23.16	-18.88

Temperature :	28°C	Test Date :	December 8, 2016
Humidity :	65 %	Test By:	King Kong
Test mode:	GFSK	Frequency:	2439 MHZ

Freq. (MHz)	Ant.Pol. H/V	Emission Level(dBuV/m)		Limit 3m(dBuV/m)		Over(dB)	
		PK	AV	PK	AV	PK	AV
4909.02	V	44.57	29.43	74.00	54.00	-29.43	-24.57
7357.94	V	47.58	32.38	74.00	54.00	-26.42	-21.62
9789.62	V	53.23	40.33	74.00	54.00	-20.77	-13.67
--	--	--	--	--	--	--	--
--	--	--	--	--	--	--	--
--	--	--	--	--	--	--	--
4892.66	H	49.15	32.15	74.00	54.00	-24.85	-21.85
7305.79	H	50.66	34.52	74.00	54.00	-23.34	-19.48
9774.11	H	53.69	38.62	74.00	54.00	-20.31	-15.38

Temperature :	28°C	Test Date :	December 8, 2016
Humidity :	65 %	Test By:	King Kong
Test mode:	GFSK	Frequency:	2472 MHZ

Freq. (MHz)	Ant.Pol. H/V	Emission Level(dBuV/m)		Limit 3m(dBuV/m)		Over(dB)	
		PK	AV	PK	AV	PK	AV
4936.60	V	43.49	29.92	74.00	54.00	-30.51	-24.08
7462.26	V	46.49	33.65	74.00	54.00	-27.51	-20.35
9888.05	V	52.94	40.03	74.00	54.00	-21.06	-13.97
--	--	--	--	--	--	--	--
--	--	--	--	--	--	--	--
--	--	--	--	--	--	--	--
4937.25	H	47.54	31.91	74.00	54.00	-26.46	-22.09
7465.19	H	46.22	30.39	74.00	54.00	-27.78	-23.61
9888.32	H	51.64	36.02	74.00	54.00	-22.36	-17.98

- Note:** (1) All Readings are Peak Value (VBW=3MHz) and Peak Value (VBW=10Hz).
(2) Emission Level= Reading Level+Probe Factor +Cable Loss.
(3) Data of measurement within this frequency range shown “ -- ” in the table above means the reading of emissions are attenuated more than 20dB below the permissible limits or the field strength is too small to be measured.

■ Spurious Emission in Restricted Band 2310-2390MHz and 2483.5-2500MHz

Temperature :	28°C	Test Date :	December 8, 2016
Humidity :	65 %	Test By:	King Kong
Test mode:	GFSK	Frequency:	

Frequency (MHz)	Polarity	PK(dBuV/m) (VBW=3MHz)	Limit 3m (dBuV/m)	AV(dBuV/m) (VBW=10Hz)	Limit 3m (dBuV/m)
2380.960	H	49.18	74.00	33.21	54.00
2389.360	V	50.25	74.00	35.60	54.00

Temperature :	28°C	Test Date :	December 8, 2016
Humidity :	65 %	Test By:	King Kong
Test mode:	GFSK	Frequency:	

Frequency (MHz)	Polarity	PK(dBuV/m) (VBW=3MHz)	Limit 3m (dBuV/m)	AV(dBuV/m) (VBW=10Hz)	Limit 3m (dBuV/m)
2483.814	H	46.47	74.00	31.20	54.00
2483.530	V	49.03	74.00	31.50	54.00

- Note:** (1) All Readings are Peak Value (VBW=3MHz) and Peak Value (VBW=10Hz).
 (2) Emission Level= Reading Level+Probe Factor +Cable Loss.
 (3) Data of measurement within this frequency range shown "--" in the table above means the reading of emissions are attenuated more than 20dB below the permissible limits or the field strength is too small to be measured.

Spurious Emission in Restricted Band 2310-2390MHz		
Test Model	GFSK	Polarity: H
	Channel 1: 2406MHz	Test By: King Kong

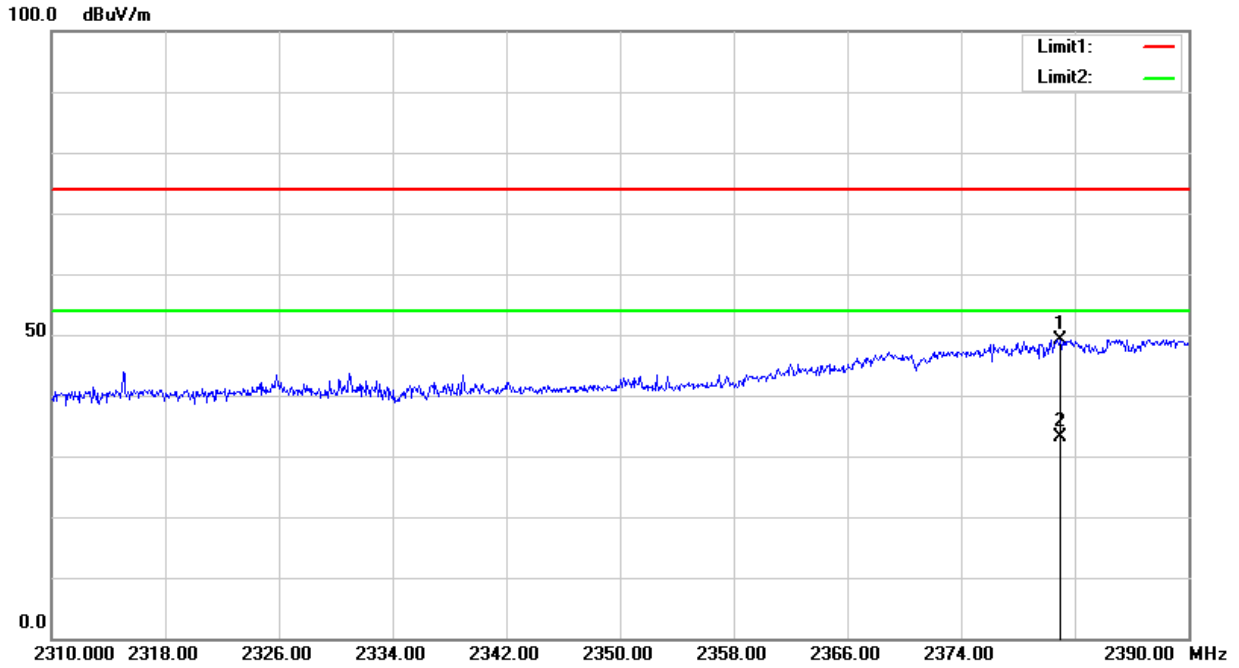

Spurious Emission in Restricted Band 2310-2390MHz		
Test Model	GFSK	Polarity: V
	Channel 1: 2406MHz	Test By: King Kong

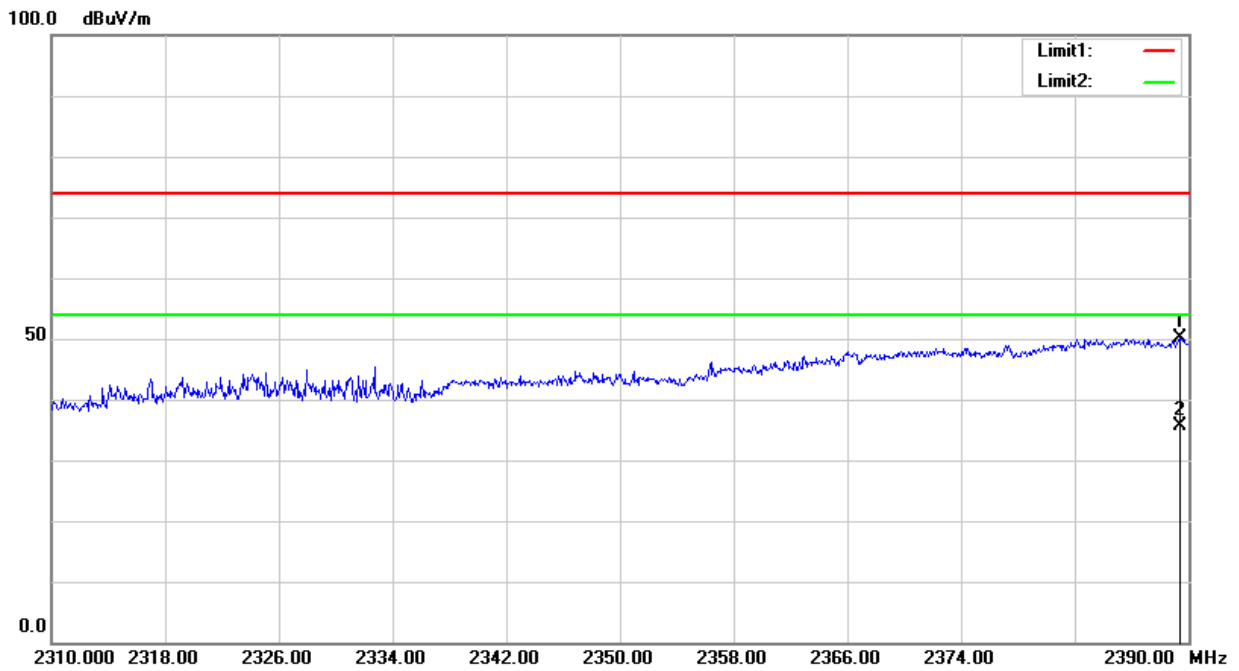

Spurious Emission in Restricted Band 2483.5-2500MHz	
Test Model	GFSK
	Channel 23: 2472MHz
	Polarity:H
	Test By: King Kong

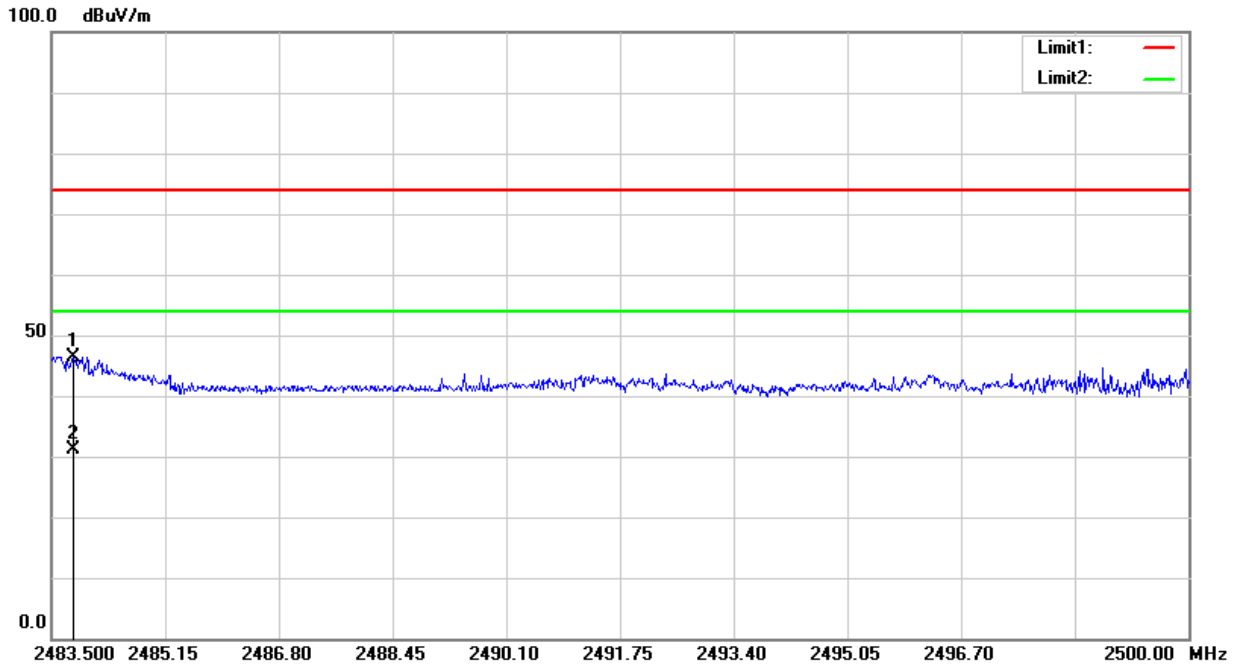

Spurious Emission in Restricted Band 2483.5-2500MHz	
Test Model	GFSK
	Channel 23: 2472MHz
	Polarity:V
	Test By: King Kong

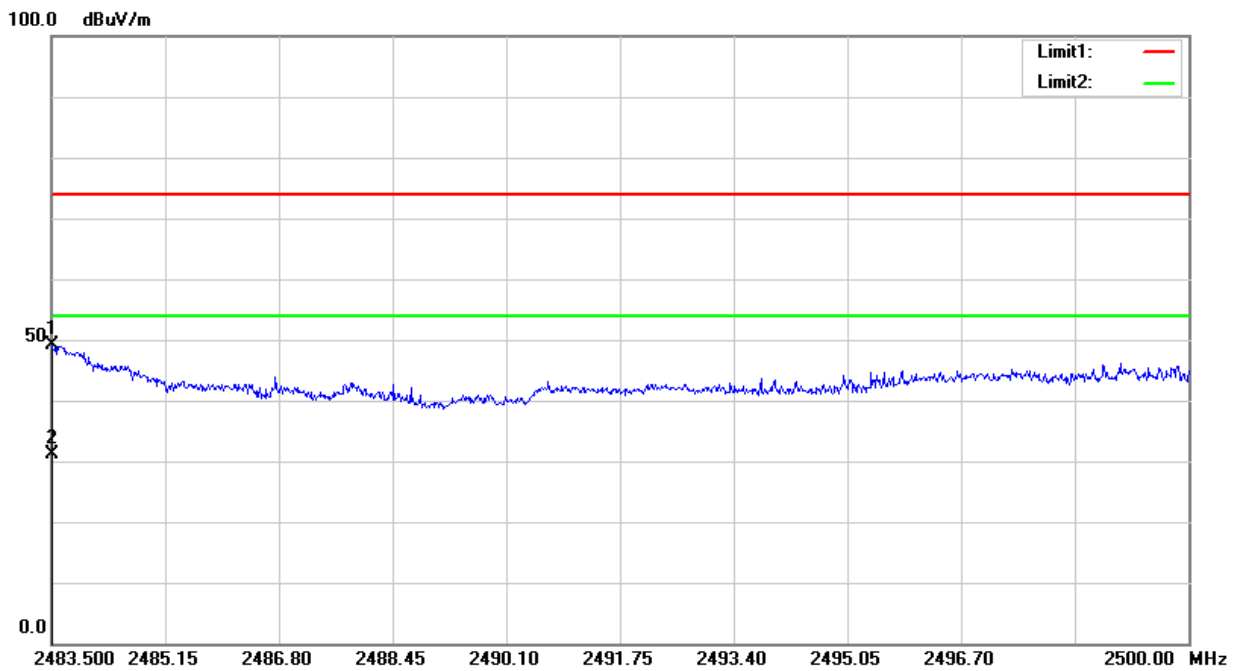

■ Spurious Emission below 1GHz (30MHz to 1GHz)

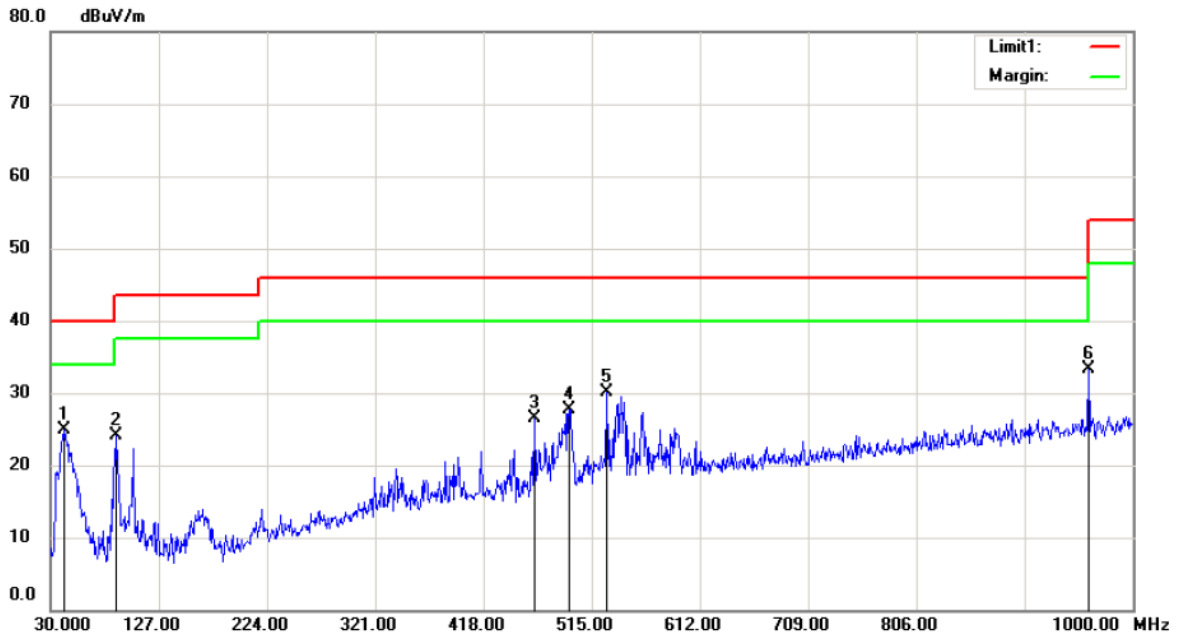

Site 3m Chamber #2

Polarization: *Vertical*

Temperature: 22 C

Limit: (RE)FCC PART 15 CLASS B

Power: AC 120V/60Hz

Humidity: 55 %

Mode:TX LOW

Note:

No.	Mk.	Freq.	Reading Level	Correct Factor	Measurement	Limit	Over	Antenna Height	Table Degree	
		MHz	dBuV	dB	dBuV/m	dBuV/m	dB	cm	degree	Comment
1	*	42.6100	39.19	-14.33	24.86	40.00	-15.14	QP		
2		89.1700	42.20	-18.01	24.19	43.50	-19.31	QP		
3		463.5900	34.95	-8.37	26.58	46.00	-19.42	QP		
4		494.6300	35.27	-7.63	27.64	46.00	-18.36	QP		
5		528.5800	37.06	-6.86	30.20	46.00	-15.80	QP		
6		960.2300	33.06	0.24	33.30	54.00	-20.70	QP		

*:Maximum data x:Over limit !:over margin

Operator: RJB

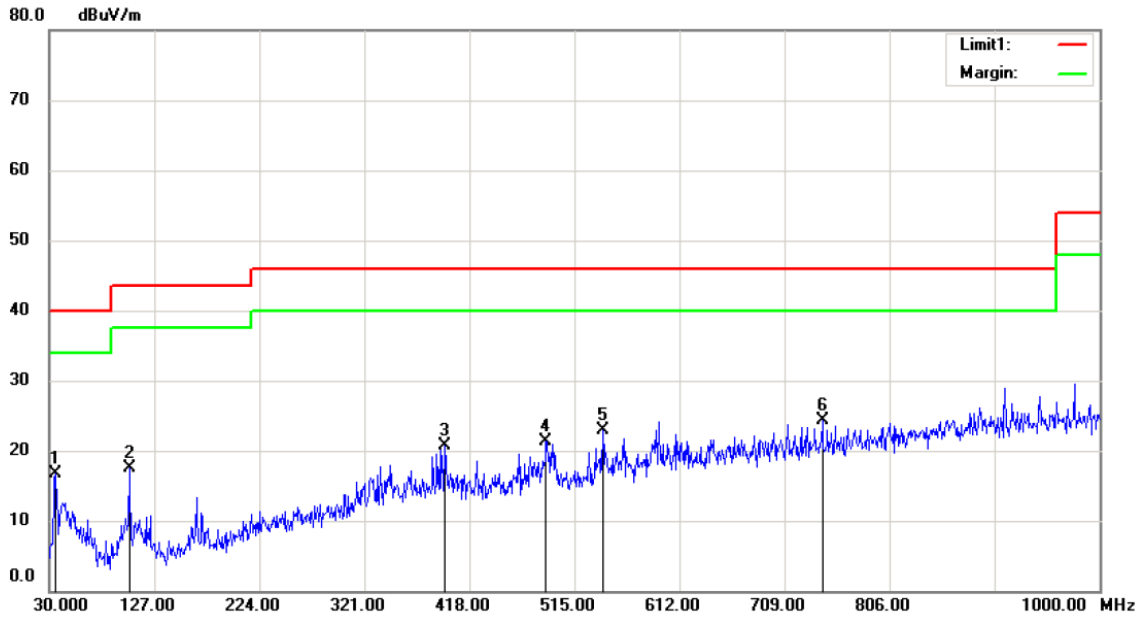

Site 3m Chamber #2 Polarization: **Horizontal** Temperature: 22 C
 Limit: (RE)FCC PART 15 CLASS B Power: AC 120V/60Hz Humidity: 55 %
 Mode:TX LOW
 Note:

No.	Mk.	Freq.	Reading Level	Correct Factor	Measurement	Limit	Over	Antenna Height	Table Degree	
		MHz	dBuV	dB	dBuV/m	dBuV/m	dB	cm	degree	Comment
1		35.8200	33.43	-16.66	16.77	40.00	-23.23	QP		
2		103.7200	32.57	-15.15	17.42	43.50	-26.08	QP		
3		395.6900	29.88	-9.24	20.64	46.00	-25.36	QP		
4		488.8100	29.10	-7.76	21.34	46.00	-24.66	QP		
5		541.1900	29.43	-6.57	22.86	46.00	-23.14	QP		
6	*	743.9200	27.30	-2.96	24.34	46.00	-21.66	QP		

*:Maximum data x:Over limit !:over margin

Operator: RJB

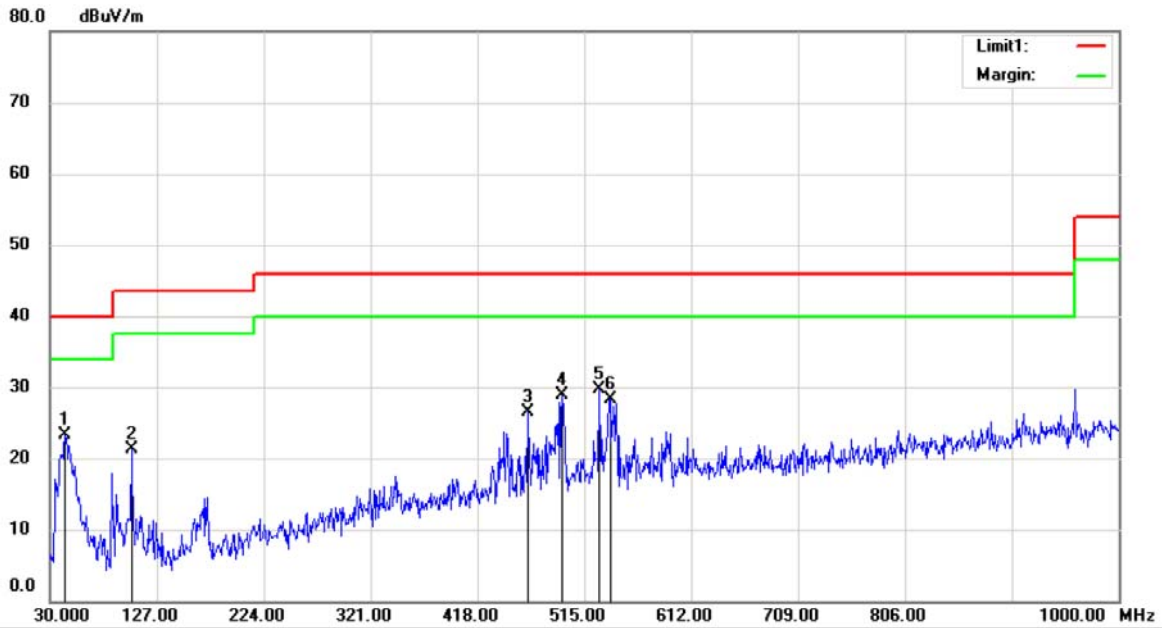

Site 3m Chamber #2 Polarization: *Vertical* Temperature: 22 C
 Limit: (RE)FCC PART 15 CLASS B Power: AC 120V/60Hz Humidity: 55 %

Mode:TX MID

Note:

No.	Mk.	Freq.	Reading Level	Correct Factor	Measurement	Limit	Over	Antenna Height	Table Degree	
		MHz	dBuV	dB	dBuV/m	dBuV/m	dB	cm	degree	Comment
1		43.5800	37.47	-14.14	23.33	40.00	-16.67			QP
2		103.7200	36.45	-15.15	21.30	43.50	-22.20			QP
3		463.5900	34.89	-8.37	26.52	46.00	-19.48			QP
4		494.6300	36.47	-7.63	28.84	46.00	-17.16			QP
5	*	528.5800	36.56	-6.86	29.70	46.00	-16.30			QP
6		538.2800	34.86	-6.63	28.23	46.00	-17.77			QP

*:Maximum data x:Over limit !:over margin

Operator: RJB

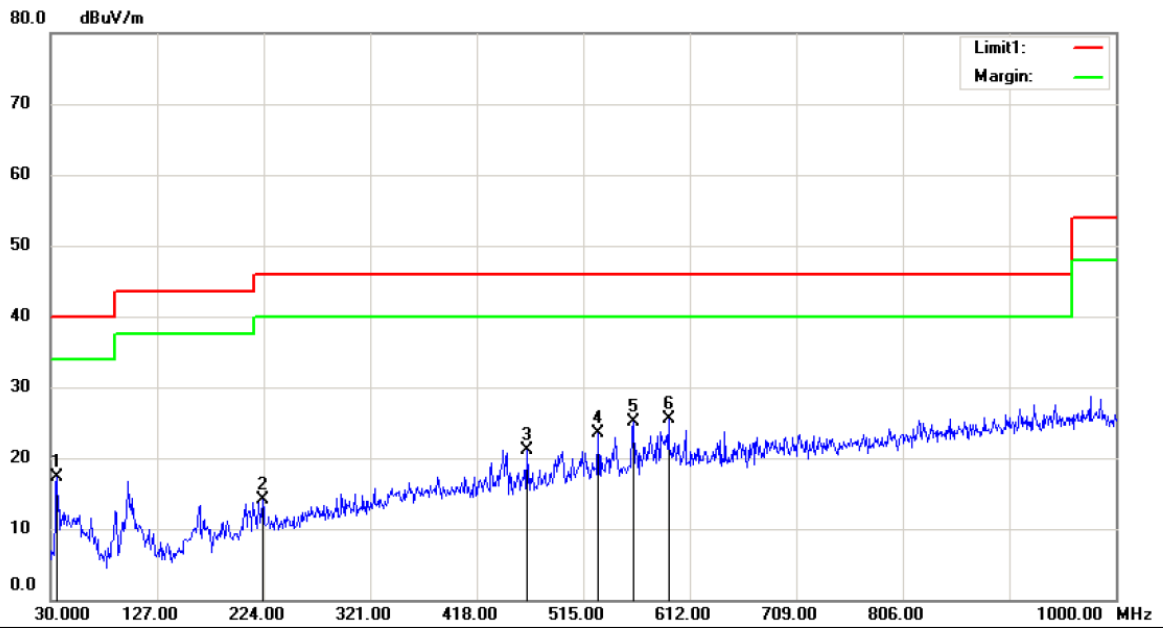

Site: 3m Chamber #2 Polarization: *Horizontal* Temperature: 22 C
 Limit: (RE)FCC PART 15 CLASS B Power: AC 120V/60Hz Humidity: 55 %
 Mode: TX MID
 Note:

No.	Mk.	Freq.	Reading Level	Correct Factor	Measurement	Limit	Over	Antenna Height	Table Degree	
		MHz	dBuV	dB	dBuV/m	dBuV/m	dB	cm	degree	Comment
1		35.8200	34.02	-16.66	17.36	40.00	-22.64	QP		
2		223.0300	28.43	-14.30	14.13	46.00	-31.87	QP		
3		463.5900	29.53	-8.37	21.16	46.00	-24.84	QP		
4		528.5800	30.36	-6.86	23.50	46.00	-22.50	QP		
5		560.5900	31.15	-6.13	25.02	46.00	-20.98	QP		
6	*	592.6000	30.94	-5.40	25.54	46.00	-20.46	QP		

!:Maximum data x:Over limit !:over margin

Operator: RJB

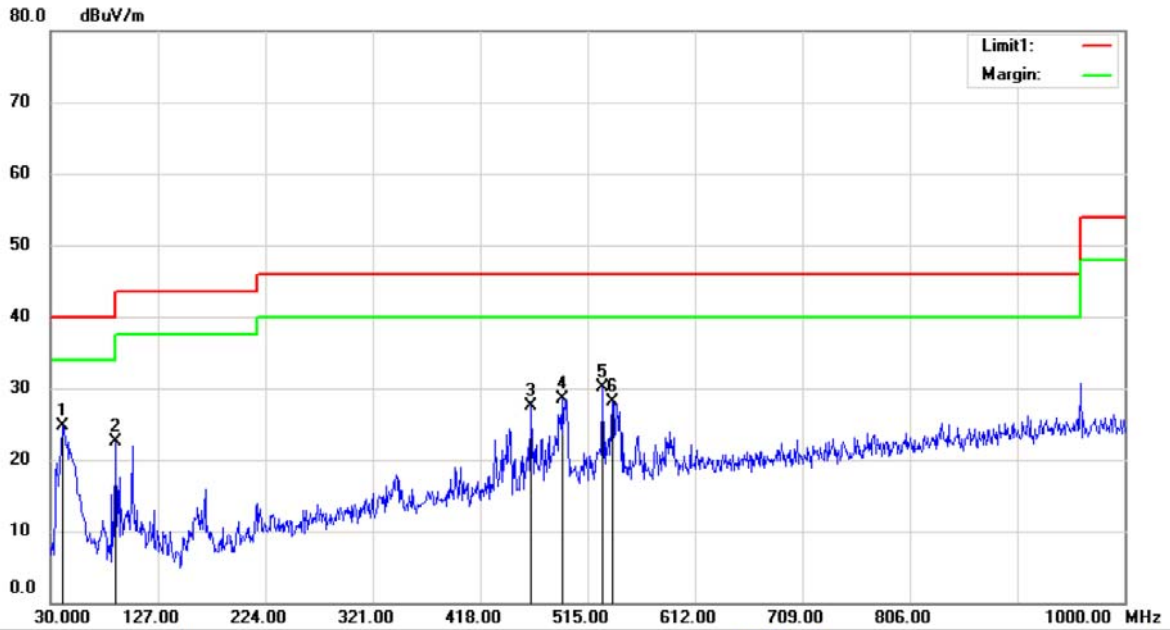

Site 3m Chamber #2 Polarization: *Vertical* Temperature: 22 C
 Limit: (RE)FCC PART 15 CLASS B Power: AC 120V/60Hz Humidity: 55 %
 Mode:TX HIGH
 Note:

No.	Mk.	Freq.	Reading Level	Correct Factor	Measurement	Limit	Over	Antenna Height	Table Degree	
		MHz	dBuV	dB	dBuV/m	dBuV/m	dB	cm	degree	Comment
1	*	40.6700	39.19	-14.46	24.73	40.00	-15.27	QP		
2		88.2000	40.66	-18.14	22.52	43.50	-20.98	QP		
3		463.5900	35.94	-8.37	27.57	46.00	-18.43	QP		
4		491.7200	36.19	-7.69	28.50	46.00	-17.50	QP		
5		528.5800	36.88	-6.86	30.02	46.00	-15.98	QP		
6		537.3100	34.66	-6.65	28.01	46.00	-17.99	QP		

*:Maximum data x:Over limit l:over margin

Operator: RJB

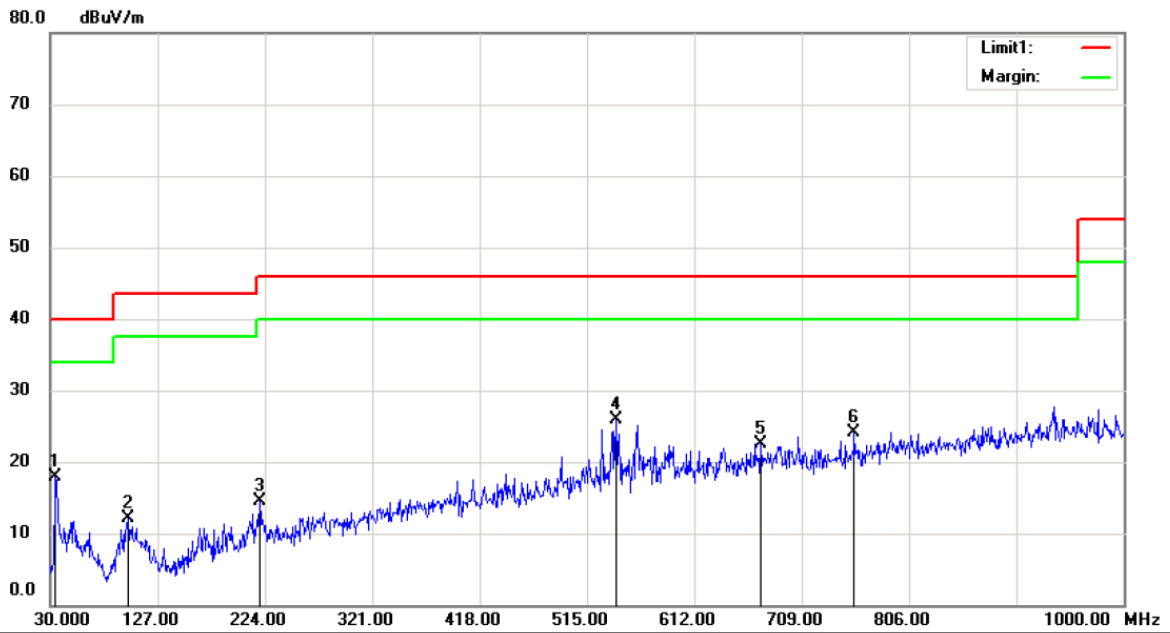

Site 3m Chamber #2

Polarization: *Horizontal*

Temperature: 22 C

Limit: (RE)FCC PART 15 CLASS B

Power: AC 120V/60Hz

Humidity: 55 %

Mode:TX HIGH

Note:

No.	Mk.	Freq. MHz	Reading Level dBuV	Correct Factor dB	Measure- ment dBuV/m	Limit dBuV/m	Over dB	Detector	Antenna Height cm	Table Degree	Comment
1		34.8500	34.77	-16.86	17.91	40.00	-22.09	peak			
2		100.8100	27.10	-14.94	12.16	43.50	-31.34	peak			
3		219.1500	28.86	-14.45	14.41	46.00	-31.59	peak			
4	*	541.1900	32.52	-6.57	25.95	46.00	-20.05	peak			
5		672.1400	26.67	-4.17	22.50	46.00	-23.50	peak			
6		756.5300	26.86	-2.75	24.11	46.00	-21.89	peak			

*:Maximum data x:Over limit !:over margin

Operator: RJB

■ Transmitter Fundamental Field Strength

Operation Mode:	GFSK(Low,Mid,High)	Test Date :	December 7, 2016
Temperature :	24°C	Humidity :	55 %
Test Result:	PASS	Test By:	King Kong
Measured Distance:	3m		

Freq. (MHz)	Ant.Pol. H/V	Emission Level		Limit at 3m		Margin	
		PK(dBuV/m) (VBW=3MHz)	AV(dBuV/m) (VBW=10Hz)	PK (dBuV/m)	AV (dBuV/m)	PK (dB)	AV (dB)
2406	V	86.25	73.10	114	94	-27.75	-20.9
2406	H	82.16	70.85	114	94	-31.84	-23.15
2439	V	87.36	72.62	114	94	-26.64	-21.38
2439	H	79.65	66.20	114	94	-34.35	-27.8
2472	V	86.74	73.31	114	94	-27.26	-20.69
2472	H	82.65	68.90	114	94	-31.35	-25.10

Note: (1) All Readings are Peak Value (VBW=3MHz) and Peak Value (VBW=10Hz).
 (2) Emission Level= Reading Level+Probe Factor +Cable Loss

8.4 CONDUCTED EMISSIONS TEST

8.4.1 Applicable Standard

According to FCC Part 15.207(a)

8.4.2 Conformance Limit

Conducted Emission Limit		
Frequency(MHz)	Quasi-peak	Average
0.15-0.5	66-56	56-46
0.5-5.0	56	46
5.0-30.0	60	50

Note: 1. The lower limit shall apply at the transition frequencies
 2. The limit decreases in line with the logarithm of the frequency in the range of 0.15 to 0.50MHz.

8.4.3 Test Configuration

Test according to clause 7.3 conducted emission test setup

8.4.4 Test Procedure

The EUT was placed on a table which is 0.8m above ground plane.
 Maximum procedure was performed on the highest emissions to ensure EUT compliance.
 Repeat above procedures until all frequency measured were complete.

8.4.5 Test Results

Pass

We test the EUT at 120V and 240V, and show the worst result as bellow.

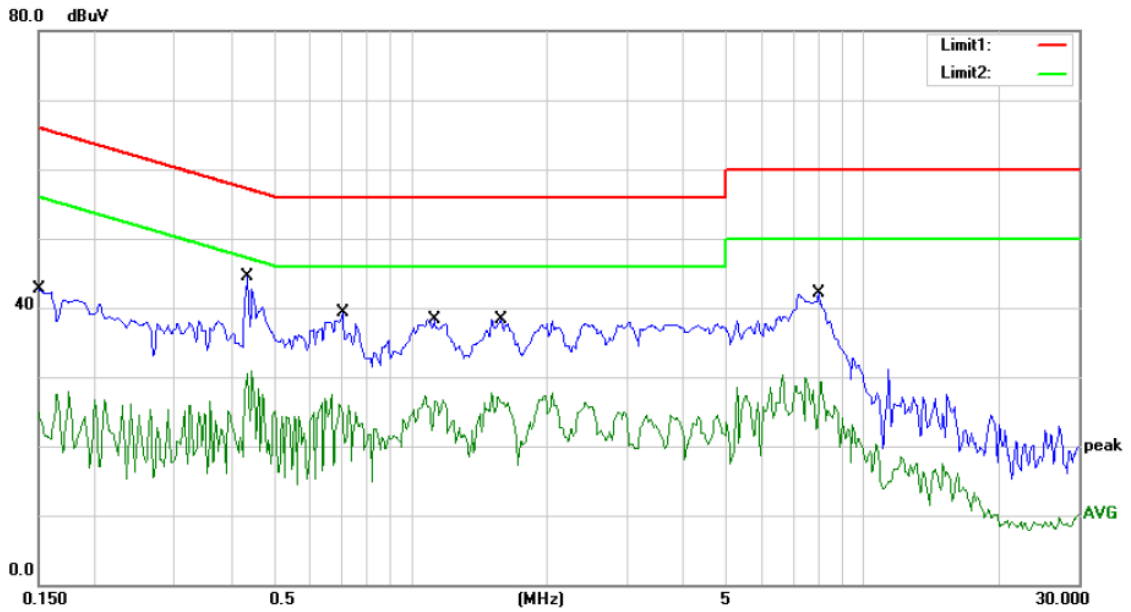

Site Conduction #1 Phase: **L1** Temperature: 22
 Limit: (CE)FCC PART 15 class B_QP Power: AC 120V/60Hz Humidity: 55 %
 Mode: ON
 Note:

No.	Mk.	Freq.	Reading Level	Correct Factor	Measurement	Limit	Over	Detector	Comment
		MHz	dBuV	dB	dBuV	dBuV	dB		
1		0.1500	42.69	0.00	42.69	66.00	-23.31	QP	
2		0.1500	27.88	0.00	27.88	56.00	-28.12	AVG	
3	*	0.4350	44.41	0.00	44.41	57.16	-12.75	QP	
4		0.4350	30.97	0.00	30.97	47.16	-16.19	AVG	
5		0.7050	39.35	0.00	39.35	56.00	-16.65	QP	
6		0.7050	27.41	0.00	27.41	46.00	-18.59	AVG	
7		1.1250	38.36	0.00	38.36	56.00	-17.64	QP	
8		1.1250	27.24	0.00	27.24	46.00	-18.76	AVG	
9		1.5800	38.39	0.00	38.39	56.00	-17.61	QP	
10		1.5800	27.66	0.00	27.66	46.00	-18.34	AVG	
11		8.0000	42.02	0.00	42.02	60.00	-17.98	QP	
12		8.0000	29.32	0.00	29.32	50.00	-20.68	AVG	

*:Maximum data x:Over limit !:over margin Comment: Factor build in receiver. Operator: CSL

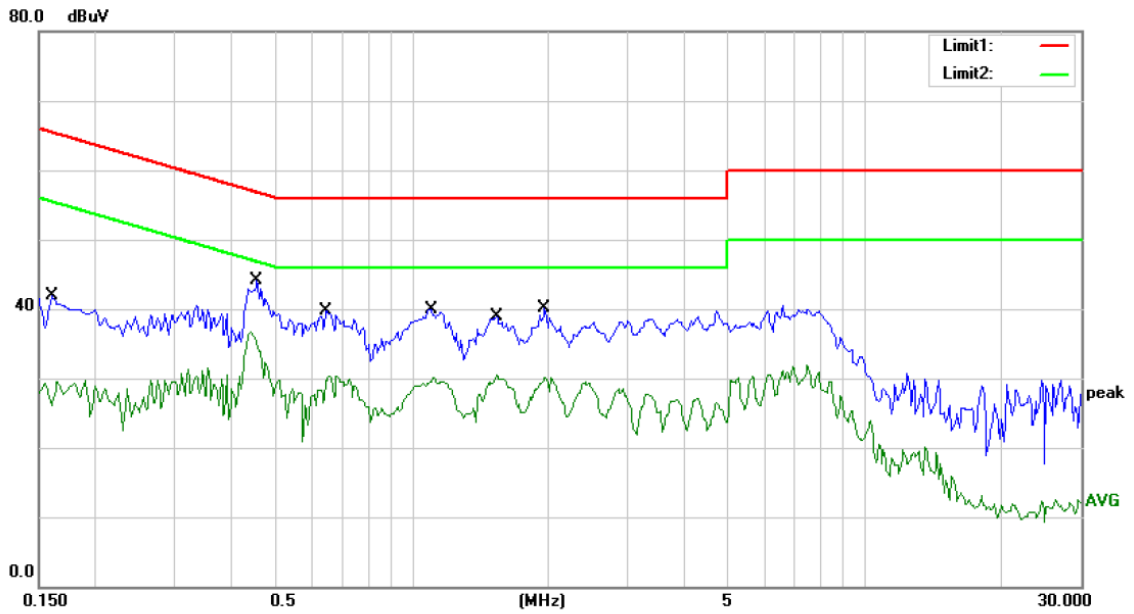

Site Conduction #1 Phase: **N** Temperature: 22
 Limit: (CE)FCC PART 15 class B_QP Power: AC 120V/60Hz Humidity: 55 %
 Mode: ON
 Note:

No. Mk.	Freq. MHz	Reading Level dBuV	Correct Factor dB	Measurement dBuV	Limit dBuV	Over dB	Detector	Comment
1	0.1600	41.83	0.00	41.83	65.46	-23.63	QP	
2	0.1600	29.52	0.00	29.52	55.46	-25.94	AVG	
3	0.4550	44.17	0.00	44.17	56.78	-12.61	QP	
4 *	0.4550	36.69	0.00	36.69	46.78	-10.09	AVG	
5	0.6450	39.79	0.00	39.79	56.00	-16.21	QP	
6	0.6450	30.36	0.00	30.36	46.00	-15.64	AVG	
7	1.1050	39.94	0.00	39.94	56.00	-16.06	QP	
8	1.1050	30.07	0.00	30.07	46.00	-15.93	AVG	
9	1.5400	38.95	0.00	38.95	56.00	-17.05	QP	
10	1.5400	30.44	0.00	30.44	46.00	-15.56	AVG	
11	1.9650	40.07	0.00	40.07	56.00	-15.93	QP	
12	1.9650	30.18	0.00	30.18	46.00	-15.82	AVG	

*:Maximum data x:Over limit !:over margin Comment: Factor build in receiver. Operator: CSL

8.5 ANTENNA APPLICATION

8.5.1 Antenna Requirement

Standard	Requirement
FCC CRF Part 15.203	An intentional radiator shall be designed to ensure that no antenna other than that furnished by the responsible party shall be used with the device. The use of a permanently attached antenna or of an antenna that uses a unique coupling to the intentional radiator shall be considered sufficient to comply with the provisions of this section. The manufacturer may design the unit so that a broken antenna can be replaced by the user, but the use of a standard antenna jack or electrical connector is prohibited. This requirement does not apply to carrier current devices or to devices operated under the provisions of §15.211, §15.213, §15.217, §15.219, or §15.221. Further, this requirement does not apply to intentional radiators that must be professionally installed, such as perimeter protection systems and some field disturbance sensors, or to other intentional radiators which, in accordance with §15.31(d), must be measured at the installation site. However, the installer shall be responsible for ensuring that the proper antenna is employed so that the limits in this part are not exceeded.

For intentional device, according to FCC 47 CFR Section 15.203, an intentional radiator shall be designed to ensure that no antenna other than that furnished by the responsible party shall be used with the device.

8.5.2 Result

PASS.

- Note:
- Antenna use a permanently attached antenna which is not replaceable.
 - Not using a standard antenna jack or electrical connector for antenna replacement
 - The antenna has to be professionally installed (please provide method of installation)

which in accordance to section 15.203, please refer to the internal photos.