



HYUNDAI CALIBRATION & CERTIFICATION TECH. CO., LTD.

PRODUCT COMPLIANCE DIVISION
SAN 136-1, AMI-RI, BUBAL-EUP, ICHEON-SI, KYOUNGKI-DO, 467-701, KOREA
TEL: +82 31 639 8518 FAX: +82 31 639 8525 www.hct.co.kr



HEARING AID COMPATIBILITY CERTIFICATE

PANTECH&CURITEL COMMUNICATIONS, INC.

110-1, ONGJEONG-RI, TONGJIN-EUP, GIMPO-SI,
GYOUNGGI-DO, 415-865, KOREA

Date of Issue: December 14, 2006

Test Report No.: HCT-SAR06-1210

Test Site: HYUNDAI CALIBRATION &
CERTIFICATIONTECHNOLOGIES CO., LTD.

FCC ID: PP4OVAL

APPLICANT: PANTECH&CURITEL COMMUNICATION, INC.

Application Type:	Certification
EUT Type:	Dual-Band CDMA phone with Bluetooth- Prototype
Tx Frequency:	824.70 — 848.31 MHz (CDMA) 1851.25 — 1908.75 MHz (PCS CDMA)
Maximum Conducted	0.316W CDMA (25.0dBm)
Power (HAC):	0.316W PCS CDMA (25.0dBm)
Trade Name/Model(s):	PANTECH&CURITEL / OVAL
FCC Classification:	Licensed Portable Transmitter Held to Ear (PCE)
FCC Rule Part(s):	§20.19
HAC Standard:	ANSI C63.19-2006 V3.12

Hearing Aid Near-Field Category: M4

This wireless portable device has been shown to be hearing-aid compatible under the above rated category, specified in ANSI/IEEE Std. C63.19-2006 and had been tested in accordance with the specified measurement procedures. Hearing-Aid Compatibility is based on the assumption that all production units will be designed electrically identical to the device tested in this report.

I attest to the accuracy of data. All measurements reported herein were performed by me or were made under my supervision and are correct to the best of my knowledge and belief. I assume full responsibility for the completeness of these measurements and vouch for the qualifications of all persons taking them.

Hyundai C-Tech Co., Ltd. Certifies that no party to this application has been denied FCC benefits pursuant to section 5301 of the Anti-Drug Abuse Act of 1998, 21 U.S. C. 862

Report prepared by: Ki-Soo Kim

Manager of Product Compliance Team

This report only only relates to the tested sample and may not be reproduced, except in full, without written approval of the HCT Co., Ltd.

Table of Contents

1. APLICANT / EUT DESCRIPTION -----	3
2. HAC MEASUREMENT SET- UP -----	4
3. SYSTEM SPECIFICATIONS -----	5-6
4. EUT ARRANGEMENT -----	7
5. SYSTEM VALIDATION -----	8-9
6. PROBE MODULATION FACTOR -----	10-12
7. FCC 3G MEASUREMENTS – MAY / JUNE 2006 -----	13
8. TEST PROCEDURE -----	14-15
9. ANSI/IEEE C63.19 PERFORMANCE CATEGORIES -----	16
10. MEASUREMENT UNCERTAINTIES -----	17
11. HAC TEST DATA SUMMARY -----	18-20
12. HAC TEST EQUIPMENT LIST -----	21
13. CONCLUSION -----	22

Appendix 1 –HAC Data Plots

HAC MEASUREMENT REPORT

1. APPLICANT / EUT DESCRIPTION

1.1 Applicant

Company Name:	PANTECH&CURITEL COMMUNICATION, INC.
Address:	110-1, ONGJEONG-RI, TONGJIN-EUP, GIMPO-SI, GYOUNGGI-DO, 415-865, KOREA
Attention:	Ki Yeoul, LEE
Tel. / Fax :	+82-31-999-8801 / +82-31-984-9771
E-Mail :	leekiyeoul@pantech.com

1.2 EUT Description

• EUT Type:	Dual-Band CDMA phone with Bluetooth- Prototype
• Trade Name:	PANTECH&CURITEL
• Model(s):	OVAL
• FCC ID:	PP4OVAL
• Serial Number(s):	PCCOVAL-1
• Tx Frequency:	824.70 — 848.31 MHz (CDMA) 1851.25 — 1908.75 MHz (PCS CDMA)
• FCC Classification:	Licensed Portable Transmitter Held to Ear (PCE)
• FCC Rule Part(s):	§2.1093; FCC/ OET Bulletin Supplement C [July 2001]
• Modulation(s):	CDMA/ PCS CDMA
• Antenna Type:	Intenna
• Date(s) of Tests:	December 13, 2006
• Place of Tests:	Hyundai C-Tech. EMC Lab. Icheon, Kyoungki-Do, KOREA
• Report Serial No.:	HCT-SAR06-1210
• Max E-Field Emission:	channel 1175, 1908.75 MHz= 33.5dBV/m (M4)
• Max H-Field Emission:	channel 1175, 1908.75 MHz= -18.6 dBA/m (M4)

2. HAC MEASUREMENT SET-UP

These measurements are performed using the DASY4 automated dosimetric assessment system. It is made by Schmid & Partner Engineering AG (SPEAG) in Zurich, Switzerland. It consists of high precision robotics system (Staubli), robot controller, Pentium IV computer, near-field probe, probe alignment sensor. The robot is a six-axis industrial robot performing precise movements.

A cell controller system contains the power supply, robot controller, teach pendant (Joystick), and remote control, is used to drive the robot motors. The PC consists of the HP Pentium IV 3.0 GHz computer with Windows XP system and HAC Measurement Software DASY4, A/D interface card, monitor, mouse, and keyboard. The Staubli Robot is connected to the cell controller to allow software manipulation of the robot. A data acquisition electronic (DAE) circuit performs the signal amplification, signal multiplexing, AD-conversion, offset measurements, mechanical surface detection, collision detection, etc. is connected to the Electro-optical coupler (EOC). The EOC performs the conversion from the optical into digital electric signal of the DAE and transfers data to the PC plug-in card.

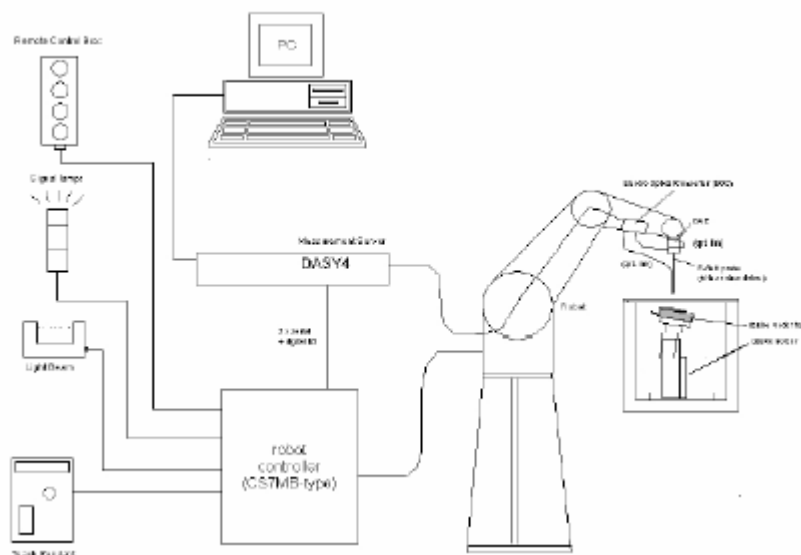



Figure 1. HAC Test Measurement Set-up

The DAE4 consists of a highly sensitive electrometer-grade preamplifier with auto-zeroing, a channel and gain-switching multiplexer, a fast 16 bit AD-converter and a command decoder and control logic unit. Transmission to the PC-card is accomplished through an optical downlink for data and status information and an optical uplink for commands and clock lines. The mechanical probe mounting device includes two different sensor systems for frontal and sidewise probe contacts. They are also used for mechanical surface detection and probe collision detection. The robot uses its own controller with a built in VME-bus computer.

3. SYSTEM SPECIFICATIONS

3.1 Probe

3.1.1 E-Field Probe Description

Construction	One dipole parallel, two dipoles normal to probe axis Built-in shielding against static charges	 <p>[E-Field Probe]</p>
Calibration	In air from 100 MHz to 3.0 GHz (absolute accuracy $\pm 6.0\%$, k=2)	
Frequency	100 MHz to > 6 GHz; Linearity: $\pm 0.2\text{dB}$ (100 MHz to 3 GHz)	
Directivity	± 0.2 dB in air (rotation around probe axis) ± 0.4 dB in air (rotation normal to probe axis)	
Dynamic Range	2 V/m to > 1000 V/m (M3 or better device readings fall well below diode compression point)	
Linearity	± 0.2 dB	
Dimensions	Overall length: 330 mm (Tip: 16mm) Tip diameter: 8 mm (Body: 12 mm) Distance from probe tip to dipole centers: 2.5 mm	

3.1.2 H-Field Probe Description

Construction	Three concentric loop sensors with 3.8 mm loop diameters resistively loaded detector diodes for linear response Built-in shielding against static charges PEEK enclosure material (resistant to organic solvents, e.g., glycoether)	 <p>[H-Field Probe]</p>
Frequency	200 MHz to > 3 GHz (absolute accuracy $\pm 6.0\%$, k=2); Output linearized	
Directivity	± 0.25 dB (spherical isotropy error)	
Dynamic Range	10 mA/m to 2 A/m at 1 GHz	
E-Field Interference	< 10% at 3 GHz (for plane wave)	
Dimensions	Overall length: 330 mm (Tip: 40mm) Tip diameter: 6 mm (Body: 12 mm) Distance from probe tip to dipole centers: 3 mm The closest part of the sensor element is 1.9 mm closer to the tip	

3.2 Phantom & Device Holder



Figure 2. HAC Phantom & Device Holder

The Test Arch phantom should be positioned horizontally on a stable surface. Reference markings on the Phantom allow the complete setup of all predefined phantom positions and measurement grids by manually teaching three points in the robot.

The devices can be easily, accurately, and repeatably positioned according to the FCC specifications.

3.3 Robotic System Specifications

Specifications

POSITIONER:	Stäubli Unimation Corp. Robot Model: RX90LB
Repeatability:	0.02 mm
No. of axis:	6
Data Acquisition Electronic (DAE) System	
Cell Controller	
Processor:	Pentium IV
Clock Speed:	3.0 GHz
Operating System:	Windows XP
Data Card:	DASY4 PC-Board
Data Converter	
Features:	Signal Amplifier, multiplexer, A/D converter, and control logic
Software:	DASY4 software
Connecting Lines:	Optical downlink for data and status info. Optical uplink for commands and clock
PC Interface Card	
Function:	24 bit (64 MHz) DSP for real time processing Link to DAE3 16 bit A/D converter for surface detection system serial link to robot direct emergency stop output for robot

4. EUT ARRANGEMENT

4.1 WD RF Emission Measurements Reference and Plane

Figure 3. Illustrate the references and reference plane that shall be used in the WD emissions measurement.

- The grid is 5 cm by 5 cm area that is divided into 9 evenly sized blocks or sub-grids.
- The grid is centered on the audio frequency output transducer of the WD (speaker or T-coil).
- The grid is in a reference plane, which is defined as the planar area that contains the highest point in the area of the phone that normally rests against the user's ear. It is parallel to the centerline of the receiver area of the phone and is defined by the points of the receiver-end of the WD handset, which, in normal handset use, rest against the ear.
- The measurement plane is parallel to, and 1.0 cm in front of, the reference plane.

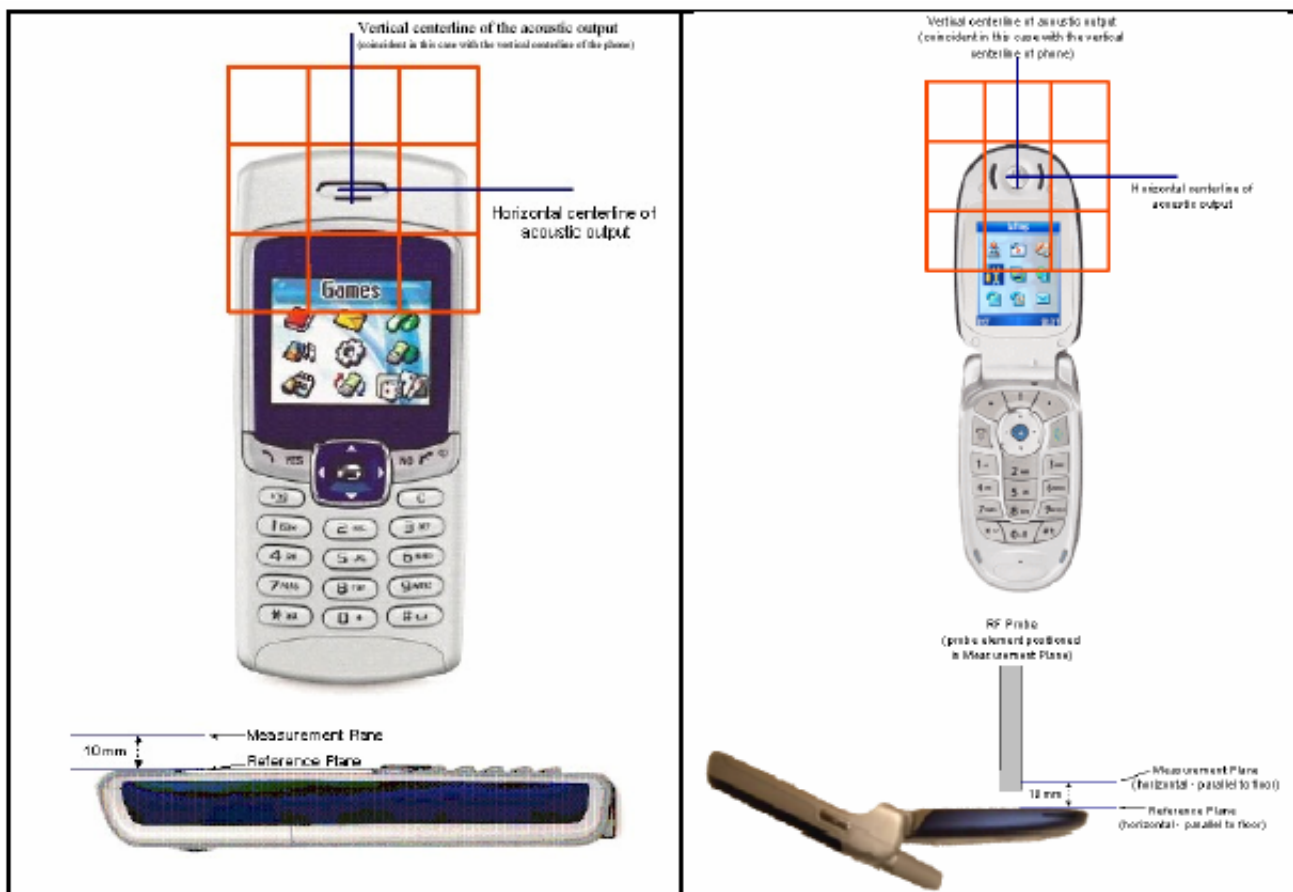

Figure 3. WD reference and plane for RF emission measurements

5. SYSTEM VALIDATION

The test setup was validated when configured and verified periodically thereafter to ensure proper function. The procedure is a validation procedure using dipole antennas for which the field levels were computed by FDTD modeling.

5.1 Validation Procedure

Place a dipole antenna meeting the requirements given in ANSI-PC63.19 in the position normally occupied by the WD. The dipole antenna serves as a known source for an electrical and magnetic output. Position the E-field and H-field probes so that:

- the probes and their cables are parallel to the coaxial feed of the dipole antenna
- the probe cables and the coaxial feed of the dipole antenna approach the measurement area from opposite directions; and
- the probes are 10 mm from the surface of the dipole elements.

Scan the length of the dipole with both E-field and H-field probes and record the maximum values for each. Compare the readings to expected values.

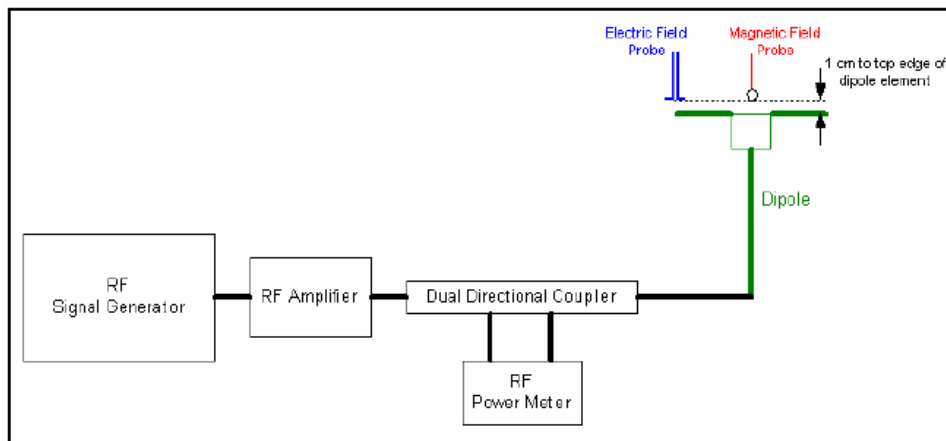

Figure 5. WD dipole calibration procedure

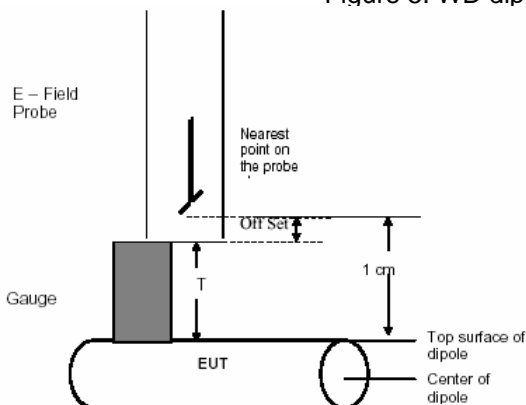

Figure 6. Gauge Block with E-Field Probe

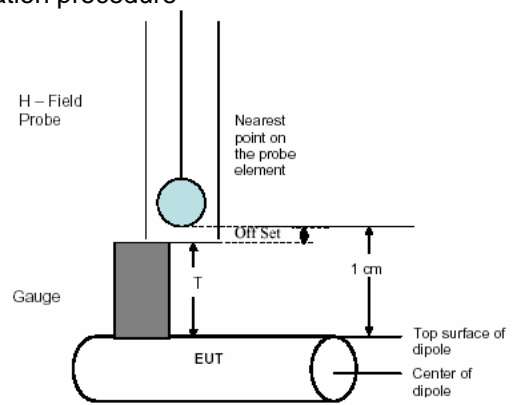

Figure 7. Gauge Block with H-Field Probe

5.2 Validation Result

5.2.1 E-Field Scan

Mode	Freq. [MHz]	Input Power (dBm)	Measured Value (V/m)	Target Value (V/m) SPEAG	Deviation [%]	Limit [%]
CW	835	20	167.15	163.3	+2.36	±25
CW	1880	20	147.75	138.9	+6.37	±25

5.2.2 H-Field Scan

Mode	Freq. [MHz]	Input Power (dBm)	Measured Value (A/m)	Target Value (A/m) SPEAG	Deviation [%]	Limit [%]
CW	835	20	0.463	0.453	+2.21	±25
CW	1880	20	0.479	0.462	+3.68	±25

Notes:

- 1) Deviation (%) = $100 * (\text{Measured value} - \text{Target value}) / \text{Target value}$.
ANSI-PC63.19 requires values to be within 25% of their targets. 12% is deviation and 13% is measurement uncertainty.
- 2) The maximum E-field or H-field were evaluated and compared to the target values provided by SPEAD in the calibration certificate of specific dipoles.
- 3) Please refer to the attachment for detailed measurement data and plot.

6. Probe Modulation Factor

A calibration was made of the modulation response of the probe and its instrumentation chain. This calibration was performed with the field probe, attached to its instrumentation. The response of the probe system to a CW field at the frequency of interest is compared to its response to a modulated signal with equal peak amplitude to that of a CW signal. The field level of the test signals are ensured to be more than 10 dB above the ambient level and the noise floor of the instrumentation being used. The ratio of the CW reading to that taken with a modulated reading was applied to the DUT measurements.

All voice modes for this device have been investigated in this section of the report. According to the FCC 3G Measurement Procedures, May 2006 for RF Emissions, variations in peak field and power readings.

This was done using the following procedure:

1. The probe was illuminated with a CW signal at the intended measurement frequency and wireless device power.
2. The probe was positioned at the field maxima over the dipole antenna (determined after an area scan over the dipole) illuminated with the CW signal.
3. The reading of the probe measurement system of the CW signal at the maximum point was recorded.
4. Using a Spectrum Analyzer, the modulated signal adjusted with the same peak level of the CW signal was determined.
5. The probe measurement system reading was recorded with the modulated signal. The appropriate system crest factors for the modulation type were configured in the software to the system measurements.
6. The ratio of the CW reading to modulated signal reading is the probe modulation factor (PMF) for the modulation and field probe combination. This was repeated for 80% AM.
7. Steps 1-6 were repeated at all frequency bands and for both E and H field probes.

The modulation factors obtained were applied to readings taken of the actual wireless device, in order to obtain an accurate peak field reading using the formula:

$$\text{Peak} = 20 \cdot \log (\text{Raw} \cdot \text{PMF})$$

This method correlates well with the modulation using the DUT in the alternative substitution method. See below for correlation of signal:

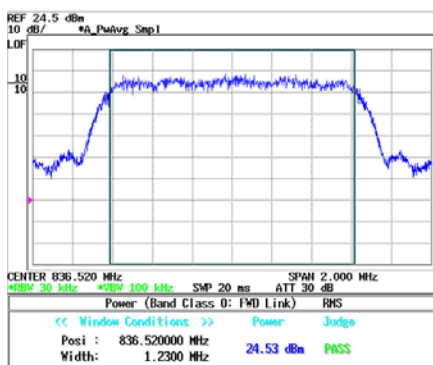

Figure 19

Signal Generator Modulated Signal

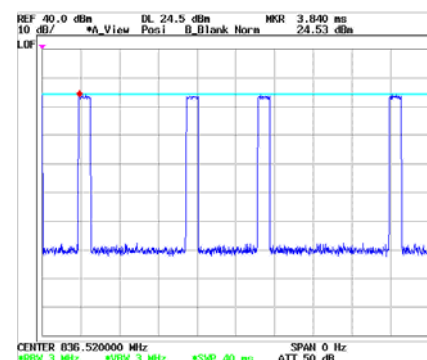

Figure 20

Wireless Device Modulated Signal

6.2 Modulation Factor

6.2.1 E-Field

Mode	Freq. [MHz]	Input Power (dB)	E-Field measured value (V/m)	Probe Modulation Factor
CW	835	25.0	238.7	-
80% AM		25.0	148.8	1.604
CDMA (Full Rate)		25.0	249.7	0.96
CDMA (1/8 Rate)		25.0	86.5	2.76
CW	1880	25.0	255.3	-
80% AM		25.0	162.6	1.57
CDMA (Full Rate)		25.0	265.9	0.95
CDMA (1/8 Rate)		25.0	87.5	2.91

6.2.2 H-Field

Mode	Freq. [MHz]	Input Power (dB)	H-Field measured value (A/m)	Probe Modulation Factor
CW	835	25.0	0.950	-
80% AM		25.0	0.653	1.45
CDMA (Full Rate)		25.0	1.12	0.848
CDMA (1/8 Rate)		25.0	0.34	2.79
CW	1880	25.0	0.904	-
80% AM		25.0	0.6731	1.34
CDMA (Full Rate)		25.0	1.118	0.808
CDMA (1/8 Rate)		25.0	0.318	2.84

Notes:

- 1) Modulation Factor = CW / WD_CDMA

6.2.3 PMF Peak Power Measurement Plots

Probe Modulation Factor (CW)

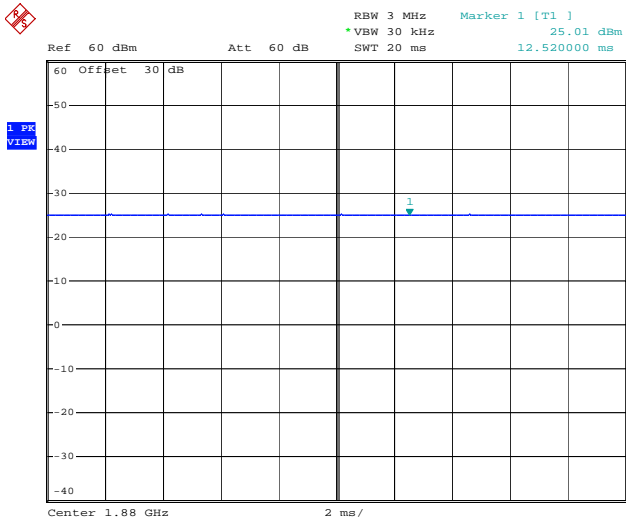

Comment: CW_83MHz
Date: 15.DEC.2006 08:38:35

Probe Modulation Factor (AM 80%)

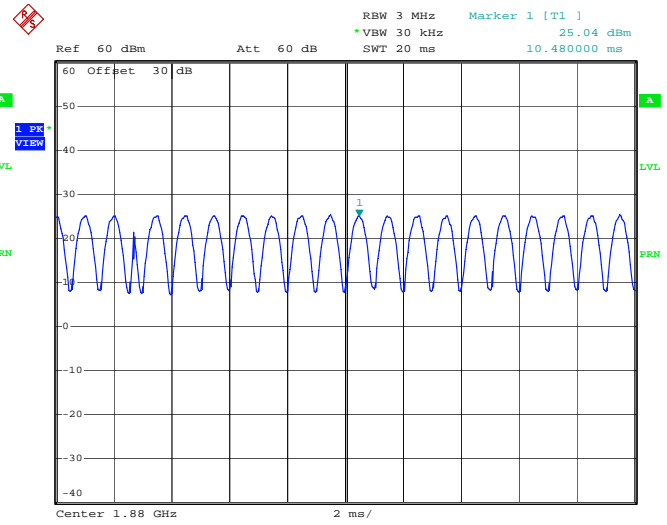

Date: 15.DEC.2006 09:28:04

Probe Modulation Factor (CDMA: full rate)

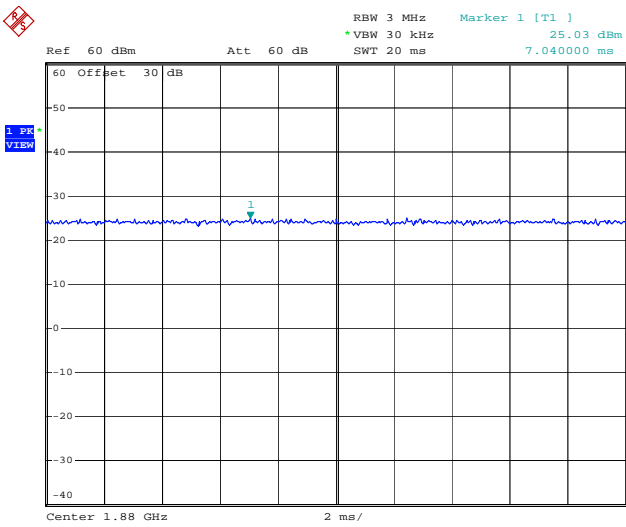

Date: 15.DEC.2006 09:17:16

Probe Modulation Factor (CDMA: 1/8 rate)

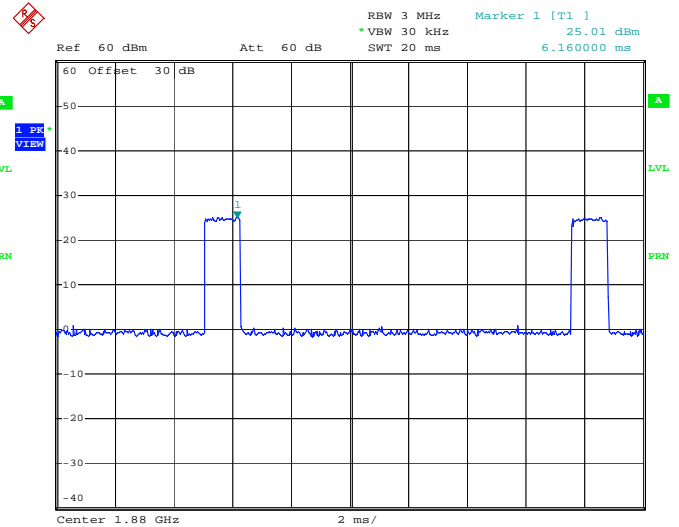

Date: 15.DEC.2006 09:18:54

Spectrum Analyzer Settings

- Input Power: 25.0dBm
- RBW: 3MHz
- Video Bandwidth: 30 kHz
- Span: Zero
- Sweep Time: 20ms
- Detection: Peak detection

7. FCC 3G MEASUREMENTS – MAY / JUNE 2006

Sample pre-testing of the various modes were performed at the worst case probe location as part of subset testing justification. See below for measured conducted power for applicable device modes:

7.1 Handset Measured Conducted Powers

FCC 3G Measured Conducted Powers for FCC ID: PP40VAL

Mode	CDMA800 (ch384)		CDMA1900 (ch600)	
	Peak (dBm)	Average (dBm)	Peak (dBm)	Average (dBm)
RC1, SO2, Full Rate	28.72	24.86	28.47	24.86
RC1, SO55, Full Rate	28.70	24.83	28.44	24.87
RC2, SO9, Full Rate	28.68	24.85	28.41	24.88
RC2, SO55, Full Rate	28.69	24.87	28.40	24.83
RC3, SO2, Full Rate	28.65	24.92	28.36	24.86
RC3, SO55, Full Rate	28.67	24.91	28.34	24.88
RC43, SO2, Full Rate	28.64	24.90	28.31	24.79
RC43, SO55, Full Rate	28.62	24.87	28.29	24.83
RC54, SO9, Full Rate	28.60	24.86	28.27	24.85
RC54, SO55, Full Rate	28.55	24.85	28.28	24.83
RC3, SO32, (+ F-SCH) Full Rate	28.49	24.91	28.25	24.85
RC3, SO32, (+ SCH) Full Rate	28.45	24.87	28.21	24.82

7.2 Worst-Case Probe Location Measurements

Below are RC/SO mode investigation results of the device at the worst-case (maximum) field point location. The worst-case RC/SO was used for T-coil testing.

Mode	Channel	SO	Antenna	Conducted Power (dBm)	Time Avg. Field (A/m)	Peak Field (dBV/m)	FCC Limit (dBV/m)	FCC MARGIN (dB)	RESULT
PCS	1175	SO2/RC1	Intenna	24.98	49.1	33.4	41	-7.62	M4
PCS	1175	SO3/RC1	Intenna	24.96	20.6	35.6	41	-5.44	M4
PCS	1175	SO55/RC1	Intenna	24.97	50.7	33.7	41	-7.35	M4
PCS	1175	SO9/RC2	Intenna	24.97	50.9	33.7	41	-7.31	M4
PCS	1175	SO17/RC2	Intenna	24.99	17.5	24.4	41	-16.58	M4
PCS	1175	SO2/RC3	Intenna	24.96	50.8	33.7	41	-7.33	M4
PCS	1175	SO3/RC3	Intenna	24.97	51.4	33.8	41	-7.23	M4
PCS	1175	SO55/RC3	Intenna	24.98	52.6	34.0	41	-7.03	M4

8. TEST PROCEDURE

Test Instructions

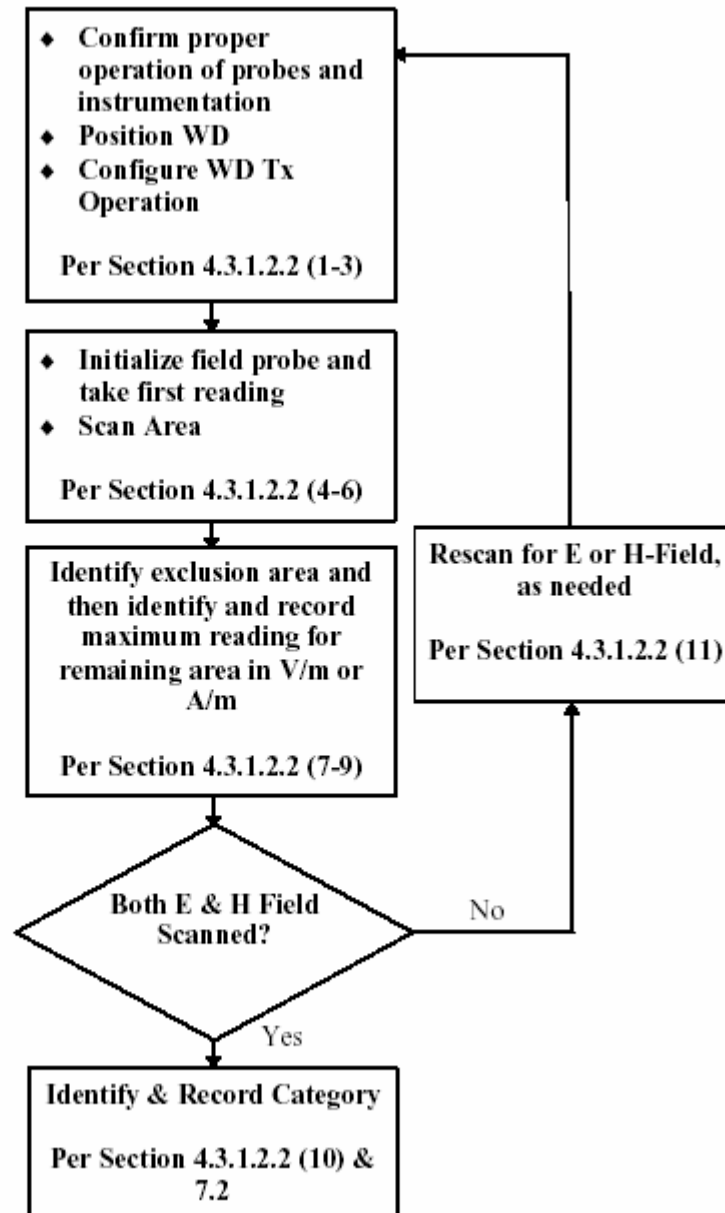

Figure 9. WD near-field emission automated test flowchart

The evaluation was performed with the following procedure:

1. Confirm proper operation of the field probe, probe measurement system and other instrumentation and the positioning system.
2. Position the WD in its intended test position. The gauge block, depicted in Section A.2.1, can simplify this positioning. Note that a separate E- and H-field gauge block will be needed if the edges of the probe sensors are at different distances from the tip of the probe.
3. Configure the WD normal operation for maximum rated RF output power, at the desired channel and other operating parameters, (e.g. call simulation) as intended for the test.
4. The center sub-grid shall be centered on the center of the WD output (acoustic or T-Coil output), as appropriate. Locate the field probe at the initial test position in the 5 x 5 cm grid, which is contained in the measurement plane.
5. Record the reading.
6. Scan the entire 5 x 5 cm region in equally spaced increments and record the reading at each measurement point. The distance between measurement points shall be sufficient to assure the identification of the peak reading.
7. Identify the five contiguous sub-grids around the center sub-grid with the lowest maximum field strength readings. Thus the 6 areas to be used to determine the WD's peak emissions are identified and outlined for the final manual scan. Please note that a maximum of five blocks can be excluded for both E- and H-field measurements for the WD output being measured. State another way, the center sub-grid and 3 other must be common to both the E- and H-field measurements.
8. Identify the highest field reading within the non-excluded sub-grids identified in step 7.
9. Convert the highest field strength reading identified in step 8 to peak V/m or A/m, as appropriate. This conversion shall be done using the appropriate probe modulation factor.
10. Repeat steps 1-10 for both the E- and H-field measurements.
11. Compare this reading to the categories in ANSI-PC63.19 and record the resulting category. The lowest category number listed in ANSI-PC63.19, obtained in step 10 for either E or H field determines the M category for the audio coupling mode assessment. Record the WD category rating.

9. ANSI/IEEE C63.19 PERFORMANCE CATEGORIES

The EUT must meet the following M3 or M4 category:

Category	Telephone RF Parameters		
Near Field	AWF (dB)	E-Field Emissions dB (V/m)	H-Field Emissions(V/m)
Frequency < 960 MHz			
M1	0	56 to 61	+5.6 to +10.6
	-5	53.5 to 58.5	+3.1 to +8.1
M2	0	51 to 56	+0.6 to +5.6
	-5	48.5 to 53.5	-1.9 to +3.1
M3	0	46 to 51	-4.4 to +0.6
	-5	43.5 to 48.5	-6.9 to -1.9
M4	0	< 46	< -4.4
	-5	< 43.5	< -6.9
Frequency > 960 MHz			
M1	0	46 to 51	-4.4 to 0.6
	-5	43.5 to 48.5	-6.9 to -1.9
M2	0	41 to 46	-9.4 to -4.4
	-5	38.5 to 43.5	-11.9 to -6.9
M3	0	36 to 41	-14.4 to -9.4
	-5	33.5 to 38.5	-16.9 to -11.9
M4	0	<36	<-14.4
	-5	<33.5	<-16.9

Table 1. Telephone near-field categories in linear units

10. MEASUREMENT UNCERTAINTIES

HAC Uncertainty Budget [According to ANSI C63.19]								
Error Description	Uncertainty (%)	Probability Distribution	Divisor	ci (E)	ci (H)	Standard Uncertainty (E)	Standard Uncertainty (H)	Notes
Measurement system								
Probe Calibration	5.1%	Normal	1.00	1	1	5.1%	5.1%	
Axial Isotropy	4.7%	Rectangular	1.73	1	1	2.7%	2.7%	*
Sensor Displacement	16.5%	Rectangular	1.73	1	0.145	9.5%	1.4%	*
Boundary effect	2.4%	Rectangular	1.73	1	1	1.4%	1.4%	*
Field Probe Frequency Response	3.2%	Normal	1.00	1	1	3.2%	3.2%	
Linearity	4.7%	Rectangular	1.73	1	1	2.7%	2.7%	*
Scaling to peak Envelope Power	2.0%	Rectangular	1.73	1	1	1.2%	1.2%	*
System Detection limits	1.0%	Rectangular	1.73	1	1	0.6%	0.6%	*
Readout Electronics	0.3%	Normal	1.00	1	1	0.3%	0.3%	*
Response time	0.8%	Rectangular	1.73	1	1	0.5%	0.5%	*
Integration time	2.6%	Rectangular	1.73	1	1	1.5%	1.5%	*
RF Ambient Conditions	3.0%	Rectangular	1.73	1	1	1.7%	1.7%	*
RF Reflections	12.0%	Rectangular	1.73	1	1	6.9%	6.9%	*
Probe positioner	1.2%	Rectangular	1.73	1	0.67	0.7%	0.5%	*
Probe positioning	4.7%	Rectangular	1.73	1	0.67	2.7%	1.8%	*
Extrap. And Interpolation	1.0%	Rectangular	1.73	1	1	0.6%	0.6%	*
Test Sample Related								
Test Positioning Vertical	4.7%	Rectangular	1.73	1	0.67	2.7%	1.8%	*
Test Positioning Lateral	1.0%	Rectangular	1.73	1	1	0.6%	0.6%	*
Device Holder and Phantom	2.4%	Rectangular	1.73	1	1	1.4%	1.4%	*
Power drift	5.0%	Rectangular	1.73	1	1	2.9%	2.9%	*
Phantom and Setup Related								
Phantom Thickness	2.4%	Rectangular	1.73	1	0.67	1.4%	0.9%	*
Combined standard Uncertainty (%)						15.0%	11.1%	
Expanded standard Uncertainty (%)						30.1%	22.3%	

Table 2. Uncertainties

Notes:

1. Worst-Case uncertainty budget for HAC free field assessment according to ANSI-C 63.19[1].The budget is valid for the frequency range 800MHz-3GHz and represents a worst-Case analysis. For specific test sand configurations, the uncertainty could be considerably smaller. Some of the parameters are dependent on the user situations and need adjustment according to the actual laboratory conditions.

2. * Uncertainty specifications from Schmidt & Partner Engineering AG (not site specific)

11. HAC TEST DATA SUMMARY

Ambient TEMPERATURE (°C): 21.6
 S/N: PCCOVAL-1

11.1 Measurement Results (E-Field CDMA / PCS DATA)

Mode	Channel	Backlight	SO	Antenna	Conducted Power (dBm)	Time Avg. Field (V/m)	Peak Field (dBV/m)	FCC Limit (dBV/m)	FCC MARGIN (dB)	Exclusion Block	RESULT
CDMA	1013	off	SO55/RC3	Intenna	24.84	76.3	37.3	51	-13.70	none	M4
CDMA	384	off	SO55/RC3	Intenna	24.83	88.1	38.5	51	-12.46	none	M4
CDMA	777	off	SO55/RC3	Intenna	24.85	77.7	37.5	51	-13.55	none	M4
PCS	25	off	SO55/RC3	Intenna	24.97	47.4	33.1	41	-7.93	none	M4
PCS	600	off	SO55/RC3	Intenna	24.92	45.8	32.8	41	-8.23	none	M4
PCS	1175	off	SO55/RC3	Intenna	24.83	49.7	33.5	41	-7.52	none	M4
PCS	1175	on	SO55/RC3	Intenna	24.85	47.0	33.0	41	-8.00	none	M4

NOTES:

1. All modes of operation were investigated and the worst-case are reported.
2. Battery Type Standard Extended Fixed
3. Power Measured Conducted EIRP ERP
4. Test Signal Call Mode Manual Test cord Base Station Simulator
5. SAR Measurement System SPEAG

11. HAC TEST DATA SUMMARY

Ambient TEMPERATURE (°C): 21.6

S/N: PCCOVAL-1

11.4 Measurement Results (H-Field CDMA / PCS DATA)

Mode	Channel	Backlight	SO	Antenna	Conducted Power (dBm)	Time Avg. Field (A/m)	Peak Field (dBA/m)	FCC Limit (dBA/m)	FCC MARGIN (dB)	Exclusion Block	RESULT
CDMA	1013	off	SO55/RC3	Intenna	24.83	0.142	-18.4	0.6	-18.99	none	M4
CDMA	384	off	SO55/RC3	Intenna	24.85	0.165	-17.1	0.6	-17.68	none	M4
CDMA	777	off	SO55/RC3	Intenna	24.90	0.150	-17.9	0.6	-18.51	none	M4
PCS	25	off	SO55/RC3	Intenna	24.92	0.131	-19.5	-9.4	-10.11	none	M4
PCS	600	off	SO55/RC3	Intenna	24.93	0.137	-19.1	-9.4	-9.72	none	M4
PCS	1175	off	SO55/RC3	Intenna	24.85	0.146	-18.6	-9.4	-9.16	none	M4

NOTES:

- All modes of operation were investigated and the worst-case are reported.
- Battery Type Standard Extended Fixed
- Power Measured Conducted EIRP ERP
- Test Signal Call Mode Manual Test cord Base Station Simulator
- SAR Measurement System SPEAG

11. HAC TEST DATA SUMMARY

Ambient TEMPERATURE (°C): 21.6

S/N: PCCOVAL-1

11.5 Worst-case Configuration Evaluation

Peak Reading 360° Probe Rotation at Azimuth axis

Mode	Channel	Backlight	SO	Antenna	Conducted Power (dBm)	Time Avg. Field (V/m)	Peak Field (dBV/m)	FCC Limit (dBV/m)	FCC MARGIN (dB)	Exclusion Block	RESULT
PCS	1175	off	SO55/RC3	Intenna	24.96	49.7	33.5	41	-7.52	none	M4



Worst-Case Probe Rotation about Azimuth axis

12. HAC TEST EQUIPMENT LIST

Type / Model	Calib. Date	S/N
Staubli Robot RX90L	N/A	F01/ 5K09A1/A/01
Staubli Robot ControllerCS7MB	N/A	F99/5A82A1/C/01
Staubli Teach Pendant (Joystick)	N/A	D221340.01
Dell OptiPlex GX100	N/A	HY4640
Windows NT 4.0	N/A	-
SPEAG DAE3V1	March 06	446
SPEAG DAE4V1	Feb. 06	447
SPEAG E-Field Probe	April 06	2343
SPEAG H-Field Probe	July 06	6101
SPEAG HAC Phantom	N/A	-
SPEAG Light Alignment Sensor	N/A	265
SPEAG Validation Dipole D835V2	March 06	1024
SPEAG Validation Dipole D1880V2	March 06	1019
Phone Holder	N/A	-
A/B Power Indicator	N/A	-
Remote Power Switch	N/A	-

NOTE:

The E-field, H-field probe was calibrated by SPEAG. Dipole Validation measurement is performed by HCT Lab. before each test. The following list of equipment was used to :

Power Meter(A)	E4419B	June 06	MY40511244
Power Sensor(A)	8481	June 06	MY41090680
Signal Generator	8664A (100kHz ~ 3GHz)	April 06	3744A02069
Power Amp	A0825-4343-R	Sep. 06	A00450
Dual Directional Coupler	778D	August 06	16072
Power divider	1506A	Jan. 06	MD793
Base Station Simulator	E5515C	May 06	US41070189
Network Analyzer	8753ES (30KHz ~ 6GHz)	April06	JP39240221
Base Station	CMU200	March 06	110740
Base Station	NJZ-2000	May 06	ET00117
Bluetooth Simulator	TC-3000	Jan 06	3000A490112
Signal Generator	E4438C	August 06	MY45092381
Spectrum Analyzer	R3273	April06	J004821

13. CONCLUSION

The HAC measurement indicates that the EUT complies with the HAC limits of the ANSI-PC63.19-2006.

These measurements are taken to simulate the RF effects exposure under worst-case conditions. Precise Laboratory measures were taken to assure repeatability of the tests.

Appendix 1

HAC Data Plots

Test Laboratory: HCT
 Ambient Temperature : 21.6 °C
 Date Tested : December 13, 2006

DUT: HAC-Dipole 835 MHz; Type: D835V3; Serial: 1024
Program Name: HAC E Dipole

Communication System: CW; Frequency: 835 MHz; Duty Cycle: 1:1
 Medium parameters used: $\sigma = 0$ mho/m, $\epsilon_r = 1$; $\rho = 1000$ kg/m³
 Phantom section: E Dipole Section ; Measurement SW: DASY4, V4.7 Build 44

DASY4 Configuration:
 - Probe: ER3DV6 - SN2343; ConvF(1, 1, 1); Calibrated: 2006-03-23
 - Sensor-Surface: (Fix Surface)
 - Electronics: DAE4 Sn447; Calibrated: 2006-11-17
 - Phantom: HAC Test Arch; Type: SD HAC P01 BA

E Scan 10mm above CD 835 MHz/Hearing Aid Compatibility Test (41x361x1):

Measurement grid: dx=5mm, dy=5mm
 Maximum value of peak Total field = 168.0 V/m
 Probe Modulation Factor = 1.00
 Reference Value = 123.5 V/m; Power Drift = -0.050 dB
Hearing Aid Near-Field Category: M2 (AWF 0 dB)

Peak E-field in V/m

Grid 1	Grid 2	Grid 3
164.6	166.3	160.5
Grid 4	Grid 5	Grid 6
87.8	91.3	88.3
Grid 7	Grid 8	Grid 9
159.4	168.0	161.7

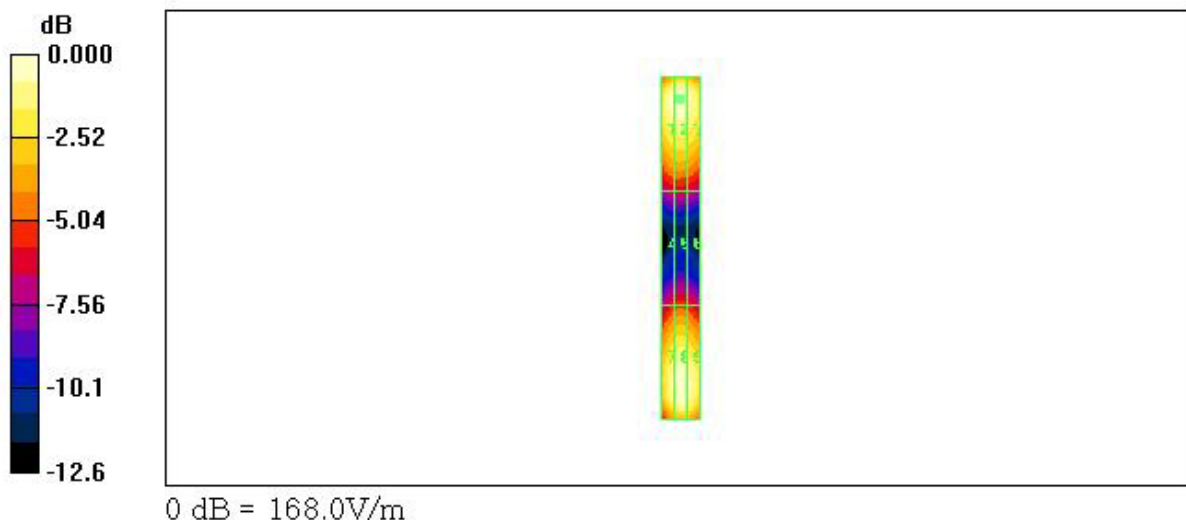

Test Laboratory: HCT
 Ambient Temperature : 21.6 °C
 Date Tested : December 13, 2006

DUT: HAC Dipole 1880 MHz; Type: CD1880V3; Serial: 1019
Program Name: HAC H Dipole

Communication System: CW; Frequency: 1880 MHz; Duty Cycle: 1:1
 Medium parameters used: $\sigma = 0$ mho/m, $\epsilon_r = 1$; $\rho = 1000$ kg/m³
 Phantom section: E Dipole Section ; Measurement SW: DASY4, V4.7 Build 44

DASY4 Configuration:
 - Probe: ER3DV6 - SN2343; ConvF(1, 1, 1); Calibrated: 2006-03-23
 - Sensor-Surface: (Fix Surface)
 - Electronics: DAE4 Sn447; Calibrated: 2006-11-17
 - Phantom: HAC Test Arch; Type: SD HAC P01 BA

E Scan 10mm above CD 1880 MHz/Hearing Aid Compatibility Test (41x181x1):

Measurement grid: dx=5mm, dy=5mm
 Maximum value of peak Total field = 148.4 V/m
 Probe Modulation Factor = 1.00
 Reference Value = 150.7 V/m; Power Drift = 0.007 dB
Hearing Aid Near-Field Category: M2 (A WF 0 dB)

Peak E-field in V/m

Grid 1	Grid 2	Grid 3
130.7	147.1	146.9
Grid 4	Grid 5	Grid 6
87.4	97.5	97.4
Grid 7	Grid 8	Grid 9
133.7	148.4	148.4

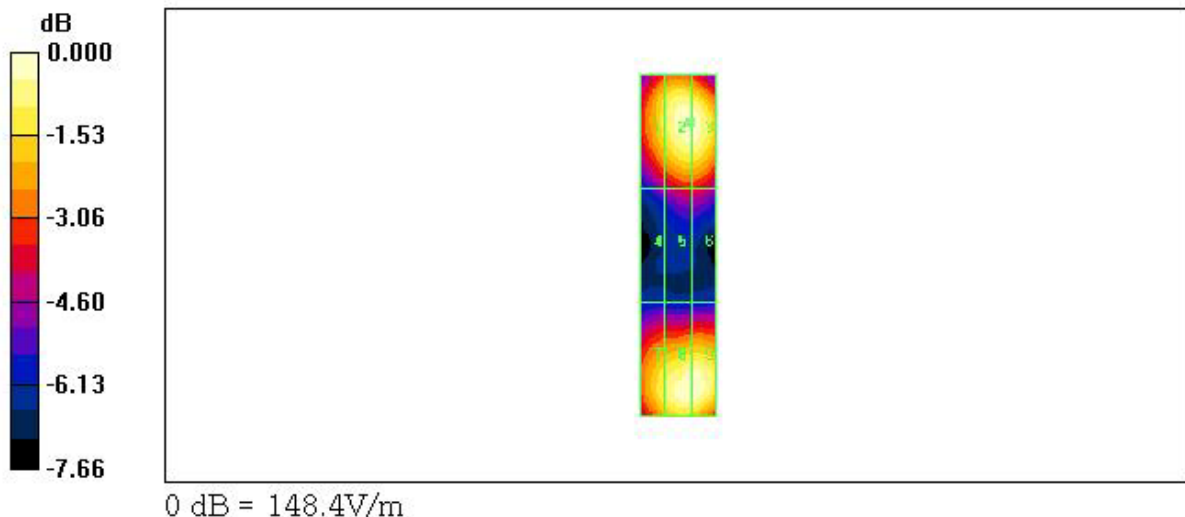

Test Laboratory: HCT
 Ambient Temperature : 21.6°C
 Date Tested : December 13, 2006

DUT: HAC-Dipole 835 MHz; Type: D835V3; Serial: 1024
Program Name: HAC E Dipole

Communication System: CW; Frequency: 835 MHz; Duty Cycle: 1:1
 Medium parameters used: $\sigma = 0$ mho/m, $\epsilon_r = 1$; $\rho = 1$ kg/m³
 Phantom section: E Dipole Section ; Measurement SW: DASY4, V4.7 Build 44

DASY4 Configuration:
 - Probe: H3DV6 - SN6101; ; Calibrated: 2006-07-12
 - Sensor-Surface: (Fix Surface)
 - Electronics: DAE4 Sn447; Calibrated: 2006-11-17
 - Phantom: HAC Test Arch; Type: SD HAC P01 BA

H Scan 10mm above CD 835 MHz/Hearing Aid Compatibility Test (41x361x1):

Measurement grid: dx=5mm, dy=5mm
 Maximum value of peak Total field = 0.463 A/m
 Probe Modulation Factor = 1.00
 Reference Value = 0.404 A/m; Power Drift = 0.024 dB
Hearing Aid Near-Field Category: M2 (A WF 0 dB)

Peak H-field in A/m

Grid 1	Grid 2	Grid 3
0.379	0.400	0.382
Grid 4	Grid 5	Grid 6
0.439	0.463	0.445
Grid 7	Grid 8	Grid 9
0.384	0.410	0.399

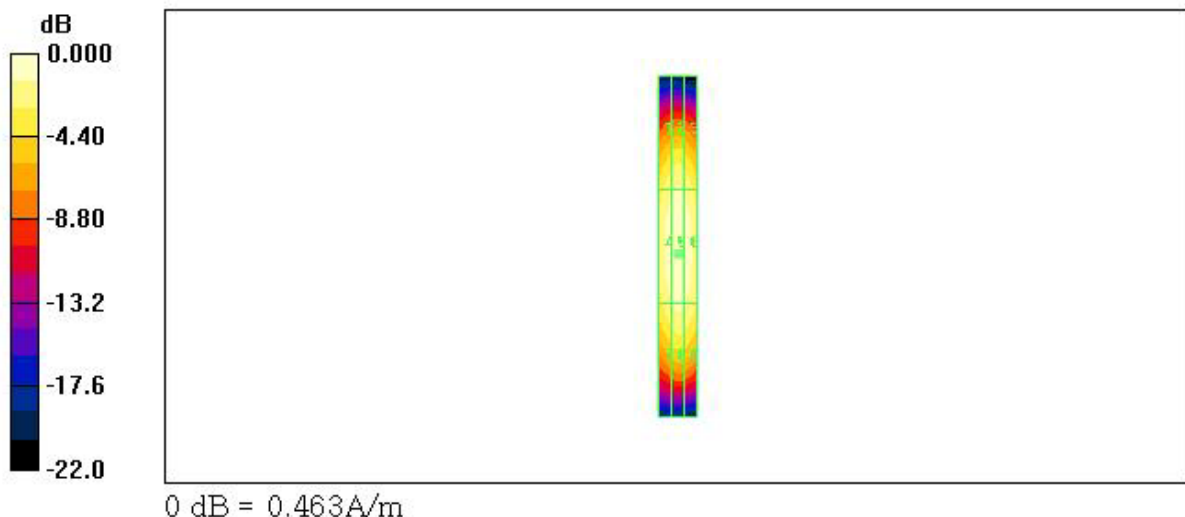

Test Laboratory: HCT
 Ambient Temperature : 21.6 °C
 Date Tested : December 13, 2006

DUT: HAC Dipole 1880 MHz; Type: CD1880V3; Serial: 1019
Program Name: HAC H Dipole

Communication System: CW; Frequency: 1880 MHz; Duty Cycle: 1:1
 Medium parameters used: $\sigma = 0$ mho/m, $\epsilon_r = 1$; $\rho = 1$ kg/m³
 Phantom section: H Dipole Section ; Measurement SW: DASY4, V4.7 Build 44

DASY4 Configuration:
 - Probe: H3DV6 - SN6101; ; Calibrated: 2006-07-12
 - Sensor-Surface: (Fix Surface)
 - Electronics: DAE4 Sn447; Calibrated: 2006-11-17
 - Phantom: HAC Test Arch; Type: SD HAC P01 BA

E Scan 10mm above CD 1880 MHz/Hearing Aid Compatibility Test (41x181x1):

Measurement grid: dx=5mm, dy=5mm
 Maximum value of peak Total field = 0.479 A/m
 Probe Modulation Factor = 1.00
 Reference Value = 0.490 A/m; Power Drift = -0.012 dB
Hearing Aid Near-Field Category: M2 (A WF 0 dB)

Peak H-field in A/m

Grid 1	Grid 2	Grid 3
0.393	0.427	0.418
Grid 4	Grid 5	Grid 6
0.441	0.479	0.469
Grid 7	Grid 8	Grid 9
0.405	0.447	0.437

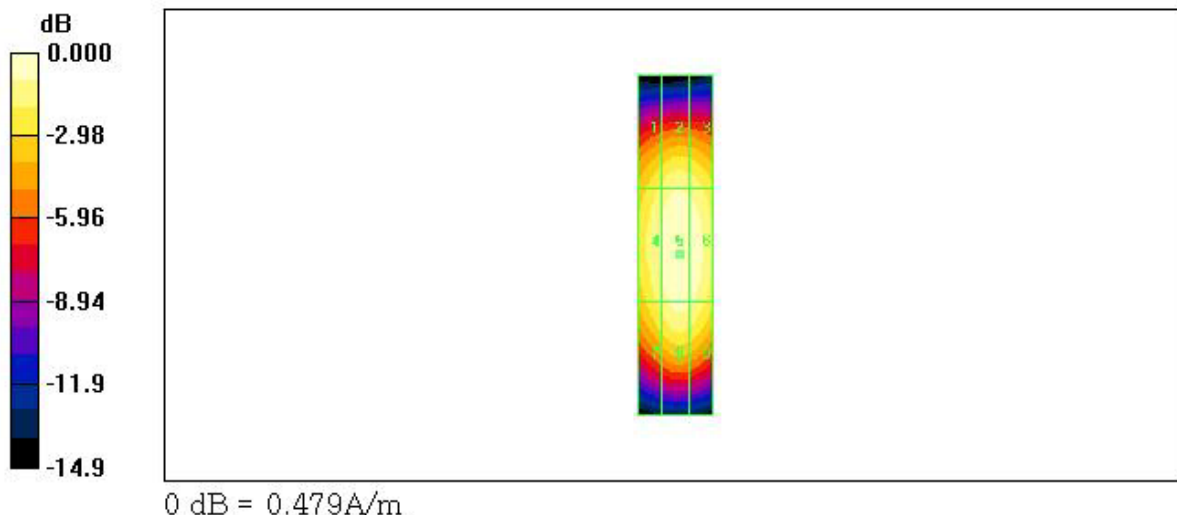

Test Laboratory: HCT
Ambient Temperature : 21.6℃
Date Tested : December 13, 2006

DUT: OVAL; Type: Folder; Serial: #1
Program Name: HAC E Device

Communication System: CDMA 835MHz FCC, Frequency: 836.52 MHz, Duty Cycle: 1:1
Medium parameters used: $\sigma = 0$ mho/m, $\epsilon_r = 1$; $\rho = 1000$ kg/m³
Phantom section: E Device Section ; Measurement SW: DASY4, V4.7 Build 44

DASY4 Configuration:

- Probe: ER3DV6 - SN2343; ConvF(1, 1, 1); Calibrated: 2006-03-23
- Sensor-Surface: (Fix Surface)
- Electronics: DAE4 Sn447; Calibrated: 2006-11-17
- Phantom: HAC Test Arch; Type: SD HAC P01 BA

E Scan 10mm above Device Reference/Hearing Aid Compatibility Test (101x101x1):

Measurement grid: dx=5mm, dy=5mm
Maximum value of peak Total field = 84.5 V/m
Probe Modulation Factor = 0.960
Reference Value = 90.2 V/m; Power Drift = -0.113 dB
Hearing Aid Near-Field Category: M4 (A WF 0 dB)

Peak E-field in V/m

Grid 1	Grid 2	Grid 3
66.6	72.6	71.1
Grid 4	Grid 5	Grid 6
76.5	84.5	82.6
Grid 7	Grid 8	Grid 9
73.2	80.5	78.1

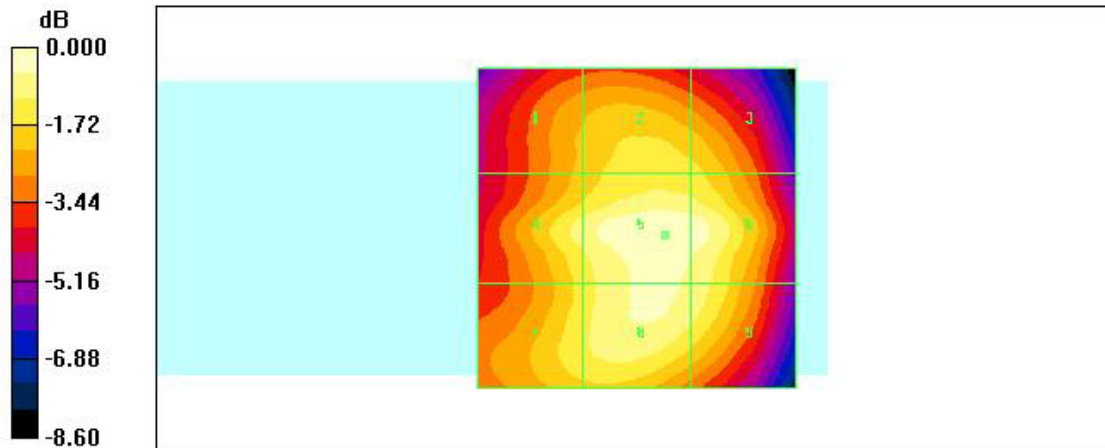

0 dB = 84.5V/m

Test Laboratory: HCT
 Ambient Temperature : 21.6°C
 Date Tested : December 13, 2006

DUT: OVAL; Type: Folder; Serial: #1
Program Name: HAC E Device

Communication System: PCS 1900MHz FCC; Frequency: 1908.75 MHz;Duty Cycle: 1:1
 Medium parameters used: $\sigma = 0$ mho/m, $\epsilon_r = 1$; $\rho = 1000$ kg/m³
 Phantom section: E Device Section ;Measurement SW: DASY4, V4.7 Build 44

DASY4 Configuration:
 - Probe: ER3DV6 - SN2343; ConvF(1, 1, 1); Calibrated: 2006-03-23
 - Sensor-Surface: (Fix Surface)
 - Electronics: DAE4 Sn447; Calibrated: 2006-11-17
 - Phantom: HAC Test Arch; Type: SD HAC P01 BA

E Scan 10mm above Device Reference/Hearing Aid Compatibility Test (101x101x1):

Measurement grid: dx=5mm, dy=5mm
 Maximum value of peak Total field = 47.2 V/m
 Probe Modulation Factor = 0.950
 Reference Value = 39.2 V/m; Power Drift = -0.180 dB
Hearing Aid Near-Field Category: M4 (A WF 0 dB)

Peak E-field in V/m

Grid 1	Grid 2	Grid 3
21.6	37.6	38.5
Grid 4	Grid 5	Grid 6
25.1	46.6	47.2
Grid 7	Grid 8	Grid 9
28.9	46.0	46.3

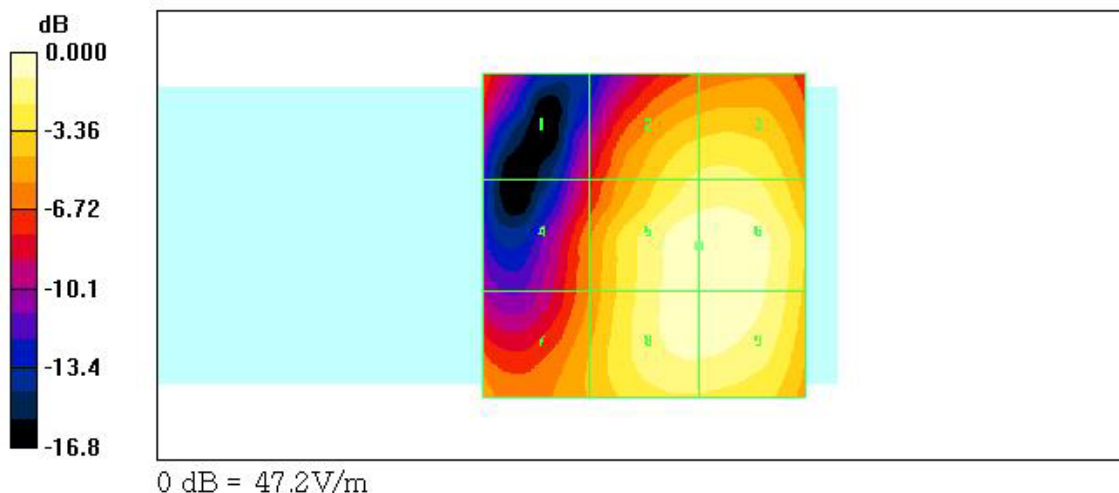

Test Laboratory: HCT
 Ambient Temperature : 21.6°C
 Date Tested : December 13, 2006

DUT: OVAL; Type: Folder; Serial: #1
Program Name: HAC H Device

Communication System: CDMA 835MHz FCC; Frequency: 836.52 MHz; Duty Cycle: 1:1
 Medium parameters used: $\sigma = 0 \text{ mho/m}$, $\epsilon_r = 1$; $\rho = 1 \text{ kg/m}^3$
 Phantom section: H Device Section ; Measurement SW: DASY4, V4.7 Build 44

DASY4 Configuration:
 - Probe: H3DV6 - SN6101; ; Calibrated: 2006-07-12
 - Sensor-Surface: (Fix Surface)
 - Electronics: DAE4 Sn447; Calibrated: 2006-11-17
 - Phantom: HAC Test Arch; Type: SD HAC P01 BA

H Scan 10mm above Device Reference/Hearing Aid Compatibility Test (101x101x1):

Measurement grid: dx=5mm, dy=5mm
 Maximum value of peak Total field = 0.140 A/m
 Probe Modulation Factor = 0.848
 Reference Value = 0.085 A/m; Power Drift = 0.016 dB
Hearing Aid Near-Field Category: M4 (A WF 0 dB)

Peak H-field in A/m

Grid 1	Grid 2	Grid 3
0.140	0.097	0.057
Grid 4	Grid 5	Grid 6
0.131	0.091	0.055
Grid 7	Grid 8	Grid 9
0.134	0.096	0.056

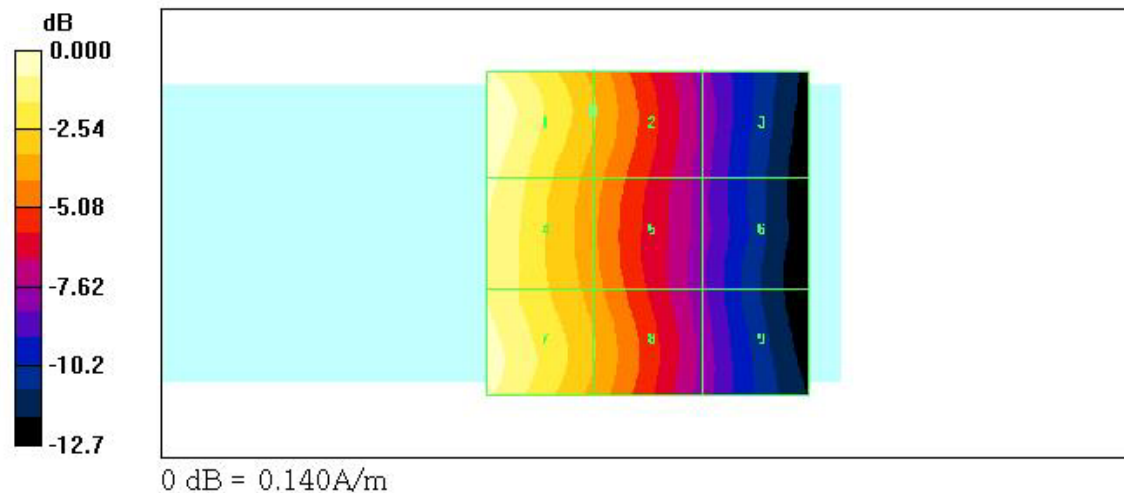

Test Laboratory: HCT
 Ambient Temperature : 21.6°C
 Date Tested : December 13, 2006

DUT: OVAL; Type: Folder; Serial: #1
Program Name: HAC H Device

Communication System: PCS 1900MHz FCC; Frequency: 1908.75 MHz; Duty Cycle: 1:1
 Medium parameters used: $\sigma = 0$ mho/m, $\epsilon_r = 1$; $\rho = 1$ kg/m³
 Phantom section: H Device Section ; Measurement SW: DASY4, V4.7 Build 44

DASY4 Configuration:
 - Probe: H3DV6 - SN6101; ; Calibrated: 2006-07-12
 - Sensor-Surface: (Fix Surface)
 - Electronics: DAE4 Sn447; Calibrated: 2006-11-17
 - Phantom: HAC Test Arch; Type: SD HAC P01 BA

H Scan 10mm above Device Reference/Hearing Aid Compatibility Test (101x101x1):

Measurement grid: dx=5mm, dy=5mm
 Maximum value of peak Total field = 0.118 A/m
 Probe Modulation Factor = 0.808
 Reference Value = 0.102 A/m; Power Drift = 0.072 dB
Hearing Aid Near-Field Category: M4 (A WF 0 dB)

Peak H-field in A/m

Grid 1	Grid 2	Grid 3
0.104	0.102	0.074
Grid 4	Grid 5	Grid 6
0.105	0.096	0.067
Grid 7	Grid 8	Grid 9
0.118	0.103	0.072

