

APPENDIX A: SAR TEST DATA

PCTEST ENGINEERING LABORATORY, INC.

DUT: XV620 with COMPAQ V4332US; Type: Dual Band CDMA Modem Card; Serial: 112

Communication System: Cellular CDMA; Frequency: 848.31 MHz; Duty Cycle: 1:1

Medium: 835 Muscle ($\sigma = 0.99$ mho/m, $\epsilon_r = 56.89$, $\rho = 1000$ kg/m³)

Phantom section: Flat Section; Space: 0.9 cm

Test Date: 03-28-2006; Ambient Temp: 23.5°C; Tissue Temp: 21.2°C

Probe: EX3DV4 - SN3561; ConvF(7.9, 7.9, 7.9); Calibrated: 8/24/2005

Sensor-Surface: 3mm (Mechanical Surface Detection)

Electronics: DAE4 Sn649; Calibrated: 9/13/2005

Phantom: SAM Main; Type: SAM 4.0; Serial: TP:1197

Measurement SW: DASY4, V4.6 Build 23; Postprocessing SW: SEMCAD, V1.8 Build 160

Mode: CDMA, Laptop position, High.ch, Ant.close

Area Scan (7x21x1): Measurement grid: dx=15mm, dy=15mm

Zoom Scan (5x5x7)/Cube 0: Measurement grid: dx=8mm, dy=8mm, dz=5mm

Reference Value = 31.7 V/m

Peak SAR (extrapolated) = 1.75 W/kg

SAR(1 g) = 0.996 mW/g; SAR(10 g) = 0.565 mW/g

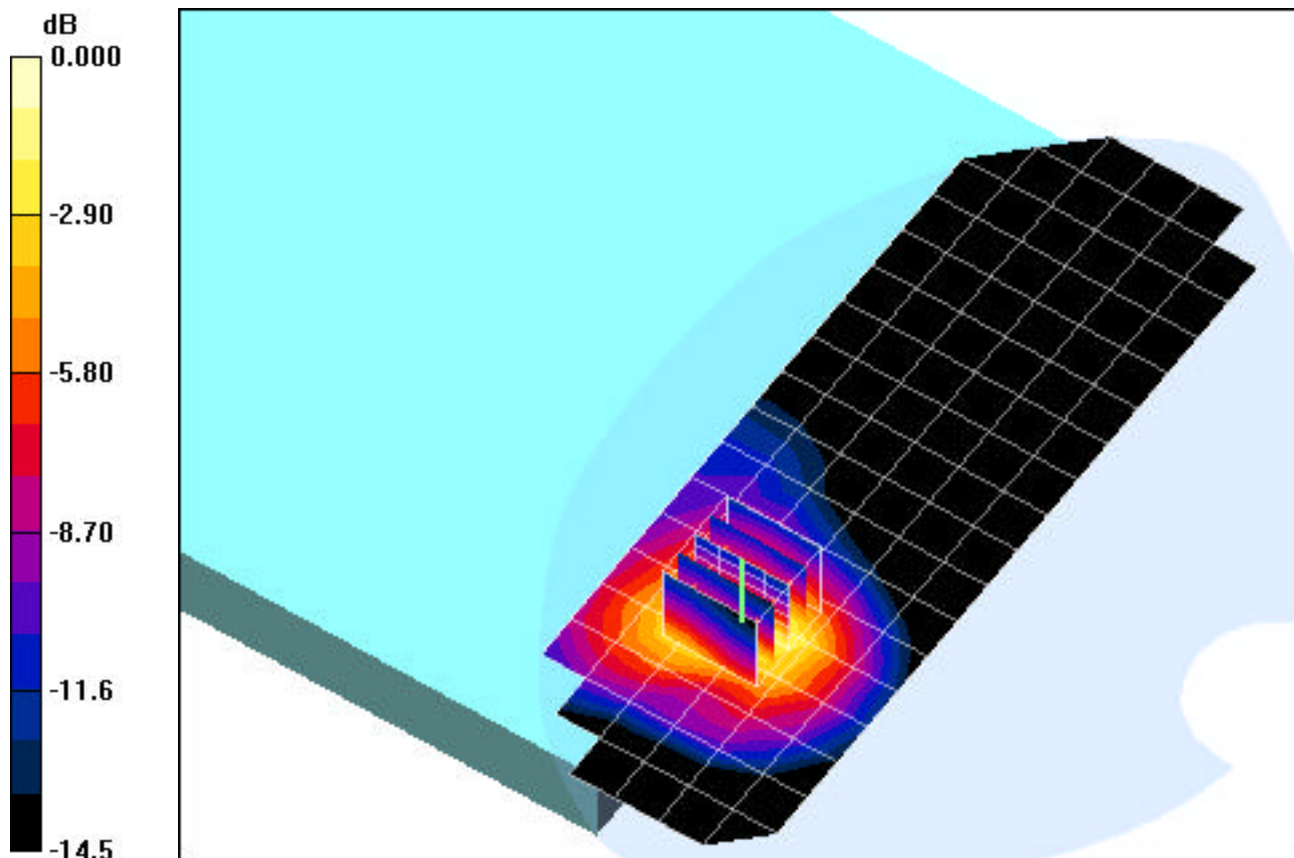

0 dB = 1.23mW/g

PCTEST ENGINEERING LABORATORY, INC.

DUT: XV620 with COMPAQ V4332US; Type: Dual Band CDMA Modem Card; Serial: 112

Communication System: PCS CDMA; Frequency: 1851.25 MHz; Duty Cycle: 1:1

Medium: 1900 Muscle ($\sigma = 1.57$ mho/m, $\epsilon_r = 52.64$, $\rho = 1000$ kg/m³)

Phantom section: Flat Section; Space: 0.9 cm

Test Date: 03-28-2006; Ambient Temp: 23.0°C; Tissue Temp: 21.5°C

Probe: EX3DV4 - SN3561; ConvF(6.48, 6.48, 6.48); Calibrated: 8/24/2005

Sensor-Surface: 3mm (Mechanical Surface Detection)

Electronics: DAE4 Sn649; Calibrated: 9/13/2005

Phantom: SAM Sub; Type: SAM 4.0; Serial: TP:1357

Measurement SW: DASY4, V4.6 Build 23; Postprocessing SW: SEMCAD, V1.8 Build 160

Mode: PCS, Laptop position, Low.ch, Ant.open

Area Scan (9x21x1): Measurement grid: dx=15mm, dy=15mm

Zoom Scan (5x5x7)/Cube 0: Measurement grid: dx=8mm, dy=8mm, dz=5mm

Reference Value = 7.45 V/m

Peak SAR (extrapolated) = 1.84 W/kg

SAR(1 g) = 1.14 mW/g; SAR(10 g) = 0.639 mW/g

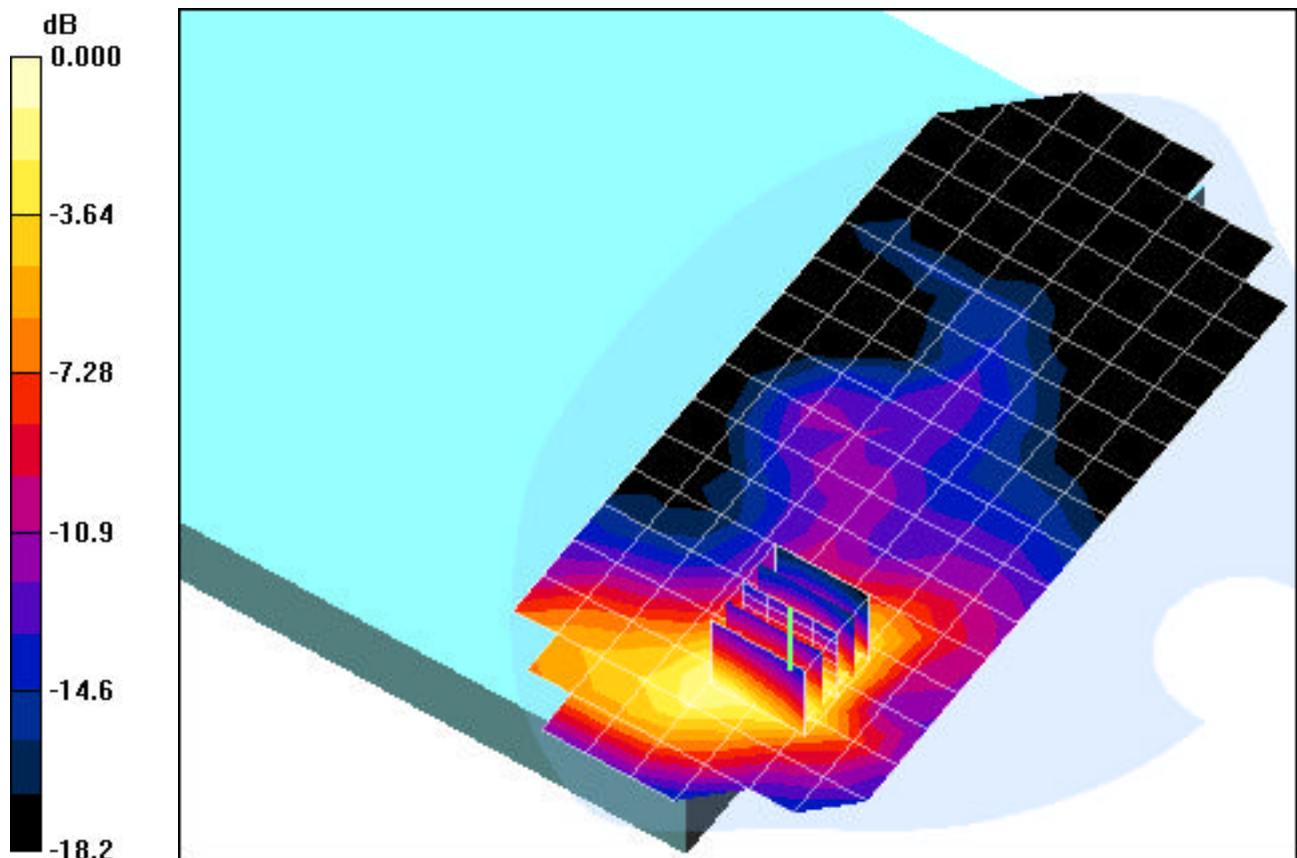

0 dB = 1.40mW/g

PCTEST ENGINEERING LABORATORY, INC.

DUT: XV620 with COMPAQ V4332US; Type: Dual Band CDMA Modem Card; Serial: 112

Communication System: Cellular CDMA; Frequency: 836.52 MHz; Duty Cycle: 1:1

Medium: 835 Muscle ($\sigma = 0.99$ mho/m, $\epsilon_r = 56.89$, $\rho = 1000$ kg/m³)

Phantom section: Flat Section; Space: 2.5 cm

Test Date: 03-29-2006; Ambient Temp: 23.3°C; Tissue Temp: 21.3°C

Probe: EX3DV4 - SN3561; ConvF(7.9, 7.9, 7.9); Calibrated: 8/24/2005

Sensor-Surface: 3mm (Mechanical Surface Detection)

Electronics: DAE4 Sn649; Calibrated: 9/13/2005

Phantom: SAM Main; Type: SAM 4.0; Serial: TP:1197

Measurement SW: DASY4, V4.6 Build 23; Postprocessing SW: SEMCAD, V1.8 Build 160

Mode: CDMA, Bystander position, Mid.ch, Ant.open

Area Scan (9x21x1): Measurement grid: dx=15mm, dy=15mm

Zoom Scan (5x5x7)/Cube 0: Measurement grid: dx=8mm, dy=8mm, dz=5mm

Reference Value = 5.39 V/m

Peak SAR (extrapolated) = 0.037 W/kg

SAR(1 g) = 0.028 mW/g; SAR(10 g) = 0.022 mW/g

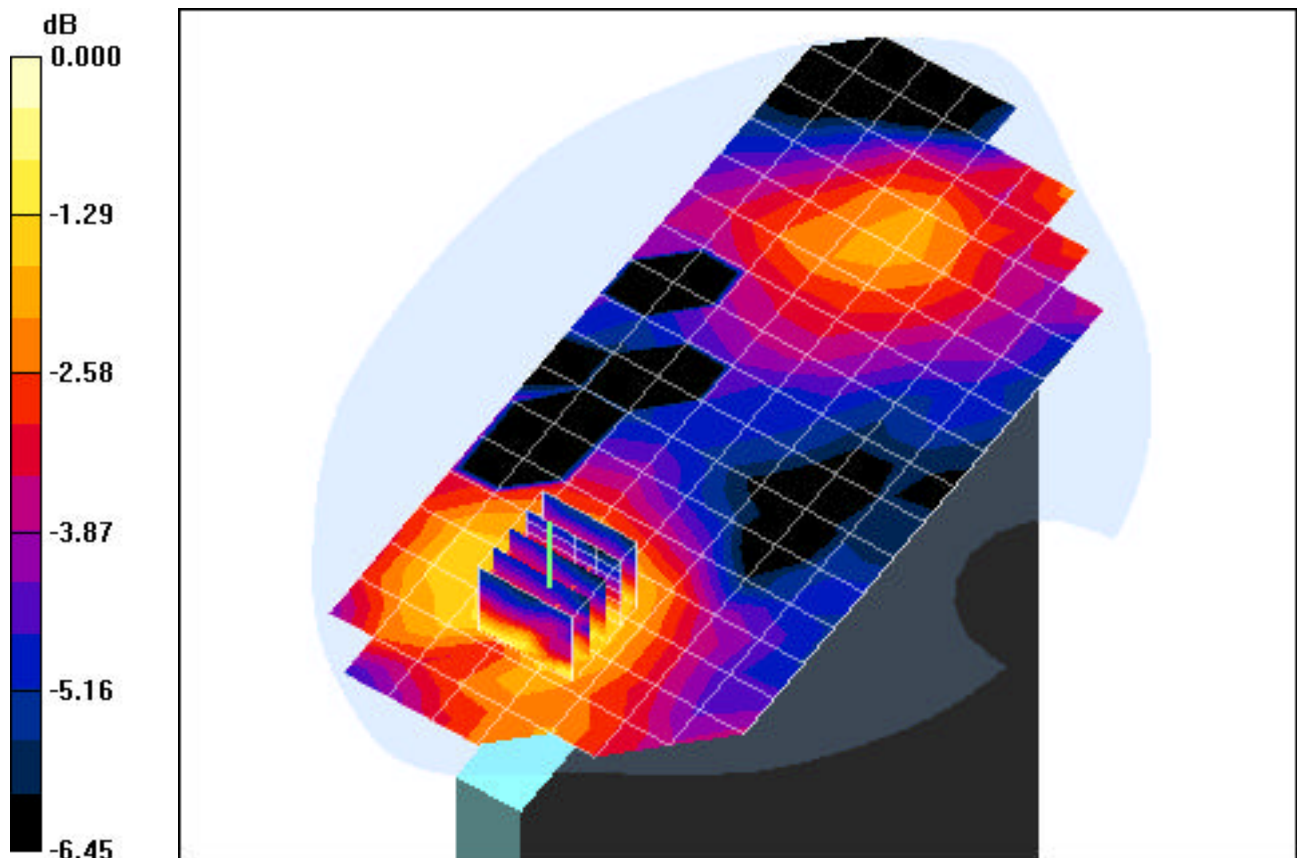

0 dB = 0.031mW/g

PCTEST ENGINEERING LABORATORY, INC.

DUT: XV620 with COMPAQ V4332US; Type: Dual Band CDMA Modem Card; Serial: 112

Communication System: PCS CDMA; Frequency: 1880 MHz; Duty Cycle: 1:1

Medium: 1900 Muscle ($\sigma = 1.57$ mho/m, $\epsilon_r = 52.64$, $\rho = 1000$ kg/m³)

Phantom section: Flat Section; Space: 2.5 cm

Test Date: 03-28-2006; Ambient Temp: 23.0°C; Tissue Temp: 21.5°C

Probe: EX3DV4 - SN3561; ConvF(6.48, 6.48, 6.48); Calibrated: 8/24/2005

Sensor-Surface: 3mm (Mechanical Surface Detection)

Electronics: DAE4 Sn649; Calibrated: 9/13/2005

Phantom: SAM Sub; Type: SAM 4.0; Serial: TP:1357

Measurement SW: DASY4, V4.6 Build 23; Postprocessing SW: SEMCAD, V1.8 Build 160

Mode: PCS, Bystander position, Mid.ch, Ant.open

Area Scan (9x21x1): Measurement grid: dx=15mm, dy=15mm

Zoom Scan (5x5x7)/Cube 0: Measurement grid: dx=8mm, dy=8mm, dz=5mm

Reference Value = 10.2 V/m

Peak SAR (extrapolated) = 0.219 W/kg

SAR(1 g) = 0.144 mW/g; SAR(10 g) = 0.090 mW/g

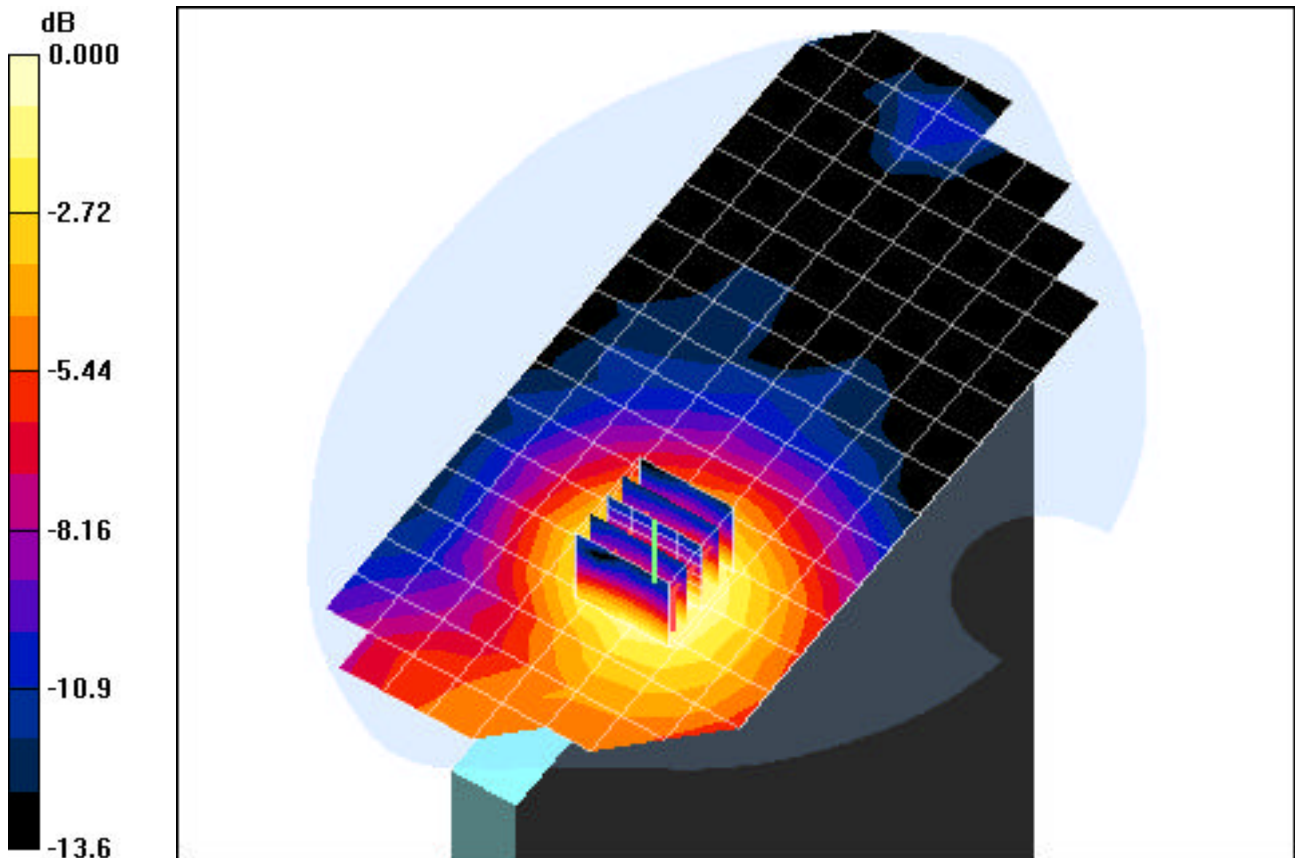

0 dB = 0.169mW/g

PCTEST ENGINEERING LABORATORY, INC.

DUT: XV620 with DELL M1210; Type: Dual Band CDMA Modem Card; Serial: 112

Communication System: Cellular CDMA; Frequency: 836.52 MHz; Duty Cycle: 1:1

Medium: 835 Muscle ($\sigma = 0.99$ mho/m, $\epsilon_r = 56.89$, $\rho = 1000$ kg/m³)

Phantom section: Flat Section; Space: 2.0 cm

Test Date: 03-29-2006; Ambient Temp: 23.3°C; Tissue Temp: 21.3°C

Probe: EX3DV4 - SN3561; ConvF(7.9, 7.9, 7.9); Calibrated: 8/24/2005

Sensor-Surface: 3mm (Mechanical Surface Detection)

Electronics: DAE4 Sn649; Calibrated: 9/13/2005

Phantom: SAM Main; Type: SAM 4.0; Serial: TP:1197

Measurement SW: DASY4, V4.6 Build 23; Postprocessing SW: SEMCAD, V1.8 Build 160

Mode: CDMA, Laptop position, Mid.ch, Ant.close

Area Scan (8x18x1): Measurement grid: dx=15mm, dy=15mm

Zoom Scan (5x5x7)/Cube 0: Measurement grid: dx=8mm, dy=8mm, dz=5mm

Reference Value = 23.2 V/m

Peak SAR (extrapolated) = 0.771 W/kg

SAR(1 g) = 0.516 mW/g; SAR(10 g) = 0.335 mW/g

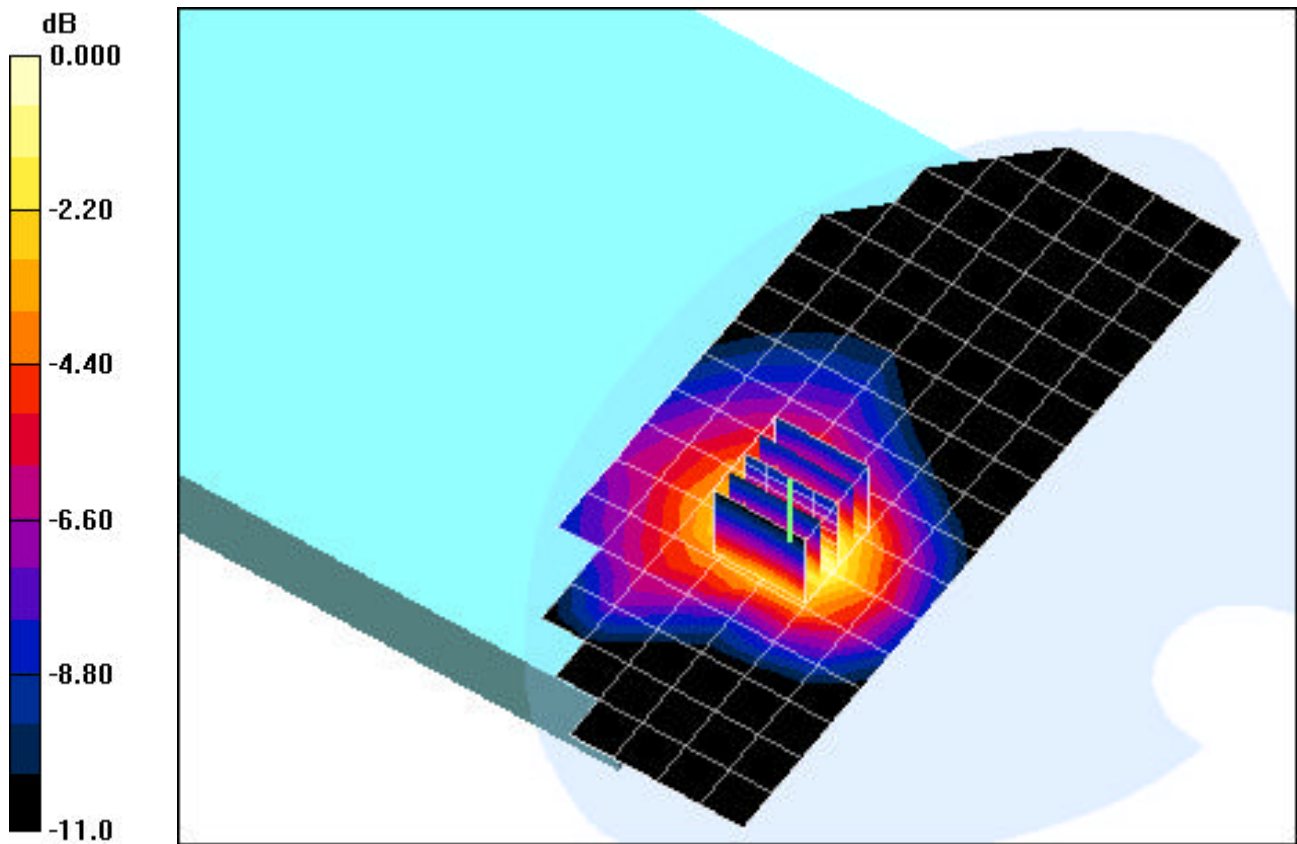

0 dB = 0.604mW/g

PCTEST ENGINEERING LABORATORY, INC.

DUT: XV620 with DELL M1210; Type: Dual Band CDMA Modem Card; Serial: 112

Communication System: PCS CDMA; Frequency: 1880 MHz; Duty Cycle: 1:1

Medium: 1900 Muscle ($\sigma = 1.57$ mho/m, $\epsilon_r = 52.64$, $\rho = 1000$ kg/m³)

Phantom section: Flat Section; Space: 2.0 cm

Test Date: 03-29-2006; Ambient Temp: 23.6°C; Tissue Temp: 21.7°C

Probe: EX3DV4 - SN3561; ConvF(6.48, 6.48, 6.48); Calibrated: 8/24/2005

Sensor-Surface: 3mm (Mechanical Surface Detection)

Electronics: DAE4 Sn649; Calibrated: 9/13/2005

Phantom: SAM Sub; Type: SAM 4.0; Serial: TP:1357

Measurement SW: DASY4, V4.6 Build 23; Postprocessing SW: SEMCAD, V1.8 Build 160

Mode: PCS, Laptop position, Mid.ch, Ant.open

Area Scan (8x18x1): Measurement grid: dx=15mm, dy=15mm

Zoom Scan (5x5x7)/Cube 0: Measurement grid: dx=8mm, dy=8mm, dz=5mm

Reference Value = 17.0 V/m

Peak SAR (extrapolated) = 0.656 W/kg

SAR(1 g) = 0.416 mW/g; SAR(10 g) = 0.242 mW/g

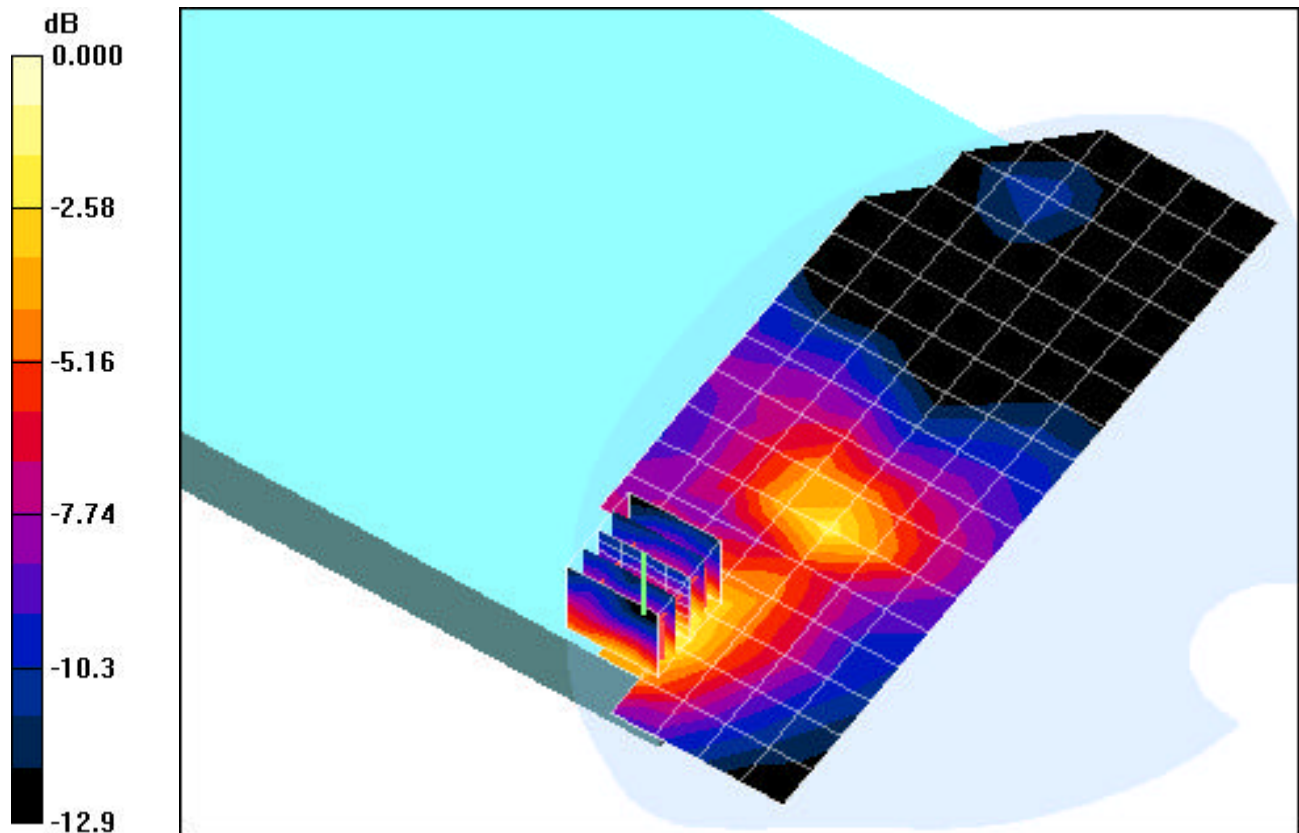

0 dB = 0.496mW/g

PCTEST ENGINEERING LABORATORY, INC.

DUT: XV620 with DELL M1210; Type: Dual Band CDMA Modem Card; Serial: 112

Communication System: Cellular CDMA; Frequency: 836.52 MHz; Duty Cycle: 1:1

Medium: 835 Muscle ($\sigma = 0.99$ mho/m, $\epsilon_r = 56.89$, $\rho = 1000$ kg/m³)

Phantom section: Flat Section; Space: 2.5 cm

Test Date: 03-29-2006; Ambient Temp: 23.3°C; Tissue Temp: 21.3°C

Probe: EX3DV4 - SN3561; ConvF(7.9, 7.9, 7.9); Calibrated: 8/24/2005

Sensor-Surface: 3mm (Mechanical Surface Detection)

Electronics: DAE4 Sn649; Calibrated: 9/13/2005

Phantom: SAM Main; Type: SAM 4.0; Serial: TP:1197

Measurement SW: DASY4, V4.6 Build 23; Postprocessing SW: SEMCAD, V1.8 Build 160

Mode: CDMA, Bystander position, Mid.ch, Ant.open

Area Scan (7x18x1): Measurement grid: dx=15mm, dy=15mm

Zoom Scan (5x5x7)/Cube 0: Measurement grid: dx=8mm, dy=8mm, dz=5mm

Reference Value = 5.54 V/m

Peak SAR (extrapolated) = 0.040 W/kg

SAR(1 g) = 0.030 mW/g; SAR(10 g) = 0.023 mW/g

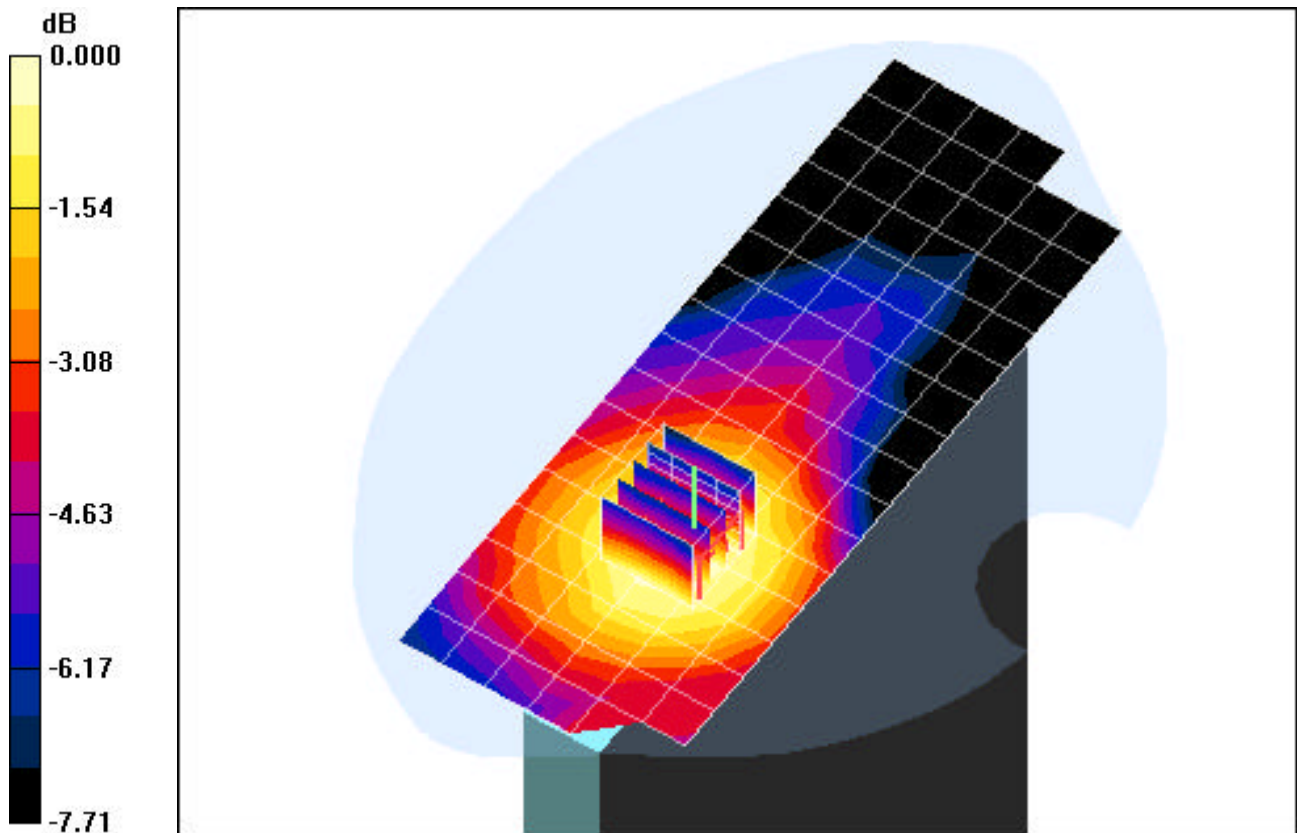

0 dB = 0.033mW/g

PCTEST ENGINEERING LABORATORY, INC.

DUT: XV620 with DELL M1210; Type: Dual Band CDMA Modem Card; Serial: 112

Communication System: PCS CDMA; Frequency: 1880 MHz; Duty Cycle: 1:1

Medium: 1900 Muscle ($\sigma = 1.57$ mho/m, $\epsilon_r = 52.64$, $\rho = 1000$ kg/m³)

Phantom section: Flat Section; Space: 2.5 cm

Test Date: 03-30-2006; Ambient Temp: 23.2°C; Tissue Temp: 21.1°C

Probe: EX3DV4 - SN3561; ConvF(6.48, 6.48, 6.48); Calibrated: 8/24/2005

Sensor-Surface: 3mm (Mechanical Surface Detection)

Electronics: DAE4 Sn649; Calibrated: 9/13/2005

Phantom: SAM Sub; Type: SAM 4.0; Serial: TP:1357

Measurement SW: DASY4, V4.6 Build 23; Postprocessing SW: SEMCAD, V1.8 Build 160

Mode: PCS, Bystander position, Mid.ch, Ant.close

Area Scan (8x18x1): Measurement grid: dx=15mm, dy=15mm

Zoom Scan (5x5x7)/Cube 0: Measurement grid: dx=8mm, dy=8mm, dz=5mm

Reference Value = 10.7 V/m

Peak SAR (extrapolated) = 0.246 W/kg

SAR(1 g) = 0.163 mW/g; SAR(10 g) = 0.103 mW/g

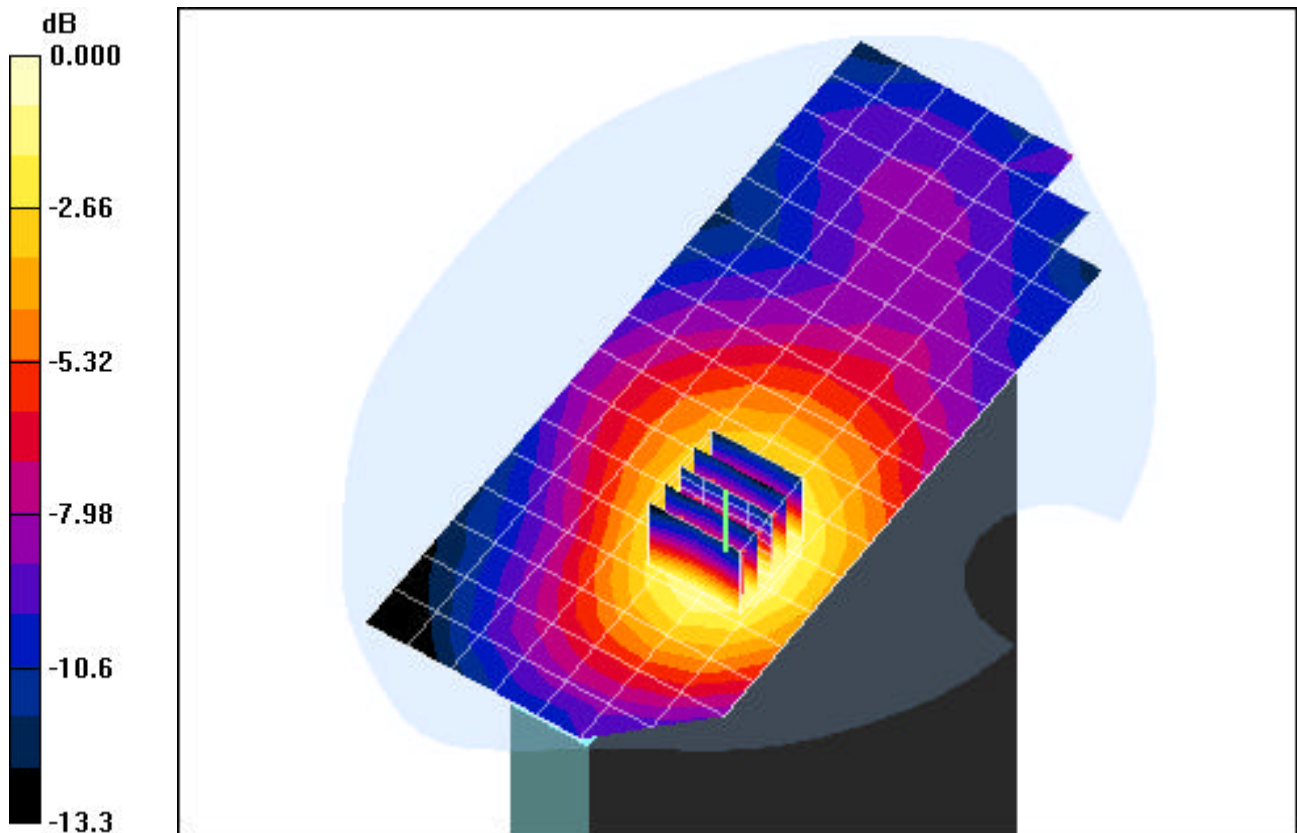

0 dB = 0.192mW/g

PCTEST ENGINEERING LABORATORY, INC.

DUT: XV620 with DELL FM1B; Type: Dual Band CDMA Modem Card; Serial: 112

Communication System: Cellular CDMA; Frequency: 836.52 MHz; Duty Cycle: 1:1

Medium: 835 Muscle ($\sigma = 0.99$ mho/m, $\epsilon_r = 56.89$, $\rho = 1000$ kg/m³)

Phantom section: Flat Section; Space: 1.6 cm

Test Date: 03-29-2006; Ambient Temp: 23.3°C; Tissue Temp: 21.3°C

Probe: EX3DV4 - SN3561; ConvF(7.9, 7.9, 7.9); Calibrated: 8/24/2005

Sensor-Surface: 3mm (Mechanical Surface Detection)

Electronics: DAE4 Sn649; Calibrated: 9/13/2005

Phantom: SAM Main; Type: SAM 4.0; Serial: TP:1197

Measurement SW: DASY4, V4.6 Build 23; Postprocessing SW: SEMCAD, V1.8 Build 160

Mode: CDMA, Laptop position, Mid.ch, Ant.close

Area Scan (8x21x1): Measurement grid: dx=15mm, dy=15mm

Zoom Scan (5x5x7)/Cube 0: Measurement grid: dx=8mm, dy=8mm, dz=5mm

Reference Value = 29.5 V/m

Peak SAR (extrapolated) = 1.24 W/kg

SAR(1 g) = 0.793 mW/g; SAR(10 g) = 0.499 mW/g

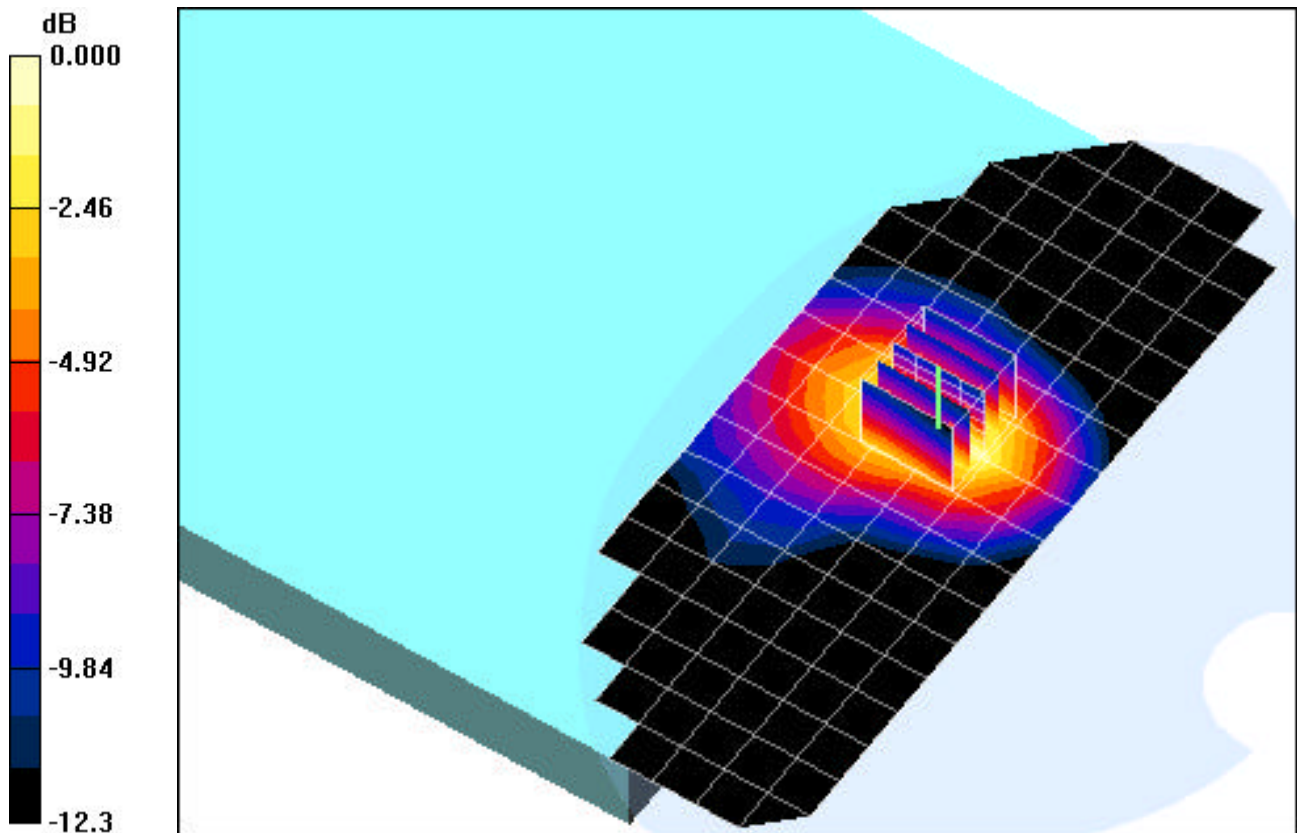

0 dB = 0.936mW/g

PCTEST ENGINEERING LABORATORY, INC.

DUT: XV620 with DELL FM1B; Type: Dual Band CDMA Modem Card; Serial: 112

Communication System: PCS CDMA; Frequency: 1880 MHz; Duty Cycle: 1:1

Medium: 1900 Muscle ($\sigma = 1.57$ mho/m, $\epsilon_r = 52.64$, $\rho = 1000$ kg/m³)

Phantom section: Flat Section; Space: 1.6 cm

Test Date: 03-30-2006; Ambient Temp: 23.2°C; Tissue Temp: 21.1°C

Probe: EX3DV4 - SN3561; ConvF(6.48, 6.48, 6.48); Calibrated: 8/24/2005

Sensor-Surface: 3mm (Mechanical Surface Detection)

Electronics: DAE4 Sn649; Calibrated: 9/13/2005

Phantom: SAM Sub; Type: SAM 4.0; Serial: TP:1357

Measurement SW: DASY4, V4.6 Build 23; Postprocessing SW: SEMCAD, V1.8 Build 160

Mode: PCS, Laptop position, Mid.ch, Ant.close

Area Scan (7x21x1): Measurement grid: dx=15mm, dy=15mm

Zoom Scan (5x5x7)/Cube 0: Measurement grid: dx=8mm, dy=8mm, dz=5mm

Reference Value = 17.0 V/m

Peak SAR (extrapolated) = 0.825 W/kg

SAR(1 g) = 0.486 mW/g; SAR(10 g) = 0.262 mW/g

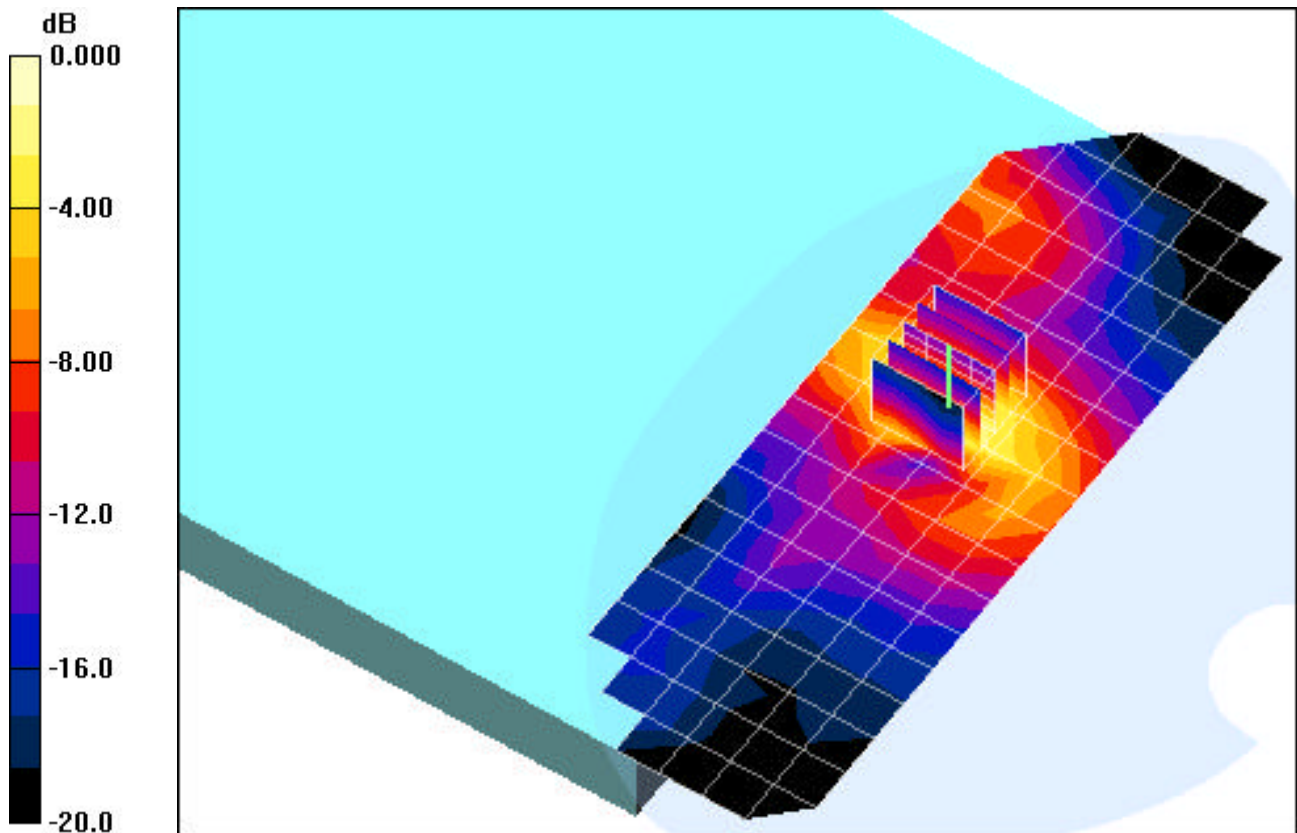

0 dB = 0.599mW/g

PCTEST ENGINEERING LABORATORY, INC.

DUT: XV620 with DELL FM1B; Type: Dual Band CDMA Modem Card; Serial: 112

Communication System: Cellular CDMA; Frequency: 836.52 MHz; Duty Cycle: 1:1

Medium: 835 Muscle ($\sigma = 0.99$ mho/m, $\epsilon_r = 56.89$, $\rho = 1000$ kg/m³)

Phantom section: Flat Section; Space: 2.5 cm

Test Date: 03-29-2006; Ambient Temp: 23.3°C; Tissue Temp: 21.3°C

Probe: EX3DV4 - SN3561; ConvF(7.9, 7.9, 7.9); Calibrated: 8/24/2005

Sensor-Surface: 3mm (Mechanical Surface Detection)

Electronics: DAE4 Sn649; Calibrated: 9/13/2005

Phantom: SAM Main; Type: SAM 4.0; Serial: TP:1197

Measurement SW: DASY4, V4.6 Build 23; Postprocessing SW: SEMCAD, V1.8 Build 160

Mode: CDMA, Bystander position, Mid.ch, Ant.close

Area Scan (7x21x1): Measurement grid: dx=15mm, dy=15mm

Zoom Scan (5x5x7)/Cube 0: Measurement grid: dx=8mm, dy=8mm, dz=5mm

Reference Value = 6.17 V/m

Peak SAR (extrapolated) = 0.047 W/kg

SAR(1 g) = 0.036 mW/g; SAR(10 g) = 0.028 mW/g

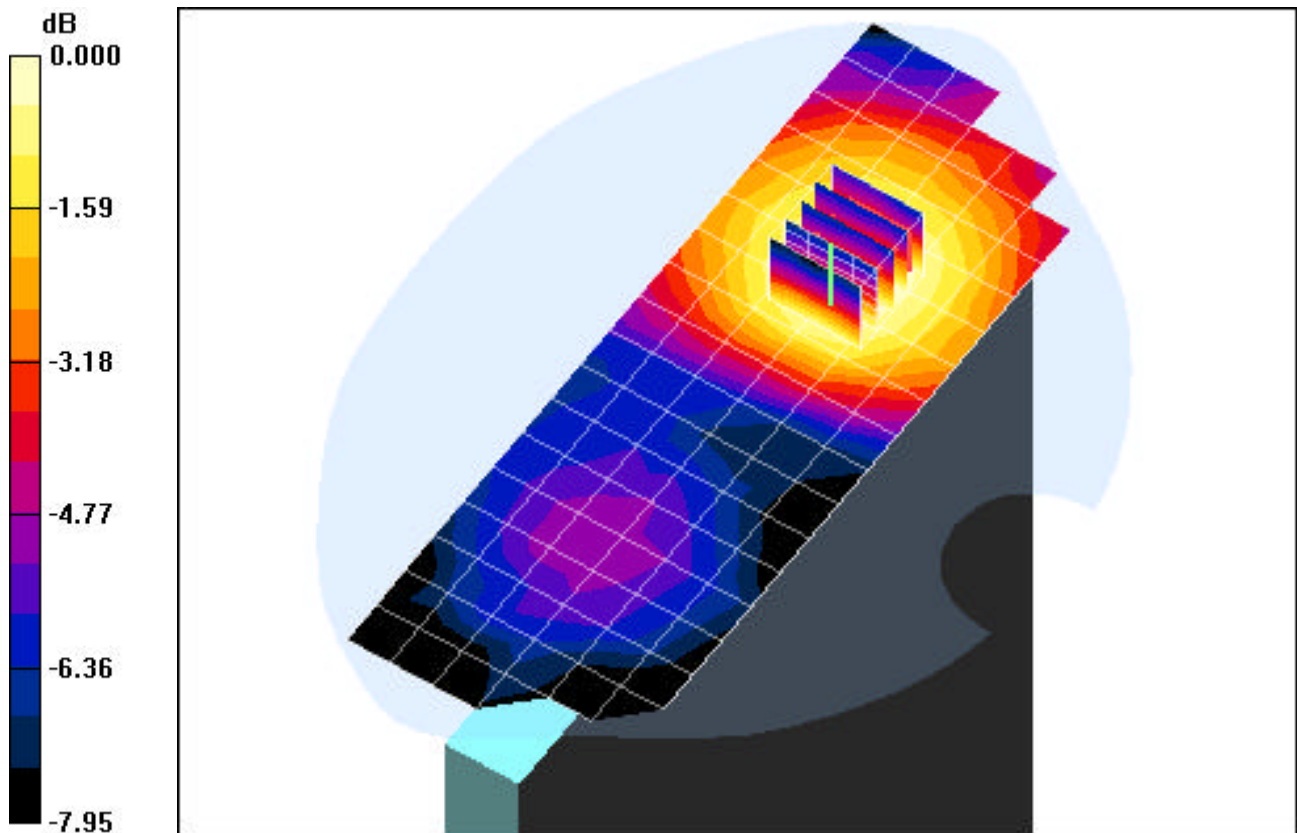

0 dB = 0.040mW/g

PCTEST ENGINEERING LABORATORY, INC.

DUT: XV620 with DELL FM1B; Type: Dual Band CDMA Modem Card; Serial: 112

Communication System: PCS CDMA; Frequency: 1880 MHz; Duty Cycle: 1:1

Medium: 1900 Muscle ($\sigma = 1.57$ mho/m, $\epsilon_r = 52.64$, $\rho = 1000$ kg/m³)

Phantom section: Flat Section; Space: 2.5 cm

Test Date: 03-30-2006; Ambient Temp: 23.2°C; Tissue Temp: 21.1°C

Probe: EX3DV4 - SN3561; ConvF(6.48, 6.48, 6.48); Calibrated: 8/24/2005

Sensor-Surface: 3mm (Mechanical Surface Detection)

Electronics: DAE4 Sn649; Calibrated: 9/13/2005

Phantom: SAM Sub; Type: SAM 4.0; Serial: TP:1357

Measurement SW: DASY4, V4.6 Build 23; Postprocessing SW: SEMCAD, V1.8 Build 160

Mode: PCS, Bystander position, Mid.ch, Ant.open

Area Scan (8x21x1): Measurement grid: dx=15mm, dy=15mm

Zoom Scan (5x5x7)/Cube 0: Measurement grid: dx=8mm, dy=8mm, dz=5mm

Reference Value = 9.15 V/m

Peak SAR (extrapolated) = 0.175 W/kg

SAR(1 g) = 0.117 mW/g; SAR(10 g) = 0.074 mW/g

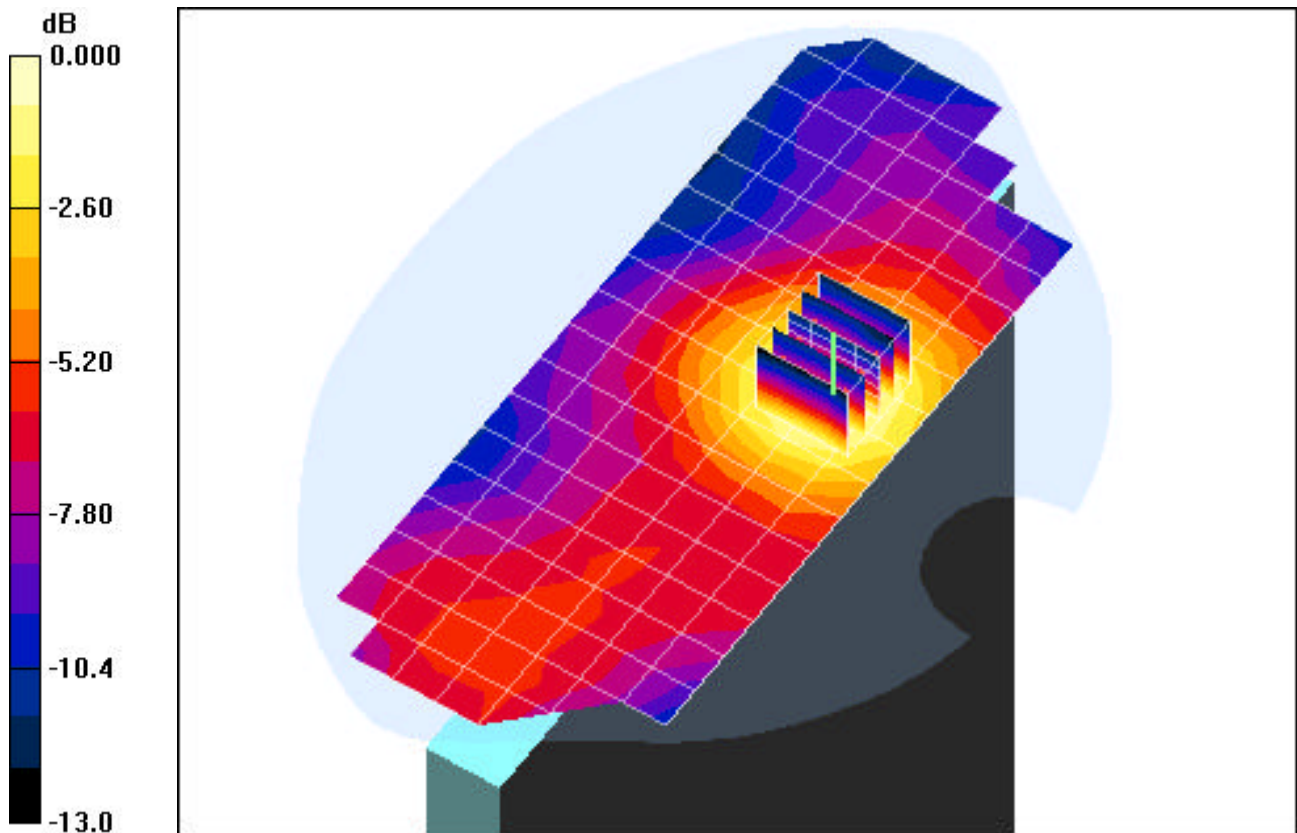

0 dB = 0.137mW/g

PCTEST ENGINEERING LABORATORY, INC.

DUT: XV620 with COMPAQ V4332US; Type: Dual Band CDMA Modem Card; Serial: 112

Communication System: Cellular CDMA; Frequency: 848.31 MHz; Duty Cycle: 1:1
Medium: 835 Muscle ($\sigma = 0.99$ mho/m, $\epsilon_r = 56.89$, $\rho = 1000$ kg/m³)
Phantom section: Flat Section; Space: 0.9 cm

Test Date: 03-28-2006; Ambient Temp: 23.5°C; Tissue Temp: 21.2°C

Probe: EX3DV4 - SN3561; ConvF(7.9, 7.9, 7.9); Calibrated: 8/24/2005

Sensor-Surface: 3mm (Mechanical Surface Detection)

Electronics: DAE4 Sn649; Calibrated: 9/13/2005

Phantom: SAM Main; Type: SAM 4.0; Serial: TP:1197

Measurement SW: DASY4, V4.6 Build 23; Postprocessing SW: SEMCAD, V1.8 Build 160

Mode: CDMA, Laptop position, High.ch, Ant.close

Area Scan (7x21x1): Measurement grid: dx=15mm, dy=15mm

Zoom Scan (5x5x7)/Cube 0: Measurement grid: dx=8mm, dy=8mm, dz=5mm

Reference Value = 31.7 V/m

Peak SAR (extrapolated) = 1.75 W/kg

SAR(1 g) = 0.996 mW/g; SAR(10 g) = 0.565 mW/g

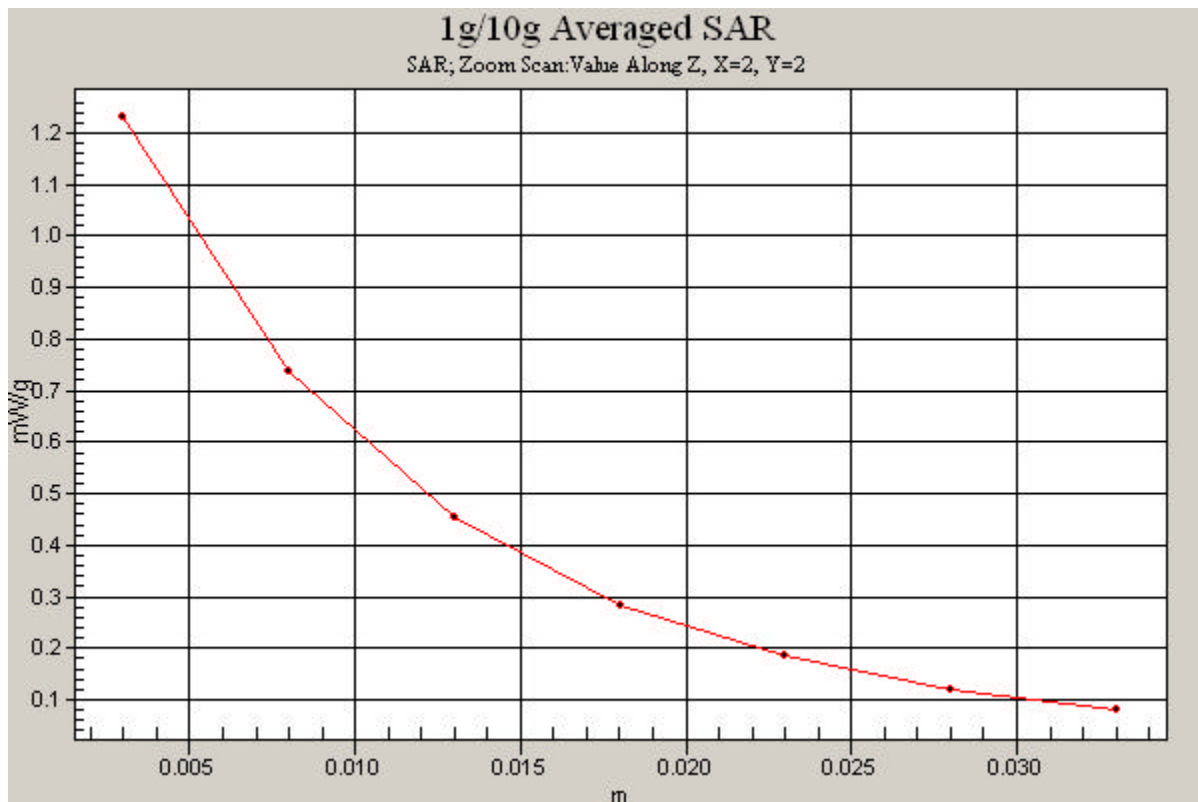

PCTEST ENGINEERING LABORATORY, INC.

DUT: XV620 with COMPAQ V4332US; Type: Dual Band CDMA Modem Card; Serial: 112

Communication System: PCS CDMA; Frequency: 1851.25 MHz; Duty Cycle: 1:1

Medium: 1900 Muscle ($\sigma = 1.57$ mho/m, $\epsilon_r = 52.64$, $\rho = 1000$ kg/m³)

Phantom section: Flat Section; Space: 0.9 cm

Test Date: 03-28-2006; Ambient Temp: 23.0°C; Tissue Temp: 21.5°C

Probe: EX3DV4 - SN3561; ConvF(6.48, 6.48, 6.48); Calibrated: 8/24/2005

Sensor-Surface: 3mm (Mechanical Surface Detection)

Electronics: DAE4 Sn649; Calibrated: 9/13/2005

Phantom: SAM Sub; Type: SAM 4.0; Serial: TP:1357

Measurement SW: DASY4, V4.6 Build 23; Postprocessing SW: SEMCAD, V1.8 Build 160

Mode: PCS, Laptop position, Low.ch, Ant.open

Area Scan (9x21x1): Measurement grid: dx=15mm, dy=15mm

Zoom Scan (5x5x7)/Cube 0: Measurement grid: dx=8mm, dy=8mm, dz=5mm

Reference Value = 7.45 V/m

Peak SAR (extrapolated) = 1.84 W/kg

SAR(1 g) = 1.14 mW/g; SAR(10 g) = 0.639 mW/g

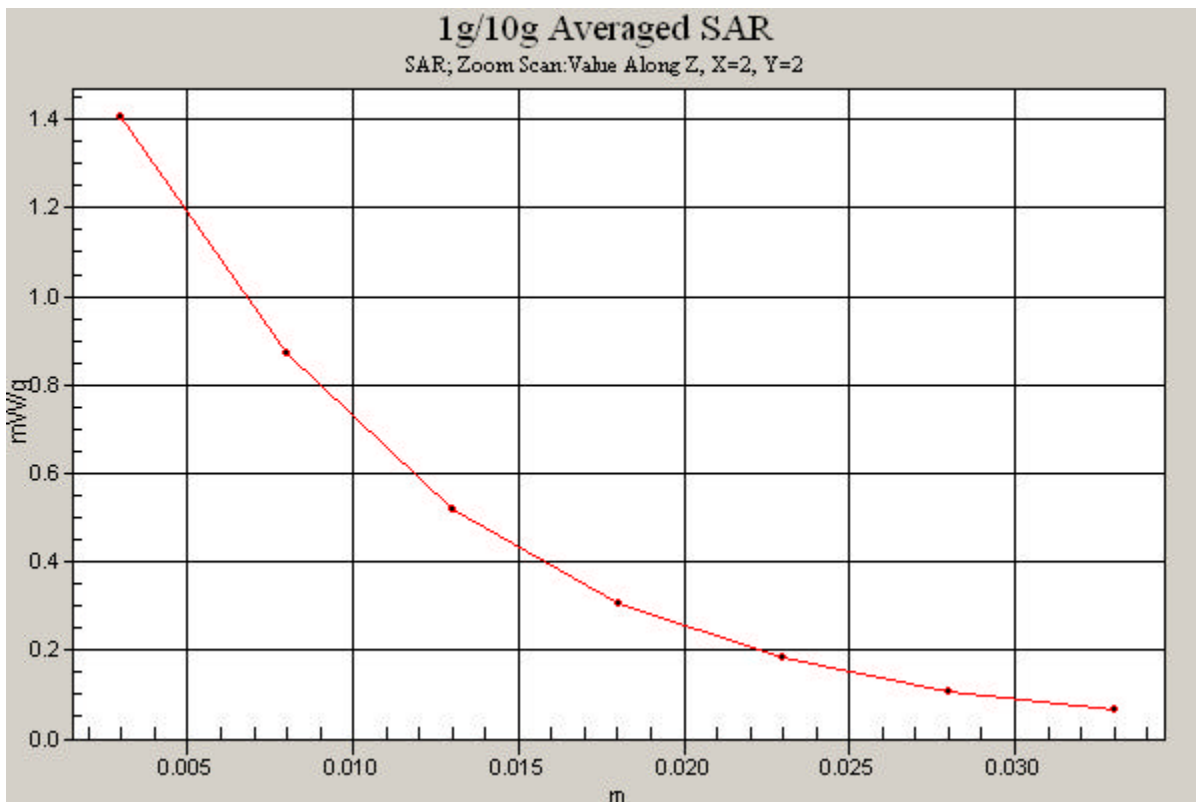

APPENDIX B: DIPOLE VALIDATION

PCTEST ENGINEERING LABORATORY, INC.

DUT: Dipole 835 MHz; Type: D835V2; Serial: 4d026

Communication System: CW; Frequency: 835 MHz; Duty Cycle: 1:1

Medium: 835 Brain ($\sigma = 0.88$ mho/m, $\epsilon_r = 42.10$, $\rho = 1000$ kg/m³)

Phantom section: Flat Section; Space: 1.5 cm

Test Date: 03-28-2006; Ambient Temp: 23.1°C; Tissue Temp: 21.8°C

Probe: EX3DV4 - SN3561; ConvF(7.91, 7.91, 7.91); Calibrated: 8/24/2005

Sensor-Surface: 3mm (Mechanical Surface Detection)

Electronics: DAE4 Sn649; Calibrated: 9/13/2005

Phantom: SAM Main; Type: SAM 4.0; Serial: TP:1197

Measurement SW: DASY4, V4.6 Build 23; Postprocessing SW: SEMCAD, V1.8 Build 160

835MHz Dipole Validation

Area Scan (7x13x1): Measurement grid: dx=15mm, dy=15mm

Zoom Scan (5x5x7)/Cube 0: Measurement grid: dx=8mm, dy=8mm, dz=5mm

Input Power = 24.0 dBm (250 mW)

SAR(1 g) = 2.33 mW/g; SAR(10 g) = 1.53 mW/g

Target SAR(1g) = 2.375 mW/g; Deviation = -1.89 %

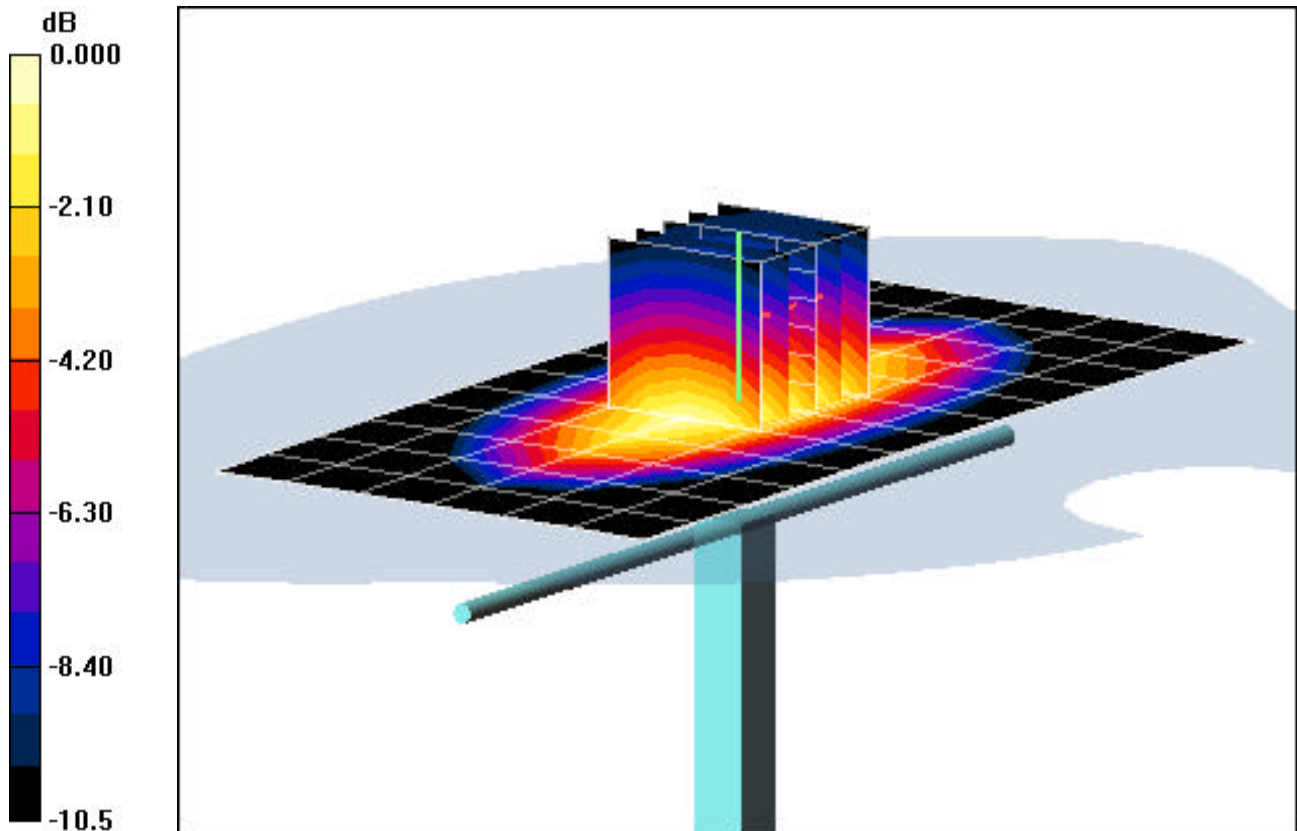

0 dB = 2.72mW/g

PCTEST ENGINEERING LABORATORY, INC.

DUT: Dipole 835 MHz; Type: D835V2; Serial: 4d026

Communication System: CW; Frequency: 835 MHz; Duty Cycle: 1:1

Medium: 835 Brain ($\sigma = 0.88$ mho/m, $\epsilon_r = 42.10$, $\rho = 1000$ kg/m³)

Phantom section: Flat Section; Space: 1.5 cm

Test Date: 03-29-2006; Ambient Temp: 23.4°C; Tissue Temp: 21.6°C

Probe: EX3DV4 - SN3561; ConvF(7.91, 7.91, 7.91); Calibrated: 8/24/2005

Sensor-Surface: 3mm (Mechanical Surface Detection)

Electronics: DAE4 Sn649; Calibrated: 9/13/2005

Phantom: SAM Main; Type: SAM 4.0; Serial: TP:1197

Measurement SW: DASY4, V4.6 Build 23; Postprocessing SW: SEMCAD, V1.8 Build 160

835MHz Dipole Validation

Area Scan (7x13x1): Measurement grid: dx=15mm, dy=15mm

Zoom Scan (5x5x7)/Cube 0: Measurement grid: dx=8mm, dy=8mm, dz=5mm

Input Power = 24.0 dBm (250 mW)

SAR(1 g) = 2.44 mW/g; SAR(10 g) = 1.6 mW/g

Target SAR(1g) = 2.375 mW/g; Deviation = +2.73 %

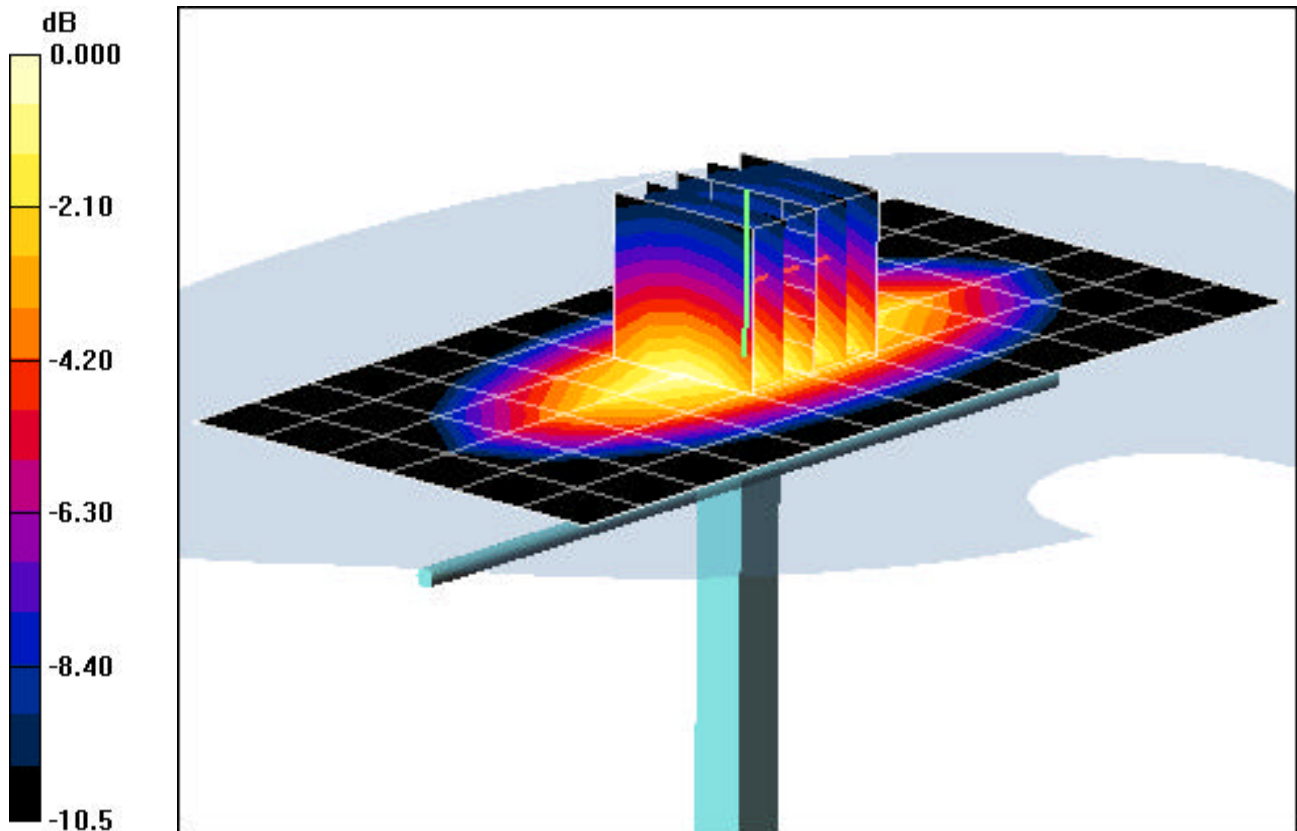

0 dB = 2.85mW/g

PCTEST ENGINEERING LABORATORY, INC.

DUT: Dipole 1900 MHz; Type: D1900V2; Serial: 502

Communication System: CW; Frequency: 1900 MHz; Duty Cycle: 1:1

Medium: 1900 Brain ($\sigma = 1.46$ mho/m, $\epsilon_r = 38.62$, $\rho = 1000$ kg/m³)

Phantom section: Flat Section; Space: 1.0 cm

Test Date: 03-28-2006; Ambient Temp: 23.4°C; Tissue Temp: 21.1°C

Probe: EX3DV4 - SN3561; ConvF(7.04, 7.04, 7.04); Calibrated: 8/24/2005

Sensor-Surface: 3mm (Mechanical Surface Detection)

Electronics: DAE4 Sn649; Calibrated: 9/13/2005

Phantom: SAM Sub; Type: SAM 4.0; Serial: TP:1357

Measurement SW: DASY4, V4.6 Build 23; Postprocessing SW: SEMCAD, V1.8 Build 160

1900MHz Dipole Validation

Area Scan (5x7x1): Measurement grid: dx=15mm, dy=15mm

Zoom Scan (5x5x7)/Cube 0: Measurement grid: dx=8mm, dy=8mm, dz=5mm

Input Power = 20.0 dBm (100 mW)

SAR(1 g) = 3.89 mW/g; SAR(10 g) = 2 mW/g

Target SAR(1g) = 3.97 mW/g; Deviation = -2.01 %

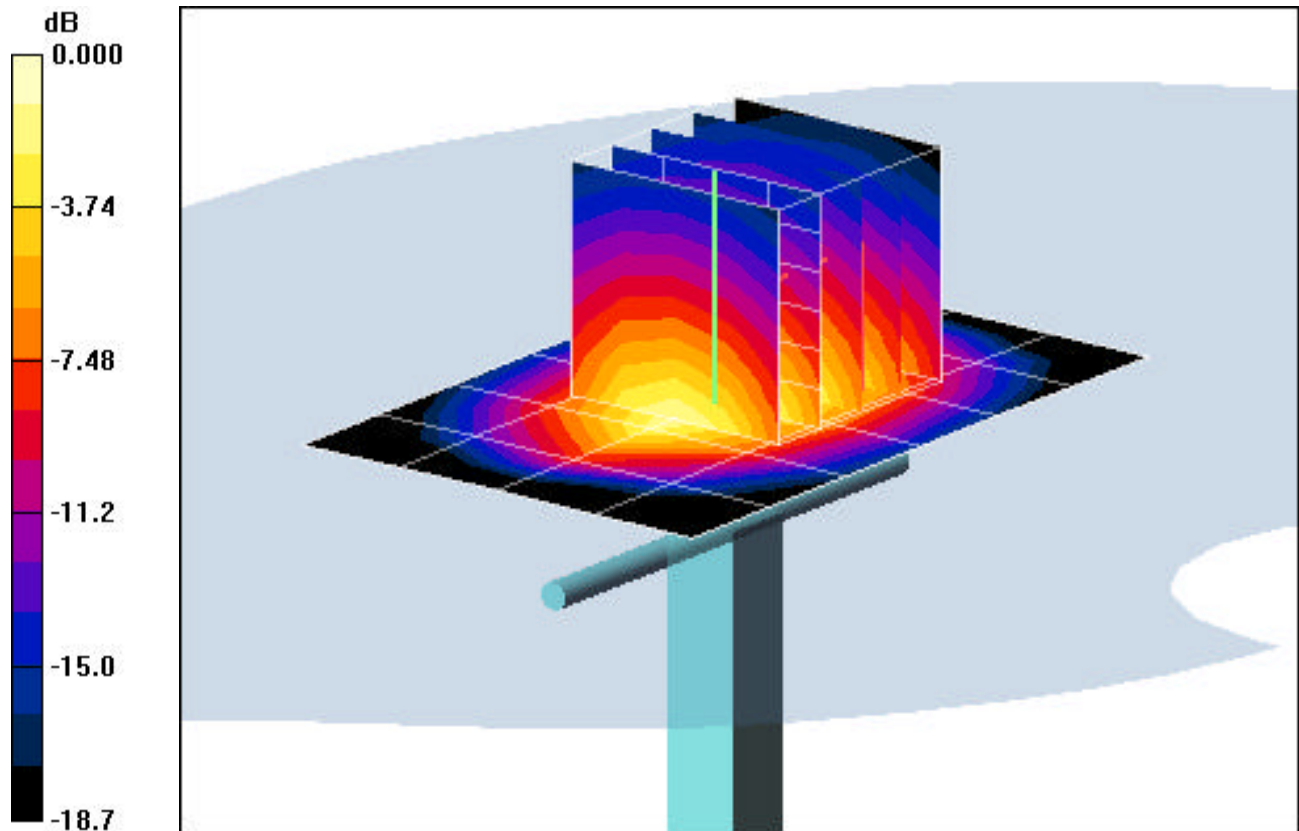

PCTEST ENGINEERING LABORATORY, INC.

DUT: Dipole 1900 MHz; Type: D1900V2; Serial: 502

Communication System: CW; Frequency: 1900 MHz; Duty Cycle: 1:1

Medium: 1900 Brain ($\sigma = 1.46$ mho/m, $\epsilon_r = 38.62$, $\rho = 1000$ kg/m³)

Phantom section: Flat Section; Space: 1.0 cm

Test Date: 03-29-2006; Ambient Temp: 23.1°C; Tissue Temp: 21.5°C

Probe: EX3DV4 - SN3561; ConvF(7.04, 7.04, 7.04); Calibrated: 8/24/2005

Sensor-Surface: 3mm (Mechanical Surface Detection)

Electronics: DAE4 Sn649; Calibrated: 9/13/2005

Phantom: SAM Sub; Type: SAM 4.0; Serial: TP:1357

Measurement SW: DASY4, V4.6 Build 23; Postprocessing SW: SEMCAD, V1.8 Build 160

1900MHz Dipole Validation

Area Scan (5x7x1): Measurement grid: dx=15mm, dy=15mm

Zoom Scan (5x5x7)/Cube 0: Measurement grid: dx=8mm, dy=8mm, dz=5mm

Input Power = 20.0 dBm (100 mW)

SAR(1 g) = 4.16 mW/g; SAR(10 g) = 2.14 mW/g

Target SAR(1g) = 3.97 mW/g; Deviation = +4.78 %

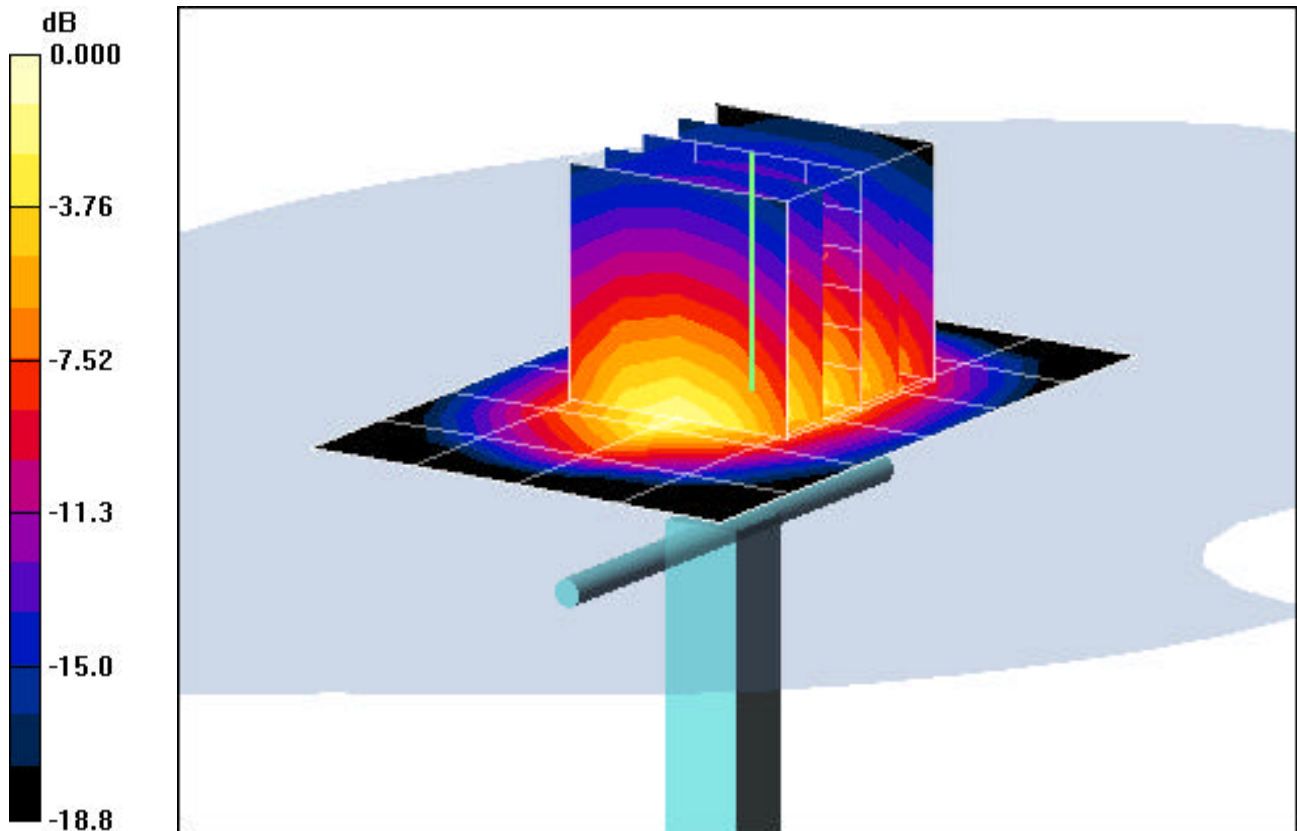

0 dB = 5.19mW/g

PCTEST ENGINEERING LABORATORY, INC.

DUT: Dipole 1900 MHz; Type: D1900V2; Serial: 502

Communication System: CW; Frequency: 1900 MHz; Duty Cycle: 1:1

Medium: 1900 Brain ($\sigma = 1.46$ mho/m, $\epsilon_r = 38.62$, $\rho = 1000$ kg/m³)

Phantom section: Flat Section; Space: 1.0 cm

Test Date: 03-30-2006; Ambient Temp: 23.5°C; Tissue Temp: 21.4°C

Probe: EX3DV4 - SN3561; ConvF(7.04, 7.04, 7.04); Calibrated: 8/24/2005

Sensor-Surface: 3mm (Mechanical Surface Detection)

Electronics: DAE4 Sn649; Calibrated: 9/13/2005

Phantom: SAM Sub; Type: SAM 4.0; Serial: TP:1357

Measurement SW: DASY4, V4.6 Build 23; Postprocessing SW: SEMCAD, V1.8 Build 160

1900MHz Dipole Validation

Area Scan (5x7x1): Measurement grid: dx=15mm, dy=15mm

Zoom Scan (5x5x7)/Cube 0: Measurement grid: dx=8mm, dy=8mm, dz=5mm

Input Power = 20.0 dBm (100 mW)

SAR(1 g) = 4.07 mW/g; SAR(10 g) = 2.1 mW/g

Target SAR(1g) = 3.97 mW/g; Deviation = +2.51 %

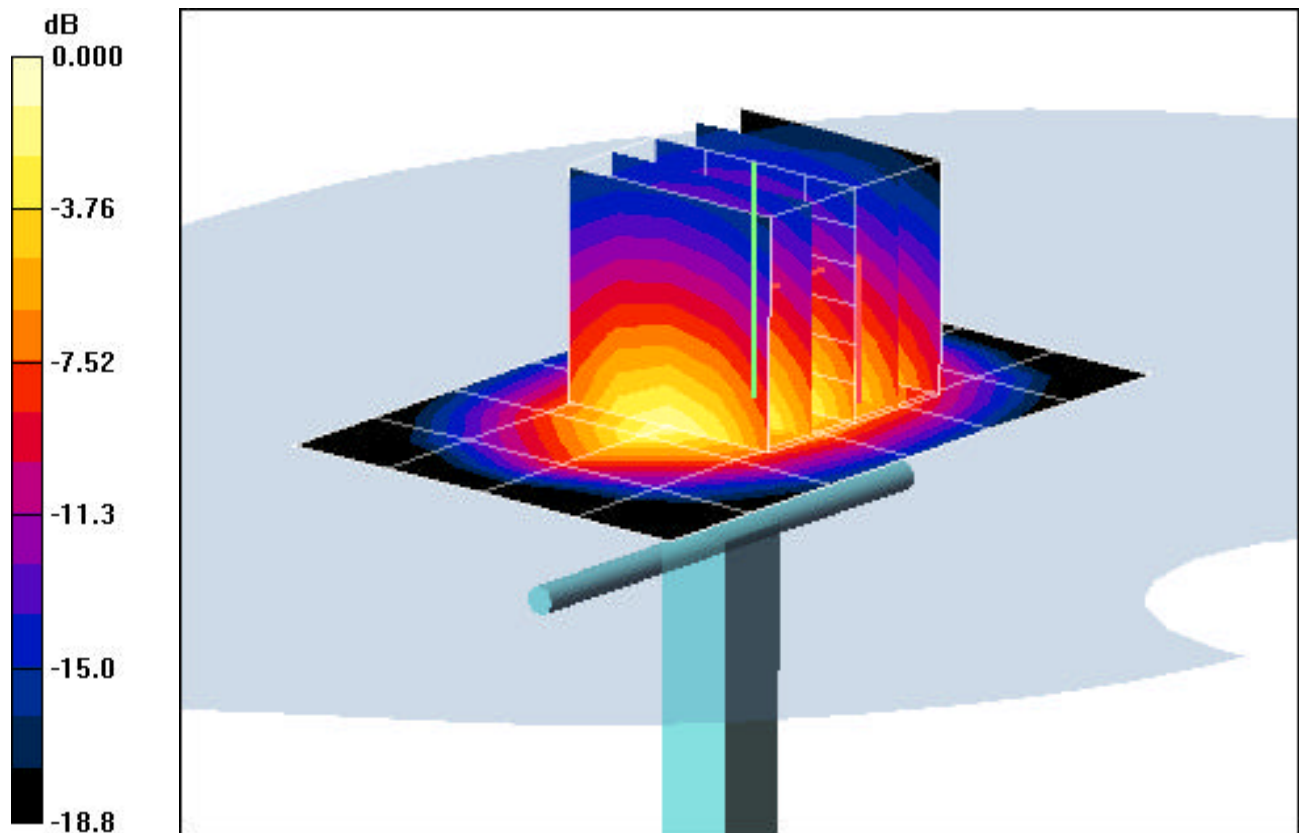

0 dB = 5.08mW/g

APPENDIX C: PROBE CALIBRATION



Accredited by the Swiss Federal Office of Metrology and Accreditation
The Swiss Accreditation Service is one of the signatories to the EA
Multilateral Agreement for the recognition of calibration certificates

Accreditation No.: **SCS 108**

Client **PC Test**

Certificate No: **EX3-3561_Aug05**

CALIBRATION CERTIFICATE

Object **EX3DV4 - SN:3561**

Calibration procedure(s) **QA CAL-01 v5 and QA CAL-14 v2
Calibration procedure for dosimetric E-field probes**

Calibration date: **August 24, 2005**

Condition of the calibrated item **In Tolerance**

This calibration certificate documents the traceability to national standards, which realize the physical units of measurements (SI).
The measurements and the uncertainties with confidence probability are given on the following pages and are part of the certificate.

All calibrations have been conducted in the closed laboratory facility: environment temperature (22 ± 3)°C and humidity < 70%.

Calibration Equipment used (M&TE critical for calibration)

Primary Standards	ID #	Cal Date (Calibrated by, Certificate No.)	Scheduled Calibration
Power meter E4419B	GB41293874	3-May-05 (METAS, No. 251-00466)	May-06
Power sensor E4412A	MY41495277	3-May-05 (METAS, No. 251-00466)	May-06
Power sensor E4412A	MY41498087	3-May-05 (METAS, No. 251-00466)	May-06
Reference 3 dB Attenuator	SN: S5054 (3c)	11-Aug-05 (METAS, No. 251-00499)	Aug-06
Reference 20 dB Attenuator	SN: S5086 (20b)	3-May-05 (METAS, No. 251-00467)	May-06
Reference 30 dB Attenuator	SN: S5129 (30b)	11-Aug-05 (METAS, No. 251-00500)	Aug-06
Reference Probe ES3DV2	SN: 3013	7-Jan-05 (SPEAG, No. ES3-3013_Jan05)	Jan-06
DAE4	SN: 654	29-Nov-04 (SPEAG, No. DAE4-654_Nov04)	Nov-05

Secondary Standards	ID #	Check Date (in house)	Scheduled Check
RF generator HP 8648C	US3642U01700	4-Aug-99 (SPEAG, in house check Dec-03)	In house check: Dec-05
Network Analyzer HP 8753E	US37390585	18-Oct-01 (SPEAG, in house check Nov-04)	In house check: Nov 05

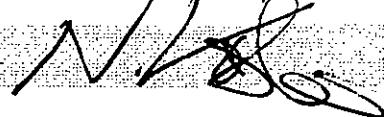
	Name	Function	Signature
Calibrated by:	Katja Pokovic	Technical Manager	
Approved by:	Niels Kuster	Quality Manager	

Issued: August 24, 2005

This calibration certificate shall not be reproduced except in full without written approval of the laboratory.



Accredited by the Swiss Federal Office of Metrology and Accreditation
The Swiss Accreditation Service is one of the signatories to the EA
Multilateral Agreement for the recognition of calibration certificates

Accreditation No.: **SCS 108**

Glossary:

TSL	tissue simulating liquid
NORM _{x,y,z}	sensitivity in free space
ConF	sensitivity in TSL / NORM _{x,y,z}
DCP	diode compression point
Polarization φ	φ rotation around probe axis
Polarization ϑ	ϑ rotation around an axis that is in the plane normal to probe axis (at measurement center), i.e., $\vartheta = 0$ is normal to probe axis

Calibration is Performed According to the Following Standards:

- IEEE Std 1528-2003, "IEEE Recommended Practice for Determining the Peak Spatial-Averaged Specific Absorption Rate (SAR) in the Human Head from Wireless Communications Devices: Measurement Techniques", December 2003
- CENELEC EN 50361, "Basic standard for the measurement of Specific Absorption Rate related to human exposure to electromagnetic fields from mobile phones (300 MHz - 3 GHz), July 2001

Methods Applied and Interpretation of Parameters:

- NORM_{x,y,z}**: Assessed for E-field polarization $\vartheta = 0$ ($f \leq 900$ MHz in TEM-cell; $f > 1800$ MHz: R22 waveguide). NORM_{x,y,z} are only intermediate values, i.e., the uncertainties of NORM_{x,y,z} does not effect the E²-field uncertainty inside TSL (see below *ConvF*).
- NORM(f)_{x,y,z}** = NORM_{x,y,z} * *frequency_response* (see Frequency Response Chart). This linearization is implemented in DASY4 software versions later than 4.2. The uncertainty of the frequency response is included in the stated uncertainty of *ConvF*.
- DCP_{x,y,z}**: DCP are numerical linearization parameters assessed based on the data of power sweep (no uncertainty required). DCP does not depend on frequency nor media.
- ConvF and Boundary Effect Parameters**: Assessed in flat phantom using E-field (or Temperature Transfer Standard for $f \leq 800$ MHz) and inside waveguide using analytical field distributions based on power measurements for $f > 800$ MHz. The same setups are used for assessment of the parameters applied for boundary compensation (alpha, depth) of which typical uncertainty values are given. These parameters are used in DASY4 software to improve probe accuracy close to the boundary. The sensitivity in TSL corresponds to NORM_{x,y,z} * *ConvF* whereby the uncertainty corresponds to that given for *ConvF*. A frequency dependent *ConvF* is used in DASY version 4.4 and higher which allows extending the validity from ± 50 MHz to ± 100 MHz.
- Spherical isotropy (3D deviation from isotropy)**: in a field of low gradients realized using a flat phantom exposed by a patch antenna.
- Sensor Offset**: The sensor offset corresponds to the offset of virtual measurement center from the probe tip (on probe axis). No tolerance required.

Probe EX3DV4

SN:3561

Manufactured:	February 14, 2005
Calibrated:	August 24, 2005

Calibrated for DASY Systems

(Note: non-compatible with DASY2 system!)

DASY - Parameters of Probe: EX3DV4 SN:3561

Sensitivity in Free Space^A

NormX	0.430 ± 10.1%	$\mu\text{V}/(\text{V}/\text{m})^2$	DCP X	90 mV
NormY	0.470 ± 10.1%	$\mu\text{V}/(\text{V}/\text{m})^2$	DCP Y	90 mV
NormZ	0.430 ± 10.1%	$\mu\text{V}/(\text{V}/\text{m})^2$	DCP Z	90 mV

Diode Compression^B

Sensitivity in Tissue Simulating Liquid (Conversion Factors)

Please see Page 8.

Boundary Effect

TSL **900 MHz** **Typical SAR gradient: 5 % per mm**

Sensor Center to Phantom Surface Distance		2.0 mm	3.0 mm
SAR _{be} [%]	Without Correction Algorithm	3.8	1.5
SAR _{be} [%]	With Correction Algorithm	0.0	0.0

TSL **1810 MHz** **Typical SAR gradient: 10 % per mm**

Sensor Center to Phantom Surface Distance		2.0 mm	3.0 mm
SAR _{be} [%]	Without Correction Algorithm	4.7	2.8
SAR _{be} [%]	With Correction Algorithm	1.1	0.8

Sensor Offset

Probe Tip to Sensor Center **1.0 mm**

The reported uncertainty of measurement is stated as the standard uncertainty of measurement multiplied by the coverage factor k=2, which for a normal distribution corresponds to a coverage probability of approximately 95%.

^A The uncertainties of NormX,Y,Z do not affect the E²-field uncertainty inside TSL (see Page 8).

^B Numerical linearization parameter: uncertainty not required.

Frequency Response of E-Field

(TEM-Cell:ifi110 EXX, Waveguide: R22)

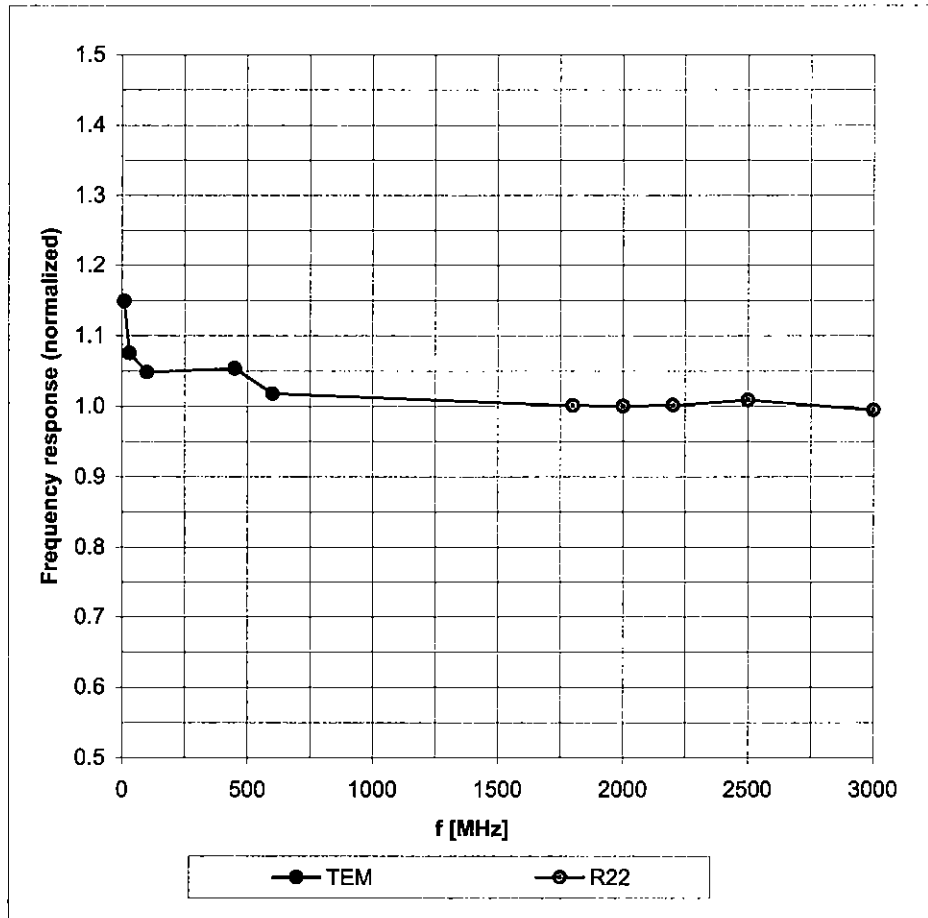

Uncertainty of Frequency Response of E-field: $\pm 6.3\%$ (k=2)

Receiving Pattern (ϕ), $\vartheta = 0^\circ$

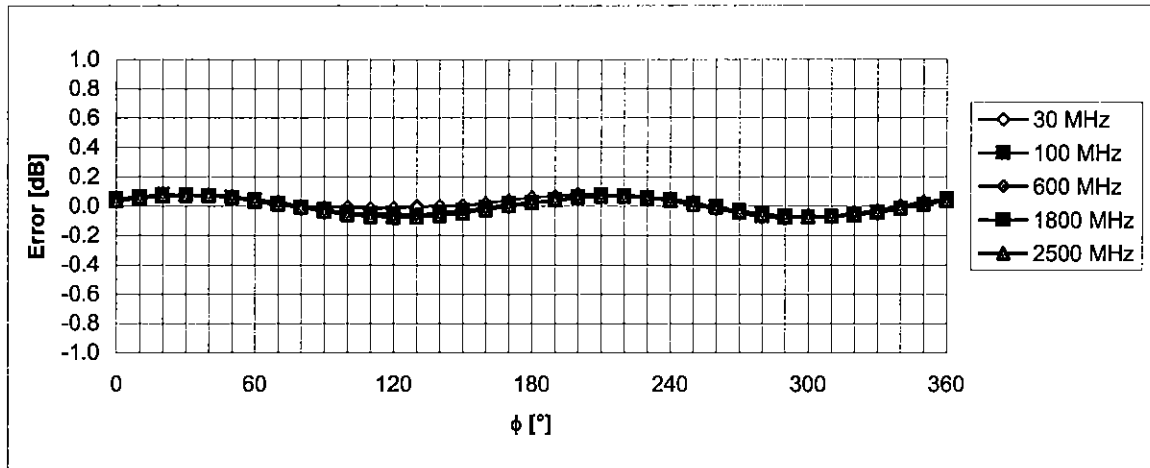
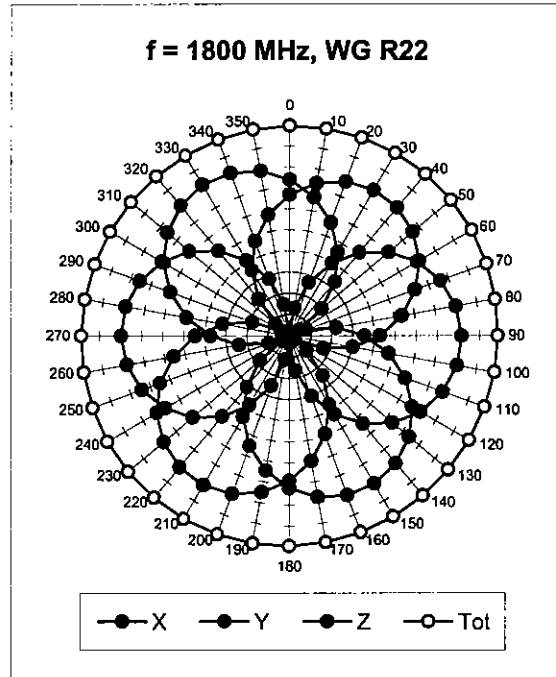
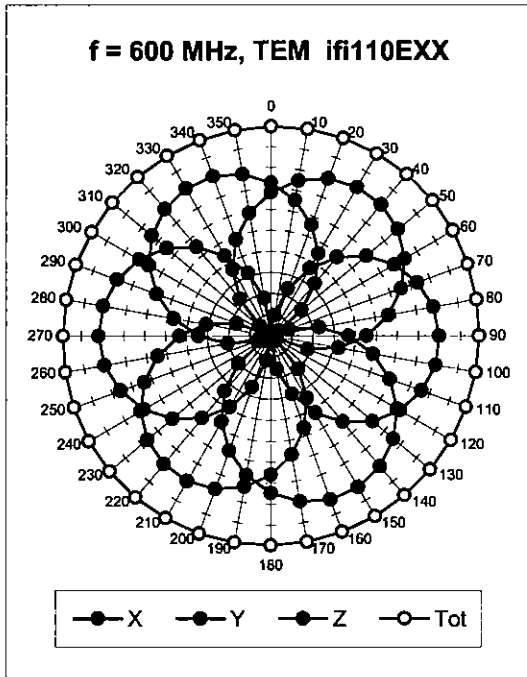

Uncertainty of Axial Isotropy Assessment: $\pm 0.5\%$ ($k=2$)

Dynamic Range $f(SAR_{head})$ (Waveguide R22, $f = 1800$ MHz)

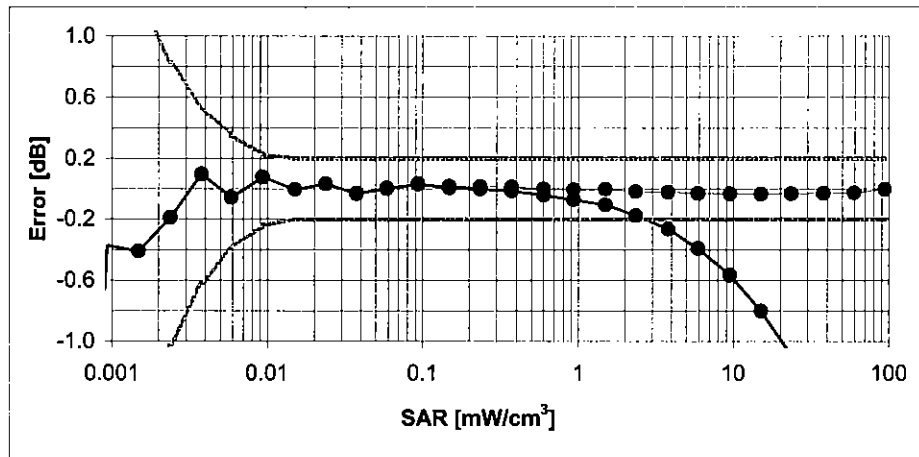
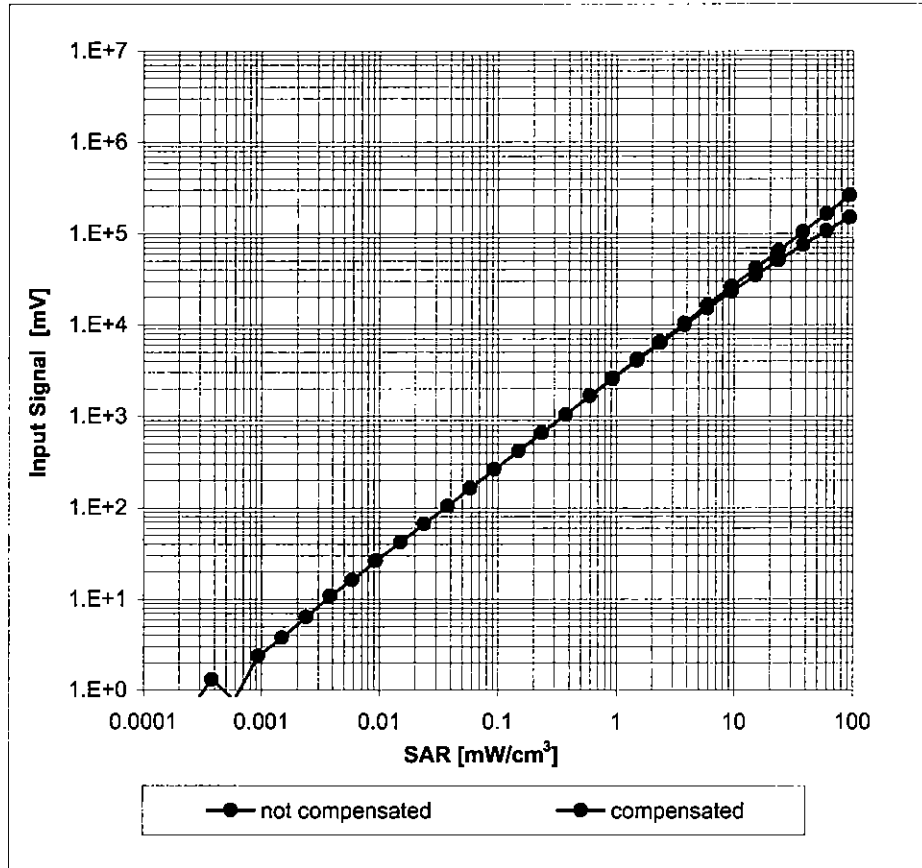

Uncertainty of Linearity Assessment: $\pm 0.6\%$ ($k=2$)

Conversion Factor Assessment

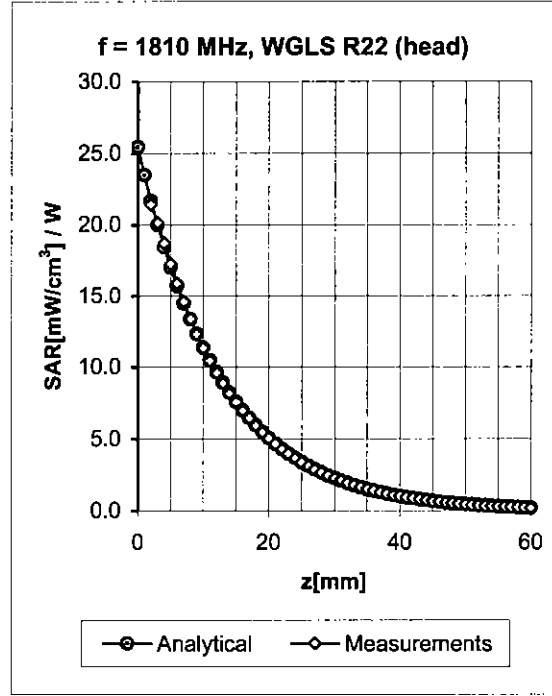
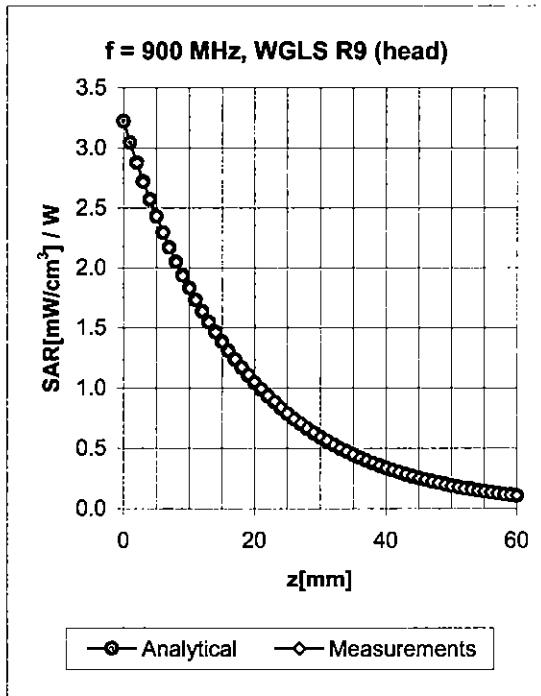

f [MHz]	Validity [MHz] ^c	TSL	Permittivity	Conductivity	Alpha	Depth	ConvF Uncertainty
900	± 50 / ± 100	Head	41.5 ± 5%	0.97 ± 5%	0.21	1.13	7.91 ± 11.0% (k=2)
1810	± 50 / ± 100	Head	40.0 ± 5%	1.40 ± 5%	0.47	0.94	7.04 ± 11.0% (k=2)
2450	± 50 / ± 100	Head	39.2 ± 5%	1.80 ± 5%	0.61	0.71	6.37 ± 11.8% (k=2)
900	± 50 / ± 100	Body	55.0 ± 5%	1.05 ± 5%	0.32	0.93	7.90 ± 11.0% (k=2)
1810	± 50 / ± 100	Body	53.3 ± 5%	1.52 ± 5%	0.34	1.60	6.48 ± 11.0% (k=2)
2450	± 50 / ± 100	Body	52.7 ± 5%	1.95 ± 5%	0.75	0.62	6.30 ± 11.8% (k=2)

^c The validity of ± 100 MHz only applies for DASY v4.4 and higher (see Page 2). The uncertainty is the RSS of the ConvF uncertainty at calibration frequency and the uncertainty for the indicated frequency band.

Deviation from Isotropy in HSL

Error (ϕ , θ), $f = 900$ MHz

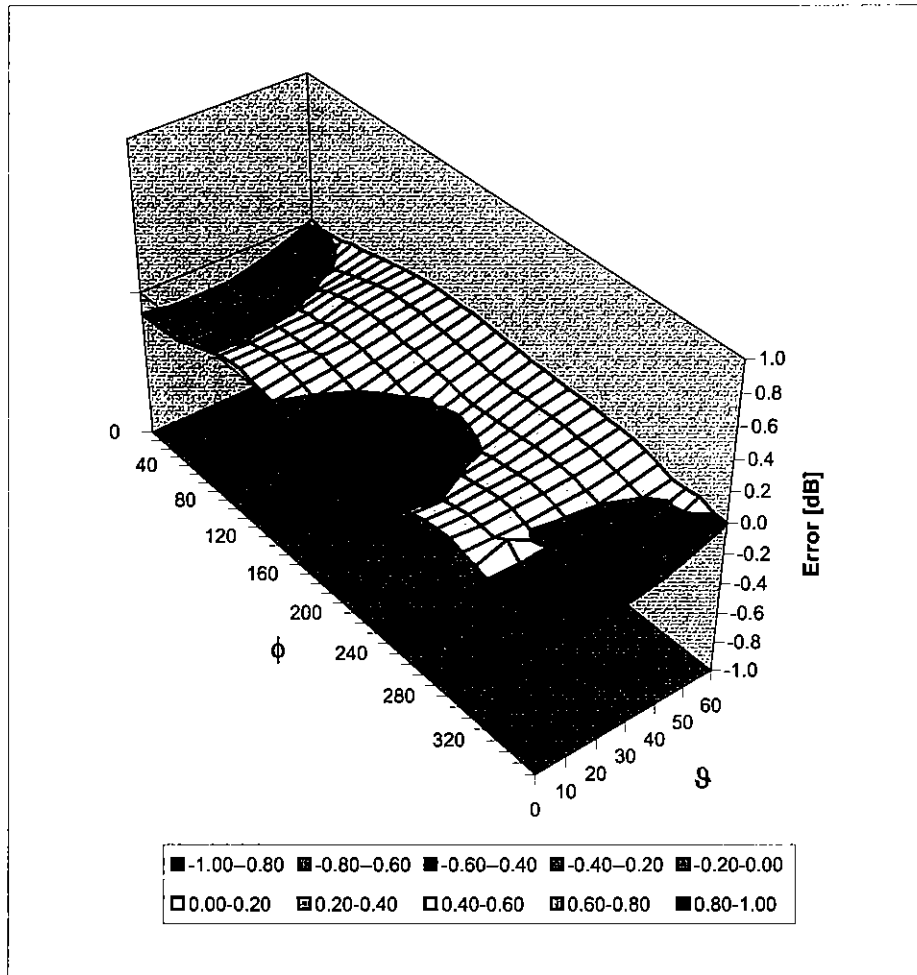

Uncertainty of Spherical Isotropy Assessment: $\pm 2.6\%$ ($k=2$)

Appendix^D

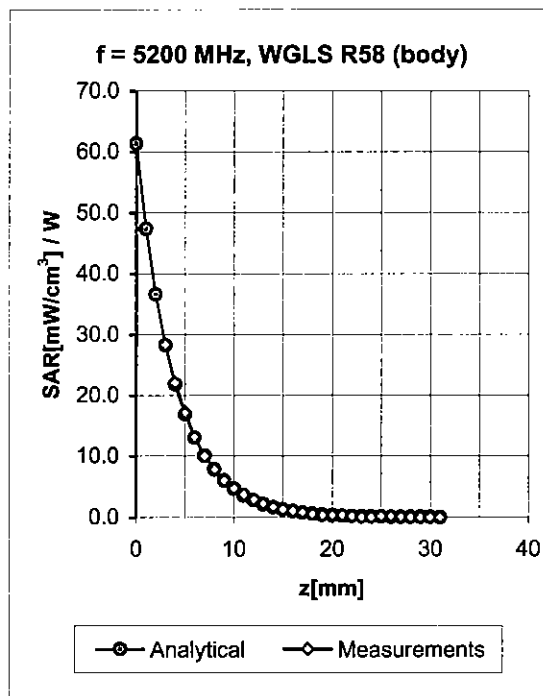
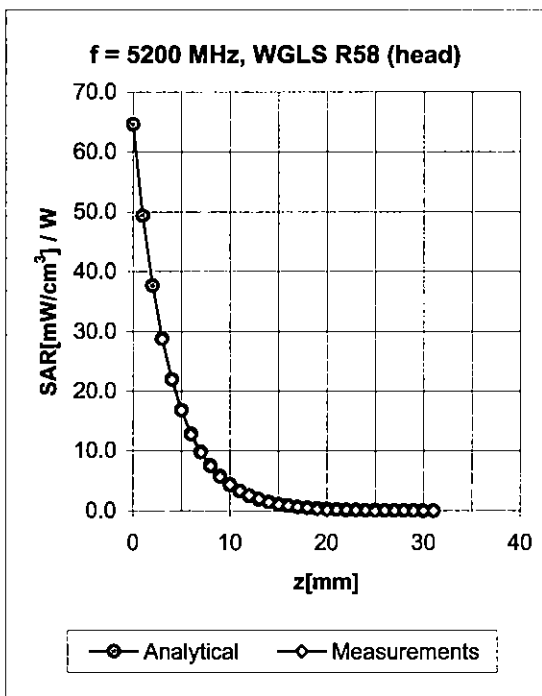

f [MHz] ^D	Validity [MHz]	TSL	Permittivity	Conductivity	Alpha	Depth	ConvF Uncertainty
5200	± 50	Head	36.0 ± 5%	4.76 ± 5%	0.49	1.36	4.26 ± 13.6% (k=2)
5800	± 50	Head	35.3 ± 5%	5.27 ± 5%	0.52	1.42	3.75 ± 13.6% (k=2)
5200	± 50	Body	49.0 ± 5%	5.30 ± 5%	0.50	1.63	4.10 ± 13.6% (k=2)
5800	± 50	Body	48.2 ± 5%	6.00 ± 5%	0.49	1.70	3.63 ± 13.6% (k=2)

^D Accreditation for ConvF assessment above 3000 MHz is currently applied for.