

## Chapter 1

- 1.1 Views of the Device
- 1.2 Get Started
- 1.3 Status Indicators
- 1.4 Enter Information

## Chapter 2

- 2.1 Today Screen
- 2.2 Start Menu
- 2.3 Ring tones and Notifications
- 2.4 General Settings
- 2.5 Security

## Chapter 3

- 3.1 Make a Call
- 3.2 Receive a Call
- 3.3 Video Telephony
- 3.4 In-Call Options
- 3.5 Special Dialing Requirements
- 3.6 Additional Settings

## Chapter 4

- 4.1 Automatic Setup of Your Data Connections
- 4.2 Manual Setup of Your Data Connections
- 4.3 Bluetooth
- 4.4 Beams

## 4.5 Connect to a Wireless LAN

### Chapter 5

#### 5.1 Text Messaging

#### 5.2 MMS

#### 5.3 E-mail

#### 5.4 Windows Live Messenger

### Chapter 6

#### 6.1 Introduction to ActiveSync

#### 6.2 Install and Configure ActiveSync

### Chapter 7

#### 7.1 Contacts

#### 7.2 Calendar

#### 7.3 Tasks

#### 7.4 Camera and Video Recorder

#### 7.5 Pictures and Videos

#### 7.6 Windows Media Player

#### 7.7 Internet Explorer Mobile

#### 7.8 Java

#### 7.9 Wireless Manager

#### 7.10 Notes

#### 7.11 Office Mobile

#### 7.12 Internet Sharing

#### 7.13 File Explorer

- 7.14 Windows Live
- 7.15 Remote Desktop Mobile
- 7.16 Remote Control
- 7.17 ClearVue PDF
- 7.18 Voice Speed Dial
- 7.19 FM Radio
- 7.20 Add More Programs to your device

## Chapter 8

- 8.1 Maintain Your Phone
- 8.2 Reset Your Phone
- 8.3 Manage Your Program Memory

## Appendix

- A.1 Regulatory Notices

## Chapter 1

1.5 Views of the Device

1.6 Get Started

1.7 Status Indicators

1.8 Enter Information

## 1.1 Views of the Device

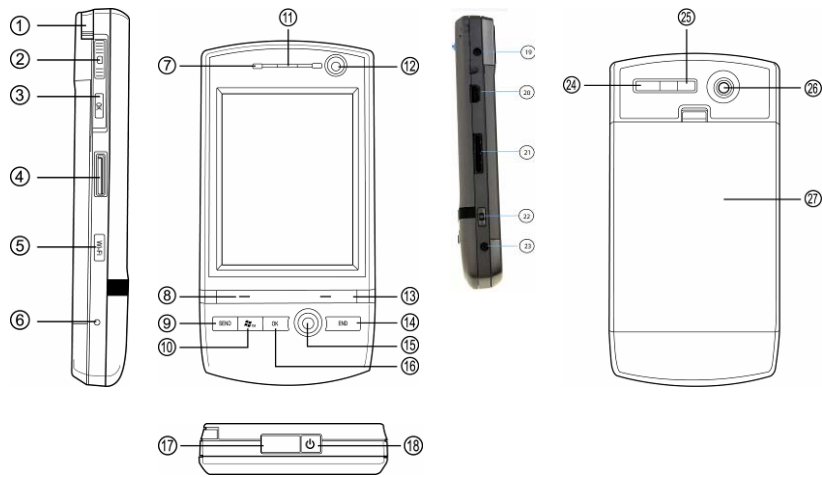

No.	Item	Function
1	Stylus	Use the stylus to write, draw or select items on the touch screen.
2	Jog Wheel	Scroll up or down to move through menus and program instructions. Press for 3 seconds then scroll up or down to adjust the volume.
3	OK Button	Press to confirm your data entries or to exit the program in use.
4	Micro SD Card Slot	Insert micro SD memory card with metal contacts facing downwards.
5	Wi-Fi Button	Press to access the <b>Wireless Manager</b> application.

6	Reset	Use the stylus to soft reset the device.
7	LED	Displays the status of the phone.
8	Left Soft Key	Opens the <b>Calendar</b> from the <b>Today</b> screen and performs the command shown in the label above the button.
9	SEND Key	Press this key to answer an incoming phone call or dial a number.
10	Windows Start Menu Button	Press to bring up the <b>Start</b> menu.
11	Earpiece	For use during phone calls.
12	Video Camera	For making video telephone calls with another party who has a 3G phone with this feature.
13	Right Soft Key	Opens the <b>Contacts</b> list from the <b>Today</b> screen and performs the command shown in the label above the button.
14	END Key	Press to end a phone call.
15	Action Button/ Navigation Controller	Action button - confirm the selection from the Navigation controller by pressing the centre button. Navigation controller - press this multi-directional control up, down, left, or right to move through menus or programs.
16	OK Button	Short Press – Backspace when typing. Long Press – Confirm your data entries or exit the program in use.
17	Infrared Port	Enables you to exchange files or data with other devices without cables or wires or use the device as a remote control.
18	Power Button	Press and hold for 2 seconds and then release to put the device in Standby mode. Press and hold for 5 seconds to shut down and turn off the device.
19	Wi-Fi Plug	External Wi-Fi antenna plug.

20	Mini-USB Connector	Connect the USB data cable to a PC for synchronization of information, data transmission and battery charging or use the device as an earphone jack or use the hands-free kit.
21	TV/VGA Out Connector	To send images to a TV, projector or monitor.
22.	Camera & Video Button	Press to launch the camera function and take a picture or record high quality video.
23	GSM/UMTS Plug	External GSM/UMTS antenna plug.
24	Video Microphone	Microphone for recording sound whilst recording a video.
25	Flash	White LED strobe flash.
26	Camera Lens	The CMOS camera supports a 2 mega-pixel resolution with auto-focus function for high quality colour photos or high quality video recording.
27	Battery Cover	To remove or replace the battery, push and slide out the battery cover.

## 1.2 Get Started

### Install the SIM/USIM Card

Follow these steps to install the SIM/USIM card provided by your local network service provider. The SIM/USIM card contains your phone number, service details and phonebook/message memory.

Your device supports both 3V and 1.8V SIM/USIM cards. Some legacy SIM/USIM cards will not function within this device. Consult with your service provider for a replacement SIM card. There might be a fee for this service.

1. Make sure your device is turned off.
2. Pull the battery cover catch up (away from the battery cover) and lift the battery cover up to remove it.
3. Lift the battery to remove it. Then, insert the SIM/USIM card into the SIM card slot with its gold contacts facing down (the cut-off corner of the SIM/USIM card should match the cut-off corner in the slot).
4. Replace the battery and gently push down to fit it into place.
5. Replace the battery cover.

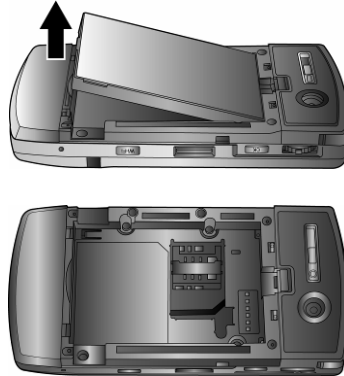



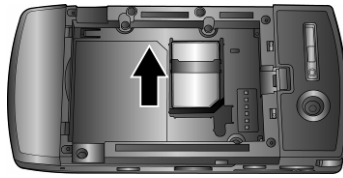



### Turn on the device

To turn **ON** the device, press and hold the **Power** button for 4 seconds. When you turn on the device for the first time, you will be asked to complete the screen calibration process. Calibrating the device screen involves tapping the centre of a cross with the stylus as the cross moves around the screen. This process ensures that when you tap the screen with your stylus, the tapped item is activated.

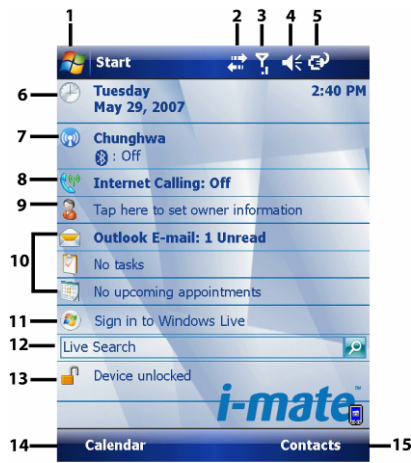
The **Today** screen displays important information, such as upcoming appointments and status indicators. You can tap a section on the screen to open the associated program. If at any point you need to access the **Today** screen, just tap **Start > Today**.



No.	Description	No.	Description
1	Tap to open the <b>Start</b> menu.	9	Displays the current owner information. Tap to change the details.
2	Tap to view the connectivity status.	10	Tap to open the related messages, tasks and appointments.
3	Indicates the radio signal strength. Tap to configure the phone settings.	11	Tap to sign into Windows Live.*
4	Tap to control device/ringer volume level.	12	Enter the word to search for and your device will connect to the internet and search using Microsoft Live Search.
5	Indicates the battery status. Tap to open the <b>Power Settings</b> screen.	13	Tap to lock or unlock the device.
6	Displays the current date and time. Tap to set up date, time, alarm, etc.	14	Shows the current function of the <b>left soft</b> key. Tap to open the <b>Calendar</b> screen.



















7	Tap to open the Wireless Manager. If the Wi-Fi  (left) and Bluetooth  (right) icons are displayed, they are available.	15	Shows the current function of the <b>right soft</b> key. Tap to open the <b>Contacts</b> screen.
8	Indicates the status of internet calling. Tap to change the status.		















**Note:** Not supported on all language versions of Windows Mobile Operating System.\*

To power **OFF** the device completely, press and hold the **POWER** button for 2 seconds and the system will prompt you to power off the device. In this state, the device cannot receive calls or text messages. To save battery power, your device will automatically go into standby mode if not used for a period of time.

### 1.3 Status Indicators

Status indicators appear at the top of the screen and on the **Today** screen. The following table lists common status indicators and their meanings.

Icon	Description	Icon	Description
	Battery level.		Voice call in progress.
	Battery is very low / Charge battery soon.		Calls are forwarded.
	Battery charging.		Call on hold.
	Battery fault.		Missed call.
	Ringer off.		GPRS Connection in progress.
	Ringer on.		GPRS Connected.
	New instant message.		GPRS available.
	Ringer in vibration mode.		Indicates if the device is locked / unlocked.
	New e-mail or text message.		Connected to the PC.

	There are more notifications. Tap the icon to view all.		Connected to the PC. Synchronization error.
	No SIM card installed.		Synchronization in progress
	Roaming.		Bluetooth
	No signal		Indicates Wi-Fi is turned on.
	Reception is turned off.		Wi-Fi network in range
	GSM signal strength. The number of bars indicates the signal strength.		Wi-Fi is connected
	3G in range		3G connected

## 1.4 Enter Information



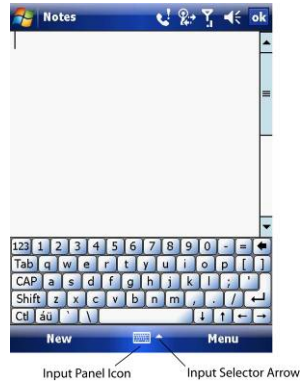

### Input Panel

Input Panel provides access to the various available input methods for your device, including **Block Recognizer**, **Keyboard**, **Letter Recognizer** and **Transcriber**. By default, the Input Panel icon appears on the menu bar to indicate which input method is currently selected. The Input Selector arrow (shown at the right side of the Input Panel icon) opens a list of available input methods.



**Note:** Not supported on all language versions of Windows Mobile Operating System.

The following input methods are available when text entry is possible.

Icon	Input Method
	Press to switch the keyboard input on or off.
	Input Panel Icon / Press the Input Selector Arrow to change input methods.
	Letter Recognizer or Block Recognizer.
	Transcriber.

## Draw and Write on the Screen

With your device, you can draw directly on the screen or write on the screen and save notes (**Start > Programs > Notes**) in your own handwriting. If you prefer to use handwriting or frequently add drawings to your notes, you may find it helpful to set **Writing** as the default input mode. If you prefer typed text, set **Typing** as the default input mode.

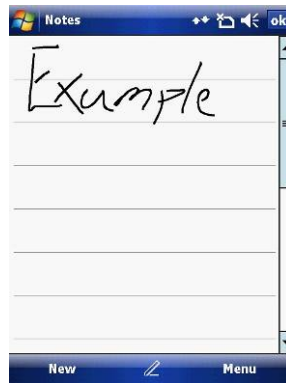



To change the default input mode in **Notes**, tap **Menu > Options** in the notes list and then, in the **Default mode** box, tap either **Writing** or **Typing**, depending on your personal preferences. Tap **OK**.

## Voice Recording

You can create a standalone voice recording or you can add a recording to a note.

### Create a voice note

1. Tap **Start > Programs > Notes**.
2. If you do not see the **Recording Toolbar**, tap **Menu > View Recording Toolbar**.
3. Tap the record icon  to begin recording.
4. Hold your device's microphone near your mouth or other audio source.
5. Tap the stop icon  when finished recording.

### Change recording formats

1. Tap **Start > Settings > Personal tab > Input**.
2. Tap the **Options** tab and in the voice recording format list, tap the format you want.
3. Tap **OK**.



## Chapter 2

2.1 Today Screen

2.2 Start Menu

2.3 Ring tones and Notifications

2.4 General Settings

2.5 Security

## 2.1 Today Screen

The **Today** screen shows your upcoming appointments, active tasks, and information about e-mail messages.

### Customise background items on the Today Screen

1. Tap **Start > Settings > Personal tab > Today**.
2. On the **Appearance** tab, select the desired theme for the background of the **Today** screen. You can use one of your own pictures as the background image on the **Today** screen by selecting the **Use this picture as the background** check box and tap **Browse** to view a list of your picture files.
3. On the **Items** tab, select the items you want to appear on the **Today** screen. To change the order of items displayed on the **Today** screen, tap the item and then tap **Move Up** or **Move Down**.
4. Tap **OK**.

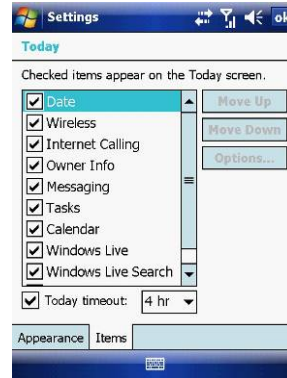
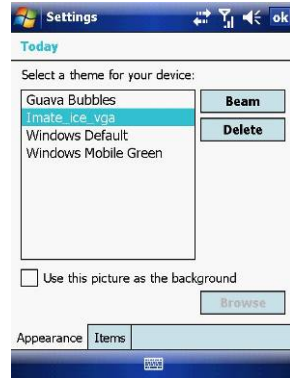

## Enter Owner Information

Entering and displaying Owner Information on the **Today** Screen is recommended and allows someone to return the device if lost.

1. Tap **Start > Settings > Personal tab > Owner Information**.
2. In the **Identification** tab, enter your personal information.

If owner information is displayed on the **Today** screen, you can open and edit the information directly from it. Just tap that section of the screen.

## 2.2 Start Menu

The **Start** menu, located at the top left corner of the **Today** screen, displays a list of programs. It lets you close a screen and switch from one program to another. You can start a program by scrolling through the programs list and then pressing **Enter** or by tapping a program with the stylus.

You can choose which items appear in the **Start** menu:

1. Tap **Start > Settings > Personal tab > Menus**.
2. Select the check boxes of the items you want to appear in the **Start** menu.  
You can select up to seven items.

### Create folders and shortcuts

You can also create folders and shortcuts that appear on the **Start** menu. Open **ActiveSync** on your PC, click **Explore**. In the Mobile Device window, double click **Mobile Device > Windows > Start Menu**, then create the folders and shortcuts that you want. You will see the added items after you synchronize.

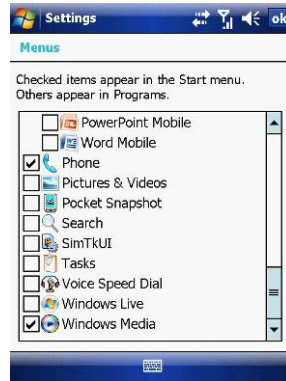

## 2.3 Ring tones and Notifications

### Change ring tones

1. From the **Phone** screen, tap **Menu > Options > Phone** tab.
2. In the **Ring tone** list, tap the sound you want to use.

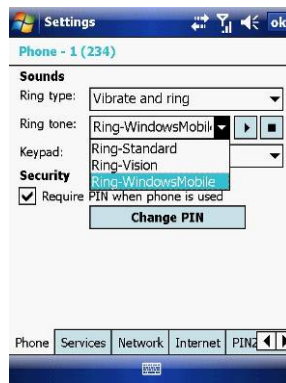

**Note:** To use custom \*.wav, \*.mid, \*.mp3, or \*.wma files as ring tones, use ActiveSync on your PC to copy the file to the **Windows/Rings** folder on your device. Then, select the sound from the ring tone list. For more information about copying files to your device, see ActiveSync Help on your PC.

### Assign ring tones to Contacts

It is also possible to assign a specific ring tone to a Contact:

1. Go to **Start > Contacts** and tap on the desired Contact.
2. Select **Menu > Edit**.
3. In the **Ring tone** field, select your desired ring tone.

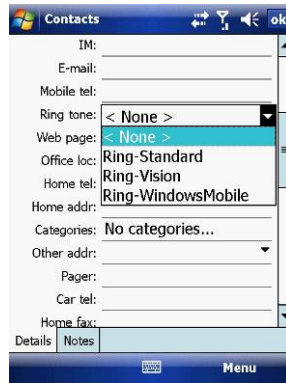

### Change the ring type

You can change the way that you are notified of incoming calls. For example, you can choose to be notified by a ring, vibration or a combination of both.

1. From the Phone keypad, tap **Menu > Options > Phone** tab.
2. In the **Ring type** list, tap the desired option.

### Set an alarm

1. Tap **Start > Settings > System** tab > **Clock & Alarms > Alarms** tab.
2. Tap **<Description>** and enter a name for the alarm.
3. Tap the day of the week for the alarm. You can select multiple days by tapping each desired day.
4. Tap the time to open a clock and set the time for the alarm.
5. Tap the alarm icon  to specify the type of alarm you want. You can choose a flashing light, a single sound, a repeating sound or vibration.
6. If you choose to play a sound, tap the list next to the **Play sound** check box and tap the sound you want.

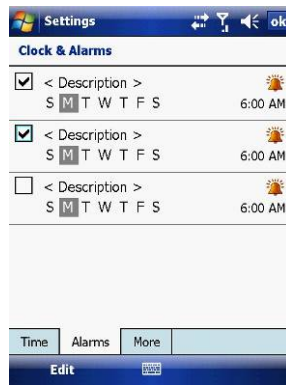

### Choose how to be notified about events or actions

1. Tap **Start > Settings > Personal tab > Sounds & Notifications**.
2. On the **Sounds** tab, choose how you want to be notified by selecting the appropriate check boxes.
3. On the **Notifications** tab, tap an event name and choose how you want to be notified by selecting the appropriate check boxes. You can choose from several options, such as a special sound, a message, or a flashing light.

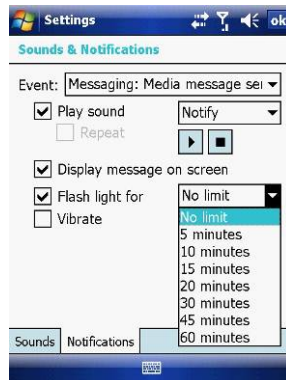

## 2.4 General Settings

### Set the time and date:

1. Tap **Start > Settings > System tab > Clock & Alarms.**
2. Select the correct time zone and change the date or time.

### Set the time and date for a different location

If you visit or communicate with someone in a particular time zone often, you can select it as your visiting time zone.

1. Tap **Start > Settings > System tab > Clock & Alarms.**
2. Tap **Visiting.**
3. Select the correct time zone and change the time or date.

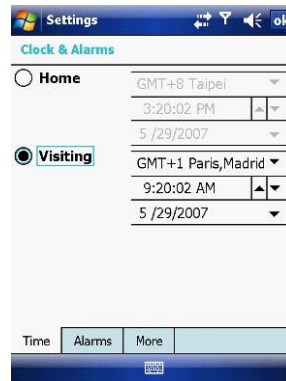
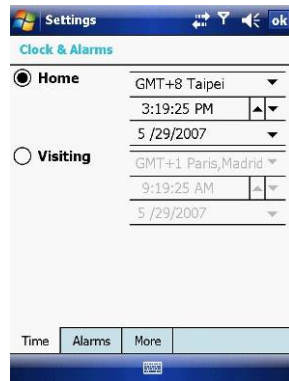



## Change language and regional settings

The style in which numbers, currency, dates, and times are displayed is specified in regional settings.

1. Tap **Start > Settings > System tab > Regional Settings**.
2. On the **Region** tab, select your region and language.
3. The region you select determines which options will be available on the other tabs.
4. To customise settings further, tap the appropriate tabs and select desired options.



## Reassign programs or shortcuts to program buttons

1. Tap **Start > Settings > Personal tab > Buttons**.
2. A list of buttons and their current assignments is displayed on the **Program Buttons** tab.
3. Tap the button you want to reassign. To help you identify the buttons, there are numbers and icons representing their original functions.
4. In the **Assign a program** box, tap the program or shortcut to assign.
5. Tap **OK**.

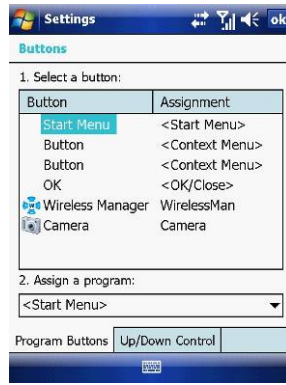

### Increase or decrease screen text size

1. Tap **Start > Settings > System tab > Screen > Text Size** tab.
2. Move the slider to increase or decrease the text size.

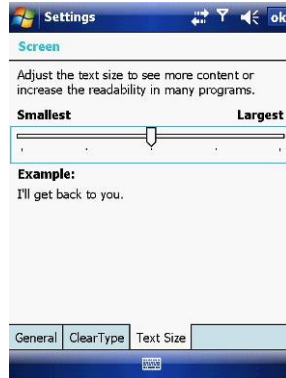

## Adjust the speed for scrolling

1. Tap **Start** > **Settings** > **Personal** tab > **Buttons** > **Up/Down Control** tab.
2. Do one of the following:
  - Under **Delay before first repeat**, move the slider to shorten or lengthen the time that elapses before scrolling begins.
  - To change the time it takes to scroll from one item to the next, under **Repeat rate**, move the slider to adjust the speed.

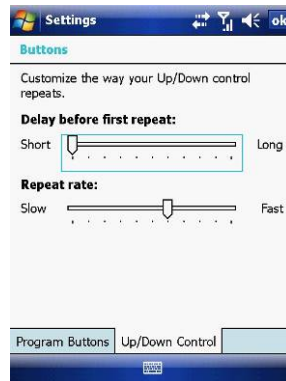

## Change the device name

1. Tap **Start** > **Settings** > **System** tab > **About**.
2. Tap the **Device ID** tab.
3. Enter a name.

The device name is used to identify the device in the following situations:

- Synchronizing with a PC.
- Connecting to a network.
- Restoring information from a backup.



**Note:** The device name must begin with a letter, consisting of letters from A to Z, numbers from 0 to 9, and cannot contain spaces. Use the underscore character to separate words. If you synchronize multiple devices with the same PC, each device must have a unique name.

### Make the battery last longer

1. Tap **Start > Settings > System tab > Power**. On the **Advanced** tab, you can specify when your device turns off, to conserve battery power. For optimum conservation, specify 3 minutes or less.
2. Use the AC adapter to plug your device into external power whenever possible, especially when using a microSD card, a modem or other peripheral.
3. Adjust the backlight settings.

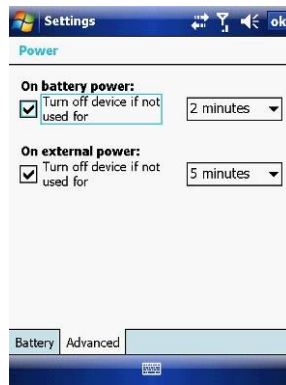

### **Adjust backlight brightness**

1. Tap **Start > Settings > System tab > Backlight > Brightness** tab.
2. Move the sliders right to increase the brightness or left to decrease it.

### **Set the backlight to dim after a time delay**

1. Tap **Start > Settings > System tab > Backlight**.
2. Tap the **Battery power** tab or the **External power** tab.
3. Select the **Turn off backlight if device is not used for** check box and specify the time delay.

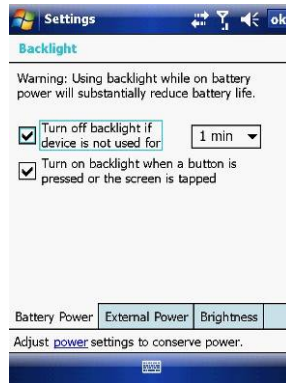

## Close a program

In most cases, programs automatically close to free needed memory. However, you can close programs manually.

1. Tap **Start > Settings > System > Memory** tab > **Running Programs**.
2. In the **Running Programs** list, tap the program you want to close and tap **Stop**.



## Change the orientation of the screen

You can use your Pocket PC in landscape or portrait modes, depending on how you wish to use the device.

1. Tap **Start > Settings > System tab > Screen > General tab**.
2. Choose whether you wish to use the device in **Portrait** or **Landscape** modes. **Landscape** can be right or left-handed. Tap **OK** to make the changes.

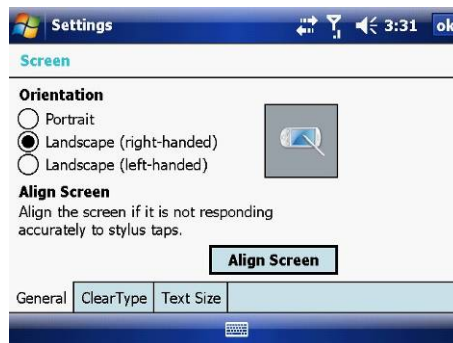
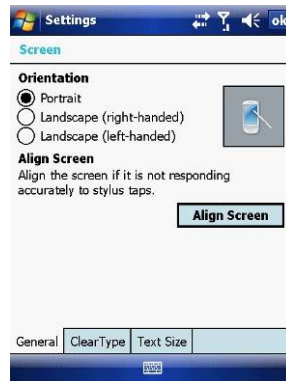

## 2.5 Security

### SIM Security

To protect your phone with a PIN:

1. From the Phone screen, tap **Menu > Options > Phone** tab.
2. Tap **Require PIN** when the phone is used.
3. To change the PIN at any time, tap **Change PIN**.

**Note:** Emergency calls can be placed at any time, without a PIN.

### Protect your device with a password

You can help keep your data more secure by requiring a password every time the device is turned on.

1. Tap **Start > Settings > Personal** tab > **Lock**.
2. Select the **Prompt if device unused for** check box. In the box to the right, select how long your device must be turned off before a password is needed. In the **Password type** box, select the type of password you want to use. Enter the password and, if necessary, confirm it. If the device is configured for network connection, use a strong password for better network security.
3. On the **Hint** tab, enter a phrase that will help you remember your password but does not allow others to guess it. The hint will be displayed after the wrong password is entered four times.
4. Tap **OK**. The next time the device is turned on you will be prompted to enter your password.

**Note:** Each time a wrong password is entered, the time the device takes to respond will get longer and longer until the device appears to be not responding. If you forget your password, you must follow the instructions in your owner's manual to clear memory before you can access your device.

### Change your password

1. Tap **Start > Settings > Personal** tab > **Lock**. You will be prompted to enter your current password.
2. In the **Password** box, enter your new password.
3. On the **Hint** tab, enter a phrase that will help you remember your new password but does not allow others to guess your password. The hint will be displayed after the wrong password is entered four times.
4. Tap **OK**.



## **Encrypt your files**

1. Tap **Start > Settings > System tab > Encryption**.
2. Select **Encrypt files placed on storage cards** to encrypt files as they are placed on a storage card.

## Chapter 3

3.1 Make a Call

3.2 Receive a Call

3.3 Video Telephony

3.4 In-Call Options

3.5 Special Dialing Requirements

3.6 Additional Settings

## 3.1 Make a Call

Like a standard mobile phone, you can use your i-mate™ Windows Mobile® Pocket PC Phone to make, receive and keep track of calls. You can also take notes while talking, dial directly from **Contacts** and easily copy SIM/USIM contacts to **Contacts** on the device.

In order to make calls, you will need to insert your SIM/USIM card into the device as described in *Chapter 1*. Most SIM/USIM cards are preset with a PIN (personal identification number), provided by your wireless service provider. If this option is enabled in your SIM/USIM card, you will be prompted to enter the PIN when the unit is switched on.

**Note:** If your PIN is entered incorrectly three times, the SIM/USIM card will be blocked. If this happens, you can unblock it with the PUK (PIN Unblocking Key) obtained from your wireless service provider.

You can make a call from **Phone**, **Contacts**, **Speed Dial**, **Call History** and **SIM/USIM Manager**.

### **Make a call from the Phone screen**

On the **Phone** screen:

1. Tap the desired phone number and then tap the **SEND** button.
2. To open the Phone screen, either use the stylus to tap **Start > Phone** or press the **SEND** button.



### **Make a call from the Contacts screen**

1. Tap **Start > Contacts**.
2. To search for a contact, enter the desired name and number in the search field, or tap the letter corresponding to the name in the alphabet bar.
3. Tap the desired contact and tap **Call** or press the **SEND** button.

You can also tap the desired contact in the **Contacts** list and tap the phone number that you want to call. Or, tap and hold the desired contact. On the shortcut menu, tap **Call Work**, **Call Home**, or **Call Mobile**.

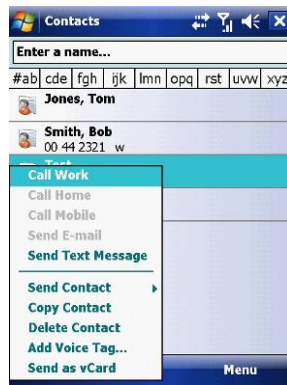

By default, the mobile telephone number (m) of a contact is dialed when you make a call from **Contacts**. However, you can specify that a different phone number is used instead.

1. Tap **Start > Contacts**.
2. Press the **Navigation Controller** up or down to select the contact.
3. Press the **Navigation Controller** left or right. The letters representing the number will change as you scroll through them.

### **Make a call from Call History**

1. On the **Phone** screen, tap **Call History**.
2. Tap **Menu > Filter** and tap a category.
3. Scroll to the desired contact or phone number and tap **Call** or press the **SEND** button.

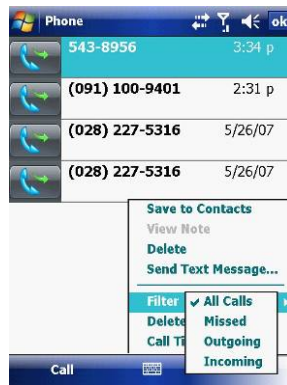

### Make a call from Speed Dial

Use **Speed Dial** to call frequently-used numbers with a single tap. For example, if you assign a contact to **Location 2** in **Speed Dial**, you can tap and hold it on the **Phone** screen to dial the contact's number. Before you can create a **Speed Dial** entry, the number must be in **Contacts**. To create a **Speed Dial** entry:

1. On the **Phone** screen, tap **Speed Dial**.
2. Tap **Menu > New**.
3. Tap a contact. Tap the phone number for which you want to create a **Speed Dial** entry.
4. In the **Location** box, select an available location for the new **Speed Dial** entry.



**Note:** To create a **Speed Dial** entry from **Contacts**, tap and hold the contact name, tap **Menu** > **Add to Speed Dial** and select an available location for the new **Speed Dial** entry. To delete a **Speed Dial** entry, in the **Speed Dial** list, tap and hold the desired entry and tap **Delete**.

### **Make an emergency call**

To make an emergency call, just enter the emergency phone number for your location and press **SEND**.

**Note:** You can make calls to emergency services under any circumstances, even if you have enabled the SIM PIN or locked the device. The ability to make emergency calls depends on network availability.

## 3.2 Receive a Call

When you receive a phone call, a message will appear, giving you the option to either answer or ignore the incoming call.

1. To answer the call, tap **Answer** or press the **SEND** button.
2. To reject the call, tap **Ignore** or press the **END** button.

### **End a call**

Once an incoming or outgoing call is in progress, you can tap **End** or press **END** on the device to hang up.



### 3.3 Video Telephony

Tapping the **Video Call** button allows you to make a VT (video telephone) call.



Image from VT UI flow

No	Item	Description
1	Call Duration	Displays the length of the video call.
2	Caller Image	Displays the caller image.
3	Keypad	Tap to return to the keypad.
4	Brightness	Use + and - to increase or decrease the screen brightness.
5	Camera	Turns on or off the caller image.
6	Internal / External Camera	Switches between the camera facing you and the camera pointing away from you.
7	Speaker	Turns the speaker on/off.
8	View Mode	There are 4 view modes available, tap this button to switch between them: <b>Only Receiver</b> - Displays only the person you are calling. <b>Only Sender</b> - Displays your image only. <b>Standard Mode</b> - Displays both the caller and

		the receiver (the sender is smaller). <b>Sender is large</b> - The sender image is large and the receiver image is small.
9	Menu	Contains: <b>Hold</b> - Places the current call on hold <b>Mute</b> - Mutes the speaker <b>Turn Speakerphone On</b> – Turns the speaker phone on or off. <b>Turn Handsfree On</b> - Turns handsfree on or off. <b>Conference</b> <b>Paste</b> <b>Save to contacts</b> <b>Create note</b> <b>Call history</b> <b>Speed dial</b> <b>Options</b> <b>Video call options</b>
10	End	Ends the call.
11	Receiver Image	See the person who receives your call.

The above table needs to be applied when the video telephony module is installed.

## 3.4 In-Call Options

### Put a call on hold

If this option is enabled, your device notifies you when you have another incoming call and gives you the choice of rejecting or accepting the call.

If you are already on a call and accept the new call, you can choose to switch between the two callers or set up a conference call between all three parties.

- Tap **Answer** to take the second call, which will put the first call on hold.
- To end the second call and return to the first call, tap **End** or press the **END** button on your device.

To switch between calls, tap **Swap** or press the **SEND** button.

### Set up a conference call

1. Either put a call on hold and dial a second number or accept a second incoming call when you already have one in progress.
2. Tap **Conference**.

**Note:** Not all service providers support conference calling. Contact your service provider for details.

### Turn on and off the speakerphone

The built-in speakerphone on your device allows handsfree operation or lets other people listen to the conversation. To activate the speakerphone mode, press and hold the **SEND** button or tap **Speaker On** on the screen. The

speakerphone icon  will appear in the title bar. To turn off the speakerphone, tap **Speaker Off**.

### Mute a call

You can turn off the microphone during a call so that you can hear the caller but the caller cannot hear you. During a call, tap **Mute**.

- When the microphone is turned off, the mute icon will appear on the screen.
- Tap **Unmute** to turn on the microphone again.

## 3.5 Special Dialling Requirements

### **Insert a pause in a dialling sequence**

Calls to certain networks may require a pause in between the dialled digits:

1. Tap **Start > Contacts**.
2. Click the contact whose phone you want to insert a pause.
3. Select the phone number and add a 'p' character where you want to insert a 3 second pause.
4. Select the phone number and add a 'w' character where you want to insert a manual pause.
5. To resume dialling after reaching a manual pause, press **SEND**.

### **Insert an International Country Code**

To make an international call, you must insert a country code at the beginning of the dialling sequence for the phone number. Tap and Hold '0' on the **Phone** screen until a (+) sign appears and then insert the rest of the number.

## 3.6 Additional Settings

### Phone services

Phone Services, such as **Call Waiting**, enable you to choose how to handle all incoming calls on your device.

### Choose services

1. Tap **Start > Settings > Personal tab > Phone > Services** tab.
2. Tap the service you want to use and tap **Get Settings**.

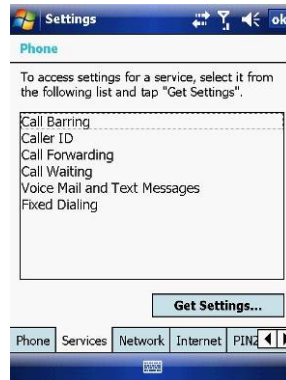

### Networks

You can view available wireless networks, determine the order in which your device accesses another network if the current one is unavailable, and specify whether you want to change networks manually or automatically.

### Change phone network settings

1. Tap **Start > Settings > Phone > Network** tab.
2. By default, your device displays the current network as offered by your service provider. You can customise this to your preferred network.

## Set preferred networks

1. Tap **Start > Settings > Phone > Network** tab. By default, network selection field is set to **Automatic**. However, you can set it to **Manual** to choose your own network at any point of time.
2. Tap **Set Networks**.
3. Select the networks in **Preferred networks** and sort them according to your preference.
4. Tap **OK**.

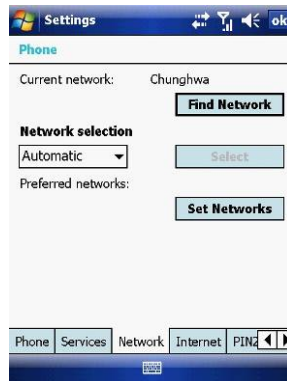

## Change the keypad tone

You can change the tone you hear when entering a phone number on the keypad. If set to **Long tones**, the tone is heard continuously for as long as the number on the keypad is tapped. Use this setting if you are having trouble accomplishing tasks that rely on tones from your phone such as accessing messages from an answering machine. If set to **Short tones**, the tone is heard only for one or two seconds. If set to **Off**, no tone will be heard.

1. From the **Phone** screen, tap **Menu > Options > Phone** tab.
2. In the Keypad list, tap the option you want.

## Automatic answering

You can set the phone to automatically answer calls when using the headset. To do this:

1. From the **Today** screen, tap **Start > Settings > Personal tab > Phone > Auto-answer** tab.
2. Tap the **When using headset, auto answer after** check box.
3. Select the number of seconds from the drop down menu.

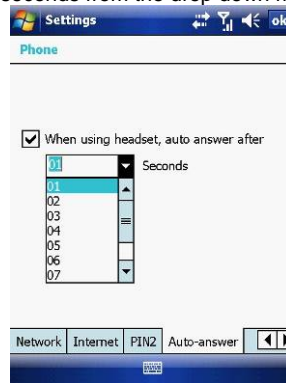

## Band settings

The default network type and GSM/UMTS band is set to **Auto**. However, this can be changed by the following:

1. From the **Today** screen, tap **Start > Settings > Personal tab > Phone > Band** tab.
2. Tap **Select your network type**.
3. Select your preferred network type.
4. Tap **Select your GSM/UMTS band**.
5. Select your preferred GSM/UMTS band type.

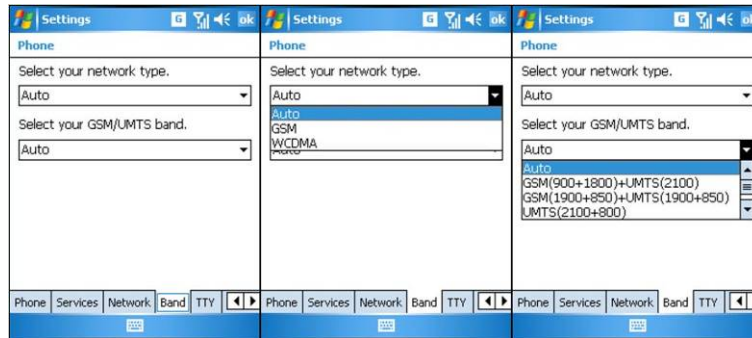

## Chapter 4



- 4.1 Automatic Setup of Your Data Connections
- 4.2 Manual Setup of Your Data Connections
- 4.3 Bluetooth
- 4.4 Beams
- 4.5 Connect to a Wireless LAN

## 4.1 Automatic Setup of Your Data Connections

Your device is equipped with powerful networking functions that enable you to connect to the Internet through a General Packet Radio Service (GPRS) network.

GPRS is a service that allows information to be sent and received across a mobile telephone network.

Your device is able to configure itself for data services from many of the major GSM/GPRS operators across the world. Simply insert your SIM/USIM card and switch on your device. When the device powers on it will prompt for the configuration steps and configure itself for Web, MMS, and WAP services. If the settings are not known for your operator, the device will notify you and you will need to enter them manually.

**Note:** The use of Web, WAP and Multimedia Messaging Services is subject to your Mobile Service Provider. You must ensure that your subscription has Web, WAP and MMS before using those services.

## 4.2 Manual Setup of Your Data Connections

You can set up connections to the Internet or to a corporate network and exchange e-mail or instant messages.

Your device has two connection setting categories: **My ISP** (Internet Service Provider) and **My Work Network**. The **My ISP** settings are used to connect to the Internet, and the **My Work Network** settings can be used to connect to any private corporate network.

To ensure that both **My ISP** and **My Work Network** connections are displayed:

- Tap **Start > Settings > Connections** tab > **Connections > Advanced** tab > tap the **Select Networks** button.
- From **Programs that automatically connect to the Internet**, select **My ISP**.
- From **Programs that automatically connect to a private network**, select **My Work Network**.

### Connect to the Internet via ISP

Obtain the following information from your ISP:

- Access point name or server phone number.
- User name (if required).
- Password (if required).
- Domain (if provided by an ISP or a network administrator).
- Proxy settings (if required).

1. Tap **Start > Settings > Connections** tab > **Connections**.
2. Tap **Add a new modem connection**.
3. Enter a name for the connection.
4. Select a modem from the list. For example, if you want to use the mobile phone network, select **Cellular Line** or **Cellular Line (GPRS)**.
5. Tap **Next**.
6. Complete the Connection Wizard by entering the required information and tapping **Finish**.



### Connect to a private network

Obtain the following information from your ISP:

- Access Point name or server phone number.
- User name (if required).
- Password (if required).
- Domain (If provided by an ISP or a network administrator).
- Proxy settings (if required).

1. Tap **Start > Settings > Connections** tab > **Connections**.
2. In **My Work Network**, follow the instructions for each type of connection.
3. Once finished, tap **Edit my proxy server** and enter the Proxy Information, including any WAP Proxy required by the operator if you are setting up a connection to their WAP site.
4. Complete the Connection Wizard and tap **Finish**.

### Connect to a VPN using the Internet

Please ensure that you have setup a successful GPRS / Wi-Fi connection. The VPN connection uses existing Internet connections to connect to your work network. Refer to the next section, *Connect to an Intranet URL*, for more information.

1. If the Work Connection is not being used for any other connection, tap on **Add a new VPN server connection** and skip to step 4.
2. Tap **Start > Settings > Connections > Connections > Advanced tab > tap Select Networks.**
3. Create a new connection to a private network by tapping **New...** under the **Programs that automatically connect to a private network** list. This new network connection must be selected from this menu when necessary to connect to a VPN. Assign a name for your choice and tap the **VPN tab > New.**
4. Complete the VPN setup wizard using the settings provided by your network administrator, which should include Host Name/IP, VPN Type, User Name, Password and Domain.



5. If you selected **IPSec VPN type**, tap **Next** to select the type of authentication required. If **Pre-Shared** key is selected, enter the key.
6. Check the advanced settings and complete the settings according to the instructions from your network administrator.

## Connect to an Intranet URL

A work URL exception tells Internet Explorer Mobile and/or ActiveSync to look on the work network to find that URL instead of searching the Internet. This also has to be setup if you wish to browse intranet websites through your VPN connection:

1. On the **Today** screen, tap **Start > Settings > Connections > Advanced > Exceptions**.
2. In **Work URL Exceptions**, tap **Add new URL** and enter the URL. Tap **OK**.

**Note:** Separate multiple URLs with a semicolon.

You should not create URL exceptions for URLs on the Internet. An Intranet URL can be either an IP address or FQDN (Fully Qualified Domain Name).

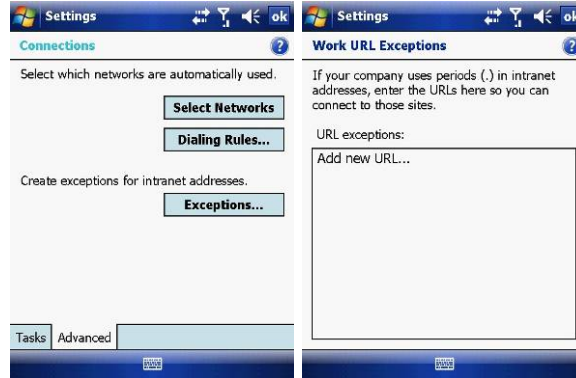

## 4.3 Bluetooth

Bluetooth is a short-range wireless communications technology. Devices with Bluetooth capabilities can exchange information over a distance of about 10 meters without a physical connection. You can even beam information to a device in a different room as long as it is within the Bluetooth signal coverage range.

The software included with your device allows you to use Bluetooth in the following ways:

1. Beam information such as files, appointments, tasks and contact cards between devices that have Bluetooth capabilities.
2. Use a Bluetooth headset.

### Turn Bluetooth on or off

1. On your device, tap **Start > Settings > Connections tab > Wireless Manager**.
2. Select **Turn on Bluetooth**.
3. Tap Bluetooth **Settings > Mode** tab. Check the **Make this device visible to other devices** box if you want your device to be visible to other Bluetooth users within a range of approximately 10 meters.
4. Tap **OK**.

### Create a Bluetooth partnership

A Bluetooth partnership is a relationship that you create between your device and another Bluetooth enabled device in order to exchange information in a secure manner. Creating a partnership between two devices involves entering the same personal identification number (PIN) or Passkey on both devices. Creating a partnership between two devices is a one-time process. Once a partnership is created, the devices can recognize the partnership and exchange information without requiring a PIN. Make sure the two devices are within a range of 10 meters from one another and that Bluetooth is on and discoverable.

1. On the **Today** screen, tap **Start > Settings > Connections tab > Bluetooth**.

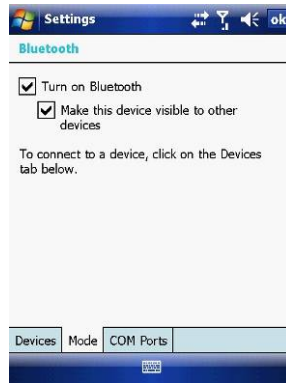

2. On the **Devices** tab, tap **Add new device**. Your device searches for other Bluetooth devices and displays them in the box.



3. Tap the desired device name in the box and tap **Next**.



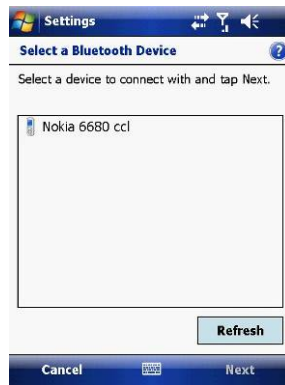

4. Enter a passkey to establish a secure connection. The passkey must be between 1 and 16 characters.
5. Tap **Next**.



6. Enter the same passkey that is entered on the other device. You can, however, edit and enter a new name for the other device.
7. Tap **Finish** after checking the services offered by the other Bluetooth device.



### Accept a Bluetooth partnership

1. Ensure that Bluetooth is turned on and discoverable.
2. Tap **Yes** when prompted to establish a partnership with the other device.
3. Enter a passkey (the same passkey that is entered on the device requesting the partnership) to establish a secure connection. The passkey must be between 1 and 16 characters.
4. Tap **Next**.
5. Tap **Finish**. You can now exchange information with the other device.

### Rename a Bluetooth partnership

1. On the **Today** screen, tap **Start** > **Settings** > **Connections** tab > **Bluetooth**.
2. Tap and hold the partnership on the **Devices** tab.
3. On the shortcut menu, tap **Edit**.
4. Enter a new name for the partnership.
5. Tap **Save**.

## Delete a Bluetooth partnership

1. On the **Today** screen, tap **Start > Settings > Connections** tab > **Bluetooth**.
2. Tap and hold the partnership on the **Devices** tab.
3. Tap **Delete** from the shortcut menu.



## 4.4 Beams

The term Beam is used to describe the short range transferring of information between two units via Bluetooth. An example of beaming could be sending the details of a contact to another Windows Mobile device.

By default, the option to receive incoming beams is disabled for security and battery conservation. Make sure that **Receive All Incoming beams** is enabled in **Start > Settings > Connections > Beam**.



## Beam an item

In the **Calendar**, **Contacts**, **Notes**, **Tasks** and **Pictures** programs, you can beam files and information to other devices using Bluetooth.

1. From the program, select the item you want to beam, such as an appointment in **Calendar**, a task in **Tasks**, a contact card in **Contacts**, or a picture in **Pictures**. In **Calendar**, first open the appointment in **Agenda view**.
2. Different applications have different ways of beaming:
  - In **Calendar**, tap **Menu** > **Beam**.
  - In **Contacts**, tap **Menu** > **Send Contact** > **Beam**.

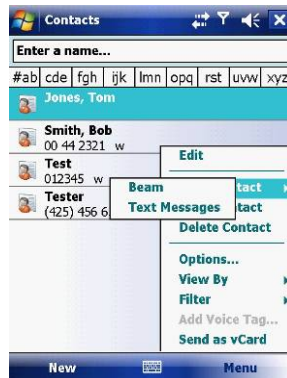

3. Via Bluetooth, select the device to which you want to send the item.
4. Tap on **Tap to Send**.

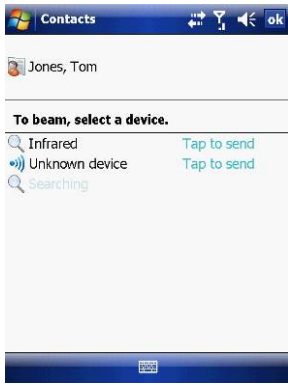

## 4.5 Connect to a Wireless LAN

### Connect to a Wi-Fi network

1. On the **Today** screen, tap **Start > Settings > Connections** tab > **Wireless Manager**. You may also access **Wireless Manager** from the **Today** screen or by pressing the Wi-Fi button on the left side of the device.
2. Press the **Wi-Fi** button to turn the wireless function on and off.



3. When the Wi-Fi function is turned on, the device will start scanning for available networks and will prompt the user to select one. Select whether this network is used to connect to **The Internet** or as a **Work** connection and enter the password for this access point, if requested.

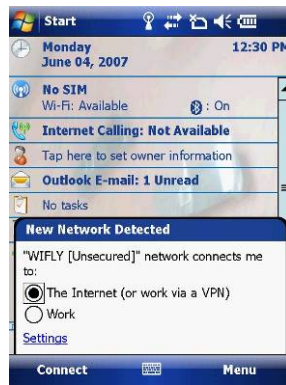

4. To configure the required settings on the **Wireless Manager** screen, tap **Settings** next to each of the wireless functions. When the configuration is completed, you can connect to a Wi-Fi network using your device.



## Check Wireless LAN status

You can check the current wireless connection status from the following the screens of your device:

- Tap **Start > Settings > Connections > Wi-Fi** or tapping the  icon on the title bar provides information about the connection status and signal quality for the current connection.



- To manually configure your connection, tap **Start > Settings > Connections tab > Network Cards**. This screen displays the wireless networks currently available and allows you to change the connection settings and create new connections to other access points not broadcasting their **SSIDs**.

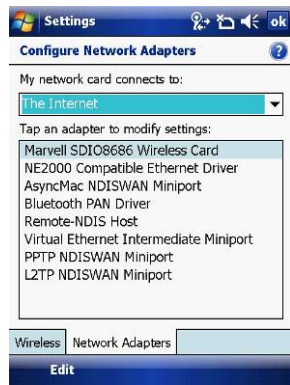

On <http://www.clubimate.com> you can find step-by-step guidelines for connecting your device to public and private Wi-Fi access points. Those guidelines are also available in the CD that came with your device.

## Chapter 5

5.1 Text Messaging

5.2 MMS

5.3 E-mail

5.4 Windows Live Messenger

This chapter describes how you can create or delete, send or receive, and organise or store your messages in the phone. The following types of messages are all stored under the Messaging Application:

- Text message (SMS - Short Message Service)
- E-mail messages
- Multimedia messages (MMS)

Real-time messaging is also possible on your device by signing into the MSN Messenger application, as explained in this chapter.

## 5.1 Text Messaging

Text Messaging is a popular way of sending short messages to other mobile phone users and, in some countries, to land lines as well. Each text message is a maximum of 160 characters long. In some countries the maximum size is 70 characters if accents or other special characters are used. Your device will automatically join multiple texts together.

### Create a text message

1. On the **Today** screen, tap **Start > Messaging**.
2. Select an account from the list. You are automatically taken to the **Inbox** of the chosen account.
3. From the bottom of the screen, press **Menu > New**.
4. In the **To:** field, enter the mobile phone number of the recipient. Insert a semicolon (;) between multiple recipients. You may also choose a contact by pressing **Menu > Add Recipient**.
5. Tap **Send**. Text messages are sent immediately.

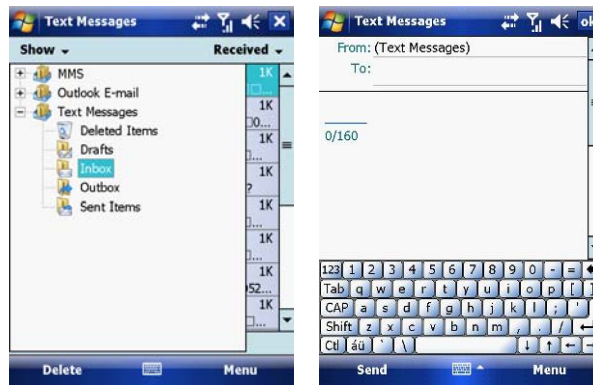

**Note:** In the **To:** field, you can enter phone numbers from your contact cards quickly. Press the **Action** button when the cursor is in this field. A new screen displays the contact list for your selection. Press the **Action** button again for the selection and the phone returns to the SMS text message screen. Repeat this for all contacts you wish to send the SMS to.

### Cancel a text message

To cancel a message, tap **Menu** > **Cancel Message**. If you require Delivery notification, in the message creation screen tap **Menu** > **Message Options...** and check the **Request message delivery notification** box.

### Insert predefined text into a message

To save time when entering text, you can insert predefined text into messages.

1. Tap **Menu** > **My Text**.
2. Select the text you want to insert by tapping the phrase you wish to insert.

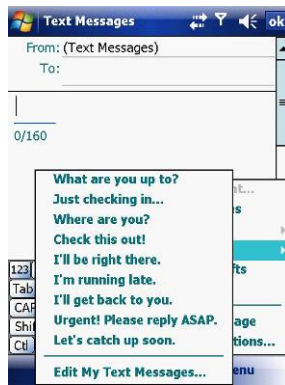

## Reply to and Forward a message

1. From the text message inbox tap **Menu** > **Reply** > **Reply All** or from an open message, tap **Reply** (bottom left corner).

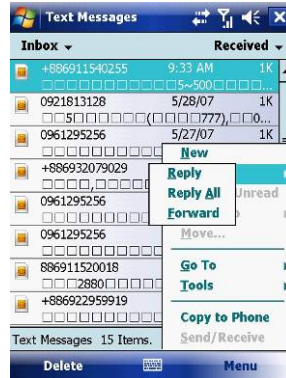

2. Enter a message in the message area.
3. Tap **Send**.

## Forward a message

1. From an open message, tap **Menu > Reply > Forward**.

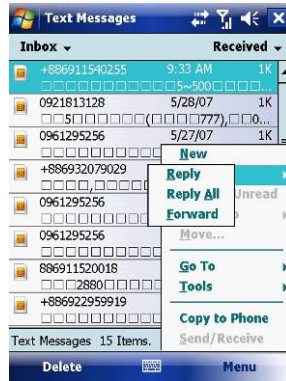

2. Enter a message in the message area.

3. Choose a recipient to send the message to. Type in the name or tap **Menu > Add recipient**.

4. Tap **Send**.

## Delete a message

1. On the **Today** screen, tap **Start > Messaging** and select an account.
2. Select the message to delete.
3. Tap **Delete** or press the **Left Soft Key**.





## 5.2 MMS

Creating and sharing MMS messages with your friends and family is easy with your device. You can even use the device's camera to capture photos while composing a new MMS message, and send them along it.

### Set up an MMS account

Before you can use MMS, you have to configure the required settings on your device. If your mobile operator settings are recognised by the device when it first boots-up, MMS settings should be set up automatically.

### Manually set up an MMS account

To set up your default MMS Messaging account, tap **Start > Messaging > MMS**.

1. Tap **Menu > Options > Accounts tab > MMS**.
2. Tap the **Servers** tab > **New**.
3. Enter the details of your mobile operator's MMSC.

### Manage MMS messages

After configuring the required settings, you can start to compose and manage your MMS messages.

### Compose MMS messages

You can compose MMS messages in a combination of various slides, where each slide can consist of a photo, audio or video clip and/or text.

1. Tap **Start > Messaging > MMS**.
2. Tap **Menu > New**. Select either a custom message from your collection or a predefined message.
3. In the **To:** field, enter the recipient's phone number or e-mail address directly, or tap **To**, **Cc**, or **Bcc** to choose a phone number or e-mail address from **Contacts**.
4. Enter a subject for your message.
5. Tap the **Insert** icon to select and send a photo or video clip. By default, it will open the **My Pictures** folder. To navigate to any other folder containing pictures or videos, tap **Show**.
6. Tap the image to insert it. Once selected you may remove the image by pressing and holding the image.

7. Enter text and insert audio clips by tapping the respective areas.
8. Tap **Send** to send the message.

The following icons act as shortcuts to some of the operations on the MMS message screen:

Tap  to preview your message.

Tap  to go to the previous slide.

Tap  to go to the next slide.

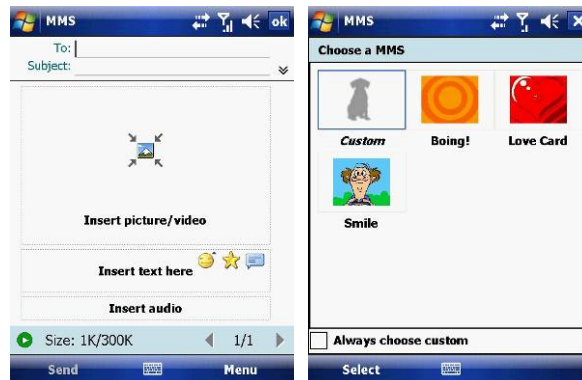

### Add an audio clip to an MMS message

You can add audio clips to your MMS message. However, you can add only one audio clip per slide.

1. Tap **Insert audio**. By default, it will open the **My Sounds** folder. To navigate to any other folder containing pictures or videos, tap **Show**.
2. Select an audio file.



**Note:** To record a new audio clip and add it to your MMS message, tap . This activates the recording control mode for a new audio clip. Tap **Record** to start recording and **Stop** to stop recording. The new audio clip is automatically inserted into your MMS message.

## Reply to an MMS message

Tap **Menu** > **Reply** > **Reply** or **Reply All** to reply to the sender of the message, or to all persons listed in **To**, **Cc**, and **Bcc** of the message.

## View an MMS message

You can view MMS messages in several ways.

- Use the playback controls ,  and .
- Tap **Objects** to see a list of files included in the message. To save a file, select it and tap **Tools** > **Save**.
- View the slides manually by scrolling through the message using the **Navigation** control.

## Set advanced options for an MMS message

From the selected message you can change the following:

- Tap **Menu** > **Options** > **Background** to choose a background colour from the list.
- Tap **Menu** > **Options** > **Text Layout** to align the included text to appear above, below, left or right of the message.
- Tap **Menu** > **Options** > **Text Size** to choose the size of the text.
- Tap **Menu** > **Options** > **Text Color** to choose the text colour from the list.
- Tap **Menu** > **Options** > **Text background** to choose the text background colour from the list.
- Tap **Menu** > **Options** > **Send Options** to set the **Delivery Time** (**1-72 hours** or **Now**), **Expiration** (**1-72 hours** or **Maximum**) and **Priority** (**Low**, **Normal** or **High**). Check the **Delivery report** and **Read report** check boxes to activate them.

## Change MMS settings

You can set options to keep track of your messages, retrieve messages immediately, accept or reject messages, and request a delivery or read receipt. You can also specify resolution for the images you send and message delivery attempts, and set up a server to access messages.

## Configure MMS settings

1. Tap **Start > Messaging**.
2. Tap **Menu > Options > MMS**.
3. Select any of the following:
  - **Retrieve messages immediately:** Select this check box to download new messages automatically without being notified. (Typically, when you are connected to a network, you receive a notification whenever you receive a new message.) You can also choose to download messages when you are on your home network only.
  - **Confirm to receive messages while roaming:** Receive messages when moving between wireless network sites.
  - **Save sent messages:** Select this check box to save a copy of messages that you send.
  - **Allow read report:** Select this check box to send and receive read reports.
  - **Disconnect network connection after MMS:** Once an MMS message has been sent, disconnect from the network.
  - **Attempts before giving up:** Select a value from this list to limit the number of times the program attempts to send your message.
  - **Photo resolution:** Select a value from this list to choose the resolution for images that you send. Decreasing the original resolution helps speed up the sending and receiving of messages.
  - **Servers:** On this tab, you can create a new server or select an existing one from the list to store and manage your messages. You can also set a server as default by tapping **Set As Default**.

## 5.3 E-mail

Before you can send or receive e-mails, you will need to setup an e-mail account. There are different types of e-mail accounts supported by the device. This is described in the next few pages.

- Internet e-mail account (POP3/IMAP4).
- Microsoft Exchange Server (Microsoft Outlook).

### Set up an Internet e-mail account automatically

1. On the **Today** screen, tap **Start > Messaging > New E-mail Account**.
2. Enter the e-mail address.
3. Check the **Try to get e-mail settings...** checkbox.
4. Tap **Next** to begin searching.

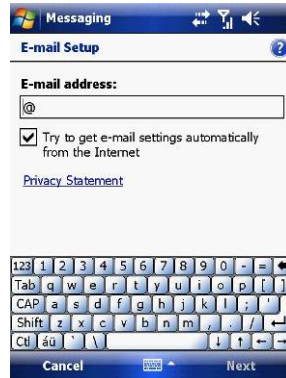

5. If the e-mail address cannot be found, you will be asked to set up the account manually.

**Note:** If the account is set up successfully, you will be prompted to send and receive e-mail. If not, you must tap **Next** and set up the account manually, which is described in the following pages. You will need to enter your user name and password for your e-mail account.

### View the Inbox message list

On the **Today** screen, tap **Start > Messaging**, and select an account. The **Inbox** message list displays your received messages.

**Note:** To view new messages when they arrive, tap the notification on the **Today** screen.

### Create an e-mail message

1. On the **Today** screen, tap **Start > Messaging**.
2. Select an e-mail account from the list.
3. Tap **Menu > New**.
4. In **To**, **Cc**, and/or **Bcc**, enter the recipient's e-mail address. Insert a semicolon (;) between multiple addresses.
5. In **Subject**, enter a subject for the message.
6. Enter a message.
7. Tap **Send**. E-mail messages are stored in the **Outbox** and are sent to recipients the next time you synchronize or connect to your e-mail server and send and receive mail.

**Note:** You can quickly enter e-mail addresses from your contact cards. In the **To:** field, press **ENTER** and select a recipient from the list. Then, select the recipient's e-mail address. The semicolon separator is automatically inserted if you enter multiple recipients.

- To set the priority of the message (i.e. to make it appear as **Low**, **Normal** or **High** priority in the recipient's inbox), tap **Menu > Message Options**.
- To cancel a message, tap **Menu > Cancel Message**.

### Insert predefined text into a message

Please refer to *Section 5.1 Text Messaging* for details on how to use this feature. You can use it when creating a new message or replying to an e-mail. When the message screen appears, tap **Menu > My Text**.

## Create and add a signature to message

For each account in **Messaging**, you can specify a signature to be automatically inserted into messages that you send.

1. On the **Today** screen, tap **Start > Messaging**.
2. Select an e-mail account from the list.
3. Tap **Menu > Options > Signatures....**
4. Scroll to the account for which you are creating the signature.
5. Select **Use Signature** with this account.

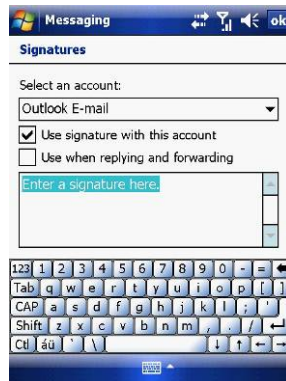

6. To insert a signature into every message you send, select **Include when replying and forwarding**. Otherwise, a signature is inserted only into new messages.
7. Tap **OK**.

## Reply to a message

1. From an open message, tap either the soft-key **Reply** or tap **Menu > Reply > Reply** or **Reply All**.
2. Enter a message in the message area.
3. Tap **Send**.

If you are replying to an e-mail in the Outlook E-mail account, you will send less data if you do not edit the original message. This may reduce data transfer costs, depending on your rate plan.



### Send and receive Internet e-mail messages

1. On the **Today** screen, tap **Start > Messaging**
2. Select an e-mail account from the list.
3. Tap **Menu > Send/Receive**. The phone should then connect to your e-mail server via the Internet and send/receive your messages.
4. To manage your folders for ActiveSync, tap on **Menu > Tools > Manage Folders**.

**Note:** To stop this process, tap **Menu > Stop Send/Receive**.

### Download a complete e-mail message

1. On the **Today** screen, tap **Start > Messaging**
2. Select an e-mail account from the list.
3. Select the message to download.
4. Tap **Menu > Download Message**. The complete message is retrieved the next time you synchronize or connect to your e-mail server to send and receive e-mail.



**Note:** Alternatively, you can scroll down to the bottom of the message and tap **Get the rest of this message**. The message will be downloaded the next time your phone connects to the e-mail server to send/receive e-mail. The frequency of this is determined by the schedule setup in your ActiveSync configuration, described in *Chapter 6*.

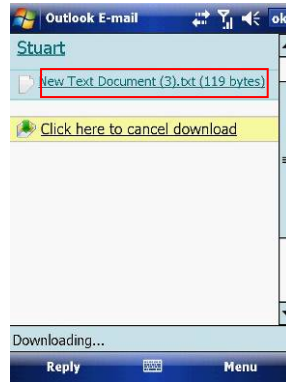

After you scroll down to the file name shown, tap it and the attached file will be downloaded when your phone connects to your e-mail server to send/ receive e-mails again.

### **View an attachment**

In an open message containing a downloaded attachment, tap the attachment.

**Note:** You can view attachments only for file formats supported by the device.

## Digitally sign a message

Digitally signing a message applies your public-key certificate to the message. This proves to the recipient that the message is from you and not from an impostor, and that the message has not been altered.

1. On the **Today** screen, tap **Start > Messaging**.
2. Select an e-mail account from the list.
3. Click **Menu > New**.
4. Click **Menu > Message Options**.

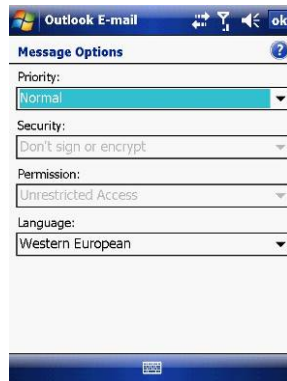

5. From the **Security** list, choose from the drop down menu.
6. Tap **OK**.

**Note:** S/MIME encryption and digital signatures for Windows Mobile®-based devices are available only with Exchange Server 2003 Service Pack 2 or later versions that support S/MIME. If you are not using one of these products, or have not yet synchronized, these options are unavailable.

## Change e-mail folders and accounts

1. On the **Today** screen, tap **Start > Messaging**
2. Select an e-mail account from the list.
3. Tap **Go To > Folders**.
4. You can select the new folder you wish to view.
5. To manage your folders for ActiveSync, tap **Menu > Tools > Manage Folders**.

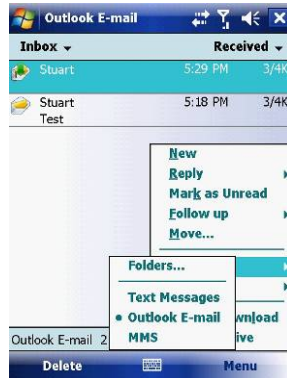

## 5.4 Windows Live Messenger

Before you can use Windows Live Messenger you must be connected to the Internet.

### **Pocket MSN Messenger overview**

With MSN Messenger you can send instant messages to your contacts' mobile devices or computers. For instructions, select a task below.

### **Get started with MSN Messenger**

To use MSN Messenger, you need Microsoft Passport Network credentials.

After obtaining credentials, complete the following tasks:

1. Setup a connection with your phone: refer to *Chapter 4 Getting Connected*. This enables you to connect to the Internet.
2. Setup an MSN Messenger account. For more information, see *Set Up an Account*.
3. Sign in to MSN Messenger. For more information, see *Sign In and Out*.

To obtain a Passport, go to <http://www.passport.com>.

To create a Hotmail account, go to <http://www.hotmail.com>.

### **Setup an account**

Before you can use MSN Messenger, you must set up an instant messaging account. For MSN Messenger service, you must have Microsoft Passport Network credentials or a Hotmail account. To use MSN Messenger, you need to create a connection to the Internet.

1. On the **Today** screen, tap **Start > Messaging > New E-mail Account**.
2. Enter the e-mail address.
3. Check the **Try to get e-mail settings automatically from the Internet** check box.
4. Tap **Next** to begin searching.
5. Once found, you will be taken to **Windows Live**.

## Sign In and Out

1. On the **Today** screen, tap **Start > Programs > Messenger** or go to Windows Live, tap **Start > Programs > Windows Live**.
2. Tap **Sign in**.
3. Enter the e-mail address and password for your Microsoft® Passport Network credentials or Hotmail account, and tap **Sign in**.

**Note:** The phone will only prompt for your **Sign in** account and password the first time you sign in for that account. After successful sign in, you will not be prompted for your **Sign in** details the next time. To switch to a different account, tap **Menu > Switch User**.

Signing in to an account may take several minutes, depending on your connection speed and how busy your mobile network is.

## Add and delete Contacts

After you have signed into Messenger, you will be able to perform the functions below.

- To add a contact, tap **Menu > Add New Contact** and then follow the directions on the screen.
  1. To delete a contact, select the contact and tap **Menu > Contact options > Remove contact**. Check the boxes to **Block this contact** and/or **Remove this contact from my Windows Live contact list**.
  2. Tap **OK** to permanently delete the contact.

## Manage Contacts

- To block a contact from viewing your status and sending you messages, select the contact and tap **Menu > Contact options > Block contact**.
- To unblock a contact, select the blocked contact from the list and tap **Menu > Contact options > Unblock Contact**.

## Change your display name and personal message

1. In MSN Messenger, tap **Menu > Change Appearance**.
2. In **My display name** and **Personal message**, enter the name and phrase that you want to display in MSN Messenger. Tap **Done**.

## Check your Messenger Status

- Tap the messenger title bar. Your current status is indicated in the list by a bullet point. You can change your status by selecting another description.



## Let Contacts know you are not available

Select your own name at the top of the page and then tap the desired status description. For example, tap **Away**.

### Send a message

1. Tap the contact you want to send a message to.
2. Enter your message in the text entry area at the bottom of the screen and tap **Send**.
3. **Emoticons, Pictures, Voice Clips and Files** can also be sent to the contact. Tap **Menu > Add emoticon or Menu > Send > Picture, Voice Clip or File**.

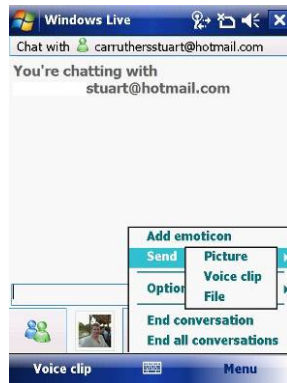

### Add Participants

Extra participants can be added to the current conversation.

1. Tap **Menu > Options > Add participant**.
2. Select the contact.
3. Tap **Add**.

### End a conversation

- Tap **Menu > End Conversation**.

## Chapter 6

6.1 Introduction to ActiveSync

6.2 Install and Configure ActiveSync



## 6.1 Introduction to ActiveSync

Your device contains ActiveSync software that allows you to create a synchronisation relationship between your mobile device and your PC. This means that when your device is connected to your PC, data is shared between them, according to your preferences. If you make a change in one place, the next time you connect your PC and device, the change is automatically made to the other machine.

You may connect to your PC using a cable or a Bluetooth connection. Accessing files from your PC remotely on your device is also possible using the 1-View component of the i-mate™ Suite. Go to <http://www.imatesuite.com> for more information.

To allow the connection to be made, the ActiveSync software provided on the getting started CD must also be installed on your PC.

Note that upon connecting the device, Windows Vista™ users will be prompted to download Windows Mobile Device Center software and do not require ActiveSync on their PC.

To access e-mails or other Outlook information whilst away from your PC, you may also connect your device to your Microsoft Exchange E-mail server.

This connection may be performed over GPRS, 3G, Wi-Fi or through your PC's connection to the Internet. If your Exchange Server is running Exchange 2003 SP2 or later, you may also be able to receive Push e-mails. Any new e-mails will be sent directly to your device.

## 6.2 Install and Configure ActiveSync

You can either install ActiveSync from your Windows Mobile Getting started CD or download it from <http://www.microsoft.com>. After the software has been installed and the USB cable is connected between your PC and phone, the ActiveSync setup wizard starts up. Click **Next** to continue.



If you only intend to synchronize directly with your Microsoft Exchange Server and not your PC, select the option below. The alternative is to synchronize your phone with your PC. Note that you cannot do both at the same time while connected to your PC.

### **Synchronize with Exchange Server**

The next few steps explain how to synchronize directly with Exchange Server. If you plan to synchronize with your PC, go to the *Synchronize with your PC* section below.

If you have a PC which is already fully synchronized with your Exchange Server, then synchronize your device to your PC the very first time instead of synchronising to the Exchange Server. This will allow faster synchronisation.

First, check the box **Synchronize directly with a server running Microsoft Exchange Server** and click **Next**.

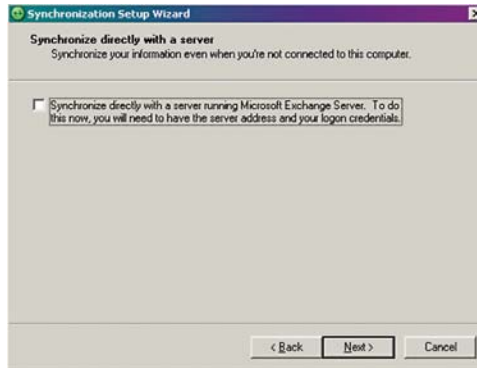

Complete the details below. Contact your network administrator if you do not know this information.

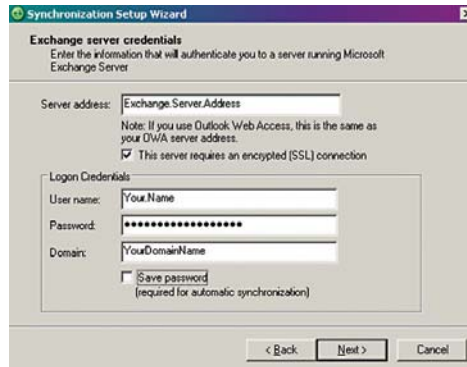

Ensure that your PC has a connection which is accessible to the Server as the setup will check the connection and your User name and Password setting validity.

To synchronize directly through to your Exchange Server instead of your PC, click the box above and enter the Exchange Server details, as shown below:

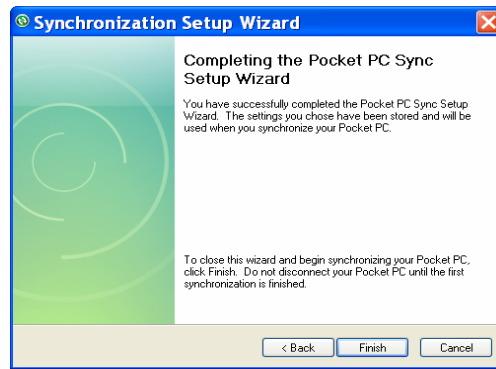

You can view additional setting information by selecting an item and clicking **Settings** below. For example, you may choose to synchronize details of your **Calendar** for the past two weeks only.



After you click **Finish**, you should get a screen prompt as below. This needs to be selected as appropriate to your own requirements, depending on the state of your PC. The time required for synchronisation depends on how much data is to be transferred.

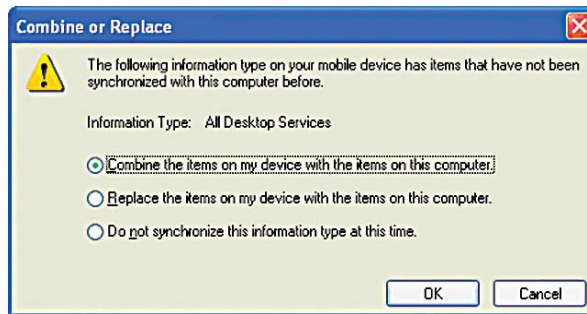

Note: Files can only be synchronized with Microsoft Exchange SP 2 or later.

## Synchronize with your PC

First you must choose a name for your PC. If you have more than two synchronisations already established, one must be erased in order to proceed.

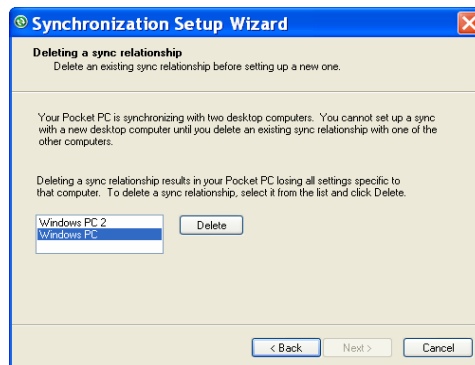

After choosing a name, click **Next**.



This window allows you to choose which information to synchronize and which will remain private.

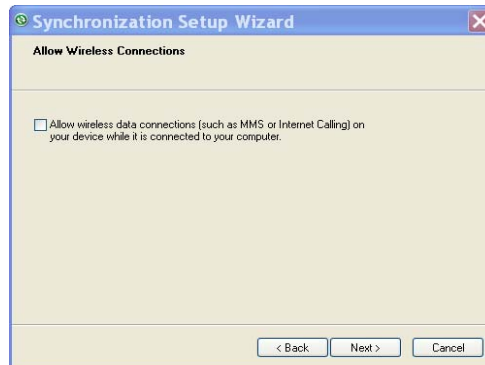

Check the box to maintain wireless connection while the device is plugged into your PC.



To begin the PC Sync, click **Finish** but leave the device plugged in.

### Change ActiveSync settings

After setting up synchronisation using the Sync Setup wizard on the PC, the synchronisation settings can subsequently be changed:

- If you want to change ActiveSync settings when synchronising with your PC, use the **Changing the amount of information synchronized** section in the Help files on your PC.
- If you want to change ActiveSync settings for synchronising through to your Exchange Server, use the ActiveSync settings on your device, as described in *Change settings for an information type* below.

### Change settings for an information type

Before changing synchronisation settings on the device, first disconnect it from your PC.

1. On the **Today** screen, tap **Start > Programs > ActiveSync > Menu > Options**.
2. Select one of the information types.
  - To view or change settings for an information type (when available), tap **Settings**.
  - To view or change settings for a computer or Exchange Server, tap **Menu > Settings**.

3. Change the amount of information to be synchronized or other settings.
4. Click **Done** (or **Finish** in the Exchange Server settings wizard).

### Connect to a PC using Bluetooth

1. Follow the instructions in **ActiveSync Help** on the PC for configuring Bluetooth on your PC to support ActiveSync. Make sure that your PC's Bluetooth is set to **Visible (Discoverable)** and that ActiveSync on the PC has the Bluetooth COM port enabled – see below.
2. From the device's **Today** screen, tap **Start > Programs > ActiveSync**.
3. Tap **Menu > Connect via Bluetooth**. Ensure that the phone and PC are within close range.
4. If this is the first time you have connected to this PC via Bluetooth, you must complete the Bluetooth wizard on the phone and setup a Bluetooth partnership with the PC before synchronising.
5. Tap **Sync**.
6. When finished, tap **Menu > Disconnect Bluetooth**.
7. To preserve battery power, turn off Bluetooth.

Ensure that the PC ActiveSync Serial port corresponds to the PC's Bluetooth Serial port configuration. In the example below, the Bluetooth Serial Port has already been set up as **COM4** by the computer. Because **COM4** is allocated to Bluetooth, the **Allow connections to one of the following** field has been set to **COM4** to match this.





In the sample screenshot below, the PC Bluetooth Manager indicates that the Bluetooth Serial Port is set to **COM4**.

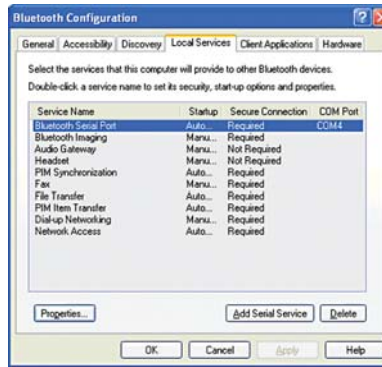

If, for example, you wish to synchronize your phone to the Exchange Server for **E-mail** and **Tasks**, and to your PC for **Contacts** and **Calendar**, tap **Start > Programs > ActiveSync > Menu > Options** from your device and select from the list as shown.

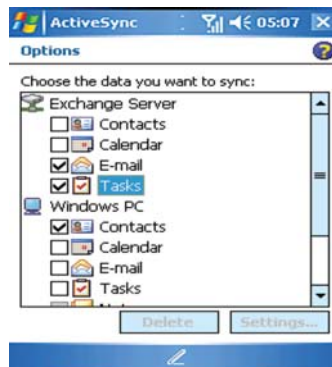

Before connecting your device to your PC, you may first need to check your ActiveSync **Connection Settings** by double clicking on the ActiveSync icons at the bottom right of your PC screen.

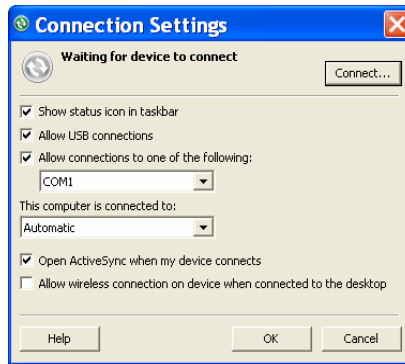

When complete, connect your device and synchronisation should take place as below.

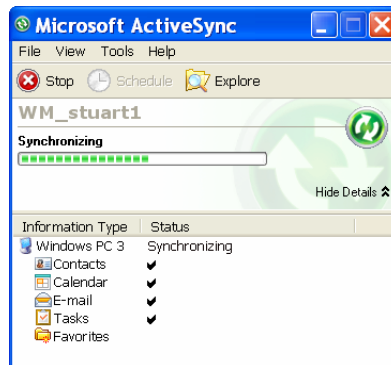

## Set up an Exchange Server connection

You can synchronize your **E-mail**, **Calendar Appointments** and **Contacts** directly with your Exchange server. Tasks may also be synchronized if your company is running Exchange Server 2003 SP 2 or later.

To complete this configuration, you will need to get the name of the server and the server domain name from your service provider or system administrator. You must also know your Exchange user name and password.

**Note:** Before changing synchronisation settings on the phone, disconnect it from your PC. You can also refer to some of the screenshots in the previous section of *Install and Setup ActiveSync* (with Exchange Server).

1. On the **Today** Screen, tap **Start > Programs > ActiveSync > Menu > Configure Server**. If you have not yet set up ActiveSync with Exchange Server, it will say **Add Server Source**.
2. In **Server Address**, enter the name of the server running Exchange Server and click **Next**.
3. Enter your user name, password and domain name and click **Next**. If you want the phone to save your password so that you will not need to enter it again when connecting, select the **Save password** checkbox.
4. Select the check boxes for the types of information items that you want to synchronize with Exchange Server.
5. To change available synchronisation settings, select the type of information and tap **Menu > Settings**.
6. To change the rules for resolving synchronisation conflicts, tap **Menu > Advanced**.
7. Tap **Finish**.

## Start and stop synchronisation

1. On the **Today** screen, tap **Start** > **Programs** > **ActiveSync**.
2. To start synchronisation, tap **Sync**.
3. To stop synchronising, tap **Stop**.

**Note:** This menu only appears during synchronisation.

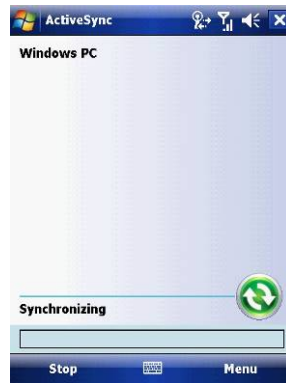

## Synchronize your Music and Video files

Your device is able to synchronize music and video files from your PC. This is described in detail in *Chapter 7*.