

Test Mode: 03; Polarity: Vertical; Modulation:802.11ac; Bandwidth:40MHz; Channel:Low

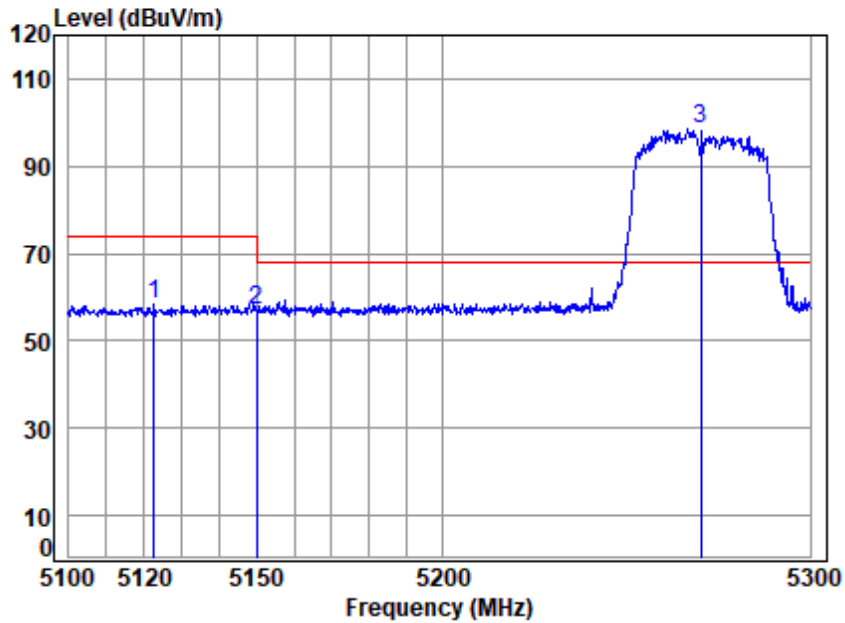

Site : chamber
 Condition: 3m VERTICAL
 Job No : 00028CR/00029CR
 Mode : 5270 Band edge
 : 5G WIFI 11AC40

	Freq	Cable Loss	Ant Factor	Preamp Factor	Read Level	Limit Level	Limit Line	Over Limit	Remark
	MHz	dB	dB/m	dB	dBuV	dBuV/m	dBuV/m	dB	
1	5122.610	7.52	34.30	42.31	58.83	58.34	74.00	-15.66	Peak
2	5149.980	7.57	34.32	42.32	57.68	57.25	74.00	-16.75	Peak
3 *	5270.000	7.79	34.42	42.33	98.46	98.34	68.20	30.14	Peak



Test Mode: 03; Polarity: Vertical; Modulation:802.11ac; Bandwidth:40MHz; Channel:Low

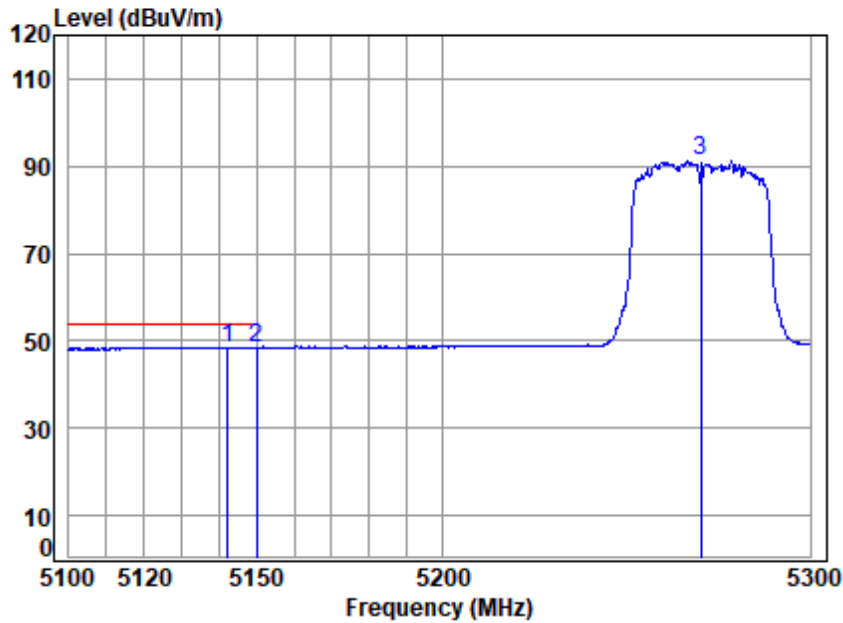

Site : chamber
 Condition: 3m VERTICAL
 Job No : 00028CR/00029CR
 Mode : 5270 Band edge
 : 5G WIFI 11AC40

	Freq	Cable Loss	Ant Factor	Preamp Factor	Read Level	Limit Level	Over Limit	Remark
	MHz	dB	dB/m	dB	dBuV	dBuV/m	dBuV/m	dB
1	5142.353	7.56	34.32	42.32	49.00	48.56	54.00	-5.44 Average
2	5149.980	7.57	34.32	42.32	48.93	48.50	54.00	-5.50 Average
3	5270.000	7.79	34.42	42.33	91.26	91.14	-----	----- Average



Unless otherwise agreed in writing, this document is issued by the Company subject to its General Conditions of Service printed overleaf, available on request or accessible at <http://www.sgs.com/en/Terms-and-Conditions.aspx> and, for electronic format documents, subject to Terms and Conditions for Electronic Documents at <http://www.sgs.com/en/Terms-and-Conditions/Terms-e-Documents.aspx>. Attention is drawn to the limitation of liability, indemnification and jurisdiction issues defined therein. Any holder of this document is advised that information contained hereon reflects the Company's findings at the time of its intervention only and within the limits of Client's instructions, if any. The Company's sole responsibility is to its Client and this document does not exonerate parties to a transaction from exercising all their rights and obligations under the transaction documents. This document cannot be reproduced except in full, without prior written approval of the Company. Any unauthorized alteration, forgery or falsification of the content or appearance of this document is unlawful and offenders may be prosecuted to the fullest extent of the law. Unless otherwise stated the results shown in this test report refer only to the sample(s) tested and such sample(s) are retained for 30 days only.
 Attention: To check the authenticity of testing /inspection report & certificate, please contact us at telephone: (86-755) 8307 1443, or email: CN.Doccheck@sgs.com

Test Mode: 03; Polarity: Horizontal; Modulation:802.11ac; Bandwidth:40MHz; Channel:High

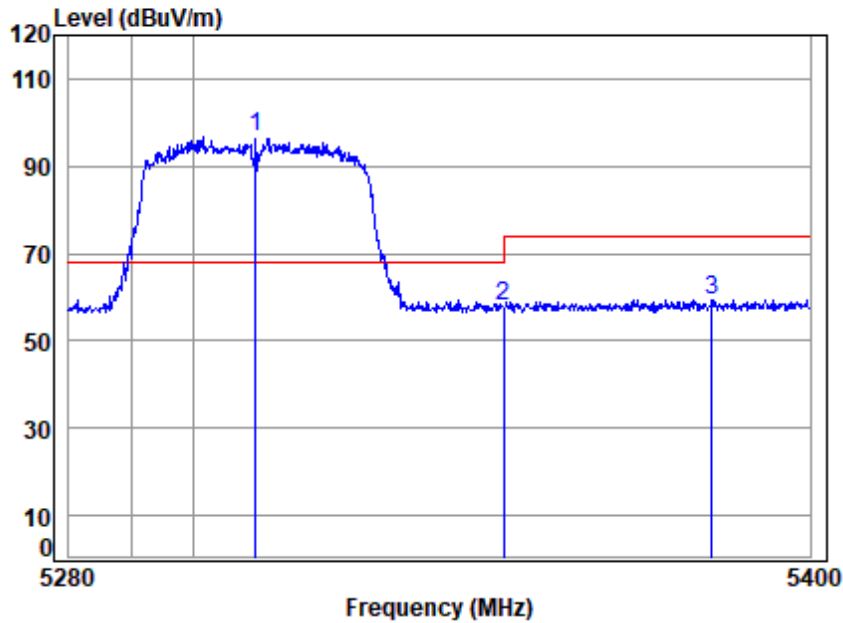

Site : chamber
 Condition: 3m HORIZONTAL
 Job No : 00028CR/00029CR
 Mode : 5310 Band edge
 : 5G WIFI 11AC40

	Cable	Ant	Preamp	Read	Limit	Over	
Freq	Loss	Factor	Factor	Level	Level	Line	Limit
MHz	dB	dB/m	dB	dBuV	dBuV/m	dBuV/m	dB
1 * 5310.000	7.86	34.45	42.33	96.66	96.64	68.20	28.44 peak
2 5350.020	7.92	34.48	42.34	58.07	58.13	74.00	-15.87 peak
3 5384.005	7.98	34.51	42.34	59.39	59.54	74.00	-14.46 peak



Test Mode: 03; Polarity: Horizontal; Modulation:802.11ac; Bandwidth:40MHz; Channel:High

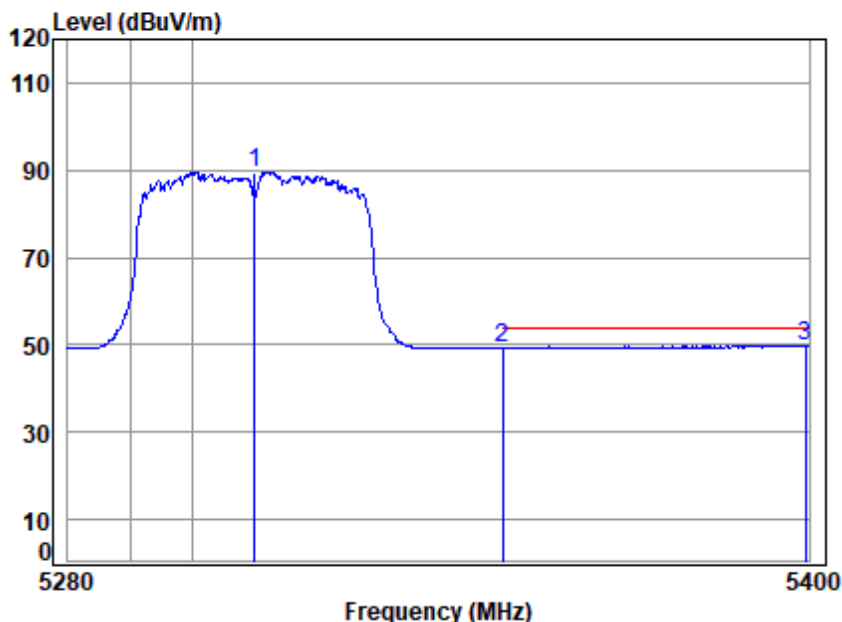

Site : chamber
 Condition: 3m HORIZONTAL
 Job No : 00028CR/00029CR
 Mode : 5310 Band edge
 : 5G WIFI 11AC40

	Freq	Cable Loss	Ant Factor	Preamp Factor	Read Level	Limit Level	Over Line	Over Limit	Remark
	MHz	dB	dB/m	dB	dBuV	dBuV/m	dBuV/m	dB	
1	5310.000	7.86	34.45	42.33	89.63	89.61	-----	-----	Average
2	5350.020	7.92	34.48	42.34	49.22	49.28	54.00	-4.72	Average
3	5399.393	8.01	34.52	42.34	49.55	49.74	54.00	-4.26	Average



Unless otherwise agreed in writing, this document is issued by the Company subject to its General Conditions of Service printed overleaf, available on request or accessible at <http://www.sgs.com/en/Terms-and-Conditions.aspx> and, for electronic format documents, subject to Terms and Conditions for Electronic Documents at <http://www.sgs.com/en/Terms-and-Conditions/Terms-e-Documents.aspx>. Attention is drawn to the limitation of liability, indemnification and jurisdiction issues defined therein. Any holder of this document is advised that information contained hereon reflects the Company's findings at the time of its intervention only and within the limits of Client's instructions, if any. The Company's sole responsibility is to its Client and this document does not exonerate parties to a transaction from exercising all their rights and obligations under the transaction documents. This document cannot be reproduced except in full, without prior written approval of the Company. Any unauthorized alteration, forgery or falsification of the content or appearance of this document is unlawful and offenders may be prosecuted to the fullest extent of the law. Unless otherwise stated the results shown in this test report refer only to the sample(s) tested and such sample(s) are retained for 30 days only.
 Attention: To check the authenticity of testing / inspection report & certificate, please contact us at telephone: (86-755) 8307 1443, or email: CN.Doccheck@sgs.com

Test Mode: 03; Polarity: Vertical; Modulation:802.11ac; Bandwidth:40MHz; Channel:High

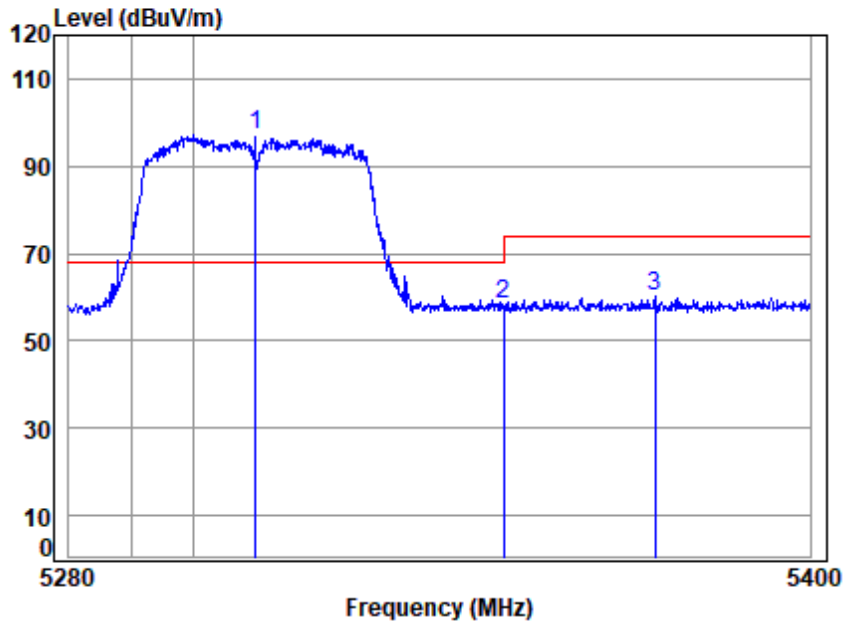

Site : chamber
 Condition: 3m VERTICAL
 Job No : 00028CR/00029CR
 Mode : 5310 Band edge
 : 5G WIFI 11AC40

	Cable	Ant	Preamp	Read	Limit	Over	
Freq	Loss	Factor	Factor	Level	Level	Line	Limit Remark
MHz	dB	dB/m	dB	dBuV	dBuV/m	dBuV/m	dB
1 * 5310.000	7.86	34.45	42.33	97.24	97.22	68.20	29.02 Peak
2 5350.020	7.92	34.48	42.34	58.13	58.19	74.00	-15.81 Peak
3 5374.697	7.97	34.50	42.34	60.01	60.14	74.00	-13.86 Peak



Test Mode: 03; Polarity: Vertical; Modulation:802.11ac; Bandwidth:40MHz; Channel:High

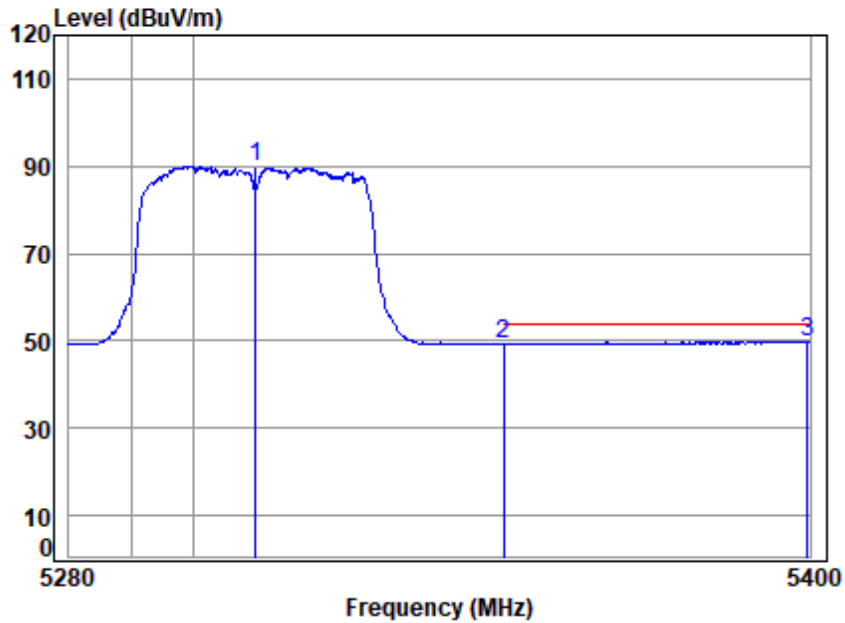

Site : chamber
 Condition: 3m VERTICAL
 Job No : 00028CR/00029CR
 Mode : 5310 Band edge
 : 5G WIFI 11AC40

	Freq	Cable Loss	Ant Factor	Preamp Factor	Read Level	Limit Level	Over Line	Over Limit	Remark
	MHz	dB	dB/m	dB	dBuV	dBuV/m	dBuV/m	dB	
1	5310.000	7.86	34.45	42.33	89.98	89.96	-----	-----	Average
2	5350.020	7.92	34.48	42.34	49.29	49.35	54.00	-4.65	Average
3	5399.515	8.01	34.52	42.34	49.66	49.85	54.00	-4.15	Average



Unless otherwise agreed in writing, this document is issued by the Company subject to its General Conditions of Service printed overleaf, available on request or accessible at <http://www.sgs.com/en/Terms-and-Conditions.aspx> and, for electronic format documents, subject to Terms and Conditions for Electronic Documents at <http://www.sgs.com/en/Terms-and-Conditions/Terms-e-Documents.aspx>. Attention is drawn to the limitation of liability, indemnification and jurisdiction issues defined therein. Any holder of this document is advised that information contained hereon reflects the Company's findings at the time of its intervention only and within the limits of Client's instructions, if any. The Company's sole responsibility is to its Client and this document does not exonerate parties to a transaction from exercising all their rights and obligations under the transaction documents. This document cannot be reproduced except in full, without prior written approval of the Company. Any unauthorized alteration, forgery or falsification of the content or appearance of this document is unlawful and offenders may be prosecuted to the fullest extent of the law. Unless otherwise stated the results shown in this test report refer only to the sample(s) tested and such sample(s) are retained for 30 days only.
 Attention: To check the authenticity of testing / inspection report & certificate, please contact us at telephone: (86-755) 8307 1443, or email: CN.Doccheck@sgs.com

Test Mode: 03; Polarity: Horizontal; Modulation:802.11ac; Bandwidth:80MHz; Channel:middle

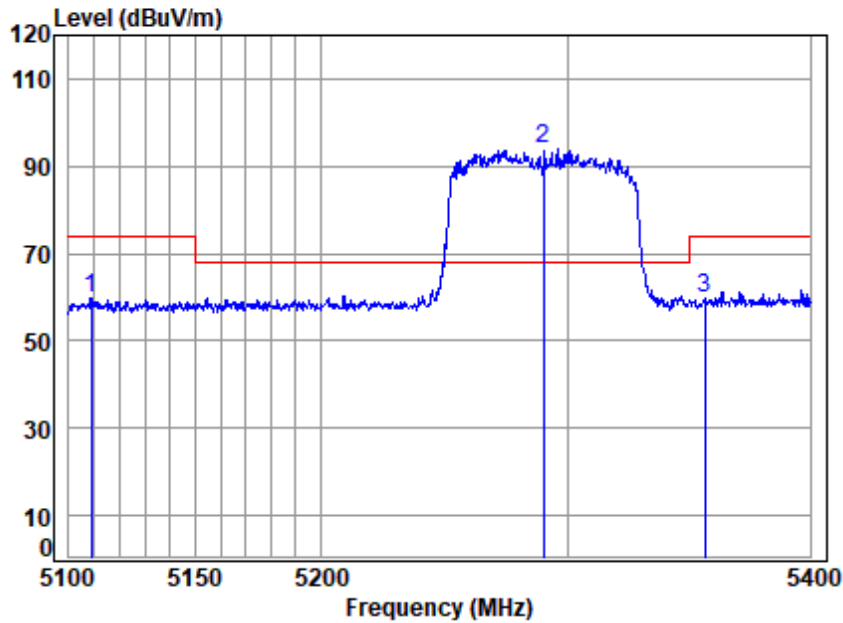

Site : chamber
 Condition: 3m HORIZONTAL
 Job No : 00028CR/00029CR
 Mode : 5290 Band edge
 : 5G WIFI 11AC80

	Cable	Ant	Preamp	Read	Limit	Over		
Freq	Loss	Factor	Factor	Level	Level	Line	Limit	Remark
MHz	dB	dB/m	dB	dBuV	dBuV/m	dBuV/m	dB	
1	5108.753	7.50	34.29	42.31	60.42	59.90	74.00	-14.10 peak
2 *	5290.000	7.82	34.44	42.33	94.00	93.93	68.20	25.73 peak
3	5356.348	7.94	34.49	42.34	59.63	59.72	74.00	-14.28 peak



Unless otherwise agreed in writing, this document is issued by the Company subject to its General Conditions of Service printed overleaf, available on request or accessible at <http://www.sgs.com/en/Terms-and-Conditions.aspx> and, for electronic format documents, subject to Terms and Conditions for Electronic Documents at <http://www.sgs.com/en/Terms-and-Conditions/Terms-e-Documents.aspx>. Attention is drawn to the limitation of liability, indemnification and jurisdiction issues defined therein. Any holder of this document is advised that information contained hereon reflects the Company's findings at the time of its intervention only and within the limits of Client's instructions, if any. The Company's sole responsibility is to its Client and this document does not exonerate parties to a transaction from exercising all their rights and obligations under the transaction documents. This document cannot be reproduced except in full, without prior written approval of the Company. Any unauthorized alteration, forgery or falsification of the content or appearance of this document is unlawful and offenders may be prosecuted to the fullest extent of the law. Unless otherwise stated the results shown in this test report refer only to the sample(s) tested and such sample(s) are retained for 30 days only.
 Attention: To check the authenticity of testing /inspection report & certificate, please contact us at telephone: (86-755) 8307 1443, or email: CN.Doccheck@sgs.com

Test Mode: 03; Polarity: Horizontal; Modulation:802.11ac; Bandwidth:80MHz; Channel:middle

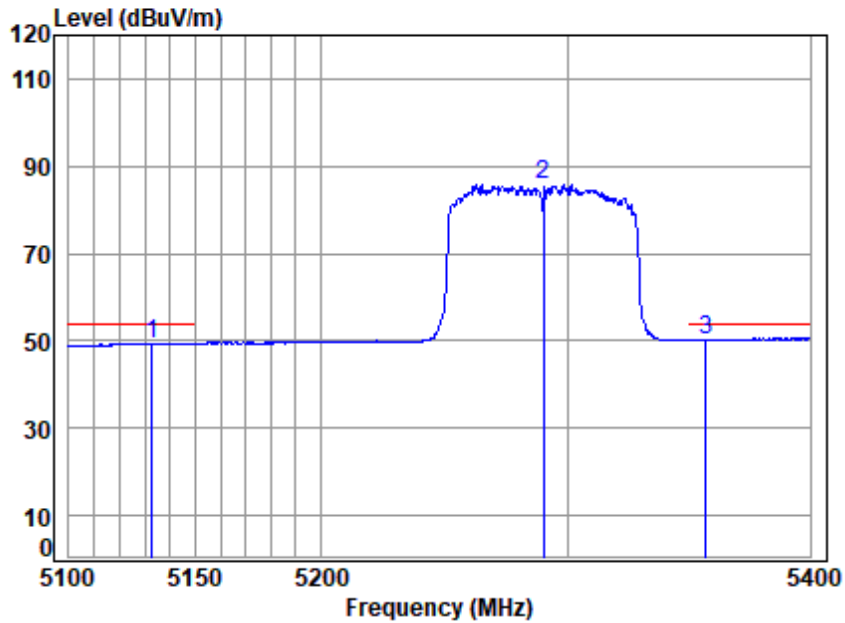

Site : chamber
 Condition: 3m HORIZONTAL
 Job No : 00028CR/00029CR
 Mode : 5290 Band edge
 : 5G WIFI 11AC80

	Freq	Cable Loss	Ant Factor	Preamp Factor	Read Level	Limit Level	Over Limit	Remark
	MHz	dB	dB/m	dB	dBuV	dBuV/m	dBuV/m	dB
1	5132.753	7.54	34.31	42.31	49.95	49.49	54.00	-4.51 Average
2	5290.000	7.82	34.44	42.33	85.94	85.87	-----	----- Average
3	5356.960	7.94	34.49	42.34	50.12	50.21	54.00	-3.79 Average



Unless otherwise agreed in writing, this document is issued by the Company subject to its General Conditions of Service printed overleaf, available on request or accessible at <http://www.sgs.com/en/Terms-and-Conditions.aspx> and, for electronic format documents, subject to Terms and Conditions for Electronic Documents at <http://www.sgs.com/en/Terms-and-Conditions/Terms-e-Documents.aspx>. Attention is drawn to the limitation of liability, indemnification and jurisdiction issues defined therein. Any holder of this document is advised that information contained hereon reflects the Company's findings at the time of its intervention only and within the limits of Client's instructions, if any. The Company's sole responsibility is to its Client and this document does not exonerate parties to a transaction from exercising all their rights and obligations under the transaction documents. This document cannot be reproduced except in full, without prior written approval of the Company. Any unauthorized alteration, forgery or falsification of the content or appearance of this document is unlawful and offenders may be prosecuted to the fullest extent of the law. Unless otherwise stated the results shown in this test report refer only to the sample(s) tested and such sample(s) are retained for 30 days only.
 Attention: To check the authenticity of testing /inspection report & certificate, please contact us at telephone: (86-755) 8307 1443, or email: CN.Doccheck@sgs.com

Test Mode: 03; Polarity: Vertical; Modulation:802.11ac; Bandwidth:80MHz; Channel:middle

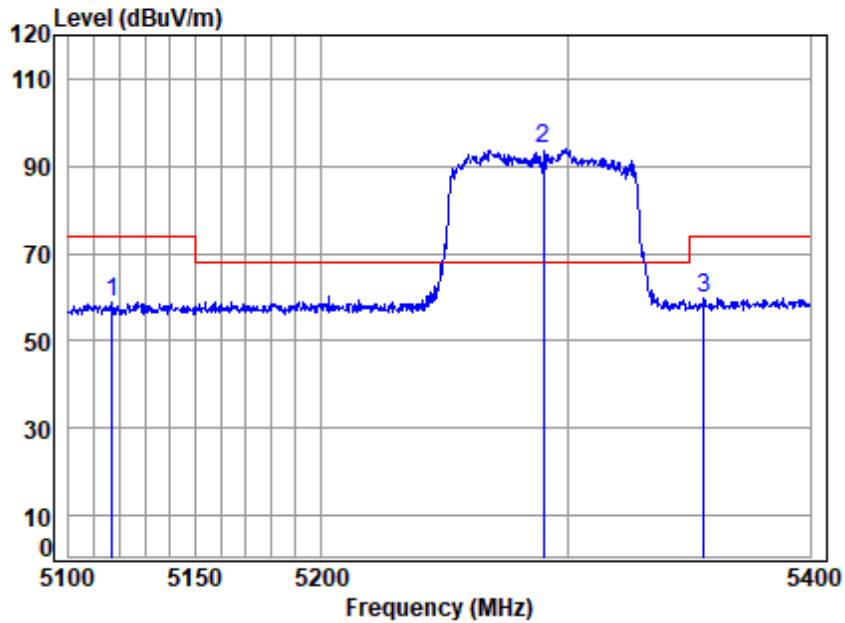

Site : chamber
 Condition: 3m VERTICAL
 Job No : 00028CR/00029CR
 Mode : 5290 Band edge
 : 5G WIFI 11AC80

	Freq	Cable Loss	Ant Factor	Preamp Factor	Read Level	Limit Level	Over Limit	Remark
	MHz	dB	dB/m	dB	dBuV	dBuV/m	dBuV/m	dB
1	5116.936	7.51	34.30	42.31	59.37	58.87	74.00	-15.13 Peak
2 *	5290.000	7.82	34.44	42.33	93.89	93.82	68.20	25.62 Peak
3	5356.042	7.94	34.49	42.34	59.69	59.78	74.00	-14.22 Peak



Unless otherwise agreed in writing, this document is issued by the Company subject to its General Conditions of Service printed overleaf, available on request or accessible at <http://www.sgs.com/en/Terms-and-Conditions.aspx> and, for electronic format documents, subject to Terms and Conditions for Electronic Documents at <http://www.sgs.com/en/Terms-and-Conditions/Terms-e-Documents.aspx>. Attention is drawn to the limitation of liability, indemnification and jurisdiction issues defined therein. Any holder of this document is advised that information contained hereon reflects the Company's findings at the time of its intervention only and within the limits of Client's instructions, if any. The Company's sole responsibility is to its Client and this document does not exonerate parties to a transaction from exercising all their rights and obligations under the transaction documents. This document cannot be reproduced except in full, without prior written approval of the Company. Any unauthorized alteration, forgery or falsification of the content or appearance of this document is unlawful and offenders may be prosecuted to the fullest extent of the law. Unless otherwise stated the results shown in this test report refer only to the sample(s) tested and such sample(s) are retained for 30 days only.
 Attention: To check the authenticity of testing / inspection report & certificate, please contact us at telephone: (86-755) 8307 1443, or email: CN.Doccheck@sgs.com

Test Mode: 03; Polarity: Vertical; Modulation:802.11ac; Bandwidth:80MHz; Channel:middle

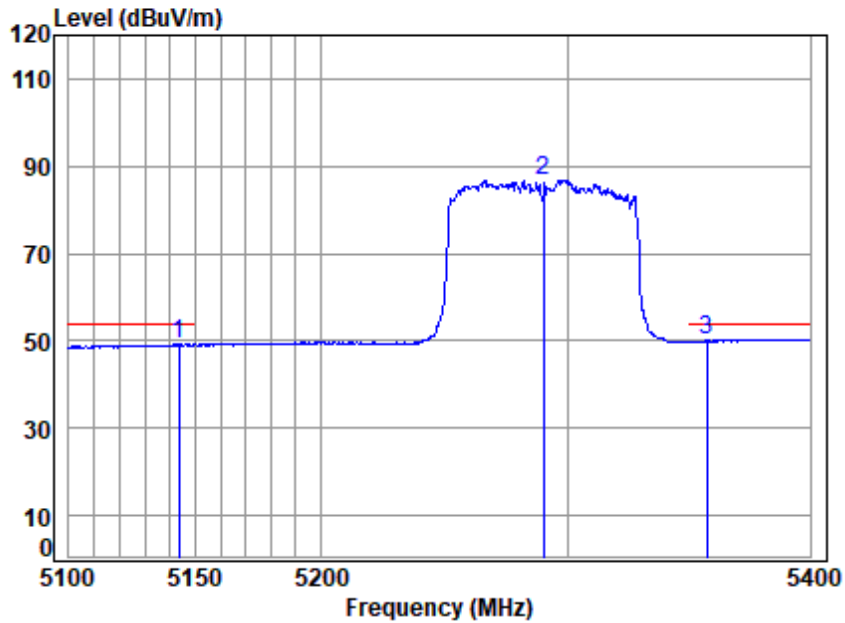

Site : chamber
 Condition: 3m VERTICAL
 Job No : 00028CR/00029CR
 Mode : 5290 Band edge
 : 5G WIFI 11AC80

	Freq	Cable Loss	Ant Factor	Preamp Factor	Read Level	Limit	Over	Remark
	MHz	dB	dB/m	dB	dBuV	dBuV/m	dB	
1	5143.326	7.56	34.32	42.32	49.60	49.16	54.00	-4.84 Average
2	5290.000	7.82	34.44	42.33	86.77	86.70	-----	----- Average
3	5357.267	7.94	34.49	42.34	50.05	50.14	54.00	-3.86 Average



Unless otherwise agreed in writing, this document is issued by the Company subject to its General Conditions of Service printed overleaf, available on request or accessible at <http://www.sgs.com/en/Terms-and-Conditions.aspx> and, for electronic format documents, subject to Terms and Conditions for Electronic Documents at <http://www.sgs.com/en/Terms-and-Conditions/Terms-e-Documents.aspx>. Attention is drawn to the limitation of liability, indemnification and jurisdiction issues defined therein. Any holder of this document is advised that information contained hereon reflects the Company's findings at the time of its intervention only and within the limits of Client's instructions, if any. The Company's sole responsibility is to its Client and this document does not exonerate parties to a transaction from exercising all their rights and obligations under the transaction documents. This document cannot be reproduced except in full, without prior written approval of the Company. Any unauthorized alteration, forgery or falsification of the content or appearance of this document is unlawful and offenders may be prosecuted to the fullest extent of the law. Unless otherwise stated the results shown in this test report refer only to the sample(s) tested and such sample(s) are retained for 30 days only.
 Attention: To check the authenticity of testing / inspection report & certificate, please contact us at telephone: (86-755) 8307 1443, or email: CN.Doccheck@sgs.com

Test Mode: 04; Polarity: Horizontal; Modulation:802.11a; Bandwidth:20MHz; Channel:Low

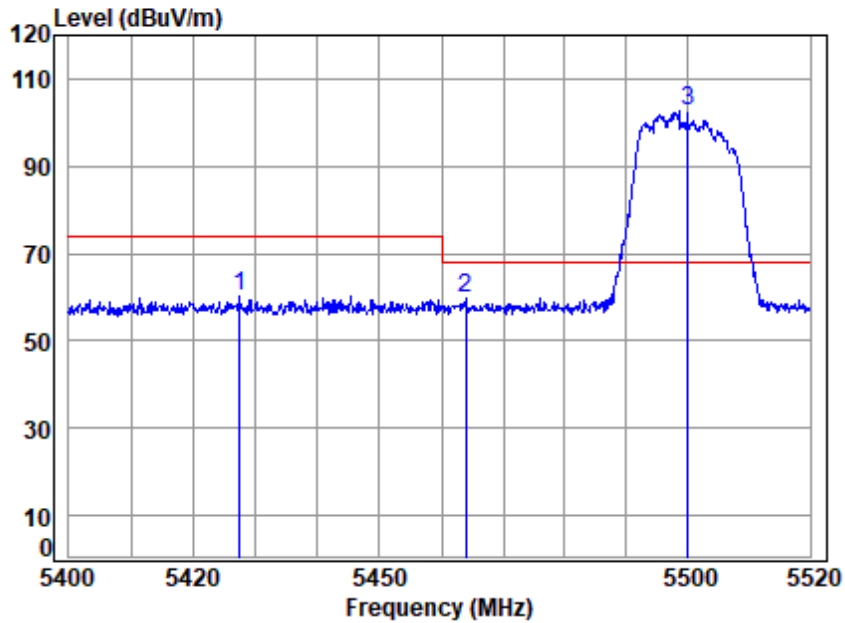

Site : chamber
 Condition: 3m HORIZONTAL
 Job No : 00028CR/00029CR
 Mode : 5500 Band edge
 : 5G WIFI 11A

	Cable	Ant	Preamp	Read	Limit	Over		
Freq	Loss	Factor	Factor	Level	Level	Line	Limit	Remark
MHz	dB	dB/m	dB	dBuV	dBuV/m	dBuV/m	dB	
1	5427.367	8.06	34.54	42.34	59.99	60.25	74.00	-13.75 peak
2	5463.992	8.12	34.57	42.35	59.45	59.79	68.20	-8.41 peak
3 *	5500.000	8.18	34.60	42.35	102.02	102.45	68.20	34.25 peak



Unless otherwise agreed in writing, this document is issued by the Company subject to its General Conditions of Service printed overleaf, available on request or accessible at <http://www.sgs.com/en/Terms-and-Conditions.aspx> and, for electronic format documents, subject to Terms and Conditions for Electronic Documents at <http://www.sgs.com/en/Terms-and-Conditions/Terms-e-Documents.aspx>. Attention is drawn to the limitation of liability, indemnification and jurisdiction issues defined therein. Any holder of this document is advised that information contained hereon reflects the Company's findings at the time of its intervention only and within the limits of Client's instructions, if any. The Company's sole responsibility is to its Client and this document does not exonerate parties to a transaction from exercising all their rights and obligations under the transaction documents. This document cannot be reproduced except in full, without prior written approval of the Company. Any unauthorized alteration, forgery or falsification of the content or appearance of this document is unlawful and offenders may be prosecuted to the fullest extent of the law. Unless otherwise stated the results shown in this test report refer only to the sample(s) tested and such sample(s) are retained for 30 days only.
 Attention: To check the authenticity of testing / inspection report & certificate, please contact us at telephone: (86-755) 8307 1443, or email: CN.Doccheck@sgs.com

Test Mode: 04; Polarity: Horizontal; Modulation:802.11a; Bandwidth:20MHz; Channel:Low

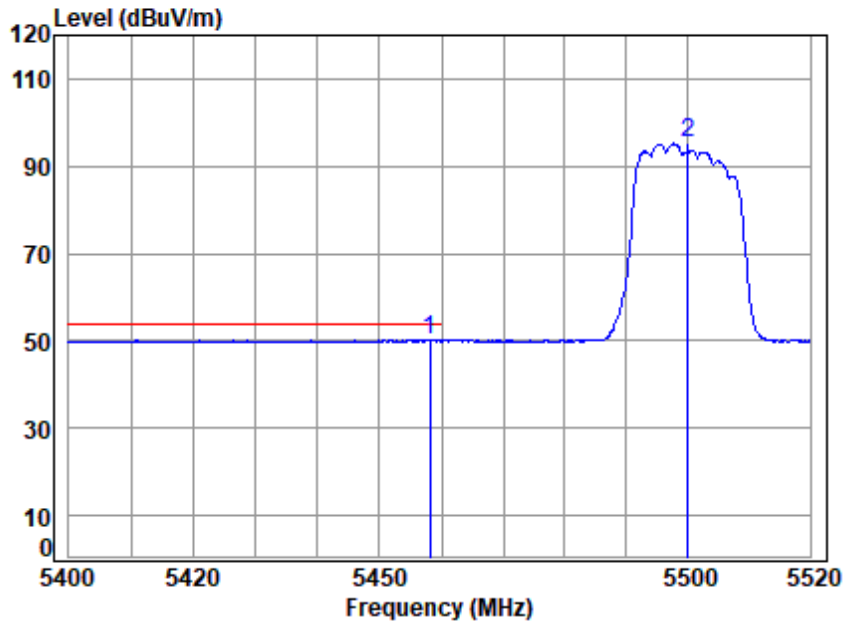

Site : chamber
 Condition: 3m HORIZONTAL
 Job No : 00028CR/00029CR
 Mode : 5500 Band edge
 : 5G WIFI 11A

	Freq	Cable Loss	Ant Factor	Preamp Factor	Read Level	Limit Level	Over Limit	Remark
	MHz	dB	dB/m	dB	dBuV	dBuV/m	dBuV/m	dB
1	5458.110	8.11	34.57	42.35	49.78	50.11	54.00	-3.89 Average
2	5500.000	8.18	34.60	42.35	94.75	95.18	-----	----- Average



Unless otherwise agreed in writing, this document is issued by the Company subject to its General Conditions of Service printed overleaf, available on request or accessible at <http://www.sgs.com/en/Terms-and-Conditions.aspx> and, for electronic format documents, subject to Terms and Conditions for Electronic Documents at <http://www.sgs.com/en/Terms-and-Conditions/Terms-e-Documents.aspx>. Attention is drawn to the limitation of liability, indemnification and jurisdiction issues defined therein. Any holder of this document is advised that information contained hereon reflects the Company's findings at the time of its intervention only and within the limits of Client's instructions, if any. The Company's sole responsibility is to its Client and this document does not exonerate parties to a transaction from exercising all their rights and obligations under the transaction documents. This document cannot be reproduced except in full, without prior written approval of the Company. Any unauthorized alteration, forgery or falsification of the content or appearance of this document is unlawful and offenders may be prosecuted to the fullest extent of the law. Unless otherwise stated the results shown in this test report refer only to the sample(s) tested and such sample(s) are retained for 30 days only.
 Attention: To check the authenticity of testing / inspection report & certificate, please contact us at telephone: (86-755) 8307 1443, or email: CN.Doccheck@sgs.com

Test Mode: 04; Polarity: Vertical; Modulation:802.11a; Bandwidth:20MHz; Channel:Low

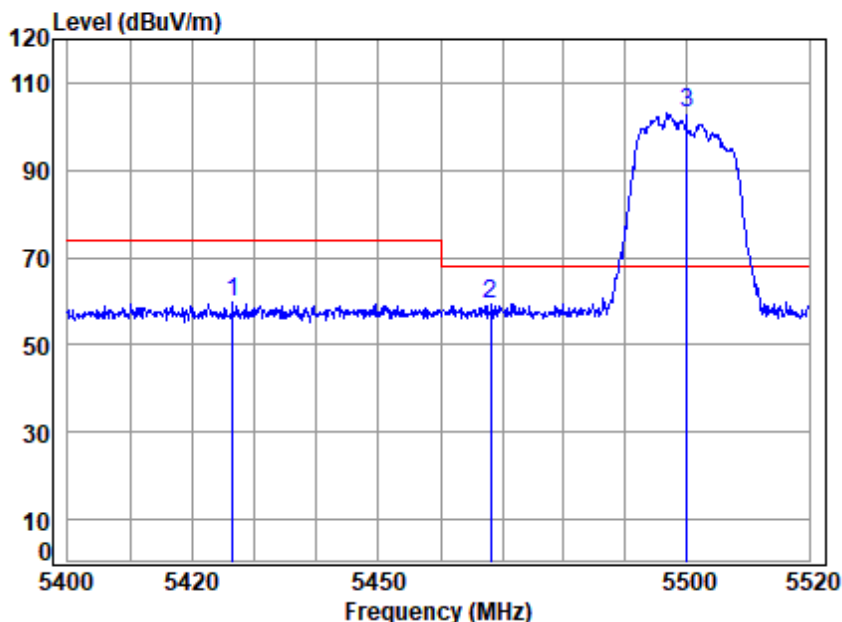

Site : chamber
 Condition: 3m VERTICAL
 Job No : 00028CR/00029CR
 Mode : 5500 Band edge
 : 5G WIFI 11A

	Cable	Ant	Preamp	Read	Limit	Over		
Freq	Loss	Factor	Factor	Level	Level	Line	Limit	Remark
MHz	dB	dB/m	dB	dBuV	dBuV/m	dBuV/m	dB	
1	5426.413	8.06	34.54	42.34	59.59	59.85	74.00	-14.15 peak
2	5468.197	8.13	34.58	42.35	58.78	59.14	68.20	-9.06 peak
3 *	5500.000	8.18	34.60	42.35	102.63	103.06	68.20	34.86 peak



Unless otherwise agreed in writing, this document is issued by the Company subject to its General Conditions of Service printed overleaf, available on request or accessible at <http://www.sgs.com/en/Terms-and-Conditions.aspx> and, for electronic format documents, subject to Terms and Conditions for Electronic Documents at <http://www.sgs.com/en/Terms-and-Conditions/Terms-e-Documents.aspx>. Attention is drawn to the limitation of liability, indemnification and jurisdiction issues defined therein. Any holder of this document is advised that information contained hereon reflects the Company's findings at the time of its intervention only and within the limits of Client's instructions, if any. The Company's sole responsibility is to its Client and this document does not exonerate parties to a transaction from exercising all their rights and obligations under the transaction documents. This document cannot be reproduced except in full, without prior written approval of the Company. Any unauthorized alteration, forgery or falsification of the content or appearance of this document is unlawful and offenders may be prosecuted to the fullest extent of the law. Unless otherwise stated the results shown in this test report refer only to the sample(s) tested and such sample(s) are retained for 30 days only.
 Attention: To check the authenticity of testing /inspection report & certificate, please contact us at telephone: (86-755) 8307 1443, or email: CN.Doccheck@sgs.com

Test Mode: 04; Polarity: Vertical; Modulation:802.11a; Bandwidth:20MHz; Channel:Low

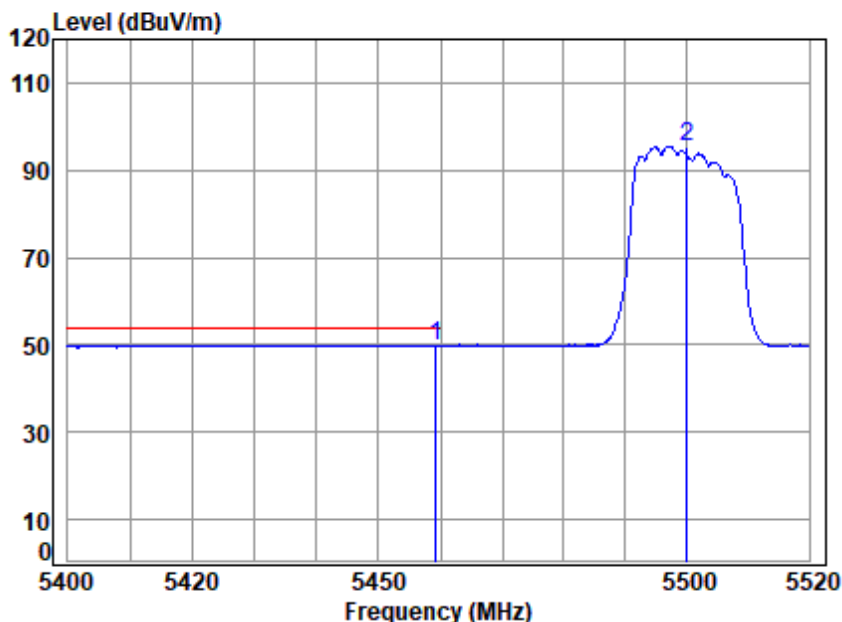

Site : chamber
 Condition: 3m VERTICAL
 Job No : 00028CR/00029CR
 Mode : 5500 Band edge
 : 5G WIFI 11A

	Freq	Cable Loss	Ant Factor	Preamp Factor	Read Level	Limit Level	Over Limit	Remark
	MHz	dB	dB/m	dB	dBuV	dBuV/m	dBuV/m	dB
1	5459.311	8.11	34.57	42.35	49.62	49.95	54.00	-4.05 Average
2	5500.000	8.18	34.60	42.35	95.15	95.58	-----	----- Average



Unless otherwise agreed in writing, this document is issued by the Company subject to its General Conditions of Service printed overleaf, available on request or accessible at <http://www.sgs.com/en/Terms-and-Conditions.aspx> and, for electronic format documents, subject to Terms and Conditions for Electronic Documents at <http://www.sgs.com/en/Terms-and-Conditions/Terms-e-Documents.aspx>. Attention is drawn to the limitation of liability, indemnification and jurisdiction issues defined therein. Any holder of this document is advised that information contained hereon reflects the Company's findings at the time of its intervention only and within the limits of Client's instructions, if any. The Company's sole responsibility is to its Client and this document does not exonerate parties to a transaction from exercising all their rights and obligations under the transaction documents. This document cannot be reproduced except in full, without prior written approval of the Company. Any unauthorized alteration, forgery or falsification of the content or appearance of this document is unlawful and offenders may be prosecuted to the fullest extent of the law. Unless otherwise stated the results shown in this test report refer only to the sample(s) tested and such sample(s) are retained for 30 days only.
 Attention: To check the authenticity of testing / inspection report & certificate, please contact us at telephone: (86-755) 8307 1443, or email: CN.Doccheck@sgs.com

Test Mode: 04; Polarity: Horizontal; Modulation:802.11a; Bandwidth:20MHz; Channel:High

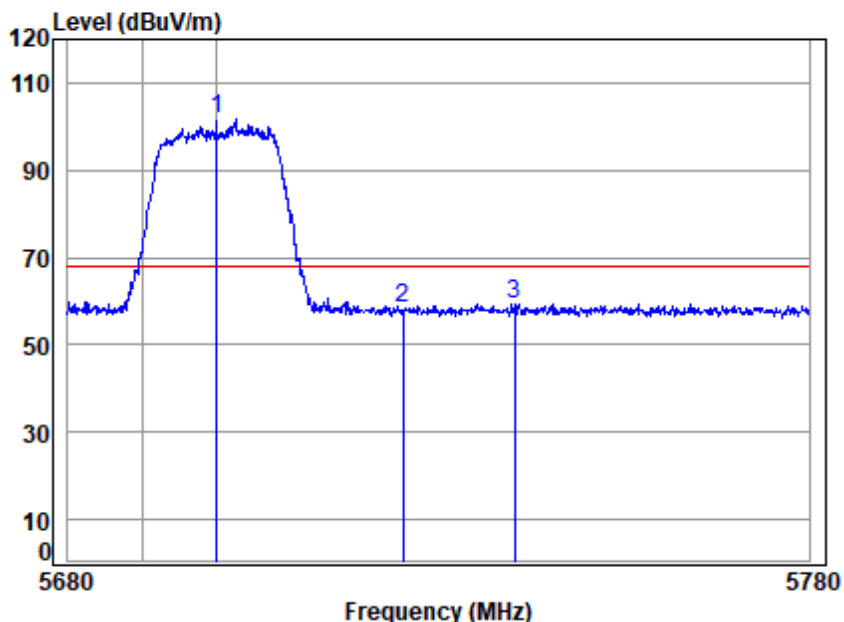

Site : chamber
 Condition: 3m HORIZONTAL
 Job No : 00028CR/00029CR
 Mode : 5700 Band edge
 : 5G WIFI 11A

Freq	Cable Loss	Ant Factor	Preamp Factor	Read Level	Level	Limit Line	Over Limit	Remark
MHz	dB	dB/m	dB	dBuV	dBuV/m	dBuV/m	dB	
1 * 5700.000	8.21	34.81	42.37	101.03	101.68	68.20	33.48	peak
2 5725.000	8.22	34.83	42.37	57.72	58.40	68.20	-9.80	peak
3 5740.091	8.22	34.85	42.38	58.81	59.50	68.20	-8.70	peak



Unless otherwise agreed in writing, this document is issued by the Company subject to its General Conditions of Service printed overleaf, available on request or accessible at <http://www.sgs.com/en/Terms-and-Conditions.aspx> and, for electronic format documents, subject to Terms and Conditions for Electronic Documents at <http://www.sgs.com/en/Terms-and-Conditions/Terms-e-Documents.aspx>. Attention is drawn to the limitation of liability, indemnification and jurisdiction issues defined therein. Any holder of this document is advised that information contained hereon reflects the Company's findings at the time of its intervention only and within the limits of Client's instructions, if any. The Company's sole responsibility is to its Client and this document does not exonerate parties to a transaction from exercising all their rights and obligations under the transaction documents. This document cannot be reproduced except in full, without prior written approval of the Company. Any unauthorized alteration, forgery or falsification of the content or appearance of this document is unlawful and offenders may be prosecuted to the fullest extent of the law. Unless otherwise stated the results shown in this test report refer only to the sample(s) tested and such sample(s) are retained for 30 days only.
 Attention: To check the authenticity of testing /inspection report & certificate, please contact us at telephone: (86-755) 8307 1443, or email: CN.Doccheck@sgs.com

Test Mode: 04; Polarity: Vertical; Modulation:802.11a; Bandwidth:20MHz; Channel:High

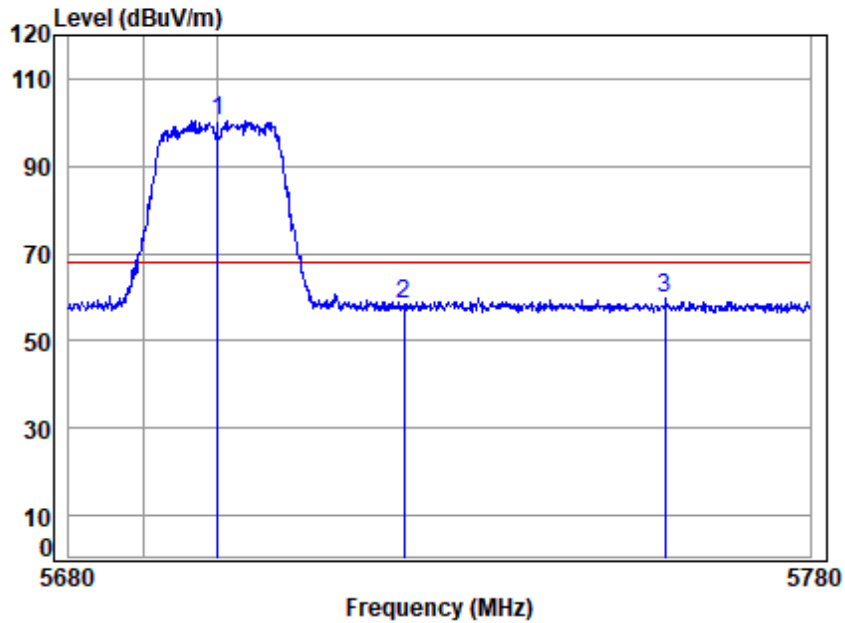

Site : chamber
 Condition: 3m VERTICAL
 Job No : 00028CR/00029CR
 Mode : 5700 Band edge
 : 5G WIFI 11A

Freq	Cable Loss	Ant Factor	Preamp Factor	Read Level	Level	Limit Line	Over Limit	Remark
MHz	dB	dB/m	dB	dBuV	dBuV/m	dBuV/m	dB	
1 * 5700.000	8.21	34.81	42.37	99.93	100.58	68.20	32.38	Peak
2 5725.000	8.22	34.83	42.37	57.74	58.42	68.20	-9.78	Peak
3 5760.363	8.22	34.87	42.38	59.06	59.77	68.20	-8.43	Peak



Unless otherwise agreed in writing, this document is issued by the Company subject to its General Conditions of Service printed overleaf, available on request or accessible at <http://www.sgs.com/en/Terms-and-Conditions.aspx> and, for electronic format documents, subject to Terms and Conditions for Electronic Documents at <http://www.sgs.com/en/Terms-and-Conditions/Terms-e-Documents.aspx>. Attention is drawn to the limitation of liability, indemnification and jurisdiction issues defined therein. Any holder of this document is advised that information contained hereon reflects the Company's findings at the time of its intervention only and within the limits of Client's instructions, if any. The Company's sole responsibility is to its Client and this document does not exonerate parties to a transaction from exercising all their rights and obligations under the transaction documents. This document cannot be reproduced except in full, without prior written approval of the Company. Any unauthorized alteration, forgery or falsification of the content or appearance of this document is unlawful and offenders may be prosecuted to the fullest extent of the law. Unless otherwise stated the results shown in this test report refer only to the sample(s) tested and such sample(s) are retained for 30 days only.
 Attention: To check the authenticity of testing / inspection report & certificate, please contact us at telephone: (86-755) 8307 1443, or email: CN.Doccheck@sgs.com

Test Mode: 04; Polarity: Horizontal; Modulation:802.11n; Bandwidth:20MHz; Channel:Low

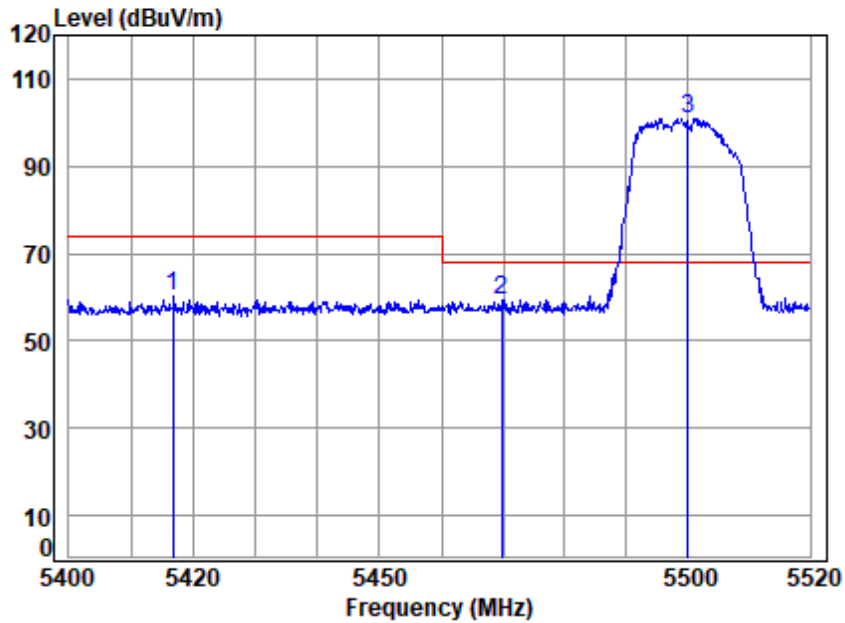

Site : chamber
 Condition: 3m HORIZONTAL
 Job No : 00028CR/00029CR
 Mode : 5500 Band edge
 : 5G WIFI 11N20

	Cable	Ant	Preamp	Read	Limit	Over	
Freq	Loss	Factor	Factor	Level	Level	Line	Limit Remark
MHz	dB	dB/m	dB	dBuV	dBuV/m	dBuV/m	dB
1	5416.761	8.04	34.54	42.34	59.79	60.03	74.00 -13.97 peak
2	5469.759	8.13	34.58	42.35	59.13	59.49	68.20 -8.71 peak
3 *	5500.000	8.18	34.60	42.35	100.46	100.89	68.20 32.69 peak



Unless otherwise agreed in writing, this document is issued by the Company subject to its General Conditions of Service printed overleaf, available on request or accessible at <http://www.sgs.com/en/Terms-and-Conditions.aspx> and, for electronic format documents, subject to Terms and Conditions for Electronic Documents at <http://www.sgs.com/en/Terms-and-Conditions/Terms-e-Documents.aspx>. Attention is drawn to the limitation of liability, indemnification and jurisdiction issues defined therein. Any holder of this document is advised that information contained hereon reflects the Company's findings at the time of its intervention only and within the limits of Client's instructions, if any. The Company's sole responsibility is to its Client and this document does not exonerate parties to a transaction from exercising all their rights and obligations under the transaction documents. This document cannot be reproduced except in full, without prior written approval of the Company. Any unauthorized alteration, forgery or falsification of the content or appearance of this document is unlawful and offenders may be prosecuted to the fullest extent of the law. Unless otherwise stated the results shown in this test report refer only to the sample(s) tested and such sample(s) are retained for 30 days only.
 Attention: To check the authenticity of testing / inspection report & certificate, please contact us at telephone: (86-755) 8307 1443, or email: CN.Doccheck@sgs.com

Test Mode: 04; Polarity: Horizontal; Modulation:802.11n; Bandwidth:20MHz; Channel:Low

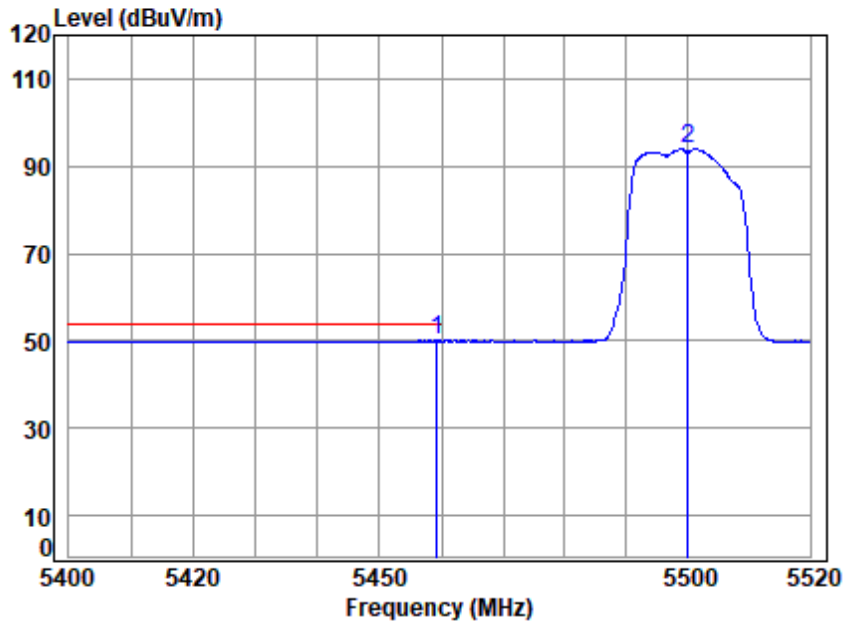

Site : chamber
 Condition: 3m HORIZONTAL
 Job No : 00028CR/00029CR
 Mode : 5500 Band edge
 : 5G WIFI 11N20

	Freq	Cable Loss	Ant Factor	Preamp Factor	Read Level	Limit Level	Over Limit	Remark
	MHz	dB	dB/m	dB	dBuV	dBuV/m	dBuV/m	dB
1	5459.190	8.11	34.57	42.35	49.75	50.08	54.00	-3.92 Average
2	5500.000	8.18	34.60	42.35	93.53	93.96	-----	----- Average



Unless otherwise agreed in writing, this document is issued by the Company subject to its General Conditions of Service printed overleaf, available on request or accessible at <http://www.sgs.com/en/Terms-and-Conditions.aspx> and, for electronic format documents, subject to Terms and Conditions for Electronic Documents at <http://www.sgs.com/en/Terms-and-Conditions/Terms-e-Documents.aspx>. Attention is drawn to the limitation of liability, indemnification and jurisdiction issues defined therein. Any holder of this document is advised that information contained hereon reflects the Company's findings at the time of its intervention only and within the limits of Client's instructions, if any. The Company's sole responsibility is to its Client and this document does not exonerate parties to a transaction from exercising all their rights and obligations under the transaction documents. This document cannot be reproduced except in full, without prior written approval of the Company. Any unauthorized alteration, forgery or falsification of the content or appearance of this document is unlawful and offenders may be prosecuted to the fullest extent of the law. Unless otherwise stated the results shown in this test report refer only to the sample(s) tested and such sample(s) are retained for 30 days only.
 Attention: To check the authenticity of testing /inspection report & certificate, please contact us at telephone: (86-755) 8307 1443, or email: CN.Doccheck@sgs.com

Test Mode: 04; Polarity: Vertical; Modulation:802.11n; Bandwidth:20MHz; Channel:Low

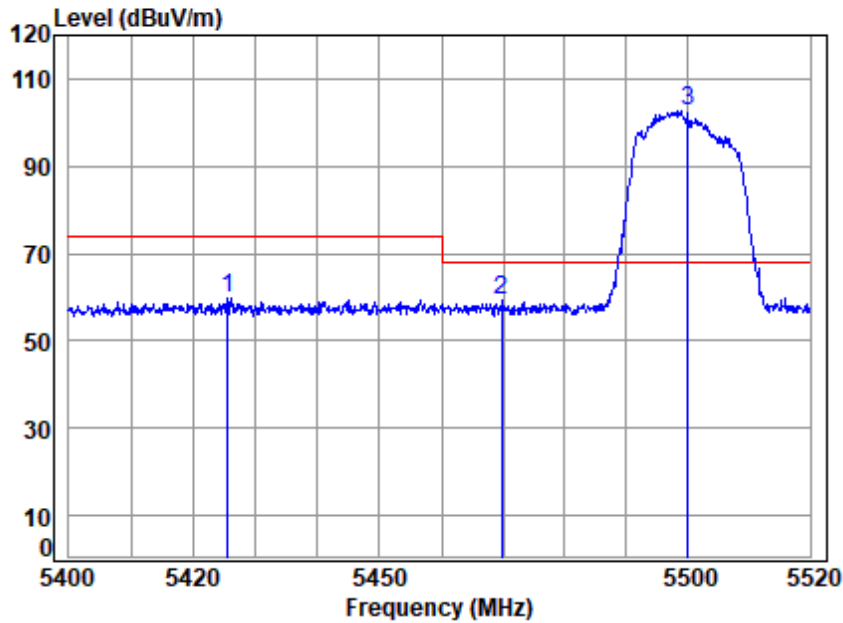

Site : chamber
 Condition: 3m VERTICAL
 Job No : 00028CR/00029CR
 Mode : 5500 Band edge
 : 5G WIFI 11N20

	Cable	Ant	Preamp	Read	Limit	Over		
Freq	Loss	Factor	Factor	Level	Level	Line	Limit	Remark
MHz	dB	dB/m	dB	dBuV	dBuV/m	dBuV/m	dB	
1	5425.578	8.05	34.54	42.34	59.33	59.58	74.00	-14.42 peak
2	5469.759	8.13	34.58	42.35	59.05	59.41	68.20	-8.79 peak
3 *	5500.000	8.18	34.60	42.35	102.46	102.89	68.20	34.69 peak



Unless otherwise agreed in writing, this document is issued by the Company subject to its General Conditions of Service printed overleaf, available on request or accessible at <http://www.sgs.com/en/Terms-and-Conditions.aspx> and, for electronic format documents, subject to Terms and Conditions for Electronic Documents at <http://www.sgs.com/en/Terms-and-Conditions/Terms-e-Documents.aspx>. Attention is drawn to the limitation of liability, indemnification and jurisdiction issues defined therein. Any holder of this document is advised that information contained hereon reflects the Company's findings at the time of its intervention only and within the limits of Client's instructions, if any. The Company's sole responsibility is to its Client and this document does not exonerate parties to a transaction from exercising all their rights and obligations under the transaction documents. This document cannot be reproduced except in full, without prior written approval of the Company. Any unauthorized alteration, forgery or falsification of the content or appearance of this document is unlawful and offenders may be prosecuted to the fullest extent of the law. Unless otherwise stated the results shown in this test report refer only to the sample(s) tested and such sample(s) are retained for 30 days only.
 Attention: To check the authenticity of testing /inspection report & certificate, please contact us at telephone: (86-755) 8307 1443, or email: CN.Doccheck@sgs.com

Test Mode: 04; Polarity: Vertical; Modulation:802.11n; Bandwidth:20MHz; Channel:Low

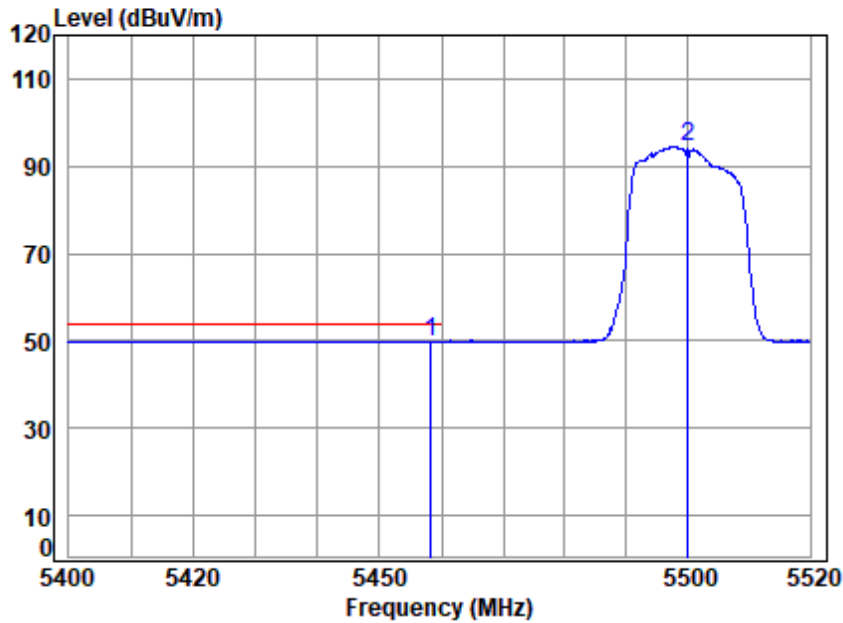

Site : chamber
 Condition: 3m VERTICAL
 Job No : 00028CR/00029CR
 Mode : 5500 Band edge
 : 5G WIFI 11N20

	Freq	Cable Loss	Ant Factor	Preamp Factor	Read Level	Limit Level	Over Limit	Remark
	MHz	dB	dB/m	dB	dBuV	dBuV/m	dBuV/m	dB
1	5458.230	8.11	34.57	42.35	49.63	49.96	54.00	-4.04 Average
2	5500.000	8.18	34.60	42.35	94.00	94.43	-----	----- Average



Unless otherwise agreed in writing, this document is issued by the Company subject to its General Conditions of Service printed overleaf, available on request or accessible at <http://www.sgs.com/en/Terms-and-Conditions.aspx> and, for electronic format documents, subject to Terms and Conditions for Electronic Documents at <http://www.sgs.com/en/Terms-and-Conditions/Terms-e-Documents.aspx>. Attention is drawn to the limitation of liability, indemnification and jurisdiction issues defined therein. Any holder of this document is advised that information contained hereon reflects the Company's findings at the time of its intervention only and within the limits of Client's instructions, if any. The Company's sole responsibility is to its Client and this document does not exonerate parties to a transaction from exercising all their rights and obligations under the transaction documents. This document cannot be reproduced except in full, without prior written approval of the Company. Any unauthorized alteration, forgery or falsification of the content or appearance of this document is unlawful and offenders may be prosecuted to the fullest extent of the law. Unless otherwise stated the results shown in this test report refer only to the sample(s) tested and such sample(s) are retained for 30 days only.
 Attention: To check the authenticity of testing / inspection report & certificate, please contact us at telephone: (86-755) 8307 1443, or email: CN.Doccheck@sgs.com

Test Mode: 04; Polarity: Horizontal; Modulation:802.11n; Bandwidth:20MHz; Channel:High

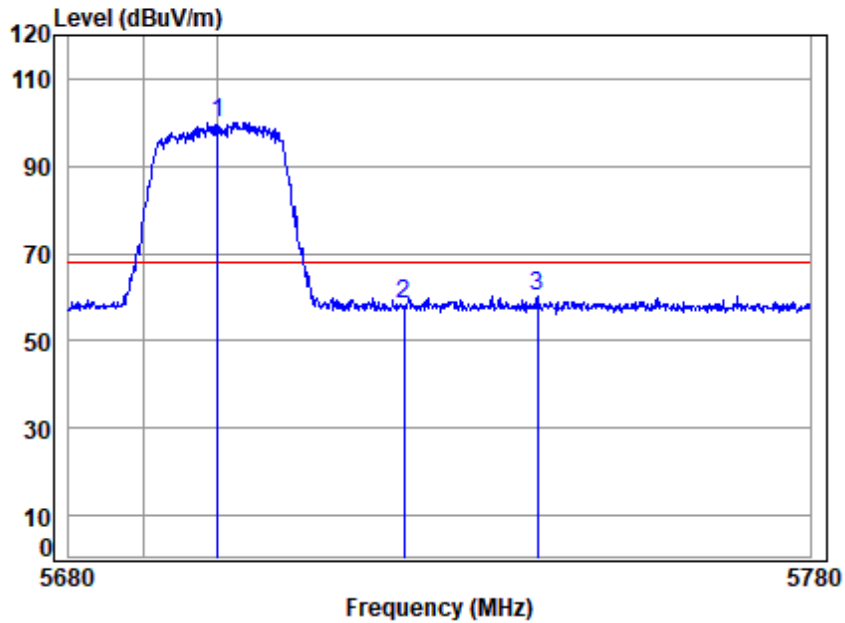

Site : chamber
 Condition: 3m HORIZONTAL
 Job No : 00028CR/00029CR
 Mode : 5700 Band edge
 : 5G WIFI 11N20

Freq	Cable Loss	Ant Factor	Preamp Factor	Read Level	Level	Limit Line	Over Limit	Remark
MHz	dB	dB/m	dB	dBuV	dBuV/m	dBuV/m	dB	
1 * 5700.000	8.21	34.81	42.37	99.43	100.08	68.20	31.88	peak
2 5725.000	8.22	34.83	42.37	57.60	58.28	68.20	-9.92	peak
3 5742.997	8.22	34.85	42.38	59.51	60.20	68.20	-8.00	peak



Unless otherwise agreed in writing, this document is issued by the Company subject to its General Conditions of Service printed overleaf, available on request or accessible at <http://www.sgs.com/en/Terms-and-Conditions.aspx> and, for electronic format documents, subject to Terms and Conditions for Electronic Documents at <http://www.sgs.com/en/Terms-and-Conditions/Terms-e-Documents.aspx>. Attention is drawn to the limitation of liability, indemnification and jurisdiction issues defined therein. Any holder of this document is advised that information contained hereon reflects the Company's findings at the time of its intervention only and within the limits of Client's instructions, if any. The Company's sole responsibility is to its Client and this document does not exonerate parties to a transaction from exercising all their rights and obligations under the transaction documents. This document cannot be reproduced except in full, without prior written approval of the Company. Any unauthorized alteration, forgery or falsification of the content or appearance of this document is unlawful and offenders may be prosecuted to the fullest extent of the law. Unless otherwise stated the results shown in this test report refer only to the sample(s) tested and such sample(s) are retained for 30 days only.
 Attention: To check the authenticity of testing /inspection report & certificate, please contact us at telephone: (86-755) 8307 1443, or email: CN.Doccheck@sgs.com

Test Mode: 04; Polarity: Vertical; Modulation:802.11n; Bandwidth:20MHz; Channel:High

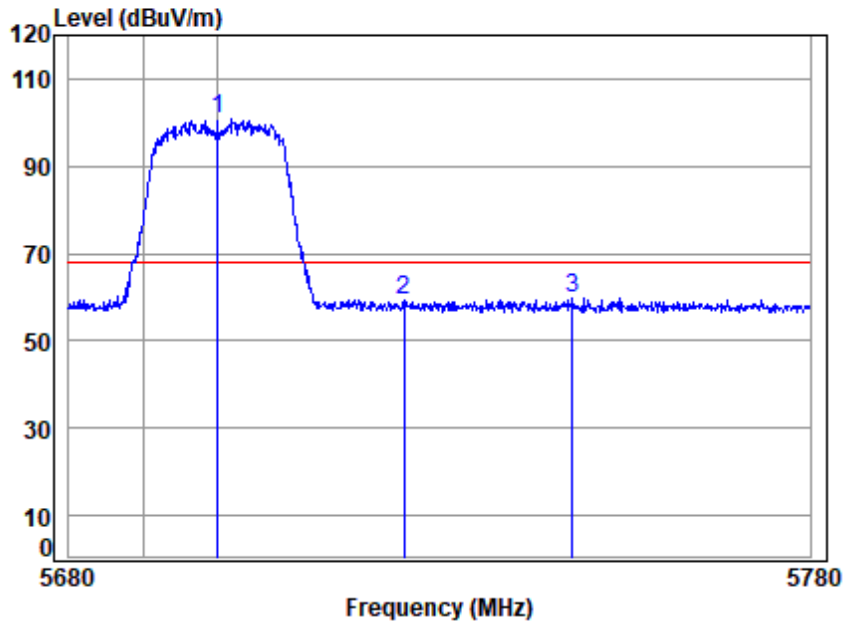

Site : chamber
 Condition: 3m VERTICAL
 Job No : 00028CR/00029CR
 Mode : 5700 Band edge
 : 5G WIFI 11N20

	Cable	Ant	Preamp	Read	Limit	Over	
Freq	Loss	Factor	Factor	Level	Level	Line	Limit Remark
MHz	dB	dB/m	dB	dBuV	dBuV/m	dBuV/m	dB
1 * 5700.000	8.21	34.81	42.37	100.02	100.67	68.20	32.47 Peak
2 5725.000	8.22	34.83	42.37	58.81	59.49	68.20	-8.71 Peak
3 5747.810	8.22	34.85	42.38	58.94	59.63	68.20	-8.57 Peak



Unless otherwise agreed in writing, this document is issued by the Company subject to its General Conditions of Service printed overleaf, available on request or accessible at <http://www.sgs.com/en/Terms-and-Conditions.aspx> and, for electronic format documents, subject to Terms and Conditions for Electronic Documents at <http://www.sgs.com/en/Terms-and-Conditions/Terms-e-Documents.aspx>. Attention is drawn to the limitation of liability, indemnification and jurisdiction issues defined therein. Any holder of this document is advised that information contained hereon reflects the Company's findings at the time of its intervention only and within the limits of Client's instructions, if any. The Company's sole responsibility is to its Client and this document does not exonerate parties to a transaction from exercising all their rights and obligations under the transaction documents. This document cannot be reproduced except in full, without prior written approval of the Company. Any unauthorized alteration, forgery or falsification of the content or appearance of this document is unlawful and offenders may be prosecuted to the fullest extent of the law. Unless otherwise stated the results shown in this test report refer only to the sample(s) tested and such sample(s) are retained for 30 days only.
 Attention: To check the authenticity of testing / inspection report & certificate, please contact us at telephone: (86-755) 8307 1443, or email: CN.Doccheck@sgs.com

Test Mode: 04; Polarity: Horizontal; Modulation:802.11n; Bandwidth:40MHz; Channel:Low

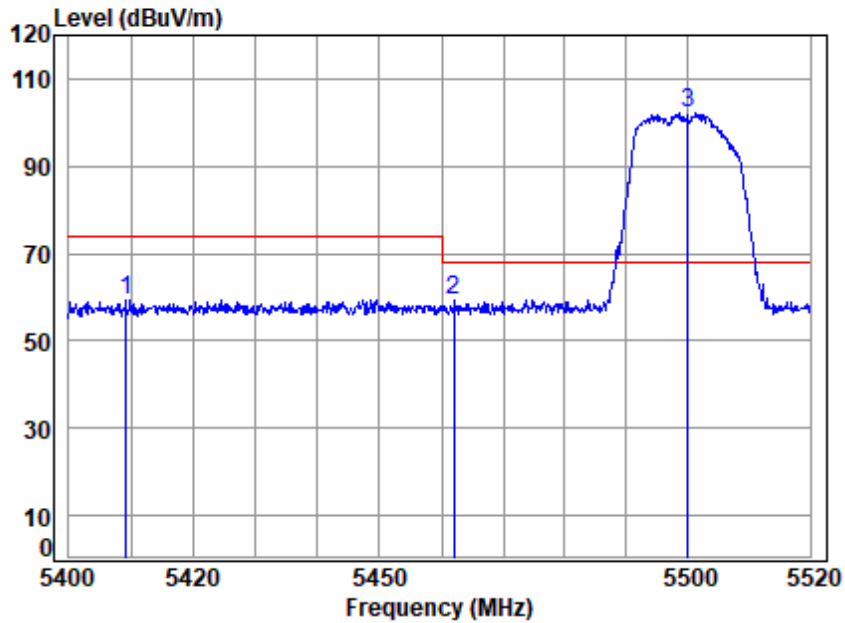

Site : chamber
 Condition: 3m HORIZONTAL
 Job No : 00028CR/00029CR
 Mode : 5500 Band edge
 : 5G WIFI 11AC20

	Cable	Ant	Preamp	Read	Limit	Over		
Freq	Loss	Factor	Factor	Level	Level	Line	Limit	Remark
MHz	dB	dB/m	dB	dBuV	dBuV/m	dBuV/m	dB	
1	5409.146	8.03	34.53	42.34	59.20	59.42	74.00	-14.58 peak
2	5462.071	8.12	34.57	42.35	58.85	59.19	68.20	-9.01 peak
3 *	5500.000	8.18	34.60	42.35	101.66	102.09	68.20	33.89 peak



Unless otherwise agreed in writing, this document is issued by the Company subject to its General Conditions of Service printed overleaf, available on request or accessible at <http://www.sgs.com/en/Terms-and-Conditions.aspx> and, for electronic format documents, subject to Terms and Conditions for Electronic Documents at <http://www.sgs.com/en/Terms-and-Conditions/Terms-e-Documents.aspx>. Attention is drawn to the limitation of liability, indemnification and jurisdiction issues defined therein. Any holder of this document is advised that information contained hereon reflects the Company's findings at the time of its intervention only and within the limits of Client's instructions, if any. The Company's sole responsibility is to its Client and this document does not exonerate parties to a transaction from exercising all their rights and obligations under the transaction documents. This document cannot be reproduced except in full, without prior written approval of the Company. Any unauthorized alteration, forgery or falsification of the content or appearance of this document is unlawful and offenders may be prosecuted to the fullest extent of the law. Unless otherwise stated the results shown in this test report refer only to the sample(s) tested and such sample(s) are retained for 30 days only.
 Attention: To check the authenticity of testing /inspection report & certificate, please contact us at telephone: (86-755) 8307 1443, or email: CN.Doccheck@sgs.com

Test Mode: 04; Polarity: Horizontal; Modulation:802.11n; Bandwidth:40MHz; Channel:Low

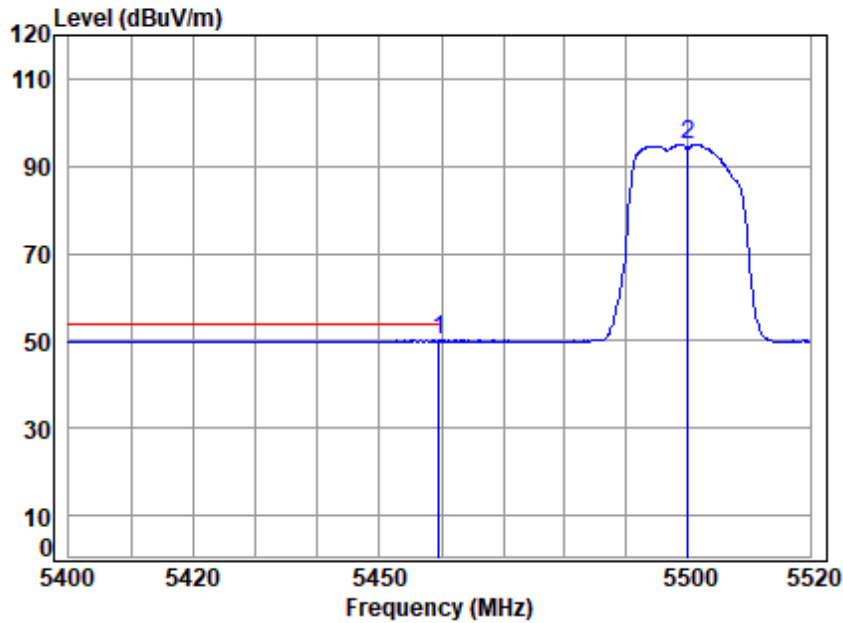

Site : chamber
 Condition: 3m HORIZONTAL
 Job No : 00028CR/00029CR
 Mode : 5500 Band edge
 : 5G WIFI 11AC20

	Freq	Cable Loss	Ant Factor	Preamp Factor	Read Level	Limit Level	Over Limit	Remark
	MHz	dB	dB/m	dB	dBuV	dBuV/m	dBuV/m	dB
1	5459.550	8.11	34.57	42.35	49.76	50.09	54.00	-3.91 Average
2	5500.000	8.18	34.60	42.35	94.59	95.02	-----	----- Average



Unless otherwise agreed in writing, this document is issued by the Company subject to its General Conditions of Service printed overleaf, available on request or accessible at <http://www.sgs.com/en/Terms-and-Conditions.aspx> and, for electronic format documents, subject to Terms and Conditions for Electronic Documents at <http://www.sgs.com/en/Terms-and-Conditions/Terms-e-Documents.aspx>. Attention is drawn to the limitation of liability, indemnification and jurisdiction issues defined therein. Any holder of this document is advised that information contained hereon reflects the Company's findings at the time of its intervention only and within the limits of Client's instructions, if any. The Company's sole responsibility is to its Client and this document does not exonerate parties to a transaction from exercising all their rights and obligations under the transaction documents. This document cannot be reproduced except in full, without prior written approval of the Company. Any unauthorized alteration, forgery or falsification of the content or appearance of this document is unlawful and offenders may be prosecuted to the fullest extent of the law. Unless otherwise stated the results shown in this test report refer only to the sample(s) tested and such sample(s) are retained for 30 days only.
 Attention: To check the authenticity of testing /inspection report & certificate, please contact us at telephone: (86-755) 8307 1443, or email: CN.Doccheck@sgs.com

Test Mode: 04; Polarity: Vertical; Modulation:802.11n; Bandwidth:40MHz; Channel:Low

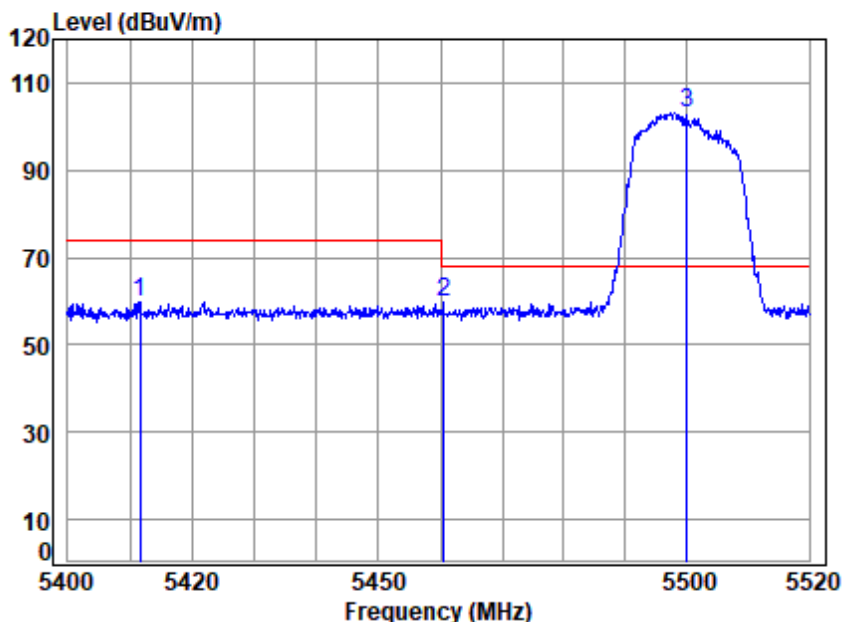

Site : chamber
 Condition: 3m VERTICAL
 Job No : 00028CR/00029CR
 Mode : 5500 Band edge
 : 5G WIFI 11AC20

	Cable	Ant	Preamp	Read	Limit	Over	
Freq	Loss	Factor	Factor	Level	Level	Line	Limit Remark
MHz	dB	dB/m	dB	dBuV	dBuV/m	dBuV/m	dB
1	5411.525	8.03	34.53	42.34	59.70	59.92	74.00 -14.08 peak
2	5460.510	8.11	34.57	42.35	59.34	59.67	68.20 -8.53 peak
3 *	5500.000	8.18	34.60	42.35	102.84	103.27	68.20 35.07 peak



Unless otherwise agreed in writing, this document is issued by the Company subject to its General Conditions of Service printed overleaf, available on request or accessible at <http://www.sgs.com/en/Terms-and-Conditions.aspx> and, for electronic format documents, subject to Terms and Conditions for Electronic Documents at <http://www.sgs.com/en/Terms-and-Conditions/Terms-e-Documents.aspx>. Attention is drawn to the limitation of liability, indemnification and jurisdiction issues defined therein. Any holder of this document is advised that information contained hereon reflects the Company's findings at the time of its intervention only and within the limits of Client's instructions, if any. The Company's sole responsibility is to its Client and this document does not exonerate parties to a transaction from exercising all their rights and obligations under the transaction documents. This document cannot be reproduced except in full, without prior written approval of the Company. Any unauthorized alteration, forgery or falsification of the content or appearance of this document is unlawful and offenders may be prosecuted to the fullest extent of the law. Unless otherwise stated the results shown in this test report refer only to the sample(s) tested and such sample(s) are retained for 30 days only.
 Attention: To check the authenticity of testing /inspection report & certificate, please contact us at telephone: (86-755) 8307 1443, or email: CN.Doccheck@sgs.com

Test Mode: 04; Polarity: Vertical; Modulation:802.11n; Bandwidth:40MHz; Channel:Low

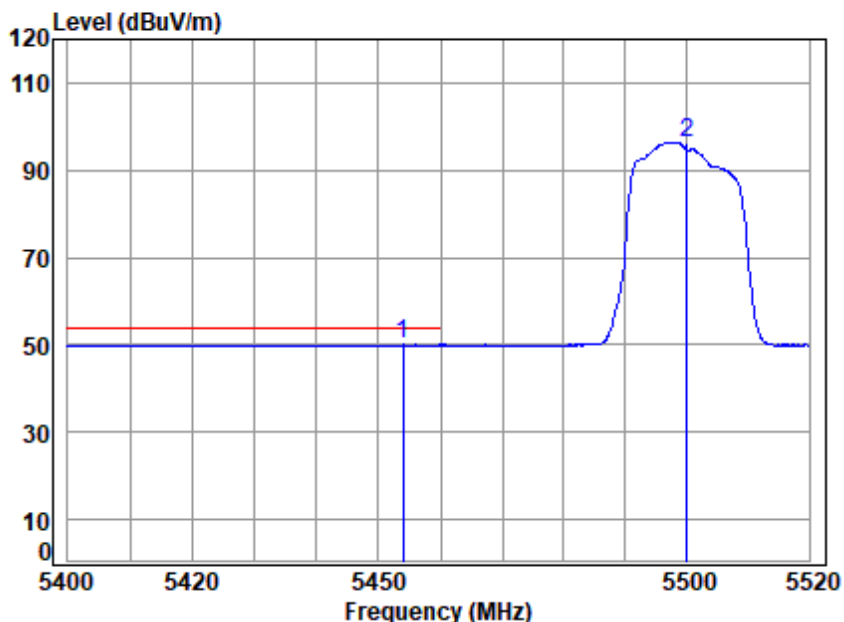

Site : chamber
 Condition: 3m VERTICAL
 Job No : 00028CR/00029CR
 Mode : 5500 Band edge
 : 5G WIFI 11AC20

	Freq	Cable Loss	Ant Factor	Preamp Factor	Read Level	Limit Level	Over Limit	Remark
	MHz	dB	dB/m	dB	dBuV	dBuV/m	dBuV/m	dB
1	5453.914	8.10	34.56	42.35	49.70	50.01	54.00	-3.99 Average
2	5500.000	8.18	34.60	42.35	96.02	96.45	-----	----- Average



Unless otherwise agreed in writing, this document is issued by the Company subject to its General Conditions of Service printed overleaf, available on request or accessible at <http://www.sgs.com/en/Terms-and-Conditions.aspx> and, for electronic format documents, subject to Terms and Conditions for Electronic Documents at <http://www.sgs.com/en/Terms-and-Conditions/Terms-e-Documents.aspx>. Attention is drawn to the limitation of liability, indemnification and jurisdiction issues defined therein. Any holder of this document is advised that information contained hereon reflects the Company's findings at the time of its intervention only and within the limits of Client's instructions, if any. The Company's sole responsibility is to its Client and this document does not exonerate parties to a transaction from exercising all their rights and obligations under the transaction documents. This document cannot be reproduced except in full, without prior written approval of the Company. Any unauthorized alteration, forgery or falsification of the content or appearance of this document is unlawful and offenders may be prosecuted to the fullest extent of the law. Unless otherwise stated the results shown in this test report refer only to the sample(s) tested and such sample(s) are retained for 30 days only.
 Attention: To check the authenticity of testing /inspection report & certificate, please contact us at telephone: (86-755) 8307 1443, or email: CN.Doccheck@sgs.com

Test Mode: 04; Polarity: Horizontal; Modulation:802.11n; Bandwidth:40MHz; Channel:High

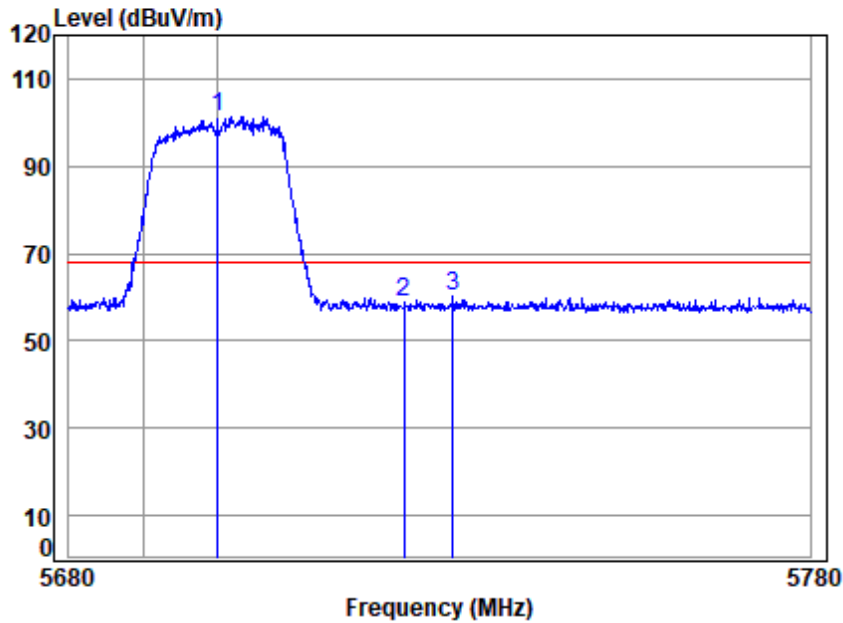

Site : chamber
 Condition: 3m HORIZONTAL
 Job No : 00028CR/00029CR
 Mode : 5700 Band edge
 : 5G WIFI 11AC20

	Cable	Ant	Preamp	Read	Limit	Over	
Freq	Loss	Factor	Factor	Level	Level	Line	Limit Remark
MHz	dB	dB/m	dB	dBuV	dBuV/m	dBuV/m	dB
1 * 5700.000	8.21	34.81	42.37	100.72	101.37	68.20	33.17 peak
2 5725.000	8.22	34.83	42.37	58.25	58.93	68.20	-9.27 peak
3 5731.582	8.22	34.84	42.37	59.60	60.29	68.20	-7.91 peak



Unless otherwise agreed in writing, this document is issued by the Company subject to its General Conditions of Service printed overleaf, available on request or accessible at <http://www.sgs.com/en/Terms-and-Conditions.aspx> and, for electronic format documents, subject to Terms and Conditions for Electronic Documents at <http://www.sgs.com/en/Terms-and-Conditions/Terms-e-Documents.aspx>. Attention is drawn to the limitation of liability, indemnification and jurisdiction issues defined therein. Any holder of this document is advised that information contained hereon reflects the Company's findings at the time of its intervention only and within the limits of Client's instructions, if any. The Company's sole responsibility is to its Client and this document does not exonerate parties to a transaction from exercising all their rights and obligations under the transaction documents. This document cannot be reproduced except in full, without prior written approval of the Company. Any unauthorized alteration, forgery or falsification of the content or appearance of this document is unlawful and offenders may be prosecuted to the fullest extent of the law. Unless otherwise stated the results shown in this test report refer only to the sample(s) tested and such sample(s) are retained for 30 days only.
 Attention: To check the authenticity of testing /inspection report & certificate, please contact us at telephone: (86-755) 8307 1443, or email: CN.Doccheck@sgs.com

Test Mode: 04; Polarity: Vertical; Modulation:802.11n; Bandwidth:40MHz; Channel:High

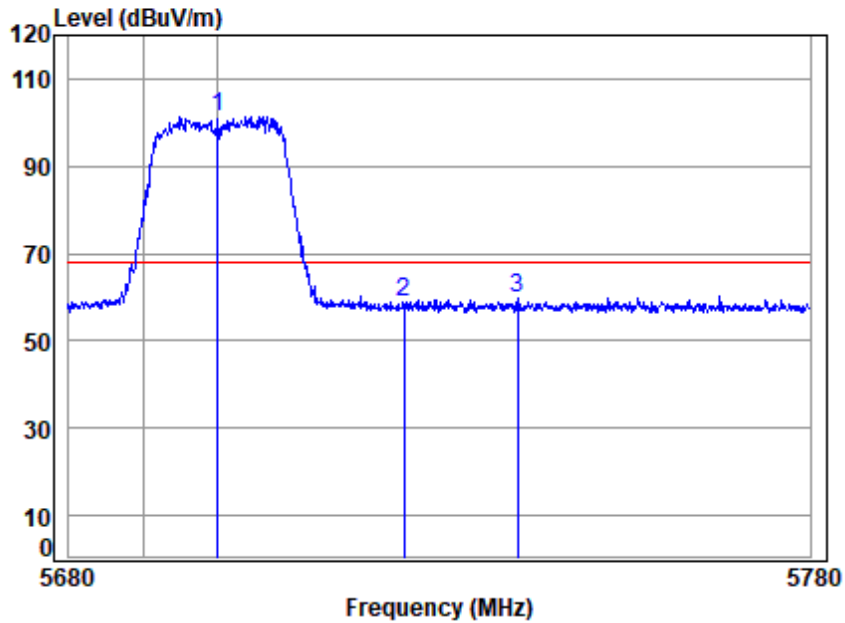

Site : chamber
 Condition: 3m VERTICAL
 Job No : 00028CR/00029CR
 Mode : 5700 Band edge
 : 5G WIFI 11AC20

Freq	Cable Loss	Ant Factor	Preamp Factor	Read Level	Level	Limit Line	Over Limit	Remark
MHz	dB	dB/m	dB	dBuV	dBuV/m	dBuV/m	dB	
1 * 5700.000	8.21	34.81	42.37	100.86	101.51	68.20	33.31	Peak
2 5725.000	8.22	34.83	42.37	57.97	58.65	68.20	-9.55	Peak
3 5740.292	8.22	34.85	42.38	59.31	60.00	68.20	-8.20	Peak



Unless otherwise agreed in writing, this document is issued by the Company subject to its General Conditions of Service printed overleaf, available on request or accessible at <http://www.sgs.com/en/Terms-and-Conditions.aspx> and, for electronic format documents, subject to Terms and Conditions for Electronic Documents at <http://www.sgs.com/en/Terms-and-Conditions/Terms-e-Documents.aspx>. Attention is drawn to the limitation of liability, indemnification and jurisdiction issues defined therein. Any holder of this document is advised that information contained hereon reflects the Company's findings at the time of its intervention only and within the limits of Client's instructions, if any. The Company's sole responsibility is to its Client and this document does not exonerate parties to a transaction from exercising all their rights and obligations under the transaction documents. This document cannot be reproduced except in full, without prior written approval of the Company. Any unauthorized alteration, forgery or falsification of the content or appearance of this document is unlawful and offenders may be prosecuted to the fullest extent of the law. Unless otherwise stated the results shown in this test report refer only to the sample(s) tested and such sample(s) are retained for 30 days only.
 Attention: To check the authenticity of testing / inspection report & certificate, please contact us at telephone: (86-755) 8307 1443, or email: CN.Doccheck@sgs.com

Test Mode: 04; Polarity: Horizontal; Modulation:802.11ac; Bandwidth:20MHz; Channel:Low

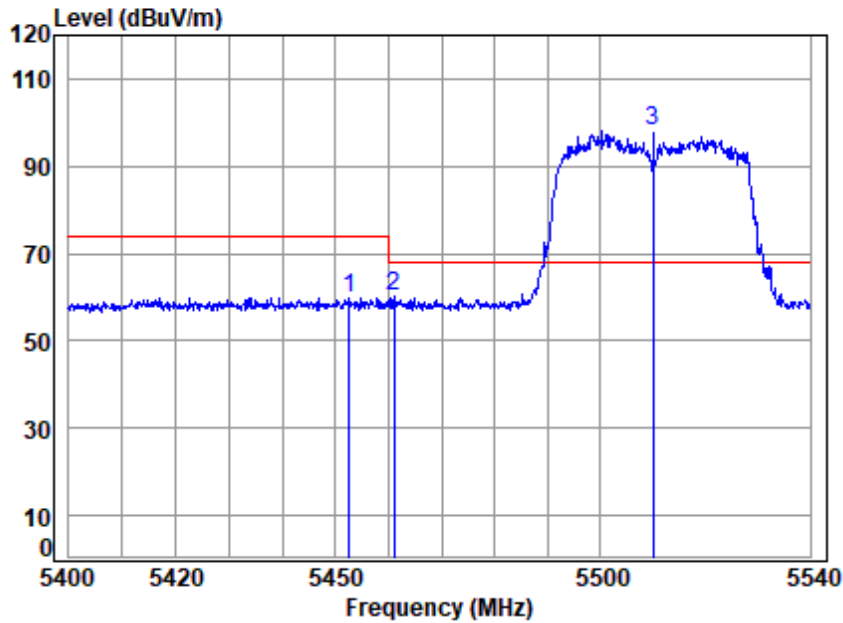

Site : chamber
 Condition: 3m HORIZONTAL
 Job No : 00028CR/00029CR
 Mode : 5510 Band edge
 : 5G WIFI 11N40

	Freq	Cable Loss	Ant Factor	Preamp Factor	Read Level	Limit Level	Over Limit	Remark
	MHz	dB	dB/m	dB	dBuV	dBuV/m	dBuV/m	dB
1	5452.639	8.10	34.56	42.35	59.66	59.97	74.00	-14.03 peak
2	5461.019	8.11	34.57	42.35	59.73	60.06	68.20	-8.14 peak
3 *	5510.000	8.18	34.61	42.35	97.45	97.89	68.20	29.69 peak



Unless otherwise agreed in writing, this document is issued by the Company subject to its General Conditions of Service printed overleaf, available on request or accessible at <http://www.sgs.com/en/Terms-and-Conditions.aspx> and, for electronic format documents, subject to Terms and Conditions for Electronic Documents at <http://www.sgs.com/en/Terms-and-Conditions/Terms-e-Documents.aspx>. Attention is drawn to the limitation of liability, indemnification and jurisdiction issues defined therein. Any holder of this document is advised that information contained hereon reflects the Company's findings at the time of its intervention only and within the limits of Client's instructions, if any. The Company's sole responsibility is to its Client and this document does not exonerate parties to a transaction from exercising all their rights and obligations under the transaction documents. This document cannot be reproduced except in full, without prior written approval of the Company. Any unauthorized alteration, forgery or falsification of the content or appearance of this document is unlawful and offenders may be prosecuted to the fullest extent of the law. Unless otherwise stated the results shown in this test report refer only to the sample(s) tested and such sample(s) are retained for 30 days only.
 Attention: To check the authenticity of testing /inspection report & certificate, please contact us at telephone: (86-755) 8307 1443, or email: CN.Doccheck@sgs.com

Test Mode: 04; Polarity: Horizontal; Modulation:802.11ac; Bandwidth:20MHz; Channel:Low

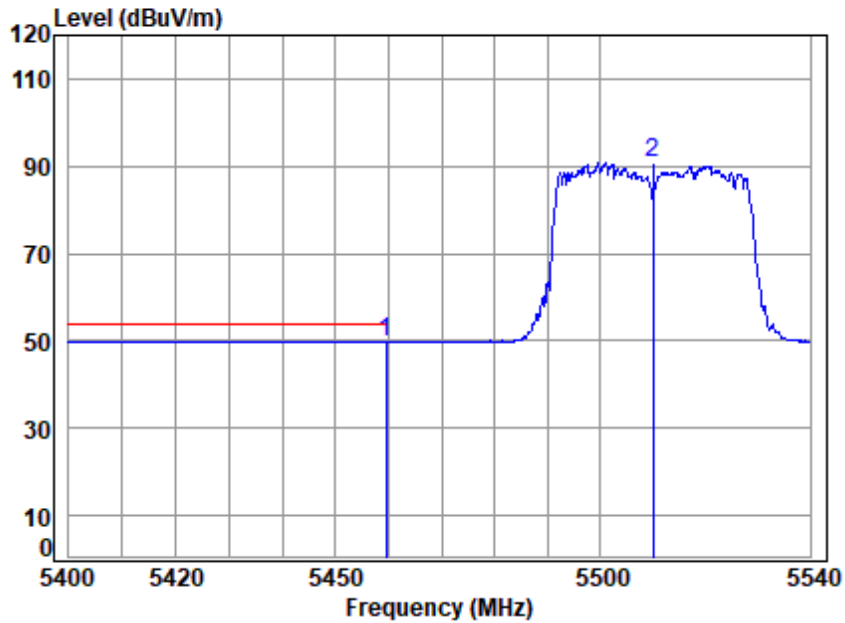

Site : chamber
 Condition: 3m HORIZONTAL
 Job No : 00028CR/00029CR
 Mode : 5510 Band edge
 : 5G WIFI 11N40

	Freq	Cable Loss	Ant Factor	Preamp Factor	Read Level	Limit Level	Over Limit	Remark
	MHz	dB	dB/m	dB	dBuV	dBuV/m	dBuV/m	dB
1	5459.481	8.11	34.57	42.35	49.54	49.87	54.00	-4.13 Average
2	5510.000	8.18	34.61	42.35	90.41	90.85	-----	----- Average



Unless otherwise agreed in writing, this document is issued by the Company subject to its General Conditions of Service printed overleaf, available on request or accessible at <http://www.sgs.com/en/Terms-and-Conditions.aspx> and, for electronic format documents, subject to Terms and Conditions for Electronic Documents at <http://www.sgs.com/en/Terms-and-Conditions/Terms-e-Documents.aspx>. Attention is drawn to the limitation of liability, indemnification and jurisdiction issues defined therein. Any holder of this document is advised that information contained hereon reflects the Company's findings at the time of its intervention only and within the limits of Client's instructions, if any. The Company's sole responsibility is to its Client and this document does not exonerate parties to a transaction from exercising all their rights and obligations under the transaction documents. This document cannot be reproduced except in full, without prior written approval of the Company. Any unauthorized alteration, forgery or falsification of the content or appearance of this document is unlawful and offenders may be prosecuted to the fullest extent of the law. Unless otherwise stated the results shown in this test report refer only to the sample(s) tested and such sample(s) are retained for 30 days only.
 Attention: To check the authenticity of testing /inspection report & certificate, please contact us at telephone: (86-755) 8307 1443, or email: CN.Doccheck@sgs.com

Test Mode: 04; Polarity: Vertical; Modulation:802.11ac; Bandwidth:20MHz; Channel:Low

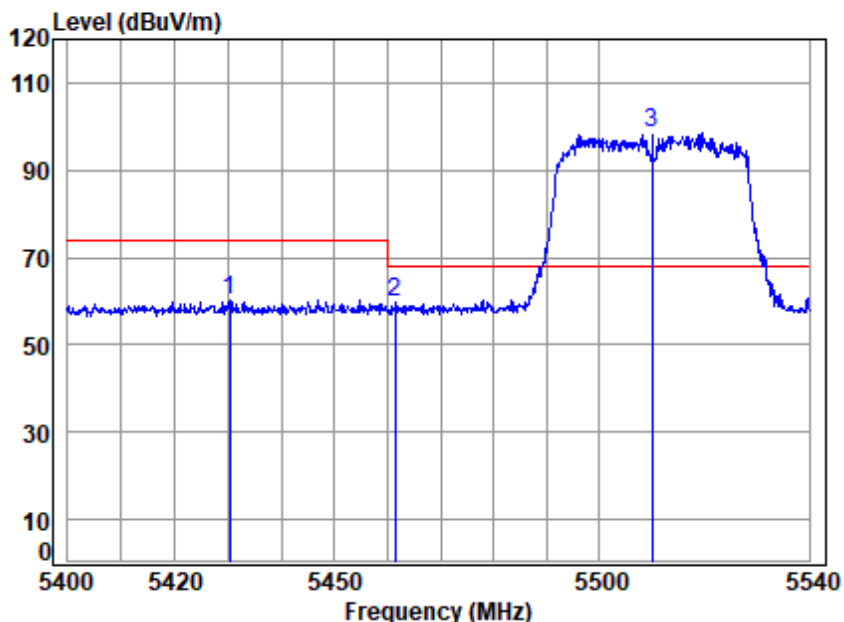

Site : chamber
 Condition: 3m VERTICAL
 Job No : 00028CR/00029CR
 Mode : 5510 Band edge
 : 5G WIFI 11N40

	Freq	Cable Loss	Ant Factor	Preamp Factor	Read Level	Limit Level	Over Limit	Remark
	MHz	dB	dB/m	dB	dBuV	dBuV/m	dBuV/m	dB
1	5430.215	8.06	34.55	42.35	59.92	60.18	74.00	-13.82 Peak
2	5461.438	8.12	34.57	42.35	59.33	59.67	68.20	-8.53 peak
3 *	5510.000	8.18	34.61	42.35	98.17	98.61	68.20	30.41 Peak



Unless otherwise agreed in writing, this document is issued by the Company subject to its General Conditions of Service printed overleaf, available on request or accessible at <http://www.sgs.com/en/Terms-and-Conditions.aspx> and, for electronic format documents, subject to Terms and Conditions for Electronic Documents at <http://www.sgs.com/en/Terms-and-Conditions/Terms-e-Documents.aspx>. Attention is drawn to the limitation of liability, indemnification and jurisdiction issues defined therein. Any holder of this document is advised that information contained hereon reflects the Company's findings at the time of its intervention only and within the limits of Client's instructions, if any. The Company's sole responsibility is to its Client and this document does not exonerate parties to a transaction from exercising all their rights and obligations under the transaction documents. This document cannot be reproduced except in full, without prior written approval of the Company. Any unauthorized alteration, forgery or falsification of the content or appearance of this document is unlawful and offenders may be prosecuted to the fullest extent of the law. Unless otherwise stated the results shown in this test report refer only to the sample(s) tested and such sample(s) are retained for 30 days only.
 Attention: To check the authenticity of testing / inspection report & certificate, please contact us at telephone: (86-755) 8307 1443, or email: CN.Doccheck@sgs.com

Test Mode: 04; Polarity: Vertical; Modulation:802.11ac; Bandwidth:20MHz; Channel:Low

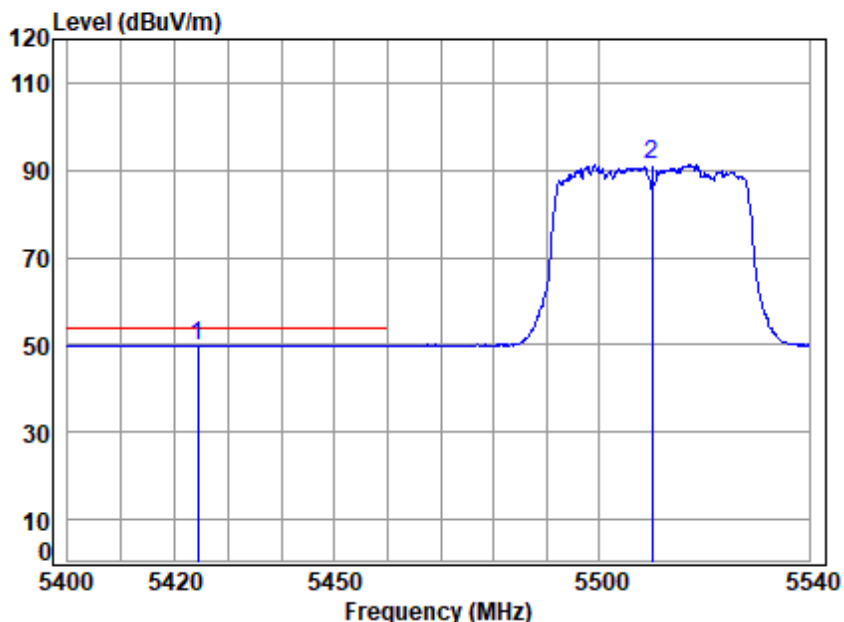

Site : chamber
 Condition: 3m VERTICAL
 Job No : 00028CR/00029CR
 Mode : 5510 Band edge
 : 5G WIFI 11N40

	Freq	Cable Loss	Ant Factor	Preamp Factor	Read Level	Limit Level	Over Limit	Remark
	MHz	dB	dB/m	dB	dBuV	dBuV/m	dBuV/m	dB
1	5424.242	8.05	34.54	42.34	49.71	49.96	54.00	-4.04 Average
2	5510.000	8.18	34.61	42.35	91.01	91.45	-----	----- Average



Unless otherwise agreed in writing, this document is issued by the Company subject to its General Conditions of Service printed overleaf, available on request or accessible at <http://www.sgs.com/en/Terms-and-Conditions.aspx> and, for electronic format documents, subject to Terms and Conditions for Electronic Documents at <http://www.sgs.com/en/Terms-and-Conditions/Terms-e-Documents.aspx>. Attention is drawn to the limitation of liability, indemnification and jurisdiction issues defined therein. Any holder of this document is advised that information contained hereon reflects the Company's findings at the time of its intervention only and within the limits of Client's instructions, if any. The Company's sole responsibility is to its Client and this document does not exonerate parties to a transaction from exercising all their rights and obligations under the transaction documents. This document cannot be reproduced except in full, without prior written approval of the Company. Any unauthorized alteration, forgery or falsification of the content or appearance of this document is unlawful and offenders may be prosecuted to the fullest extent of the law. Unless otherwise stated the results shown in this test report refer only to the sample(s) tested and such sample(s) are retained for 30 days only.
 Attention: To check the authenticity of testing / inspection report & certificate, please contact us at telephone: (86-755) 8307 1443, or email: CN.Doccheck@sgs.com

Test Mode: 04; Polarity: Horizontal; Modulation:802.11ac; Bandwidth:20MHz; Channel:High

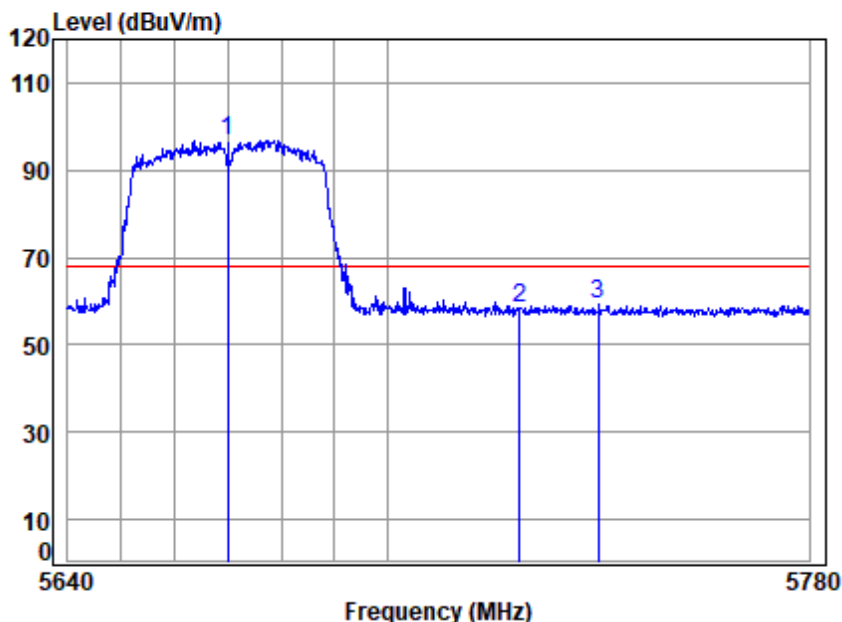

Site : chamber
 Condition: 3m HORIZONTAL
 Job No : 00028CR/00029CR
 Mode : 5670 Band edge
 : 5G WIFI 11N40

	Cable	Ant	Preamp	Read	Limit	Over	
Freq	Loss	Factor	Factor	Level	Line	Limit	Remark
MHz	dB	dB/m	dB	dBuV	dBuV/m	dBuV/m	dB
1 * 5670.000	8.21	34.77	42.37	96.31	96.92	68.20	28.72 peak
2 5725.000	8.22	34.83	42.37	57.91	58.59	68.20	-9.61 peak
3 5739.890	8.22	34.85	42.38	58.44	59.13	68.20	-9.07 peak



Unless otherwise agreed in writing, this document is issued by the Company subject to its General Conditions of Service printed overleaf, available on request or accessible at <http://www.sgs.com/en/Terms-and-Conditions.aspx> and, for electronic format documents, subject to Terms and Conditions for Electronic Documents at <http://www.sgs.com/en/Terms-and-Conditions/Terms-e-Documents.aspx>. Attention is drawn to the limitation of liability, indemnification and jurisdiction issues defined therein. Any holder of this document is advised that information contained hereon reflects the Company's findings at the time of its intervention only and within the limits of Client's instructions, if any. The Company's sole responsibility is to its Client and this document does not exonerate parties to a transaction from exercising all their rights and obligations under the transaction documents. This document cannot be reproduced except in full, without prior written approval of the Company. Any unauthorized alteration, forgery or falsification of the content or appearance of this document is unlawful and offenders may be prosecuted to the fullest extent of the law. Unless otherwise stated the results shown in this test report refer only to the sample(s) tested and such sample(s) are retained for 30 days only.
 Attention: To check the authenticity of testing / inspection report & certificate, please contact us at telephone: (86-755) 8307 1443, or email: CN.Doccheck@sgs.com

Test Mode: 04; Polarity: Vertical; Modulation:802.11ac; Bandwidth:20MHz; Channel:High

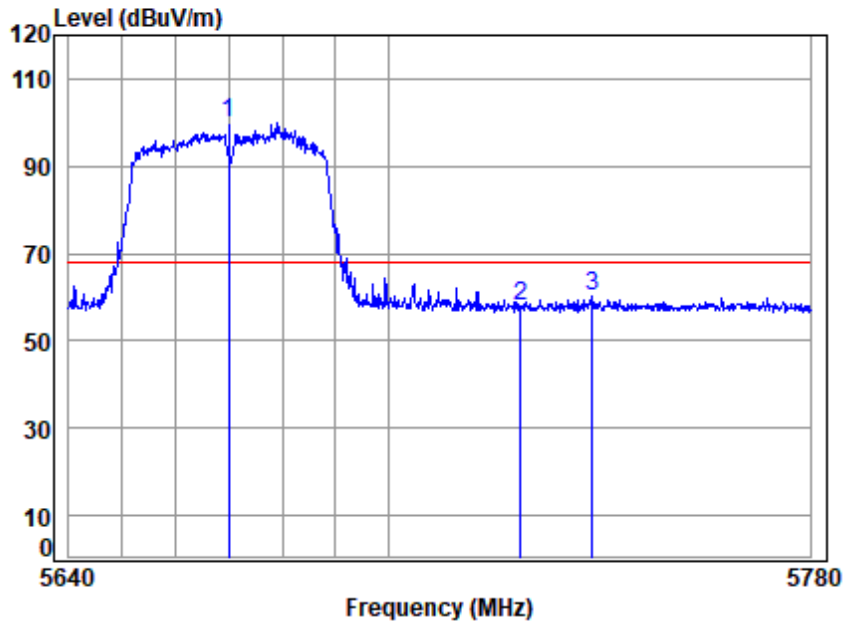

Site : chamber
 Condition: 3m VERTICAL
 Job No : 00028CR/00029CR
 Mode : 5670 Band edge
 : 5G WIFI 11N40

Freq	Cable Loss	Ant Factor	Preamp Factor	Read Level	Level	Limit Line	Over Limit	Remark
MHz	dB	dB/m	dB	dBuV	dBuV/m	dBuV/m	dB	
1 * 5670.000	8.21	34.77	42.37	99.16	99.77	68.20	31.57	Peak
2 5725.000	8.22	34.83	42.37	57.34	58.02	68.20	-10.18	Peak
3 5738.483	8.22	34.84	42.38	59.49	60.17	68.20	-8.03	Peak



Unless otherwise agreed in writing, this document is issued by the Company subject to its General Conditions of Service printed overleaf, available on request or accessible at <http://www.sgs.com/en/Terms-and-Conditions.aspx> and, for electronic format documents, subject to Terms and Conditions for Electronic Documents at <http://www.sgs.com/en/Terms-and-Conditions/Terms-e-Documents.aspx>. Attention is drawn to the limitation of liability, indemnification and jurisdiction issues defined therein. Any holder of this document is advised that information contained hereon reflects the Company's findings at the time of its intervention only and within the limits of Client's instructions, if any. The Company's sole responsibility is to its Client and this document does not exonerate parties to a transaction from exercising all their rights and obligations under the transaction documents. This document cannot be reproduced except in full, without prior written approval of the Company. Any unauthorized alteration, forgery or falsification of the content or appearance of this document is unlawful and offenders may be prosecuted to the fullest extent of the law. Unless otherwise stated the results shown in this test report refer only to the sample(s) tested and such sample(s) are retained for 30 days only.
 Attention: To check the authenticity of testing / inspection report & certificate, please contact us at telephone: (86-755) 8307 1443, or email: CN.Doccheck@sgs.com

Test Mode: 04; Polarity: Horizontal; Modulation:802.11ac; Bandwidth:40MHz; Channel:Low

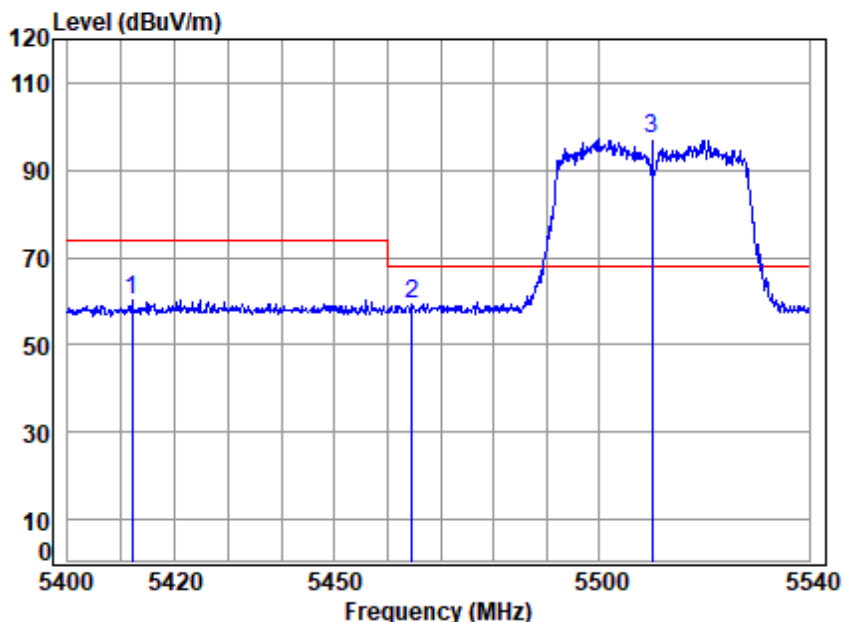

Site : chamber
 Condition: 3m HORIZONTAL
 Job No : 00028CR/00029CR
 Mode : 5510 Band edge
 : 5G WIFI 11AC40

	Freq	Cable Loss	Ant Factor	Preamp Factor	Read Level	Limit Level	Over Limit	Remark
	MHz	dB	dB/m	dB	dBuV	dBuV/m	dBuV/m	dB
1	5412.038	8.03	34.53	42.34	59.93	60.15	74.00	-13.85 peak
2	5464.515	8.12	34.57	42.35	59.15	59.49	68.20	-8.71 peak
3 *	5510.000	8.18	34.61	42.35	96.66	97.10	68.20	28.90 peak



Unless otherwise agreed in writing, this document is issued by the Company subject to its General Conditions of Service printed overleaf, available on request or accessible at <http://www.sgs.com/en/Terms-and-Conditions.aspx> and, for electronic format documents, subject to Terms and Conditions for Electronic Documents at <http://www.sgs.com/en/Terms-and-Conditions/Terms-e-Documents.aspx>. Attention is drawn to the limitation of liability, indemnification and jurisdiction issues defined therein. Any holder of this document is advised that information contained hereon reflects the Company's findings at the time of its intervention only and within the limits of Client's instructions, if any. The Company's sole responsibility is to its Client and this document does not exonerate parties to a transaction from exercising all their rights and obligations under the transaction documents. This document cannot be reproduced except in full, without prior written approval of the Company. Any unauthorized alteration, forgery or falsification of the content or appearance of this document is unlawful and offenders may be prosecuted to the fullest extent of the law. Unless otherwise stated the results shown in this test report refer only to the sample(s) tested and such sample(s) are retained for 30 days only.
 Attention: To check the authenticity of testing /inspection report & certificate, please contact us at telephone: (86-755) 8307 1443, or email: CN.Doccheck@sgs.com

Test Mode: 04; Polarity: Horizontal; Modulation:802.11ac; Bandwidth:40MHz; Channel:Low

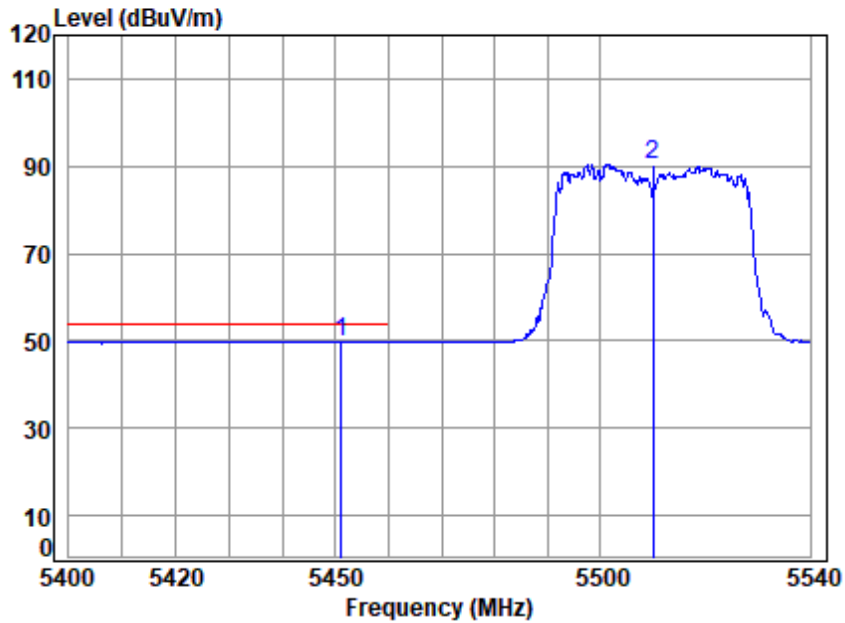

Site : chamber
 Condition: 3m HORIZONTAL
 Job No : 00028CR/00029CR
 Mode : 5510 Band edge
 : 5G WIFI 11AC40

	Freq	Cable Loss	Ant Factor	Preamp Factor	Read Level	Limit Level	Over Limit	Remark
	MHz	dB	dB/m	dB	dBuV	dBuV/m	dBuV/m	dB
1	5450.964	8.10	34.56	42.35	49.53	49.84	54.00	-4.16 Average
2	5510.000	8.18	34.61	42.35	90.02	90.46	-----	----- Average



Unless otherwise agreed in writing, this document is issued by the Company subject to its General Conditions of Service printed overleaf, available on request or accessible at <http://www.sgs.com/en/Terms-and-Conditions.aspx> and, for electronic format documents, subject to Terms and Conditions for Electronic Documents at <http://www.sgs.com/en/Terms-and-Conditions/Terms-e-Documents.aspx>. Attention is drawn to the limitation of liability, indemnification and jurisdiction issues defined therein. Any holder of this document is advised that information contained hereon reflects the Company's findings at the time of its intervention only and within the limits of Client's instructions, if any. The Company's sole responsibility is to its Client and this document does not exonerate parties to a transaction from exercising all their rights and obligations under the transaction documents. This document cannot be reproduced except in full, without prior written approval of the Company. Any unauthorized alteration, forgery or falsification of the content or appearance of this document is unlawful and offenders may be prosecuted to the fullest extent of the law. Unless otherwise stated the results shown in this test report refer only to the sample(s) tested and such sample(s) are retained for 30 days only.
 Attention: To check the authenticity of testing /inspection report & certificate, please contact us at telephone: (86-755) 8307 1443, or email: CN.Doccheck@sgs.com

Test Mode: 04; Polarity: Vertical; Modulation:802.11ac; Bandwidth:40MHz; Channel:Low

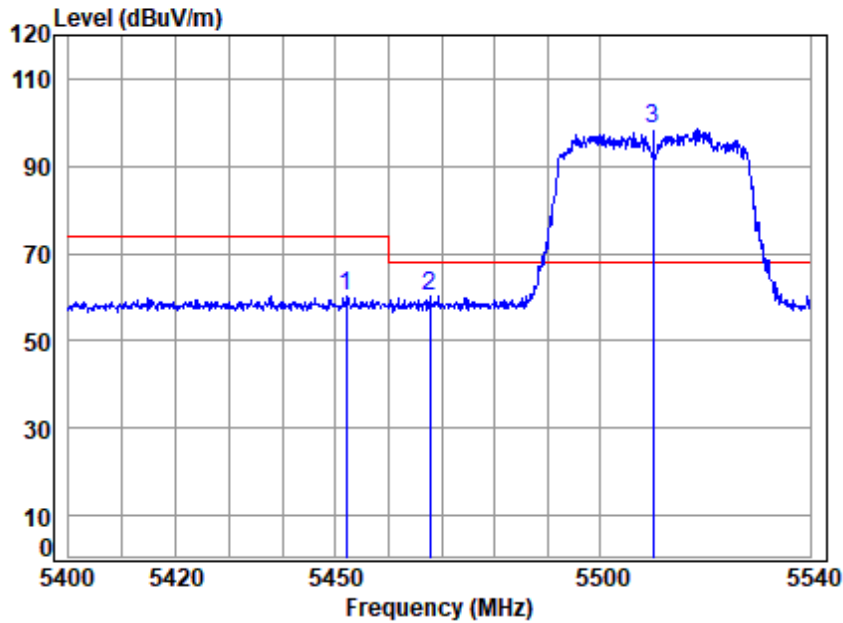

Site : chamber
 Condition: 3m VERTICAL
 Job No : 00028CR/00029CR
 Mode : 5510 Band edge
 : 5G WIFI 11AC40

	Cable	Ant	Preamp	Read	Limit	Over	
Freq	Loss	Factor	Factor	Level	Level	Line	Limit Remark
MHz	dB	dB/m	dB	dBuV	dBuV/m	dBuV/m	dB
1	8.10	34.56	42.35	59.79	60.10	74.00	-13.90 Peak
2	8.13	34.58	42.35	59.80	60.16	68.20	-8.04 peak
3 *	8.18	34.61	42.35	98.18	98.62	68.20	30.42 Peak



Unless otherwise agreed in writing, this document is issued by the Company subject to its General Conditions of Service printed overleaf, available on request or accessible at <http://www.sgs.com/en/Terms-and-Conditions.aspx> and, for electronic format documents, subject to Terms and Conditions for Electronic Documents at <http://www.sgs.com/en/Terms-and-Conditions/Terms-e-Documents.aspx>. Attention is drawn to the limitation of liability, indemnification and jurisdiction issues defined therein. Any holder of this document is advised that information contained hereon reflects the Company's findings at the time of its intervention only and within the limits of Client's instructions, if any. The Company's sole responsibility is to its Client and this document does not exonerate parties to a transaction from exercising all their rights and obligations under the transaction documents. This document cannot be reproduced except in full, without prior written approval of the Company. Any unauthorized alteration, forgery or falsification of the content or appearance of this document is unlawful and offenders may be prosecuted to the fullest extent of the law. Unless otherwise stated the results shown in this test report refer only to the sample(s) tested and such sample(s) are retained for 30 days only.
 Attention: To check the authenticity of testing /inspection report & certificate, please contact us at telephone: (86-755) 8307 1443, or email: CN.Doccheck@sgs.com

Test Mode: 04; Polarity: Vertical; Modulation:802.11ac; Bandwidth:40MHz; Channel:Low

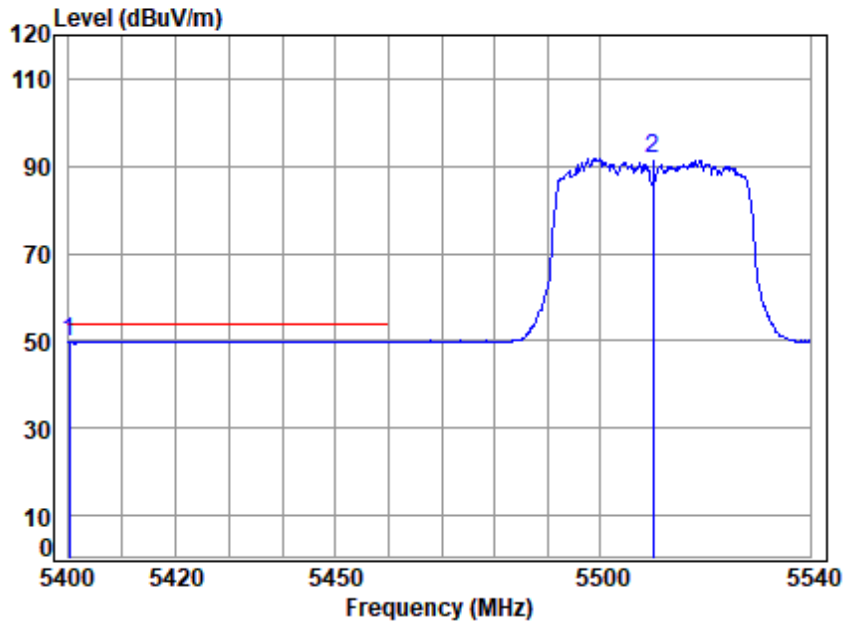

Site : chamber
 Condition: 3m VERTICAL
 Job No : 00028CR/00029CR
 Mode : 5510 Band edge
 : 5G WIFI 11AC40

	Freq	Cable Loss	Ant Factor	Preamp Factor	Read Level	Limit Level	Over Limit	Remark
	MHz	dB	dB/m	dB	dBuV	dBuV/m	dBuV/m	dB
1	5400.138	8.01	34.52	42.34	49.71	49.90	54.00	-4.10 Average
2	5510.000	8.18	34.61	42.35	91.29	91.73	-----	----- Average



Unless otherwise agreed in writing, this document is issued by the Company subject to its General Conditions of Service printed overleaf, available on request or accessible at <http://www.sgs.com/en/Terms-and-Conditions.aspx> and, for electronic format documents, subject to Terms and Conditions for Electronic Documents at <http://www.sgs.com/en/Terms-and-Conditions/Terms-e-Documents.aspx>. Attention is drawn to the limitation of liability, indemnification and jurisdiction issues defined therein. Any holder of this document is advised that information contained hereon reflects the Company's findings at the time of its intervention only and within the limits of Client's instructions, if any. The Company's sole responsibility is to its Client and this document does not exonerate parties to a transaction from exercising all their rights and obligations under the transaction documents. This document cannot be reproduced except in full, without prior written approval of the Company. Any unauthorized alteration, forgery or falsification of the content or appearance of this document is unlawful and offenders may be prosecuted to the fullest extent of the law. Unless otherwise stated the results shown in this test report refer only to the sample(s) tested and such sample(s) are retained for 30 days only.
 Attention: To check the authenticity of testing / inspection report & certificate, please contact us at telephone: (86-755) 8307 1443, or email: CN.Doccheck@sgs.com

Test Mode: 04; Polarity: Horizontal; Modulation:802.11ac; Bandwidth:40MHz; Channel:High

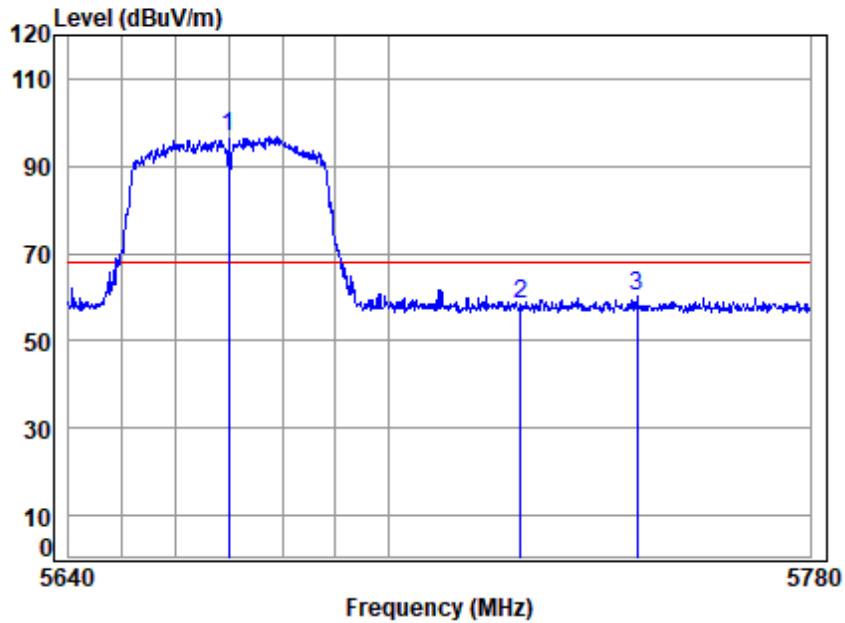

Site : chamber
 Condition: 3m HORIZONTAL
 Job No : 00028CR/00029CR
 Mode : 5670 Band edge
 : 5G WIFI 11AC40

	Cable	Ant	Preamp	Read	Limit	Over	
Freq	Loss	Factor	Factor	Level	Line	Limit	Remark
MHz	dB	dB/m	dB	dBuV	dBuV/m	dBuV/m	dB
1 * 5670.000	8.21	34.77	42.37	96.18	96.79	68.20	28.59 peak
2 5725.000	8.22	34.83	42.37	57.84	58.52	68.20	-9.68 peak
3 5747.073	8.22	34.85	42.38	59.63	60.32	68.20	-7.88 peak



Unless otherwise agreed in writing, this document is issued by the Company subject to its General Conditions of Service printed overleaf, available on request or accessible at <http://www.sgs.com/en/Terms-and-Conditions.aspx> and, for electronic format documents, subject to Terms and Conditions for Electronic Documents at <http://www.sgs.com/en/Terms-and-Conditions/Terms-e-Documents.aspx>. Attention is drawn to the limitation of liability, indemnification and jurisdiction issues defined therein. Any holder of this document is advised that information contained hereon reflects the Company's findings at the time of its intervention only and within the limits of Client's instructions, if any. The Company's sole responsibility is to its Client and this document does not exonerate parties to a transaction from exercising all their rights and obligations under the transaction documents. This document cannot be reproduced except in full, without prior written approval of the Company. Any unauthorized alteration, forgery or falsification of the content or appearance of this document is unlawful and offenders may be prosecuted to the fullest extent of the law. Unless otherwise stated the results shown in this test report refer only to the sample(s) tested and such sample(s) are retained for 30 days only.
 Attention: To check the authenticity of testing / inspection report & certificate, please contact us at telephone: (86-755) 8307 1443, or email: CN.Doccheck@sgs.com

Test Mode: 04; Polarity: Vertical; Modulation:802.11ac; Bandwidth:40MHz; Channel:High

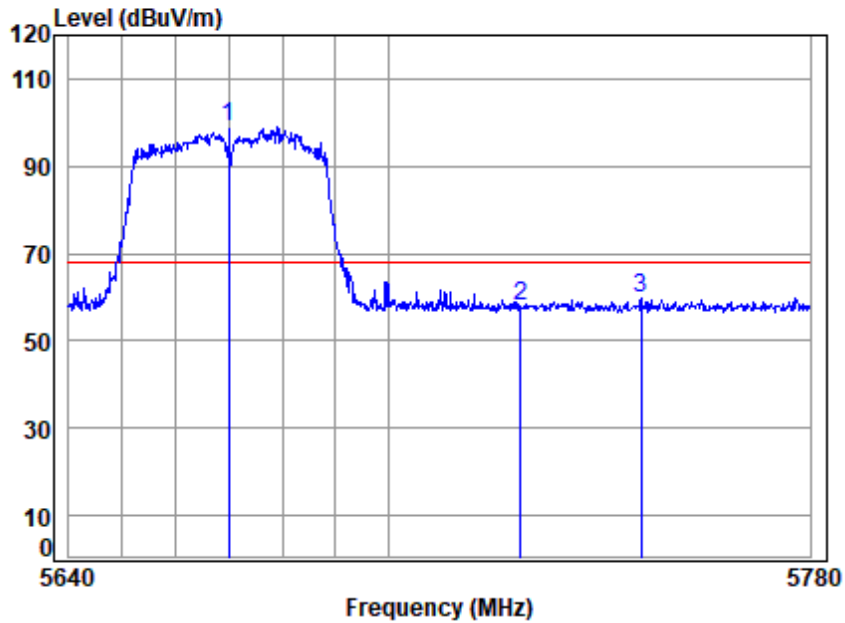

Site : chamber
 Condition: 3m VERTICAL
 Job No : 00028CR/00029CR
 Mode : 5670 Band edge
 : 5G WIFI 11AC40

	Cable	Ant	Preamp	Read	Limit	Over	
Freq	Loss	Factor	Factor	Level	Line	Limit	Remark
MHz	dB	dB/m	dB	dBuV	dBuV/m	dBuV/m	dB
1 * 5670.000	8.21	34.77	42.37	98.37	98.98	68.20	30.78 Peak
2 5725.000	8.22	34.83	42.37	57.14	57.82	68.20	-10.38 Peak
3 5747.777	8.22	34.85	42.38	58.88	59.57	68.20	-8.63 Peak



Unless otherwise agreed in writing, this document is issued by the Company subject to its General Conditions of Service printed overleaf, available on request or accessible at <http://www.sgs.com/en/Terms-and-Conditions.aspx> and, for electronic format documents, subject to Terms and Conditions for Electronic Documents at <http://www.sgs.com/en/Terms-and-Conditions/Terms-e-Documents.aspx>. Attention is drawn to the limitation of liability, indemnification and jurisdiction issues defined therein. Any holder of this document is advised that information contained hereon reflects the Company's findings at the time of its intervention only and within the limits of Client's instructions, if any. The Company's sole responsibility is to its Client and this document does not exonerate parties to a transaction from exercising all their rights and obligations under the transaction documents. This document cannot be reproduced except in full, without prior written approval of the Company. Any unauthorized alteration, forgery or falsification of the content or appearance of this document is unlawful and offenders may be prosecuted to the fullest extent of the law. Unless otherwise stated the results shown in this test report refer only to the sample(s) tested and such sample(s) are retained for 30 days only.
 Attention: To check the authenticity of testing / inspection report & certificate, please contact us at telephone: (86-755) 8307 1443, or email: CN.Doccheck@sgs.com

Test Mode: 04; Polarity: Horizontal; Modulation:802.11ac; Bandwidth:80MHz; Channel:Low

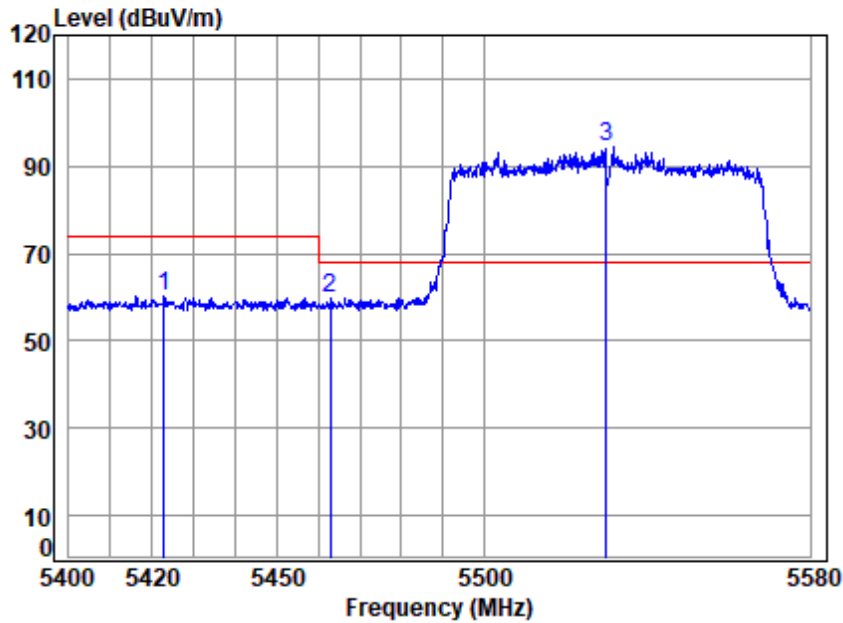

Site : chamber
 Condition: 3m HORIZONTAL
 Job No : 00028CR/00029CR
 Mode : 5530 Band edge
 : 5G WIFI 11AC80

	Freq	Cable Loss	Ant Factor	Preamp Factor	Read Level	Limit Level	Over Limit	Remark
	MHz	dB	dB/m	dB	dBuV	dBuV/m	dBuV/m	dB
1	5422.890	8.05	34.54	42.34	60.20	60.45	74.00	-13.55 peak
2	5462.867	8.12	34.57	42.35	59.63	59.97	68.20	-8.23 peak
3 *	5530.000	8.19	34.63	42.36	93.83	94.29	68.20	26.09 peak



Unless otherwise agreed in writing, this document is issued by the Company subject to its General Conditions of Service printed overleaf, available on request or accessible at <http://www.sgs.com/en/Terms-and-Conditions.aspx> and, for electronic format documents, subject to Terms and Conditions for Electronic Documents at <http://www.sgs.com/en/Terms-and-Conditions/Terms-e-Documents.aspx>. Attention is drawn to the limitation of liability, indemnification and jurisdiction issues defined therein. Any holder of this document is advised that information contained hereon reflects the Company's findings at the time of its intervention only and within the limits of Client's instructions, if any. The Company's sole responsibility is to its Client and this document does not exonerate parties to a transaction from exercising all their rights and obligations under the transaction documents. This document cannot be reproduced except in full, without prior written approval of the Company. Any unauthorized alteration, forgery or falsification of the content or appearance of this document is unlawful and offenders may be prosecuted to the fullest extent of the law. Unless otherwise stated the results shown in this test report refer only to the sample(s) tested and such sample(s) are retained for 30 days only.
 Attention: To check the authenticity of testing / inspection report & certificate, please contact us at telephone: (86-755) 8307 1443, or email: CN.Doccheck@sgs.com

Test Mode: 04; Polarity: Horizontal; Modulation:802.11ac; Bandwidth:80MHz; Channel:Low

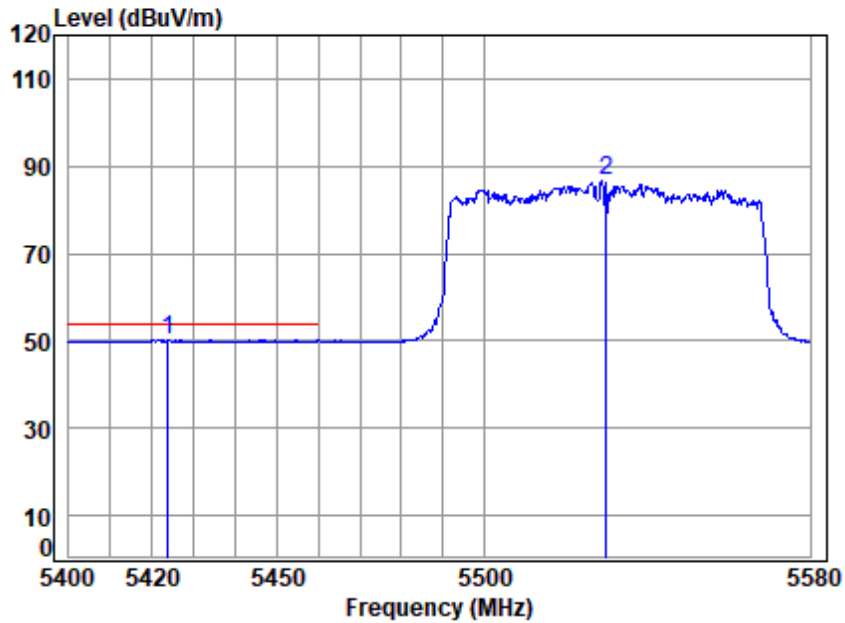

Site : chamber
 Condition: 3m HORIZONTAL
 Job No : 00028CR/00029CR
 Mode : 5530 Band edge
 : 5G WIFI 11AC80

	Freq	Cable Loss	Ant Factor	Preamp Factor	Read Level	Limit Level	Over Limit	Remark
	MHz	dB	dB/m	dB	dBuV	dBuV/m	dBuV/m	dB
1	5423.779	8.05	34.54	42.34	49.91	50.16	54.00	-3.84 Average
2	5530.000	8.19	34.63	42.36	86.34	86.80	-----	----- Average



Test Mode: 04; Polarity: Vertical; Modulation:802.11ac; Bandwidth:80MHz; Channel:Low

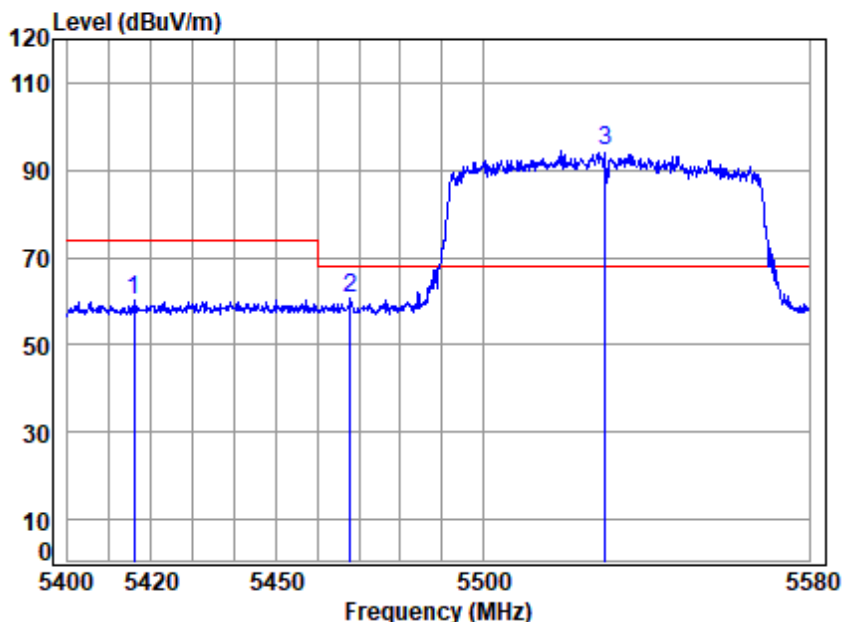

Site : chamber
 Condition: 3m VERTICAL
 Job No : 00028CR/00029CR
 Mode : 5530 Band edge
 : 5G WIFI 11AC80

	Freq	Cable Loss	Ant Factor	Preamp Factor	Read Level	Limit Level	Over Limit	Remark
	MHz	dB	dB/m	dB	dBuV	dBuV/m	dBuV/m	dB
1	5415.782	8.04	34.54	42.34	60.08	60.32	74.00	-13.68 Peak
2	5467.885	8.13	34.58	42.35	60.35	60.71	68.20	-7.49 peak
3 *	5530.000	8.19	34.63	42.36	93.95	94.41	68.20	26.21 Peak



Unless otherwise agreed in writing, this document is issued by the Company subject to its General Conditions of Service printed overleaf, available on request or accessible at <http://www.sgs.com/en/Terms-and-Conditions.aspx> and, for electronic format documents, subject to Terms and Conditions for Electronic Documents at <http://www.sgs.com/en/Terms-and-Conditions/Terms-e-Documents.aspx>. Attention is drawn to the limitation of liability, indemnification and jurisdiction issues defined therein. Any holder of this document is advised that information contained hereon reflects the Company's findings at the time of its intervention only and within the limits of Client's instructions, if any. The Company's sole responsibility is to its Client and this document does not exonerate parties to a transaction from exercising all their rights and obligations under the transaction documents. This document cannot be reproduced except in full, without prior written approval of the Company. Any unauthorized alteration, forgery or falsification of the content or appearance of this document is unlawful and offenders may be prosecuted to the fullest extent of the law. Unless otherwise stated the results shown in this test report refer only to the sample(s) tested and such sample(s) are retained for 30 days only.
 Attention: To check the authenticity of testing / inspection report & certificate, please contact us at telephone: (86-755) 8307 1443, or email: CN.Doccheck@sgs.com

Test Mode: 04; Polarity: Vertical; Modulation:802.11ac; Bandwidth:80MHz; Channel:Low

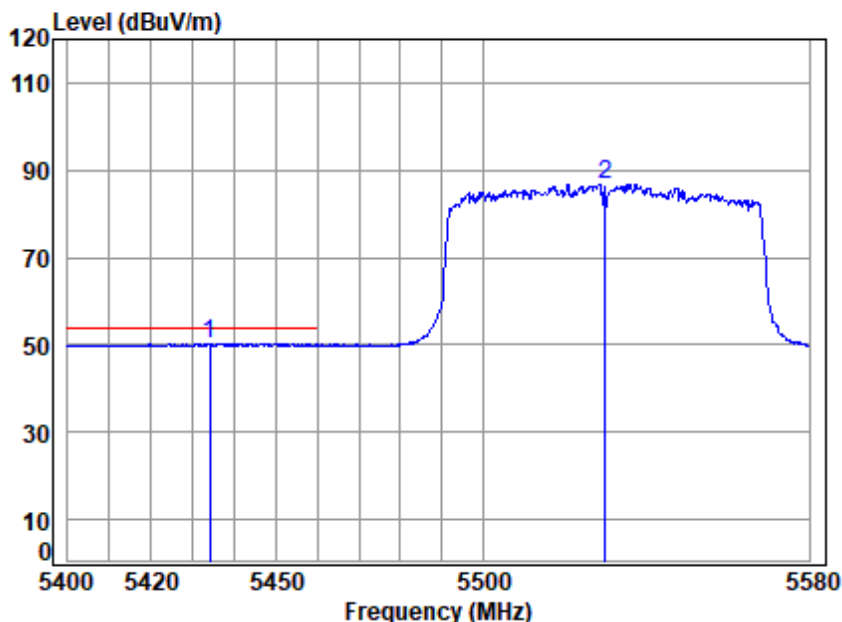

Site : chamber
 Condition: 3m VERTICAL
 Job No : 00028CR/00029CR
 Mode : 5530 Band edge
 : 5G WIFI 11AC80

	Cable	Ant	Preamp	Read	Limit	Over		
Freq	Loss	Factor	Factor	Level	Level	Line	Limit	Remark
MHz	dB	dB/m	dB	dBuV	dBuV/m	dBuV/m	dB	
1	5434.104	8.07	34.55	42.35	49.88	50.15	54.00	-3.85 Average
2	5530.000	8.19	34.63	42.36	86.44	86.90	-----	----- Average



Unless otherwise agreed in writing, this document is issued by the Company subject to its General Conditions of Service printed overleaf, available on request or accessible at <http://www.sgs.com/en/Terms-and-Conditions.aspx> and, for electronic format documents, subject to Terms and Conditions for Electronic Documents at <http://www.sgs.com/en/Terms-and-Conditions/Terms-e-Documents.aspx>. Attention is drawn to the limitation of liability, indemnification and jurisdiction issues defined therein. Any holder of this document is advised that information contained hereon reflects the Company's findings at the time of its intervention only and within the limits of Client's instructions, if any. The Company's sole responsibility is to its Client and this document does not exonerate parties to a transaction from exercising all their rights and obligations under the transaction documents. This document cannot be reproduced except in full, without prior written approval of the Company. Any unauthorized alteration, forgery or falsification of the content or appearance of this document is unlawful and offenders may be prosecuted to the fullest extent of the law. Unless otherwise stated the results shown in this test report refer only to the sample(s) tested and such sample(s) are retained for 30 days only.
 Attention: To check the authenticity of testing / inspection report & certificate, please contact us at telephone: (86-755) 8307 1443, or email: CN.Doccheck@sgs.com

Test Mode: 04; Polarity: Horizontal; Modulation:802.11ac; Bandwidth:80MHz; Channel:High

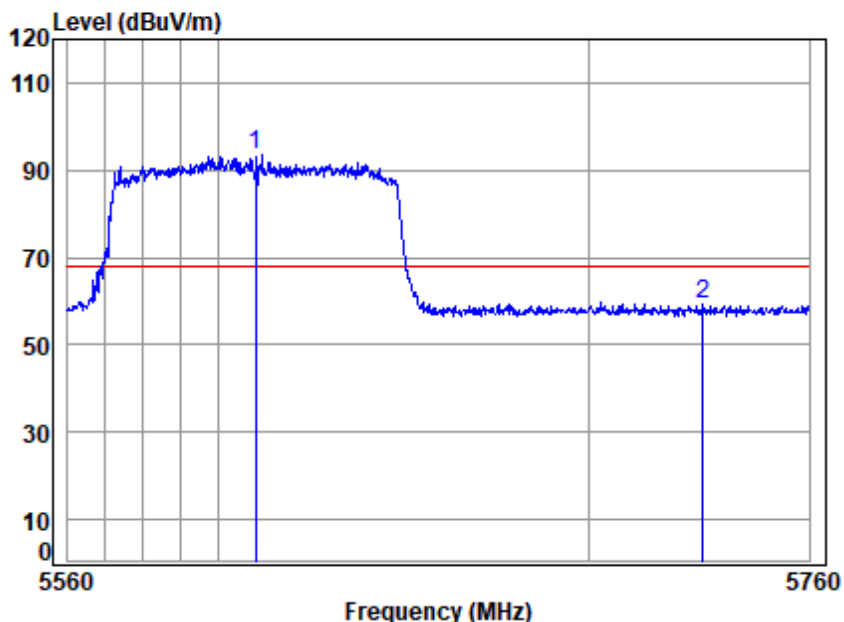

Site : chamber
 Condition: 3m HORIZONTAL
 Job No : 00028CR/00029CR
 Mode : 5610 Band edge
 : 5G WIFI 11AC80

	Cable	Ant	Preamp	Read	Limit	Over	
Freq	Loss	Factor	Factor	Level	Level	Line	Limit Remark
MHz	dB	dB/m	dB	dBuV	dBuV/m	dBuV/m	dB
1 * 5610.000	8.20	34.71	42.36	92.90	93.45	68.20	25.25 peak
2 5730.965	8.22	34.84	42.37	58.43	59.12	68.20	-9.08 peak



Unless otherwise agreed in writing, this document is issued by the Company subject to its General Conditions of Service printed overleaf, available on request or accessible at <http://www.sgs.com/en/Terms-and-Conditions.aspx> and, for electronic format documents, subject to Terms and Conditions for Electronic Documents at <http://www.sgs.com/en/Terms-and-Conditions/Terms-e-Documents.aspx>. Attention is drawn to the limitation of liability, indemnification and jurisdiction issues defined therein. Any holder of this document is advised that information contained hereon reflects the Company's findings at the time of its intervention only and within the limits of Client's instructions, if any. The Company's sole responsibility is to its Client and this document does not exonerate parties to a transaction from exercising all their rights and obligations under the transaction documents. This document cannot be reproduced except in full, without prior written approval of the Company. Any unauthorized alteration, forgery or falsification of the content or appearance of this document is unlawful and offenders may be prosecuted to the fullest extent of the law. Unless otherwise stated the results shown in this test report refer only to the sample(s) tested and such sample(s) are retained for 30 days only.
 Attention: To check the authenticity of testing / inspection report & certificate, please contact us at telephone: (86-755) 8307 1443, or email: CN.Doccheck@sgs.com

Test Mode: 04; Polarity: Vertical; Modulation:802.11ac; Bandwidth:80MHz; Channel:High

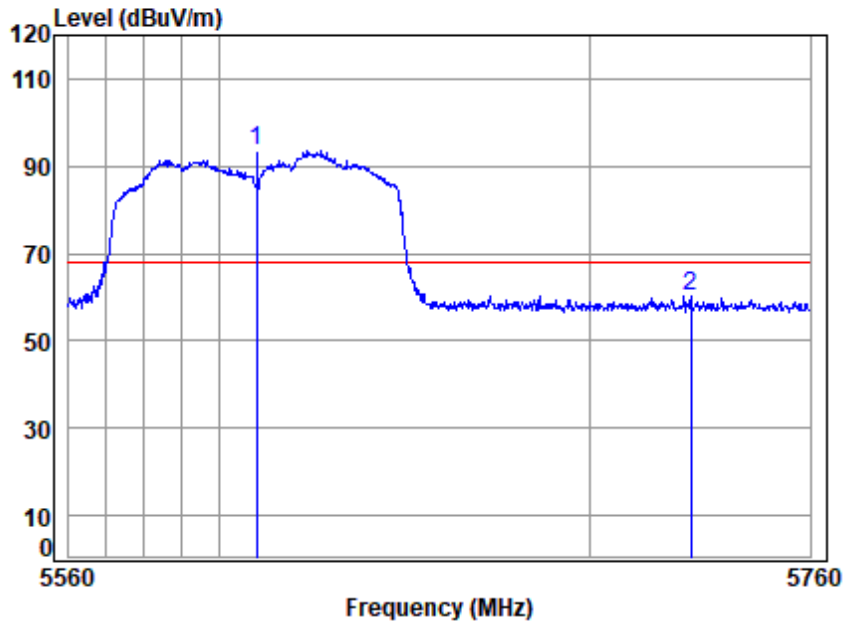

Site : chamber
 Condition: 3m VERTICAL
 Job No : 00028CR/00029CR
 Mode : 5610 Band edge
 : 5G WIFI 11AC80

Freq	Cable Loss	Ant Factor	Preamp Factor	Read Level	Limit Level	Over Limit	Remark
MHz	dB	dB/m	dB	dBuV	dBuV/m	dBuV/m	dB
1 * 5610.000	8.20	34.71	42.36	92.88	68.20	25.23	Peak
2 5727.321	8.22	34.83	42.37	59.43	68.20	-8.09	Peak



Unless otherwise agreed in writing, this document is issued by the Company subject to its General Conditions of Service printed overleaf, available on request or accessible at <http://www.sgs.com/en/Terms-and-Conditions.aspx> and, for electronic format documents, subject to Terms and Conditions for Electronic Documents at <http://www.sgs.com/en/Terms-and-Conditions/Terms-e-Documents.aspx>. Attention is drawn to the limitation of liability, indemnification and jurisdiction issues defined therein. Any holder of this document is advised that information contained hereon reflects the Company's findings at the time of its intervention only and within the limits of Client's instructions, if any. The Company's sole responsibility is to its Client and this document does not exonerate parties to a transaction from exercising all their rights and obligations under the transaction documents. This document cannot be reproduced except in full, without prior written approval of the Company. Any unauthorized alteration, forgery or falsification of the content or appearance of this document is unlawful and offenders may be prosecuted to the fullest extent of the law. Unless otherwise stated the results shown in this test report refer only to the sample(s) tested and such sample(s) are retained for 30 days only.
 Attention: To check the authenticity of testing / inspection report & certificate, please contact us at telephone: (86-755) 8307 1443, or email: CN.Doccheck@sgs.com

Test Mode: 05; Polarity: Horizontal; Modulation:802.11a; Bandwidth:20MHz; Channel:Low

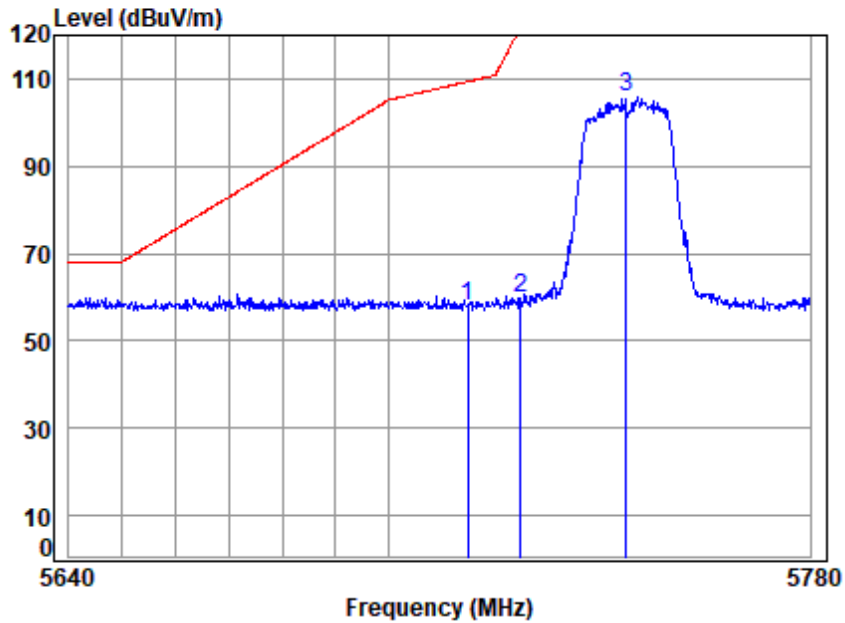

Site : chamber
 Condition: 3m HORIZONTAL
 Job No : 00028CR/00029CR
 Mode : 5745 Band edge
 : 5G WIFI 11A

	Freq	Cable Loss	Ant Factor	Preamp Factor	Read Level	Limit Level	Limit Line	Over Limit	Remark
	MHz	dB	dB/m	dB	dBuV	dBuV/m	dBuV/m	dB	
1	5715.000	8.22	34.82	42.37	57.07	57.74	109.40	-51.66	peak
2	5725.000	8.22	34.83	42.37	59.12	59.80	122.20	-62.40	peak
3	5745.000	8.22	34.85	42.38	105.22	105.91	-----	-----	peak



Unless otherwise agreed in writing, this document is issued by the Company subject to its General Conditions of Service printed overleaf, available on request or accessible at <http://www.sgs.com/en/Terms-and-Conditions.aspx> and, for electronic format documents, subject to Terms and Conditions for Electronic Documents at <http://www.sgs.com/en/Terms-and-Conditions/Terms-e-Documents.aspx>. Attention is drawn to the limitation of liability, indemnification and jurisdiction issues defined therein. Any holder of this document is advised that information contained hereon reflects the Company's findings at the time of its intervention only and within the limits of Client's instructions, if any. The Company's sole responsibility is to its Client and this document does not exonerate parties to a transaction from exercising all their rights and obligations under the transaction documents. This document cannot be reproduced except in full, without prior written approval of the Company. Any unauthorized alteration, forgery or falsification of the content or appearance of this document is unlawful and offenders may be prosecuted to the fullest extent of the law. Unless otherwise stated the results shown in this test report refer only to the sample(s) tested and such sample(s) are retained for 30 days only.
 Attention: To check the authenticity of testing / inspection report & certificate, please contact us at telephone: (86-755) 8307 1443, or email: CN.Doccheck@sgs.com

Test Mode: 05; Polarity: Vertical; Modulation:802.11a; Bandwidth:20MHz; Channel:Low

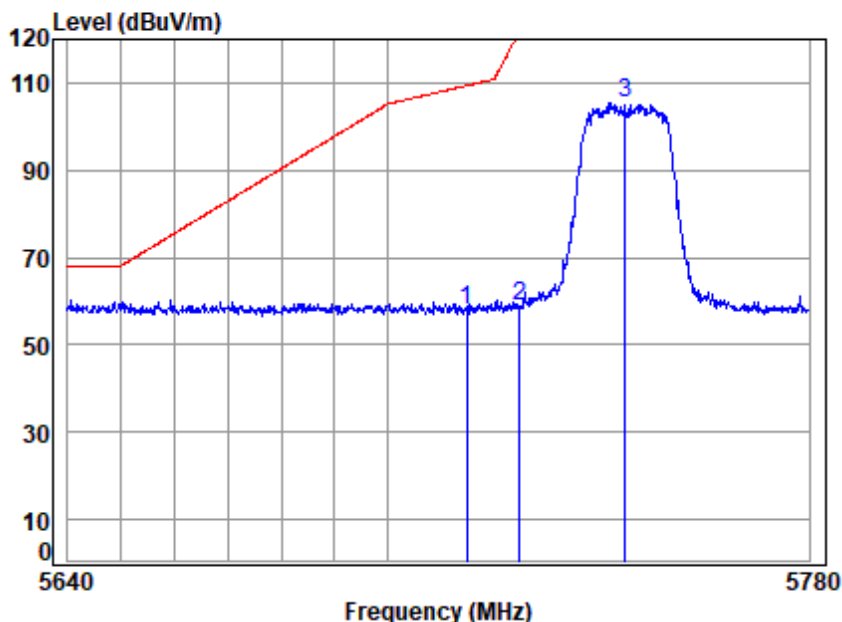

Site : chamber
 Condition: 3m VERTICAL
 Job No : 00028CR/00029CR
 Mode : 5745 Band edge
 : 5G WIFI 11A

	Freq	Cable Loss	Ant Factor	Preamp Factor	Read Level	Limit Level	Over Limit	Remark
	MHz	dB	dB/m	dB	dBuV	dBuV/m	dBuV/m	dB
1	5715.000	8.22	34.82	42.37	57.09	57.76	109.40	-51.64 peak
2	5725.000	8.22	34.83	42.37	58.19	58.87	122.20	-63.33 peak
3	5745.000	8.22	34.85	42.38	104.59	105.28	-----	----- peak



Unless otherwise agreed in writing, this document is issued by the Company subject to its General Conditions of Service printed overleaf, available on request or accessible at <http://www.sgs.com/en/Terms-and-Conditions.aspx> and, for electronic format documents, subject to Terms and Conditions for Electronic Documents at <http://www.sgs.com/en/Terms-and-Conditions/Terms-e-Documents.aspx>. Attention is drawn to the limitation of liability, indemnification and jurisdiction issues defined therein. Any holder of this document is advised that information contained hereon reflects the Company's findings at the time of its intervention only and within the limits of Client's instructions, if any. The Company's sole responsibility is to its Client and this document does not exonerate parties to a transaction from exercising all their rights and obligations under the transaction documents. This document cannot be reproduced except in full, without prior written approval of the Company. Any unauthorized alteration, forgery or falsification of the content or appearance of this document is unlawful and offenders may be prosecuted to the fullest extent of the law. Unless otherwise stated the results shown in this test report refer only to the sample(s) tested and such sample(s) are retained for 30 days only.
 Attention: To check the authenticity of testing / inspection report & certificate, please contact us at telephone: (86-755) 8307 1443, or email: CN.Doccheck@sgs.com

Test Mode: 05; Polarity: Horizontal; Modulation:802.11a; Bandwidth:20MHz; Channel:High

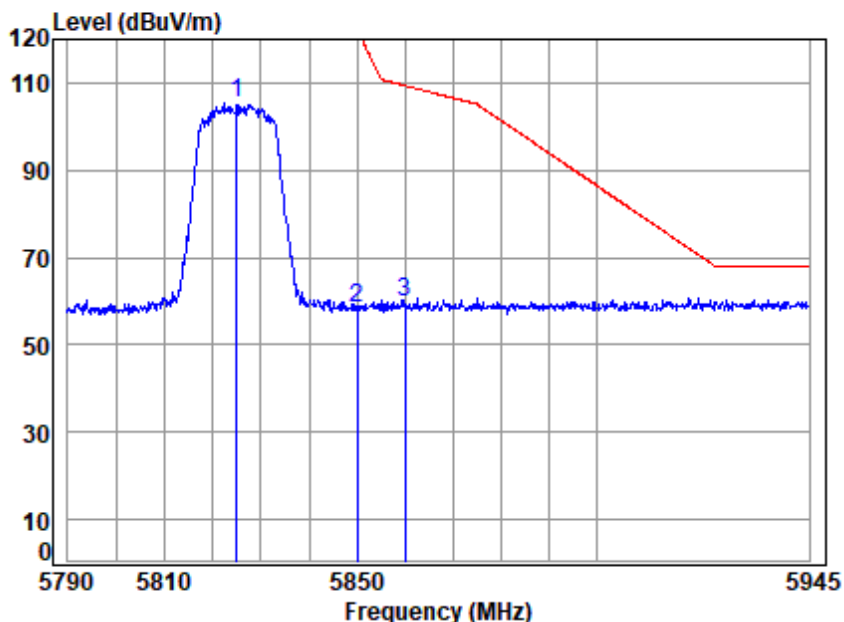

Site : chamber
 Condition: 3m HORIZONTAL
 Job No : 00028CR/00029CR
 Mode : 5825 Band edge
 : 5G WIFI 11A

	Cable	Ant	Preamp	Read	Limit	Over		
Freq	Loss	Factor	Factor	Level	Level	Line	Limit	Remark
MHz	dB	dB/m	dB	dBuV	dBuV/m	dBuV/m	dB	
1 5825.000	8.23	34.93	42.38	104.55	105.33	-----	-----	peak
2 5850.000	8.24	34.95	42.39	57.64	58.44	122.20	-63.76	peak
3 5860.000	8.24	34.96	42.39	58.87	59.68	109.40	-49.72	peak



Unless otherwise agreed in writing, this document is issued by the Company subject to its General Conditions of Service printed overleaf, available on request or accessible at <http://www.sgs.com/en/Terms-and-Conditions.aspx> and, for electronic format documents, subject to Terms and Conditions for Electronic Documents at <http://www.sgs.com/en/Terms-and-Conditions/Terms-e-Documents.aspx>. Attention is drawn to the limitation of liability, indemnification and jurisdiction issues defined therein. Any holder of this document is advised that information contained hereon reflects the Company's findings at the time of its intervention only and within the limits of Client's instructions, if any. The Company's sole responsibility is to its Client and this document does not exonerate parties to a transaction from exercising all their rights and obligations under the transaction documents. This document cannot be reproduced except in full, without prior written approval of the Company. Any unauthorized alteration, forgery or falsification of the content or appearance of this document is unlawful and offenders may be prosecuted to the fullest extent of the law. Unless otherwise stated the results shown in this test report refer only to the sample(s) tested and such sample(s) are retained for 30 days only.
 Attention: To check the authenticity of testing / inspection report & certificate, please contact us at telephone: (86-755) 8307 1443, or email: CN.Doccheck@sgs.com

Test Mode: 05; Polarity: Vertical; Modulation:802.11a; Bandwidth:20MHz; Channel:High

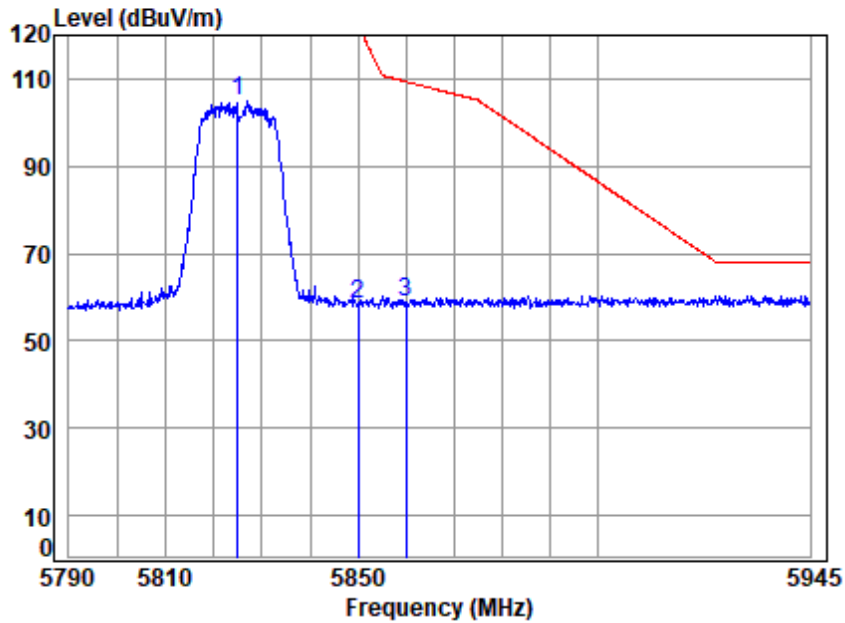

Site : chamber
 Condition: 3m VERTICAL
 Job No : 00028CR/00029CR
 Mode : 5825 Band edge
 : 5G WIFI 11A

	Freq	Cable Loss	Ant Factor	Preamp Factor	Read Level	Limit Level	Limit Line	Over Limit	Remark
	MHz	dB	dB/m	dB	dBuV	dBuV/m	dBuV/m	dB	
1	5825.000	8.23	34.93	42.38	104.01	104.79	-----	-----	peak
2	5850.000	8.24	34.95	42.39	57.45	58.25	122.20	-63.95	peak
3	5860.000	8.24	34.96	42.39	57.97	58.78	109.40	-50.62	peak



Test Mode: 05; Polarity: Horizontal; Modulation:802.11n; Bandwidth:20MHz; Channel:Low

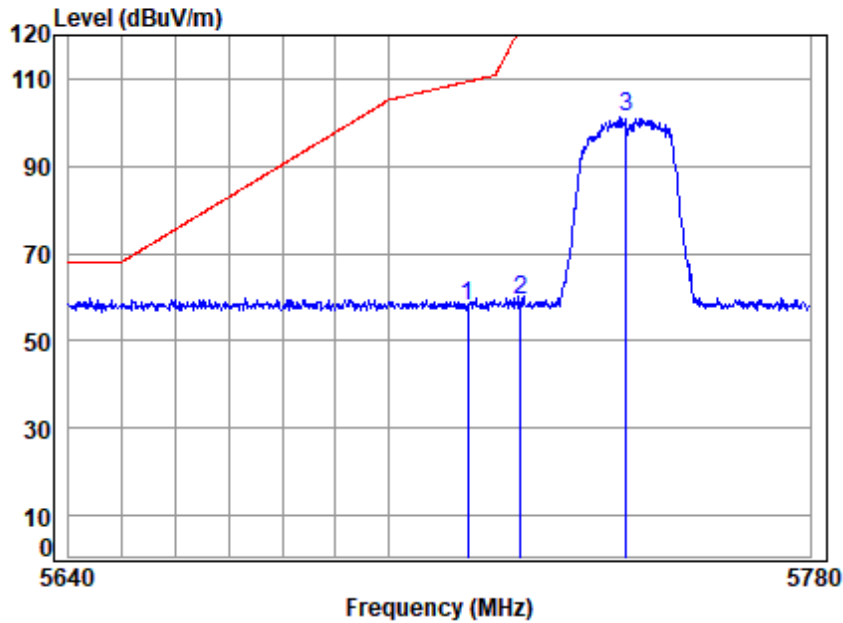

Site : chamber
 Condition: 3m HORIZONTAL
 Job No : 00028CR/00029CR
 Mode : 5745 Band edge
 : 5G WIFI 11N20

	Cable	Ant	Preamp	Read	Limit	Over			
Freq	Loss	Factor	Factor	Level	Level	Line	Limit		
MHz	dB	dB/m	dB	dBuV	dBuV/m	dBuV/m	dB		
1	5715.000	8.22	34.82	42.37	57.34	58.01	109.40	-51.39	peak
2	5725.000	8.22	34.83	42.37	58.61	59.29	122.20	-62.91	peak
3	5745.000	8.22	34.85	42.38	100.70	101.39	-----	-----	peak



Unless otherwise agreed in writing, this document is issued by the Company subject to its General Conditions of Service printed overleaf, available on request or accessible at <http://www.sgs.com/en/Terms-and-Conditions.aspx> and, for electronic format documents, subject to Terms and Conditions for Electronic Documents at <http://www.sgs.com/en/Terms-and-Conditions/Terms-e-Documents.aspx>. Attention is drawn to the limitation of liability, indemnification and jurisdiction issues defined therein. Any holder of this document is advised that information contained hereon reflects the Company's findings at the time of its intervention only and within the limits of Client's instructions, if any. The Company's sole responsibility is to its Client and this document does not exonerate parties to a transaction from exercising all their rights and obligations under the transaction documents. This document cannot be reproduced except in full, without prior written approval of the Company. Any unauthorized alteration, forgery or falsification of the content or appearance of this document is unlawful and offenders may be prosecuted to the fullest extent of the law. Unless otherwise stated the results shown in this test report refer only to the sample(s) tested and such sample(s) are retained for 30 days only.
 Attention: To check the authenticity of testing / inspection report & certificate, please contact us at telephone: (86-755) 8307 1443, or email: CN.Doccheck@sgs.com

Test Mode: 05; Polarity: Vertical; Modulation:802.11n; Bandwidth:20MHz; Channel:Low

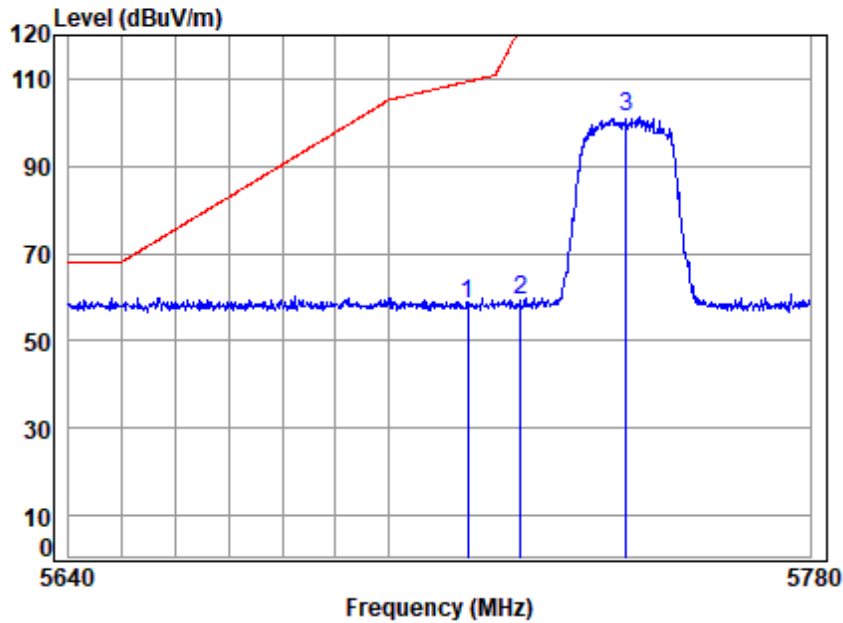

Site : chamber
 Condition: 3m VERTICAL
 Job No : 00028CR/00029CR
 Mode : 5745 Band edge
 : 5G WIFI 11N20

	Cable	Ant	Preamp	Read	Limit	Over	
Freq	Loss	Factor	Factor	Level	Level	Line	Limit Remark
MHz	dB	dB/m	dB	dBuV	dBuV/m	dBuV/m	dB
1 5715.000	8.22	34.82	42.37	57.77	58.44	109.40	-50.96 peak
2 5725.000	8.22	34.83	42.37	58.76	59.44	122.20	-62.76 peak
3 5745.000	8.22	34.85	42.38	100.51	101.20	-----	----- peak



Test Mode: 05; Polarity: Horizontal; Modulation:802.11n; Bandwidth:20MHz; Channel:High

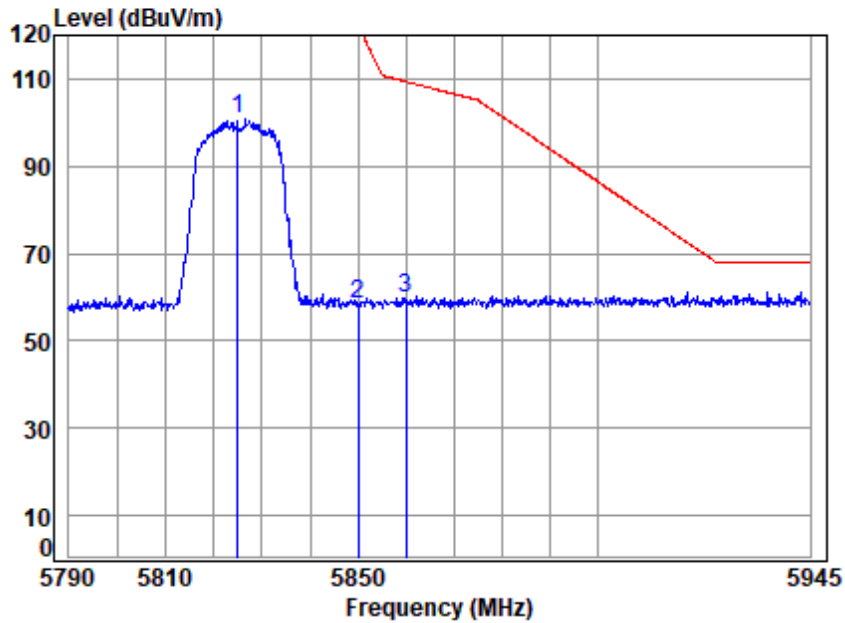

Site : chamber
 Condition: 3m HORIZONTAL
 Job No : 00028CR/00029CR
 Mode : 5825 Band edge
 : 5G WIFI 11N20

	Freq	Cable Loss	Ant Factor	Preamp Factor	Read Level	Limit Level	Limit Line	Over Limit	Remark
	MHz	dB	dB/m	dB	dBuV	dBuV/m	dBuV/m	dB	
1	5825.000	8.23	34.93	42.38	100.01	100.79	-----	-----	peak
2	5850.000	8.24	34.95	42.39	57.68	58.48	122.20	-63.72	peak
3	5860.000	8.24	34.96	42.39	59.00	59.81	109.40	-49.59	peak



Test Mode: 05; Polarity: Vertical; Modulation:802.11n; Bandwidth:20MHz; Channel:High

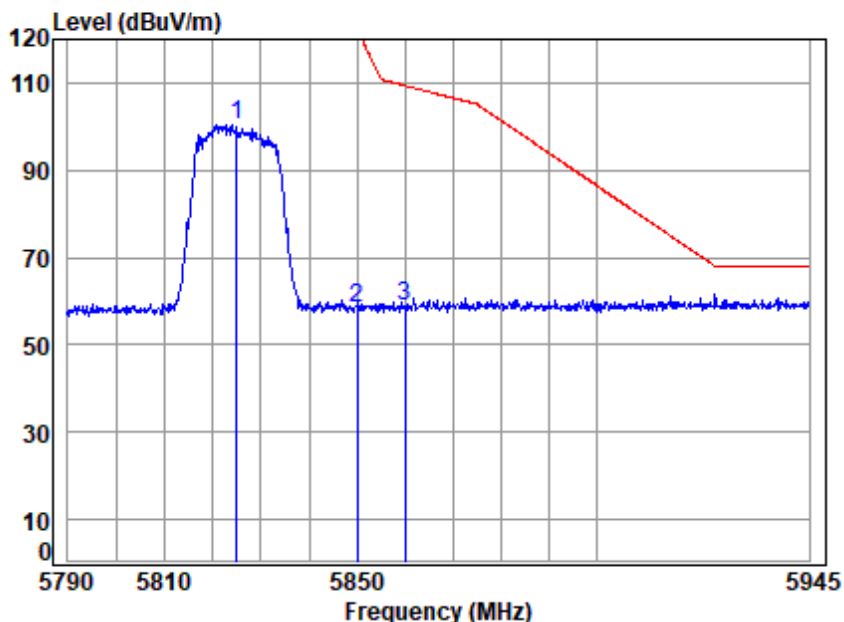

Site : chamber
 Condition: 3m VERTICAL
 Job No : 00028CR/00029CR
 Mode : 5825 Band edge
 : 5G WIFI 11N20

	Cable	Ant	Preamp	Read	Limit	Over	
Freq	Loss	Factor	Factor	Level	Level	Line	Limit
MHz	dB	dB/m	dB	dBuV	dBuV/m	dBuV/m	dB
1 5825.000	8.23	34.93	42.38	99.56	100.34	-----	----- peak
2 5850.000	8.24	34.95	42.39	57.38	58.18	122.20	-64.02 peak
3 5860.000	8.24	34.96	42.39	58.14	58.95	109.40	-50.45 peak



Unless otherwise agreed in writing, this document is issued by the Company subject to its General Conditions of Service printed overleaf, available on request or accessible at <http://www.sgs.com/en/Terms-and-Conditions.aspx> and, for electronic format documents, subject to Terms and Conditions for Electronic Documents at <http://www.sgs.com/en/Terms-and-Conditions/Terms-e-Documents.aspx>. Attention is drawn to the limitation of liability, indemnification and jurisdiction issues defined therein. Any holder of this document is advised that information contained hereon reflects the Company's findings at the time of its intervention only and within the limits of Client's instructions, if any. The Company's sole responsibility is to its Client and this document does not exonerate parties to a transaction from exercising all their rights and obligations under the transaction documents. This document cannot be reproduced except in full, without prior written approval of the Company. Any unauthorized alteration, forgery or falsification of the content or appearance of this document is unlawful and offenders may be prosecuted to the fullest extent of the law. Unless otherwise stated the results shown in this test report refer only to the sample(s) tested and such sample(s) are retained for 30 days only.
 Attention: To check the authenticity of testing / inspection report & certificate, please contact us at telephone: (86-755) 8307 1443, or email: CN.Doccheck@sgs.com

Test Mode: 05; Polarity: Horizontal; Modulation:802.11n; Bandwidth:40MHz; Channel:Low

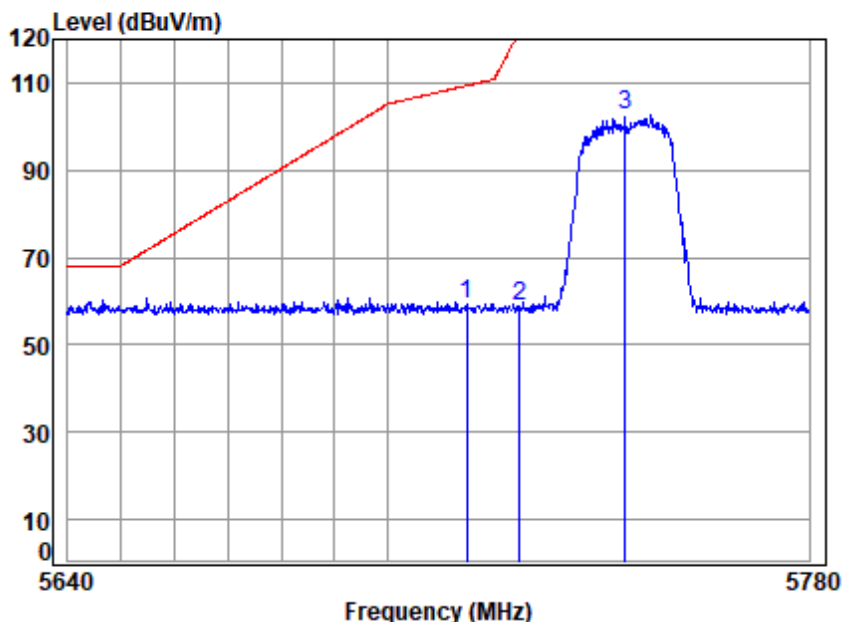

Site : chamber
 Condition: 3m HORIZONTAL
 Job No : 00028CR/00029CR
 Mode : 5745 Band edge
 : 5G WIFI 11AC20

	Cable	Ant	Preamp	Read	Limit	Over			
Freq	Loss	Factor	Factor	Level	Level	Line	Limit		
MHz	dB	dB/m	dB	dBuV	dBuV/m	dBuV/m	dB		
1	5715.000	8.22	34.82	42.37	58.54	59.21	109.40	-50.19	peak
2	5725.000	8.22	34.83	42.37	58.02	58.70	122.20	-63.50	peak
3	5745.000	8.22	34.85	42.38	101.83	102.52	-----	-----	peak



Unless otherwise agreed in writing, this document is issued by the Company subject to its General Conditions of Service printed overleaf, available on request or accessible at <http://www.sgs.com/en/Terms-and-Conditions.aspx> and, for electronic format documents, subject to Terms and Conditions for Electronic Documents at <http://www.sgs.com/en/Terms-and-Conditions/Terms-e-Documents.aspx>. Attention is drawn to the limitation of liability, indemnification and jurisdiction issues defined therein. Any holder of this document is advised that information contained hereon reflects the Company's findings at the time of its intervention only and within the limits of Client's instructions, if any. The Company's sole responsibility is to its Client and this document does not exonerate parties to a transaction from exercising all their rights and obligations under the transaction documents. This document cannot be reproduced except in full, without prior written approval of the Company. Any unauthorized alteration, forgery or falsification of the content or appearance of this document is unlawful and offenders may be prosecuted to the fullest extent of the law. Unless otherwise stated the results shown in this test report refer only to the sample(s) tested and such sample(s) are retained for 30 days only.
 Attention: To check the authenticity of testing / inspection report & certificate, please contact us at telephone: (86-755) 8307 1443, or email: CN.Doccheck@sgs.com

Test Mode: 05; Polarity: Vertical; Modulation:802.11n; Bandwidth:40MHz; Channel:Low

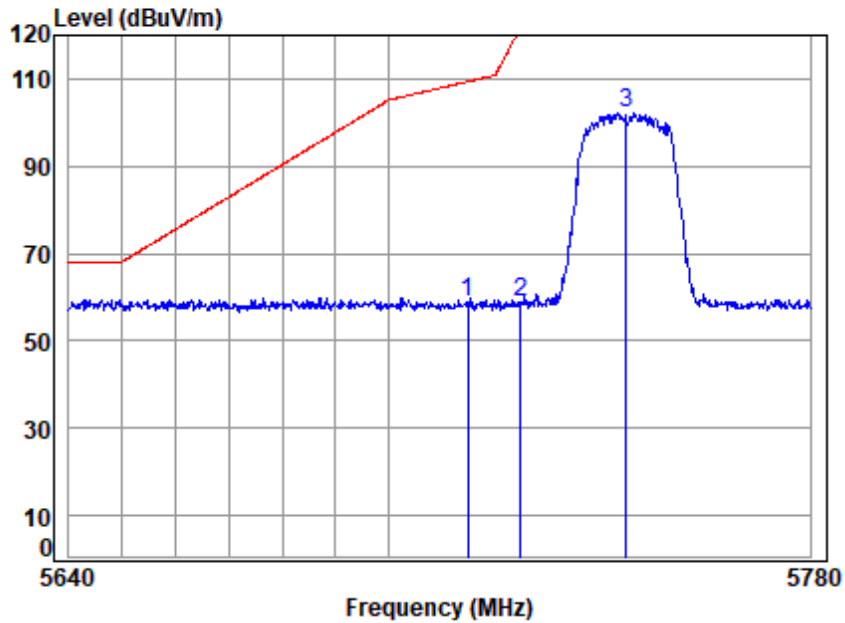

Site : chamber
 Condition: 3m VERTICAL
 Job No : 00028CR/00029CR
 Mode : 5745 Band edge
 : 5G WIFI 11AC20

	Freq	Cable Loss	Ant Factor	Preamp Factor	Read Level	Limit Level	Limit Line	Over Limit	Remark
	MHz	dB	dB/m	dB	dBuV	dBuV/m	dBuV/m	dB	
1	5715.000	8.22	34.82	42.37	58.26	58.93	109.40	-50.47	peak
2	5725.000	8.22	34.83	42.37	58.40	59.08	122.20	-63.12	peak
3	5745.000	8.22	34.85	42.38	101.52	102.21	-----	-----	peak



Test Mode: 05; Polarity: Horizontal; Modulation:802.11n; Bandwidth:40MHz; Channel:High

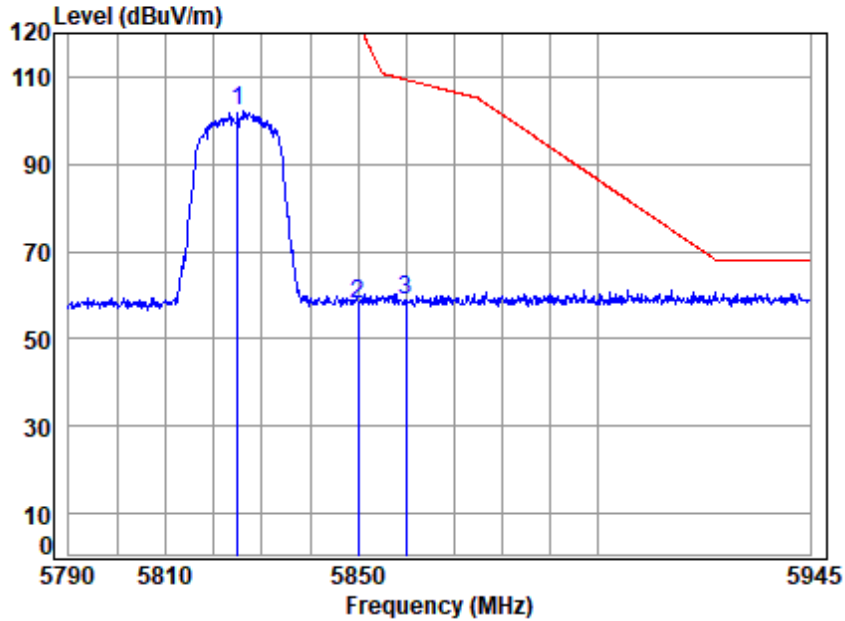

Site : chamber
 Condition: 3m HORIZONTAL
 Job No : 00028CR/00029CR
 Mode : 5825 Band edge
 : 5G WIFI 11AC20

	Cable	Ant	Preamp	Read	Limit	Over		
Freq	Loss	Factor	Factor	Level	Level	Line	Limit	Remark
MHz	dB	dB/m	dB	dBuV	dBuV/m	dBuV/m	dB	
1 5825.000	8.23	34.93	42.38	101.25	102.03	-----	-----	peak
2 5850.000	8.24	34.95	42.39	57.18	57.98	122.20	-64.22	peak
3 5860.000	8.24	34.96	42.39	58.07	58.88	109.40	-50.52	peak



Test Mode: 05; Polarity: Vertical; Modulation:802.11n; Bandwidth:40MHz; Channel:High

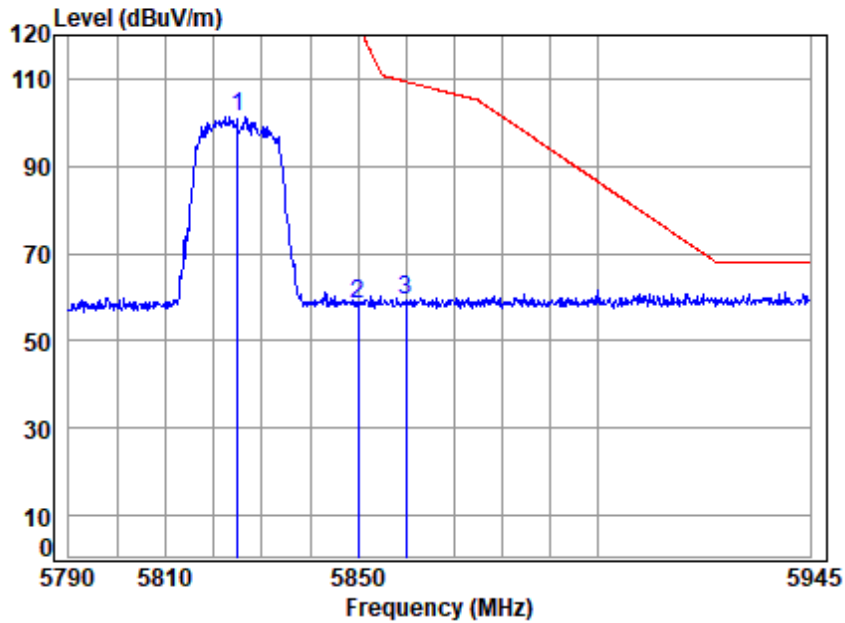

Site : chamber
 Condition: 3m VERTICAL
 Job No : 00028CR/00029CR
 Mode : 5825 Band edge
 : 5G WIFI 11AC20

	Freq	Cable Loss	Ant Factor	Preamp Factor	Read Level	Limit Level	Limit Line	Over Limit	Remark
	MHz	dB	dB/m	dB	dBuV	dBuV/m	dBuV/m	dB	
1	5825.000	8.23	34.93	42.38	100.69	101.47	-----	-----	peak
2	5850.000	8.24	34.95	42.39	57.72	58.52	122.20	-63.68	peak
3	5860.000	8.24	34.96	42.39	58.73	59.54	109.40	-49.86	peak



Unless otherwise agreed in writing, this document is issued by the Company subject to its General Conditions of Service printed overleaf, available on request or accessible at <http://www.sgs.com/en/Terms-and-Conditions.aspx> and, for electronic format documents, subject to Terms and Conditions for Electronic Documents at <http://www.sgs.com/en/Terms-and-Conditions/Terms-e-Documents.aspx>. Attention is drawn to the limitation of liability, indemnification and jurisdiction issues defined therein. Any holder of this document is advised that information contained hereon reflects the Company's findings at the time of its intervention only and within the limits of Client's instructions, if any. The Company's sole responsibility is to its Client and this document does not exonerate parties to a transaction from exercising all their rights and obligations under the transaction documents. This document cannot be reproduced except in full, without prior written approval of the Company. Any unauthorized alteration, forgery or falsification of the content or appearance of this document is unlawful and offenders may be prosecuted to the fullest extent of the law. Unless otherwise stated the results shown in this test report refer only to the sample(s) tested and such sample(s) are retained for 30 days only.
 Attention: To check the authenticity of testing / inspection report & certificate, please contact us at telephone: (86-755) 8307 1443, or email: CN.Doccheck@sgs.com

Test Mode: 05; Polarity: Horizontal; Modulation:802.11ac; Bandwidth:20MHz; Channel:Low

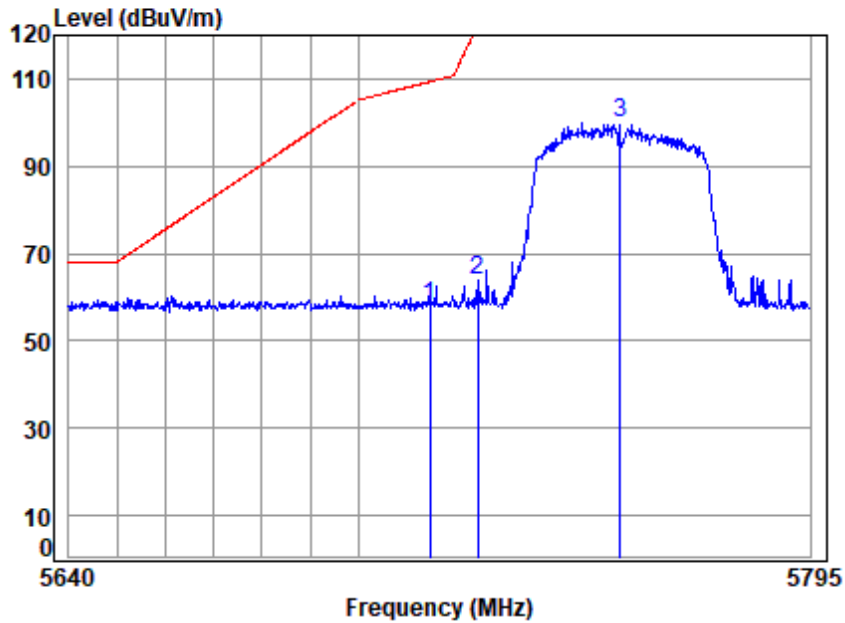

Site : chamber
 Condition: 3m HORIZONTAL
 Job No : 00028CR/00029CR
 Mode : 5755 Band edge
 : 5G WIFI 11N40

	Freq	Cable Loss	Ant Factor	Preamp Factor	Read Level	Limit Level	Over Limit	Remark
	MHz	dB	dB/m	dB	dBuV	dBuV/m	dBuV/m	dB
1	5715.000	8.22	34.82	42.37	57.29	57.96	109.40	-51.44 peak
2	5725.000	8.22	34.83	42.37	63.36	64.04	122.20	-58.16 peak
3	5755.000	8.22	34.86	42.38	99.09	99.79	-----	----- peak



Unless otherwise agreed in writing, this document is issued by the Company subject to its General Conditions of Service printed overleaf, available on request or accessible at <http://www.sgs.com/en/Terms-and-Conditions.aspx> and, for electronic format documents, subject to Terms and Conditions for Electronic Documents at <http://www.sgs.com/en/Terms-and-Conditions/Terms-e-Documents.aspx>. Attention is drawn to the limitation of liability, indemnification and jurisdiction issues defined therein. Any holder of this document is advised that information contained hereon reflects the Company's findings at the time of its intervention only and within the limits of Client's instructions, if any. The Company's sole responsibility is to its Client and this document does not exonerate parties to a transaction from exercising all their rights and obligations under the transaction documents. This document cannot be reproduced except in full, without prior written approval of the Company. Any unauthorized alteration, forgery or falsification of the content or appearance of this document is unlawful and offenders may be prosecuted to the fullest extent of the law. Unless otherwise stated the results shown in this test report refer only to the sample(s) tested and such sample(s) are retained for 30 days only.
 Attention: To check the authenticity of testing / inspection report & certificate, please contact us at telephone: (86-755) 8307 1443, or email: CN.Doccheck@sgs.com

Test Mode: 05; Polarity: Vertical; Modulation:802.11ac; Bandwidth:20MHz; Channel:Low

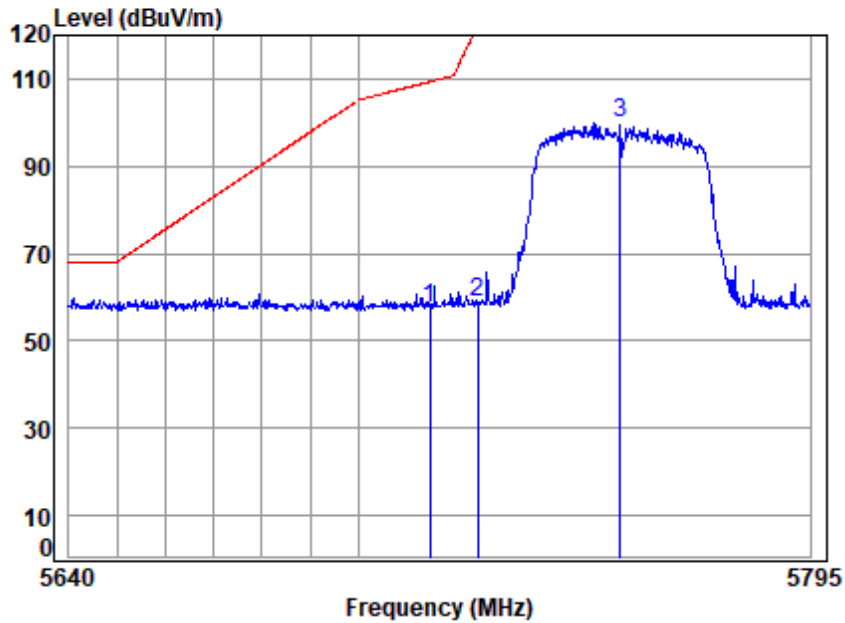

Site : chamber
 Condition: 3m VERTICAL
 Job No : 00028CR/00029CR
 Mode : 5755 Band edge
 : 5G WIFI 11N40

	Freq	Cable Loss	Ant Factor	Preamp Factor	Read Level	Limit Level	Limit Line	Over Limit	Remark
	MHz	dB	dB/m	dB	dBuV	dBuV/m	dBuV/m	dB	
1	5715.000	8.22	34.82	42.37	57.04	57.71	109.40	-51.69	peak
2	5725.000	8.22	34.83	42.37	58.20	58.88	122.20	-63.32	peak
3	5755.000	8.22	34.86	42.38	99.00	99.70	-----	-----	peak



Test Mode: 05; Polarity: Horizontal; Modulation:802.11ac; Bandwidth:20MHz; Channel:High

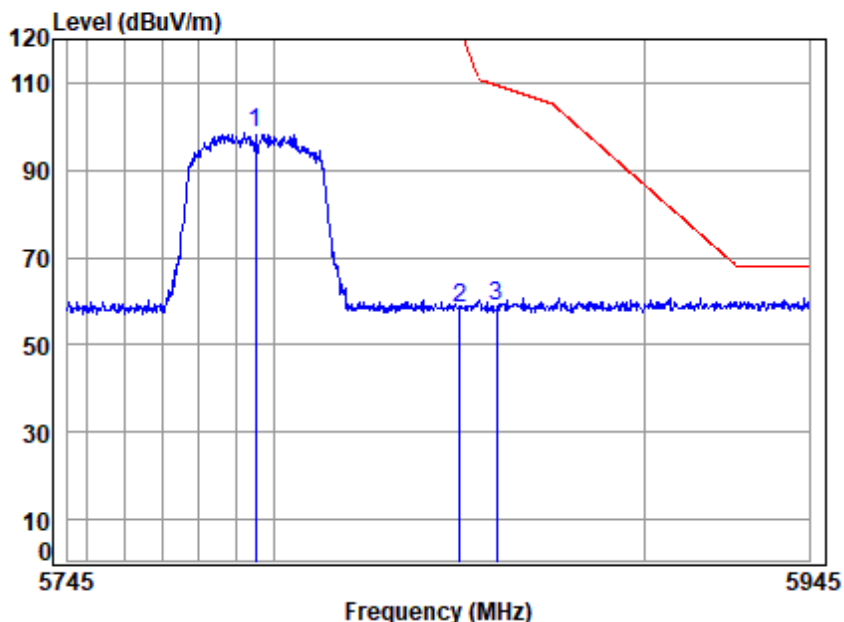

Site : chamber
 Condition: 3m HORIZONTAL
 Job No : 00028CR/00029CR
 Mode : 5795 Band edge
 : 5G WIFI 11N40

	Cable	Ant	Preamp	Read	Limit	Over		
Freq	Loss	Factor	Factor	Level	Level	Line	Limit	Remark
MHz	dB	dB/m	dB	dBuV	dBuV/m	dBuV/m	dB	
1 5795.000	8.23	34.90	42.38	97.69	98.44	-----	-----	peak
2 5850.000	8.24	34.95	42.39	57.68	58.48	122.20	-63.72	peak
3 5860.000	8.24	34.96	42.39	58.20	59.01	109.40	-50.39	peak



Unless otherwise agreed in writing, this document is issued by the Company subject to its General Conditions of Service printed overleaf, available on request or accessible at <http://www.sgs.com/en/Terms-and-Conditions.aspx> and, for electronic format documents, subject to Terms and Conditions for Electronic Documents at <http://www.sgs.com/en/Terms-and-Conditions/Terms-e-Documents.aspx>. Attention is drawn to the limitation of liability, indemnification and jurisdiction issues defined therein. Any holder of this document is advised that information contained hereon reflects the Company's findings at the time of its intervention only and within the limits of Client's instructions, if any. The Company's sole responsibility is to its Client and this document does not exonerate parties to a transaction from exercising all their rights and obligations under the transaction documents. This document cannot be reproduced except in full, without prior written approval of the Company. Any unauthorized alteration, forgery or falsification of the content or appearance of this document is unlawful and offenders may be prosecuted to the fullest extent of the law. Unless otherwise stated the results shown in this test report refer only to the sample(s) tested and such sample(s) are retained for 30 days only.
 Attention: To check the authenticity of testing /inspection report & certificate, please contact us at telephone: (86-755) 8307 1443, or email: CN.Doccheck@sgs.com

Test Mode: 05; Polarity: Vertical; Modulation:802.11ac; Bandwidth:20MHz; Channel:High

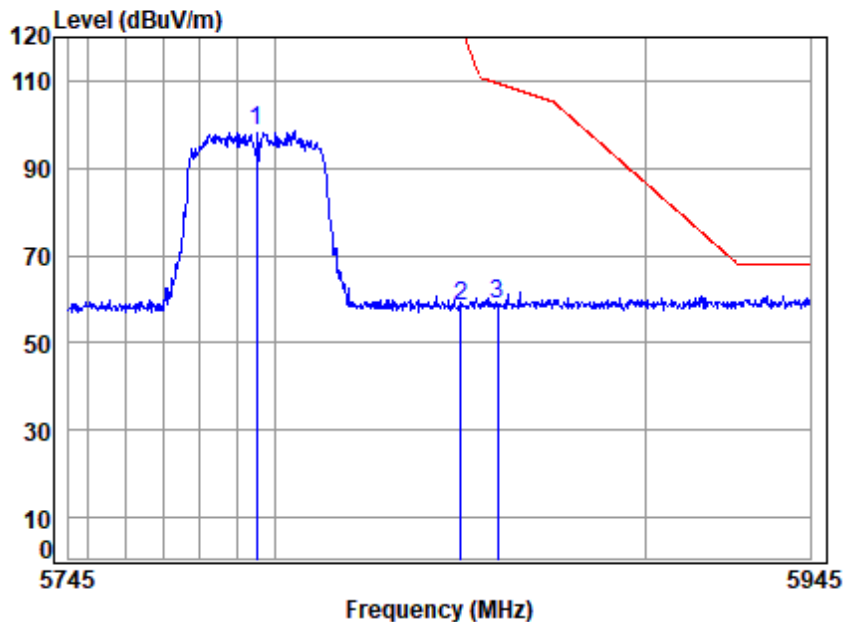

Site : chamber
 Condition: 3m VERTICAL
 Job No : 00028CR/00029CR
 Mode : 5795 Band edge
 : 5G WIFI 11N40

	Freq	Cable Loss	Ant Factor	Preamp Factor	Read Level	Limit Level	Limit Line	Over Limit	Remark
	MHz	dB	dB/m	dB	dBuV	dBuV/m	dBuV/m	dB	
1	5795.000	8.23	34.90	42.38	97.87	98.62	-----	-----	peak
2	5850.000	8.24	34.95	42.39	57.76	58.56	122.20	-63.64	peak
3	5860.000	8.24	34.96	42.39	58.13	58.94	109.40	-50.46	peak



Unless otherwise agreed in writing, this document is issued by the Company subject to its General Conditions of Service printed overleaf, available on request or accessible at <http://www.sgs.com/en/Terms-and-Conditions.aspx> and, for electronic format documents, subject to Terms and Conditions for Electronic Documents at <http://www.sgs.com/en/Terms-and-Conditions/Terms-e-Documents.aspx>. Attention is drawn to the limitation of liability, indemnification and jurisdiction issues defined therein. Any holder of this document is advised that information contained hereon reflects the Company's findings at the time of its intervention only and within the limits of Client's instructions, if any. The Company's sole responsibility is to its Client and this document does not exonerate parties to a transaction from exercising all their rights and obligations under the transaction documents. This document cannot be reproduced except in full, without prior written approval of the Company. Any unauthorized alteration, forgery or falsification of the content or appearance of this document is unlawful and offenders may be prosecuted to the fullest extent of the law. Unless otherwise stated the results shown in this test report refer only to the sample(s) tested and such sample(s) are retained for 30 days only.
 Attention: To check the authenticity of testing / inspection report & certificate, please contact us at telephone: (86-755) 8307 1443, or email: CN.Doccheck@sgs.com

Test Mode: 05; Polarity: Horizontal; Modulation:802.11ac; Bandwidth:40MHz; Channel:Low

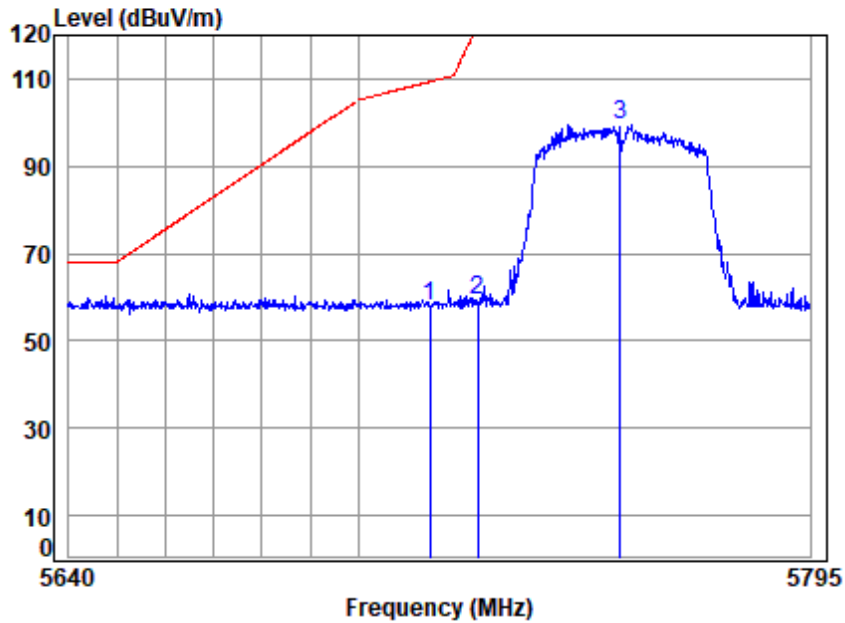

Site : chamber
 Condition: 3m HORIZONTAL
 Job No : 00028CR/00029CR
 Mode : 5755 Band edge
 : 5G WIFI 11AC40

	Cable	Ant	Preamp	Read	Limit	Over			
Freq	Loss	Factor	Factor	Level	Level	Line	Limit		
MHz	dB	dB/m	dB	dBuV	dBuV/m	dBuV/m	dB		
1	5715.000	8.22	34.82	42.37	57.24	57.91	109.40	-51.49	peak
2	5725.000	8.22	34.83	42.37	58.52	59.20	122.20	-63.00	peak
3	5755.000	8.22	34.86	42.38	98.98	99.68	-----	-----	peak



Test Mode: 05; Polarity: Vertical; Modulation:802.11ac; Bandwidth:40MHz; Channel:Low

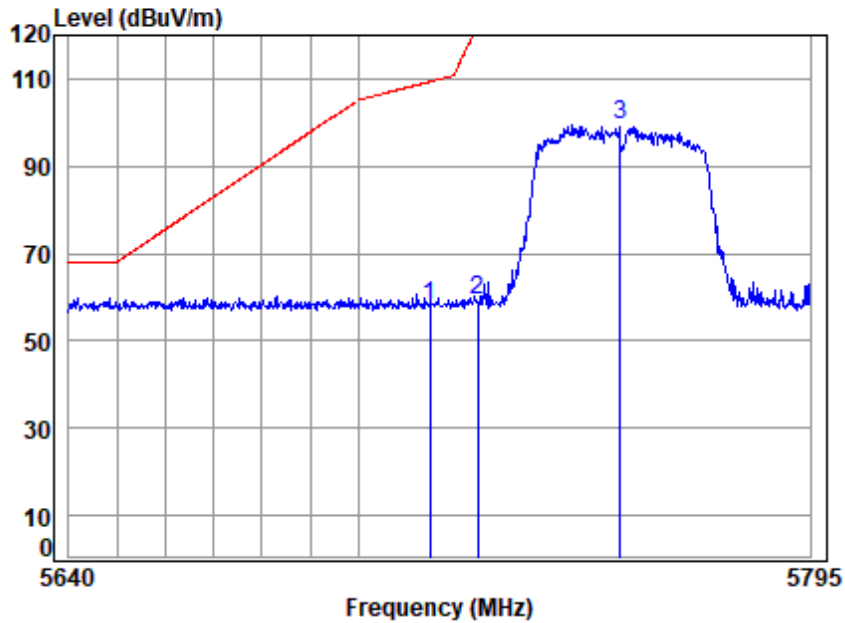

Site : chamber
 Condition: 3m VERTICAL
 Job No : 00028CR/00029CR
 Mode : 5755 Band edge
 : 5G WIFI 11AC40

	Cable	Ant	Preamp	Read	Limit	Over			
Freq	Loss	Factor	Factor	Level	Level	Line	Limit	Remark	
MHz	dB	dB/m	dB	dBuV	dBuV/m	dBuV/m	dB		
1	5715.000	8.22	34.82	42.37	57.18	57.85	109.40	-51.55	peak
2	5725.000	8.22	34.83	42.37	58.57	59.25	122.20	-62.95	peak
3	5755.000	8.22	34.86	42.38	98.73	99.43	-----	-----	peak



Test Mode: 05; Polarity: Horizontal; Modulation:802.11ac; Bandwidth:40MHz; Channel:High

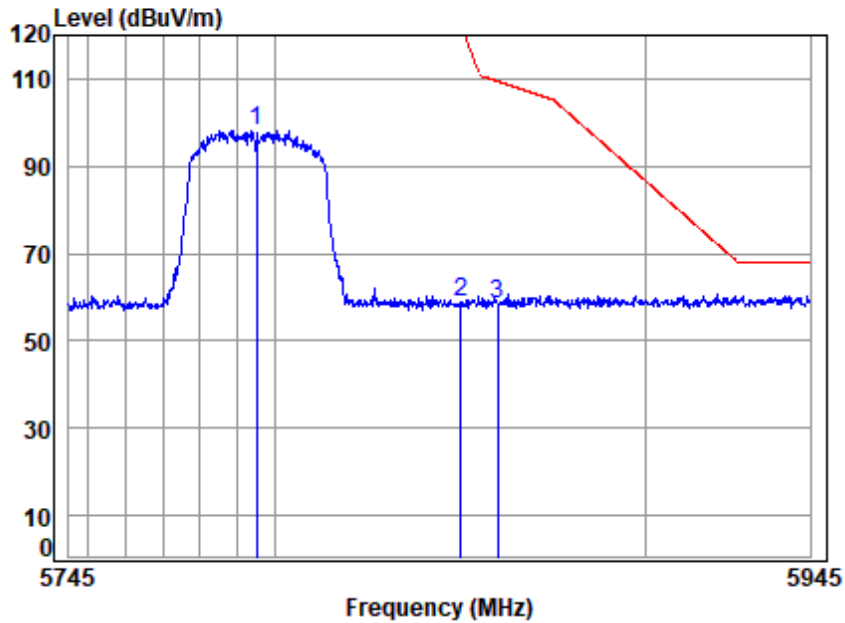

Site : chamber
 Condition: 3m HORIZONTAL
 Job No : 00028CR/00029CR
 Mode : 5795 Band edge
 : 5G WIFI 11AC40

	Cable	Ant	Preamp	Read	Limit	Over		
Freq	Loss	Factor	Factor	Level	Level	Line	Limit	
MHz	dB	dB/m	dB	dBuV	dBuV/m	dBuV/m	dB	
1 5795.000	8.23	34.90	42.38	97.51	98.26	-----	-----	peak
2 5850.000	8.24	34.95	42.39	57.84	58.64	122.20	-63.56	peak
3 5860.000	8.24	34.96	42.39	57.53	58.34	109.40	-51.06	peak



Unless otherwise agreed in writing, this document is issued by the Company subject to its General Conditions of Service printed overleaf, available on request or accessible at <http://www.sgs.com/en/Terms-and-Conditions.aspx> and, for electronic format documents, subject to Terms and Conditions for Electronic Documents at <http://www.sgs.com/en/Terms-and-Conditions/Terms-e-Documents.aspx>. Attention is drawn to the limitation of liability, indemnification and jurisdiction issues defined therein. Any holder of this document is advised that information contained hereon reflects the Company's findings at the time of its intervention only and within the limits of Client's instructions, if any. The Company's sole responsibility is to its Client and this document does not exonerate parties to a transaction from exercising all their rights and obligations under the transaction documents. This document cannot be reproduced except in full, without prior written approval of the Company. Any unauthorized alteration, forgery or falsification of the content or appearance of this document is unlawful and offenders may be prosecuted to the fullest extent of the law. Unless otherwise stated the results shown in this test report refer only to the sample(s) tested and such sample(s) are retained for 30 days only.
 Attention: To check the authenticity of testing / inspection report & certificate, please contact us at telephone: (86-755) 8307 1443, or email: CN.Doccheck@sgs.com

Test Mode: 05; Polarity: Vertical; Modulation:802.11ac; Bandwidth:40MHz; Channel:High

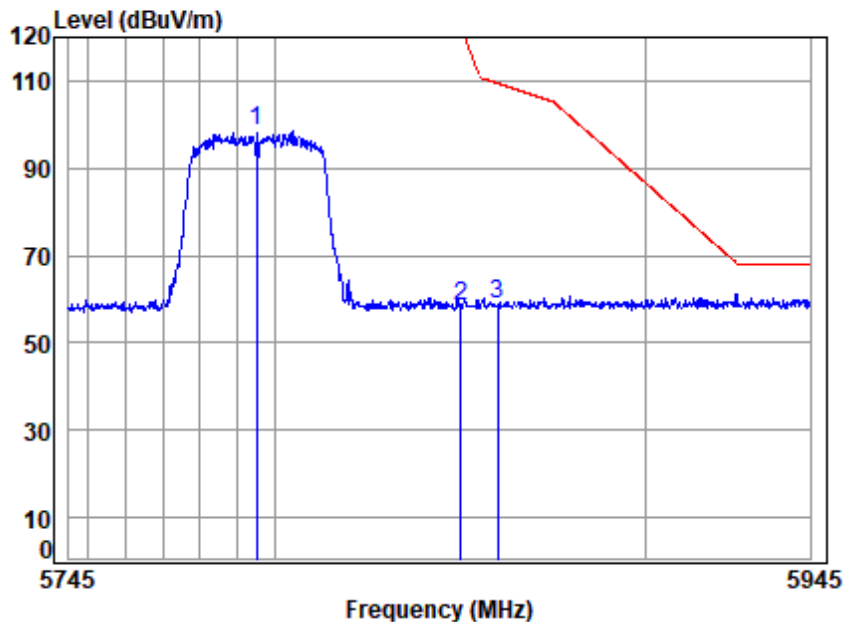

Site : chamber
 Condition: 3m VERTICAL
 Job No : 00028CR/00029CR
 Mode : 5795 Band edge
 : 5G WIFI 11AC40

	Cable	Ant	Preamp	Read	Limit	Over		
Freq	Loss	Factor	Factor	Level	Level	Line	Limit	Remark
MHz	dB	dB/m	dB	dBuV	dBuV/m	dBuV/m	dB	
1 5795.000	8.23	34.90	42.38	98.00	98.75	-----	-----	peak
2 5850.000	8.24	34.95	42.39	57.64	58.44	122.20	-63.76	peak
3 5860.000	8.24	34.96	42.39	58.05	58.86	109.40	-50.54	peak



Test Mode: 05; Polarity: Horizontal; Modulation:802.11ac; Bandwidth:80MHz; Channel:middle

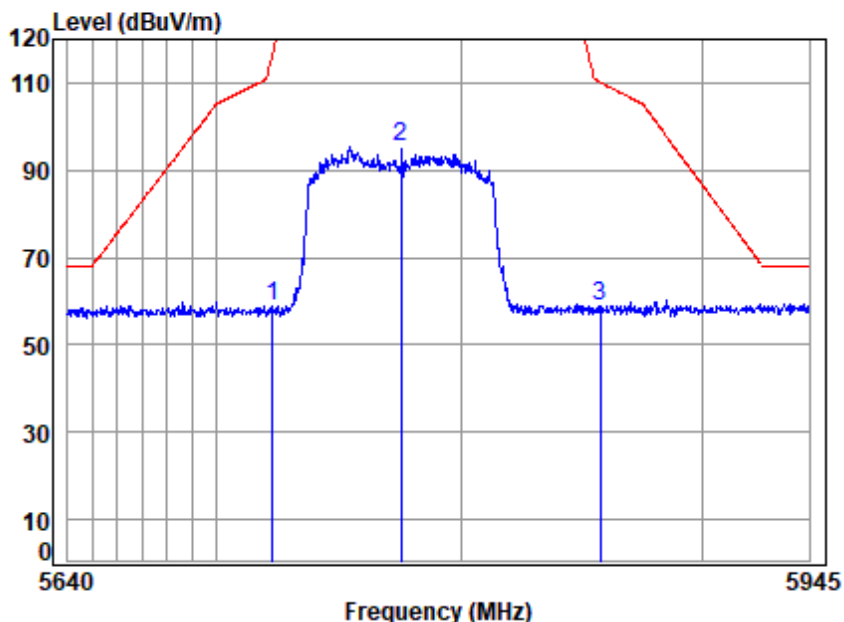

Site : chamber
 Condition: 3m HORIZONTAL
 Job No : 00028CR/00029CR
 Mode : 5775 Band edge
 : 5G WIFI 11AC80

	Freq	Cable Loss	Ant Factor	Preamp Factor	Read Level	Limit Level	Limit Line	Over Limit	Remark
	MHz	dB	dB/m	dB	dBuV	dBuV/m	dBuV/m	dB	
1	5722.582	8.22	34.83	42.37	58.26	58.94	116.69	-57.75	peak
2	5775.000	8.22	34.88	42.38	94.48	95.20	-----	-----	peak
3	5857.357	8.24	34.96	42.39	58.26	59.07	110.14	-51.07	peak



Test Mode: 05; Polarity: Vertical; Modulation:802.11ac; Bandwidth:80MHz; Channel:middle

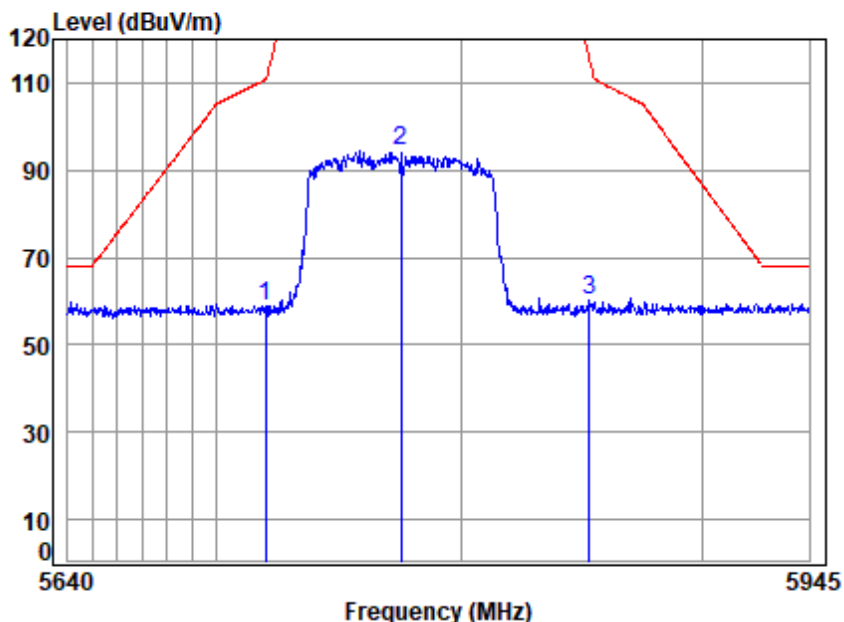

Site : chamber
 Condition: 3m VERTICAL
 Job No : 00028CR/00029CR
 Mode : 5775 Band edge
 : 5G WIFI 11AC80

	Freq	Cable Loss	Ant Factor	Preamp Factor	Read Level	Limit Level	Over Limit	Remark
	MHz	dB	dB/m	dB	dBuV	dBuV/m	dBuV/m	dB
1	5719.870	8.22	34.83	42.37	58.37	59.05	110.76	-51.71 peak
2	5775.000	8.22	34.88	42.38	93.59	94.31	-----	----- peak
3	5852.732	8.24	34.96	42.39	59.37	60.18	115.97	-55.79 peak



Unless otherwise agreed in writing, this document is issued by the Company subject to its General Conditions of Service printed overleaf, available on request or accessible at <http://www.sgs.com/en/Terms-and-Conditions.aspx> and, for electronic format documents, subject to Terms and Conditions for Electronic Documents at <http://www.sgs.com/en/Terms-and-Conditions/Terms-e-Documents.aspx>. Attention is drawn to the limitation of liability, indemnification and jurisdiction issues defined therein. Any holder of this document is advised that information contained hereon reflects the Company's findings at the time of its intervention only and within the limits of Client's instructions, if any. The Company's sole responsibility is to its Client and this document does not exonerate parties to a transaction from exercising all their rights and obligations under the transaction documents. This document cannot be reproduced except in full, without prior written approval of the Company. Any unauthorized alteration, forgery or falsification of the content or appearance of this document is unlawful and offenders may be prosecuted to the fullest extent of the law. Unless otherwise stated the results shown in this test report refer only to the sample(s) tested and such sample(s) are retained for 30 days only.
 Attention: To check the authenticity of testing / inspection report & certificate, please contact us at telephone: (86-755) 8307 1443, or email: CN.Doccheck@sgs.com

Test data for Dock WLAN(Station mode, SANAV Antenna)

Test Mode: 02; Polarity: Horizontal; Modulation:802.11a; Bandwidth:20MHz; Channel:Low

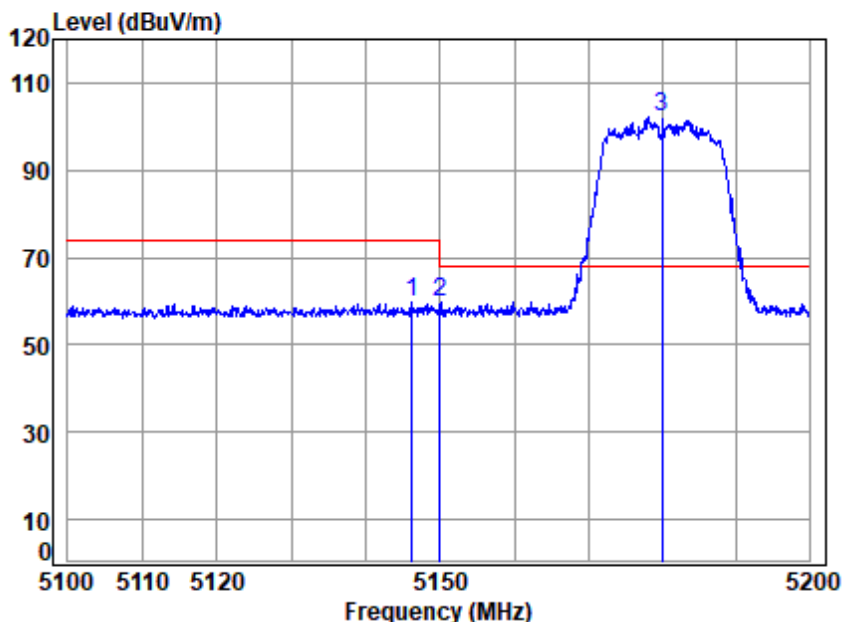

Site : chamber
 Condition: 3m HORIZONTAL
 Job No : 00028CR/00029CR
 Mode : 5180 Band edge
 : 5G WIFI 11A

	Freq	Cable Loss	Ant Factor	Preamp Factor	Read Level	Level	Limit Line	Over Limit	Remark
	MHz	dB	dB/m	dB	dBuV	dBuV/m	dBuV/m	dB	
1	5146.258	7.57	34.32	42.32	60.06	59.63	74.00	-14.37	peak
2	5149.980	7.57	34.32	42.32	60.28	59.85	74.00	-14.15	peak
3 *	5180.000	7.63	34.35	42.32	102.54	102.20	68.20	34.00	peak



Unless otherwise agreed in writing, this document is issued by the Company subject to its General Conditions of Service printed overleaf, available on request or accessible at <http://www.sgs.com/en/Terms-and-Conditions.aspx> and, for electronic format documents, subject to Terms and Conditions for Electronic Documents at <http://www.sgs.com/en/Terms-and-Conditions/Terms-e-Documents.aspx>. Attention is drawn to the limitation of liability, indemnification and jurisdiction issues defined therein. Any holder of this document is advised that information contained hereon reflects the Company's findings at the time of its intervention only and within the limits of Client's instructions, if any. The Company's sole responsibility is to its Client and this document does not exonerate parties to a transaction from exercising all their rights and obligations under the transaction documents. This document cannot be reproduced except in full, without prior written approval of the Company. Any unauthorized alteration, forgery or falsification of the content or appearance of this document is unlawful and offenders may be prosecuted to the fullest extent of the law. Unless otherwise stated the results shown in this test report refer only to the sample(s) tested and such sample(s) are retained for 30 days only.
 Attention: To check the authenticity of testing /inspection report & certificate, please contact us at telephone: (86-755) 8307 1443, or email: CN.Doccheck@sgs.com

Test Mode: 02; Polarity: Horizontal; Modulation:802.11a; Bandwidth:20MHz; Channel:Low

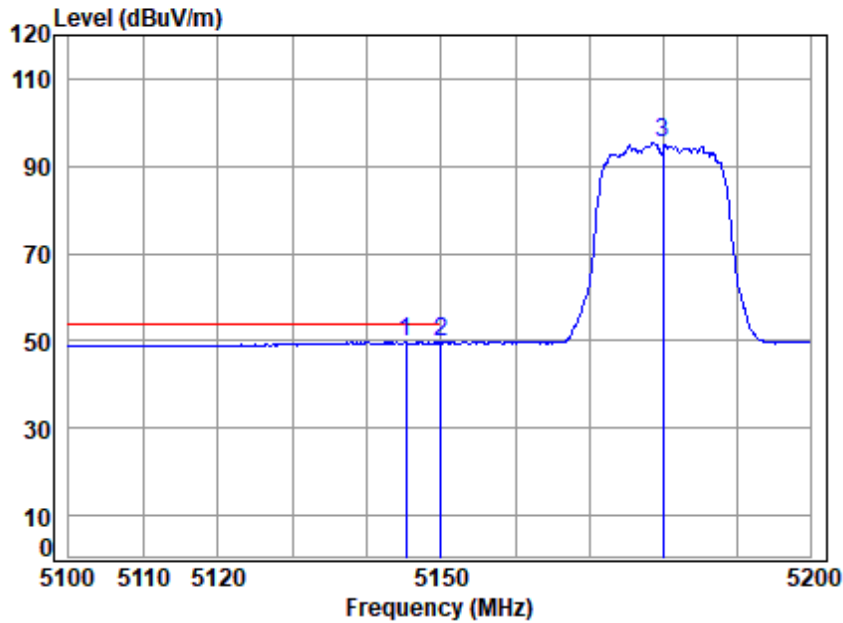

Site : chamber
 Condition: 3m HORIZONTAL
 Job No : 00028CR/00029CR
 Mode : 5180 Band edge
 : 5G WIFI 11A

	Freq	Cable Loss	Ant Factor	Preamp Factor	Read Level	Limit Level	Over Limit	Remark
	MHz	dB	dB/m	dB	dBuV	dBuV/m	dBuV/m	dB
1	5145.259	7.56	34.32	42.32	50.12	49.68	54.00	-4.32 Average
2	5149.980	7.57	34.32	42.32	49.99	49.56	54.00	-4.44 Average
3	5180.000	7.63	34.35	42.32	95.68	95.34	-----	----- Average



Unless otherwise agreed in writing, this document is issued by the Company subject to its General Conditions of Service printed overleaf, available on request or accessible at <http://www.sgs.com/en/Terms-and-Conditions.aspx> and, for electronic format documents, subject to Terms and Conditions for Electronic Documents at <http://www.sgs.com/en/Terms-and-Conditions/Terms-e-Documents.aspx>. Attention is drawn to the limitation of liability, indemnification and jurisdiction issues defined therein. Any holder of this document is advised that information contained hereon reflects the Company's findings at the time of its intervention only and within the limits of Client's instructions, if any. The Company's sole responsibility is to its Client and this document does not exonerate parties to a transaction from exercising all their rights and obligations under the transaction documents. This document cannot be reproduced except in full, without prior written approval of the Company. Any unauthorized alteration, forgery or falsification of the content or appearance of this document is unlawful and offenders may be prosecuted to the fullest extent of the law. Unless otherwise stated the results shown in this test report refer only to the sample(s) tested and such sample(s) are retained for 30 days only.
 Attention: To check the authenticity of testing / inspection report & certificate, please contact us at telephone: (86-755) 8307 1443, or email: CN.Doccheck@sgs.com

Test Mode: 02; Polarity: Vertical; Modulation:802.11a; Bandwidth:20MHz; Channel:Low

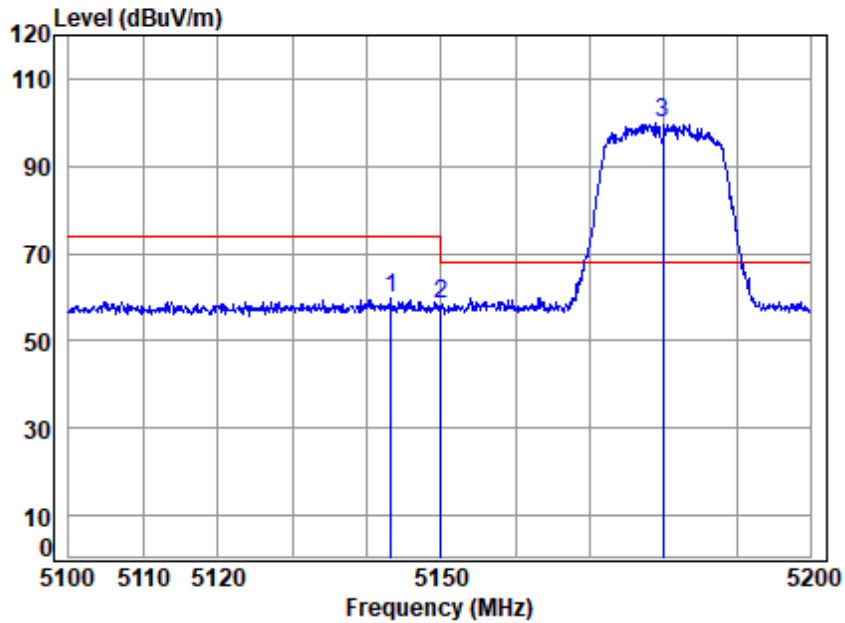

Site : chamber
 Condition: 3m VERTICAL
 Job No : 00028CR/00029CR
 Mode : 5180 Band edge
 : 5G WIFI 11A

	Freq	Cable Loss	Ant Factor	Preamp Factor	Read Level	Level	Limit Line	Over Limit	Remark
	MHz	dB	dB/m	dB	dBuV	dBuV/m	dBuV/m	dB	
1	5143.262	7.56	34.32	42.32	60.34	59.90	74.00	-14.10	Peak
2	5149.980	7.57	34.32	42.32	58.73	58.30	74.00	-15.70	Peak
3 *	5180.000	7.63	34.35	42.32	100.35	100.01	68.20	31.81	Peak



Unless otherwise agreed in writing, this document is issued by the Company subject to its General Conditions of Service printed overleaf, available on request or accessible at <http://www.sgs.com/en/Terms-and-Conditions.aspx> and, for electronic format documents, subject to Terms and Conditions for Electronic Documents at <http://www.sgs.com/en/Terms-and-Conditions/Terms-e-Documents.aspx>. Attention is drawn to the limitation of liability, indemnification and jurisdiction issues defined therein. Any holder of this document is advised that information contained hereon reflects the Company's findings at the time of its intervention only and within the limits of Client's instructions, if any. The Company's sole responsibility is to its Client and this document does not exonerate parties to a transaction from exercising all their rights and obligations under the transaction documents. This document cannot be reproduced except in full, without prior written approval of the Company. Any unauthorized alteration, forgery or falsification of the content or appearance of this document is unlawful and offenders may be prosecuted to the fullest extent of the law. Unless otherwise stated the results shown in this test report refer only to the sample(s) tested and such sample(s) are retained for 30 days only.
 Attention: To check the authenticity of testing /inspection report & certificate, please contact us at telephone: (86-755) 8307 1443, or email: CN.Doccheck@sgs.com

Test Mode: 02; Polarity: Vertical; Modulation:802.11a; Bandwidth:20MHz; Channel:Low

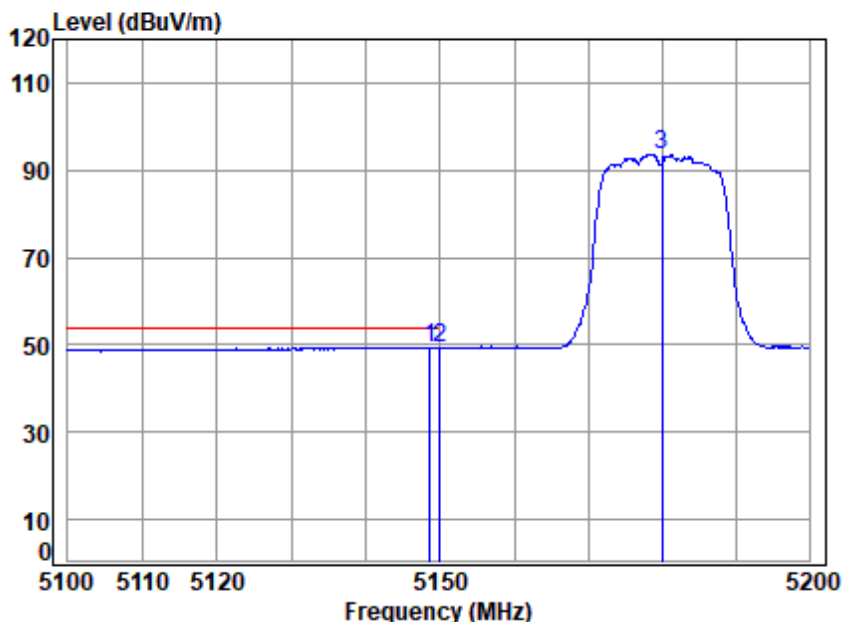

Site : chamber
 Condition: 3m VERTICAL
 Job No : 00028CR/00029CR
 Mode : 5180 Band edge
 : 5G WIFI 11A

	Freq	Cable Loss	Ant Factor	Preamp Factor	Read Level	Level	Limit Line	Over Limit	Remark
	MHz	dB	dB/m	dB	dBuV	dBuV/m	dBuV/m	dB	
1	5148.657	7.57	34.32	42.32	49.84	49.41	54.00	-4.59	Average
2	5149.980	7.57	34.32	42.32	49.71	49.28	54.00	-4.72	Average
3	5180.000	7.63	34.35	42.32	93.89	93.55	-----	-----	Average



Unless otherwise agreed in writing, this document is issued by the Company subject to its General Conditions of Service printed overleaf, available on request or accessible at <http://www.sgs.com/en/Terms-and-Conditions.aspx> and, for electronic format documents, subject to Terms and Conditions for Electronic Documents at <http://www.sgs.com/en/Terms-and-Conditions/Terms-e-Documents.aspx>. Attention is drawn to the limitation of liability, indemnification and jurisdiction issues defined therein. Any holder of this document is advised that information contained hereon reflects the Company's findings at the time of its intervention only and within the limits of Client's instructions, if any. The Company's sole responsibility is to its Client and this document does not exonerate parties to a transaction from exercising all their rights and obligations under the transaction documents. This document cannot be reproduced except in full, without prior written approval of the Company. Any unauthorized alteration, forgery or falsification of the content or appearance of this document is unlawful and offenders may be prosecuted to the fullest extent of the law. Unless otherwise stated the results shown in this test report refer only to the sample(s) tested and such sample(s) are retained for 30 days only.
 Attention: To check the authenticity of testing / inspection report & certificate, please contact us at telephone: (86-755) 8307 1443, or email: CN.Doccheck@sgs.com

Test Mode: 02; Polarity: Horizontal; Modulation:802.11a; Bandwidth:20MHz; Channel:High

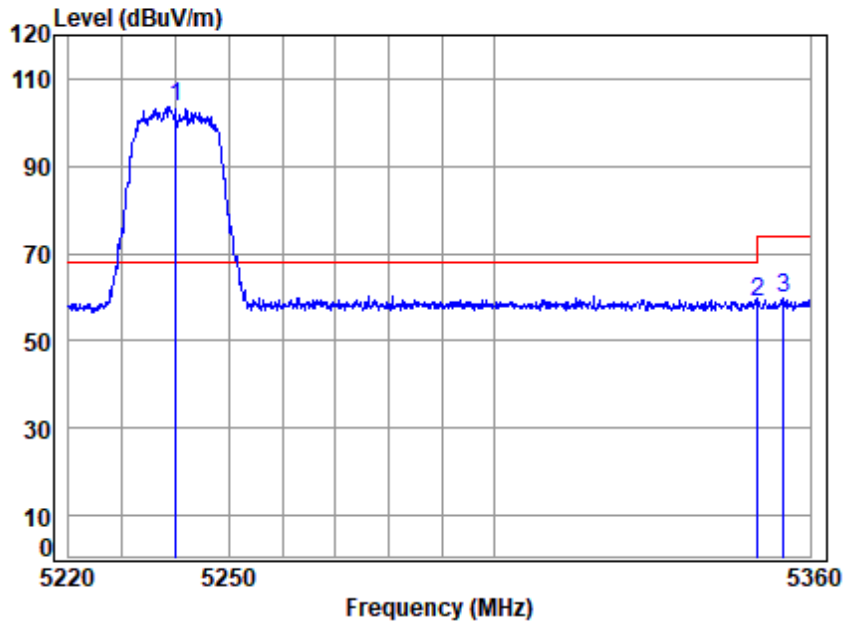

Site : chamber
 Condition: 3m HORIZONTAL
 Job No : 00028CR/00029CR
 Mode : 5240 Band edge
 : 5G WIFI 11A

	Cable	Ant	Preamp	Read	Limit	Over	
Freq	Loss	Factor	Factor	Level	Level	Line	Limit
MHz	dB	dB/m	dB	dBuV	dBuV/m	dBuV/m	dB
1 * 5240.000	7.73	34.40	42.33	103.86	103.66	68.20	35.46 peak
2 5350.020	7.92	34.48	42.34	58.70	58.76	74.00	-15.24 peak
3 5354.896	7.93	34.49	42.34	59.64	59.72	74.00	-14.28 peak



Test Mode: 02; Polarity: Horizontal; Modulation:802.11a; Bandwidth:20MHz; Channel:High

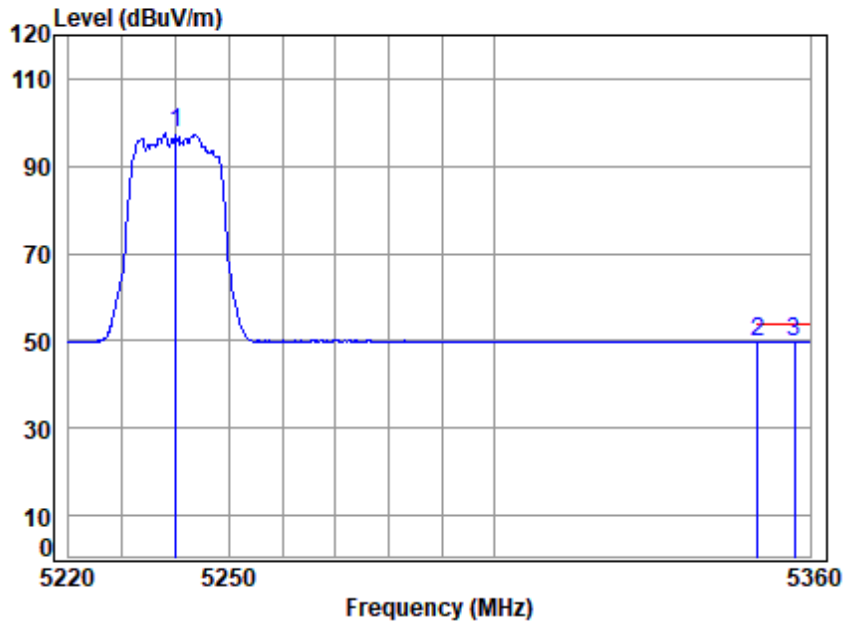

Site : chamber
 Condition: 3m HORIZONTAL
 Job No : 00028CR/00029CR
 Mode : 5240 Band edge
 : 5G WIFI 11A

	Cable	Ant	Preamp	Read	Limit	Over		
Freq	Loss	Factor	Factor	Level	Level	Line	Limit	Remark
MHz	dB	dB/m	dB	dBuV	dBuV/m	dBuV/m	dB	
1	5240.000	7.73	34.40	42.33	97.77	97.57	-----	----- Average
2	5350.020	7.92	34.48	42.34	49.71	49.77	54.00	-4.23 Average
3	5357.022	7.94	34.49	42.34	49.84	49.93	54.00	-4.07 Average



Unless otherwise agreed in writing, this document is issued by the Company subject to its General Conditions of Service printed overleaf, available on request or accessible at <http://www.sgs.com/en/Terms-and-Conditions.aspx> and, for electronic format documents, subject to Terms and Conditions for Electronic Documents at <http://www.sgs.com/en/Terms-and-Conditions/Terms-e-Documents.aspx>. Attention is drawn to the limitation of liability, indemnification and jurisdiction issues defined therein. Any holder of this document is advised that information contained hereon reflects the Company's findings at the time of its intervention only and within the limits of Client's instructions, if any. The Company's sole responsibility is to its Client and this document does not exonerate parties to a transaction from exercising all their rights and obligations under the transaction documents. This document cannot be reproduced except in full, without prior written approval of the Company. Any unauthorized alteration, forgery or falsification of the content or appearance of this document is unlawful and offenders may be prosecuted to the fullest extent of the law. Unless otherwise stated the results shown in this test report refer only to the sample(s) tested and such sample(s) are retained for 30 days only.
 Attention: To check the authenticity of testing /inspection report & certificate, please contact us at telephone: (86-755) 8307 1443, or email: CN.Doccheck@sgs.com

Test Mode: 02; Polarity: Vertical; Modulation:802.11a; Bandwidth:20MHz; Channel:High

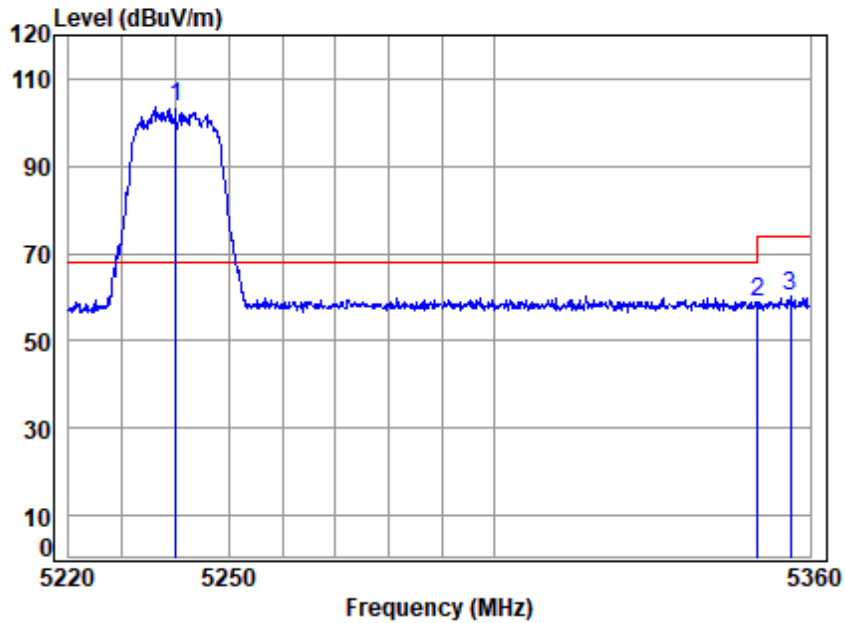

Site : chamber
 Condition: 3m VERTICAL
 Job No : 00028CR/00029CR
 Mode : 5240 Band edge
 : 5G WIFI 11A

Freq	Cable Loss	Ant Factor	Preamp Factor	Read Level	Limit Level	Over Line	Over Limit	Remark
MHz	dB	dB/m	dB	dBuV	dBuV/m	dBuV/m	dB	
1 * 5240.000	7.73	34.40	42.33	103.59	103.39	68.20	35.19	Peak
2 5350.020	7.92	34.48	42.34	59.00	59.06	74.00	-14.94	Peak
3 5356.313	7.94	34.49	42.34	60.27	60.36	74.00	-13.64	Peak



Test Mode: 02; Polarity: Vertical; Modulation:802.11a; Bandwidth:20MHz; Channel:High

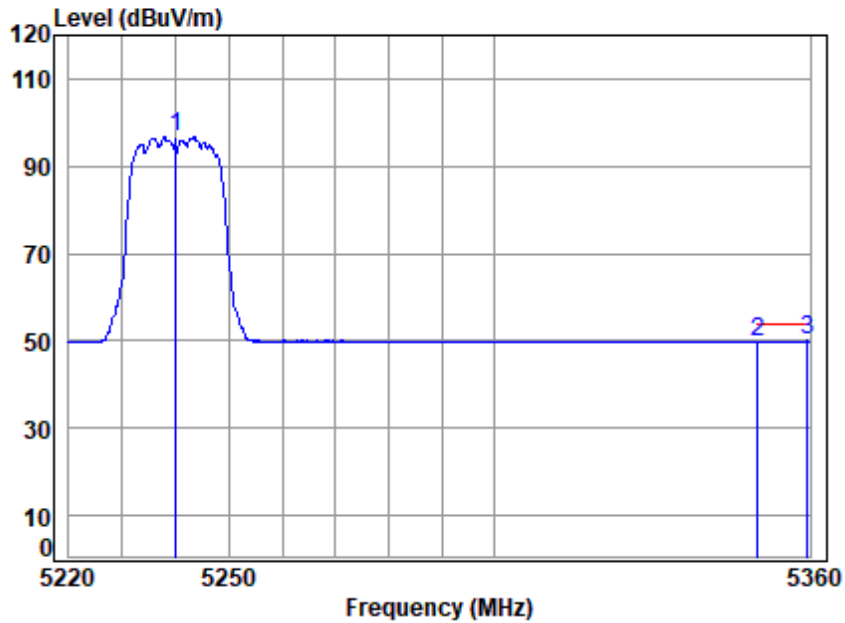

Site : chamber
 Condition: 3m VERTICAL
 Job No : 00028CR/00029CR
 Mode : 5240 Band edge
 : 5G WIFI 11A

	Freq	Cable Loss	Ant Factor	Preamp Factor	Read Level	Limit Level	Over Line	Remark
	MHz	dB	dB/m	dB	dBuV	dBuV/m	dBuV/m	dB
1	5240.000	7.73	34.40	42.33	96.90	96.70	-----	Average
2	5350.020	7.92	34.48	42.34	49.83	49.89	54.00	-4.11 Average
3	5359.433	7.94	34.49	42.34	49.92	50.01	54.00	-3.99 Average



Unless otherwise agreed in writing, this document is issued by the Company subject to its General Conditions of Service printed overleaf, available on request or accessible at <http://www.sgs.com/en/Terms-and-Conditions.aspx> and, for electronic format documents, subject to Terms and Conditions for Electronic Documents at <http://www.sgs.com/en/Terms-and-Conditions/Terms-e-Documents.aspx>. Attention is drawn to the limitation of liability, indemnification and jurisdiction issues defined therein. Any holder of this document is advised that information contained hereon reflects the Company's findings at the time of its intervention only and within the limits of Client's instructions, if any. The Company's sole responsibility is to its Client and this document does not exonerate parties to a transaction from exercising all their rights and obligations under the transaction documents. This document cannot be reproduced except in full, without prior written approval of the Company. Any unauthorized alteration, forgery or falsification of the content or appearance of this document is unlawful and offenders may be prosecuted to the fullest extent of the law. Unless otherwise stated the results shown in this test report refer only to the sample(s) tested and such sample(s) are retained for 30 days only.
 Attention: To check the authenticity of testing /inspection report & certificate, please contact us at telephone: (86-755) 8307 1443, or email: CN.Doccheck@sgs.com

Test Mode: 02; Polarity: Horizontal; Modulation:802.11n; Bandwidth:20MHz; Channel:Low

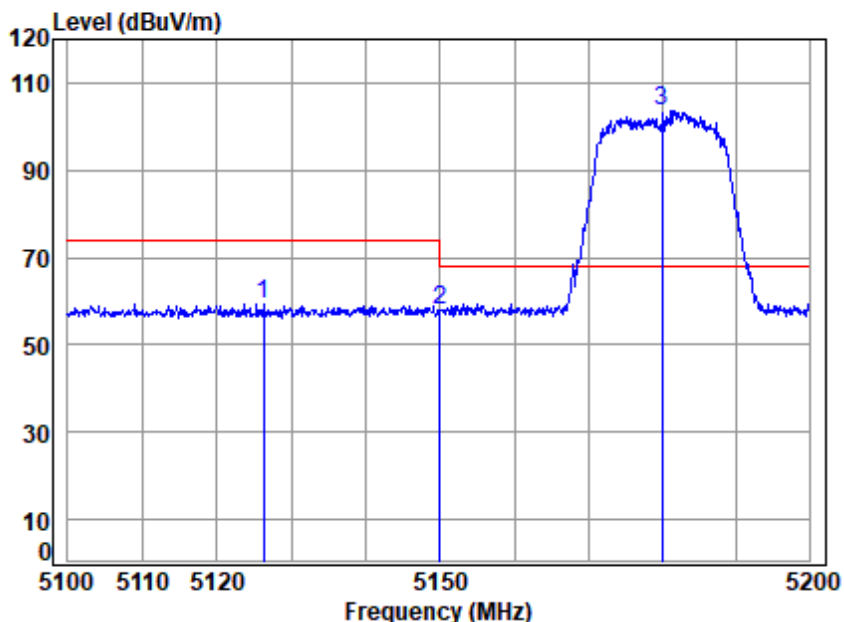

Site : chamber
 Condition: 3m HORIZONTAL
 Job No : 00028CR/00029CR
 Mode : 5180 Band edge
 : 5G WIFI 11N20

	Freq	Cable Loss	Ant Factor	Preamp Factor	Read Level	Limit Level	Over Limit	Remark
	MHz	dB	dB/m	dB	dBuV	dBuV/m	dBuV/m	dB
1	5126.211	7.53	34.30	42.31	59.81	59.33	74.00	-14.67 peak
2	5149.980	7.57	34.32	42.32	58.51	58.08	74.00	-15.92 peak
3 *	5180.000	7.63	34.35	42.32	104.12	103.78	68.20	35.58 peak



Unless otherwise agreed in writing, this document is issued by the Company subject to its General Conditions of Service printed overleaf, available on request or accessible at <http://www.sgs.com/en/Terms-and-Conditions.aspx> and, for electronic format documents, subject to Terms and Conditions for Electronic Documents at <http://www.sgs.com/en/Terms-and-Conditions/Terms-e-Documents.aspx>. Attention is drawn to the limitation of liability, indemnification and jurisdiction issues defined therein. Any holder of this document is advised that information contained hereon reflects the Company's findings at the time of its intervention only and within the limits of Client's instructions, if any. The Company's sole responsibility is to its Client and this document does not exonerate parties to a transaction from exercising all their rights and obligations under the transaction documents. This document cannot be reproduced except in full, without prior written approval of the Company. Any unauthorized alteration, forgery or falsification of the content or appearance of this document is unlawful and offenders may be prosecuted to the fullest extent of the law. Unless otherwise stated the results shown in this test report refer only to the sample(s) tested and such sample(s) are retained for 30 days only.
 Attention: To check the authenticity of testing / inspection report & certificate, please contact us at telephone: (86-755) 8307 1443, or email: CN.Doccheck@sgs.com

Test Mode: 02; Polarity: Horizontal; Modulation:802.11n; Bandwidth:20MHz; Channel:Low

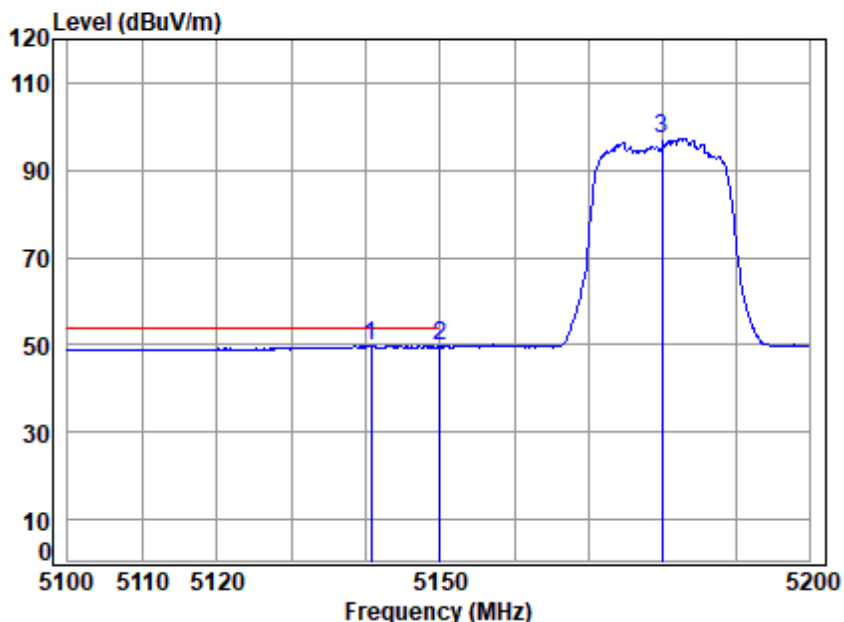

Site : chamber
 Condition: 3m HORIZONTAL
 Job No : 00028CR/00029CR
 Mode : 5180 Band edge
 : 5G WIFI 11N20

	Freq	Cable Loss	Ant Factor	Preamp Factor	Read Level	Limit Level	Over Limit	Remark
	MHz	dB	dB/m	dB	dBuV	dBuV/m	dBuV/m	dB
1	5140.666	7.56	34.32	42.32	50.14	49.70	54.00	-4.30 Average
2	5149.980	7.57	34.32	42.32	50.05	49.62	54.00	-4.38 Average
3	5180.000	7.63	34.35	42.32	97.56	97.22	-----	----- Average



Unless otherwise agreed in writing, this document is issued by the Company subject to its General Conditions of Service printed overleaf, available on request or accessible at <http://www.sgs.com/en/Terms-and-Conditions.aspx> and, for electronic format documents, subject to Terms and Conditions for Electronic Documents at <http://www.sgs.com/en/Terms-and-Conditions/Terms-e-Documents.aspx>. Attention is drawn to the limitation of liability, indemnification and jurisdiction issues defined therein. Any holder of this document is advised that information contained hereon reflects the Company's findings at the time of its intervention only and within the limits of Client's instructions, if any. The Company's sole responsibility is to its Client and this document does not exonerate parties to a transaction from exercising all their rights and obligations under the transaction documents. This document cannot be reproduced except in full, without prior written approval of the Company. Any unauthorized alteration, forgery or falsification of the content or appearance of this document is unlawful and offenders may be prosecuted to the fullest extent of the law. Unless otherwise stated the results shown in this test report refer only to the sample(s) tested and such sample(s) are retained for 30 days only.
 Attention: To check the authenticity of testing / inspection report & certificate, please contact us at telephone: (86-755) 8307 1443, or email: CN.Doccheck@sgs.com

Test Mode: 02; Polarity: Vertical; Modulation:802.11n; Bandwidth:20MHz; Channel:Low

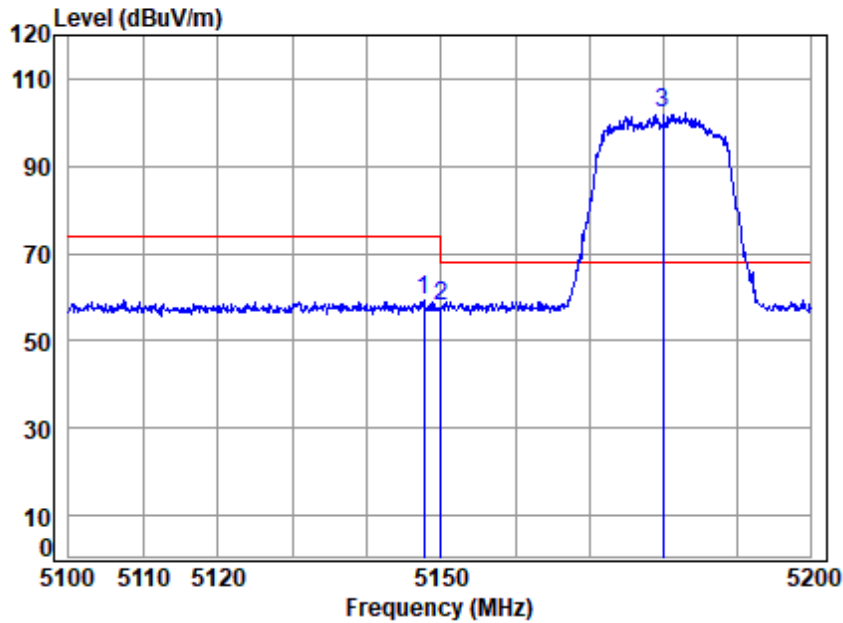

Site : chamber
 Condition: 3m VERTICAL
 Job No : 00028CR/00029CR
 Mode : 5180 Band edge
 : 5G WIFI 11N20

	Freq	Cable Loss	Ant Factor	Preamp Factor	Read Level	Level	Limit Line	Over Limit	Remark
	MHz	dB	dB/m	dB	dBuV	dBuV/m	dBuV/m	dB	
1	5147.658	7.57	34.32	42.32	59.75	59.32	74.00	-14.68	Peak
2	5149.980	7.57	34.32	42.32	58.55	58.12	74.00	-15.88	Peak
3 *	5180.000	7.63	34.35	42.32	102.69	102.35	68.20	34.15	Peak



Unless otherwise agreed in writing, this document is issued by the Company subject to its General Conditions of Service printed overleaf, available on request or accessible at <http://www.sgs.com/en/Terms-and-Conditions.aspx> and, for electronic format documents, subject to Terms and Conditions for Electronic Documents at <http://www.sgs.com/en/Terms-and-Conditions/Terms-e-Documents.aspx>. Attention is drawn to the limitation of liability, indemnification and jurisdiction issues defined therein. Any holder of this document is advised that information contained hereon reflects the Company's findings at the time of its intervention only and within the limits of Client's instructions, if any. The Company's sole responsibility is to its Client and this document does not exonerate parties to a transaction from exercising all their rights and obligations under the transaction documents. This document cannot be reproduced except in full, without prior written approval of the Company. Any unauthorized alteration, forgery or falsification of the content or appearance of this document is unlawful and offenders may be prosecuted to the fullest extent of the law. Unless otherwise stated the results shown in this test report refer only to the sample(s) tested and such sample(s) are retained for 30 days only.
 Attention: To check the authenticity of testing /inspection report & certificate, please contact us at telephone: (86-755) 8307 1443, or email: CN.Doccheck@sgs.com

Test Mode: 02; Polarity: Vertical; Modulation:802.11n; Bandwidth:20MHz; Channel:Low

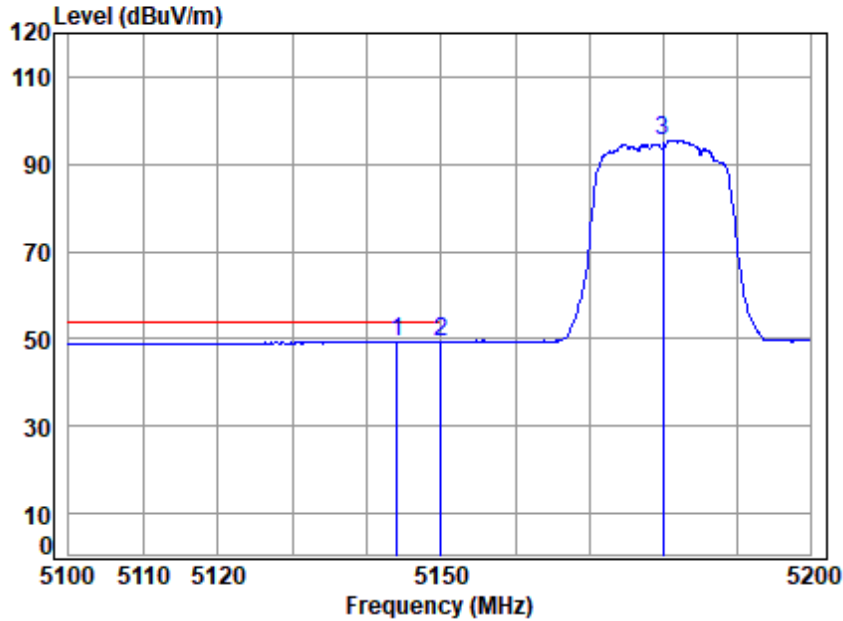

Site : chamber
 Condition: 3m VERTICAL
 Job No : 00028CR/00029CR
 Mode : 5180 Band edge
 : 5G WIFI 11N20

	Freq	Cable Loss	Ant Factor	Preamp Factor	Read Level	Level	Limit Line	Over Limit	Remark
	MHz	dB	dB/m	dB	dBuV	dBuV/m	dBuV/m	dB	
1	5144.061	7.56	34.32	42.32	49.86	49.42	54.00	-4.58	Average
2	5149.980	7.57	34.32	42.32	49.83	49.40	54.00	-4.60	Average
3	5180.000	7.63	34.35	42.32	95.73	95.39	-----	-----	Average



Unless otherwise agreed in writing, this document is issued by the Company subject to its General Conditions of Service printed overleaf, available on request or accessible at <http://www.sgs.com/en/Terms-and-Conditions.aspx> and, for electronic format documents, subject to Terms and Conditions for Electronic Documents at <http://www.sgs.com/en/Terms-and-Conditions/Terms-e-Documents.aspx>. Attention is drawn to the limitation of liability, indemnification and jurisdiction issues defined therein. Any holder of this document is advised that information contained hereon reflects the Company's findings at the time of its intervention only and within the limits of Client's instructions, if any. The Company's sole responsibility is to its Client and this document does not exonerate parties to a transaction from exercising all their rights and obligations under the transaction documents. This document cannot be reproduced except in full, without prior written approval of the Company. Any unauthorized alteration, forgery or falsification of the content or appearance of this document is unlawful and offenders may be prosecuted to the fullest extent of the law. Unless otherwise stated the results shown in this test report refer only to the sample(s) tested and such sample(s) are retained for 30 days only.
 Attention: To check the authenticity of testing / inspection report & certificate, please contact us at telephone: (86-755) 8307 1443, or email: CN.Doccheck@sgs.com

Test Mode: 02; Polarity: Horizontal; Modulation:802.11n; Bandwidth:20MHz; Channel:High

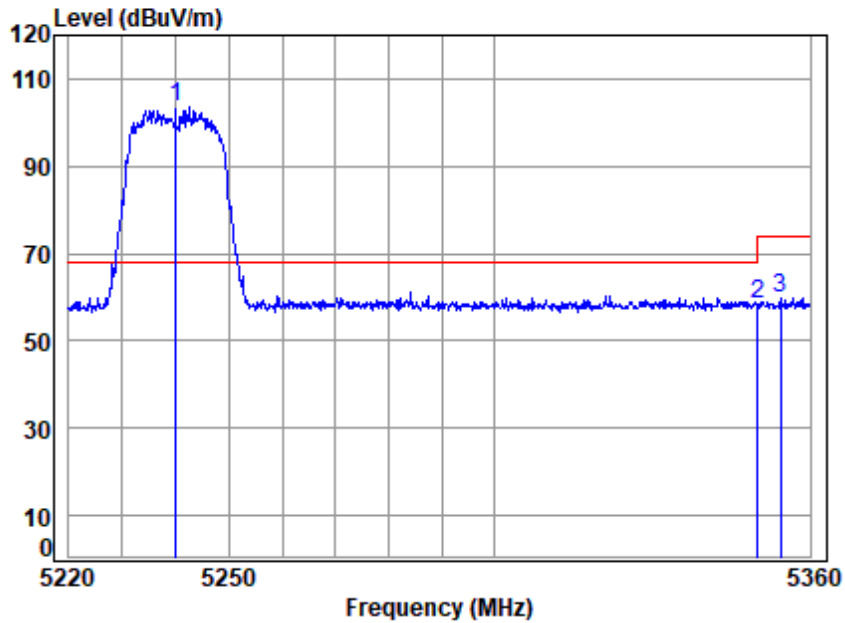

Site : chamber
 Condition: 3m HORIZONTAL
 Job No : 00028CR/00029CR
 Mode : 5240 Band edge
 : 5G WIFI 11N20

Freq	Cable Loss	Ant Factor	Preamp Factor	Read Level	Limit Level	Limit Line	Over Limit	Remark
MHz	dB	dB/m	dB	dBuV	dBuV/m	dBuV/m	dB	
1 * 5240.000	7.73	34.40	42.33	103.73	103.53	68.20	35.33	peak
2 5350.020	7.92	34.48	42.34	58.44	58.50	74.00	-15.50	peak
3 5354.329	7.93	34.49	42.34	59.65	59.73	74.00	-14.27	peak



Unless otherwise agreed in writing, this document is issued by the Company subject to its General Conditions of Service printed overleaf, available on request or accessible at <http://www.sgs.com/en/Terms-and-Conditions.aspx> and, for electronic format documents, subject to Terms and Conditions for Electronic Documents at <http://www.sgs.com/en/Terms-and-Conditions/Terms-e-Documents.aspx>. Attention is drawn to the limitation of liability, indemnification and jurisdiction issues defined therein. Any holder of this document is advised that information contained hereon reflects the Company's findings at the time of its intervention only and within the limits of Client's instructions, if any. The Company's sole responsibility is to its Client and this document does not exonerate parties to a transaction from exercising all their rights and obligations under the transaction documents. This document cannot be reproduced except in full, without prior written approval of the Company. Any unauthorized alteration, forgery or falsification of the content or appearance of this document is unlawful and offenders may be prosecuted to the fullest extent of the law. Unless otherwise stated the results shown in this test report refer only to the sample(s) tested and such sample(s) are retained for 30 days only.
 Attention: To check the authenticity of testing /inspection report & certificate, please contact us at telephone: (86-755) 8307 1443, or email: CN.Doccheck@sgs.com

Test Mode: 02; Polarity: Horizontal; Modulation:802.11n; Bandwidth:20MHz; Channel:High

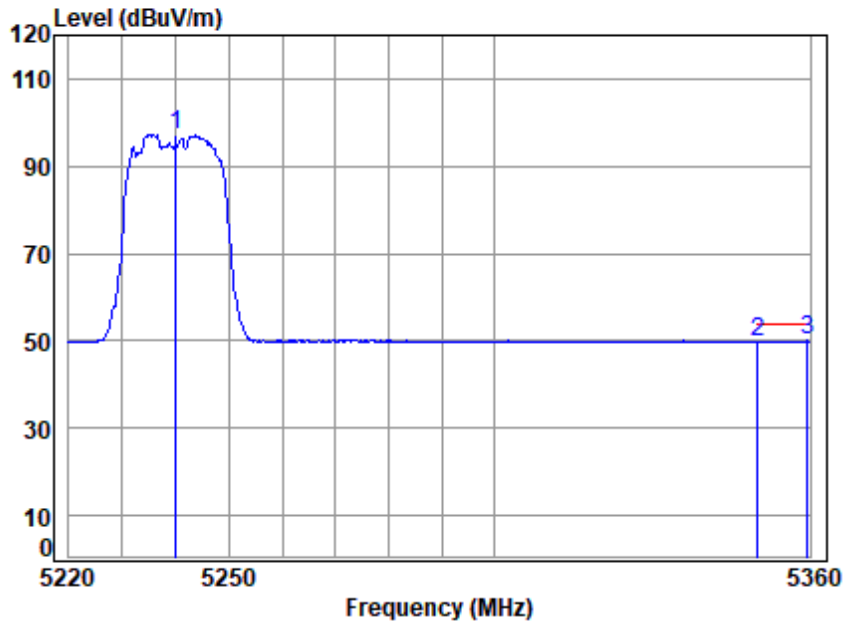

Site : chamber
 Condition: 3m HORIZONTAL
 Job No : 00028CR/00029CR
 Mode : 5240 Band edge
 : 5G WIFI 11N20

	Freq	Cable Loss	Ant Factor	Preamp Factor	Read Level	Limit Level	Over Line	Over Limit	Remark
	MHz	dB	dB/m	dB	dBuV	dBuV/m	dBuV/m	dB	
1	5240.000	7.73	34.40	42.33	97.35	97.15	-----	-----	Average
2	5350.020	7.92	34.48	42.34	49.74	49.80	54.00	-4.20	Average
3	5359.574	7.94	34.49	42.34	49.89	49.98	54.00	-4.02	Average



Unless otherwise agreed in writing, this document is issued by the Company subject to its General Conditions of Service printed overleaf, available on request or accessible at <http://www.sgs.com/en/Terms-and-Conditions.aspx> and, for electronic format documents, subject to Terms and Conditions for Electronic Documents at <http://www.sgs.com/en/Terms-and-Conditions/Terms-e-Documents.aspx>. Attention is drawn to the limitation of liability, indemnification and jurisdiction issues defined therein. Any holder of this document is advised that information contained hereon reflects the Company's findings at the time of its intervention only and within the limits of Client's instructions, if any. The Company's sole responsibility is to its Client and this document does not exonerate parties to a transaction from exercising all their rights and obligations under the transaction documents. This document cannot be reproduced except in full, without prior written approval of the Company. Any unauthorized alteration, forgery or falsification of the content or appearance of this document is unlawful and offenders may be prosecuted to the fullest extent of the law. Unless otherwise stated the results shown in this test report refer only to the sample(s) tested and such sample(s) are retained for 30 days only.
 Attention: To check the authenticity of testing /inspection report & certificate, please contact us at telephone: (86-755) 8307 1443, or email: CN.Doccheck@sgs.com

Test Mode: 02; Polarity: Vertical; Modulation:802.11n; Bandwidth:20MHz; Channel:High

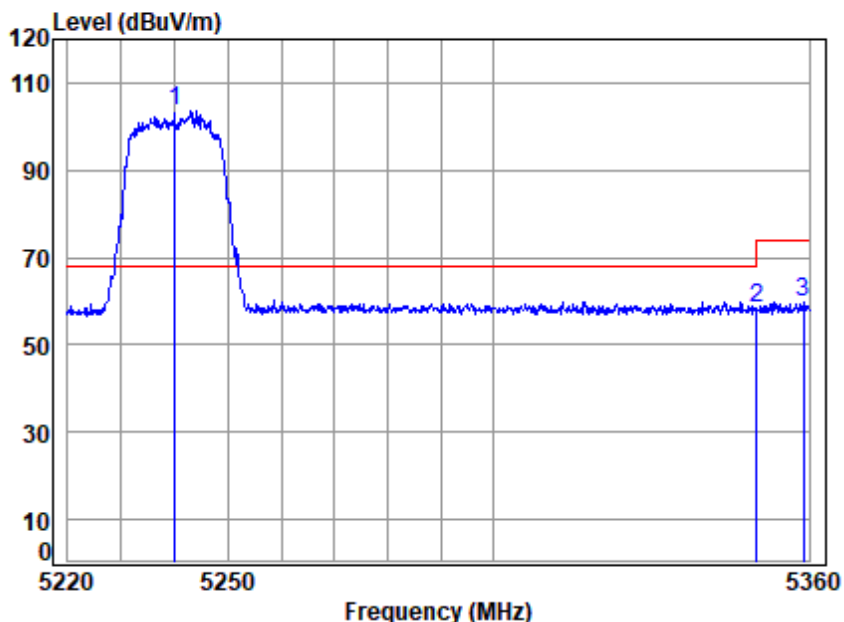

Site : chamber
 Condition: 3m VERTICAL
 Job No : 00028CR/00029CR
 Mode : 5240 Band edge
 : 5G WIFI 11N20

Freq	Cable Loss	Ant Factor	Preamp Factor	Read Level	Limit Level	Over Line	Remark
MHz	dB	dB/m	dB	dBuV	dBuV/m	dBuV/m	dB
1 * 5240.000	7.73	34.40	42.33	103.58	103.38	68.20	35.18 Peak
2 5350.020	7.92	34.48	42.34	58.13	58.19	74.00	-15.81 Peak
3 5358.865	7.94	34.49	42.34	59.61	59.70	74.00	-14.30 Peak



Test Mode: 02; Polarity: Vertical; Modulation:802.11n; Bandwidth:20MHz; Channel:High

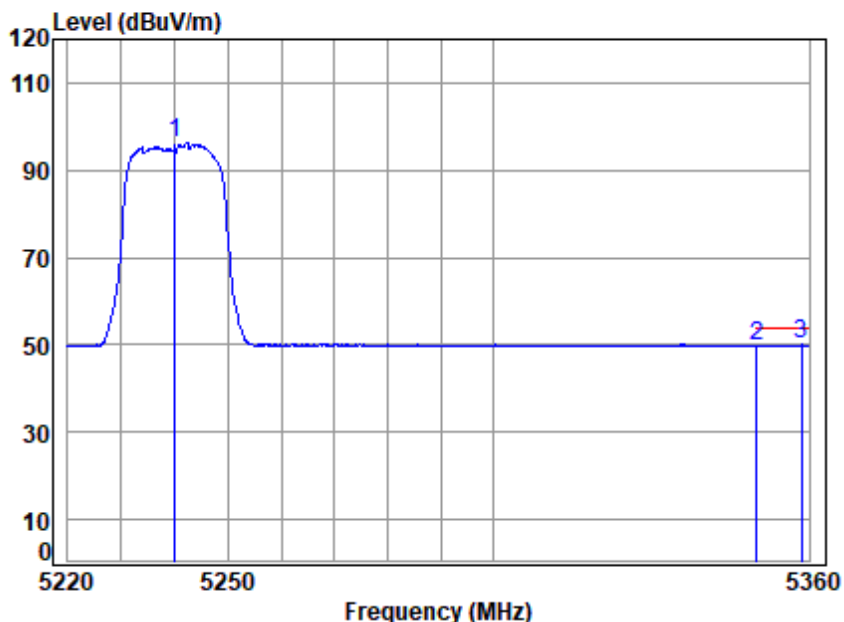

Site : chamber
 Condition: 3m VERTICAL
 Job No : 00028CR/00029CR
 Mode : 5240 Band edge
 : 5G WIFI 11N20

	Freq	Cable Loss	Ant Factor	Preamp Factor	Read Level	Limit Level	Over Line	Over Limit	Remark
	MHz	dB	dB/m	dB	dBuV	dBuV/m	dBuV/m	dB	
1	5240.000	7.73	34.40	42.33	96.67	96.47	-----	-----	Average
2	5350.020	7.92	34.48	42.34	49.73	49.79	54.00	-4.21	Average
3	5358.582	7.94	34.49	42.34	49.88	49.97	54.00	-4.03	Average



Unless otherwise agreed in writing, this document is issued by the Company subject to its General Conditions of Service printed overleaf, available on request or accessible at <http://www.sgs.com/en/Terms-and-Conditions.aspx> and, for electronic format documents, subject to Terms and Conditions for Electronic Documents at <http://www.sgs.com/en/Terms-and-Conditions/Terms-e-Documents.aspx>. Attention is drawn to the limitation of liability, indemnification and jurisdiction issues defined therein. Any holder of this document is advised that information contained hereon reflects the Company's findings at the time of its intervention only and within the limits of Client's instructions, if any. The Company's sole responsibility is to its Client and this document does not exonerate parties to a transaction from exercising all their rights and obligations under the transaction documents. This document cannot be reproduced except in full, without prior written approval of the Company. Any unauthorized alteration, forgery or falsification of the content or appearance of this document is unlawful and offenders may be prosecuted to the fullest extent of the law. Unless otherwise stated the results shown in this test report refer only to the sample(s) tested and such sample(s) are retained for 30 days only.
 Attention: To check the authenticity of testing /inspection report & certificate, please contact us at telephone: (86-755) 8307 1443, or email: CN.Doccheck@sgs.com

Test Mode: 02; Polarity: Horizontal; Modulation:802.11n; Bandwidth:40MHz; Channel:Low

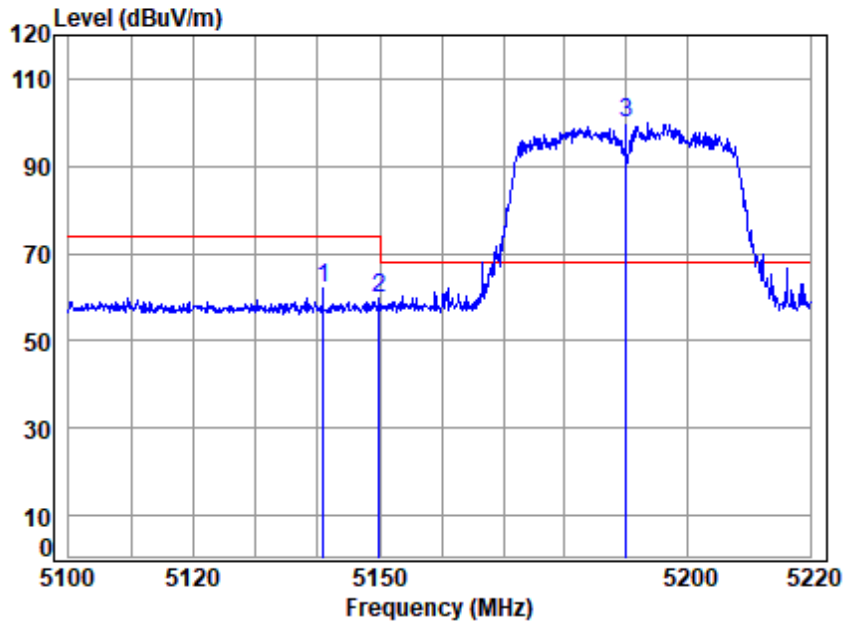

Site : chamber
 Condition: 3m HORIZONTAL
 Job No : 00028CR/00029CR
 Mode : 5190 Band edge
 : 5G WIFI 11N40

	Cable	Ant	Preamp	Read	Limit	Over		
Freq	Loss	Factor	Factor	Level	Level	Line	Limit	Remark
MHz	dB	dB/m	dB	dBuV	dBuV/m	dBuV/m	dB	
1	5140.846	7.56	34.32	42.32	62.68	62.24	74.00	-11.76 peak
2	5149.980	7.57	34.32	42.32	60.28	59.85	74.00	-14.15 peak
3 *	5190.000	7.64	34.36	42.32	100.13	99.81	68.20	31.61 peak



Unless otherwise agreed in writing, this document is issued by the Company subject to its General Conditions of Service printed overleaf, available on request or accessible at <http://www.sgs.com/en/Terms-and-Conditions.aspx> and, for electronic format documents, subject to Terms and Conditions for Electronic Documents at <http://www.sgs.com/en/Terms-and-Conditions/Terms-e-Documents.aspx>. Attention is drawn to the limitation of liability, indemnification and jurisdiction issues defined therein. Any holder of this document is advised that information contained hereon reflects the Company's findings at the time of its intervention only and within the limits of Client's instructions, if any. The Company's sole responsibility is to its Client and this document does not exonerate parties to a transaction from exercising all their rights and obligations under the transaction documents. This document cannot be reproduced except in full, without prior written approval of the Company. Any unauthorized alteration, forgery or falsification of the content or appearance of this document is unlawful and offenders may be prosecuted to the fullest extent of the law. Unless otherwise stated the results shown in this test report refer only to the sample(s) tested and such sample(s) are retained for 30 days only.
 Attention: To check the authenticity of testing /inspection report & certificate, please contact us at telephone: (86-755) 8307 1443, or email: CN.Doccheck@sgs.com

Test Mode: 02; Polarity: Horizontal; Modulation:802.11n; Bandwidth:40MHz; Channel:Low

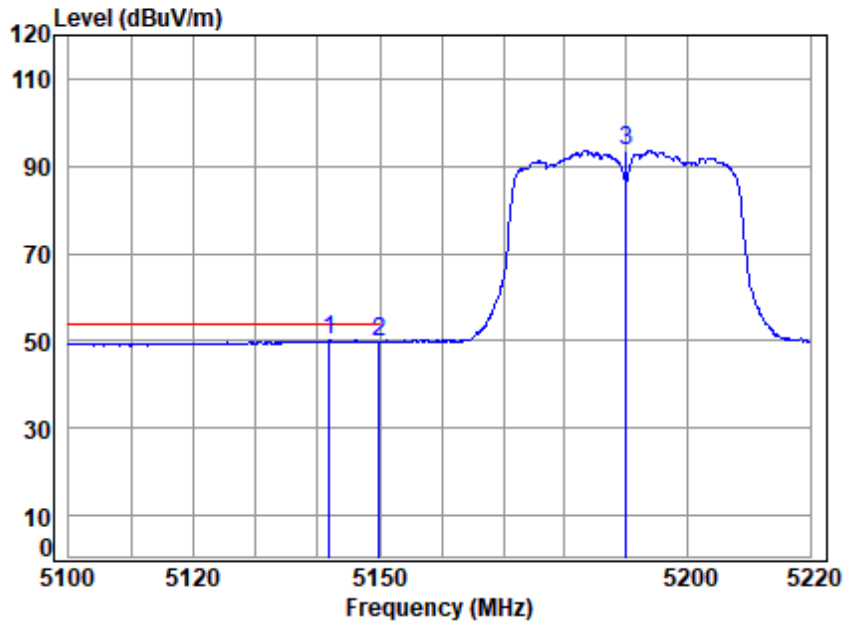

Site : chamber
 Condition: 3m HORIZONTAL
 Job No : 00028CR/00029CR
 Mode : 5190 Band edge
 : 5G WIFI 11N40

	Freq	Cable Loss	Ant Factor	Preamp Factor	Read Level	Level	Limit Line	Over Limit	Remark
	MHz	dB	dB/m	dB	dBuV	dBuV/m	dBuV/m	dB	
1	5141.922	7.56	34.32	42.32	50.59	50.15	54.00	-3.85	Average
2	5149.980	7.57	34.32	42.32	50.24	49.81	54.00	-4.19	Average
3	5190.000	7.64	34.36	42.32	93.97	93.65	-----	-----	Average



Unless otherwise agreed in writing, this document is issued by the Company subject to its General Conditions of Service printed overleaf, available on request or accessible at <http://www.sgs.com/en/Terms-and-Conditions.aspx> and, for electronic format documents, subject to Terms and Conditions for Electronic Documents at <http://www.sgs.com/en/Terms-and-Conditions/Terms-e-Documents.aspx>. Attention is drawn to the limitation of liability, indemnification and jurisdiction issues defined therein. Any holder of this document is advised that information contained hereon reflects the Company's findings at the time of its intervention only and within the limits of Client's instructions, if any. The Company's sole responsibility is to its Client and this document does not exonerate parties to a transaction from exercising all their rights and obligations under the transaction documents. This document cannot be reproduced except in full, without prior written approval of the Company. Any unauthorized alteration, forgery or falsification of the content or appearance of this document is unlawful and offenders may be prosecuted to the fullest extent of the law. Unless otherwise stated the results shown in this test report refer only to the sample(s) tested and such sample(s) are retained for 30 days only.
 Attention: To check the authenticity of testing /inspection report & certificate, please contact us at telephone: (86-755) 8307 1443, or email: CN.Doccheck@sgs.com

Test Mode: 02; Polarity: Vertical; Modulation:802.11n; Bandwidth:40MHz; Channel:Low

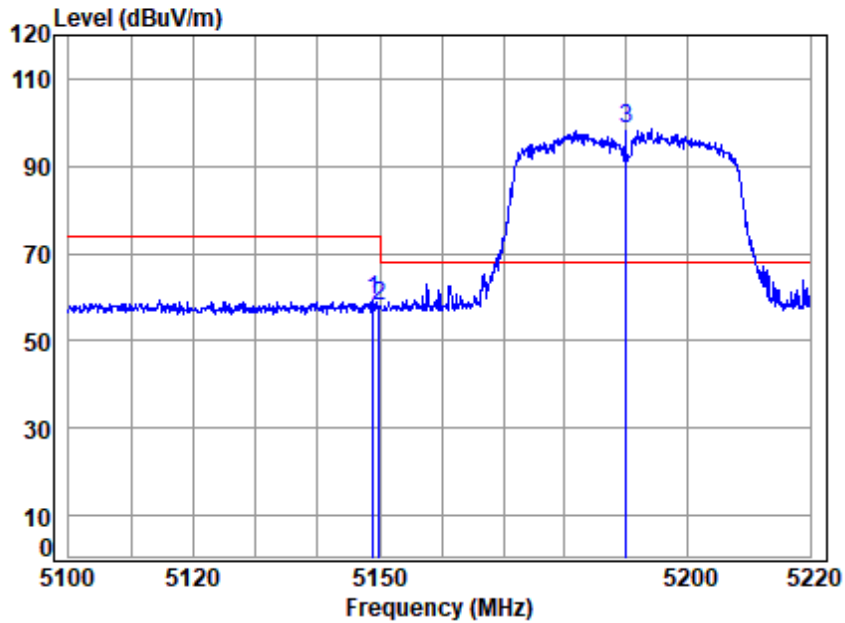

Site : chamber
 Condition: 3m VERTICAL
 Job No : 00028CR/00029CR
 Mode : 5190 Band edge
 : 5G WIFI 11N40

	Cable	Ant	Preamp	Read	Limit	Over		
Freq	Loss	Factor	Factor	Level	Level	Line	Limit	Remark
MHz	dB	dB/m	dB	dBuV	dBuV/m	dBuV/m	dB	
1	5148.982	7.57	34.32	42.32	59.59	59.16	74.00	-14.84 Peak
2	5149.980	7.57	34.32	42.32	58.34	57.91	74.00	-16.09 Peak
3 *	5190.000	7.64	34.36	42.32	98.76	98.44	68.20	30.24 Peak



Unless otherwise agreed in writing, this document is issued by the Company subject to its General Conditions of Service printed overleaf, available on request or accessible at <http://www.sgs.com/en/Terms-and-Conditions.aspx> and, for electronic format documents, subject to Terms and Conditions for Electronic Documents at <http://www.sgs.com/en/Terms-and-Conditions/Terms-e-Documents.aspx>. Attention is drawn to the limitation of liability, indemnification and jurisdiction issues defined therein. Any holder of this document is advised that information contained hereon reflects the Company's findings at the time of its intervention only and within the limits of Client's instructions, if any. The Company's sole responsibility is to its Client and this document does not exonerate parties to a transaction from exercising all their rights and obligations under the transaction documents. This document cannot be reproduced except in full, without prior written approval of the Company. Any unauthorized alteration, forgery or falsification of the content or appearance of this document is unlawful and offenders may be prosecuted to the fullest extent of the law. Unless otherwise stated the results shown in this test report refer only to the sample(s) tested and such sample(s) are retained for 30 days only.
 Attention: To check the authenticity of testing /inspection report & certificate, please contact us at telephone: (86-755) 8307 1443, or email: CN.Doccheck@sgs.com

Test Mode: 02; Polarity: Vertical; Modulation:802.11n; Bandwidth:40MHz; Channel:Low

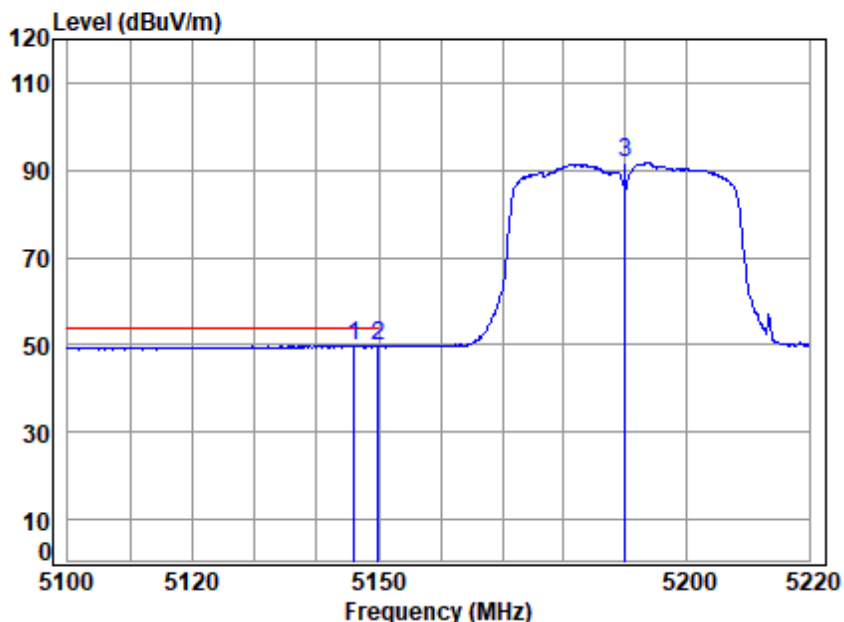

Site : chamber
 Condition: 3m VERTICAL
 Job No : 00028CR/00029CR
 Mode : 5190 Band edge
 : 5G WIFI 11N40

	Freq	Cable Loss	Ant Factor	Preamp Factor	Read Level	Level	Limit Line	Over Limit	Remark
	MHz	dB	dB/m	dB	dBuV	dBuV/m	dBuV/m	dB	
1	5145.990	7.57	34.32	42.32	50.19	49.76	54.00	-4.24	Average
2	5149.980	7.57	34.32	42.32	50.02	49.59	54.00	-4.41	Average
3	5190.000	7.64	34.36	42.32	92.01	91.69	-----	-----	Average



Unless otherwise agreed in writing, this document is issued by the Company subject to its General Conditions of Service printed overleaf, available on request or accessible at <http://www.sgs.com/en/Terms-and-Conditions.aspx> and, for electronic format documents, subject to Terms and Conditions for Electronic Documents at <http://www.sgs.com/en/Terms-and-Conditions/Terms-e-Documents.aspx>. Attention is drawn to the limitation of liability, indemnification and jurisdiction issues defined therein. Any holder of this document is advised that information contained hereon reflects the Company's findings at the time of its intervention only and within the limits of Client's instructions, if any. The Company's sole responsibility is to its Client and this document does not exonerate parties to a transaction from exercising all their rights and obligations under the transaction documents. This document cannot be reproduced except in full, without prior written approval of the Company. Any unauthorized alteration, forgery or falsification of the content or appearance of this document is unlawful and offenders may be prosecuted to the fullest extent of the law. Unless otherwise stated the results shown in this test report refer only to the sample(s) tested and such sample(s) are retained for 30 days only.
 Attention: To check the authenticity of testing /inspection report & certificate, please contact us at telephone: (86-755) 8307 1443, or email: CN.Doccheck@sgs.com

Test Mode: 02; Polarity: Horizontal; Modulation:802.11n; Bandwidth:40MHz; Channel:High

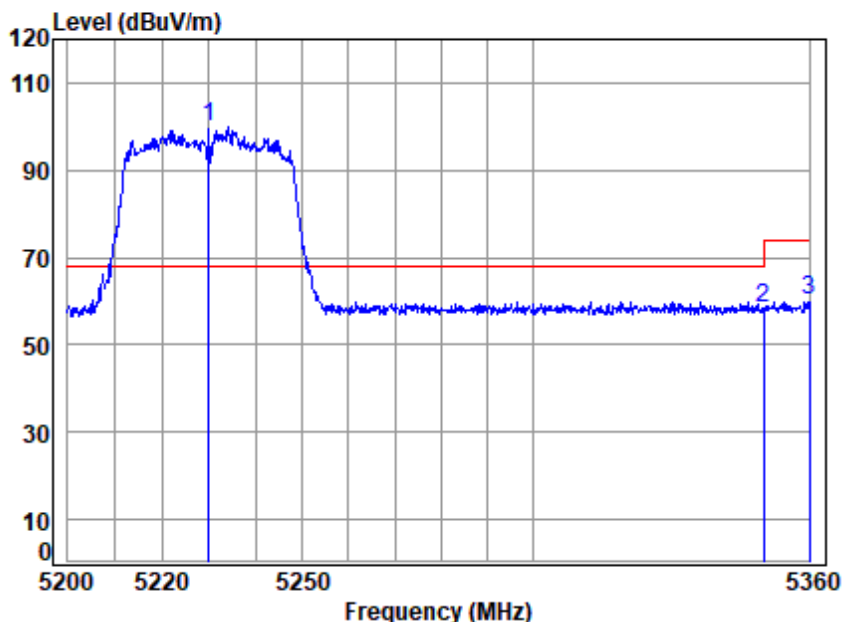

Site : chamber
 Condition: 3m HORIZONTAL
 Job No : 00028CR/00029CR
 Mode : 5230 Band edge
 : 5G WIFI 11N40

	Cable	Ant	Preamp	Read	Limit	Over	
Freq	Loss	Factor	Factor	Level	Level	Line	Limit Remark
MHz	dB	dB/m	dB	dBuV	dBuV/m	dBuV/m	dB
1 * 5230.000	7.72	34.39	42.32	100.15	99.94	68.20	31.74 peak
2 5350.020	7.92	34.48	42.34	58.19	58.25	74.00	-15.75 peak
3 5360.000	7.94	34.49	42.34	59.96	60.05	74.00	-13.95 peak



Unless otherwise agreed in writing, this document is issued by the Company subject to its General Conditions of Service printed overleaf, available on request or accessible at <http://www.sgs.com/en/Terms-and-Conditions.aspx> and, for electronic format documents, subject to Terms and Conditions for Electronic Documents at <http://www.sgs.com/en/Terms-and-Conditions/Terms-e-Documents.aspx>. Attention is drawn to the limitation of liability, indemnification and jurisdiction issues defined therein. Any holder of this document is advised that information contained hereon reflects the Company's findings at the time of its intervention only and within the limits of Client's instructions, if any. The Company's sole responsibility is to its Client and this document does not exonerate parties to a transaction from exercising all their rights and obligations under the transaction documents. This document cannot be reproduced except in full, without prior written approval of the Company. Any unauthorized alteration, forgery or falsification of the content or appearance of this document is unlawful and offenders may be prosecuted to the fullest extent of the law. Unless otherwise stated the results shown in this test report refer only to the sample(s) tested and such sample(s) are retained for 30 days only.
 Attention: To check the authenticity of testing / inspection report & certificate, please contact us at telephone: (86-755) 8307 1443, or email: CN.Doccheck@sgs.com

Test Mode: 02; Polarity: Horizontal; Modulation:802.11n; Bandwidth:40MHz; Channel:High

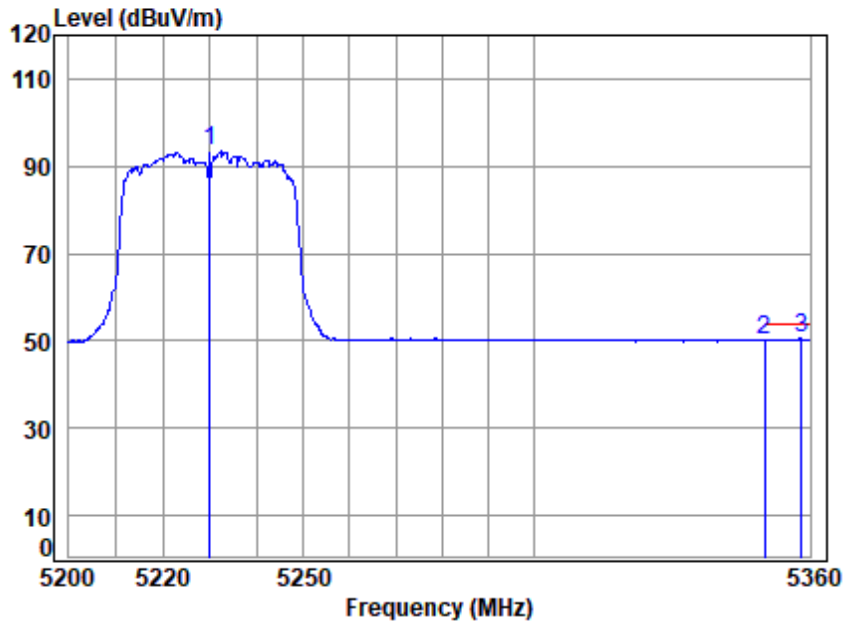

Site : chamber
 Condition: 3m HORIZONTAL
 Job No : 00028CR/00029CR
 Mode : 5230 Band edge
 : 5G WIFI 11N40

	Freq	Cable Loss	Ant Factor	Preamp Factor	Read Level	Limit Level	Over Limit	Remark
	MHz	dB	dB/m	dB	dBuV	dBuV/m	dBuV/m	dB
1	5230.000	7.72	34.39	42.32	93.54	93.33	-----	----- Average
2	5350.020	7.92	34.48	42.34	50.12	50.18	54.00	-3.82 Average
3	5358.051	7.94	34.49	42.34	50.36	50.45	54.00	-3.55 Average



Unless otherwise agreed in writing, this document is issued by the Company subject to its General Conditions of Service printed overleaf, available on request or accessible at <http://www.sgs.com/en/Terms-and-Conditions.aspx> and, for electronic format documents, subject to Terms and Conditions for Electronic Documents at <http://www.sgs.com/en/Terms-and-Conditions/Terms-e-Documents.aspx>. Attention is drawn to the limitation of liability, indemnification and jurisdiction issues defined therein. Any holder of this document is advised that information contained hereon reflects the Company's findings at the time of its intervention only and within the limits of Client's instructions, if any. The Company's sole responsibility is to its Client and this document does not exonerate parties to a transaction from exercising all their rights and obligations under the transaction documents. This document cannot be reproduced except in full, without prior written approval of the Company. Any unauthorized alteration, forgery or falsification of the content or appearance of this document is unlawful and offenders may be prosecuted to the fullest extent of the law. Unless otherwise stated the results shown in this test report refer only to the sample(s) tested and such sample(s) are retained for 30 days only.
 Attention: To check the authenticity of testing /inspection report & certificate, please contact us at telephone: (86-755) 8307 1443, or email: CN.Doccheck@sgs.com

Test Mode: 02; Polarity: Vertical; Modulation:802.11n; Bandwidth:40MHz; Channel:High

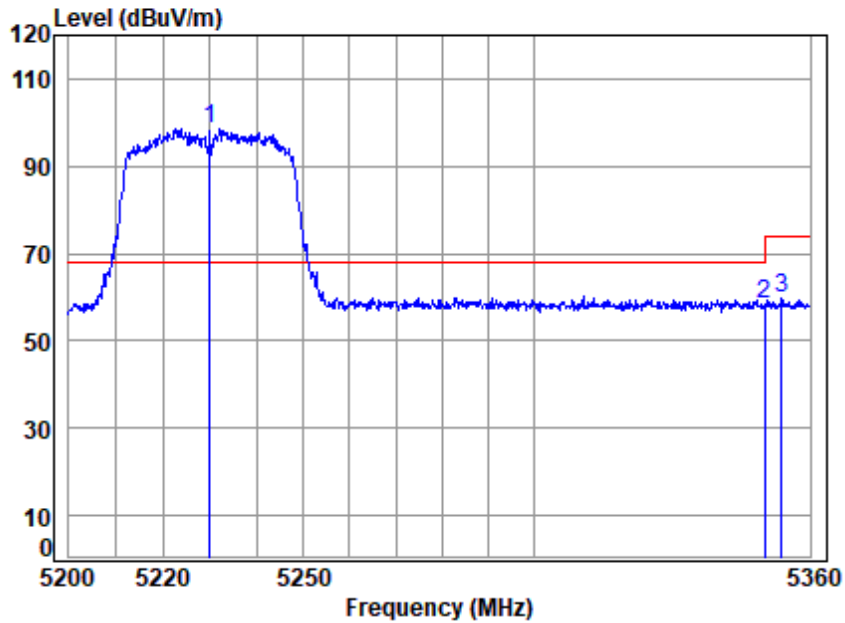

Site : chamber
 Condition: 3m VERTICAL
 Job No : 00028CR/00029CR
 Mode : 5230 Band edge
 : 5G WIFI 11N40

	Cable	Ant	Preamp	Read	Limit	Over	
Freq	Loss	Factor	Factor	Level	Level	Line	Limit Remark
MHz	dB	dB/m	dB	dBuV	dBuV/m	dBuV/m	dB
1 * 5230.000	7.72	34.39	42.32	98.98	98.77	68.20	30.57 Peak
2 5350.020	7.92	34.48	42.34	58.25	58.31	74.00	-15.69 Peak
3 5353.831	7.93	34.49	42.34	59.63	59.71	74.00	-14.29 Peak



Unless otherwise agreed in writing, this document is issued by the Company subject to its General Conditions of Service printed overleaf, available on request or accessible at <http://www.sgs.com/en/Terms-and-Conditions.aspx> and, for electronic format documents, subject to Terms and Conditions for Electronic Documents at <http://www.sgs.com/en/Terms-and-Conditions/Terms-e-Documents.aspx>. Attention is drawn to the limitation of liability, indemnification and jurisdiction issues defined therein. Any holder of this document is advised that information contained hereon reflects the Company's findings at the time of its intervention only and within the limits of Client's instructions, if any. The Company's sole responsibility is to its Client and this document does not exonerate parties to a transaction from exercising all their rights and obligations under the transaction documents. This document cannot be reproduced except in full, without prior written approval of the Company. Any unauthorized alteration, forgery or falsification of the content or appearance of this document is unlawful and offenders may be prosecuted to the fullest extent of the law. Unless otherwise stated the results shown in this test report refer only to the sample(s) tested and such sample(s) are retained for 30 days only.
 Attention: To check the authenticity of testing / inspection report & certificate, please contact us at telephone: (86-755) 8307 1443, or email: CN.Doccheck@sgs.com

Test Mode: 02; Polarity: Vertical; Modulation:802.11n; Bandwidth:40MHz; Channel:High

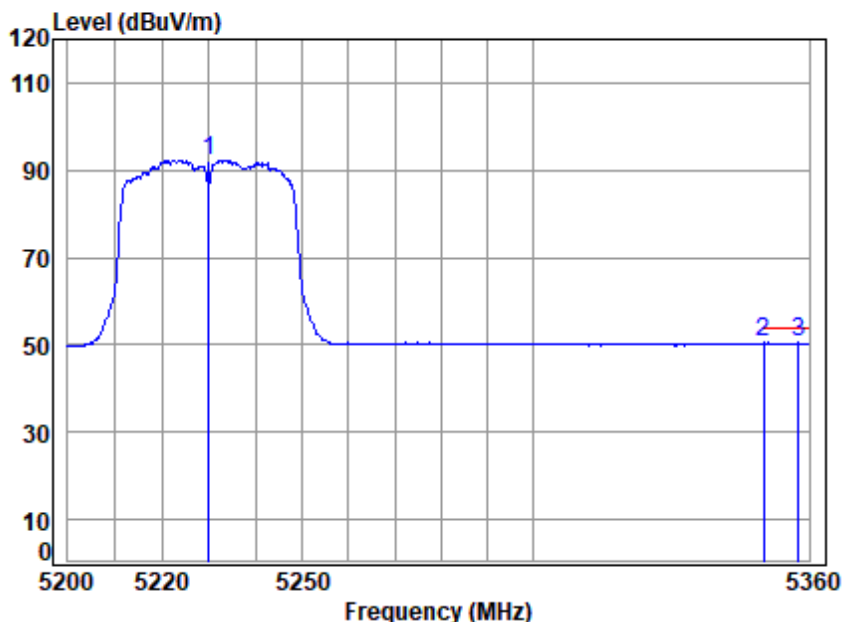

Site : chamber
 Condition: 3m VERTICAL
 Job No : 00028CR/00029CR
 Mode : 5230 Band edge
 : 5G WIFI 11N40

	Freq	Cable Loss	Ant Factor	Preamp Factor	Read Level	Limit Level	Over Limit	Remark
	MHz	dB	dB/m	dB	dBuV	dBuV/m	dBuV/m	dB
1	5230.000	7.72	34.39	42.32	92.59	92.38	-----	Average
2	5350.020	7.92	34.48	42.34	50.47	50.53	54.00	-3.47 Average
3	5357.727	7.94	34.49	42.34	50.36	50.45	54.00	-3.55 Average



Unless otherwise agreed in writing, this document is issued by the Company subject to its General Conditions of Service printed overleaf, available on request or accessible at <http://www.sgs.com/en/Terms-and-Conditions.aspx> and, for electronic format documents, subject to Terms and Conditions for Electronic Documents at <http://www.sgs.com/en/Terms-and-Conditions/Terms-e-Documents.aspx>. Attention is drawn to the limitation of liability, indemnification and jurisdiction issues defined therein. Any holder of this document is advised that information contained hereon reflects the Company's findings at the time of its intervention only and within the limits of Client's instructions, if any. The Company's sole responsibility is to its Client and this document does not exonerate parties to a transaction from exercising all their rights and obligations under the transaction documents. This document cannot be reproduced except in full, without prior written approval of the Company. Any unauthorized alteration, forgery or falsification of the content or appearance of this document is unlawful and offenders may be prosecuted to the fullest extent of the law. Unless otherwise stated the results shown in this test report refer only to the sample(s) tested and such sample(s) are retained for 30 days only.
 Attention: To check the authenticity of testing / inspection report & certificate, please contact us at telephone: (86-755) 8307 1443, or email: CN.Doccheck@sgs.com

Test Mode: 02; Polarity: Horizontal; Modulation:802.11ac; Bandwidth:20MHz; Channel:Low

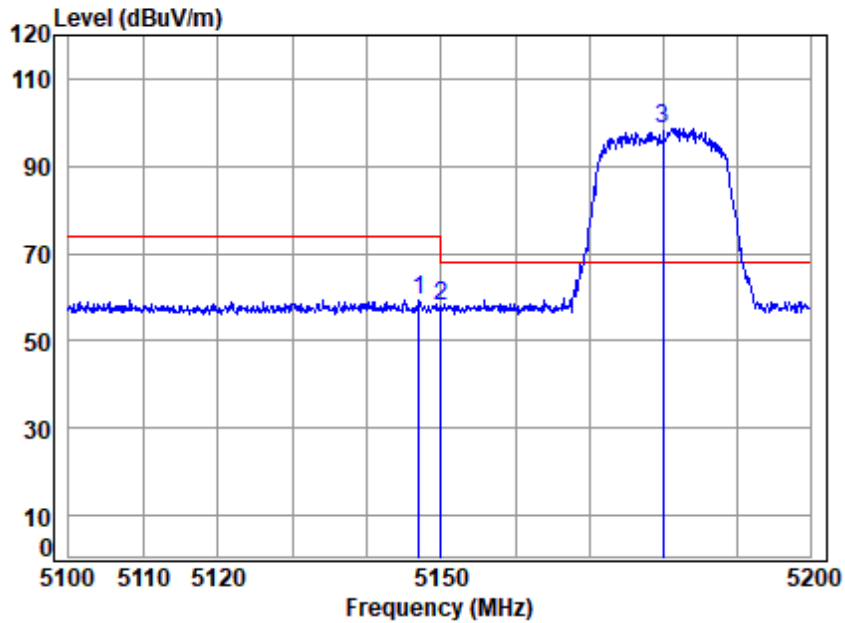

Site : chamber
 Condition: 3m HORIZONTAL
 Job No : 00028CR/00029CR
 Mode : 5180 Band edge
 : 5G WIFI 11AC20

	Freq	Cable Loss	Ant Factor	Preamp Factor	Read Level	Limit Level	Over Limit	Remark
	MHz	dB	dB/m	dB	dBuV	dBuV/m	dBuV/m	dB
1	5146.958	7.57	34.32	42.32	59.95	59.52	74.00	-14.48 peak
2	5149.980	7.57	34.32	42.32	58.24	57.81	74.00	-16.19 peak
3 *	5180.000	7.63	34.35	42.32	98.99	98.65	68.20	30.45 peak



Unless otherwise agreed in writing, this document is issued by the Company subject to its General Conditions of Service printed overleaf, available on request or accessible at <http://www.sgs.com/en/Terms-and-Conditions.aspx> and, for electronic format documents, subject to Terms and Conditions for Electronic Documents at <http://www.sgs.com/en/Terms-and-Conditions/Terms-e-Documents.aspx>. Attention is drawn to the limitation of liability, indemnification and jurisdiction issues defined therein. Any holder of this document is advised that information contained hereon reflects the Company's findings at the time of its intervention only and within the limits of Client's instructions, if any. The Company's sole responsibility is to its Client and this document does not exonerate parties to a transaction from exercising all their rights and obligations under the transaction documents. This document cannot be reproduced except in full, without prior written approval of the Company. Any unauthorized alteration, forgery or falsification of the content or appearance of this document is unlawful and offenders may be prosecuted to the fullest extent of the law. Unless otherwise stated the results shown in this test report refer only to the sample(s) tested and such sample(s) are retained for 30 days only.
 Attention: To check the authenticity of testing /inspection report & certificate, please contact us at telephone: (86-755) 8307 1443, or email: CN.Doccheck@sgs.com

Test Mode: 02; Polarity: Horizontal; Modulation:802.11ac; Bandwidth:20MHz; Channel:Low

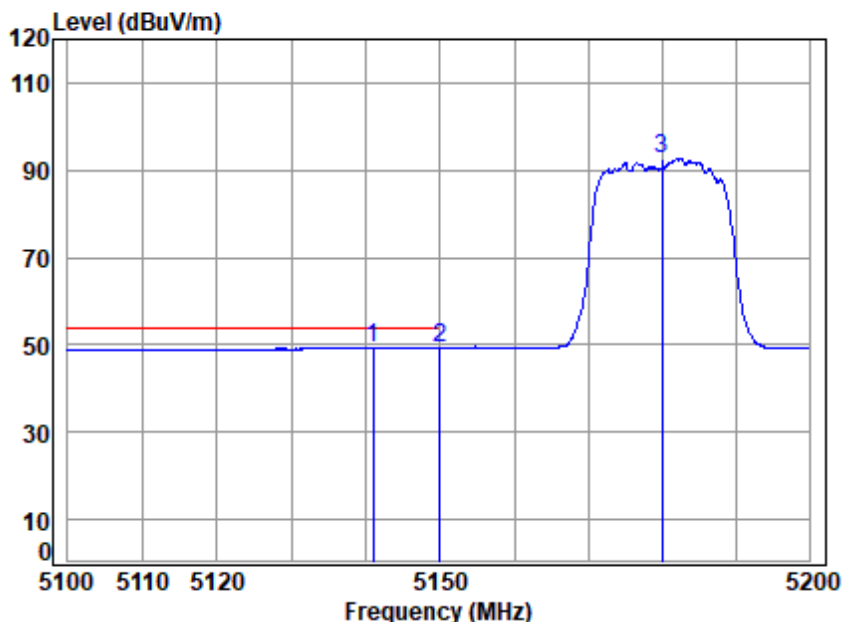

Site : chamber
 Condition: 3m HORIZONTAL
 Job No : 00028CR/00029CR
 Mode : 5180 Band edge
 : 5G WIFI 11AC20

	Freq	Cable Loss	Ant Factor	Preamp Factor	Read Level	Limit Level	Over Limit	Remark
	MHz	dB	dB/m	dB	dBuV	dBuV/m	dBuV/m	dB
1	5140.965	7.56	34.32	42.32	49.82	49.38	54.00	-4.62 Average
2	5149.980	7.57	34.32	42.32	49.69	49.26	54.00	-4.74 Average
3	5180.000	7.63	34.35	42.32	93.16	92.82	-----	----- Average



Unless otherwise agreed in writing, this document is issued by the Company subject to its General Conditions of Service printed overleaf, available on request or accessible at <http://www.sgs.com/en/Terms-and-Conditions.aspx> and, for electronic format documents, subject to Terms and Conditions for Electronic Documents at <http://www.sgs.com/en/Terms-and-Conditions/Terms-e-Documents.aspx>. Attention is drawn to the limitation of liability, indemnification and jurisdiction issues defined therein. Any holder of this document is advised that information contained hereon reflects the Company's findings at the time of its intervention only and within the limits of Client's instructions, if any. The Company's sole responsibility is to its Client and this document does not exonerate parties to a transaction from exercising all their rights and obligations under the transaction documents. This document cannot be reproduced except in full, without prior written approval of the Company. Any unauthorized alteration, forgery or falsification of the content or appearance of this document is unlawful and offenders may be prosecuted to the fullest extent of the law. Unless otherwise stated the results shown in this test report refer only to the sample(s) tested and such sample(s) are retained for 30 days only.
 Attention: To check the authenticity of testing /inspection report & certificate, please contact us at telephone: (86-755) 8307 1443, or email: CN.Doccheck@sgs.com

Test Mode: 02; Polarity: Vertical; Modulation:802.11ac; Bandwidth:20MHz; Channel:Low

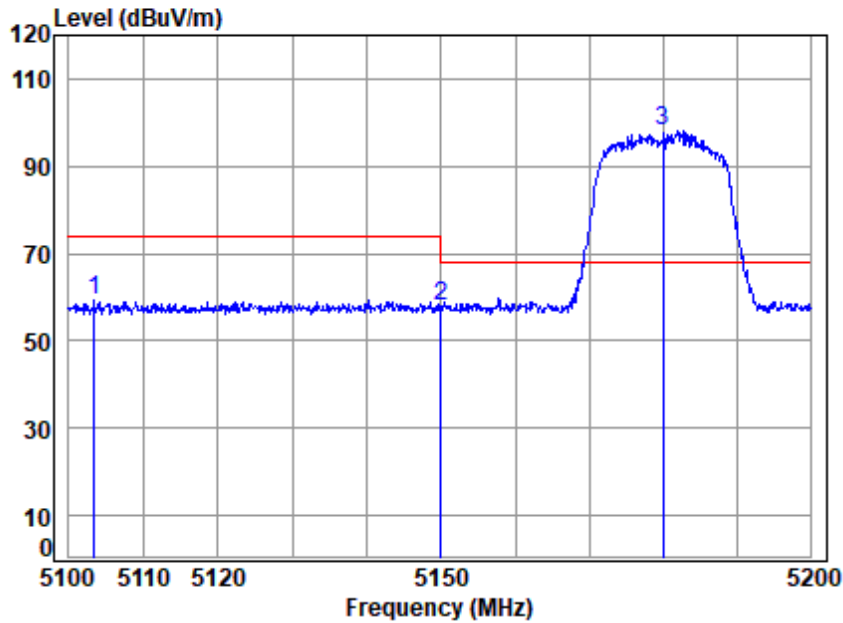

Site : chamber
 Condition: 3m VERTICAL
 Job No : 00028CR/00029CR
 Mode : 5180 Band edge
 : 5G WIFI 11AC20

	Freq	Cable Loss	Ant Factor	Preamp Factor	Read Level	Level	Limit Line	Over Limit	Remark
	MHz	dB	dB/m	dB	dBuV	dBuV/m	dBuV/m	dB	
1	5103.368	7.49	34.29	42.31	59.81	59.28	74.00	-14.72	Peak
2	5149.980	7.57	34.32	42.32	58.47	58.04	74.00	-15.96	Peak
3 *	5180.000	7.63	34.35	42.32	98.62	98.28	68.20	30.08	Peak



Unless otherwise agreed in writing, this document is issued by the Company subject to its General Conditions of Service printed overleaf, available on request or accessible at <http://www.sgs.com/en/Terms-and-Conditions.aspx> and, for electronic format documents, subject to Terms and Conditions for Electronic Documents at <http://www.sgs.com/en/Terms-and-Conditions/Terms-e-Documents.aspx>. Attention is drawn to the limitation of liability, indemnification and jurisdiction issues defined therein. Any holder of this document is advised that information contained hereon reflects the Company's findings at the time of its intervention only and within the limits of Client's instructions, if any. The Company's sole responsibility is to its Client and this document does not exonerate parties to a transaction from exercising all their rights and obligations under the transaction documents. This document cannot be reproduced except in full, without prior written approval of the Company. Any unauthorized alteration, forgery or falsification of the content or appearance of this document is unlawful and offenders may be prosecuted to the fullest extent of the law. Unless otherwise stated the results shown in this test report refer only to the sample(s) tested and such sample(s) are retained for 30 days only.
 Attention: To check the authenticity of testing /inspection report & certificate, please contact us at telephone: (86-755) 8307 1443, or email: CN.Doccheck@sgs.com

Test Mode: 02; Polarity: Vertical; Modulation:802.11ac; Bandwidth:20MHz; Channel:Low

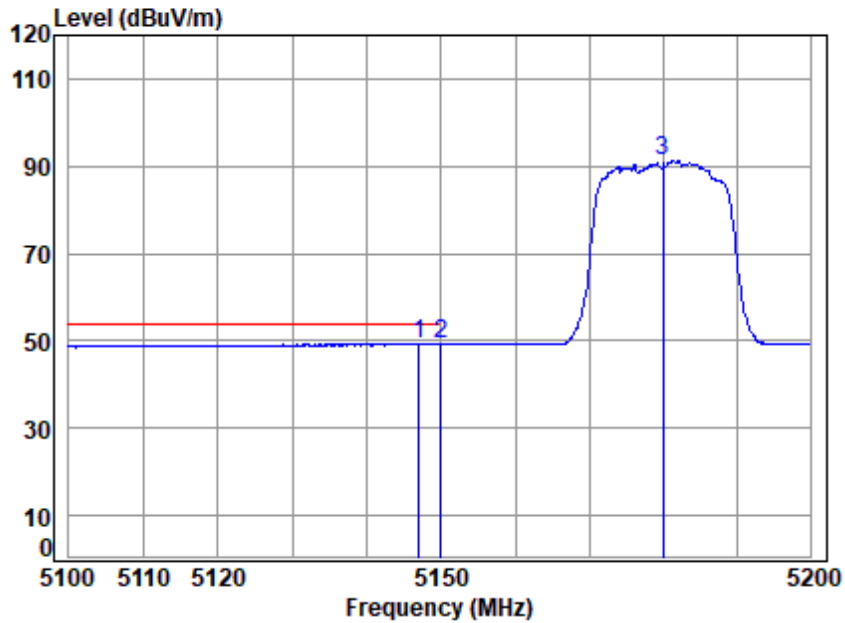

Site : chamber
 Condition: 3m VERTICAL
 Job No : 00028CR/00029CR
 Mode : 5180 Band edge
 : 5G WIFI 11AC20

	Freq	Cable Loss	Ant Factor	Preamp Factor	Read Level	Limit Level	Over Limit	Remark
	MHz	dB	dB/m	dB	dBuV	dBuV/m	dBuV/m	dB
1	5147.058	7.57	34.32	42.32	49.73	49.30	54.00	-4.70 Average
2	5149.980	7.57	34.32	42.32	49.63	49.20	54.00	-4.80 Average
3	5180.000	7.63	34.35	42.32	91.54	91.20	-----	----- Average



Unless otherwise agreed in writing, this document is issued by the Company subject to its General Conditions of Service printed overleaf, available on request or accessible at <http://www.sgs.com/en/Terms-and-Conditions.aspx> and, for electronic format documents, subject to Terms and Conditions for Electronic Documents at <http://www.sgs.com/en/Terms-and-Conditions/Terms-e-Documents.aspx>. Attention is drawn to the limitation of liability, indemnification and jurisdiction issues defined therein. Any holder of this document is advised that information contained hereon reflects the Company's findings at the time of its intervention only and within the limits of Client's instructions, if any. The Company's sole responsibility is to its Client and this document does not exonerate parties to a transaction from exercising all their rights and obligations under the transaction documents. This document cannot be reproduced except in full, without prior written approval of the Company. Any unauthorized alteration, forgery or falsification of the content or appearance of this document is unlawful and offenders may be prosecuted to the fullest extent of the law. Unless otherwise stated the results shown in this test report refer only to the sample(s) tested and such sample(s) are retained for 30 days only.
 Attention: To check the authenticity of testing / inspection report & certificate, please contact us at telephone: (86-755) 8307 1443, or email: CN.Doccheck@sgs.com

Test Mode: 02; Polarity: Horizontal; Modulation:802.11ac; Bandwidth:20MHz; Channel:High

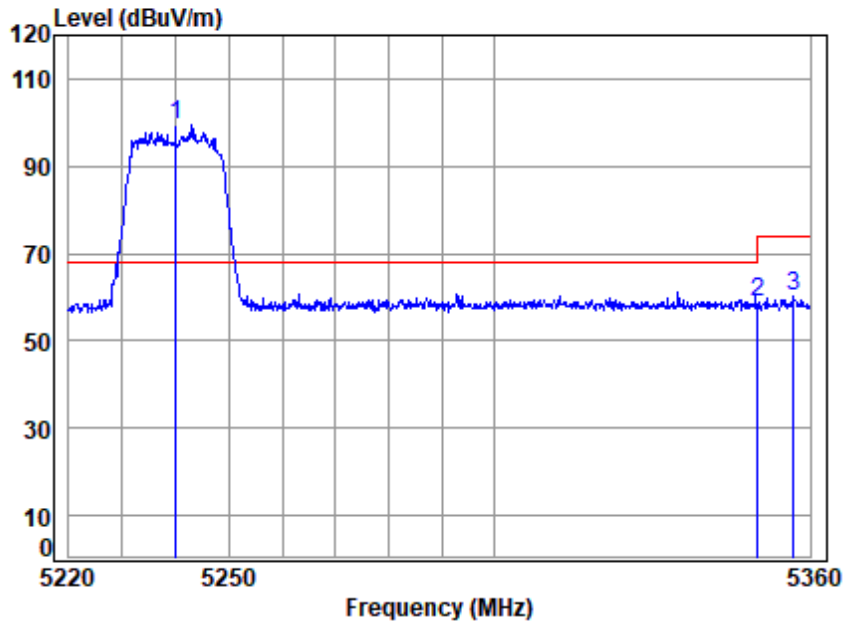

Site : chamber
 Condition: 3m HORIZONTAL
 Job No : 00028CR/00029CR
 Mode : 5240 Band edge
 : 5G WIFI 11AC20

	Cable	Ant	Preamp	Read	Limit	Over	
Freq	Loss	Factor	Factor	Level	Level	Line	Limit Remark
MHz	dB	dB/m	dB	dBuV	dBuV/m	dBuV/m	dB
1 * 5240.000	7.73	34.40	42.33	99.56	99.36	68.20	31.16 peak
2 5350.020	7.92	34.48	42.34	58.71	58.77	74.00	-15.23 peak
3 5356.880	7.94	34.49	42.34	59.95	60.04	74.00	-13.96 peak



Test Mode: 02; Polarity: Horizontal; Modulation:802.11ac; Bandwidth:20MHz; Channel:High

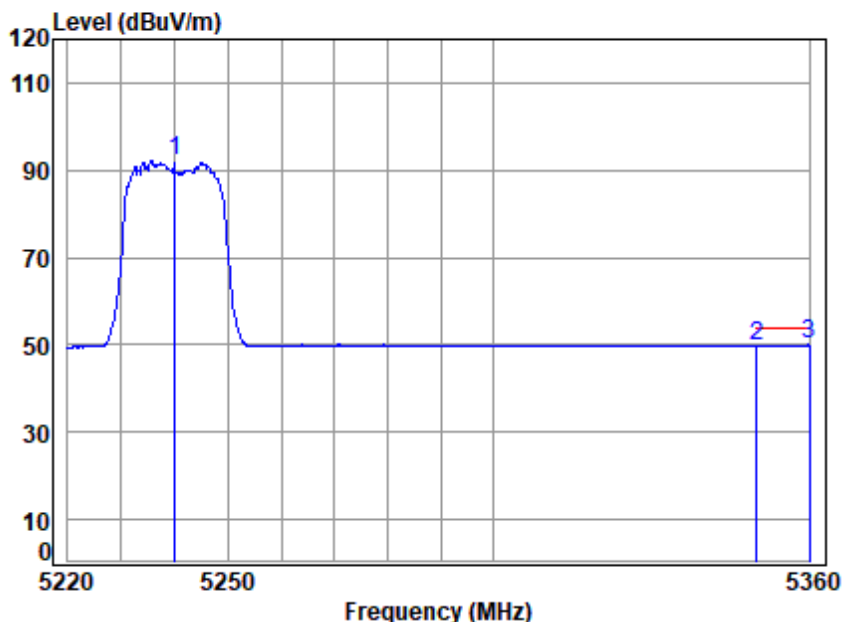

Site : chamber
 Condition: 3m HORIZONTAL
 Job No : 00028CR/00029CR
 Mode : 5240 Band edge
 : 5G WIFI 11AC20

	Freq	Cable Loss	Ant Factor	Preamp Factor	Read Level	Limit Level	Over Line	Remark
	MHz	dB	dB/m	dB	dBuV	dBuV/m	dBuV/m	dB
1	5240.000	7.73	34.40	42.33	92.38	92.18	-----	Average
2	5350.020	7.92	34.48	42.34	49.85	49.91	54.00	-4.09 Average
3	5360.000	7.94	34.49	42.34	49.95	50.04	54.00	-3.96 Average



Unless otherwise agreed in writing, this document is issued by the Company subject to its General Conditions of Service printed overleaf, available on request or accessible at <http://www.sgs.com/en/Terms-and-Conditions.aspx> and, for electronic format documents, subject to Terms and Conditions for Electronic Documents at <http://www.sgs.com/en/Terms-and-Conditions/Terms-e-Documents.aspx>. Attention is drawn to the limitation of liability, indemnification and jurisdiction issues defined therein. Any holder of this document is advised that information contained hereon reflects the Company's findings at the time of its intervention only and within the limits of Client's instructions, if any. The Company's sole responsibility is to its Client and this document does not exonerate parties to a transaction from exercising all their rights and obligations under the transaction documents. This document cannot be reproduced except in full, without prior written approval of the Company. Any unauthorized alteration, forgery or falsification of the content or appearance of this document is unlawful and offenders may be prosecuted to the fullest extent of the law. Unless otherwise stated the results shown in this test report refer only to the sample(s) tested and such sample(s) are retained for 30 days only.
 Attention: To check the authenticity of testing /inspection report & certificate, please contact us at telephone: (86-755) 8307 1443, or email: CN.Doccheck@sgs.com

Test Mode: 02; Polarity: Vertical; Modulation:802.11ac; Bandwidth:20MHz; Channel:High

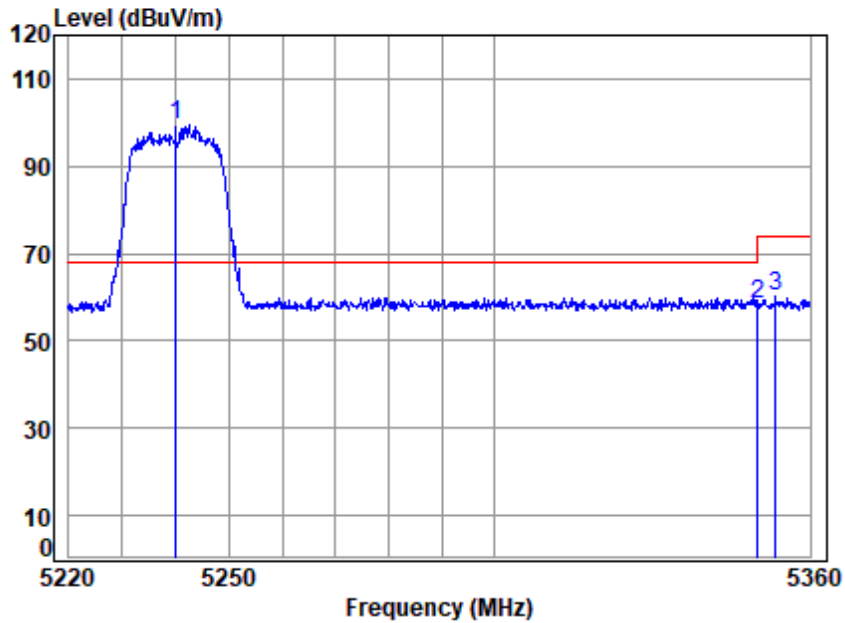

Site : chamber
 Condition: 3m VERTICAL
 Job No : 00028CR/00029CR
 Mode : 5240 Band edge
 : 5G WIFI 11AC20

Freq	Cable Loss	Ant Factor	Preamp Factor	Read Level	Limit Level	Limit Line	Over Limit	Remark
MHz	dB	dB/m	dB	dBuV	dBuV/m	dBuV/m	dB	
1 * 5240.000	7.73	34.40	42.33	99.89	99.69	68.20	31.49	Peak
2 5350.020	7.92	34.48	42.34	58.37	58.43	74.00	-15.57	Peak
3 5353.479	7.93	34.49	42.34	60.29	60.37	74.00	-13.63	Peak



Unless otherwise agreed in writing, this document is issued by the Company subject to its General Conditions of Service printed overleaf, available on request or accessible at <http://www.sgs.com/en/Terms-and-Conditions.aspx> and, for electronic format documents, subject to Terms and Conditions for Electronic Documents at <http://www.sgs.com/en/Terms-and-Conditions/Terms-e-Documents.aspx>. Attention is drawn to the limitation of liability, indemnification and jurisdiction issues defined therein. Any holder of this document is advised that information contained hereon reflects the Company's findings at the time of its intervention only and within the limits of Client's instructions, if any. The Company's sole responsibility is to its Client and this document does not exonerate parties to a transaction from exercising all their rights and obligations under the transaction documents. This document cannot be reproduced except in full, without prior written approval of the Company. Any unauthorized alteration, forgery or falsification of the content or appearance of this document is unlawful and offenders may be prosecuted to the fullest extent of the law. Unless otherwise stated the results shown in this test report refer only to the sample(s) tested and such sample(s) are retained for 30 days only.
 Attention: To check the authenticity of testing / inspection report & certificate, please contact us at telephone: (86-755) 8307 1443, or email: CN.Doccheck@sgs.com

Test Mode: 02; Polarity: Vertical; Modulation:802.11ac; Bandwidth:20MHz; Channel:High

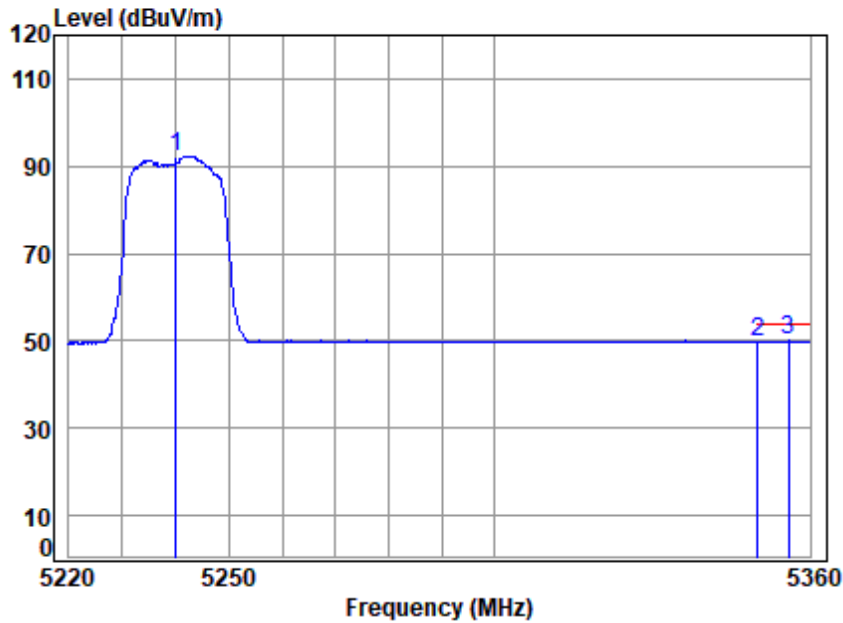

Site : chamber
 Condition: 3m VERTICAL
 Job No : 00028CR/00029CR
 Mode : 5240 Band edge
 : 5G WIFI 11AC20

	Freq	Cable Loss	Ant Factor	Preamp Factor	Read Level	Limit Level	Over Line	Over Limit	Remark
	MHz	dB	dB/m	dB	dBuV	dBuV/m	dBuV/m	dB	
1	5240.000	7.73	34.40	42.33	92.44	92.24	-----	-----	Average
2	5350.020	7.92	34.48	42.34	49.75	49.81	54.00	-4.19	Average
3	5355.888	7.93	34.49	42.34	49.96	50.04	54.00	-3.96	Average



Unless otherwise agreed in writing, this document is issued by the Company subject to its General Conditions of Service printed overleaf, available on request or accessible at <http://www.sgs.com/en/Terms-and-Conditions.aspx> and, for electronic format documents, subject to Terms and Conditions for Electronic Documents at <http://www.sgs.com/en/Terms-and-Conditions/Terms-e-Documents.aspx>. Attention is drawn to the limitation of liability, indemnification and jurisdiction issues defined therein. Any holder of this document is advised that information contained hereon reflects the Company's findings at the time of its intervention only and within the limits of Client's instructions, if any. The Company's sole responsibility is to its Client and this document does not exonerate parties to a transaction from exercising all their rights and obligations under the transaction documents. This document cannot be reproduced except in full, without prior written approval of the Company. Any unauthorized alteration, forgery or falsification of the content or appearance of this document is unlawful and offenders may be prosecuted to the fullest extent of the law. Unless otherwise stated the results shown in this test report refer only to the sample(s) tested and such sample(s) are retained for 30 days only.
 Attention: To check the authenticity of testing / inspection report & certificate, please contact us at telephone: (86-755) 8307 1443, or email: CN.Doccheck@sgs.com

Test Mode: 02; Polarity: Horizontal; Modulation:802.11ac; Bandwidth:40MHz; Channel:Low

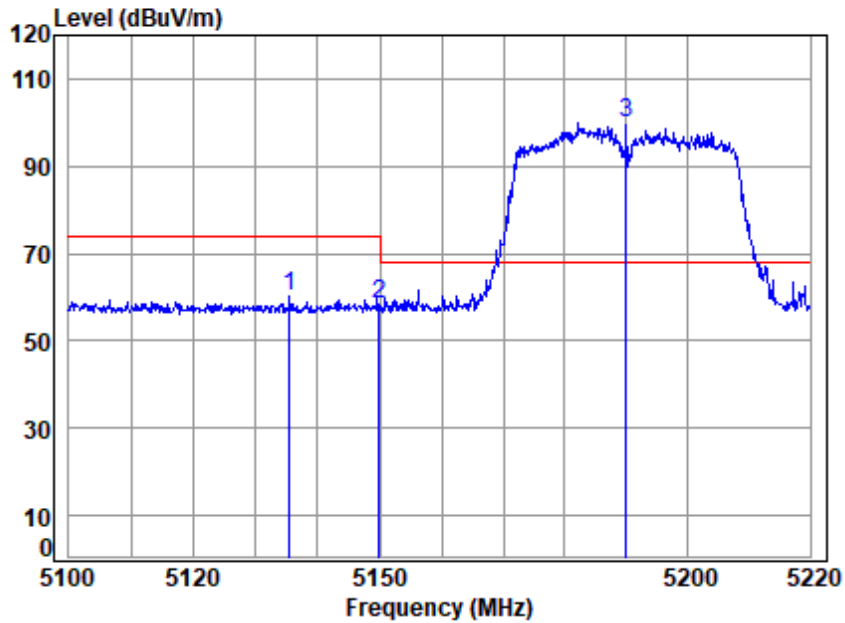

Site : chamber
 Condition: 3m HORIZONTAL
 Job No : 00028CR/00029CR
 Mode : 5190 Band edge
 : 5G WIFI 11AC40

	Cable	Ant	Preamp	Read	Limit	Over	
Freq	Loss	Factor	Factor	Level	Level	Line	Limit Remark
MHz	dB	dB/m	dB	dBuV	dBuV/m	dBuV/m	dB
1	5135.469	7.55	34.31	42.31	60.81	60.36	74.00 -13.64 peak
2	5149.980	7.57	34.32	42.32	58.76	58.33	74.00 -15.67 peak
3 *	5190.000	7.64	34.36	42.32	100.04	99.72	68.20 31.52 peak



Unless otherwise agreed in writing, this document is issued by the Company subject to its General Conditions of Service printed overleaf, available on request or accessible at <http://www.sgs.com/en/Terms-and-Conditions.aspx> and, for electronic format documents, subject to Terms and Conditions for Electronic Documents at <http://www.sgs.com/en/Terms-and-Conditions/Terms-e-Documents.aspx>. Attention is drawn to the limitation of liability, indemnification and jurisdiction issues defined therein. Any holder of this document is advised that information contained hereon reflects the Company's findings at the time of its intervention only and within the limits of Client's instructions, if any. The Company's sole responsibility is to its Client and this document does not exonerate parties to a transaction from exercising all their rights and obligations under the transaction documents. This document cannot be reproduced except in full, without prior written approval of the Company. Any unauthorized alteration, forgery or falsification of the content or appearance of this document is unlawful and offenders may be prosecuted to the fullest extent of the law. Unless otherwise stated the results shown in this test report refer only to the sample(s) tested and such sample(s) are retained for 30 days only.
 Attention: To check the authenticity of testing /inspection report & certificate, please contact us at telephone: (86-755) 8307 1443, or email: CN.Doccheck@sgs.com

Test Mode: 02; Polarity: Horizontal; Modulation:802.11ac; Bandwidth:40MHz; Channel:Low

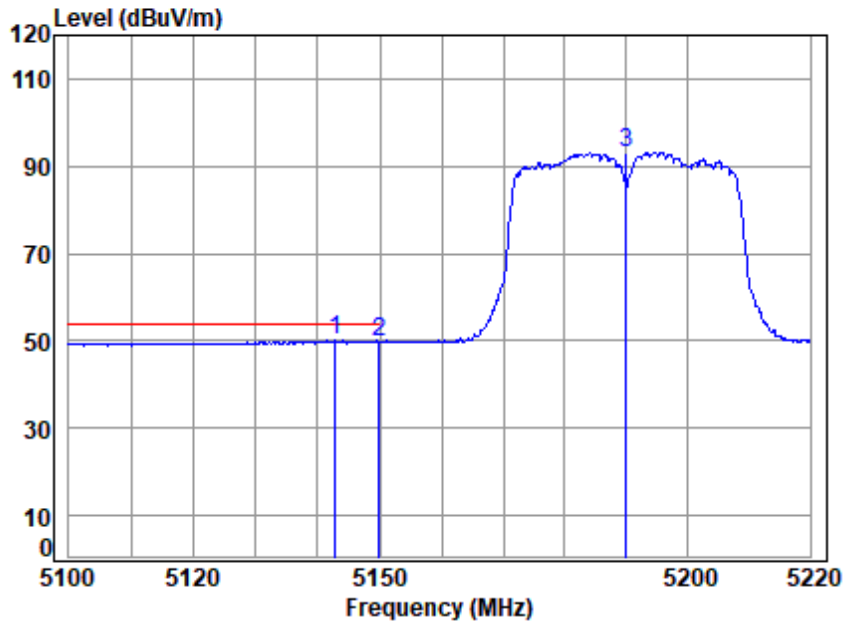

Site : chamber
 Condition: 3m HORIZONTAL
 Job No : 00028CR/00029CR
 Mode : 5190 Band edge
 : 5G WIFI 11AC40

	Freq	Cable Loss	Ant Factor	Preamp Factor	Read Level	Limit Level	Over Limit	Remark
	MHz	dB	dB/m	dB	dBuV	dBuV/m	dBuV/m	dB
1	5142.879	7.56	34.32	42.32	50.44	50.00	54.00	-4.00 Average
2	5149.980	7.57	34.32	42.32	50.27	49.84	54.00	-4.16 Average
3	5190.000	7.64	34.36	42.32	93.48	93.16	-----	----- Average



Unless otherwise agreed in writing, this document is issued by the Company subject to its General Conditions of Service printed overleaf, available on request or accessible at <http://www.sgs.com/en/Terms-and-Conditions.aspx> and, for electronic format documents, subject to Terms and Conditions for Electronic Documents at <http://www.sgs.com/en/Terms-and-Conditions/Terms-e-Documents.aspx>. Attention is drawn to the limitation of liability, indemnification and jurisdiction issues defined therein. Any holder of this document is advised that information contained hereon reflects the Company's findings at the time of its intervention only and within the limits of Client's instructions, if any. The Company's sole responsibility is to its Client and this document does not exonerate parties to a transaction from exercising all their rights and obligations under the transaction documents. This document cannot be reproduced except in full, without prior written approval of the Company. Any unauthorized alteration, forgery or falsification of the content or appearance of this document is unlawful and offenders may be prosecuted to the fullest extent of the law. Unless otherwise stated the results shown in this test report refer only to the sample(s) tested and such sample(s) are retained for 30 days only.
 Attention: To check the authenticity of testing /inspection report & certificate, please contact us at telephone: (86-755) 8307 1443, or email: CN.Doccheck@sgs.com

Test Mode: 02; Polarity: Vertical; Modulation:802.11ac; Bandwidth:40MHz; Channel:Low

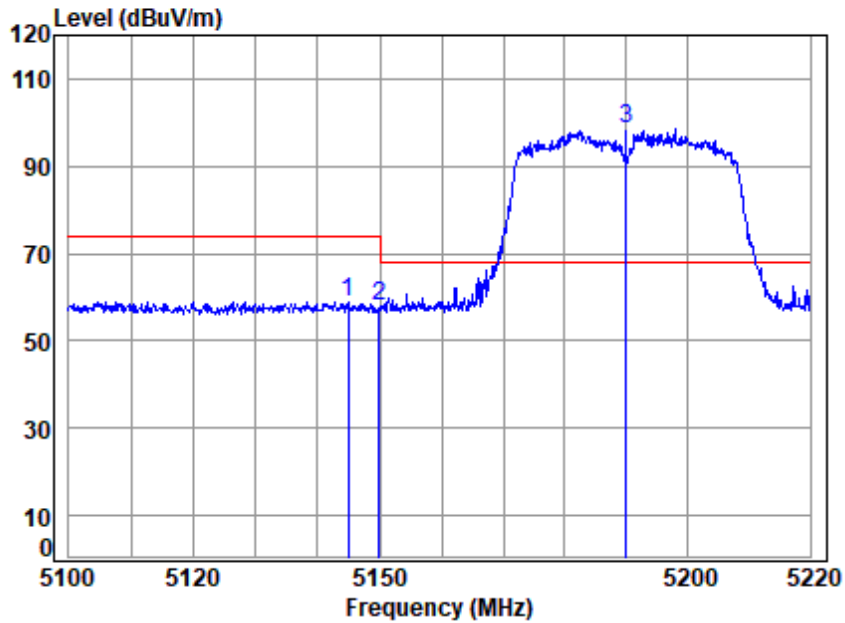

Site : chamber
 Condition: 3m VERTICAL
 Job No : 00028CR/00029CR
 Mode : 5190 Band edge
 : 5G WIFI 11AC40

	Cable	Ant	Preamp	Read	Limit	Over	
Freq	Loss	Factor	Factor	Level	Level	Line	Limit
MHz	dB	dB/m	dB	dBuV	dBuV/m	dBuV/m	dB
1	7.56	34.32	42.32	59.51	59.07	74.00	-14.93
2	7.57	34.32	42.32	58.57	58.14	74.00	-15.86
3 *	7.64	34.36	42.32	98.67	98.35	68.20	30.15



Unless otherwise agreed in writing, this document is issued by the Company subject to its General Conditions of Service printed overleaf, available on request or accessible at <http://www.sgs.com/en/Terms-and-Conditions.aspx> and, for electronic format documents, subject to Terms and Conditions for Electronic Documents at <http://www.sgs.com/en/Terms-and-Conditions/Terms-e-Documents.aspx>. Attention is drawn to the limitation of liability, indemnification and jurisdiction issues defined therein. Any holder of this document is advised that information contained hereon reflects the Company's findings at the time of its intervention only and within the limits of Client's instructions, if any. The Company's sole responsibility is to its Client and this document does not exonerate parties to a transaction from exercising all their rights and obligations under the transaction documents. This document cannot be reproduced except in full, without prior written approval of the Company. Any unauthorized alteration, forgery or falsification of the content or appearance of this document is unlawful and offenders may be prosecuted to the fullest extent of the law. Unless otherwise stated the results shown in this test report refer only to the sample(s) tested and such sample(s) are retained for 30 days only.

Test Mode: 02; Polarity: Vertical; Modulation:802.11ac; Bandwidth:40MHz; Channel:Low

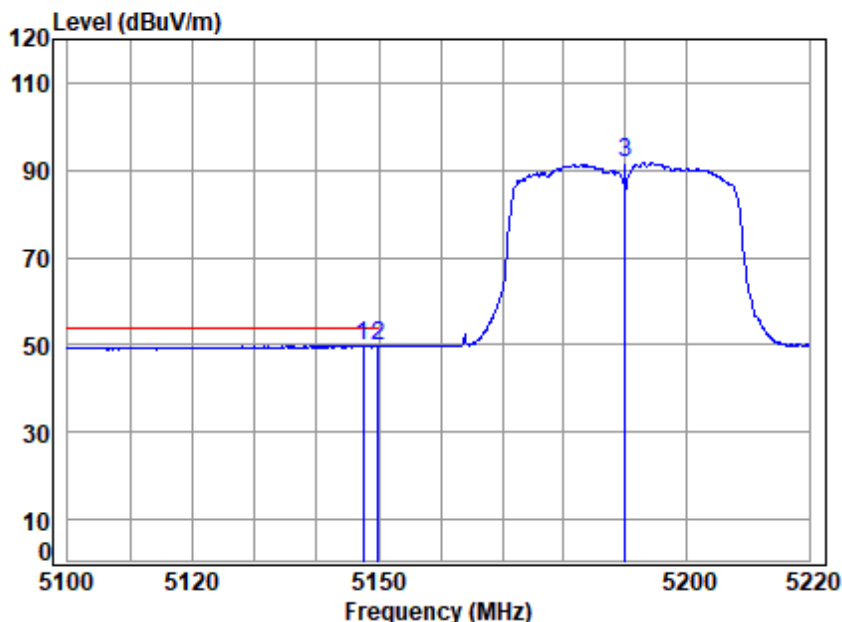

Site : chamber
 Condition: 3m VERTICAL
 Job No : 00028CR/00029CR
 Mode : 5190 Band edge
 : 5G WIFI 11AC40

	Freq	Cable Loss	Ant Factor	Preamp Factor	Read Level	Limit Level	Over Limit	Remark
	MHz	dB	dB/m	dB	dBuV	dBuV/m	dB	
1	5147.545	7.57	34.32	42.32	50.27	54.00	-4.16	Average
2	5149.980	7.57	34.32	42.32	50.13	54.00	-4.30	Average
3	5190.000	7.64	34.36	42.32	91.94	-----	-----	Average



Unless otherwise agreed in writing, this document is issued by the Company subject to its General Conditions of Service printed overleaf, available on request or accessible at <http://www.sgs.com/en/Terms-and-Conditions.aspx> and, for electronic format documents, subject to Terms and Conditions for Electronic Documents at <http://www.sgs.com/en/Terms-and-Conditions/Terms-e-Documents.aspx>. Attention is drawn to the limitation of liability, indemnification and jurisdiction issues defined therein. Any holder of this document is advised that information contained hereon reflects the Company's findings at the time of its intervention only and within the limits of Client's instructions, if any. The Company's sole responsibility is to its Client and this document does not exonerate parties to a transaction from exercising all their rights and obligations under the transaction documents. This document cannot be reproduced except in full, without prior written approval of the Company. Any unauthorized alteration, forgery or falsification of the content or appearance of this document is unlawful and offenders may be prosecuted to the fullest extent of the law. Unless otherwise stated the results shown in this test report refer only to the sample(s) tested and such sample(s) are retained for 30 days only.
 Attention: To check the authenticity of testing /inspection report & certificate, please contact us at telephone: (86-755) 8307 1443, or email: CN.Doccheck@sgs.com

Test Mode: 02; Polarity: Horizontal; Modulation:802.11ac; Bandwidth:40MHz; Channel:High

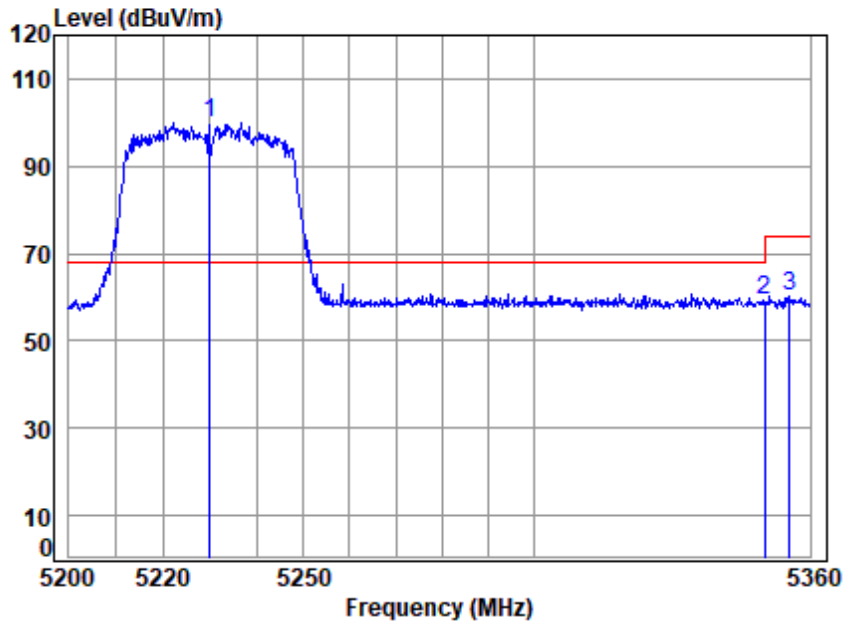

Site : chamber
 Condition: 3m HORIZONTAL
 Job No : 00028CR/00029CR
 Mode : 5230 Band edge
 : 5G WIFI 11AC40

Freq	Cable Loss	Ant Factor	Preamp Factor	Read Level	Limit Level	Over Limit	Remark
MHz	dB	dB/m	dB	dBuV	dBuV/m	dBuV/m	dB
1 * 5230.000	7.72	34.39	42.32	100.04	99.83	68.20	31.63 peak
2 5350.020	7.92	34.48	42.34	59.27	59.33	74.00	-14.67 peak
3 5355.454	7.93	34.49	42.34	60.06	60.14	74.00	-13.86 peak



Unless otherwise agreed in writing, this document is issued by the Company subject to its General Conditions of Service printed overleaf, available on request or accessible at <http://www.sgs.com/en/Terms-and-Conditions.aspx> and, for electronic format documents, subject to Terms and Conditions for Electronic Documents at <http://www.sgs.com/en/Terms-and-Conditions/Terms-e-Documents.aspx>. Attention is drawn to the limitation of liability, indemnification and jurisdiction issues defined therein. Any holder of this document is advised that information contained hereon reflects the Company's findings at the time of its intervention only and within the limits of Client's instructions, if any. The Company's sole responsibility is to its Client and this document does not exonerate parties to a transaction from exercising all their rights and obligations under the transaction documents. This document cannot be reproduced except in full, without prior written approval of the Company. Any unauthorized alteration, forgery or falsification of the content or appearance of this document is unlawful and offenders may be prosecuted to the fullest extent of the law. Unless otherwise stated the results shown in this test report refer only to the sample(s) tested and such sample(s) are retained for 30 days only.
 Attention: To check the authenticity of testing /inspection report & certificate, please contact us at telephone: (86-755) 8307 1443, or email: CN.Doccheck@sgs.com

Test Mode: 02; Polarity: Horizontal; Modulation:802.11ac; Bandwidth:40MHz; Channel:High

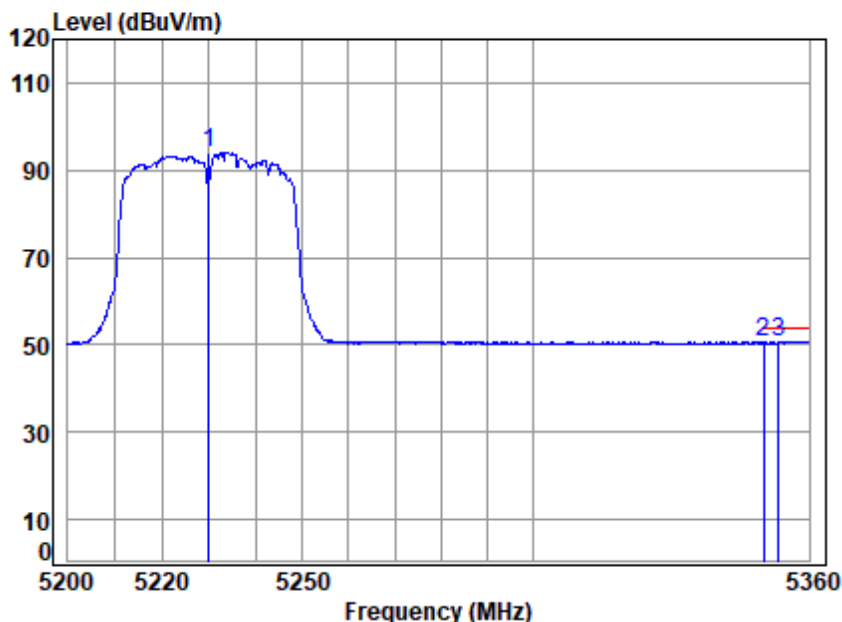

Site : chamber
 Condition: 3m HORIZONTAL
 Job No : 00028CR/00029CR
 Mode : 5230 Band edge
 : 5G WIFI 11AC40

	Freq	Cable Loss	Ant Factor	Preamp Factor	Read Level	Limit Level	Over Limit	Remark
	MHz	dB	dB/m	dB	dBuV	dBuV/m	dBuV/m	dB
1	5230.000	7.72	34.39	42.32	94.18	93.97	-----	Average
2	5350.020	7.92	34.48	42.34	50.46	50.52	54.00	-3.48 Average
3	5353.344	7.93	34.49	42.34	50.58	50.66	54.00	-3.34 Average



Unless otherwise agreed in writing, this document is issued by the Company subject to its General Conditions of Service printed overleaf, available on request or accessible at <http://www.sgs.com/en/Terms-and-Conditions.aspx> and, for electronic format documents, subject to Terms and Conditions for Electronic Documents at <http://www.sgs.com/en/Terms-and-Conditions/Terms-e-Documents.aspx>. Attention is drawn to the limitation of liability, indemnification and jurisdiction issues defined therein. Any holder of this document is advised that information contained hereon reflects the Company's findings at the time of its intervention only and within the limits of Client's instructions, if any. The Company's sole responsibility is to its Client and this document does not exonerate parties to a transaction from exercising all their rights and obligations under the transaction documents. This document cannot be reproduced except in full, without prior written approval of the Company. Any unauthorized alteration, forgery or falsification of the content or appearance of this document is unlawful and offenders may be prosecuted to the fullest extent of the law. Unless otherwise stated the results shown in this test report refer only to the sample(s) tested and such sample(s) are retained for 30 days only.
 Attention: To check the authenticity of testing / inspection report & certificate, please contact us at telephone: (86-755) 8307 1443, or email: CN.Doccheck@sgs.com

Test Mode: 02; Polarity: Vertical; Modulation:802.11ac; Bandwidth:40MHz; Channel:High

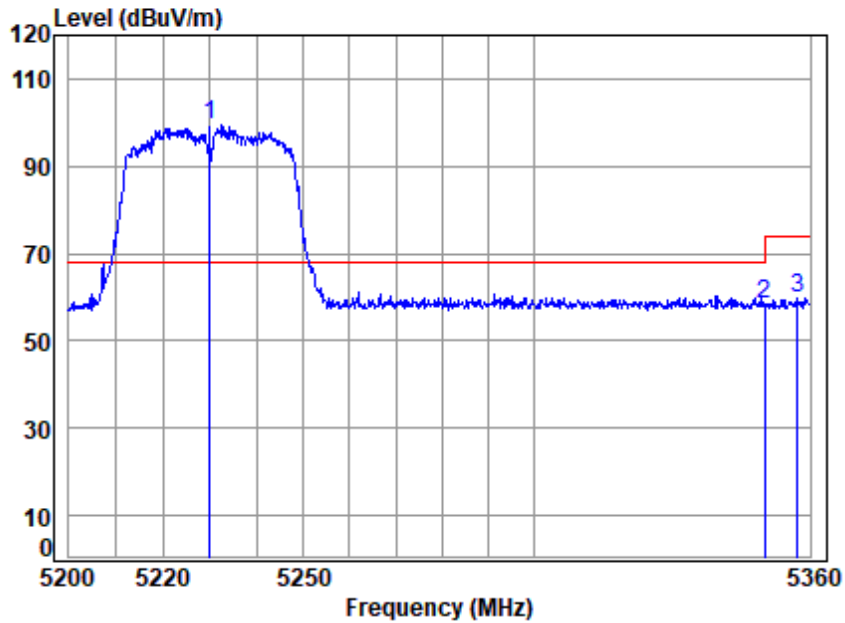

Site : chamber
 Condition: 3m VERTICAL
 Job No : 00028CR/00029CR
 Mode : 5230 Band edge
 : 5G WIFI 11AC40

Freq	Cable Loss	Ant Factor	Preamp Factor	Read Level	Limit Level	Over Line	Remark
MHz	dB	dB/m	dB	dBuV	dBuV/m	dBuV/m	dB
1 * 5230.000	7.72	34.39	42.32	99.83	99.62	68.20	31.42 Peak
2 5350.020	7.92	34.48	42.34	58.44	58.50	74.00	-15.50 Peak
3 5357.239	7.94	34.49	42.34	59.60	59.69	74.00	-14.31 Peak



Unless otherwise agreed in writing, this document is issued by the Company subject to its General Conditions of Service printed overleaf, available on request or accessible at <http://www.sgs.com/en/Terms-and-Conditions.aspx> and, for electronic format documents, subject to Terms and Conditions for Electronic Documents at <http://www.sgs.com/en/Terms-and-Conditions/Terms-e-Documents.aspx>. Attention is drawn to the limitation of liability, indemnification and jurisdiction issues defined therein. Any holder of this document is advised that information contained hereon reflects the Company's findings at the time of its intervention only and within the limits of Client's instructions, if any. The Company's sole responsibility is to its Client and this document does not exonerate parties to a transaction from exercising all their rights and obligations under the transaction documents. This document cannot be reproduced except in full, without prior written approval of the Company. Any unauthorized alteration, forgery or falsification of the content or appearance of this document is unlawful and offenders may be prosecuted to the fullest extent of the law. Unless otherwise stated the results shown in this test report refer only to the sample(s) tested and such sample(s) are retained for 30 days only.
 Attention: To check the authenticity of testing / inspection report & certificate, please contact us at telephone: (86-755) 8307 1443, or email: CN.Doccheck@sgs.com

Test Mode: 02; Polarity: Vertical; Modulation:802.11ac; Bandwidth:40MHz; Channel:High

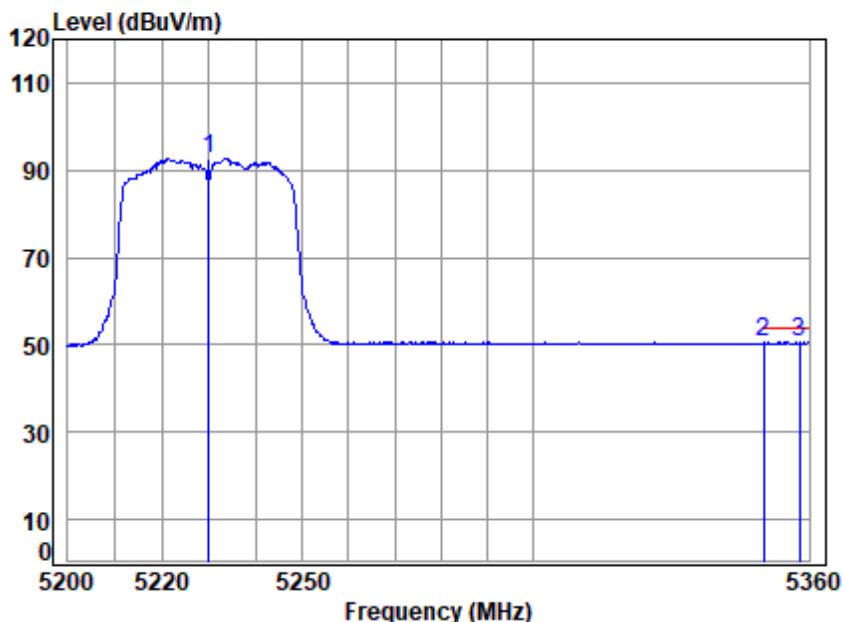

Site : chamber
 Condition: 3m VERTICAL
 Job No : 00028CR/00029CR
 Mode : 5230 Band edge
 : 5G WIFI 11AC40

	Freq	Cable Loss	Ant Factor	Preamp Factor	Read Level	Limit Level	Over Line	Over Limit	Remark
	MHz	dB	dB/m	dB	dBuV	dBuV/m	dBuV/m	dB	
1	5230.000	7.72	34.39	42.32	92.88	92.67	-----	-----	Average
2	5350.020	7.92	34.48	42.34	50.40	50.46	54.00	-3.54	Average
3	5357.889	7.94	34.49	42.34	50.44	50.53	54.00	-3.47	Average



Unless otherwise agreed in writing, this document is issued by the Company subject to its General Conditions of Service printed overleaf, available on request or accessible at <http://www.sgs.com/en/Terms-and-Conditions.aspx> and, for electronic format documents, subject to Terms and Conditions for Electronic Documents at <http://www.sgs.com/en/Terms-and-Conditions/Terms-e-Documents.aspx>. Attention is drawn to the limitation of liability, indemnification and jurisdiction issues defined therein. Any holder of this document is advised that information contained hereon reflects the Company's findings at the time of its intervention only and within the limits of Client's instructions, if any. The Company's sole responsibility is to its Client and this document does not exonerate parties to a transaction from exercising all their rights and obligations under the transaction documents. This document cannot be reproduced except in full, without prior written approval of the Company. Any unauthorized alteration, forgery or falsification of the content or appearance of this document is unlawful and offenders may be prosecuted to the fullest extent of the law. Unless otherwise stated the results shown in this test report refer only to the sample(s) tested and such sample(s) are retained for 30 days only.
 Attention: To check the authenticity of testing / inspection report & certificate, please contact us at telephone: (86-755) 8307 1443, or email: CN.Doccheck@sgs.com

Test Mode: 02; Polarity: Horizontal; Modulation:802.11ac; Bandwidth:80MHz; Channel:middle

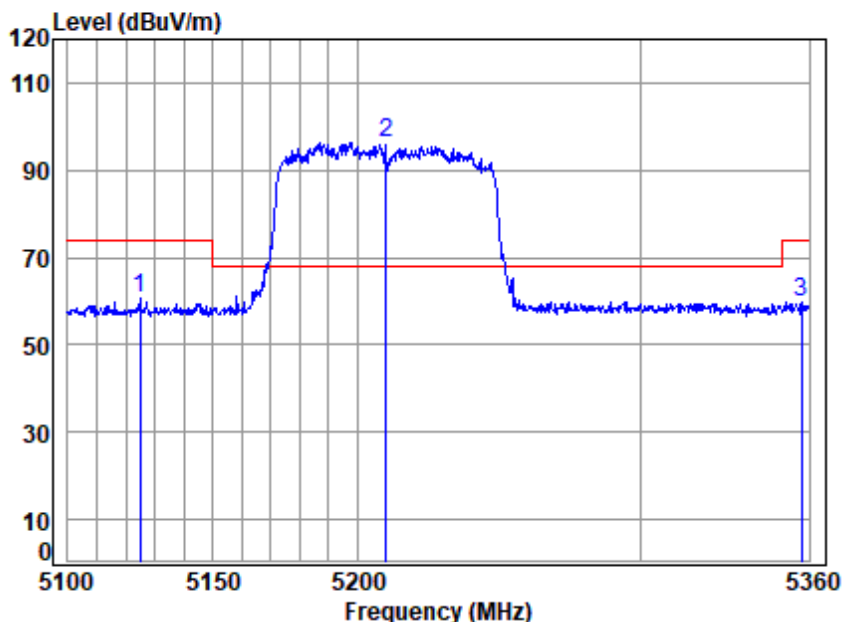

Site : chamber
 Condition: 3m HORIZONTAL
 Job No : 00028CR/00029CR
 Mode : 5210 Band edge
 : 5G WIFI 11AC80

	Freq	Cable Loss	Ant Factor	Preamp Factor	Read Level	Limit Level	Over Limit	Remark
	MHz	dB	dB/m	dB	dBuV	dBuV/m	dBuV/m	dB
1	5124.913	7.53	34.30	42.31	61.39	60.91	74.00	-13.09 peak
2 *	5210.000	7.68	34.37	42.32	96.43	96.16	68.20	27.96 peak
3	5357.335	7.94	34.49	42.34	59.91	60.00	74.00	-14.00 peak



Unless otherwise agreed in writing, this document is issued by the Company subject to its General Conditions of Service printed overleaf, available on request or accessible at <http://www.sgs.com/en/Terms-and-Conditions.aspx> and, for electronic format documents, subject to Terms and Conditions for Electronic Documents at <http://www.sgs.com/en/Terms-and-Conditions/Terms-e-Documents.aspx>. Attention is drawn to the limitation of liability, indemnification and jurisdiction issues defined therein. Any holder of this document is advised that information contained hereon reflects the Company's findings at the time of its intervention only and within the limits of Client's instructions, if any. The Company's sole responsibility is to its Client and this document does not exonerate parties to a transaction from exercising all their rights and obligations under the transaction documents. This document cannot be reproduced except in full, without prior written approval of the Company. Any unauthorized alteration, forgery or falsification of the content or appearance of this document is unlawful and offenders may be prosecuted to the fullest extent of the law. Unless otherwise stated the results shown in this test report refer only to the sample(s) tested and such sample(s) are retained for 30 days only.
 Attention: To check the authenticity of testing / inspection report & certificate, please contact us at telephone: (86-755) 8307 1443, or email: CN.Doccheck@sgs.com

Test Mode: 02; Polarity: Horizontal; Modulation:802.11ac; Bandwidth:80MHz; Channel:middle

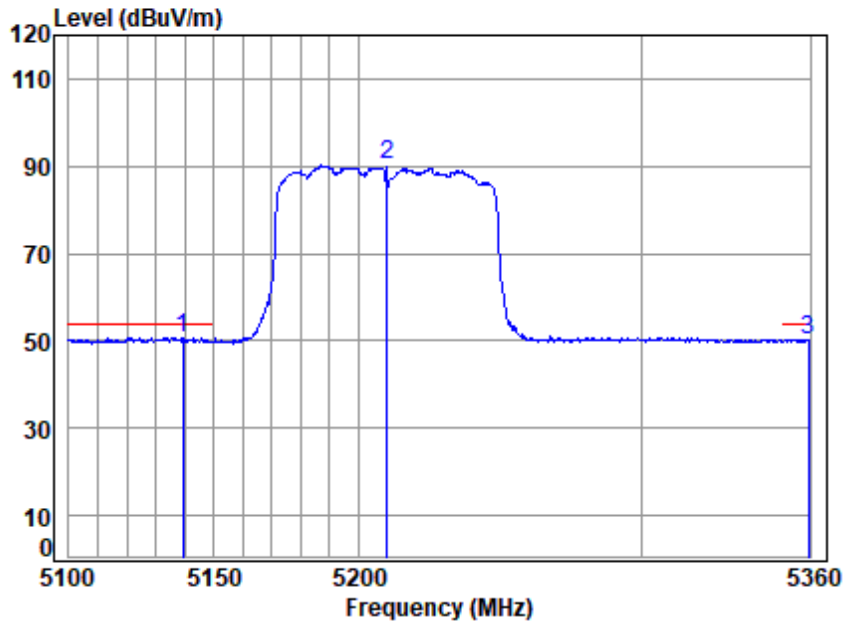

Site : chamber
 Condition: 3m HORIZONTAL
 Job No : 00028CR/00029CR
 Mode : 5210 Band edge
 : 5G WIFI 11AC80

	Freq	Cable Loss	Ant Factor	Preamp Factor	Read Level	Limit Level	Over Line	Remark
	MHz	dB	dB/m	dB	dBuV	dBuV/m	dB	
1	5139.203	7.55	34.32	42.32	51.30	50.85	-3.15	Average
2	5210.000	7.68	34.37	42.32	90.44	90.17	-----	Average
3	5359.467	7.94	34.49	42.34	50.21	50.30	-3.70	Average



Unless otherwise agreed in writing, this document is issued by the Company subject to its General Conditions of Service printed overleaf, available on request or accessible at <http://www.sgs.com/en/Terms-and-Conditions.aspx> and, for electronic format documents, subject to Terms and Conditions for Electronic Documents at <http://www.sgs.com/en/Terms-and-Conditions/Terms-e-Documents.aspx>. Attention is drawn to the limitation of liability, indemnification and jurisdiction issues defined therein. Any holder of this document is advised that information contained hereon reflects the Company's findings at the time of its intervention only and within the limits of Client's instructions, if any. The Company's sole responsibility is to its Client and this document does not exonerate parties to a transaction from exercising all their rights and obligations under the transaction documents. This document cannot be reproduced except in full, without prior written approval of the Company. Any unauthorized alteration, forgery or falsification of the content or appearance of this document is unlawful and offenders may be prosecuted to the fullest extent of the law. Unless otherwise stated the results shown in this test report refer only to the sample(s) tested and such sample(s) are retained for 30 days only.
 Attention: To check the authenticity of testing /inspection report & certificate, please contact us at telephone: (86-755) 8307 1443, or email: CN.Doccheck@sgs.com

Test Mode: 02; Polarity: Vertical; Modulation:802.11ac; Bandwidth:80MHz; Channel:middle

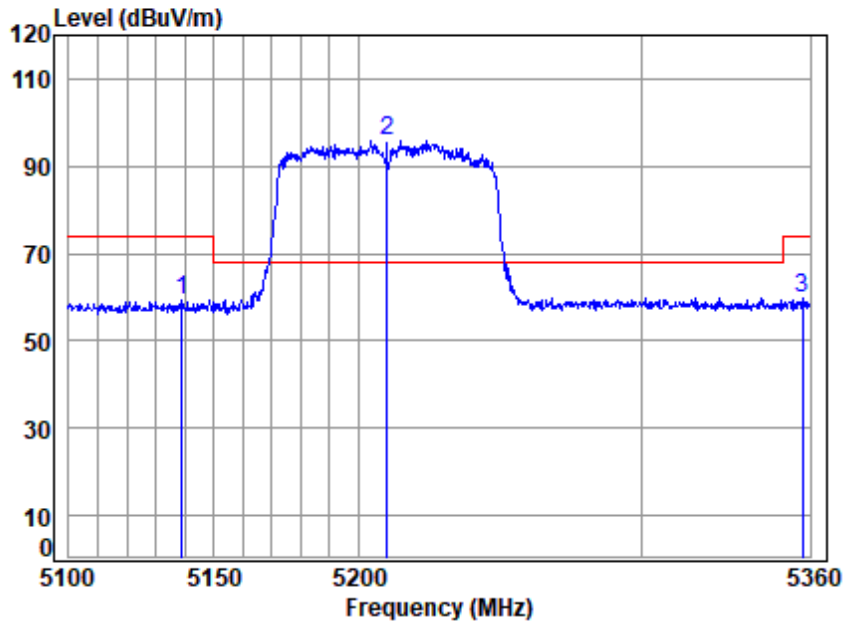

Site : chamber
 Condition: 3m VERTICAL
 Job No : 00028CR/00029CR
 Mode : 5210 Band edge
 : 5G WIFI 11AC80

	Freq	Cable Loss	Ant Factor	Preamp Factor	Read Level	Limit Level	Limit Line	Over Limit	Remark
	MHz	dB	dB/m	dB	dBuV	dBuV/m	dBuV/m	dB	
1	5138.691	7.55	34.31	42.32	59.74	59.28	74.00	-14.72	Peak
2 *	5210.000	7.68	34.37	42.32	95.94	95.67	68.20	27.47	Peak
3	5357.335	7.94	34.49	42.34	59.63	59.72	74.00	-14.28	Peak



Test Mode: 02; Polarity: Vertical; Modulation:802.11ac; Bandwidth:80MHz; Channel:middle

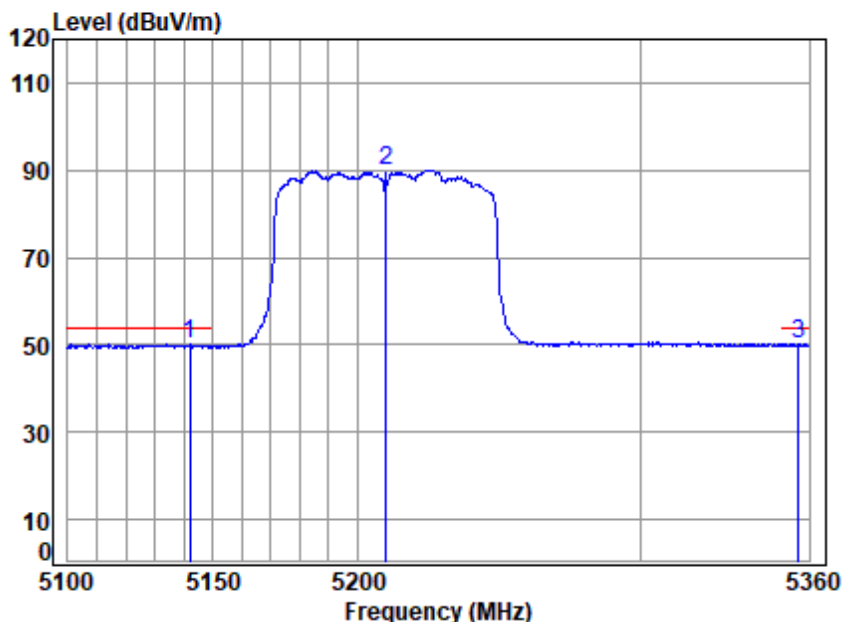

Site : chamber
 Condition: 3m VERTICAL
 Job No : 00028CR/00029CR
 Mode : 5210 Band edge
 : 5G WIFI 11AC80

	Freq	Cable Loss	Ant Factor	Preamp Factor	Read Level	Limit Level	Over Line	Over Limit	Remark
	MHz	dB	dB/m	dB	dBuV	dBuV/m	dBuV/m	dB	
1	5142.014	7.56	34.32	42.32	50.67	50.23	54.00	-3.77	Average
2	5210.000	7.68	34.37	42.32	90.28	90.01	-----	-----	Average
3	5356.270	7.94	34.49	42.34	50.15	50.24	54.00	-3.76	Average



Unless otherwise agreed in writing, this document is issued by the Company subject to its General Conditions of Service printed overleaf, available on request or accessible at <http://www.sgs.com/en/Terms-and-Conditions.aspx> and, for electronic format documents, subject to Terms and Conditions for Electronic Documents at <http://www.sgs.com/en/Terms-and-Conditions/Terms-e-Documents.aspx>. Attention is drawn to the limitation of liability, indemnification and jurisdiction issues defined therein. Any holder of this document is advised that information contained hereon reflects the Company's findings at the time of its intervention only and within the limits of Client's instructions, if any. The Company's sole responsibility is to its Client and this document does not exonerate parties to a transaction from exercising all their rights and obligations under the transaction documents. This document cannot be reproduced except in full, without prior written approval of the Company. Any unauthorized alteration, forgery or falsification of the content or appearance of this document is unlawful and offenders may be prosecuted to the fullest extent of the law. Unless otherwise stated the results shown in this test report refer only to the sample(s) tested and such sample(s) are retained for 30 days only.
 Attention: To check the authenticity of testing / inspection report & certificate, please contact us at telephone: (86-755) 8307 1443, or email: CN.Doccheck@sgs.com

Test Mode: 03; Polarity: Horizontal; Modulation:802.11a; Bandwidth:20MHz; Channel:Low

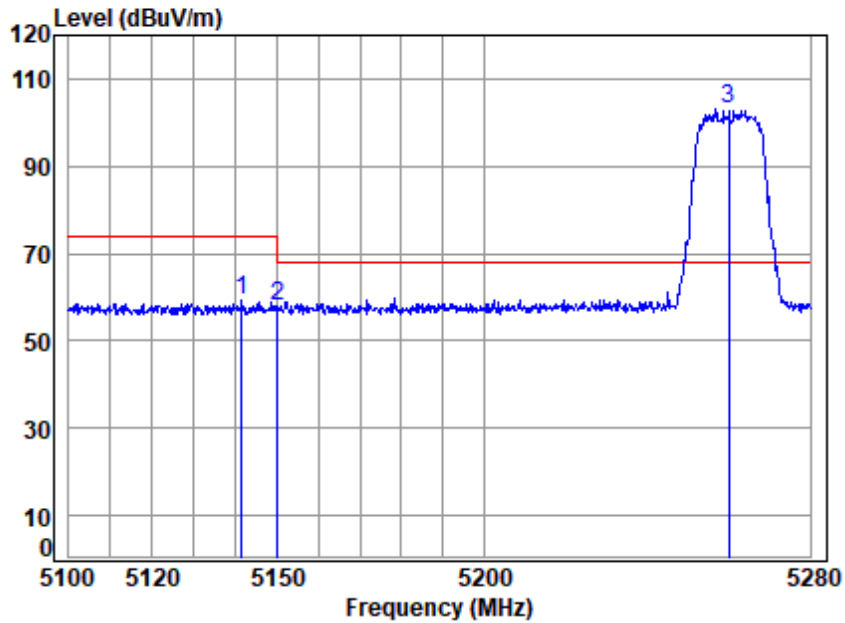

Site : chamber
 Condition: 3m HORIZONTAL
 Job No : 00028CR/00029CR
 Mode : 5260 Band edge
 : 5G WIFI 11A

	Cable	Ant	Preamp	Read	Limit	Over	
Freq	Loss	Factor	Factor	Level	Level	Line	Limit
MHz	dB	dB/m	dB	dBuV	dBuV/m	dBuV/m	dB
1	7.56	34.32	42.32	59.78	59.34	74.00	-14.66
2	7.57	34.32	42.32	58.33	57.90	74.00	-16.10
3 *	7.77	34.41	42.33	103.16	103.01	68.20	34.81



Unless otherwise agreed in writing, this document is issued by the Company subject to its General Conditions of Service printed overleaf, available on request or accessible at <http://www.sgs.com/en/Terms-and-Conditions.aspx> and, for electronic format documents, subject to Terms and Conditions for Electronic Documents at <http://www.sgs.com/en/Terms-and-Conditions/Terms-e-Documents.aspx>. Attention is drawn to the limitation of liability, indemnification and jurisdiction issues defined therein. Any holder of this document is advised that information contained hereon reflects the Company's findings at the time of its intervention only and within the limits of Client's instructions, if any. The Company's sole responsibility is to its Client and this document does not exonerate parties to a transaction from exercising all their rights and obligations under the transaction documents. This document cannot be reproduced except in full, without prior written approval of the Company. Any unauthorized alteration, forgery or falsification of the content or appearance of this document is unlawful and offenders may be prosecuted to the fullest extent of the law. Unless otherwise stated the results shown in this test report refer only to the sample(s) tested and such sample(s) are retained for 30 days only.
 Attention: To check the authenticity of testing / inspection report & certificate, please contact us at telephone: (86-755) 8307 1443, or email: CN.Doccheck@sgs.com

Test Mode: 03; Polarity: Horizontal; Modulation:802.11a; Bandwidth:20MHz; Channel:Low

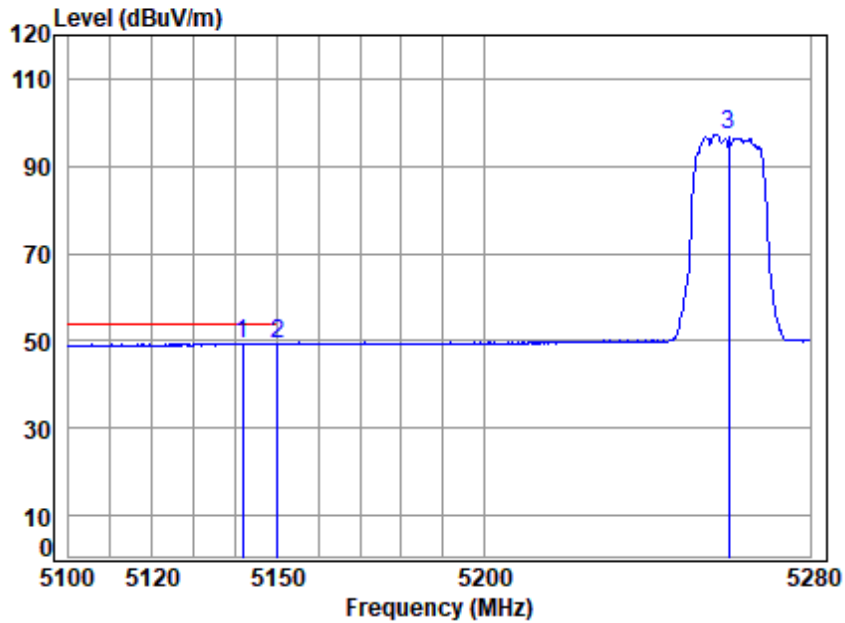

Site : chamber
 Condition: 3m HORIZONTAL
 Job No : 00028CR/00029CR
 Mode : 5260 Band edge
 : 5G WIFI 11A

	Freq	Cable Loss	Ant Factor	Preamp Factor	Read Level	Limit Level	Over Limit	Remark
	MHz	dB	dB/m	dB	dBuV	dBuV/m	dBuV/m	dB
1	5141.741	7.56	34.32	42.32	49.93	49.49	54.00	-4.51 Average
2	5149.980	7.57	34.32	42.32	49.71	49.28	54.00	-4.72 Average
3	5260.000	7.77	34.41	42.33	97.46	97.31	-----	----- Average



Unless otherwise agreed in writing, this document is issued by the Company subject to its General Conditions of Service printed overleaf, available on request or accessible at <http://www.sgs.com/en/Terms-and-Conditions.aspx> and, for electronic format documents, subject to Terms and Conditions for Electronic Documents at <http://www.sgs.com/en/Terms-and-Conditions/Terms-e-Documents.aspx>. Attention is drawn to the limitation of liability, indemnification and jurisdiction issues defined therein. Any holder of this document is advised that information contained hereon reflects the Company's findings at the time of its intervention only and within the limits of Client's instructions, if any. The Company's sole responsibility is to its Client and this document does not exonerate parties to a transaction from exercising all their rights and obligations under the transaction documents. This document cannot be reproduced except in full, without prior written approval of the Company. Any unauthorized alteration, forgery or falsification of the content or appearance of this document is unlawful and offenders may be prosecuted to the fullest extent of the law. Unless otherwise stated the results shown in this test report refer only to the sample(s) tested and such sample(s) are retained for 30 days only.
 Attention: To check the authenticity of testing / inspection report & certificate, please contact us at telephone: (86-755) 8307 1443, or email: CN.Doccheck@sgs.com

Test Mode: 03; Polarity: Vertical; Modulation:802.11a; Bandwidth:20MHz; Channel:Low

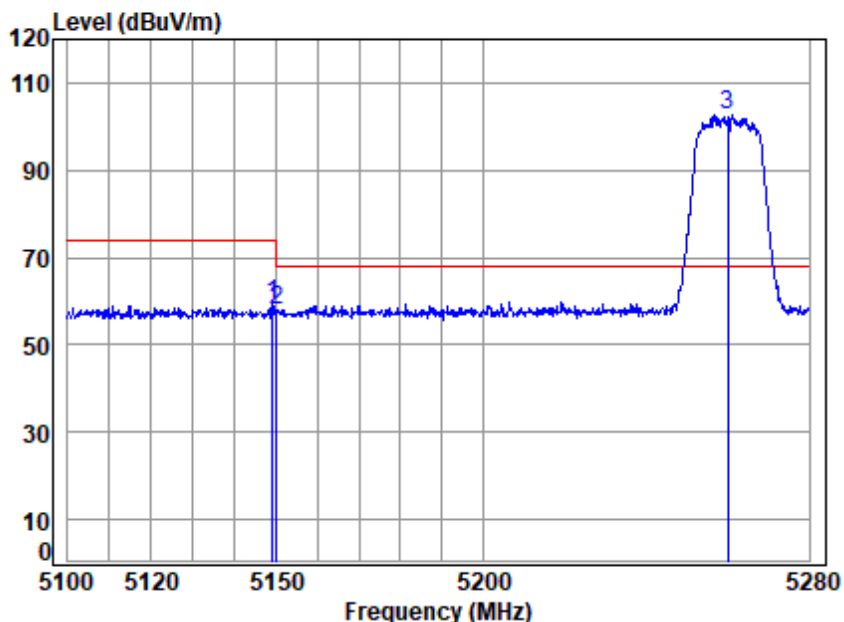

Site : chamber
 Condition: 3m VERTICAL
 Job No : 00028CR/00029CR
 Mode : 5260 Band edge
 : 5G WIFI 11A

	Freq	Cable Loss	Ant Factor	Preamp Factor	Read Level	Limit Level	Over Limit	Remark
	MHz	dB	dB/m	dB	dBuV	dBuV/m	dBuV/m	dB
1	5149.058	7.57	34.32	42.32	59.72	59.29	74.00	-14.71 Peak
2	5149.980	7.57	34.32	42.32	58.27	57.84	74.00	-16.16 Peak
3 *	5260.000	7.77	34.41	42.33	102.68	102.53	68.20	34.33 Peak



Unless otherwise agreed in writing, this document is issued by the Company subject to its General Conditions of Service printed overleaf, available on request or accessible at <http://www.sgs.com/en/Terms-and-Conditions.aspx> and, for electronic format documents, subject to Terms and Conditions for Electronic Documents at <http://www.sgs.com/en/Terms-and-Conditions/Terms-e-Documents.aspx>. Attention is drawn to the limitation of liability, indemnification and jurisdiction issues defined therein. Any holder of this document is advised that information contained hereon reflects the Company's findings at the time of its intervention only and within the limits of Client's instructions, if any. The Company's sole responsibility is to its Client and this document does not exonerate parties to a transaction from exercising all their rights and obligations under the transaction documents. This document cannot be reproduced except in full, without prior written approval of the Company. Any unauthorized alteration, forgery or falsification of the content or appearance of this document is unlawful and offenders may be prosecuted to the fullest extent of the law. Unless otherwise stated the results shown in this test report refer only to the sample(s) tested and such sample(s) are retained for 30 days only.
 Attention: To check the authenticity of testing / inspection report & certificate, please contact us at telephone: (86-755) 8307 1443, or email: CN.Doccheck@sgs.com

Test Mode: 03; Polarity: Vertical; Modulation:802.11a; Bandwidth:20MHz; Channel:Low

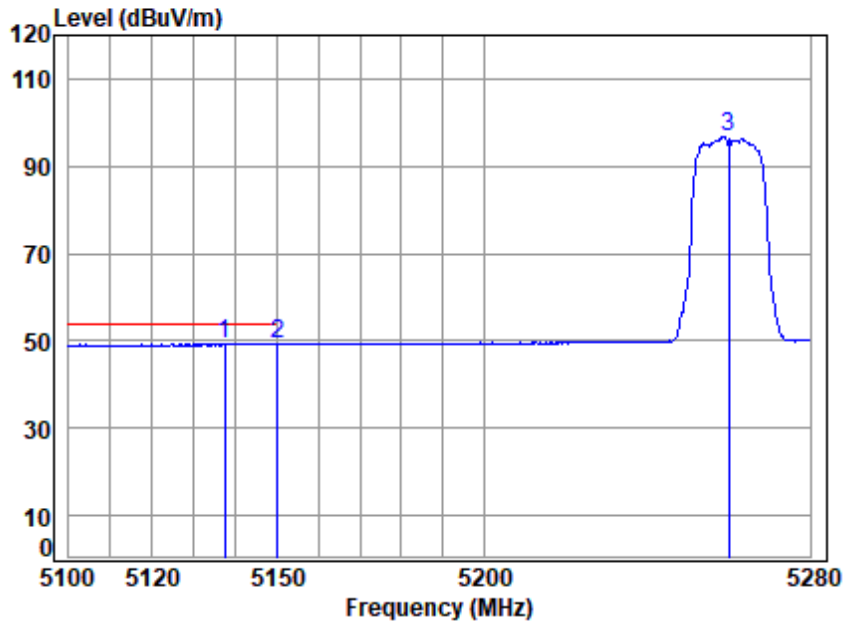

Site : chamber
 Condition: 3m VERTICAL
 Job No : 00028CR/00029CR
 Mode : 5260 Band edge
 : 5G WIFI 11A

	Cable	Ant	Preamp	Read	Limit	Over		
Freq	Loss	Factor	Factor	Level	Level	Line	Limit	Remark
MHz	dB	dB/m	dB	dBuV	dBuV/m	dBuV/m	dB	
1	5137.284	7.55	34.31	42.31	49.83	49.38	54.00	-4.62 Average
2	5149.980	7.57	34.32	42.32	49.70	49.27	54.00	-4.73 Average
3	5260.000	7.77	34.41	42.33	97.10	96.95	-----	----- Average



Test Mode: 03; Polarity: Horizontal; Modulation:802.11a; Bandwidth:20MHz; Channel:High

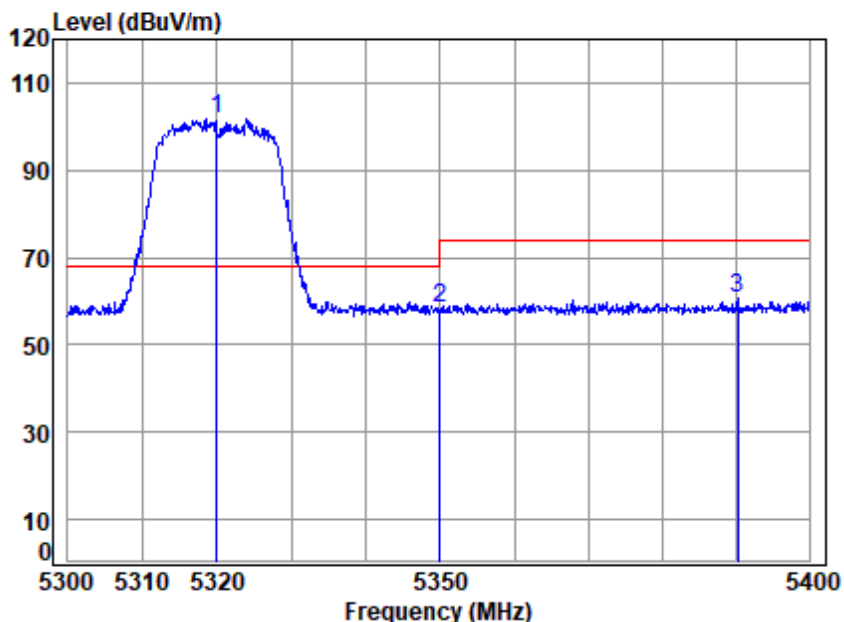

Site : chamber
 Condition: 3m HORIZONTAL
 Job No : 00028CR/00029CR
 Mode : 5320 Band edge
 : 5G WIFI 11A

Freq	Cable Loss	Ant Factor	Preamp Factor	Read Level	Level	Limit Line	Over Limit	Remark
MHz	dB	dB/m	dB	dBuV	dBuV/m	dBuV/m	dB	
1 * 5320.000	7.87	34.46	42.33	101.55	101.55	68.20	33.35	peak
2 5350.020	7.92	34.48	42.34	58.36	58.42	74.00	-15.58	peak
3 5390.319	7.99	34.52	42.34	60.35	60.52	74.00	-13.48	peak



Unless otherwise agreed in writing, this document is issued by the Company subject to its General Conditions of Service printed overleaf, available on request or accessible at <http://www.sgs.com/en/Terms-and-Conditions.aspx> and, for electronic format documents, subject to Terms and Conditions for Electronic Documents at <http://www.sgs.com/en/Terms-and-Conditions/Terms-e-Documents.aspx>. Attention is drawn to the limitation of liability, indemnification and jurisdiction issues defined therein. Any holder of this document is advised that information contained hereon reflects the Company's findings at the time of its intervention only and within the limits of Client's instructions, if any. The Company's sole responsibility is to its Client and this document does not exonerate parties to a transaction from exercising all their rights and obligations under the transaction documents. This document cannot be reproduced except in full, without prior written approval of the Company. Any unauthorized alteration, forgery or falsification of the content or appearance of this document is unlawful and offenders may be prosecuted to the fullest extent of the law. Unless otherwise stated the results shown in this test report refer only to the sample(s) tested and such sample(s) are retained for 30 days only.
 Attention: To check the authenticity of testing /inspection report & certificate, please contact us at telephone: (86-755) 8307 1443, or email: CN.Doccheck@sgs.com

Test Mode: 03; Polarity: Horizontal; Modulation:802.11a; Bandwidth:20MHz; Channel:High

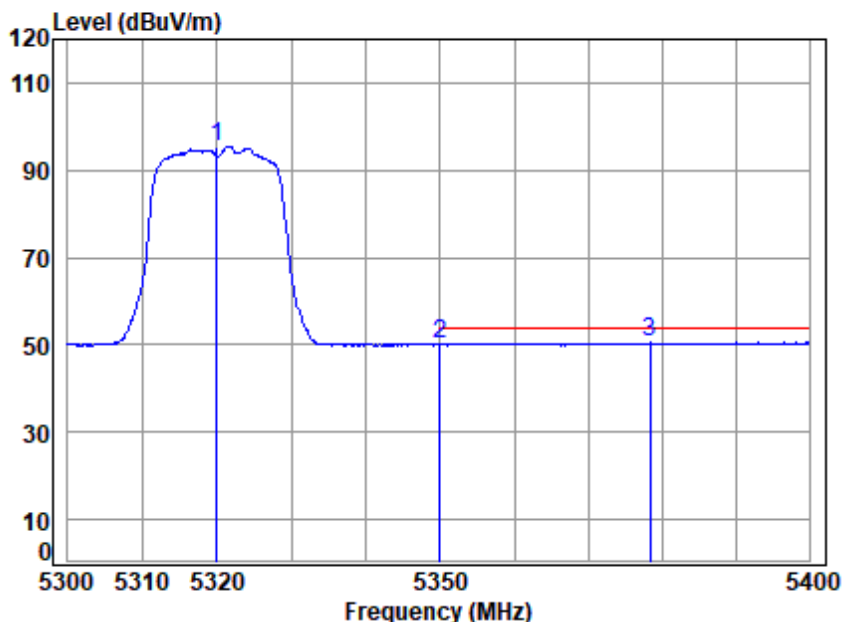

Site : chamber
 Condition: 3m HORIZONTAL
 Job No : 00028CR/00029CR
 Mode : 5320 Band edge
 : 5G WIFI 11A

	Freq	Cable Loss	Ant Factor	Preamp Factor	Read Level	Limit Level	Over Limit	Remark
	MHz	dB	dB/m	dB	dBuV	dBuV/m	dBuV/m	dB
1	5320.000	7.87	34.46	42.33	95.38	95.38	-----	Average
2	5350.020	7.92	34.48	42.34	50.30	50.36	54.00	-3.64 Average
3	5378.342	7.97	34.51	42.34	50.36	50.50	54.00	-3.50 Average



Unless otherwise agreed in writing, this document is issued by the Company subject to its General Conditions of Service printed overleaf, available on request or accessible at <http://www.sgs.com/en/Terms-and-Conditions.aspx> and, for electronic format documents, subject to Terms and Conditions for Electronic Documents at <http://www.sgs.com/en/Terms-and-Conditions/Terms-e-Documents.aspx>. Attention is drawn to the limitation of liability, indemnification and jurisdiction issues defined therein. Any holder of this document is advised that information contained hereon reflects the Company's findings at the time of its intervention only and within the limits of Client's instructions, if any. The Company's sole responsibility is to its Client and this document does not exonerate parties to a transaction from exercising all their rights and obligations under the transaction documents. This document cannot be reproduced except in full, without prior written approval of the Company. Any unauthorized alteration, forgery or falsification of the content or appearance of this document is unlawful and offenders may be prosecuted to the fullest extent of the law. Unless otherwise stated the results shown in this test report refer only to the sample(s) tested and such sample(s) are retained for 30 days only.
 Attention: To check the authenticity of testing / inspection report & certificate, please contact us at telephone: (86-755) 8307 1443, or email: CN.Doccheck@sgs.com

Test Mode: 03; Polarity: Vertical; Modulation:802.11a; Bandwidth:20MHz; Channel:High

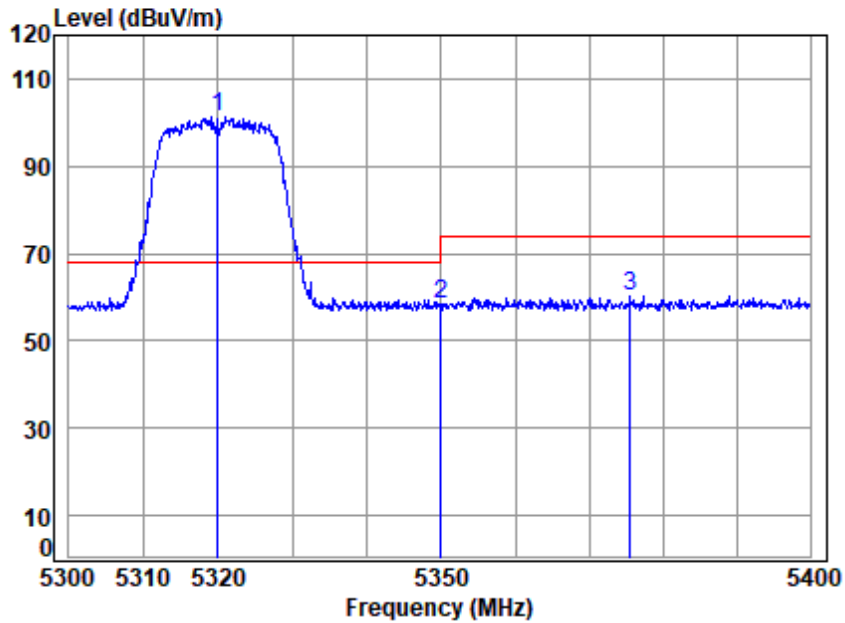

Site : chamber
 Condition: 3m VERTICAL
 Job No : 00028CR/00029CR
 Mode : 5320 Band edge
 : 5G WIFI 11A

Freq	Cable Loss	Ant Factor	Preamp Factor	Read Level	Limit Level	Limit Line	Over Limit	Remark
MHz	dB	dB/m	dB	dBuV	dBuV/m	dBuV/m	dB	
1 * 5320.000	7.87	34.46	42.33	101.46	101.46	68.20	33.26	Peak
2 5350.020	7.92	34.48	42.34	58.33	58.39	74.00	-15.61	Peak
3 5375.528	7.97	34.50	42.34	60.03	60.16	74.00	-13.84	Peak



Unless otherwise agreed in writing, this document is issued by the Company subject to its General Conditions of Service printed overleaf, available on request or accessible at <http://www.sgs.com/en/Terms-and-Conditions.aspx> and, for electronic format documents, subject to Terms and Conditions for Electronic Documents at <http://www.sgs.com/en/Terms-and-Conditions/Terms-e-Documents.aspx>. Attention is drawn to the limitation of liability, indemnification and jurisdiction issues defined therein. Any holder of this document is advised that information contained hereon reflects the Company's findings at the time of its intervention only and within the limits of Client's instructions, if any. The Company's sole responsibility is to its Client and this document does not exonerate parties to a transaction from exercising all their rights and obligations under the transaction documents. This document cannot be reproduced except in full, without prior written approval of the Company. Any unauthorized alteration, forgery or falsification of the content or appearance of this document is unlawful and offenders may be prosecuted to the fullest extent of the law. Unless otherwise stated the results shown in this test report refer only to the sample(s) tested and such sample(s) are retained for 30 days only.
 Attention: To check the authenticity of testing /inspection report & certificate, please contact us at telephone: (86-755) 8307 1443, or email: CN.Doccheck@sgs.com

Test Mode: 03; Polarity: Vertical; Modulation:802.11a; Bandwidth:20MHz; Channel:High

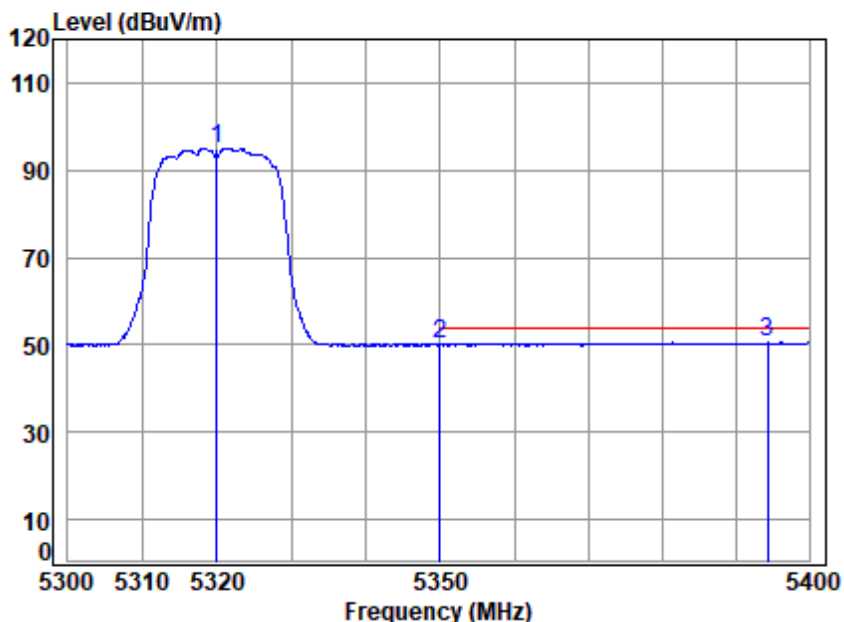

Site : chamber
 Condition: 3m VERTICAL
 Job No : 00028CR/00029CR
 Mode : 5320 Band edge
 : 5G WIFI 11A

	Cable	Ant	Preamp	Read	Limit	Over		
Freq	Loss	Factor	Factor	Level	Level	Line	Limit	Remark
MHz	dB	dB/m	dB	dBuV	dBuV/m	dBuV/m	dB	
1	5320.000	7.87	34.46	42.33	95.08	95.08	-----	----- Average
2	5350.020	7.92	34.48	42.34	49.99	50.05	54.00	-3.95 Average
3	5394.351	8.00	34.52	42.34	50.36	50.54	54.00	-3.46 Average



Unless otherwise agreed in writing, this document is issued by the Company subject to its General Conditions of Service printed overleaf, available on request or accessible at <http://www.sgs.com/en/Terms-and-Conditions.aspx> and, for electronic format documents, subject to Terms and Conditions for Electronic Documents at <http://www.sgs.com/en/Terms-and-Conditions/Terms-e-Documents.aspx>. Attention is drawn to the limitation of liability, indemnification and jurisdiction issues defined therein. Any holder of this document is advised that information contained hereon reflects the Company's findings at the time of its intervention only and within the limits of Client's instructions, if any. The Company's sole responsibility is to its Client and this document does not exonerate parties to a transaction from exercising all their rights and obligations under the transaction documents. This document cannot be reproduced except in full, without prior written approval of the Company. Any unauthorized alteration, forgery or falsification of the content or appearance of this document is unlawful and offenders may be prosecuted to the fullest extent of the law. Unless otherwise stated the results shown in this test report refer only to the sample(s) tested and such sample(s) are retained for 30 days only.
 Attention: To check the authenticity of testing / inspection report & certificate, please contact us at telephone: (86-755) 8307 1443, or email: CN.Doccheck@sgs.com

Test Mode: 03; Polarity: Horizontal; Modulation:802.11n; Bandwidth:20MHz; Channel:Low

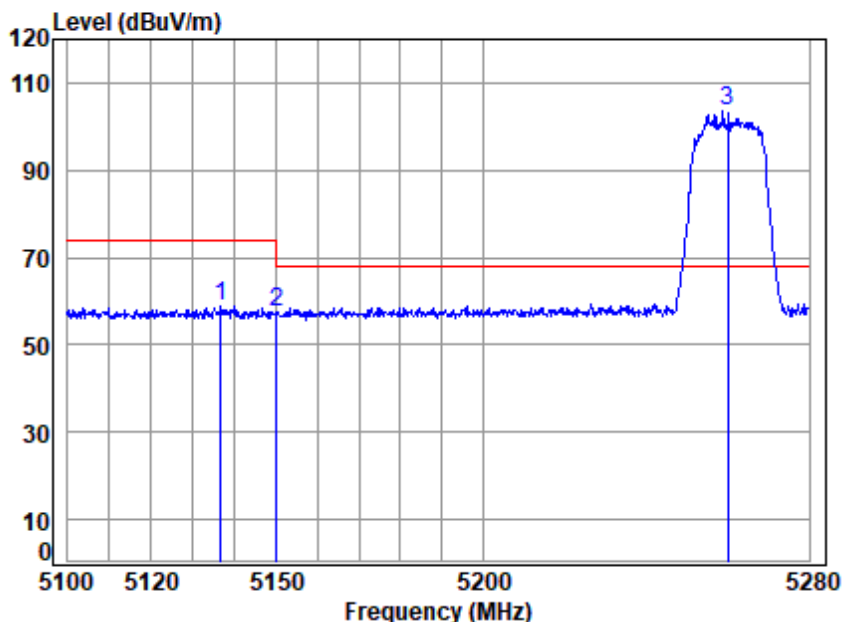

Site : chamber
 Condition: 3m HORIZONTAL
 Job No : 00028CR/00029CR
 Mode : 5260 Band edge
 : 5G WIFI 11N20

	Cable	Ant	Preamp	Read	Limit	Over	
Freq	Loss	Factor	Factor	Level	Level	Line	Limit Remark
MHz	dB	dB/m	dB	dBuV	dBuV/m	dBuV/m	dB
1	7.55	34.31	42.31	59.32	58.87	74.00	-15.13 peak
2	7.57	34.32	42.32	57.71	57.28	74.00	-16.72 peak
3 *	7.77	34.41	42.33	103.79	103.64	68.20	35.44 peak



Unless otherwise agreed in writing, this document is issued by the Company subject to its General Conditions of Service printed overleaf, available on request or accessible at <http://www.sgs.com/en/Terms-and-Conditions.aspx> and, for electronic format documents, subject to Terms and Conditions for Electronic Documents at <http://www.sgs.com/en/Terms-and-Conditions/Terms-e-Documents.aspx>. Attention is drawn to the limitation of liability, indemnification and jurisdiction issues defined therein. Any holder of this document is advised that information contained hereon reflects the Company's findings at the time of its intervention only and within the limits of Client's instructions, if any. The Company's sole responsibility is to its Client and this document does not exonerate parties to a transaction from exercising all their rights and obligations under the transaction documents. This document cannot be reproduced except in full, without prior written approval of the Company. Any unauthorized alteration, forgery or falsification of the content or appearance of this document is unlawful and offenders may be prosecuted to the fullest extent of the law. Unless otherwise stated the results shown in this test report refer only to the sample(s) tested and such sample(s) are retained for 30 days only.
 Attention: To check the authenticity of testing / inspection report & certificate, please contact us at telephone: (86-755) 8307 1443, or email: CN.Doccheck@sgs.com

Test Mode: 03; Polarity: Horizontal; Modulation:802.11n; Bandwidth:20MHz; Channel:Low

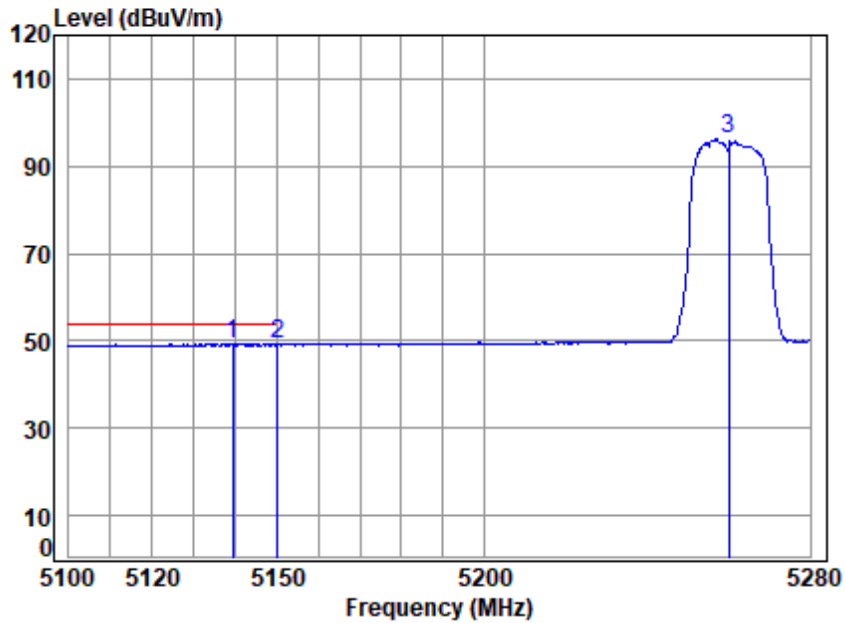

Site : chamber
 Condition: 3m HORIZONTAL
 Job No : 00028CR/00029CR
 Mode : 5260 Band edge
 : 5G WIFI 11N20

	Freq	Cable Loss	Ant Factor	Preamp Factor	Read Level	Level	Limit Line	Over Limit	Remark
	MHz	dB	dB/m	dB	dBuV	dBuV/m	dBuV/m	dB	
1	5139.244	7.55	34.32	42.32	49.75	49.30	54.00	-4.70	Average
2	5149.980	7.57	34.32	42.32	49.65	49.22	54.00	-4.78	Average
3	5260.000	7.77	34.41	42.33	96.44	96.29	-----	-----	Average



Unless otherwise agreed in writing, this document is issued by the Company subject to its General Conditions of Service printed overleaf, available on request or accessible at <http://www.sgs.com/en/Terms-and-Conditions.aspx> and, for electronic format documents, subject to Terms and Conditions for Electronic Documents at <http://www.sgs.com/en/Terms-and-Conditions/Terms-e-Documents.aspx>. Attention is drawn to the limitation of liability, indemnification and jurisdiction issues defined therein. Any holder of this document is advised that information contained hereon reflects the Company's findings at the time of its intervention only and within the limits of Client's instructions, if any. The Company's sole responsibility is to its Client and this document does not exonerate parties to a transaction from exercising all their rights and obligations under the transaction documents. This document cannot be reproduced except in full, without prior written approval of the Company. Any unauthorized alteration, forgery or falsification of the content or appearance of this document is unlawful and offenders may be prosecuted to the fullest extent of the law. Unless otherwise stated the results shown in this test report refer only to the sample(s) tested and such sample(s) are retained for 30 days only.
 Attention: To check the authenticity of testing /inspection report & certificate, please contact us at telephone: (86-755) 8307 1443, or email: CN.Doccheck@sgs.com

Test Mode: 03; Polarity: Vertical; Modulation:802.11n; Bandwidth:20MHz; Channel:Low

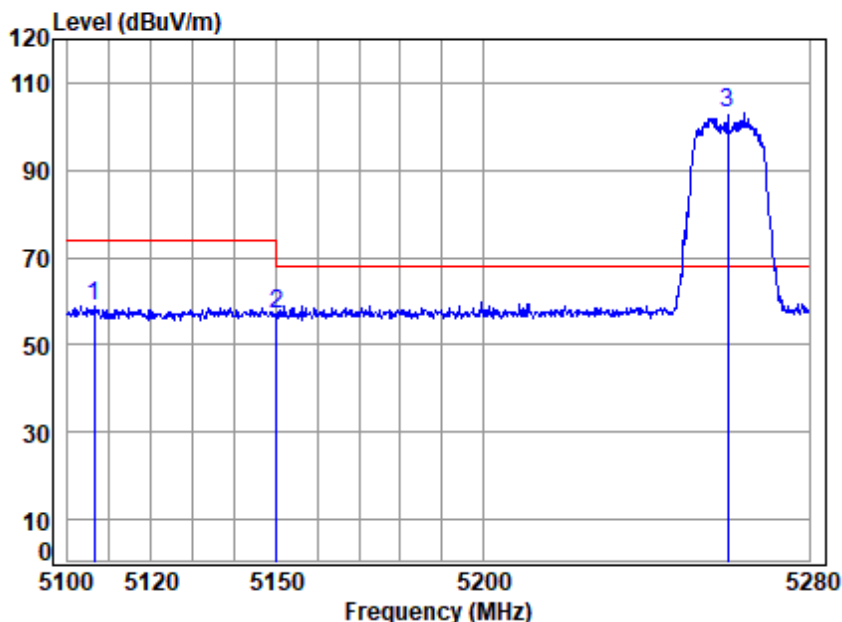

Site : chamber
 Condition: 3m VERTICAL
 Job No : 00028CR/00029CR
 Mode : 5260 Band edge
 : 5G WIFI 11N20

	Cable	Ant	Preamp	Read	Limit	Over	
Freq	Loss	Factor	Factor	Level	Level	Line	Limit
MHz	dB	dB/m	dB	dBuV	dBuV/m	dBuV/m	dB
1	7.49	34.29	42.31	59.55	59.02	74.00	-14.98
2	7.57	34.32	42.32	57.44	57.01	74.00	-16.99
3 *	7.77	34.41	42.33	103.10	102.95	68.20	34.75



Unless otherwise agreed in writing, this document is issued by the Company subject to its General Conditions of Service printed overleaf, available on request or accessible at <http://www.sgs.com/en/Terms-and-Conditions.aspx> and, for electronic format documents, subject to Terms and Conditions for Electronic Documents at <http://www.sgs.com/en/Terms-and-Conditions/Terms-e-Documents.aspx>. Attention is drawn to the limitation of liability, indemnification and jurisdiction issues defined therein. Any holder of this document is advised that information contained hereon reflects the Company's findings at the time of its intervention only and within the limits of Client's instructions, if any. The Company's sole responsibility is to its Client and this document does not exonerate parties to a transaction from exercising all their rights and obligations under the transaction documents. This document cannot be reproduced except in full, without prior written approval of the Company. Any unauthorized alteration, forgery or falsification of the content or appearance of this document is unlawful and offenders may be prosecuted to the fullest extent of the law. Unless otherwise stated the results shown in this test report refer only to the sample(s) tested and such sample(s) are retained for 30 days only.
 Attention: To check the authenticity of testing / inspection report & certificate, please contact us at telephone: (86-755) 8307 1443, or email: CN.Doccheck@sgs.com

Test Mode: 03; Polarity: Vertical; Modulation:802.11n; Bandwidth:20MHz; Channel:Low

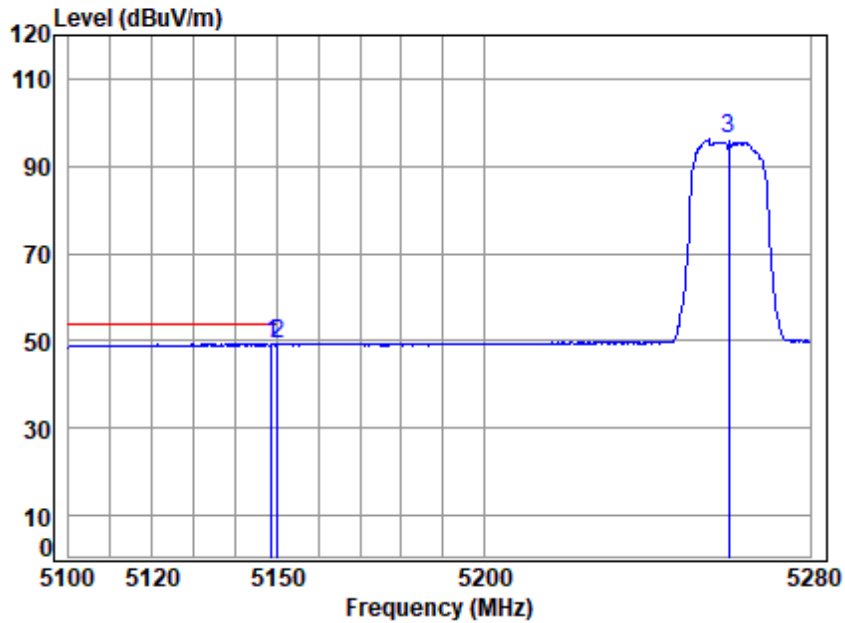

Site : chamber
 Condition: 3m VERTICAL
 Job No : 00028CR/00029CR
 Mode : 5260 Band edge
 : 5G WIFI 11N20

	Freq	Cable Loss	Ant Factor	Preamp Factor	Read Level	Limit Level	Over Limit	Remark
	MHz	dB	dB/m	dB	dBuV	dBuV/m	dBuV/m	dB
1	5148.522	7.57	34.32	42.32	49.86	49.43	54.00	-4.57 Average
2	5149.980	7.57	34.32	42.32	49.67	49.24	54.00	-4.76 Average
3	5260.000	7.77	34.41	42.33	96.20	96.05	-----	----- Average



Unless otherwise agreed in writing, this document is issued by the Company subject to its General Conditions of Service printed overleaf, available on request or accessible at <http://www.sgs.com/en/Terms-and-Conditions.aspx> and, for electronic format documents, subject to Terms and Conditions for Electronic Documents at <http://www.sgs.com/en/Terms-and-Conditions/Terms-e-Documents.aspx>. Attention is drawn to the limitation of liability, indemnification and jurisdiction issues defined therein. Any holder of this document is advised that information contained hereon reflects the Company's findings at the time of its intervention only and within the limits of Client's instructions, if any. The Company's sole responsibility is to its Client and this document does not exonerate parties to a transaction from exercising all their rights and obligations under the transaction documents. This document cannot be reproduced except in full, without prior written approval of the Company. Any unauthorized alteration, forgery or falsification of the content or appearance of this document is unlawful and offenders may be prosecuted to the fullest extent of the law. Unless otherwise stated the results shown in this test report refer only to the sample(s) tested and such sample(s) are retained for 30 days only.
 Attention: To check the authenticity of testing / inspection report & certificate, please contact us at telephone: (86-755) 8307 1443, or email: CN.Doccheck@sgs.com

Test Mode: 03; Polarity: Horizontal; Modulation:802.11n; Bandwidth:20MHz; Channel:High

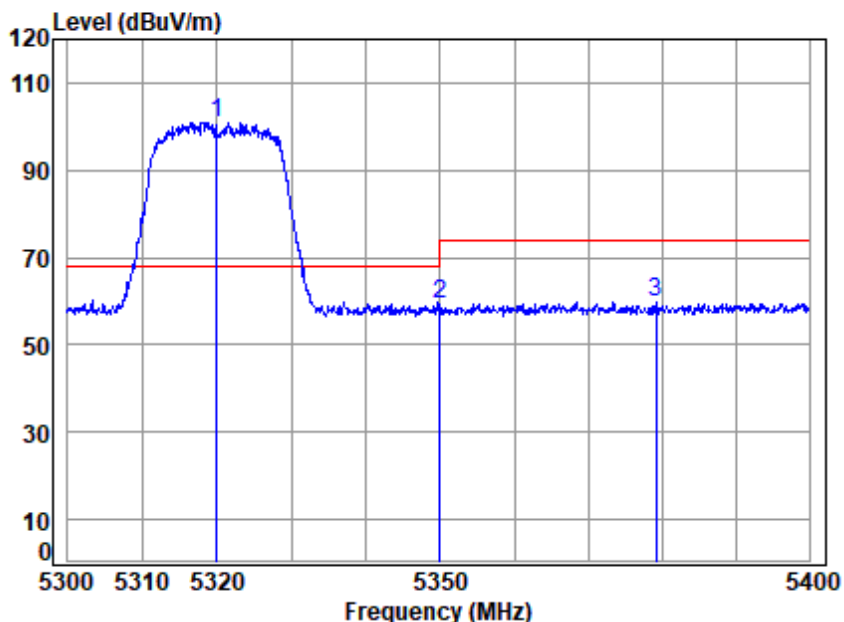

Site : chamber
 Condition: 3m HORIZONTAL
 Job No : 00028CR/00029CR
 Mode : 5320 Band edge
 : 5G WIFI 11N20

Freq	Cable Loss	Ant Factor	Preamp Factor	Read Level	Limit Level	Limit Line	Over Limit	Remark
MHz	dB	dB/m	dB	dBuV	dBuV/m	dBuV/m	dB	
1 * 5320.000	7.87	34.46	42.33	100.96	100.96	68.20	32.76	peak
2 5350.020	7.92	34.48	42.34	59.04	59.10	74.00	-14.90	peak
3 5379.146	7.97	34.51	42.34	59.53	59.67	74.00	-14.33	peak



Unless otherwise agreed in writing, this document is issued by the Company subject to its General Conditions of Service printed overleaf, available on request or accessible at <http://www.sgs.com/en/Terms-and-Conditions.aspx> and, for electronic format documents, subject to Terms and Conditions for Electronic Documents at <http://www.sgs.com/en/Terms-and-Conditions/Terms-e-Documents.aspx>. Attention is drawn to the limitation of liability, indemnification and jurisdiction issues defined therein. Any holder of this document is advised that information contained hereon reflects the Company's findings at the time of its intervention only and within the limits of Client's instructions, if any. The Company's sole responsibility is to its Client and this document does not exonerate parties to a transaction from exercising all their rights and obligations under the transaction documents. This document cannot be reproduced except in full, without prior written approval of the Company. Any unauthorized alteration, forgery or falsification of the content or appearance of this document is unlawful and offenders may be prosecuted to the fullest extent of the law. Unless otherwise stated the results shown in this test report refer only to the sample(s) tested and such sample(s) are retained for 30 days only.
 Attention: To check the authenticity of testing /inspection report & certificate, please contact us at telephone: (86-755) 8307 1443, or email: CN.Doccheck@sgs.com

Test Mode: 03; Polarity: Horizontal; Modulation:802.11n; Bandwidth:20MHz; Channel:High

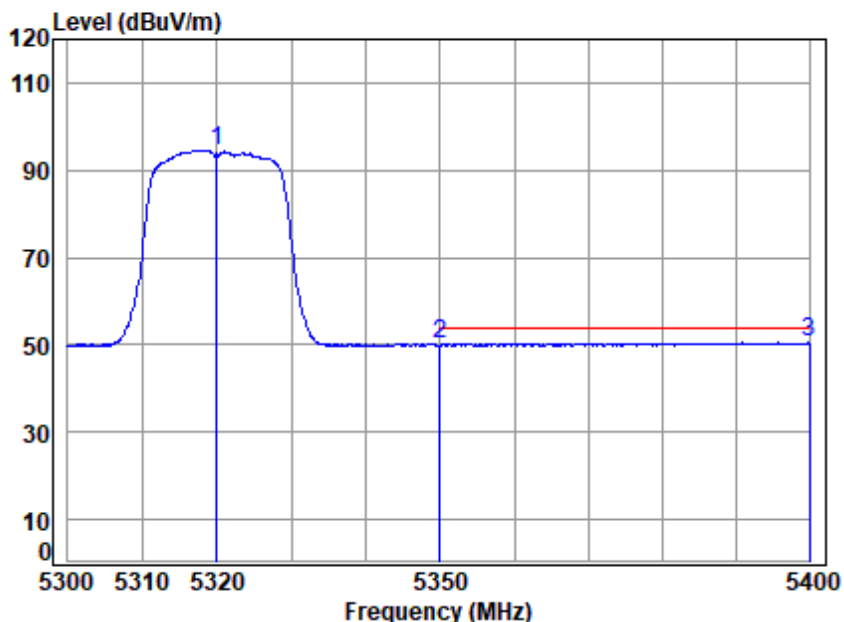

Site : chamber
 Condition: 3m HORIZONTAL
 Job No : 00028CR/00029CR
 Mode : 5320 Band edge
 : 5G WIFI 11N20

	Freq	Cable Loss	Ant Factor	Preamp Factor	Read Level	Limit Level	Over Line	Remark
	MHz	dB	dB/m	dB	dBuV	dBuV/m	dBuV/m	dB
1	5320.000	7.87	34.46	42.33	94.47	94.47	-----	Average
2	5350.020	7.92	34.48	42.34	49.93	49.99	54.00	-4.01 Average
3	5400.000	8.01	34.52	42.34	50.33	50.52	54.00	-3.48 Average



Unless otherwise agreed in writing, this document is issued by the Company subject to its General Conditions of Service printed overleaf, available on request or accessible at <http://www.sgs.com/en/Terms-and-Conditions.aspx> and, for electronic format documents, subject to Terms and Conditions for Electronic Documents at <http://www.sgs.com/en/Terms-and-Conditions/Terms-e-Documents.aspx>. Attention is drawn to the limitation of liability, indemnification and jurisdiction issues defined therein. Any holder of this document is advised that information contained hereon reflects the Company's findings at the time of its intervention only and within the limits of Client's instructions, if any. The Company's sole responsibility is to its Client and this document does not exonerate parties to a transaction from exercising all their rights and obligations under the transaction documents. This document cannot be reproduced except in full, without prior written approval of the Company. Any unauthorized alteration, forgery or falsification of the content or appearance of this document is unlawful and offenders may be prosecuted to the fullest extent of the law. Unless otherwise stated the results shown in this test report refer only to the sample(s) tested and such sample(s) are retained for 30 days only.
 Attention: To check the authenticity of testing / inspection report & certificate, please contact us at telephone: (86-755) 8307 1443, or email: CN.Doccheck@sgs.com

Test Mode: 03; Polarity: Vertical; Modulation:802.11n; Bandwidth:20MHz; Channel:High

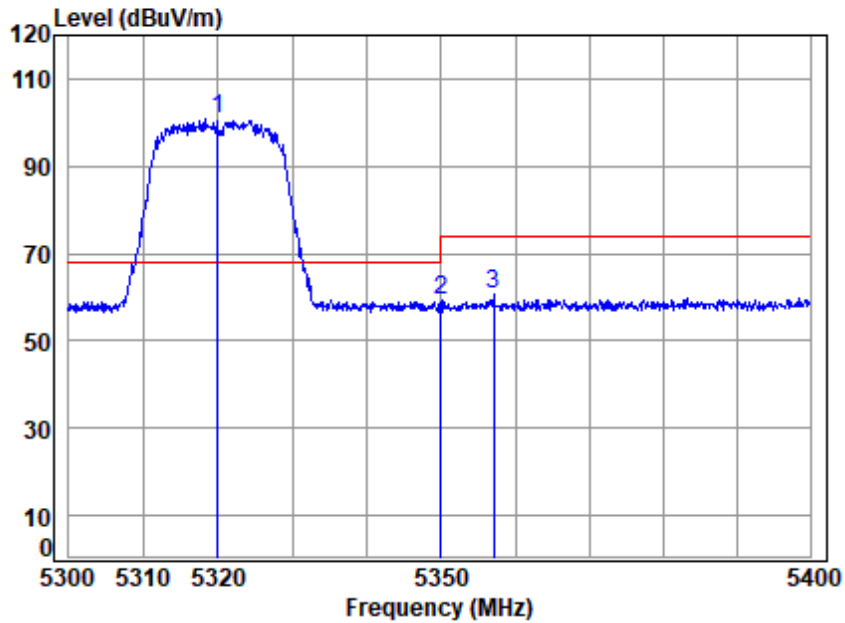

Site : chamber
 Condition: 3m VERTICAL
 Job No : 00028CR/00029CR
 Mode : 5320 Band edge
 : 5G WIFI 11N20

	Cable	Ant	Preamp	Read	Limit	Over	
Freq	Loss	Factor	Factor	Level	Level	Line	Limit
MHz	dB	dB/m	dB	dBuV	dBuV/m	dBuV/m	dB
1 * 5320.000	7.87	34.46	42.33	100.69	100.69	68.20	32.49 Peak
2 5350.020	7.92	34.48	42.34	59.20	59.26	74.00	-14.74 Peak
3 5357.071	7.94	34.49	42.34	60.75	60.84	74.00	-13.16 Peak



Unless otherwise agreed in writing, this document is issued by the Company subject to its General Conditions of Service printed overleaf, available on request or accessible at <http://www.sgs.com/en/Terms-and-Conditions.aspx> and, for electronic format documents, subject to Terms and Conditions for Electronic Documents at <http://www.sgs.com/en/Terms-and-Conditions/Terms-e-Documents.aspx>. Attention is drawn to the limitation of liability, indemnification and jurisdiction issues defined therein. Any holder of this document is advised that information contained hereon reflects the Company's findings at the time of its intervention only and within the limits of Client's instructions, if any. The Company's sole responsibility is to its Client and this document does not exonerate parties to a transaction from exercising all their rights and obligations under the transaction documents. This document cannot be reproduced except in full, without prior written approval of the Company. Any unauthorized alteration, forgery or falsification of the content or appearance of this document is unlawful and offenders may be prosecuted to the fullest extent of the law. Unless otherwise stated the results shown in this test report refer only to the sample(s) tested and such sample(s) are retained for 30 days only.
 Attention: To check the authenticity of testing /inspection report & certificate, please contact us at telephone: (86-755) 8307 1443, or email: CN.Doccheck@sgs.com

Test Mode: 03; Polarity: Vertical; Modulation:802.11n; Bandwidth:20MHz; Channel:High

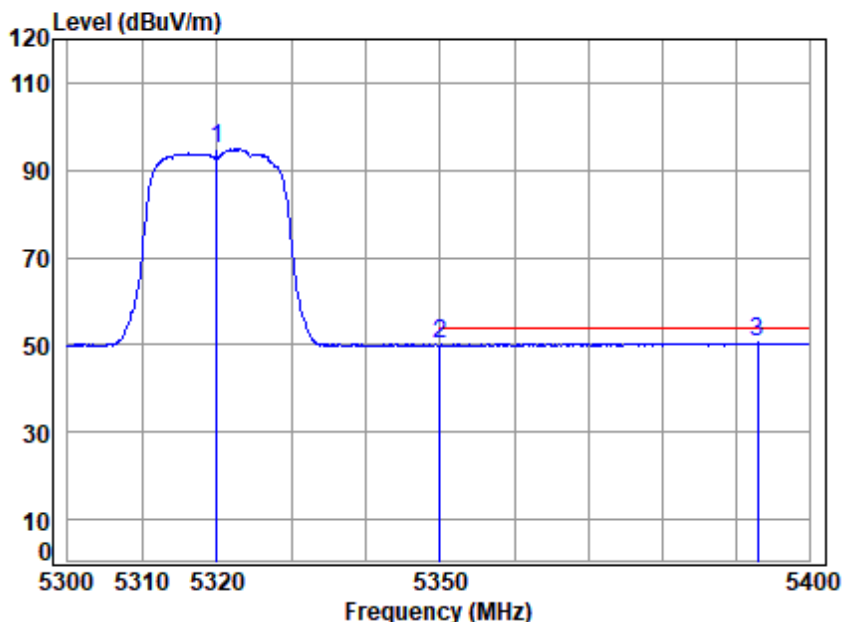

Site : chamber
 Condition: 3m VERTICAL
 Job No : 00028CR/00029CR
 Mode : 5320 Band edge
 : 5G WIFI 11N20

	Freq	Cable Loss	Ant Factor	Preamp Factor	Read Level	Limit Level	Limit Line	Over Limit	Remark
	MHz	dB	dB/m	dB	dBuV	dBuV/m	dBuV/m	dB	
1	5320.000	7.87	34.46	42.33	94.76	94.76	-----	-----	Average
2	5350.020	7.92	34.48	42.34	49.99	50.05	54.00	-3.95	Average
3	5393.040	8.00	34.52	42.34	50.32	50.50	54.00	-3.50	Average



Unless otherwise agreed in writing, this document is issued by the Company subject to its General Conditions of Service printed overleaf, available on request or accessible at <http://www.sgs.com/en/Terms-and-Conditions.aspx> and, for electronic format documents, subject to Terms and Conditions for Electronic Documents at <http://www.sgs.com/en/Terms-and-Conditions/Terms-e-Documents.aspx>. Attention is drawn to the limitation of liability, indemnification and jurisdiction issues defined therein. Any holder of this document is advised that information contained hereon reflects the Company's findings at the time of its intervention only and within the limits of Client's instructions, if any. The Company's sole responsibility is to its Client and this document does not exonerate parties to a transaction from exercising all their rights and obligations under the transaction documents. This document cannot be reproduced except in full, without prior written approval of the Company. Any unauthorized alteration, forgery or falsification of the content or appearance of this document is unlawful and offenders may be prosecuted to the fullest extent of the law. Unless otherwise stated the results shown in this test report refer only to the sample(s) tested and such sample(s) are retained for 30 days only.
 Attention: To check the authenticity of testing / inspection report & certificate, please contact us at telephone: (86-755) 8307 1443, or email: CN.Doccheck@sgs.com

Test Mode: 03; Polarity: Horizontal; Modulation:802.11n; Bandwidth:40MHz; Channel:Low

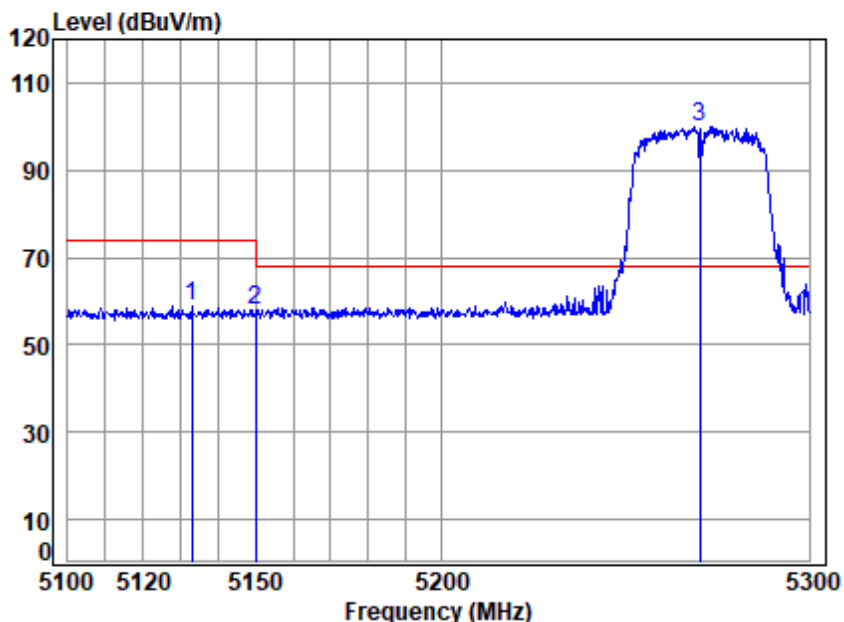

Site : chamber
 Condition: 3m HORIZONTAL
 Job No : 00028CR/00029CR
 Mode : 5270 Band edge
 : 5G WIFI 11N40

	Freq	Cable Loss	Ant Factor	Preamp Factor	Read Level	Limit Level	Limit Line	Over Limit	Remark
	MHz	dB	dB/m	dB	dBuV	dBuV/m	dBuV/m	dB	
1	5133.064	7.54	34.31	42.31	59.26	58.80	74.00	-15.20	peak
2	5149.980	7.57	34.32	42.32	58.41	57.98	74.00	-16.02	peak
3 *	5270.000	7.79	34.42	42.33	100.22	100.10	68.20	31.90	peak



Unless otherwise agreed in writing, this document is issued by the Company subject to its General Conditions of Service printed overleaf, available on request or accessible at <http://www.sgs.com/en/Terms-and-Conditions.aspx> and, for electronic format documents, subject to Terms and Conditions for Electronic Documents at <http://www.sgs.com/en/Terms-and-Conditions/Terms-e-Documents.aspx>. Attention is drawn to the limitation of liability, indemnification and jurisdiction issues defined therein. Any holder of this document is advised that information contained hereon reflects the Company's findings at the time of its intervention only and within the limits of Client's instructions, if any. The Company's sole responsibility is to its Client and this document does not exonerate parties to a transaction from exercising all their rights and obligations under the transaction documents. This document cannot be reproduced except in full, without prior written approval of the Company. Any unauthorized alteration, forgery or falsification of the content or appearance of this document is unlawful and offenders may be prosecuted to the fullest extent of the law. Unless otherwise stated the results shown in this test report refer only to the sample(s) tested and such sample(s) are retained for 30 days only.
 Attention: To check the authenticity of testing /inspection report & certificate, please contact us at telephone: (86-755) 8307 1443, or email: CN.Doccheck@sgs.com

Test Mode: 03; Polarity: Horizontal; Modulation:802.11n; Bandwidth:40MHz; Channel:Low

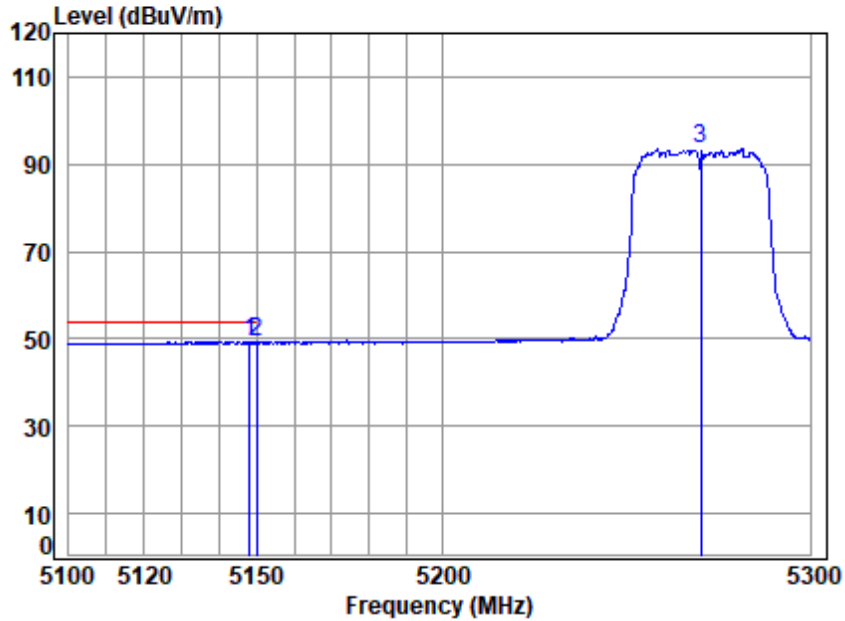

Site : chamber
 Condition: 3m HORIZONTAL
 Job No : 00028CR/00029CR
 Mode : 5270 Band edge
 : 5G WIFI 11N40

	Freq	Cable Loss	Ant Factor	Preamp Factor	Read Level	Limit Level	Over Limit	Remark
	MHz	dB	dB/m	dB	dBuV	dBuV/m	dBuV/m	dB
1	5148.093	7.57	34.32	42.32	49.80	49.37	54.00	-4.63 Average
2	5149.980	7.57	34.32	42.32	49.71	49.28	54.00	-4.72 Average
3	5270.000	7.79	34.42	42.33	93.57	93.45	-----	----- Average



Unless otherwise agreed in writing, this document is issued by the Company subject to its General Conditions of Service printed overleaf, available on request or accessible at <http://www.sgs.com/en/Terms-and-Conditions.aspx> and, for electronic format documents, subject to Terms and Conditions for Electronic Documents at <http://www.sgs.com/en/Terms-and-Conditions/Terms-e-Documents.aspx>. Attention is drawn to the limitation of liability, indemnification and jurisdiction issues defined therein. Any holder of this document is advised that information contained hereon reflects the Company's findings at the time of its intervention only and within the limits of Client's instructions, if any. The Company's sole responsibility is to its Client and this document does not exonerate parties to a transaction from exercising all their rights and obligations under the transaction documents. This document cannot be reproduced except in full, without prior written approval of the Company. Any unauthorized alteration, forgery or falsification of the content or appearance of this document is unlawful and offenders may be prosecuted to the fullest extent of the law. Unless otherwise stated the results shown in this test report refer only to the sample(s) tested and such sample(s) are retained for 30 days only.
 Attention: To check the authenticity of testing / inspection report & certificate, please contact us at telephone: (86-755) 8307 1443, or email: CN.Doccheck@sgs.com

Test Mode: 03; Polarity: Vertical; Modulation:802.11n; Bandwidth:40MHz; Channel:Low

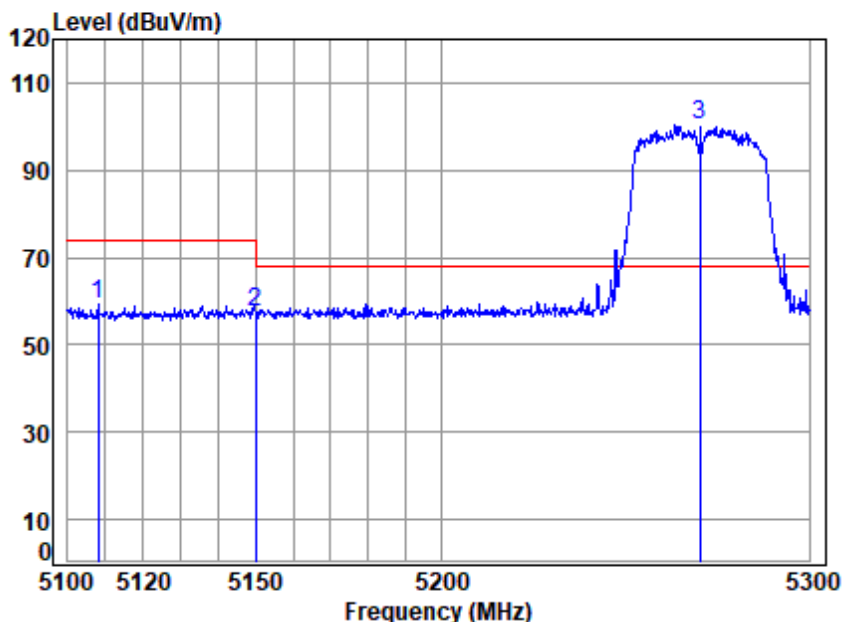

Site : chamber
 Condition: 3m VERTICAL
 Job No : 00028CR/00029CR
 Mode : 5270 Band edge
 : 5G WIFI 11N40

	Cable	Ant	Preamp	Read	Limit	Over	
Freq	Loss	Factor	Factor	Level	Level	Line	Limit Remark
MHz	dB	dB/m	dB	dBuV	dBuV/m	dBuV/m	dB
1	5108.050	7.50	34.29	42.31	59.73	59.21	74.00 -14.79 Peak
2	5149.980	7.57	34.32	42.32	58.11	57.68	74.00 -16.32 Peak
3 *	5270.000	7.79	34.42	42.33	100.46	100.34	68.20 32.14 Peak



Unless otherwise agreed in writing, this document is issued by the Company subject to its General Conditions of Service printed overleaf, available on request or accessible at <http://www.sgs.com/en/Terms-and-Conditions.aspx> and, for electronic format documents, subject to Terms and Conditions for Electronic Documents at <http://www.sgs.com/en/Terms-and-Conditions/Terms-e-Documents.aspx>. Attention is drawn to the limitation of liability, indemnification and jurisdiction issues defined therein. Any holder of this document is advised that information contained hereon reflects the Company's findings at the time of its intervention only and within the limits of Client's instructions, if any. The Company's sole responsibility is to its Client and this document does not exonerate parties to a transaction from exercising all their rights and obligations under the transaction documents. This document cannot be reproduced except in full, without prior written approval of the Company. Any unauthorized alteration, forgery or falsification of the content or appearance of this document is unlawful and offenders may be prosecuted to the fullest extent of the law. Unless otherwise stated the results shown in this test report refer only to the sample(s) tested and such sample(s) are retained for 30 days only.
 Attention: To check the authenticity of testing / inspection report & certificate, please contact us at telephone: (86-755) 8307 1443, or email: CN.Doccheck@sgs.com

Test Mode: 03; Polarity: Vertical; Modulation:802.11n; Bandwidth:40MHz; Channel:Low

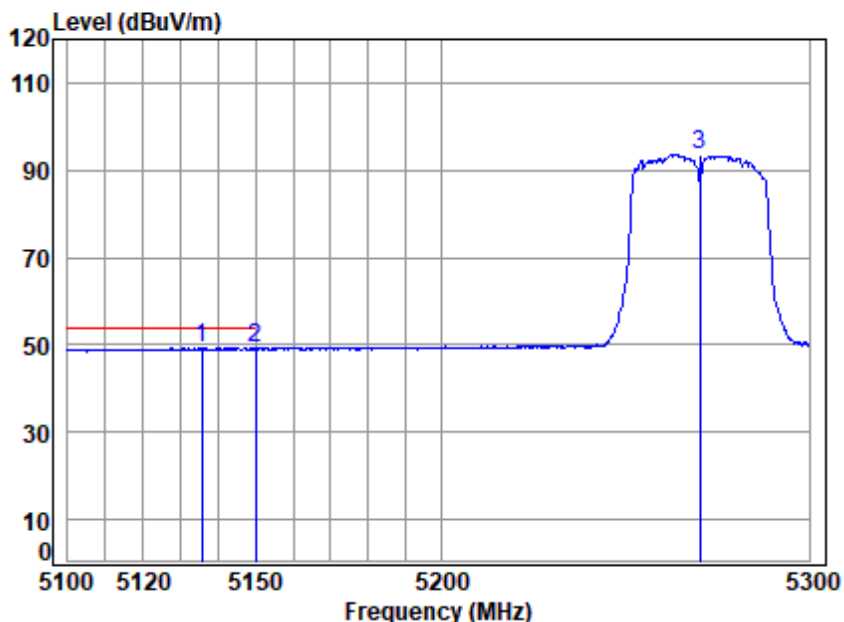

Site : chamber
 Condition: 3m VERTICAL
 Job No : 00028CR/00029CR
 Mode : 5270 Band edge
 : 5G WIFI 11N40

	Freq	Cable Loss	Ant Factor	Preamp Factor	Read Level	Limit Level	Over Limit	Remark
	MHz	dB	dB/m	dB	dBuV	dBuV/m	dBuV/m	dB
1	5135.632	7.55	34.31	42.31	49.80	49.35	54.00	-4.65 Average
2	5149.980	7.57	34.32	42.32	49.51	49.08	54.00	-4.92 Average
3	5270.000	7.79	34.42	42.33	93.75	93.63	-----	----- Average



Unless otherwise agreed in writing, this document is issued by the Company subject to its General Conditions of Service printed overleaf, available on request or accessible at <http://www.sgs.com/en/Terms-and-Conditions.aspx> and, for electronic format documents, subject to Terms and Conditions for Electronic Documents at <http://www.sgs.com/en/Terms-and-Conditions/Terms-e-Documents.aspx>. Attention is drawn to the limitation of liability, indemnification and jurisdiction issues defined therein. Any holder of this document is advised that information contained hereon reflects the Company's findings at the time of its intervention only and within the limits of Client's instructions, if any. The Company's sole responsibility is to its Client and this document does not exonerate parties to a transaction from exercising all their rights and obligations under the transaction documents. This document cannot be reproduced except in full, without prior written approval of the Company. Any unauthorized alteration, forgery or falsification of the content or appearance of this document is unlawful and offenders may be prosecuted to the fullest extent of the law. Unless otherwise stated the results shown in this test report refer only to the sample(s) tested and such sample(s) are retained for 30 days only.
 Attention: To check the authenticity of testing /inspection report & certificate, please contact us at telephone: (86-755) 8307 1443, or email: CN.Doccheck@sgs.com

Test Mode: 03; Polarity: Horizontal; Modulation:802.11n; Bandwidth:40MHz; Channel:High

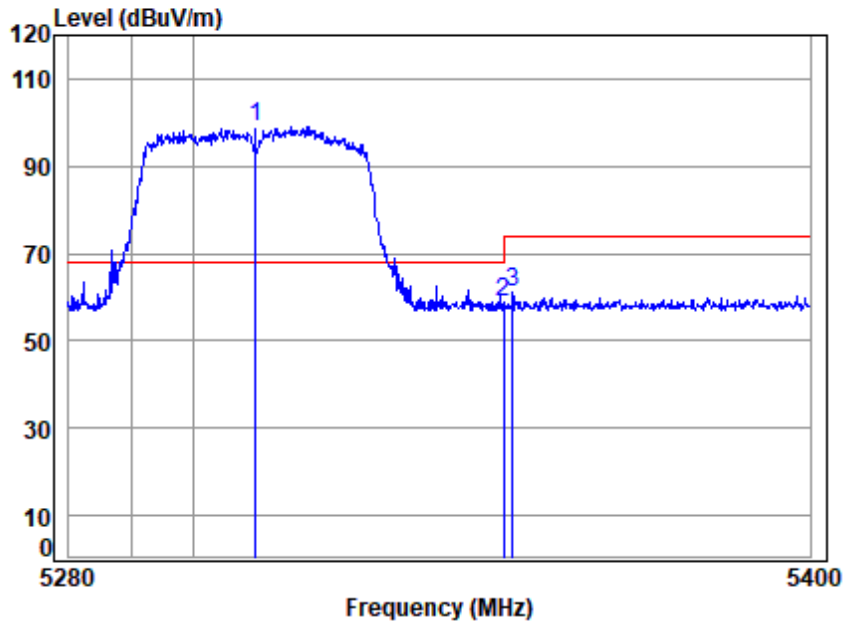

Site : chamber
 Condition: 3m HORIZONTAL
 Job No : 00028CR/00029CR
 Mode : 5310 Band edge
 : 5G WIFI 11N40

	Cable	Ant	Preamp	Read	Limit	Over		
Freq	Loss	Factor	Factor	Level	Level	Line	Limit	Remark
MHz	dB	dB/m	dB	dBuV	dBuV/m	dBuV/m	dB	
1 * 5310.000	7.86	34.45	42.33	99.07	99.05	68.20	30.85	peak
2 5350.020	7.92	34.48	42.34	58.83	58.89	74.00	-15.11	peak
3 5351.556	7.93	34.49	42.34	60.87	60.95	74.00	-13.05	peak



Unless otherwise agreed in writing, this document is issued by the Company subject to its General Conditions of Service printed overleaf, available on request or accessible at <http://www.sgs.com/en/Terms-and-Conditions.aspx> and, for electronic format documents, subject to Terms and Conditions for Electronic Documents at <http://www.sgs.com/en/Terms-and-Conditions/Terms-e-Documents.aspx>. Attention is drawn to the limitation of liability, indemnification and jurisdiction issues defined therein. Any holder of this document is advised that information contained hereon reflects the Company's findings at the time of its intervention only and within the limits of Client's instructions, if any. The Company's sole responsibility is to its Client and this document does not exonerate parties to a transaction from exercising all their rights and obligations under the transaction documents. This document cannot be reproduced except in full, without prior written approval of the Company. Any unauthorized alteration, forgery or falsification of the content or appearance of this document is unlawful and offenders may be prosecuted to the fullest extent of the law. Unless otherwise stated the results shown in this test report refer only to the sample(s) tested and such sample(s) are retained for 30 days only.
 Attention: To check the authenticity of testing /inspection report & certificate, please contact us at telephone: (86-755) 8307 1443, or email: CN.Doccheck@sgs.com

Test Mode: 03; Polarity: Horizontal; Modulation:802.11n; Bandwidth:40MHz; Channel:High

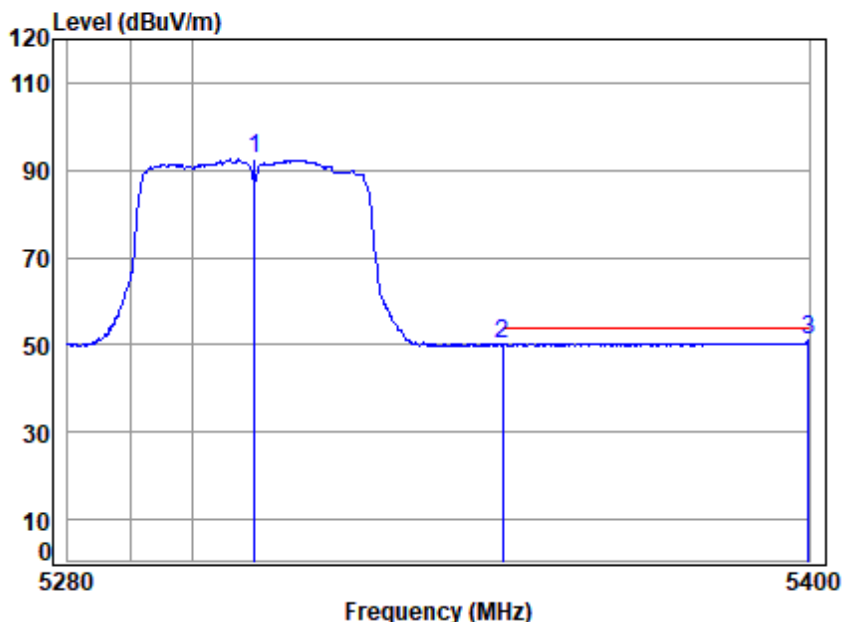

Site : chamber
 Condition: 3m HORIZONTAL
 Job No : 00028CR/00029CR
 Mode : 5310 Band edge
 : 5G WIFI 11N40

	Freq	Cable Loss	Ant Factor	Preamp Factor	Read Level	Limit Level	Over Limit	Remark
	MHz	dB	dB/m	dB	dBuV	dBuV/m	dBuV/m	dB
1	5310.000	7.86	34.45	42.33	92.47	92.45	-----	Average
2	5350.020	7.92	34.48	42.34	49.98	50.04	54.00	-3.96 Average
3	5399.878	8.01	34.52	42.34	50.71	50.90	54.00	-3.10 Average



Unless otherwise agreed in writing, this document is issued by the Company subject to its General Conditions of Service printed overleaf, available on request or accessible at <http://www.sgs.com/en/Terms-and-Conditions.aspx> and, for electronic format documents, subject to Terms and Conditions for Electronic Documents at <http://www.sgs.com/en/Terms-and-Conditions/Terms-e-Documents.aspx>. Attention is drawn to the limitation of liability, indemnification and jurisdiction issues defined therein. Any holder of this document is advised that information contained hereon reflects the Company's findings at the time of its intervention only and within the limits of Client's instructions, if any. The Company's sole responsibility is to its Client and this document does not exonerate parties to a transaction from exercising all their rights and obligations under the transaction documents. This document cannot be reproduced except in full, without prior written approval of the Company. Any unauthorized alteration, forgery or falsification of the content or appearance of this document is unlawful and offenders may be prosecuted to the fullest extent of the law. Unless otherwise stated the results shown in this test report refer only to the sample(s) tested and such sample(s) are retained for 30 days only.
 Attention: To check the authenticity of testing / inspection report & certificate, please contact us at telephone: (86-755) 8307 1443, or email: CN.Doccheck@sgs.com

Test Mode: 03; Polarity: Vertical; Modulation:802.11n; Bandwidth:40MHz; Channel:High

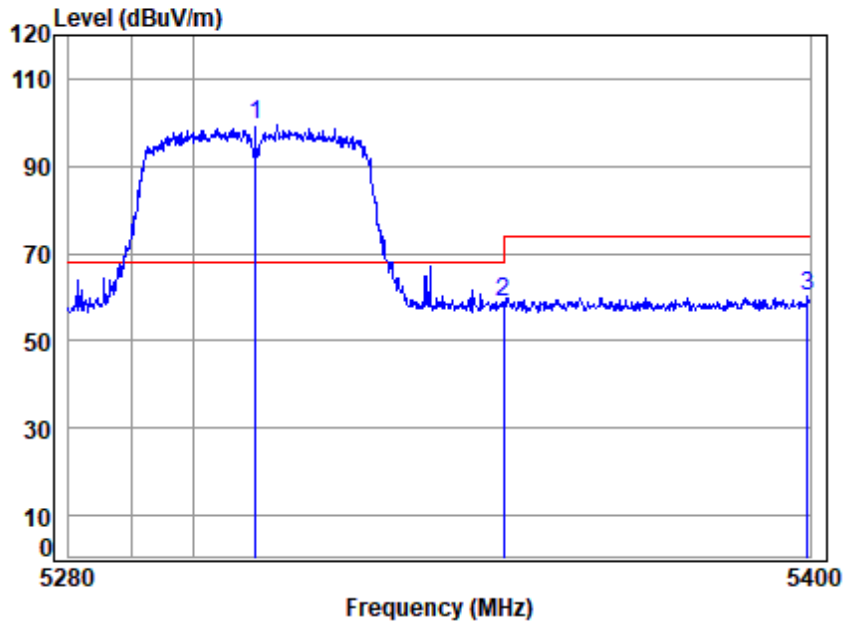

Site : chamber
 Condition: 3m VERTICAL
 Job No : 00028CR/00029CR
 Mode : 5310 Band edge
 : 5G WIFI 11N40

Freq	Cable Loss	Ant Factor	Preamp Factor	Read Level	Level	Limit Line	Over Limit	Remark
MHz	dB	dB/m	dB	dBuV	dBuV/m	dBuV/m	dB	
1 * 5310.000	7.86	34.45	42.33	99.53	99.51	68.20	31.31	Peak
2 5350.020	7.92	34.48	42.34	58.65	58.71	74.00	-15.29	Peak
3 5399.515	8.01	34.52	42.34	60.12	60.31	74.00	-13.69	Peak



Unless otherwise agreed in writing, this document is issued by the Company subject to its General Conditions of Service printed overleaf, available on request or accessible at <http://www.sgs.com/en/Terms-and-Conditions.aspx> and, for electronic format documents, subject to Terms and Conditions for Electronic Documents at <http://www.sgs.com/en/Terms-and-Conditions/Terms-e-Documents.aspx>. Attention is drawn to the limitation of liability, indemnification and jurisdiction issues defined therein. Any holder of this document is advised that information contained hereon reflects the Company's findings at the time of its intervention only and within the limits of Client's instructions, if any. The Company's sole responsibility is to its Client and this document does not exonerate parties to a transaction from exercising all their rights and obligations under the transaction documents. This document cannot be reproduced except in full, without prior written approval of the Company. Any unauthorized alteration, forgery or falsification of the content or appearance of this document is unlawful and offenders may be prosecuted to the fullest extent of the law. Unless otherwise stated the results shown in this test report refer only to the sample(s) tested and such sample(s) are retained for 30 days only.
 Attention: To check the authenticity of testing / inspection report & certificate, please contact us at telephone: (86-755) 8307 1443, or email: CN.Doccheck@sgs.com

Test Mode: 03; Polarity: Vertical; Modulation:802.11n; Bandwidth:40MHz; Channel:High

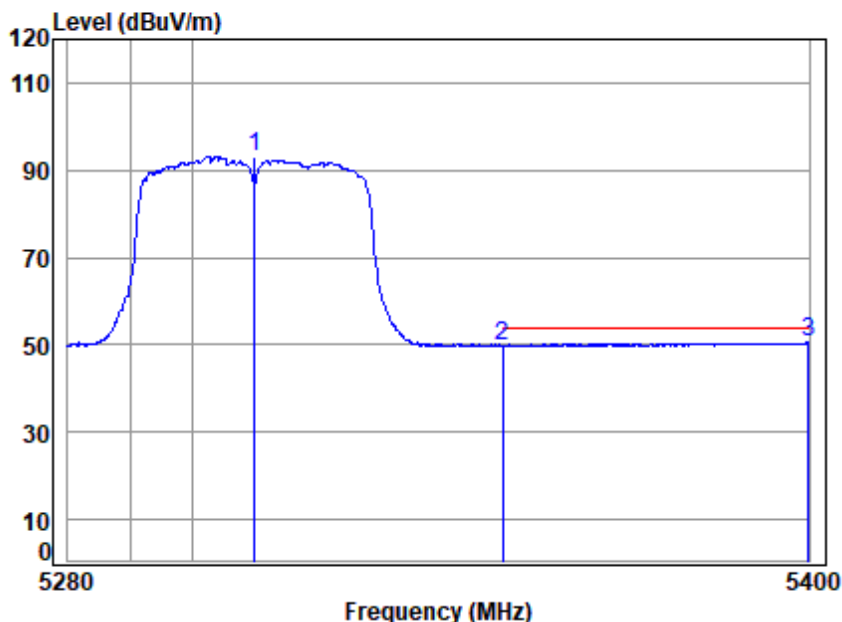

Site : chamber
 Condition: 3m VERTICAL
 Job No : 00028CR/00029CR
 Mode : 5310 Band edge
 : 5G WIFI 11N40

	Freq	Cable Loss	Ant Factor	Preamp Factor	Read Level	Limit Level	Over Line	Over Limit	Remark
	MHz	dB	dB/m	dB	dBuV	dBuV/m	dBuV/m	dB	
1	5310.000	7.86	34.45	42.33	93.24	93.22	-----	-----	Average
2	5350.020	7.92	34.48	42.34	49.87	49.93	54.00	-4.07	Average
3	5399.878	8.01	34.52	42.34	50.25	50.44	54.00	-3.56	Average



Unless otherwise agreed in writing, this document is issued by the Company subject to its General Conditions of Service printed overleaf, available on request or accessible at <http://www.sgs.com/en/Terms-and-Conditions.aspx> and, for electronic format documents, subject to Terms and Conditions for Electronic Documents at <http://www.sgs.com/en/Terms-and-Conditions/Terms-e-Documents.aspx>. Attention is drawn to the limitation of liability, indemnification and jurisdiction issues defined therein. Any holder of this document is advised that information contained hereon reflects the Company's findings at the time of its intervention only and within the limits of Client's instructions, if any. The Company's sole responsibility is to its Client and this document does not exonerate parties to a transaction from exercising all their rights and obligations under the transaction documents. This document cannot be reproduced except in full, without prior written approval of the Company. Any unauthorized alteration, forgery or falsification of the content or appearance of this document is unlawful and offenders may be prosecuted to the fullest extent of the law. Unless otherwise stated the results shown in this test report refer only to the sample(s) tested and such sample(s) are retained for 30 days only.
 Attention: To check the authenticity of testing / inspection report & certificate, please contact us at telephone: (86-755) 8307 1443, or email: CN.Doccheck@sgs.com

Test Mode: 03; Polarity: Horizontal; Modulation:802.11ac; Bandwidth:20MHz; Channel:Low

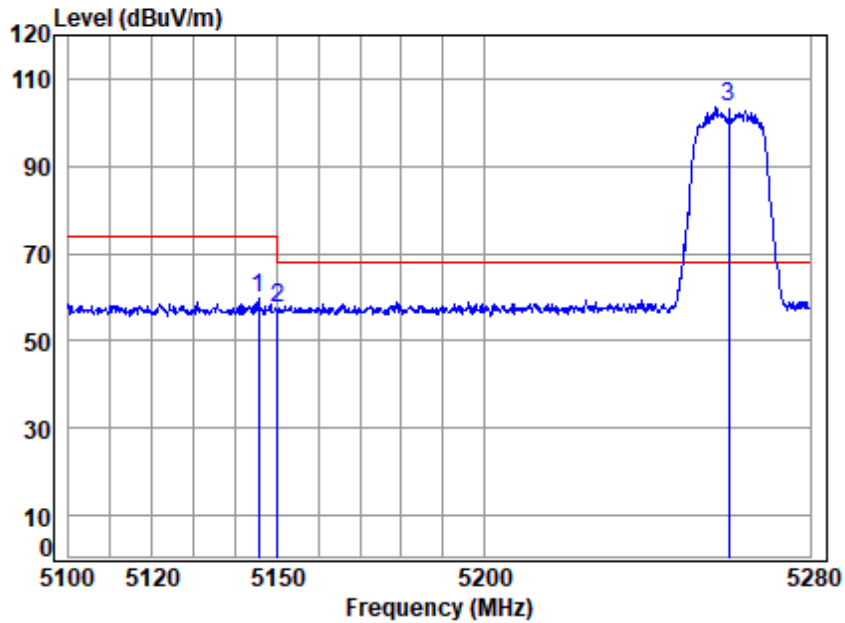

Site : chamber
 Condition: 3m HORIZONTAL
 Job No : 00028CR/00029CR
 Mode : 5260 Band edge
 : 5G WIFI 11AC20

	Cable	Ant	Preamp	Read	Limit	Over	
Freq	Loss	Factor	Factor	Level	Level	Line	Limit Remark
MHz	dB	dB/m	dB	dBuV	dBuV/m	dBuV/m	dB
1	5145.487	7.56	34.32	42.32	60.13	59.69	74.00 -14.31 peak
2	5149.980	7.57	34.32	42.32	58.02	57.59	74.00 -16.41 peak
3 *	5260.000	7.77	34.41	42.33	103.89	103.74	68.20 35.54 peak



Unless otherwise agreed in writing, this document is issued by the Company subject to its General Conditions of Service printed overleaf, available on request or accessible at <http://www.sgs.com/en/Terms-and-Conditions.aspx> and, for electronic format documents, subject to Terms and Conditions for Electronic Documents at <http://www.sgs.com/en/Terms-and-Conditions/Terms-e-Documents.aspx>. Attention is drawn to the limitation of liability, indemnification and jurisdiction issues defined therein. Any holder of this document is advised that information contained hereon reflects the Company's findings at the time of its intervention only and within the limits of Client's instructions, if any. The Company's sole responsibility is to its Client and this document does not exonerate parties to a transaction from exercising all their rights and obligations under the transaction documents. This document cannot be reproduced except in full, without prior written approval of the Company. Any unauthorized alteration, forgery or falsification of the content or appearance of this document is unlawful and offenders may be prosecuted to the fullest extent of the law. Unless otherwise stated the results shown in this test report refer only to the sample(s) tested and such sample(s) are retained for 30 days only.
 Attention: To check the authenticity of testing /inspection report & certificate, please contact us at telephone: (86-755) 8307 1443, or email: CN.Doccheck@sgs.com

Test Mode: 03; Polarity: Horizontal; Modulation:802.11ac; Bandwidth:20MHz; Channel:Low

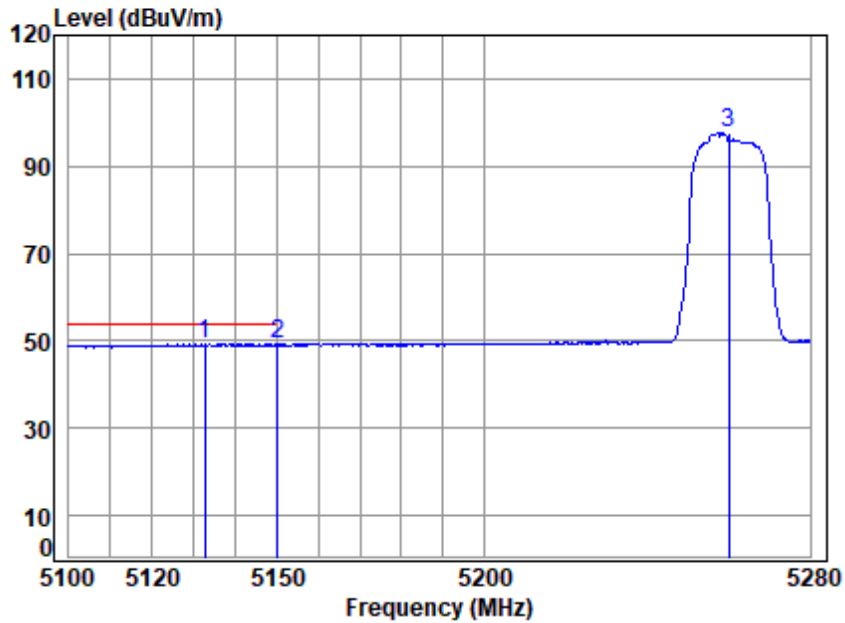

Site : chamber
 Condition: 3m HORIZONTAL
 Job No : 00028CR/00029CR
 Mode : 5260 Band edge
 : 5G WIFI 11AC20

	Cable	Ant	Preamp	Read	Limit	Over		
Freq	Loss	Factor	Factor	Level	Level	Line	Limit	Remark
MHz	dB	dB/m	dB	dBuV	dBuV/m	dBuV/m	dB	
1	7.54	34.31	42.31	49.76	49.30	54.00	-4.70	Average
2	7.57	34.32	42.32	49.56	49.13	54.00	-4.87	Average
3	7.77	34.41	42.33	97.72	97.57	-----	-----	Average



Unless otherwise agreed in writing, this document is issued by the Company subject to its General Conditions of Service printed overleaf, available on request or accessible at <http://www.sgs.com/en/Terms-and-Conditions.aspx> and, for electronic format documents, subject to Terms and Conditions for Electronic Documents at <http://www.sgs.com/en/Terms-and-Conditions/Terms-e-Documents.aspx>. Attention is drawn to the limitation of liability, indemnification and jurisdiction issues defined therein. Any holder of this document is advised that information contained hereon reflects the Company's findings at the time of its intervention only and within the limits of Client's instructions, if any. The Company's sole responsibility is to its Client and this document does not exonerate parties to a transaction from exercising all their rights and obligations under the transaction documents. This document cannot be reproduced except in full, without prior written approval of the Company. Any unauthorized alteration, forgery or falsification of the content or appearance of this document is unlawful and offenders may be prosecuted to the fullest extent of the law. Unless otherwise stated the results shown in this test report refer only to the sample(s) tested and such sample(s) are retained for 30 days only.
 Attention: To check the authenticity of testing /inspection report & certificate, please contact us at telephone: (86-755) 8307 1443, or email: CN.Doccheck@sgs.com

Test Mode: 03; Polarity: Vertical; Modulation:802.11ac; Bandwidth:20MHz; Channel:Low

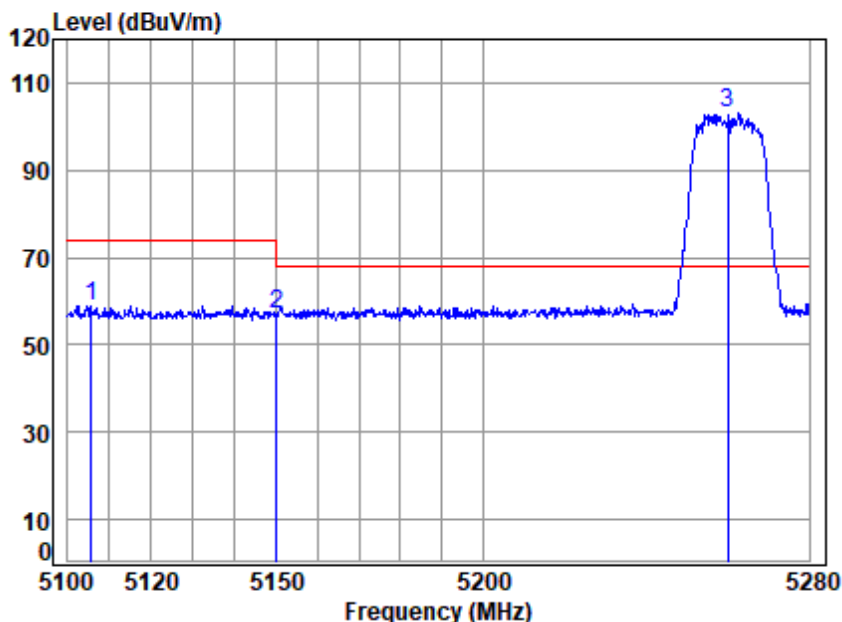

Site : chamber
 Condition: 3m VERTICAL
 Job No : 00028CR/00029CR
 Mode : 5260 Band edge
 : 5G WIFI 11AC20

	Cable	Ant	Preamp	Read	Limit	Over		
Freq	Loss	Factor	Factor	Level	Level	Line	Limit	Remark
MHz	dB	dB/m	dB	dBuV	dBuV/m	dBuV/m	dB	
1	7.49	34.29	42.31	59.37	58.84	74.00	-15.16	Peak
2	7.57	34.32	42.32	57.50	57.07	74.00	-16.93	Peak
3 *	7.77	34.41	42.33	103.26	103.11	68.20	34.91	Peak



Unless otherwise agreed in writing, this document is issued by the Company subject to its General Conditions of Service printed overleaf, available on request or accessible at <http://www.sgs.com/en/Terms-and-Conditions.aspx> and, for electronic format documents, subject to Terms and Conditions for Electronic Documents at <http://www.sgs.com/en/Terms-and-Conditions/Terms-e-Documents.aspx>. Attention is drawn to the limitation of liability, indemnification and jurisdiction issues defined therein. Any holder of this document is advised that information contained hereon reflects the Company's findings at the time of its intervention only and within the limits of Client's instructions, if any. The Company's sole responsibility is to its Client and this document does not exonerate parties to a transaction from exercising all their rights and obligations under the transaction documents. This document cannot be reproduced except in full, without prior written approval of the Company. Any unauthorized alteration, forgery or falsification of the content or appearance of this document is unlawful and offenders may be prosecuted to the fullest extent of the law. Unless otherwise stated the results shown in this test report refer only to the sample(s) tested and such sample(s) are retained for 30 days only.
 Attention: To check the authenticity of testing / inspection report & certificate, please contact us at telephone: (86-755) 8307 1443, or email: CN.Doccheck@sgs.com

Test Mode: 03; Polarity: Vertical; Modulation:802.11ac; Bandwidth:20MHz; Channel:Low

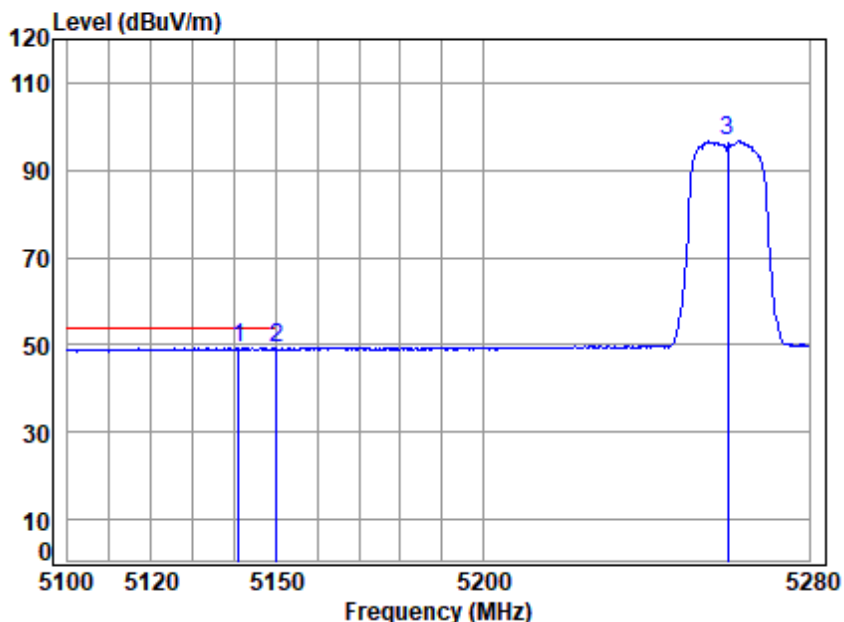

Site : chamber
 Condition: 3m VERTICAL
 Job No : 00028CR/00029CR
 Mode : 5260 Band edge
 : 5G WIFI 11AC20

	Freq	Cable Loss	Ant Factor	Preamp Factor	Read Level	Limit Level	Over Limit	Remark
	MHz	dB	dB/m	dB	dBuV	dBuV/m	dBuV/m	dB
1	5140.849	7.56	34.32	42.32	49.66	49.22	54.00	-4.78 Average
2	5149.980	7.57	34.32	42.32	49.51	49.08	54.00	-4.92 Average
3	5260.000	7.77	34.41	42.33	96.71	96.56	-----	----- Average



Unless otherwise agreed in writing, this document is issued by the Company subject to its General Conditions of Service printed overleaf, available on request or accessible at <http://www.sgs.com/en/Terms-and-Conditions.aspx> and, for electronic format documents, subject to Terms and Conditions for Electronic Documents at <http://www.sgs.com/en/Terms-and-Conditions/Terms-e-Documents.aspx>. Attention is drawn to the limitation of liability, indemnification and jurisdiction issues defined therein. Any holder of this document is advised that information contained hereon reflects the Company's findings at the time of its intervention only and within the limits of Client's instructions, if any. The Company's sole responsibility is to its Client and this document does not exonerate parties to a transaction from exercising all their rights and obligations under the transaction documents. This document cannot be reproduced except in full, without prior written approval of the Company. Any unauthorized alteration, forgery or falsification of the content or appearance of this document is unlawful and offenders may be prosecuted to the fullest extent of the law. Unless otherwise stated the results shown in this test report refer only to the sample(s) tested and such sample(s) are retained for 30 days only.
 Attention: To check the authenticity of testing / inspection report & certificate, please contact us at telephone: (86-755) 8307 1443, or email: CN.Doccheck@sgs.com

Test Mode: 03; Polarity: Horizontal; Modulation:802.11ac; Bandwidth:20MHz; Channel:High

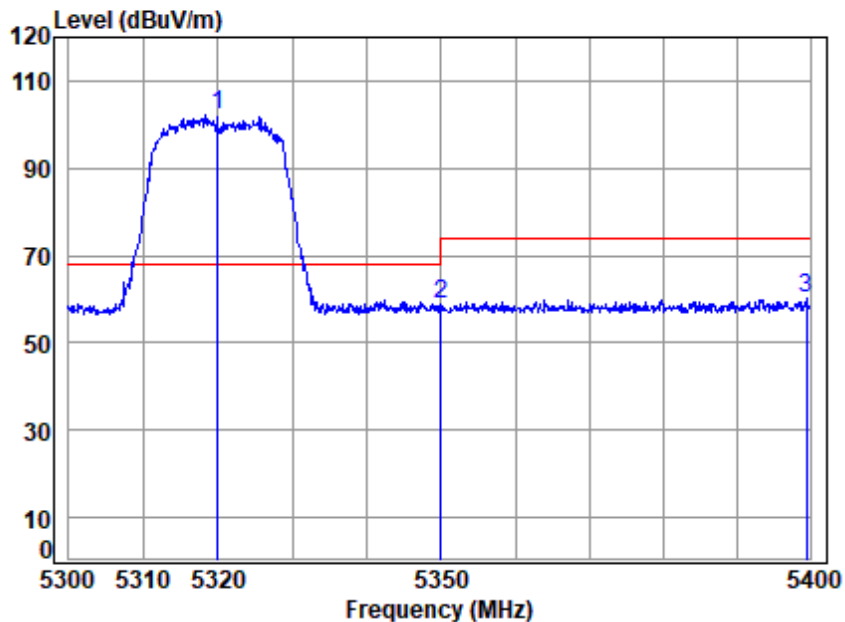

Site : chamber
 Condition: 3m HORIZONTAL
 Job No : 00028CR/00029CR
 Mode : 5320 Band edge
 : 5G WIFI 11AC20

Freq	Cable Loss	Ant Factor	Preamp Factor	Read Level	Limit Level	Over Limit	Remark
MHz	dB	dB/m	dB	dBuV	dBuV/m	dBuV/m	dB
1 * 5320.000	7.87	34.46	42.33	102.22	102.22	68.20	34.02 peak
2 5350.020	7.92	34.48	42.34	58.72	58.78	74.00	-15.22 peak
3 5399.495	8.01	34.52	42.34	59.99	60.18	74.00	-13.82 peak



Unless otherwise agreed in writing, this document is issued by the Company subject to its General Conditions of Service printed overleaf, available on request or accessible at <http://www.sgs.com/en/Terms-and-Conditions.aspx> and, for electronic format documents, subject to Terms and Conditions for Electronic Documents at <http://www.sgs.com/en/Terms-and-Conditions/Terms-e-Documents.aspx>. Attention is drawn to the limitation of liability, indemnification and jurisdiction issues defined therein. Any holder of this document is advised that information contained hereon reflects the Company's findings at the time of its intervention only and within the limits of Client's instructions, if any. The Company's sole responsibility is to its Client and this document does not exonerate parties to a transaction from exercising all their rights and obligations under the transaction documents. This document cannot be reproduced except in full, without prior written approval of the Company. Any unauthorized alteration, forgery or falsification of the content or appearance of this document is unlawful and offenders may be prosecuted to the fullest extent of the law. Unless otherwise stated the results shown in this test report refer only to the sample(s) tested and such sample(s) are retained for 30 days only.
 Attention: To check the authenticity of testing /inspection report & certificate, please contact us at telephone: (86-755) 8307 1443, or email: CN.Doccheck@sgs.com

Test Mode: 03; Polarity: Horizontal; Modulation:802.11ac; Bandwidth:20MHz; Channel:High

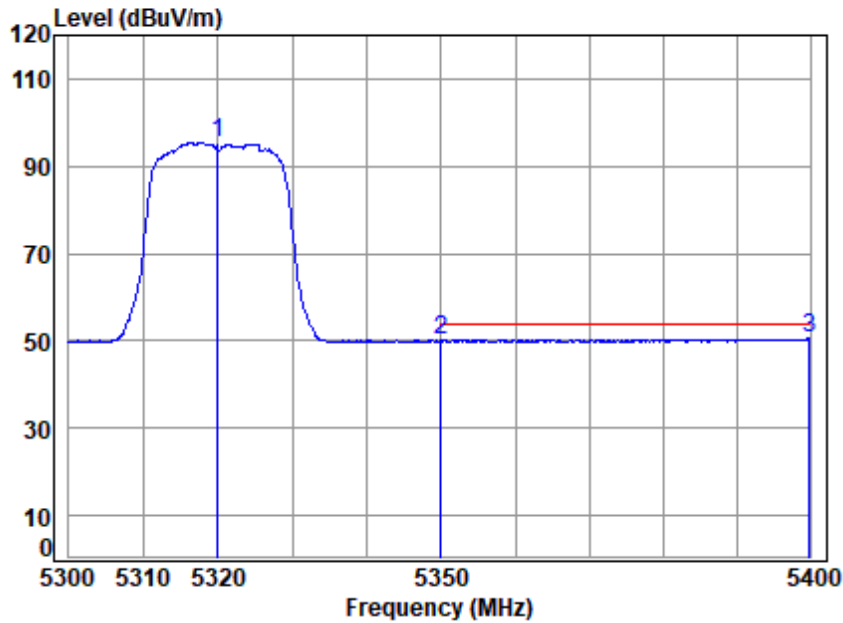

Site : chamber
 Condition: 3m HORIZONTAL
 Job No : 00028CR/00029CR
 Mode : 5320 Band edge
 : 5G WIFI 11AC20

	Freq	Cable Loss	Ant Factor	Preamp Factor	Read Level	Limit Level	Over Limit	Remark
	MHz	dB	dB/m	dB	dBuV	dBuV/m	dBuV/m	dB
1	5320.000	7.87	34.46	42.33	95.46	95.46	-----	Average
2	5350.020	7.92	34.48	42.34	49.96	50.02	54.00	-3.98 Average
3	5399.899	8.01	34.52	42.34	50.30	50.49	54.00	-3.51 Average



Unless otherwise agreed in writing, this document is issued by the Company subject to its General Conditions of Service printed overleaf, available on request or accessible at <http://www.sgs.com/en/Terms-and-Conditions.aspx> and, for electronic format documents, subject to Terms and Conditions for Electronic Documents at <http://www.sgs.com/en/Terms-and-Conditions/Terms-e-Documents.aspx>. Attention is drawn to the limitation of liability, indemnification and jurisdiction issues defined therein. Any holder of this document is advised that information contained hereon reflects the Company's findings at the time of its intervention only and within the limits of Client's instructions, if any. The Company's sole responsibility is to its Client and this document does not exonerate parties to a transaction from exercising all their rights and obligations under the transaction documents. This document cannot be reproduced except in full, without prior written approval of the Company. Any unauthorized alteration, forgery or falsification of the content or appearance of this document is unlawful and offenders may be prosecuted to the fullest extent of the law. Unless otherwise stated the results shown in this test report refer only to the sample(s) tested and such sample(s) are retained for 30 days only.
 Attention: To check the authenticity of testing /inspection report & certificate, please contact us at telephone: (86-755) 8307 1443, or email: CN.Doccheck@sgs.com

Test Mode: 03; Polarity: Vertical; Modulation:802.11ac; Bandwidth:20MHz; Channel:High

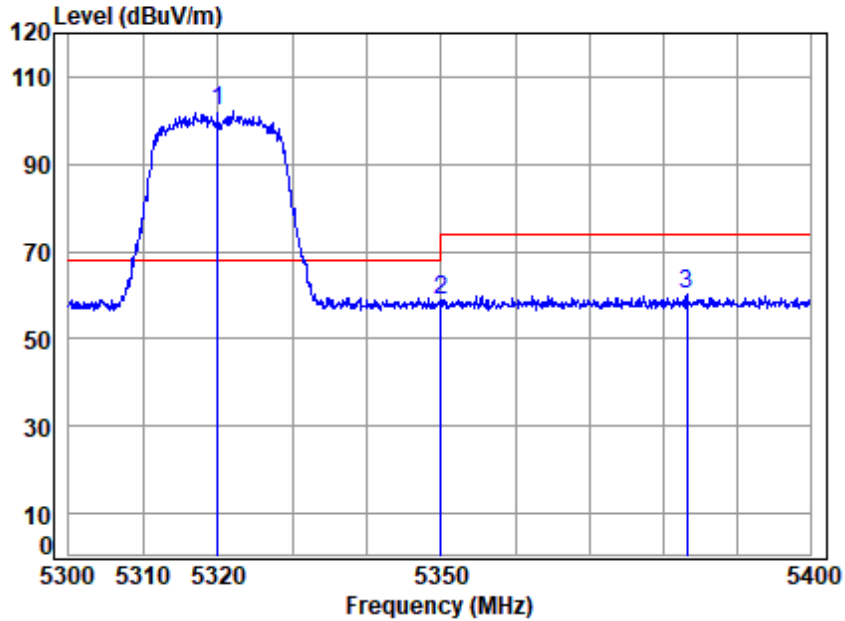

Site : chamber
 Condition: 3m VERTICAL
 Job No : 00028CR/00029CR
 Mode : 5320 Band edge
 : 5G WIFI 11AC20

Freq	Cable Loss	Ant Factor	Preamp Factor	Read Level	Limit Level	Over Line	Remark
MHz	dB	dB/m	dB	dBuV	dBuV/m	dBuV/m	dB
1 * 5320.000	7.87	34.46	42.33	102.14	102.14	68.20	33.94 Peak
2 5350.020	7.92	34.48	42.34	58.90	58.96	74.00	-15.04 Peak
3 5383.271	7.98	34.51	42.34	60.08	60.23	74.00	-13.77 Peak



Unless otherwise agreed in writing, this document is issued by the Company subject to its General Conditions of Service printed overleaf, available on request or accessible at <http://www.sgs.com/en/Terms-and-Conditions.aspx> and, for electronic format documents, subject to Terms and Conditions for Electronic Documents at <http://www.sgs.com/en/Terms-and-Conditions/Terms-e-Documents.aspx>. Attention is drawn to the limitation of liability, indemnification and jurisdiction issues defined therein. Any holder of this document is advised that information contained hereon reflects the Company's findings at the time of its intervention only and within the limits of Client's instructions, if any. The Company's sole responsibility is to its Client and this document does not exonerate parties to a transaction from exercising all their rights and obligations under the transaction documents. This document cannot be reproduced except in full, without prior written approval of the Company. Any unauthorized alteration, forgery or falsification of the content or appearance of this document is unlawful and offenders may be prosecuted to the fullest extent of the law. Unless otherwise stated the results shown in this test report refer only to the sample(s) tested and such sample(s) are retained for 30 days only.
 Attention: To check the authenticity of testing / inspection report & certificate, please contact us at telephone: (86-755) 8307 1443, or email: CN.Doccheck@sgs.com

Test Mode: 03; Polarity: Vertical; Modulation:802.11ac; Bandwidth:20MHz; Channel:High

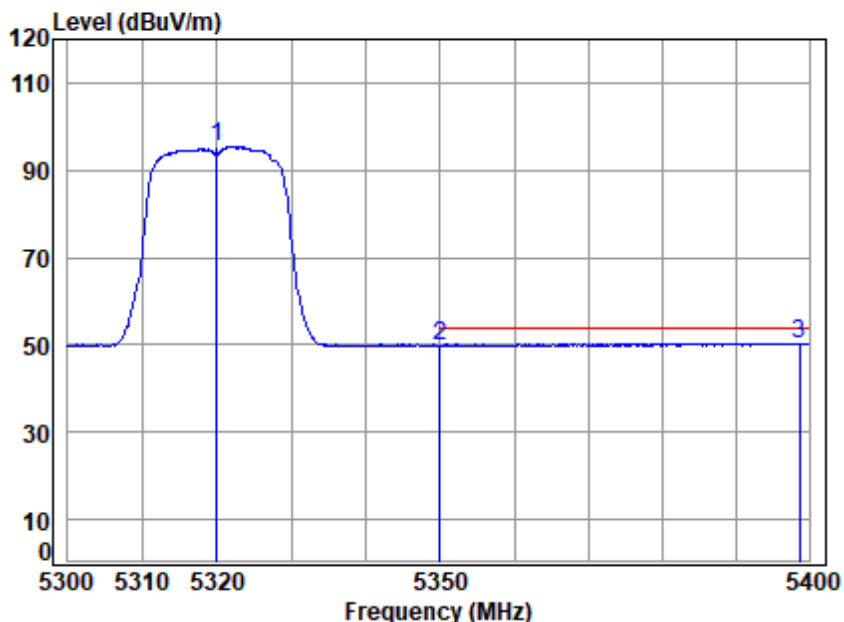

Site : chamber
 Condition: 3m VERTICAL
 Job No : 00028CR/00029CR
 Mode : 5320 Band edge
 : 5G WIFI 11AC20

	Cable	Ant	Preamp	Read	Limit	Over		
Freq	Loss	Factor	Factor	Level	Level	Line	Limit	Remark
MHz	dB	dB/m	dB	dBuV	dBuV/m	dBuV/m	dB	
1 5320.000	7.87	34.46	42.33	95.43	95.43	-----	-----	Average
2 5350.020	7.92	34.48	42.34	49.88	49.94	54.00	-4.06	Average
3 5398.688	8.01	34.52	42.34	50.12	50.31	54.00	-3.69	Average



Unless otherwise agreed in writing, this document is issued by the Company subject to its General Conditions of Service printed overleaf, available on request or accessible at <http://www.sgs.com/en/Terms-and-Conditions.aspx> and, for electronic format documents, subject to Terms and Conditions for Electronic Documents at <http://www.sgs.com/en/Terms-and-Conditions/Terms-e-Documents.aspx>. Attention is drawn to the limitation of liability, indemnification and jurisdiction issues defined therein. Any holder of this document is advised that information contained hereon reflects the Company's findings at the time of its intervention only and within the limits of Client's instructions, if any. The Company's sole responsibility is to its Client and this document does not exonerate parties to a transaction from exercising all their rights and obligations under the transaction documents. This document cannot be reproduced except in full, without prior written approval of the Company. Any unauthorized alteration, forgery or falsification of the content or appearance of this document is unlawful and offenders may be prosecuted to the fullest extent of the law. Unless otherwise stated the results shown in this test report refer only to the sample(s) tested and such sample(s) are retained for 30 days only.
 Attention: To check the authenticity of testing / inspection report & certificate, please contact us at telephone: (86-755) 8307 1443, or email: CN.Doccheck@sgs.com

Test Mode: 03; Polarity: Horizontal; Modulation:802.11ac; Bandwidth:40MHz; Channel:Low

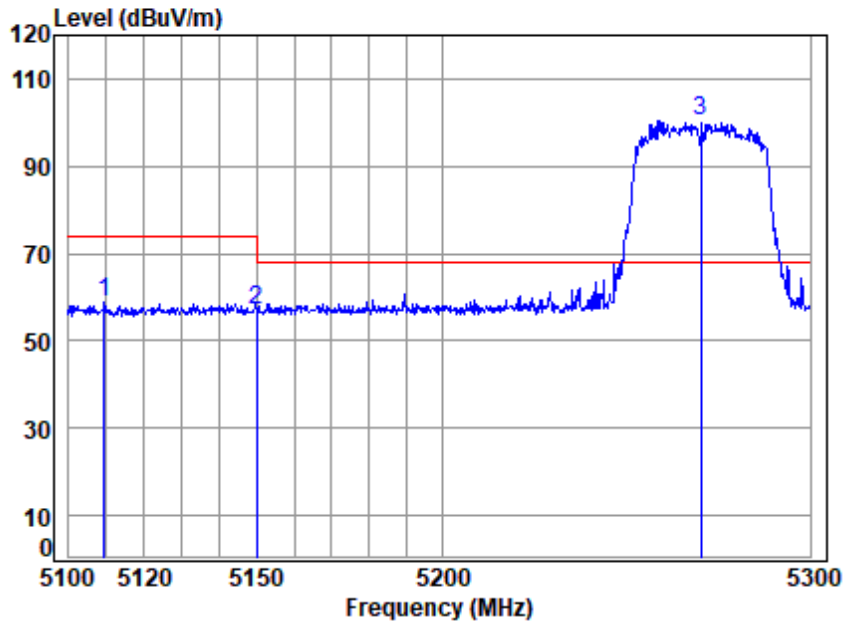

Site : chamber
 Condition: 3m HORIZONTAL
 Job No : 00028CR/00029CR
 Mode : 5270 Band edge
 : 5G WIFI 11AC40

	Freq	Cable Loss	Ant Factor	Preamp Factor	Read Level	Limit Level	Over Limit	Remark
	MHz	dB	dB/m	dB	dBuV	dBuV/m	dBuV/m	dB
1	5109.425	7.50	34.29	42.31	59.18	58.66	74.00	-15.34 peak
2	5149.980	7.57	34.32	42.32	57.38	56.95	74.00	-17.05 peak
3 *	5270.000	7.79	34.42	42.33	100.39	100.27	68.20	32.07 peak



Unless otherwise agreed in writing, this document is issued by the Company subject to its General Conditions of Service printed overleaf, available on request or accessible at <http://www.sgs.com/en/Terms-and-Conditions.aspx> and, for electronic format documents, subject to Terms and Conditions for Electronic Documents at <http://www.sgs.com/en/Terms-and-Conditions/Terms-e-Documents.aspx>. Attention is drawn to the limitation of liability, indemnification and jurisdiction issues defined therein. Any holder of this document is advised that information contained hereon reflects the Company's findings at the time of its intervention only and within the limits of Client's instructions, if any. The Company's sole responsibility is to its Client and this document does not exonerate parties to a transaction from exercising all their rights and obligations under the transaction documents. This document cannot be reproduced except in full, without prior written approval of the Company. Any unauthorized alteration, forgery or falsification of the content or appearance of this document is unlawful and offenders may be prosecuted to the fullest extent of the law. Unless otherwise stated the results shown in this test report refer only to the sample(s) tested and such sample(s) are retained for 30 days only.
 Attention: To check the authenticity of testing /inspection report & certificate, please contact us at telephone: (86-755) 8307 1443, or email: CN.Doccheck@sgs.com

Test Mode: 03; Polarity: Horizontal; Modulation:802.11ac; Bandwidth:40MHz; Channel:Low

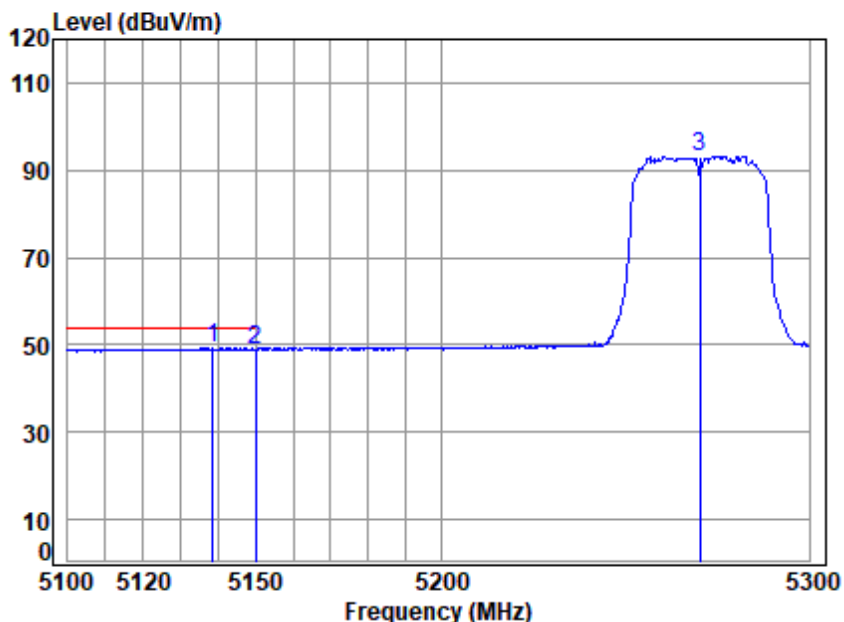

Site : chamber
 Condition: 3m HORIZONTAL
 Job No : 00028CR/00029CR
 Mode : 5270 Band edge
 : 5G WIFI 11AC40

	Freq	Cable Loss	Ant Factor	Preamp Factor	Read Level	Level	Limit Line	Over Limit	Remark
	MHz	dB	dB/m	dB	dBuV	dBuV/m	dBuV/m	dB	
1	5138.596	7.55	34.31	42.31	49.63	49.18	54.00	-4.82	Average
2	5149.980	7.57	34.32	42.32	49.47	49.04	54.00	-4.96	Average
3	5270.000	7.79	34.42	42.33	93.34	93.22	-----	-----	Average



Unless otherwise agreed in writing, this document is issued by the Company subject to its General Conditions of Service printed overleaf, available on request or accessible at <http://www.sgs.com/en/Terms-and-Conditions.aspx> and, for electronic format documents, subject to Terms and Conditions for Electronic Documents at <http://www.sgs.com/en/Terms-and-Conditions/Terms-e-Documents.aspx>. Attention is drawn to the limitation of liability, indemnification and jurisdiction issues defined therein. Any holder of this document is advised that information contained hereon reflects the Company's findings at the time of its intervention only and within the limits of Client's instructions, if any. The Company's sole responsibility is to its Client and this document does not exonerate parties to a transaction from exercising all their rights and obligations under the transaction documents. This document cannot be reproduced except in full, without prior written approval of the Company. Any unauthorized alteration, forgery or falsification of the content or appearance of this document is unlawful and offenders may be prosecuted to the fullest extent of the law. Unless otherwise stated the results shown in this test report refer only to the sample(s) tested and such sample(s) are retained for 30 days only.
 Attention: To check the authenticity of testing / inspection report & certificate, please contact us at telephone: (86-755) 8307 1443, or email: CN.Doccheck@sgs.com

Test Mode: 03; Polarity: Vertical; Modulation:802.11ac; Bandwidth:40MHz; Channel:Low

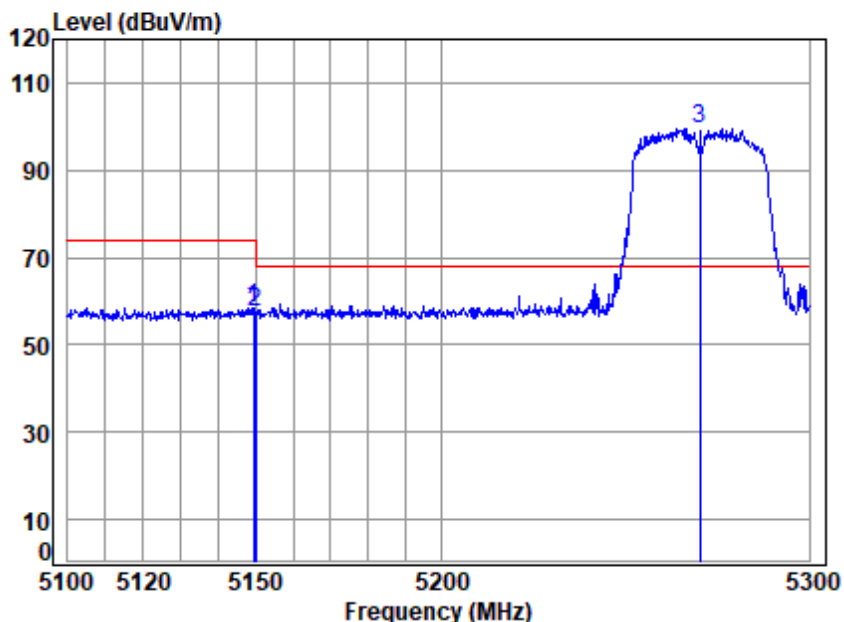

Site : chamber
 Condition: 3m VERTICAL
 Job No : 00028CR/00029CR
 Mode : 5270 Band edge
 : 5G WIFI 11AC40

	Freq	Cable Loss	Ant Factor	Preamp Factor	Read Level	Limit Level	Over Limit	Remark
	MHz	dB	dB/m	dB	dBuV	dBuV/m	dBuV/m	dB
1	5149.479	7.57	34.32	42.32	59.04	58.61	74.00	-15.39 Peak
2	5149.980	7.57	34.32	42.32	57.79	57.36	74.00	-16.64 Peak
3 *	5270.000	7.79	34.42	42.33	99.58	99.46	68.20	31.26 Peak



Unless otherwise agreed in writing, this document is issued by the Company subject to its General Conditions of Service printed overleaf, available on request or accessible at <http://www.sgs.com/en/Terms-and-Conditions.aspx> and, for electronic format documents, subject to Terms and Conditions for Electronic Documents at <http://www.sgs.com/en/Terms-and-Conditions/Terms-e-Documents.aspx>. Attention is drawn to the limitation of liability, indemnification and jurisdiction issues defined therein. Any holder of this document is advised that information contained hereon reflects the Company's findings at the time of its intervention only and within the limits of Client's instructions, if any. The Company's sole responsibility is to its Client and this document does not exonerate parties to a transaction from exercising all their rights and obligations under the transaction documents. This document cannot be reproduced except in full, without prior written approval of the Company. Any unauthorized alteration, forgery or falsification of the content or appearance of this document is unlawful and offenders may be prosecuted to the fullest extent of the law. Unless otherwise stated the results shown in this test report refer only to the sample(s) tested and such sample(s) are retained for 30 days only.
 Attention: To check the authenticity of testing / inspection report & certificate, please contact us at telephone: (86-755) 8307 1443, or email: CN.Doccheck@sgs.com

Test Mode: 03; Polarity: Vertical; Modulation:802.11ac; Bandwidth:40MHz; Channel:Low

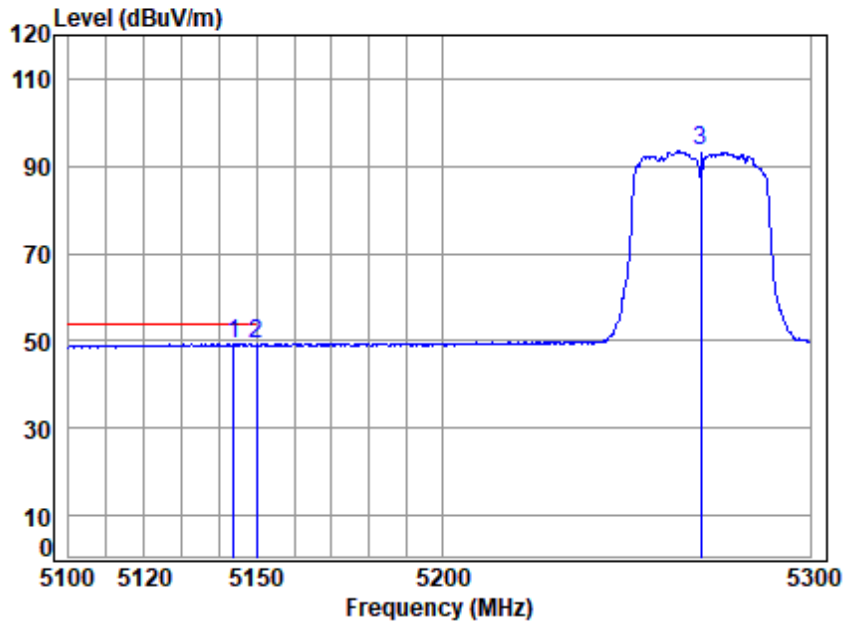

Site : chamber
 Condition: 3m VERTICAL
 Job No : 00028CR/00029CR
 Mode : 5270 Band edge
 : 5G WIFI 11AC40

	Freq	Cable Loss	Ant Factor	Preamp Factor	Read Level	Limit Level	Over Limit	Remark
	MHz	dB	dB/m	dB	dBuV	dBuV/m	dB	
1	5143.738	7.56	34.32	42.32	49.67	54.00	-4.77	Average
2	5149.980	7.57	34.32	42.32	49.54	54.00	-4.89	Average
3	5270.000	7.79	34.42	42.33	93.64	-----	-----	Average



Test Mode: 03; Polarity: Horizontal; Modulation:802.11ac; Bandwidth:40MHz; Channel:High

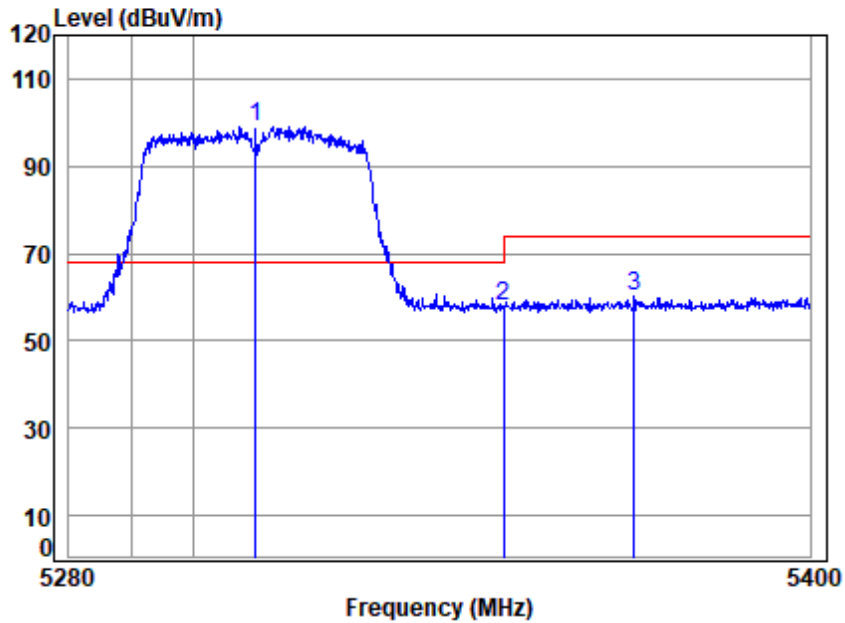

Site : chamber
 Condition: 3m HORIZONTAL
 Job No : 00028CR/00029CR
 Mode : 5310 Band edge
 : 5G WIFI 11AC40

	Cable	Ant	Preamp	Read	Limit	Over	
Freq	Loss	Factor	Factor	Level	Level	Line	Limit
MHz	dB	dB/m	dB	dBuV	dBuV/m	dBuV/m	dB
1 * 5310.000	7.86	34.45	42.33	99.10	99.08	68.20	30.88 peak
2 5350.020	7.92	34.48	42.34	57.74	57.80	74.00	-16.20 peak
3 5371.316	7.96	34.50	42.34	59.92	60.04	74.00	-13.96 peak



Unless otherwise agreed in writing, this document is issued by the Company subject to its General Conditions of Service printed overleaf, available on request or accessible at <http://www.sgs.com/en/Terms-and-Conditions.aspx> and, for electronic format documents, subject to Terms and Conditions for Electronic Documents at <http://www.sgs.com/en/Terms-and-Conditions/Terms-e-Documents.aspx>. Attention is drawn to the limitation of liability, indemnification and jurisdiction issues defined therein. Any holder of this document is advised that information contained hereon reflects the Company's findings at the time of its intervention only and within the limits of Client's instructions, if any. The Company's sole responsibility is to its Client and this document does not exonerate parties to a transaction from exercising all their rights and obligations under the transaction documents. This document cannot be reproduced except in full, without prior written approval of the Company. Any unauthorized alteration, forgery or falsification of the content or appearance of this document is unlawful and offenders may be prosecuted to the fullest extent of the law. Unless otherwise stated the results shown in this test report refer only to the sample(s) tested and such sample(s) are retained for 30 days only.
 Attention: To check the authenticity of testing /inspection report & certificate, please contact us at telephone: (86-755) 8307 1443, or email: CN.Doccheck@sgs.com

Test Mode: 03; Polarity: Horizontal; Modulation:802.11ac; Bandwidth:40MHz; Channel:High

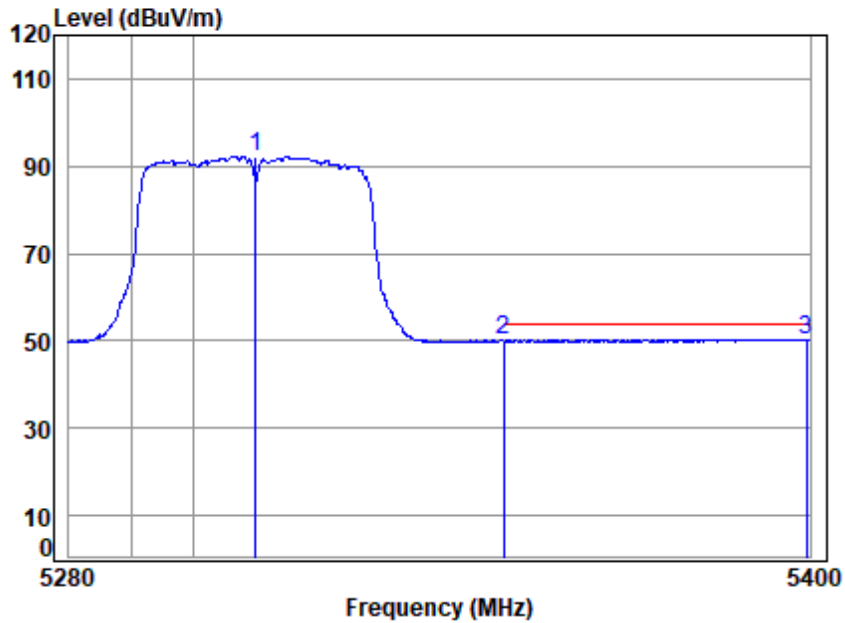

Site : chamber
 Condition: 3m HORIZONTAL
 Job No : 00028CR/00029CR
 Mode : 5310 Band edge
 : 5G WIFI 11AC40

	Freq	Cable Loss	Ant Factor	Preamp Factor	Read Level	Limit Level	Over Limit	Remark
	MHz	dB	dB/m	dB	dBuV	dBuV/m	dBuV/m	dB
1	5310.000	7.86	34.45	42.33	92.36	92.34	-----	Average
2	5350.020	7.92	34.48	42.34	49.93	49.99	54.00	-4.01 Average
3	5399.393	8.01	34.52	42.34	50.18	50.37	54.00	-3.63 Average



Unless otherwise agreed in writing, this document is issued by the Company subject to its General Conditions of Service printed overleaf, available on request or accessible at <http://www.sgs.com/en/Terms-and-Conditions.aspx> and, for electronic format documents, subject to Terms and Conditions for Electronic Documents at <http://www.sgs.com/en/Terms-and-Conditions/Terms-e-Documents.aspx>. Attention is drawn to the limitation of liability, indemnification and jurisdiction issues defined therein. Any holder of this document is advised that information contained hereon reflects the Company's findings at the time of its intervention only and within the limits of Client's instructions, if any. The Company's sole responsibility is to its Client and this document does not exonerate parties to a transaction from exercising all their rights and obligations under the transaction documents. This document cannot be reproduced except in full, without prior written approval of the Company. Any unauthorized alteration, forgery or falsification of the content or appearance of this document is unlawful and offenders may be prosecuted to the fullest extent of the law. Unless otherwise stated the results shown in this test report refer only to the sample(s) tested and such sample(s) are retained for 30 days only.
 Attention: To check the authenticity of testing /inspection report & certificate, please contact us at telephone: (86-755) 8307 1443, or email: CN.Doccheck@sgs.com

Test Mode: 03; Polarity: Vertical; Modulation:802.11ac; Bandwidth:40MHz; Channel:High

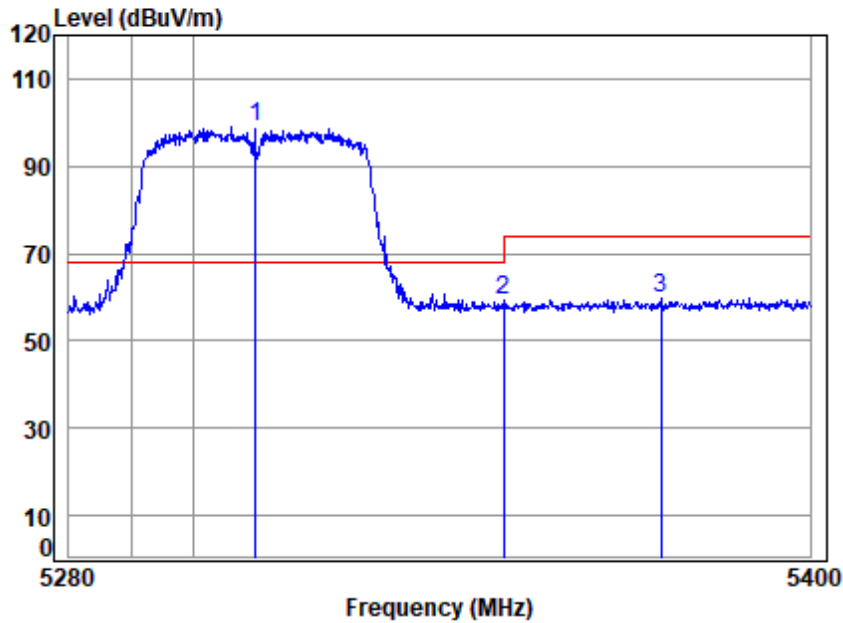

Site : chamber
 Condition: 3m VERTICAL
 Job No : 00028CR/00029CR
 Mode : 5310 Band edge
 : 5G WIFI 11AC40

	Cable	Ant	Preamp	Read	Limit	Over	
Freq	Loss	Factor	Factor	Level	Level	Line	Limit Remark
MHz	dB	dB/m	dB	dBuV	dBuV/m	dBuV/m	dB
1 * 5310.000	7.86	34.45	42.33	98.91	98.89	68.20	30.69 Peak
2 5350.020	7.92	34.48	42.34	59.40	59.46	74.00	-14.54 Peak
3 5375.663	7.97	34.50	42.34	59.54	59.67	74.00	-14.33 Peak



Test Mode: 03; Polarity: Vertical; Modulation:802.11ac; Bandwidth:40MHz; Channel:High

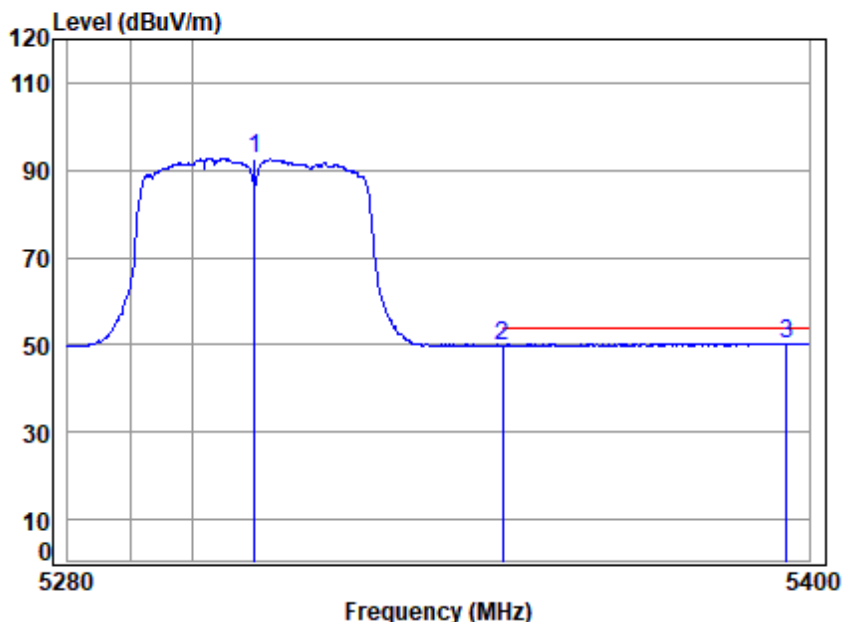

Site : chamber
 Condition: 3m VERTICAL
 Job No : 00028CR/00029CR
 Mode : 5310 Band edge
 : 5G WIFI 11AC40

	Freq	Cable Loss	Ant Factor	Preamp Factor	Read Level	Limit Level	Limit Line	Over Limit	Remark
	MHz	dB	dB/m	dB	dBuV	dBuV/m	dBuV/m	dB	
1	5310.000	7.86	34.45	42.33	92.65	92.63	-----	-----	Average
2	5350.020	7.92	34.48	42.34	49.82	49.88	54.00	-4.12	Average
3	5396.361	8.00	34.52	42.34	50.20	50.38	54.00	-3.62	Average



Unless otherwise agreed in writing, this document is issued by the Company subject to its General Conditions of Service printed overleaf, available on request or accessible at <http://www.sgs.com/en/Terms-and-Conditions.aspx> and, for electronic format documents, subject to Terms and Conditions for Electronic Documents at <http://www.sgs.com/en/Terms-and-Conditions/Terms-e-Documents.aspx>. Attention is drawn to the limitation of liability, indemnification and jurisdiction issues defined therein. Any holder of this document is advised that information contained hereon reflects the Company's findings at the time of its intervention only and within the limits of Client's instructions, if any. The Company's sole responsibility is to its Client and this document does not exonerate parties to a transaction from exercising all their rights and obligations under the transaction documents. This document cannot be reproduced except in full, without prior written approval of the Company. Any unauthorized alteration, forgery or falsification of the content or appearance of this document is unlawful and offenders may be prosecuted to the fullest extent of the law. Unless otherwise stated the results shown in this test report refer only to the sample(s) tested and such sample(s) are retained for 30 days only.
 Attention: To check the authenticity of testing / inspection report & certificate, please contact us at telephone: (86-755) 8307 1443, or email: CN.Doccheck@sgs.com

Test Mode: 03; Polarity: Horizontal; Modulation:802.11ac; Bandwidth:80MHz; Channel:middle

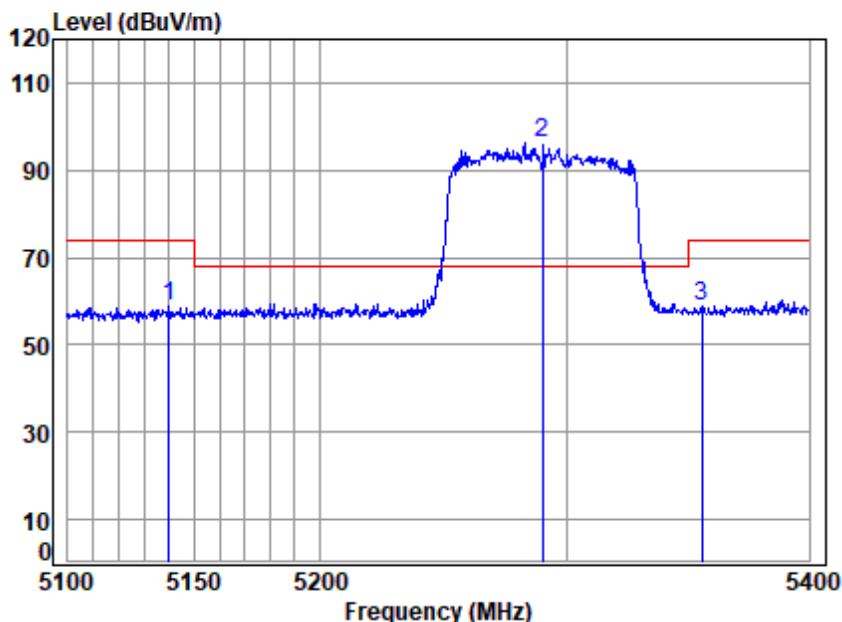

Site : chamber
 Condition: 3m HORIZONTAL
 Job No : 00028CR/00029CR
 Mode : 5290 Band edge
 : 5G WIFI 11AC80

	Freq	Cable Loss	Ant Factor	Preamp Factor	Read Level	Limit Level	Over Limit	Remark
	MHz	dB	dB/m	dB	dBuV	dBuV/m	dBuV/m	dB
1	5140.093	7.56	34.32	42.32	59.13	58.69	74.00	-15.31 peak
2 *	5290.000	7.82	34.44	42.33	96.18	96.11	68.20	27.91 peak
3	5355.430	7.93	34.49	42.34	58.59	58.67	74.00	-15.33 peak



Unless otherwise agreed in writing, this document is issued by the Company subject to its General Conditions of Service printed overleaf, available on request or accessible at <http://www.sgs.com/en/Terms-and-Conditions.aspx> and, for electronic format documents, subject to Terms and Conditions for Electronic Documents at <http://www.sgs.com/en/Terms-and-Conditions/Terms-e-Documents.aspx>. Attention is drawn to the limitation of liability, indemnification and jurisdiction issues defined therein. Any holder of this document is advised that information contained hereon reflects the Company's findings at the time of its intervention only and within the limits of Client's instructions, if any. The Company's sole responsibility is to its Client and this document does not exonerate parties to a transaction from exercising all their rights and obligations under the transaction documents. This document cannot be reproduced except in full, without prior written approval of the Company. Any unauthorized alteration, forgery or falsification of the content or appearance of this document is unlawful and offenders may be prosecuted to the fullest extent of the law. Unless otherwise stated the results shown in this test report refer only to the sample(s) tested and such sample(s) are retained for 30 days only.
 Attention: To check the authenticity of testing / inspection report & certificate, please contact us at telephone: (86-755) 8307 1443, or email: CN.Doccheck@sgs.com

Test Mode: 03; Polarity: Horizontal; Modulation:802.11ac; Bandwidth:80MHz; Channel:middle

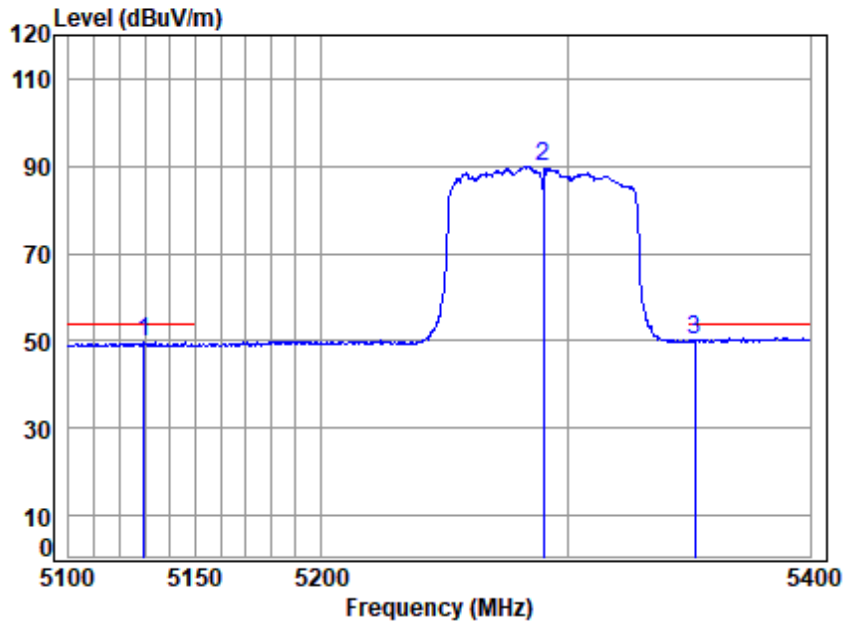

Site : chamber
 Condition: 3m HORIZONTAL
 Job No : 00028CR/00029CR
 Mode : 5290 Band edge
 : 5G WIFI 11AC80

	Freq	Cable Loss	Ant Factor	Preamp Factor	Read Level	Limit Level	Over Limit	Remark
	MHz	dB	dB/m	dB	dBuV	dBuV/m	dBuV/m	dB
1	5129.821	7.54	34.31	42.31	50.05	49.59	54.00	-4.41 Average
2	5290.000	7.82	34.44	42.33	90.04	89.97	-----	----- Average
3	5352.370	7.93	34.49	42.34	50.17	50.25	54.00	-3.75 Average



Unless otherwise agreed in writing, this document is issued by the Company subject to its General Conditions of Service printed overleaf, available on request or accessible at <http://www.sgs.com/en/Terms-and-Conditions.aspx> and, for electronic format documents, subject to Terms and Conditions for Electronic Documents at <http://www.sgs.com/en/Terms-and-Conditions/Terms-e-Documents.aspx>. Attention is drawn to the limitation of liability, indemnification and jurisdiction issues defined therein. Any holder of this document is advised that information contained hereon reflects the Company's findings at the time of its intervention only and within the limits of Client's instructions, if any. The Company's sole responsibility is to its Client and this document does not exonerate parties to a transaction from exercising all their rights and obligations under the transaction documents. This document cannot be reproduced except in full, without prior written approval of the Company. Any unauthorized alteration, forgery or falsification of the content or appearance of this document is unlawful and offenders may be prosecuted to the fullest extent of the law. Unless otherwise stated the results shown in this test report refer only to the sample(s) tested and such sample(s) are retained for 30 days only.
 Attention: To check the authenticity of testing / inspection report & certificate, please contact us at telephone: (86-755) 8307 1443, or email: CN.Doccheck@sgs.com

Test Mode: 03; Polarity: Vertical; Modulation:802.11ac; Bandwidth:80MHz; Channel:middle

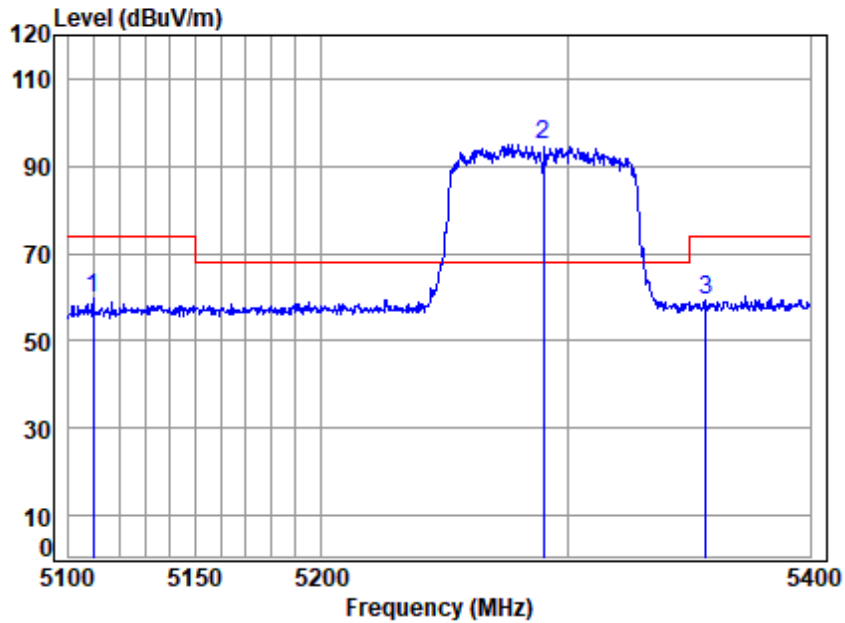

Site : chamber
 Condition: 3m VERTICAL
 Job No : 00028CR/00029CR
 Mode : 5290 Band edge
 : 5G WIFI 11AC80

	Cable	Ant	Preamp	Read	Limit	Over	
Freq	Loss	Factor	Factor	Level	Line	Limit	Remark
MHz	dB	dB/m	dB	dBuV	dBuV/m	dBuV/m	dB
1	7.50	34.29	42.31	60.23	59.71	74.00	-14.29 Peak
2 *	7.82	34.44	42.33	94.86	94.79	68.20	26.59 Peak
3	7.94	34.49	42.34	59.35	59.44	74.00	-14.56 Peak



Test Mode: 03; Polarity: Vertical; Modulation:802.11ac; Bandwidth:80MHz; Channel:middle

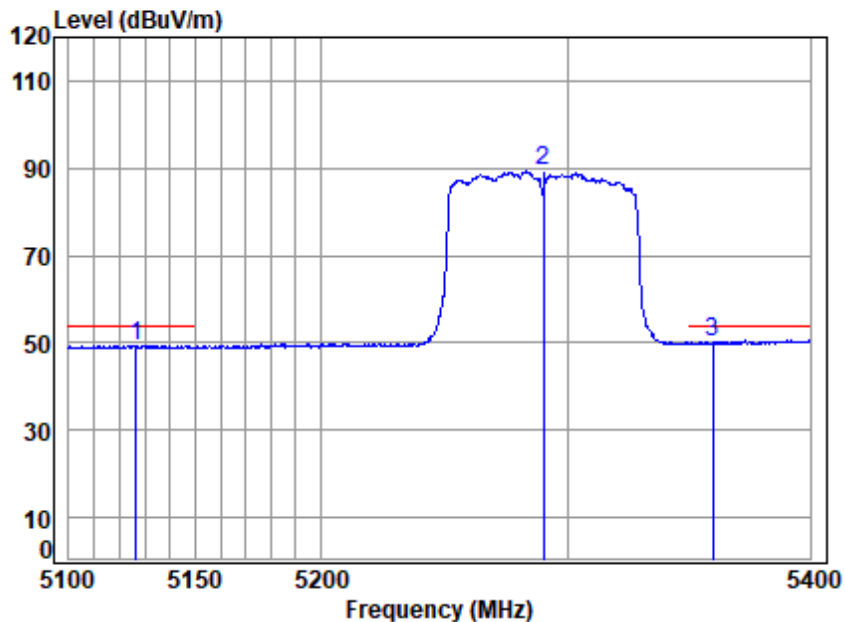

Site : chamber
 Condition: 3m VERTICAL
 Job No : 00028CR/00029CR
 Mode : 5290 Band edge
 : 5G WIFI 11AC80

	Freq	Cable Loss	Ant Factor	Preamp Factor	Read Level	Limit Level	Over Limit	Remark
	MHz	dB	dB/m	dB	dBuV	dBuV/m	dBuV/m	dB
1	5126.596	7.53	34.30	42.31	49.90	49.42	54.00	-4.58 Average
2	5290.000	7.82	34.44	42.33	89.51	89.44	-----	----- Average
3	5359.717	7.94	34.49	42.34	49.99	50.08	54.00	-3.92 Average



Unless otherwise agreed in writing, this document is issued by the Company subject to its General Conditions of Service printed overleaf, available on request or accessible at <http://www.sgs.com/en/Terms-and-Conditions.aspx> and, for electronic format documents, subject to Terms and Conditions for Electronic Documents at <http://www.sgs.com/en/Terms-and-Conditions/Terms-e-Documents.aspx>. Attention is drawn to the limitation of liability, indemnification and jurisdiction issues defined therein. Any holder of this document is advised that information contained hereon reflects the Company's findings at the time of its intervention only and within the limits of Client's instructions, if any. The Company's sole responsibility is to its Client and this document does not exonerate parties to a transaction from exercising all their rights and obligations under the transaction documents. This document cannot be reproduced except in full, without prior written approval of the Company. Any unauthorized alteration, forgery or falsification of the content or appearance of this document is unlawful and offenders may be prosecuted to the fullest extent of the law. Unless otherwise stated the results shown in this test report refer only to the sample(s) tested and such sample(s) are retained for 30 days only.
 Attention: To check the authenticity of testing / inspection report & certificate, please contact us at telephone: (86-755) 8307 1443, or email: CN.Doccheck@sgs.com

Test Mode: 04; Polarity: Horizontal; Modulation:802.11a; Bandwidth:20MHz; Channel:Low

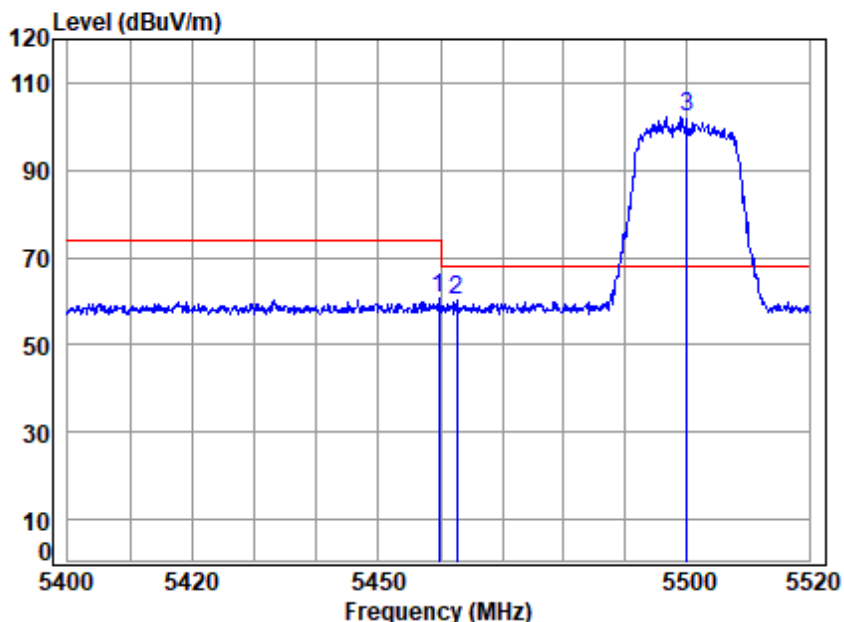

Site : chamber
 Condition: 3m HORIZONTAL
 Job No : 00028CR/00029CR
 Mode : 5500 Band edge
 : 5G WIFI 11A

	Freq	Cable Loss	Ant Factor	Preamp Factor	Read Level	Level	Limit Line	Over Limit	Remark
	MHz	dB	dB/m	dB	dBuV	dBuV/m	dBuV/m	dB	
1	5459.791	8.11	34.57	42.35	60.25	60.58	74.00	-13.42	peak
2	5462.671	8.12	34.57	42.35	59.86	60.20	68.20	-8.00	peak
3 *	5500.000	8.18	34.60	42.35	101.89	102.32	68.20	34.12	peak



Unless otherwise agreed in writing, this document is issued by the Company subject to its General Conditions of Service printed overleaf, available on request or accessible at <http://www.sgs.com/en/Terms-and-Conditions.aspx> and, for electronic format documents, subject to Terms and Conditions for Electronic Documents at <http://www.sgs.com/en/Terms-and-Conditions/Terms-e-Documents.aspx>. Attention is drawn to the limitation of liability, indemnification and jurisdiction issues defined therein. Any holder of this document is advised that information contained hereon reflects the Company's findings at the time of its intervention only and within the limits of Client's instructions, if any. The Company's sole responsibility is to its Client and this document does not exonerate parties to a transaction from exercising all their rights and obligations under the transaction documents. This document cannot be reproduced except in full, without prior written approval of the Company. Any unauthorized alteration, forgery or falsification of the content or appearance of this document is unlawful and offenders may be prosecuted to the fullest extent of the law. Unless otherwise stated the results shown in this test report refer only to the sample(s) tested and such sample(s) are retained for 30 days only.
 Attention: To check the authenticity of testing /inspection report & certificate, please contact us at telephone: (86-755) 8307 1443, or email: CN.Doccheck@sgs.com

Test Mode: 04; Polarity: Horizontal; Modulation:802.11a; Bandwidth:20MHz; Channel:Low

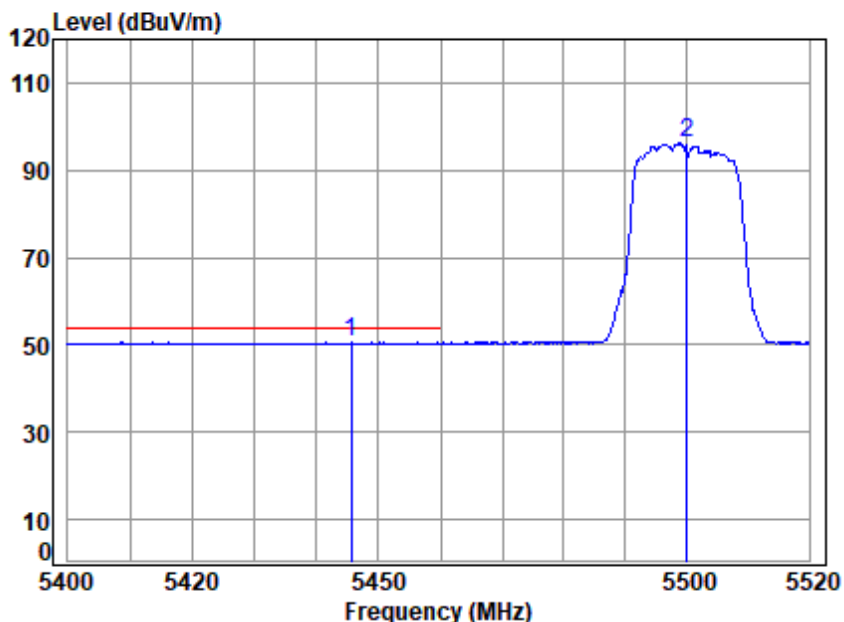

Site : chamber
 Condition: 3m HORIZONTAL
 Job No : 00028CR/00029CR
 Mode : 5500 Band edge
 : 5G WIFI 11A

	Freq	Cable Loss	Ant Factor	Preamp Factor	Read Level	Limit Level	Over Limit	Remark
	MHz	dB	dB/m	dB	dBuV	dBuV/m	dBuV/m	dB
1	5445.529	8.09	34.56	42.35	50.18	50.48	54.00	-3.52 Average
2	5500.000	8.18	34.60	42.35	95.73	96.16	-----	----- Average



Unless otherwise agreed in writing, this document is issued by the Company subject to its General Conditions of Service printed overleaf, available on request or accessible at <http://www.sgs.com/en/Terms-and-Conditions.aspx> and, for electronic format documents, subject to Terms and Conditions for Electronic Documents at <http://www.sgs.com/en/Terms-and-Conditions/Terms-e-Documents.aspx>. Attention is drawn to the limitation of liability, indemnification and jurisdiction issues defined therein. Any holder of this document is advised that information contained hereon reflects the Company's findings at the time of its intervention only and within the limits of Client's instructions, if any. The Company's sole responsibility is to its Client and this document does not exonerate parties to a transaction from exercising all their rights and obligations under the transaction documents. This document cannot be reproduced except in full, without prior written approval of the Company. Any unauthorized alteration, forgery or falsification of the content or appearance of this document is unlawful and offenders may be prosecuted to the fullest extent of the law. Unless otherwise stated the results shown in this test report refer only to the sample(s) tested and such sample(s) are retained for 30 days only.
 Attention: To check the authenticity of testing / inspection report & certificate, please contact us at telephone: (86-755) 8307 1443, or email: CN.Doccheck@sgs.com

Test Mode: 04; Polarity: Vertical; Modulation:802.11a; Bandwidth:20MHz; Channel:Low

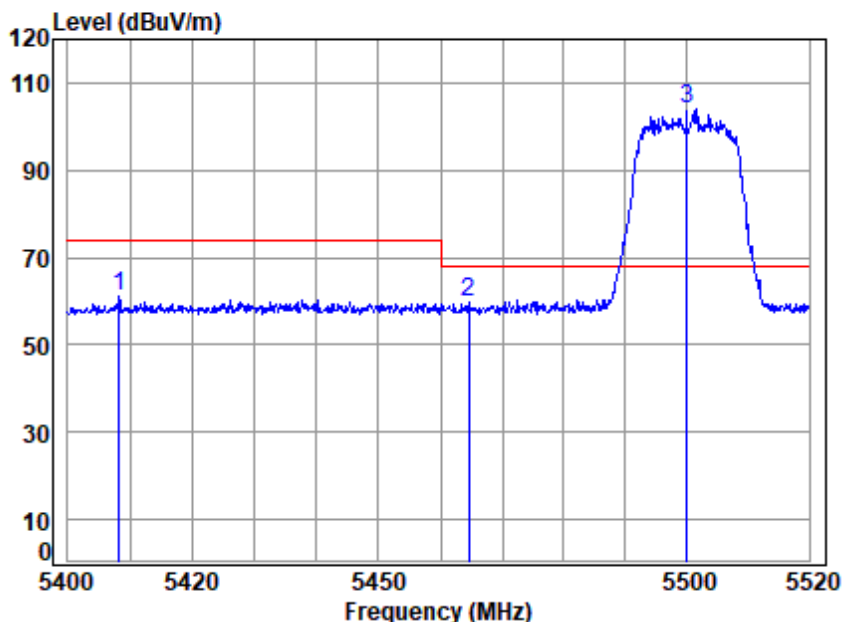

Site : chamber
 Condition: 3m VERTICAL
 Job No : 00028CR/00029CR
 Mode : 5500 Band edge
 : 5G WIFI 11A

	Cable	Ant	Preamp	Read	Limit	Over	
Freq	Loss	Factor	Factor	Level	Level	Line	Limit Remark
MHz	dB	dB/m	dB	dBuV	dBuV/m	dBuV/m	dB
1	5408.314	8.02	34.53	42.34	60.96	61.17	74.00 -12.83 Peak
2	5464.592	8.12	34.57	42.35	59.58	59.92	68.20 -8.28 peak
3 *	5500.000	8.18	34.60	42.35	103.42	103.85	68.20 35.65 Peak



Unless otherwise agreed in writing, this document is issued by the Company subject to its General Conditions of Service printed overleaf, available on request or accessible at <http://www.sgs.com/en/Terms-and-Conditions.aspx> and, for electronic format documents, subject to Terms and Conditions for Electronic Documents at <http://www.sgs.com/en/Terms-and-Conditions/Terms-e-Documents.aspx>. Attention is drawn to the limitation of liability, indemnification and jurisdiction issues defined therein. Any holder of this document is advised that information contained hereon reflects the Company's findings at the time of its intervention only and within the limits of Client's instructions, if any. The Company's sole responsibility is to its Client and this document does not exonerate parties to a transaction from exercising all their rights and obligations under the transaction documents. This document cannot be reproduced except in full, without prior written approval of the Company. Any unauthorized alteration, forgery or falsification of the content or appearance of this document is unlawful and offenders may be prosecuted to the fullest extent of the law. Unless otherwise stated the results shown in this test report refer only to the sample(s) tested and such sample(s) are retained for 30 days only.
 Attention: To check the authenticity of testing /inspection report & certificate, please contact us at telephone: (86-755) 8307 1443, or email: CN.Doccheck@sgs.com

Test Mode: 04; Polarity: Vertical; Modulation:802.11a; Bandwidth:20MHz; Channel:Low

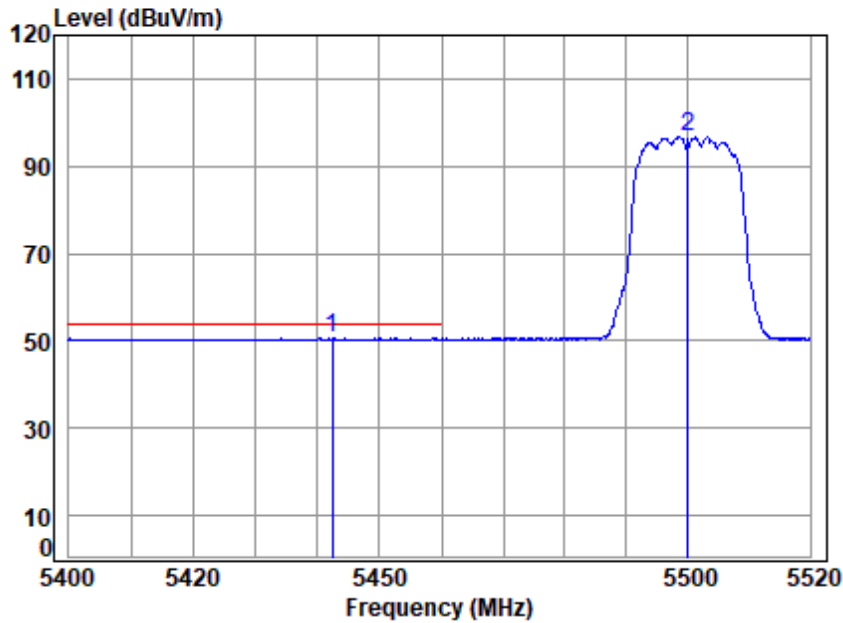

Site : chamber
 Condition: 3m VERTICAL
 Job No : 00028CR/00029CR
 Mode : 5500 Band edge
 : 5G WIFI 11A

	Freq	Cable Loss	Ant Factor	Preamp Factor	Read Level	Limit Level	Over Limit	Remark
	MHz	dB	dB/m	dB	dBuV	dBuV/m	dBuV/m	dB
1	5442.418	8.08	34.56	42.35	50.34	50.63	54.00	-3.37 Average
2	5500.000	8.18	34.60	42.35	96.14	96.57	-----	----- Average



Unless otherwise agreed in writing, this document is issued by the Company subject to its General Conditions of Service printed overleaf, available on request or accessible at <http://www.sgs.com/en/Terms-and-Conditions.aspx> and, for electronic format documents, subject to Terms and Conditions for Electronic Documents at <http://www.sgs.com/en/Terms-and-Conditions/Terms-e-Documents.aspx>. Attention is drawn to the limitation of liability, indemnification and jurisdiction issues defined therein. Any holder of this document is advised that information contained hereon reflects the Company's findings at the time of its intervention only and within the limits of Client's instructions, if any. The Company's sole responsibility is to its Client and this document does not exonerate parties to a transaction from exercising all their rights and obligations under the transaction documents. This document cannot be reproduced except in full, without prior written approval of the Company. Any unauthorized alteration, forgery or falsification of the content or appearance of this document is unlawful and offenders may be prosecuted to the fullest extent of the law. Unless otherwise stated the results shown in this test report refer only to the sample(s) tested and such sample(s) are retained for 30 days only.
 Attention: To check the authenticity of testing / inspection report & certificate, please contact us at telephone: (86-755) 8307 1443, or email: CN.Doccheck@sgs.com

Test Mode: 04; Polarity: Horizontal; Modulation:802.11a; Bandwidth:20MHz; Channel:High

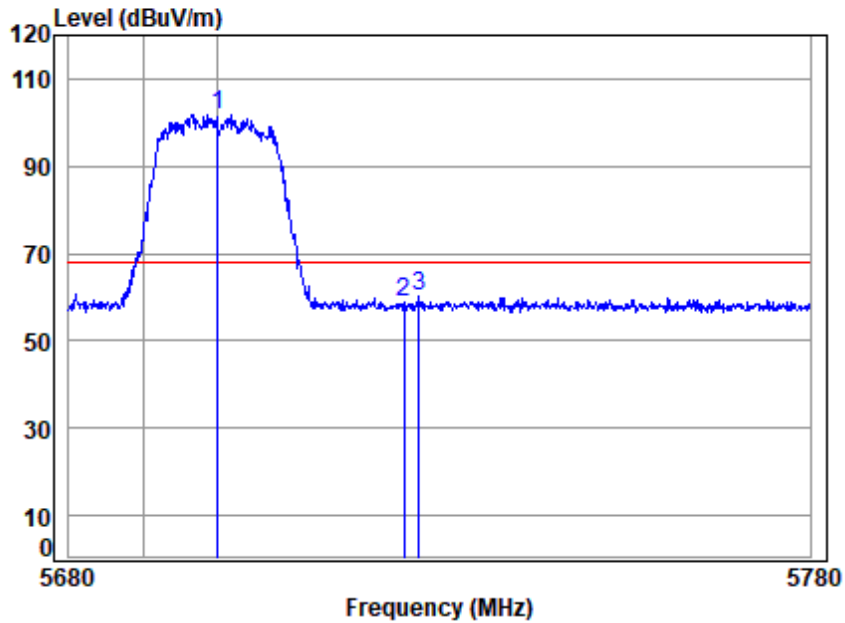

Site : chamber
 Condition: 3m HORIZONTAL
 Job No : 00028CR/00029CR
 Mode : 5700 Band edge
 : 5G WIFI 11A

Freq	Cable Loss	Ant Factor	Preamp Factor	Read Level	Level	Limit Line	Over Limit	Remark
MHz	dB	dB/m	dB	dBuV	dBuV/m	dBuV/m	dB	
1 * 5700.000	8.21	34.81	42.37	101.29	101.94	68.20	33.74	peak
2 5725.000	8.22	34.83	42.37	58.00	58.68	68.20	-9.52	peak
3 5726.982	8.22	34.83	42.37	59.38	60.06	68.20	-8.14	peak



Unless otherwise agreed in writing, this document is issued by the Company subject to its General Conditions of Service printed overleaf, available on request or accessible at <http://www.sgs.com/en/Terms-and-Conditions.aspx> and, for electronic format documents, subject to Terms and Conditions for Electronic Documents at <http://www.sgs.com/en/Terms-and-Conditions/Terms-e-Documents.aspx>. Attention is drawn to the limitation of liability, indemnification and jurisdiction issues defined therein. Any holder of this document is advised that information contained hereon reflects the Company's findings at the time of its intervention only and within the limits of Client's instructions, if any. The Company's sole responsibility is to its Client and this document does not exonerate parties to a transaction from exercising all their rights and obligations under the transaction documents. This document cannot be reproduced except in full, without prior written approval of the Company. Any unauthorized alteration, forgery or falsification of the content or appearance of this document is unlawful and offenders may be prosecuted to the fullest extent of the law. Unless otherwise stated the results shown in this test report refer only to the sample(s) tested and such sample(s) are retained for 30 days only.
 Attention: To check the authenticity of testing /inspection report & certificate, please contact us at telephone: (86-755) 8307 1443, or email: CN.Doccheck@sgs.com

Test Mode: 04; Polarity: Vertical; Modulation:802.11a; Bandwidth:20MHz; Channel:High

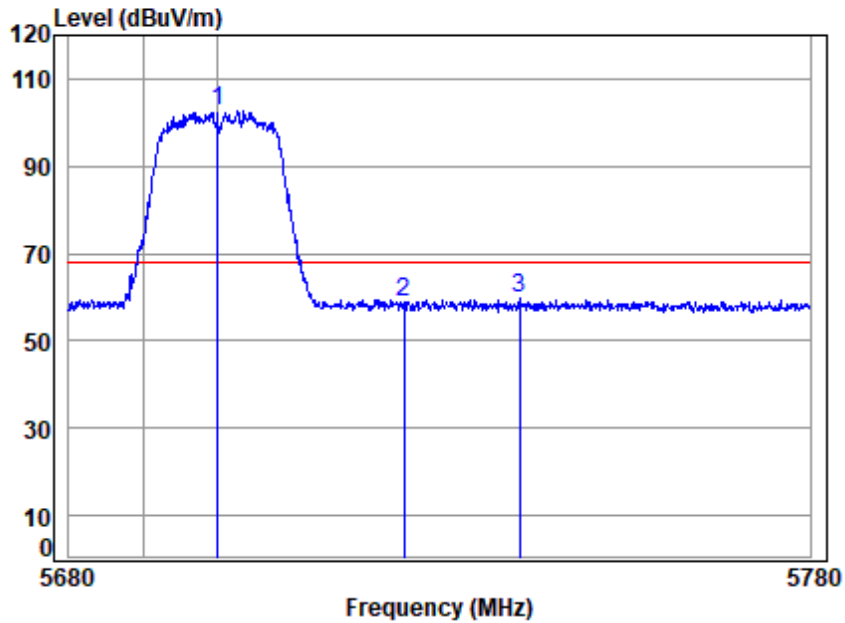

Site : chamber
 Condition: 3m VERTICAL
 Job No : 00028CR/00029CR
 Mode : 5700 Band edge
 : 5G WIFI 11A

Freq	Cable Loss	Ant Factor	Preamp Factor	Read Level	Limit	Over	Remark
MHz	dB	dB/m	dB	dBuV	dBuV/m	dB	
1 * 5700.000	8.21	34.81	42.37	101.87	102.52	68.20	34.32 Peak
2 5725.000	8.22	34.83	42.37	58.00	58.68	68.20	-9.52 Peak
3 5740.592	8.22	34.85	42.38	58.91	59.60	68.20	-8.60 Peak



Unless otherwise agreed in writing, this document is issued by the Company subject to its General Conditions of Service printed overleaf, available on request or accessible at <http://www.sgs.com/en/Terms-and-Conditions.aspx> and, for electronic format documents, subject to Terms and Conditions for Electronic Documents at <http://www.sgs.com/en/Terms-and-Conditions/Terms-e-Documents.aspx>. Attention is drawn to the limitation of liability, indemnification and jurisdiction issues defined therein. Any holder of this document is advised that information contained hereon reflects the Company's findings at the time of its intervention only and within the limits of Client's instructions, if any. The Company's sole responsibility is to its Client and this document does not exonerate parties to a transaction from exercising all their rights and obligations under the transaction documents. This document cannot be reproduced except in full, without prior written approval of the Company. Any unauthorized alteration, forgery or falsification of the content or appearance of this document is unlawful and offenders may be prosecuted to the fullest extent of the law. Unless otherwise stated the results shown in this test report refer only to the sample(s) tested and such sample(s) are retained for 30 days only.
 Attention: To check the authenticity of testing /inspection report & certificate, please contact us at telephone: (86-755) 8307 1443, or email: CN.Doccheck@sgs.com

Test Mode: 04; Polarity: Horizontal; Modulation:802.11n; Bandwidth:20MHz; Channel:Low

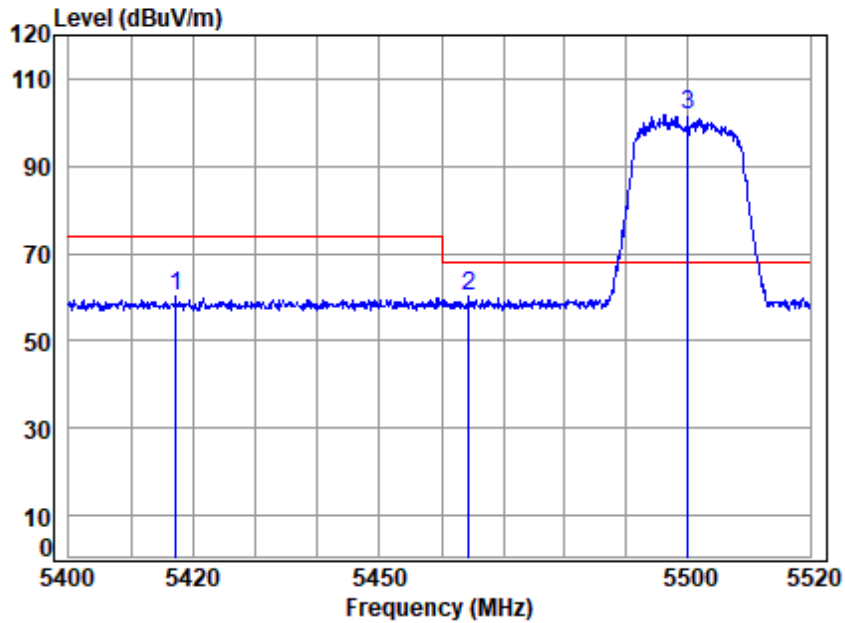

Site : chamber
 Condition: 3m HORIZONTAL
 Job No : 00028CR/00029CR
 Mode : 5500 Band edge
 : 5G WIFI 11N20

	Cable	Ant	Preamp	Read	Limit	Over		
Freq	Loss	Factor	Factor	Level	Level	Line	Limit	Remark
MHz	dB	dB/m	dB	dBuV	dBuV/m	dBuV/m	dB	
1	5417.118	8.04	34.54	42.34	59.97	60.21	74.00	-13.79 peak
2	5464.472	8.12	34.57	42.35	59.80	60.14	68.20	-8.06 peak
3 *	5500.000	8.18	34.60	42.35	101.26	101.69	68.20	33.49 peak



Unless otherwise agreed in writing, this document is issued by the Company subject to its General Conditions of Service printed overleaf, available on request or accessible at <http://www.sgs.com/en/Terms-and-Conditions.aspx> and, for electronic format documents, subject to Terms and Conditions for Electronic Documents at <http://www.sgs.com/en/Terms-and-Conditions/Terms-e-Documents.aspx>. Attention is drawn to the limitation of liability, indemnification and jurisdiction issues defined therein. Any holder of this document is advised that information contained hereon reflects the Company's findings at the time of its intervention only and within the limits of Client's instructions, if any. The Company's sole responsibility is to its Client and this document does not exonerate parties to a transaction from exercising all their rights and obligations under the transaction documents. This document cannot be reproduced except in full, without prior written approval of the Company. Any unauthorized alteration, forgery or falsification of the content or appearance of this document is unlawful and offenders may be prosecuted to the fullest extent of the law. Unless otherwise stated the results shown in this test report refer only to the sample(s) tested and such sample(s) are retained for 30 days only.
 Attention: To check the authenticity of testing / inspection report & certificate, please contact us at telephone: (86-755) 8307 1443, or email: CN.Doccheck@sgs.com

Test Mode: 04; Polarity: Horizontal; Modulation:802.11n; Bandwidth:20MHz; Channel:Low

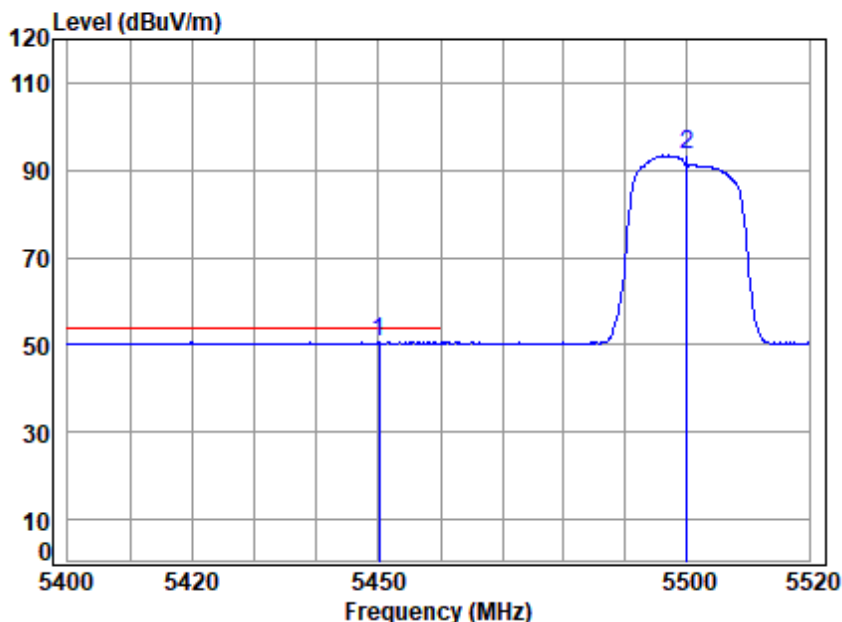

Site : chamber
 Condition: 3m HORIZONTAL
 Job No : 00028CR/00029CR
 Mode : 5500 Band edge
 : 5G WIFI 11N20

	Freq	Cable Loss	Ant Factor	Preamp Factor	Read Level	Limit Level	Over Limit	Remark
	MHz	dB	dB/m	dB	dBuV	dBuV/m	dBuV/m	dB
1	5450.079	8.10	34.56	42.35	50.37	50.68	54.00	-3.32 Average
2	5500.000	8.18	34.60	42.35	92.89	93.32	-----	----- Average



Unless otherwise agreed in writing, this document is issued by the Company subject to its General Conditions of Service printed overleaf, available on request or accessible at <http://www.sgs.com/en/Terms-and-Conditions.aspx> and, for electronic format documents, subject to Terms and Conditions for Electronic Documents at <http://www.sgs.com/en/Terms-and-Conditions/Terms-e-Documents.aspx>. Attention is drawn to the limitation of liability, indemnification and jurisdiction issues defined therein. Any holder of this document is advised that information contained hereon reflects the Company's findings at the time of its intervention only and within the limits of Client's instructions, if any. The Company's sole responsibility is to its Client and this document does not exonerate parties to a transaction from exercising all their rights and obligations under the transaction documents. This document cannot be reproduced except in full, without prior written approval of the Company. Any unauthorized alteration, forgery or falsification of the content or appearance of this document is unlawful and offenders may be prosecuted to the fullest extent of the law. Unless otherwise stated the results shown in this test report refer only to the sample(s) tested and such sample(s) are retained for 30 days only.
 Attention: To check the authenticity of testing /inspection report & certificate, please contact us at telephone: (86-755) 8307 1443, or email: CN.Doccheck@sgs.com

Test Mode: 04; Polarity: Vertical; Modulation:802.11n; Bandwidth:20MHz; Channel:Low

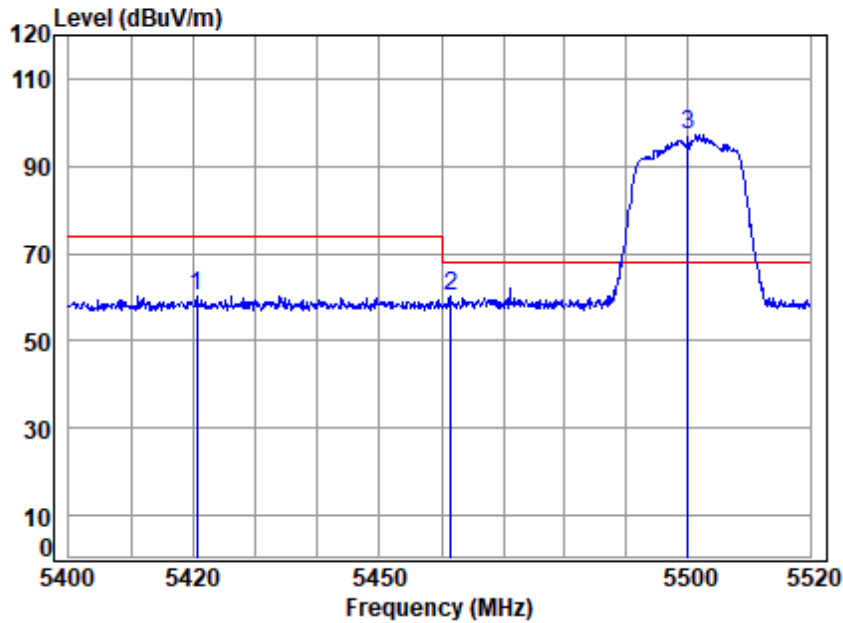

Site : chamber
 Condition: 3m VERTICAL
 Job No : 00028CR/00029CR
 Mode : 5500 Band edge
 : 5G WIFI 11N20

	Cable	Ant	Preamp	Read	Limit	Over	
Freq	Loss	Factor	Factor	Level	Level	Line	Limit Remark
MHz	dB	dB/m	dB	dBuV	dBuV/m	dBuV/m	dB
1	5420.572	8.05	34.54	42.34	60.19	60.44	74.00 -13.56 Peak
2	5461.471	8.12	34.57	42.35	59.69	60.03	68.20 -8.17 peak
3 *	5500.000	8.18	34.60	42.35	96.76	97.19	68.20 28.99 Peak



Unless otherwise agreed in writing, this document is issued by the Company subject to its General Conditions of Service printed overleaf, available on request or accessible at <http://www.sgs.com/en/Terms-and-Conditions.aspx> and, for electronic format documents, subject to Terms and Conditions for Electronic Documents at <http://www.sgs.com/en/Terms-and-Conditions/Terms-e-Documents.aspx>. Attention is drawn to the limitation of liability, indemnification and jurisdiction issues defined therein. Any holder of this document is advised that information contained hereon reflects the Company's findings at the time of its intervention only and within the limits of Client's instructions, if any. The Company's sole responsibility is to its Client and this document does not exonerate parties to a transaction from exercising all their rights and obligations under the transaction documents. This document cannot be reproduced except in full, without prior written approval of the Company. Any unauthorized alteration, forgery or falsification of the content or appearance of this document is unlawful and offenders may be prosecuted to the fullest extent of the law. Unless otherwise stated the results shown in this test report refer only to the sample(s) tested and such sample(s) are retained for 30 days only.
 Attention: To check the authenticity of testing /inspection report & certificate, please contact us at telephone: (86-755) 8307 1443, or email: CN.Doccheck@sgs.com

Test Mode: 04; Polarity: Vertical; Modulation:802.11n; Bandwidth:20MHz; Channel:Low

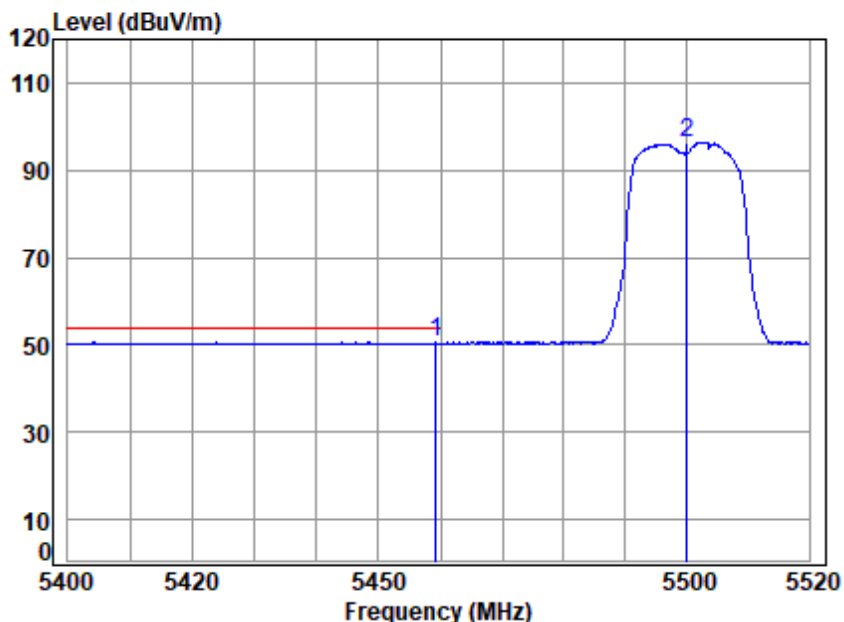

Site : chamber
 Condition: 3m VERTICAL
 Job No : 00028CR/00029CR
 Mode : 5500 Band edge
 : 5G WIFI 11N20

	Freq	Cable Loss	Ant Factor	Preamp Factor	Read Level	Limit Level	Over Limit	Remark
	MHz	dB	dB/m	dB	dBuV	dBuV/m	dBuV/m	dB
1	5459.311	8.11	34.57	42.35	50.28	50.61	54.00	-3.39 Average
2	5500.000	8.18	34.60	42.35	96.05	96.48	-----	----- Average



Unless otherwise agreed in writing, this document is issued by the Company subject to its General Conditions of Service printed overleaf, available on request or accessible at <http://www.sgs.com/en/Terms-and-Conditions.aspx> and, for electronic format documents, subject to Terms and Conditions for Electronic Documents at <http://www.sgs.com/en/Terms-and-Conditions/Terms-e-Documents.aspx>. Attention is drawn to the limitation of liability, indemnification and jurisdiction issues defined therein. Any holder of this document is advised that information contained hereon reflects the Company's findings at the time of its intervention only and within the limits of Client's instructions, if any. The Company's sole responsibility is to its Client and this document does not exonerate parties to a transaction from exercising all their rights and obligations under the transaction documents. This document cannot be reproduced except in full, without prior written approval of the Company. Any unauthorized alteration, forgery or falsification of the content or appearance of this document is unlawful and offenders may be prosecuted to the fullest extent of the law. Unless otherwise stated the results shown in this test report refer only to the sample(s) tested and such sample(s) are retained for 30 days only.
 Attention: To check the authenticity of testing / inspection report & certificate, please contact us at telephone: (86-755) 8307 1443, or email: CN.Doccheck@sgs.com

Test Mode: 04; Polarity: Horizontal; Modulation:802.11n; Bandwidth:20MHz; Channel:High

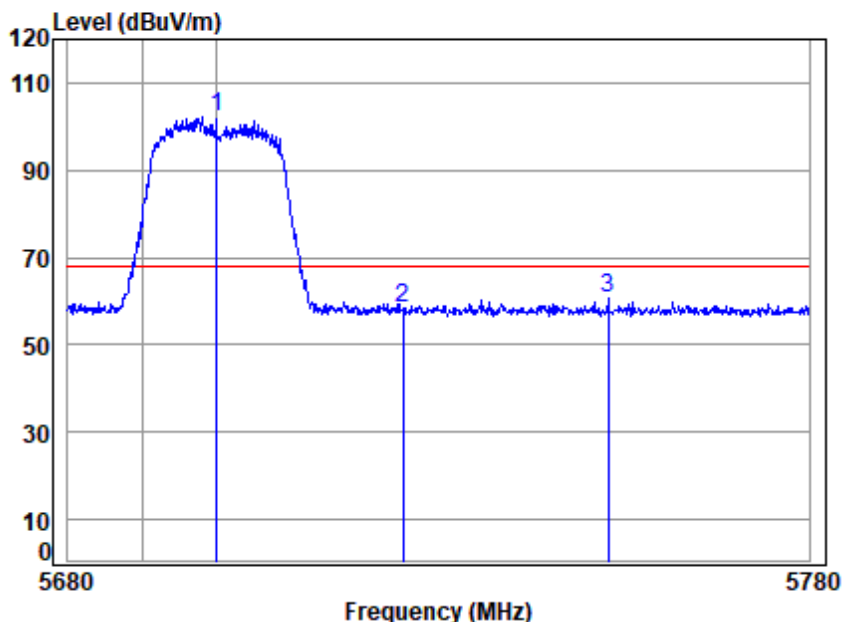

Site : chamber
 Condition: 3m HORIZONTAL
 Job No : 00028CR/00029CR
 Mode : 5700 Band edge
 : 5G WIFI 11N20

Freq	Cable Loss	Ant Factor	Preamp Factor	Read Level	Level	Limit Line	Over Limit	Remark
MHz	dB	dB/m	dB	dBuV	dBuV/m	dBuV/m	dB	
1 * 5700.000	8.21	34.81	42.37	101.54	102.19	68.20	33.99	peak
2 5725.000	8.22	34.83	42.37	57.94	58.62	68.20	-9.58	peak
3 5752.728	8.22	34.86	42.38	59.81	60.51	68.20	-7.69	peak



Unless otherwise agreed in writing, this document is issued by the Company subject to its General Conditions of Service printed overleaf, available on request or accessible at <http://www.sgs.com/en/Terms-and-Conditions.aspx> and, for electronic format documents, subject to Terms and Conditions for Electronic Documents at <http://www.sgs.com/en/Terms-and-Conditions/Terms-e-Documents.aspx>. Attention is drawn to the limitation of liability, indemnification and jurisdiction issues defined therein. Any holder of this document is advised that information contained hereon reflects the Company's findings at the time of its intervention only and within the limits of Client's instructions, if any. The Company's sole responsibility is to its Client and this document does not exonerate parties to a transaction from exercising all their rights and obligations under the transaction documents. This document cannot be reproduced except in full, without prior written approval of the Company. Any unauthorized alteration, forgery or falsification of the content or appearance of this document is unlawful and offenders may be prosecuted to the fullest extent of the law. Unless otherwise stated the results shown in this test report refer only to the sample(s) tested and such sample(s) are retained for 30 days only.
 Attention: To check the authenticity of testing /inspection report & certificate, please contact us at telephone: (86-755) 8307 1443, or email: CN.Doccheck@sgs.com

Test Mode: 04; Polarity: Vertical; Modulation:802.11n; Bandwidth:20MHz; Channel:High

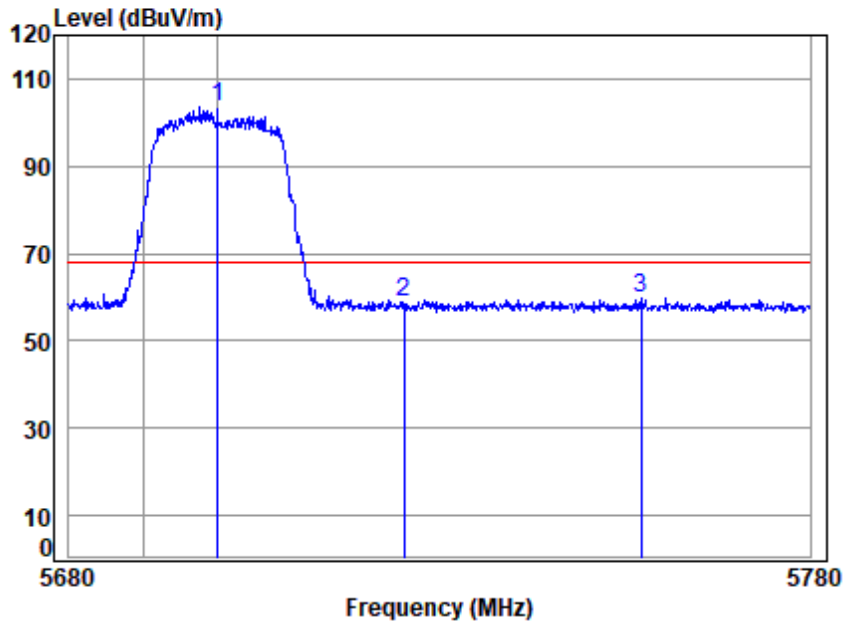

Site : chamber
 Condition: 3m VERTICAL
 Job No : 00028CR/00029CR
 Mode : 5700 Band edge
 : 5G WIFI 11N20

Freq	Cable Loss	Ant Factor	Preamp Factor	Read Level	Level	Limit Line	Over Limit	Remark
MHz	dB	dB/m	dB	dBuV	dBuV/m	dBuV/m	dB	
1 * 5700.000	8.21	34.81	42.37	102.70	103.35	68.20	35.15	Peak
2 5725.000	8.22	34.83	42.37	57.98	58.66	68.20	-9.54	Peak
3 5757.046	8.22	34.86	42.38	59.02	59.72	68.20	-8.48	Peak



Unless otherwise agreed in writing, this document is issued by the Company subject to its General Conditions of Service printed overleaf, available on request or accessible at <http://www.sgs.com/en/Terms-and-Conditions.aspx> and, for electronic format documents, subject to Terms and Conditions for Electronic Documents at <http://www.sgs.com/en/Terms-and-Conditions/Terms-e-Documents.aspx>. Attention is drawn to the limitation of liability, indemnification and jurisdiction issues defined therein. Any holder of this document is advised that information contained hereon reflects the Company's findings at the time of its intervention only and within the limits of Client's instructions, if any. The Company's sole responsibility is to its Client and this document does not exonerate parties to a transaction from exercising all their rights and obligations under the transaction documents. This document cannot be reproduced except in full, without prior written approval of the Company. Any unauthorized alteration, forgery or falsification of the content or appearance of this document is unlawful and offenders may be prosecuted to the fullest extent of the law. Unless otherwise stated the results shown in this test report refer only to the sample(s) tested and such sample(s) are retained for 30 days only.
 Attention: To check the authenticity of testing /inspection report & certificate, please contact us at telephone: (86-755) 8307 1443, or email: CN.Doccheck@sgs.com

Test Mode: 04; Polarity: Horizontal; Modulation:802.11n; Bandwidth:40MHz; Channel:Low

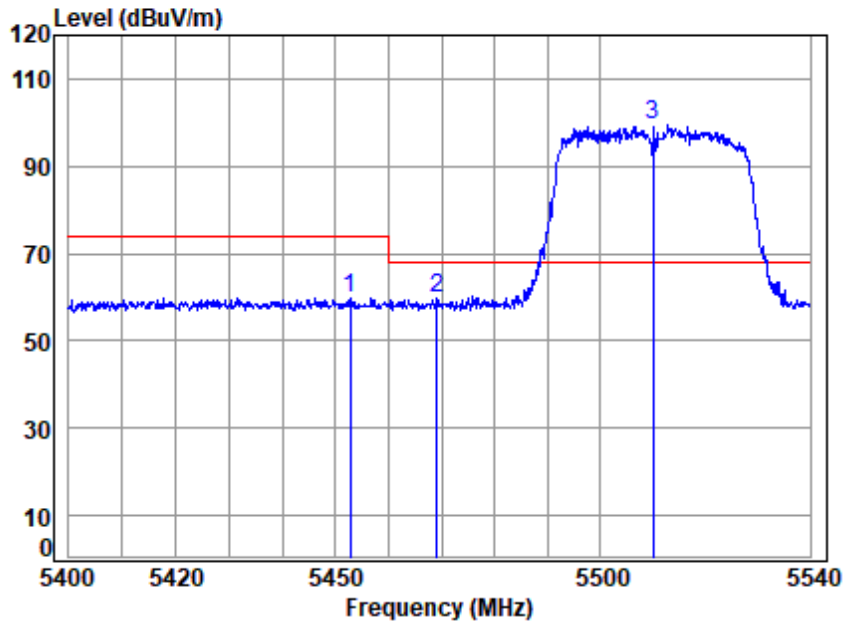

Site : chamber
 Condition: 3m HORIZONTAL
 Job No : 00028CR/00029CR
 Mode : 5510 Band edge
 : 5G WIFI 11N40

	Freq	Cable Loss	Ant Factor	Preamp Factor	Read Level	Limit Level	Over Limit	Remark
	MHz	dB	dB/m	dB	dBuV	dBuV/m	dBuV/m	dB
1	5452.778	8.10	34.56	42.35	59.66	59.97	74.00	-14.03 peak
2	5468.992	8.13	34.58	42.35	59.48	59.84	68.20	-8.36 peak
3 *	5510.000	8.18	34.61	42.35	99.08	99.52	68.20	31.32 peak



Unless otherwise agreed in writing, this document is issued by the Company subject to its General Conditions of Service printed overleaf, available on request or accessible at <http://www.sgs.com/en/Terms-and-Conditions.aspx> and, for electronic format documents, subject to Terms and Conditions for Electronic Documents at <http://www.sgs.com/en/Terms-and-Conditions/Terms-e-Document.aspx>. Attention is drawn to the limitation of liability, indemnification and jurisdiction issues defined therein. Any holder of this document is advised that information contained hereon reflects the Company's findings at the time of its intervention only and within the limits of Client's instructions, if any. The Company's sole responsibility is to its Client and this document does not exonerate parties to a transaction from exercising all their rights and obligations under the transaction documents. This document cannot be reproduced except in full, without prior written approval of the Company. Any unauthorized alteration, forgery or falsification of the content or appearance of this document is unlawful and offenders may be prosecuted to the fullest extent of the law. Unless otherwise stated the results shown in this test report refer only to the sample(s) tested and such sample(s) are retained for 30 days only.
 Attention: To check the authenticity of testing /inspection report & certificate, please contact us at telephone: (86-755) 8307 1443, or email: CN.Doccheck@sgs.com

Test Mode: 04; Polarity: Horizontal; Modulation:802.11n; Bandwidth:40MHz; Channel:Low

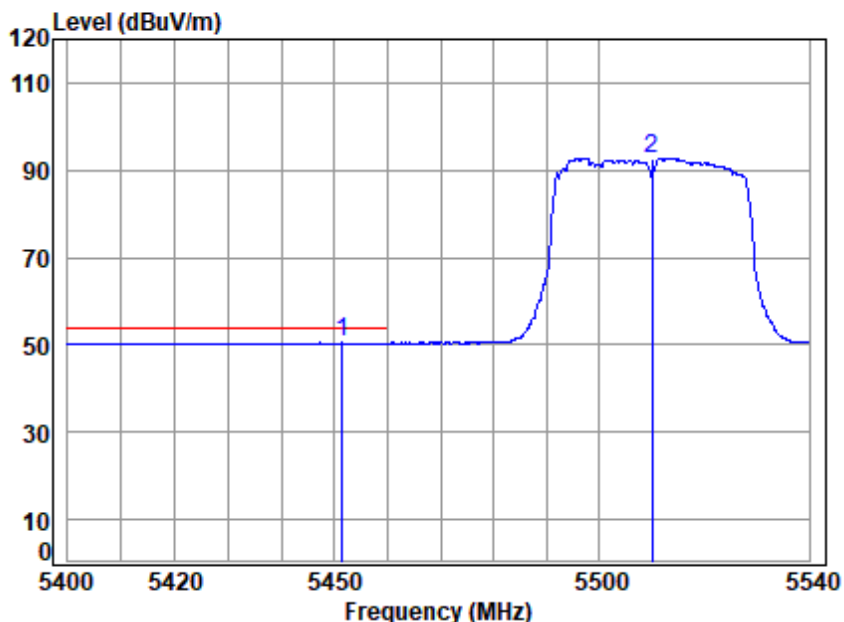

Site : chamber
 Condition: 3m HORIZONTAL
 Job No : 00028CR/00029CR
 Mode : 5510 Band edge
 : 5G WIFI 11N40

	Freq	Cable Loss	Ant Factor	Preamp Factor	Read Level	Limit Level	Over Limit	Remark
	MHz	dB	dB/m	dB	dBuV	dBuV/m	dBuV/m	dB
1	5451.383	8.10	34.56	42.35	50.16	50.47	54.00	-3.53 Average
2	5510.000	8.18	34.61	42.35	92.37	92.81	-----	----- Average



Unless otherwise agreed in writing, this document is issued by the Company subject to its General Conditions of Service printed overleaf, available on request or accessible at <http://www.sgs.com/en/Terms-and-Conditions.aspx> and, for electronic format documents, subject to Terms and Conditions for Electronic Documents at <http://www.sgs.com/en/Terms-and-Conditions/Terms-e-Documents.aspx>. Attention is drawn to the limitation of liability, indemnification and jurisdiction issues defined therein. Any holder of this document is advised that information contained hereon reflects the Company's findings at the time of its intervention only and within the limits of Client's instructions, if any. The Company's sole responsibility is to its Client and this document does not exonerate parties to a transaction from exercising all their rights and obligations under the transaction documents. This document cannot be reproduced except in full, without prior written approval of the Company. Any unauthorized alteration, forgery or falsification of the content or appearance of this document is unlawful and offenders may be prosecuted to the fullest extent of the law. Unless otherwise stated the results shown in this test report refer only to the sample(s) tested and such sample(s) are retained for 30 days only.
 Attention: To check the authenticity of testing /inspection report & certificate, please contact us at telephone: (86-755) 8307 1443, or email: CN.Doccheck@sgs.com

Test Mode: 04; Polarity: Vertical; Modulation:802.11n; Bandwidth:40MHz; Channel:Low

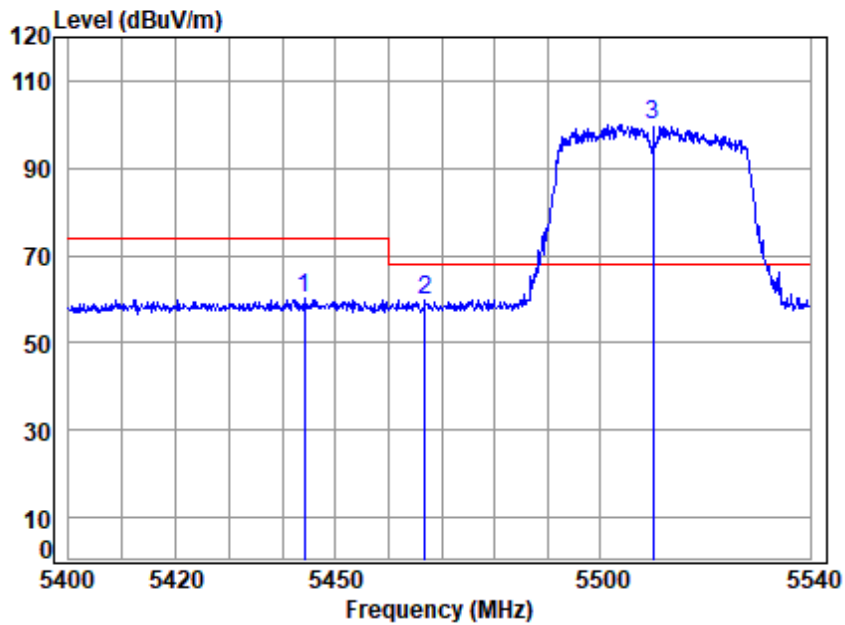

Site : chamber
 Condition: 3m VERTICAL
 Job No : 00028CR/00029CR
 Mode : 5510 Band edge
 : 5G WIFI 11N40

	Cable	Ant	Preamp	Read	Limit	Over	
Freq	Loss	Factor	Factor	Level	Level	Line	Limit Remark
MHz	dB	dB/m	dB	dBuV	dBuV/m	dBuV/m	dB
1	5444.132	8.09	34.56	42.35	60.02	60.32	74.00 -13.68 Peak
2	5466.753	8.12	34.57	42.35	59.43	59.77	68.20 -8.43 peak
3 *	5510.000	8.18	34.61	42.35	99.58	100.02	68.20 31.82 Peak



Unless otherwise agreed in writing, this document is issued by the Company subject to its General Conditions of Service printed overleaf, available on request or accessible at <http://www.sgs.com/en/Terms-and-Conditions.aspx> and, for electronic format documents, subject to Terms and Conditions for Electronic Documents at <http://www.sgs.com/en/Terms-and-Conditions/Terms-e-Documents.aspx>. Attention is drawn to the limitation of liability, indemnification and jurisdiction issues defined therein. Any holder of this document is advised that information contained hereon reflects the Company's findings at the time of its intervention only and within the limits of Client's instructions, if any. The Company's sole responsibility is to its Client and this document does not exonerate parties to a transaction from exercising all their rights and obligations under the transaction documents. This document cannot be reproduced except in full, without prior written approval of the Company. Any unauthorized alteration, forgery or falsification of the content or appearance of this document is unlawful and offenders may be prosecuted to the fullest extent of the law. Unless otherwise stated the results shown in this test report refer only to the sample(s) tested and such sample(s) are retained for 30 days only.
 Attention: To check the authenticity of testing /inspection report & certificate, please contact us at telephone: (86-755) 8307 1443, or email: CN.Doccheck@sgs.com

Test Mode: 04; Polarity: Vertical; Modulation:802.11n; Bandwidth:40MHz; Channel:Low

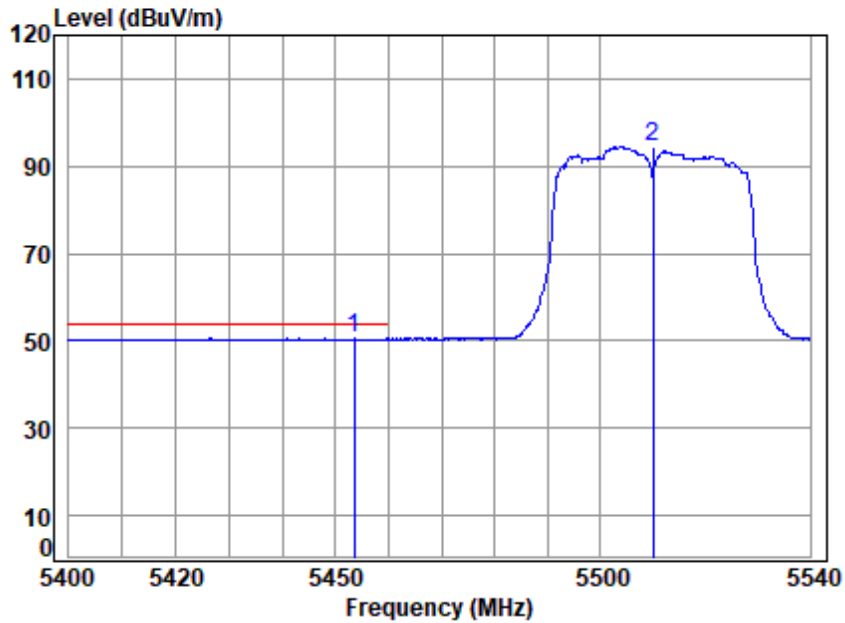

Site : chamber
 Condition: 3m VERTICAL
 Job No : 00028CR/00029CR
 Mode : 5510 Band edge
 : 5G WIFI 11N20

	Freq	Cable Loss	Ant Factor	Preamp Factor	Read Level	Limit Level	Over Limit	Remark
	MHz	dB	dB/m	dB	dBuV	dBuV/m	dBuV/m	dB
1	5453.476	8.10	34.56	42.35	50.19	50.50	54.00	-3.50 Average
2	5510.000	8.18	34.61	42.35	94.08	94.52	-----	----- Average



Test Mode: 04; Polarity: Horizontal; Modulation:802.11n; Bandwidth:40MHz; Channel:High

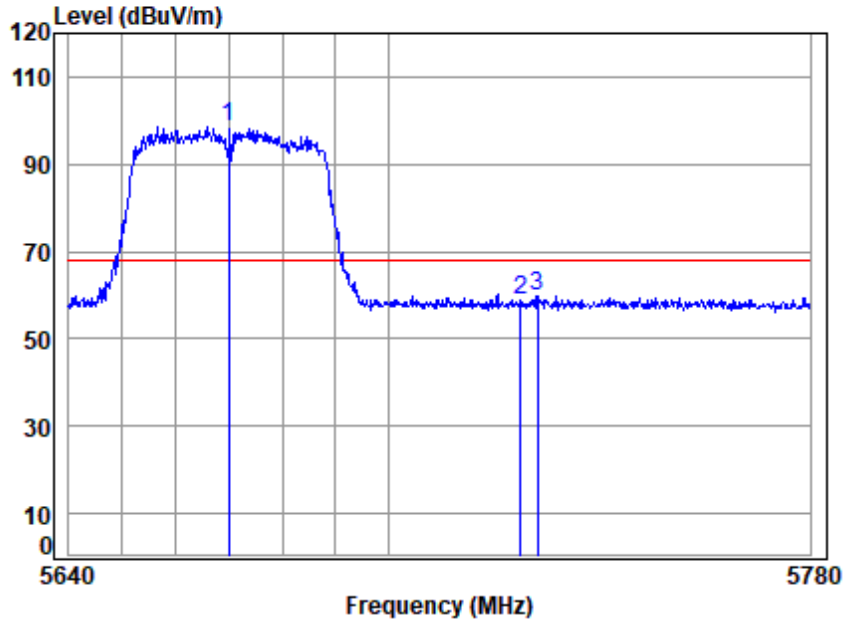

Site : chamber
 Condition: 3m HORIZONTAL
 Job No : 00028CR/00029CR
 Mode : 5670 Band edge
 : 5G WIFI 11N40

Freq	Cable Loss	Ant Factor	Preamp Factor	Read Level	Level	Limit Line	Over Limit	Remark
MHz	dB	dB/m	dB	dBuV	dBuV/m	dBuV/m	dB	
1 * 5670.000	8.21	34.77	42.37	97.84	98.45	68.20	30.25	peak
2 5725.000	8.22	34.83	42.37	58.06	58.74	68.20	-9.46	peak
3 5728.081	8.22	34.83	42.37	59.22	59.90	68.20	-8.30	peak



Unless otherwise agreed in writing, this document is issued by the Company subject to its General Conditions of Service printed overleaf, available on request or accessible at <http://www.sgs.com/en/Terms-and-Conditions.aspx> and, for electronic format documents, subject to Terms and Conditions for Electronic Documents at <http://www.sgs.com/en/Terms-and-Conditions/Terms-e-Documents.aspx>. Attention is drawn to the limitation of liability, indemnification and jurisdiction issues defined therein. Any holder of this document is advised that information contained hereon reflects the Company's findings at the time of its intervention only and within the limits of Client's instructions, if any. The Company's sole responsibility is to its Client and this document does not exonerate parties to a transaction from exercising all their rights and obligations under the transaction documents. This document cannot be reproduced except in full, without prior written approval of the Company. Any unauthorized alteration, forgery or falsification of the content or appearance of this document is unlawful and offenders may be prosecuted to the fullest extent of the law. Unless otherwise stated the results shown in this test report refer only to the sample(s) tested and such sample(s) are retained for 30 days only.
 Attention: To check the authenticity of testing / inspection report & certificate, please contact us at telephone: (86-755) 8307 1443, or email: CN.Doccheck@sgs.com

Test Mode: 04; Polarity: Vertical; Modulation:802.11n; Bandwidth:40MHz; Channel:High

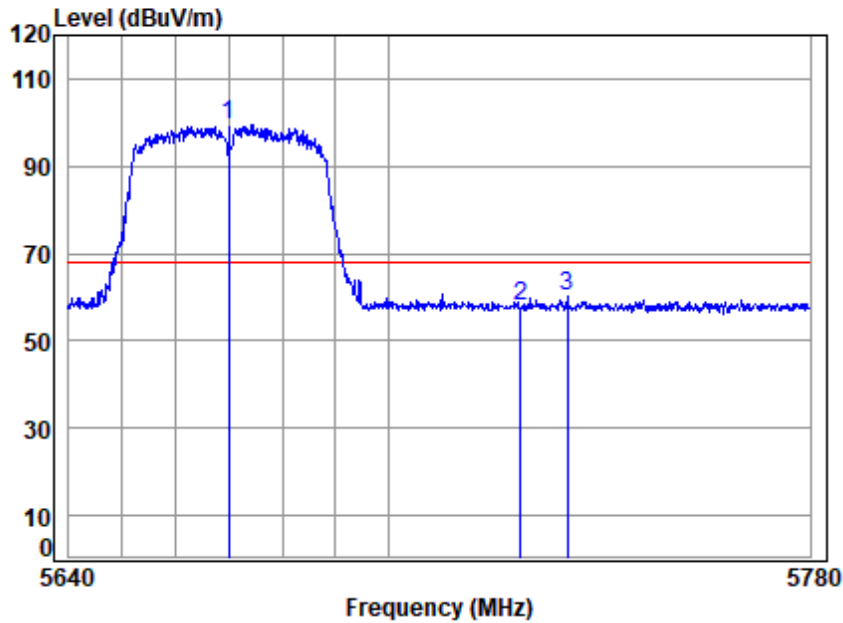

Site : chamber
 Condition: 3m VERTICAL
 Job No : 00028CR/00029CR
 Mode : 5670 Band edge
 : 5G WIFI 11N40

Freq	Cable Loss	Ant Factor	Preamp Factor	Read Level	Level	Limit Line	Over Limit	Remark
MHz	dB	dB/m	dB	dBuV	dBuV/m	dBuV/m	dB	
1 * 5670.000	8.21	34.77	42.37	98.96	99.57	68.20	31.37	Peak
2 5725.000	8.22	34.83	42.37	57.23	57.91	68.20	-10.29	Peak
3 5733.701	8.22	34.84	42.38	59.51	60.19	68.20	-8.01	Peak



Unless otherwise agreed in writing, this document is issued by the Company subject to its General Conditions of Service printed overleaf, available on request or accessible at <http://www.sgs.com/en/Terms-and-Conditions.aspx> and, for electronic format documents, subject to Terms and Conditions for Electronic Documents at <http://www.sgs.com/en/Terms-and-Conditions/Terms-e-Documents.aspx>. Attention is drawn to the limitation of liability, indemnification and jurisdiction issues defined therein. Any holder of this document is advised that information contained hereon reflects the Company's findings at the time of its intervention only and within the limits of Client's instructions, if any. The Company's sole responsibility is to its Client and this document does not exonerate parties to a transaction from exercising all their rights and obligations under the transaction documents. This document cannot be reproduced except in full, without prior written approval of the Company. Any unauthorized alteration, forgery or falsification of the content or appearance of this document is unlawful and offenders may be prosecuted to the fullest extent of the law. Unless otherwise stated the results shown in this test report refer only to the sample(s) tested and such sample(s) are retained for 30 days only.
 Attention: To check the authenticity of testing / inspection report & certificate, please contact us at telephone: (86-755) 8307 1443, or email: CN.Doccheck@sgs.com

Test Mode: 04; Polarity: Horizontal; Modulation:802.11ac; Bandwidth:20MHz; Channel:Low

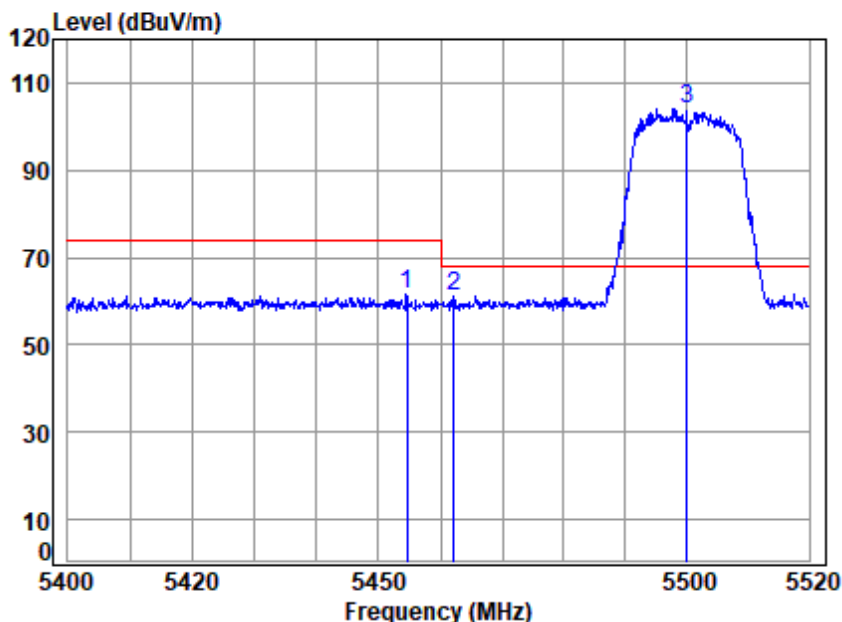

Site : chamber
 Condition: 3m HORIZONTAL
 Job No : 00028CR/00029CR
 Mode : 5500 Band edge
 : 5G WIFI 11AC20

	Freq	Cable Loss	Ant Factor	Preamp Factor	Read Level	Limit Level	Over Limit	Remark
	MHz	dB	dB/m	dB	dBuV	dBuV/m	dBuV/m	dB
1	5454.513	8.10	34.57	42.35	61.12	61.44	74.00	-12.56 peak
2	5462.191	8.12	34.57	42.35	60.65	60.99	68.20	-7.21 peak
3 *	5500.000	8.18	34.60	42.35	103.68	104.11	68.20	35.91 peak



Unless otherwise agreed in writing, this document is issued by the Company subject to its General Conditions of Service printed overleaf, available on request or accessible at <http://www.sgs.com/en/Terms-and-Conditions.aspx> and, for electronic format documents, subject to Terms and Conditions for Electronic Documents at <http://www.sgs.com/en/Terms-and-Conditions/Terms-e-Documents.aspx>. Attention is drawn to the limitation of liability, indemnification and jurisdiction issues defined therein. Any holder of this document is advised that information contained hereon reflects the Company's findings at the time of its intervention only and within the limits of Client's instructions, if any. The Company's sole responsibility is to its Client and this document does not exonerate parties to a transaction from exercising all their rights and obligations under the transaction documents. This document cannot be reproduced except in full, without prior written approval of the Company. Any unauthorized alteration, forgery or falsification of the content or appearance of this document is unlawful and offenders may be prosecuted to the fullest extent of the law. Unless otherwise stated the results shown in this test report refer only to the sample(s) tested and such sample(s) are retained for 30 days only.
 Attention: To check the authenticity of testing /inspection report & certificate, please contact us at telephone: (86-755) 8307 1443, or email: CN.Doccheck@sgs.com

Test Mode: 04; Polarity: Horizontal; Modulation:802.11ac; Bandwidth:20MHz; Channel:Low

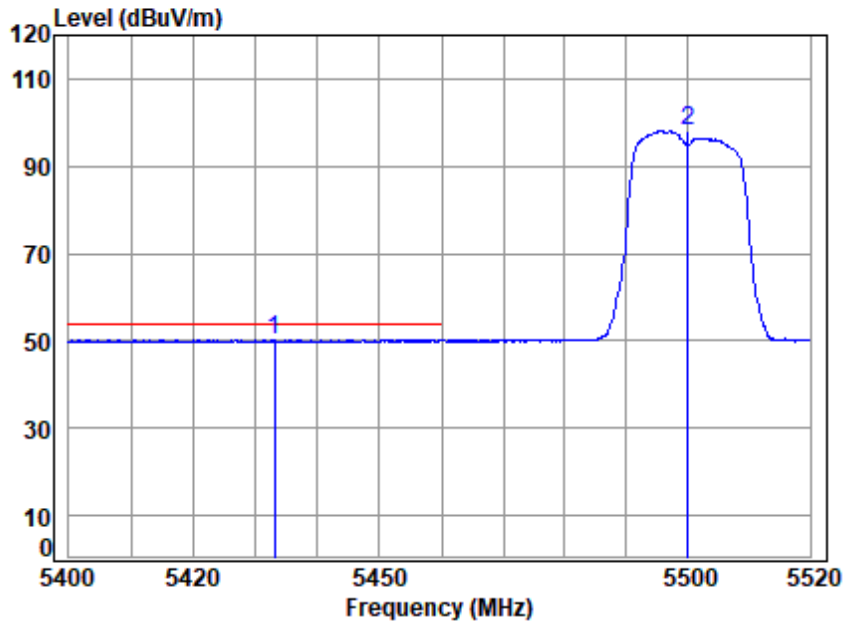

Site : chamber
 Condition: 3m HORIZONTAL
 Job No : 00028CR/00029CR
 Mode : 5500 Band edge
 : 5G WIFI 11AC20

	Freq	Cable Loss	Ant Factor	Preamp Factor	Read Level	Limit Level	Over Limit	Remark
	MHz	dB	dB/m	dB	dBuV	dBuV/m	dBuV/m	dB
1	5433.096	8.07	34.55	42.35	49.87	50.14	54.00	-3.86 Average
2	5500.000	8.18	34.60	42.35	97.71	98.14	-----	----- Average



Unless otherwise agreed in writing, this document is issued by the Company subject to its General Conditions of Service printed overleaf, available on request or accessible at <http://www.sgs.com/en/Terms-and-Conditions.aspx> and, for electronic format documents, subject to Terms and Conditions for Electronic Documents at <http://www.sgs.com/en/Terms-and-Conditions/Terms-e-Documents.aspx>. Attention is drawn to the limitation of liability, indemnification and jurisdiction issues defined therein. Any holder of this document is advised that information contained hereon reflects the Company's findings at the time of its intervention only and within the limits of Client's instructions, if any. The Company's sole responsibility is to its Client and this document does not exonerate parties to a transaction from exercising all their rights and obligations under the transaction documents. This document cannot be reproduced except in full, without prior written approval of the Company. Any unauthorized alteration, forgery or falsification of the content or appearance of this document is unlawful and offenders may be prosecuted to the fullest extent of the law. Unless otherwise stated the results shown in this test report refer only to the sample(s) tested and such sample(s) are retained for 30 days only.
 Attention: To check the authenticity of testing /inspection report & certificate, please contact us at telephone: (86-755) 8307 1443, or email: CN.Doccheck@sgs.com

Test Mode: 04; Polarity: Vertical; Modulation:802.11ac; Bandwidth:20MHz; Channel:Low

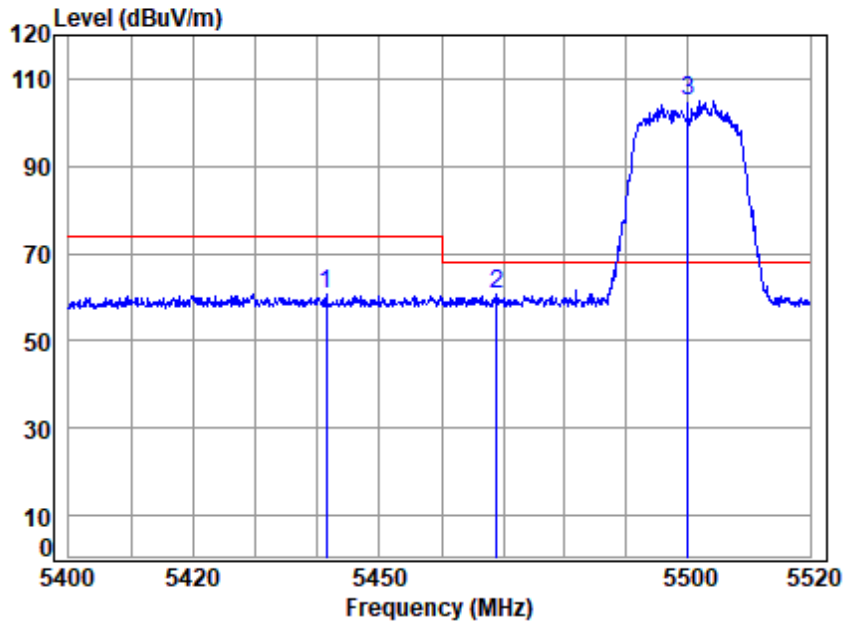

Site : chamber
 Condition: 3m VERTICAL
 Job No : 00028CR/00029CR
 Mode : 5500 Band edge
 : 5G WIFI 11AC20

	Cable	Ant	Preamp	Read	Limit	Over		
Freq	Loss	Factor	Factor	Level	Level	Line	Limit	Remark
MHz	dB	dB/m	dB	dBuV	dBuV/m	dBuV/m	dB	
1	5441.341	8.08	34.55	42.35	60.37	60.65	74.00	-13.35 Peak
2	5468.918	8.13	34.58	42.35	60.54	60.90	68.20	-7.30 peak
3 *	5500.000	8.18	34.60	42.35	104.51	104.94	68.20	36.74 Peak



Unless otherwise agreed in writing, this document is issued by the Company subject to its General Conditions of Service printed overleaf, available on request or accessible at <http://www.sgs.com/en/Terms-and-Conditions.aspx> and, for electronic format documents, subject to Terms and Conditions for Electronic Documents at <http://www.sgs.com/en/Terms-and-Conditions/Terms-e-Documents.aspx>. Attention is drawn to the limitation of liability, indemnification and jurisdiction issues defined therein. Any holder of this document is advised that information contained hereon reflects the Company's findings at the time of its intervention only and within the limits of Client's instructions, if any. The Company's sole responsibility is to its Client and this document does not exonerate parties to a transaction from exercising all their rights and obligations under the transaction documents. This document cannot be reproduced except in full, without prior written approval of the Company. Any unauthorized alteration, forgery or falsification of the content or appearance of this document is unlawful and offenders may be prosecuted to the fullest extent of the law. Unless otherwise stated the results shown in this test report refer only to the sample(s) tested and such sample(s) are retained for 30 days only.
 Attention: To check the authenticity of testing /inspection report & certificate, please contact us at telephone: (86-755) 8307 1443, or email: CN.Doccheck@sgs.com

Test Mode: 04; Polarity: Vertical; Modulation:802.11ac; Bandwidth:20MHz; Channel:Low

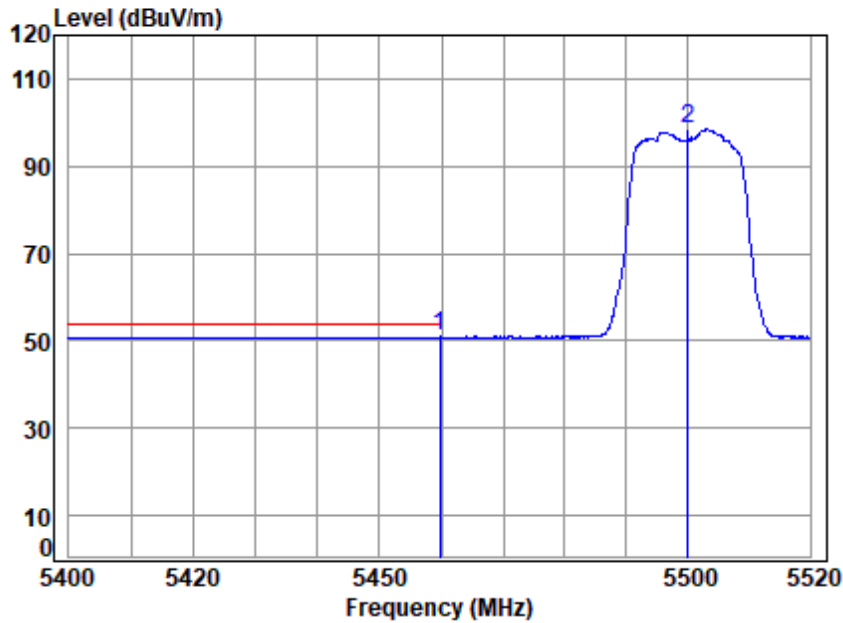

Site : chamber
 Condition: 3m VERTICAL
 Job No : 00028CR/00029CR
 Mode : 5500 Band edge
 : 5G WIFI 11AC20

	Freq	Cable Loss	Ant Factor	Preamp Factor	Read Level	Limit Level	Over Limit	Remark
	MHz	dB	dB/m	dB	dBuV	dBuV/m	dBuV/m	dB
1	5459.791	8.11	34.57	42.35	50.60	50.93	54.00	-3.07 Average
2	5500.000	8.18	34.60	42.35	97.99	98.42	-----	----- Average



Unless otherwise agreed in writing, this document is issued by the Company subject to its General Conditions of Service printed overleaf, available on request or accessible at <http://www.sgs.com/en/Terms-and-Conditions.aspx> and, for electronic format documents, subject to Terms and Conditions for Electronic Documents at <http://www.sgs.com/en/Terms-and-Conditions/Terms-e-Documents.aspx>. Attention is drawn to the limitation of liability, indemnification and jurisdiction issues defined therein. Any holder of this document is advised that information contained hereon reflects the Company's findings at the time of its intervention only and within the limits of Client's instructions, if any. The Company's sole responsibility is to its Client and this document does not exonerate parties to a transaction from exercising all their rights and obligations under the transaction documents. This document cannot be reproduced except in full, without prior written approval of the Company. Any unauthorized alteration, forgery or falsification of the content or appearance of this document is unlawful and offenders may be prosecuted to the fullest extent of the law. Unless otherwise stated the results shown in this test report refer only to the sample(s) tested and such sample(s) are retained for 30 days only.
 Attention: To check the authenticity of testing / inspection report & certificate, please contact us at telephone: (86-755) 8307 1443, or email: CN.Doccheck@sgs.com

Test Mode: 04; Polarity: Horizontal; Modulation:802.11ac; Bandwidth:20MHz; Channel:High

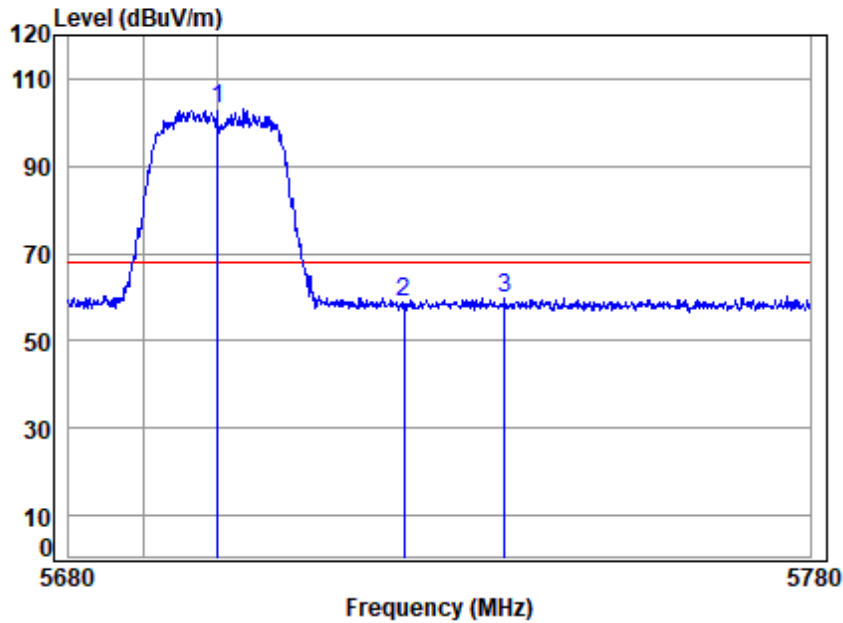

Site : chamber
 Condition: 3m HORIZONTAL
 Job No : 00028CR/00029CR
 Mode : 5700 Band edge
 : 5G WIFI 11AC20

	Cable	Ant	Preamp	Read	Limit	Over	
Freq	Loss	Factor	Factor	Level	Level	Line	Limit Remark
MHz	dB	dB/m	dB	dBuV	dBuV/m	dBuV/m	dB
1 * 5700.000	8.21	34.81	42.37	102.37	103.02	68.20	34.82 peak
2 5725.000	8.22	34.83	42.37	57.99	58.67	68.20	-9.53 peak
3 5738.588	8.22	34.84	42.38	58.98	59.66	68.20	-8.54 peak



Unless otherwise agreed in writing, this document is issued by the Company subject to its General Conditions of Service printed overleaf, available on request or accessible at <http://www.sgs.com/en/Terms-and-Conditions.aspx> and, for electronic format documents, subject to Terms and Conditions for Electronic Documents at <http://www.sgs.com/en/Terms-and-Conditions/Terms-e-Documents.aspx>. Attention is drawn to the limitation of liability, indemnification and jurisdiction issues defined therein. Any holder of this document is advised that information contained hereon reflects the Company's findings at the time of its intervention only and within the limits of Client's instructions, if any. The Company's sole responsibility is to its Client and this document does not exonerate parties to a transaction from exercising all their rights and obligations under the transaction documents. This document cannot be reproduced except in full, without prior written approval of the Company. Any unauthorized alteration, forgery or falsification of the content or appearance of this document is unlawful and offenders may be prosecuted to the fullest extent of the law. Unless otherwise stated the results shown in this test report refer only to the sample(s) tested and such sample(s) are retained for 30 days only.
 Attention: To check the authenticity of testing / inspection report & certificate, please contact us at telephone: (86-755) 8307 1443, or email: CN.Doccheck@sgs.com

Test Mode: 04; Polarity: Vertical; Modulation:802.11ac; Bandwidth:20MHz; Channel:High

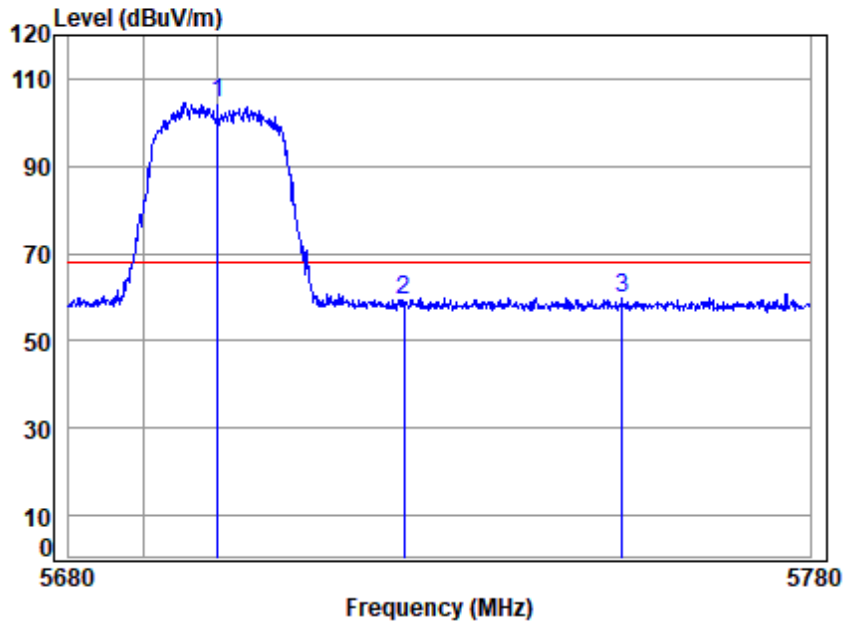

Site : chamber
 Condition: 3m VERTICAL
 Job No : 00028CR/00029CR
 Mode : 5700 Band edge
 : 5G WIFI 11AC20

	Cable	Ant	Preamp	Read	Limit	Over	
Freq	Loss	Factor	Factor	Level	Level	Line	Limit Remark
MHz	dB	dB/m	dB	dBuV	dBuV/m	dBuV/m	dB
1 * 5700.000	8.21	34.81	42.37	104.00	104.65	68.20	36.45 Peak
2 5725.000	8.22	34.83	42.37	58.56	59.24	68.20	-8.96 Peak
3 5754.535	8.22	34.86	42.38	59.29	59.99	68.20	-8.21 Peak



Unless otherwise agreed in writing, this document is issued by the Company subject to its General Conditions of Service printed overleaf, available on request or accessible at <http://www.sgs.com/en/Terms-and-Conditions.aspx> and, for electronic format documents, subject to Terms and Conditions for Electronic Documents at <http://www.sgs.com/en/Terms-and-Conditions/Terms-e-Documents.aspx>. Attention is drawn to the limitation of liability, indemnification and jurisdiction issues defined therein. Any holder of this document is advised that information contained hereon reflects the Company's findings at the time of its intervention only and within the limits of Client's instructions, if any. The Company's sole responsibility is to its Client and this document does not exonerate parties to a transaction from exercising all their rights and obligations under the transaction documents. This document cannot be reproduced except in full, without prior written approval of the Company. Any unauthorized alteration, forgery or falsification of the content or appearance of this document is unlawful and offenders may be prosecuted to the fullest extent of the law. Unless otherwise stated the results shown in this test report refer only to the sample(s) tested and such sample(s) are retained for 30 days only.
 Attention: To check the authenticity of testing / inspection report & certificate, please contact us at telephone: (86-755) 8307 1443, or email: CN.Doccheck@sgs.com

Test Mode: 04; Polarity: Horizontal; Modulation:802.11ac; Bandwidth:40MHz; Channel:Low

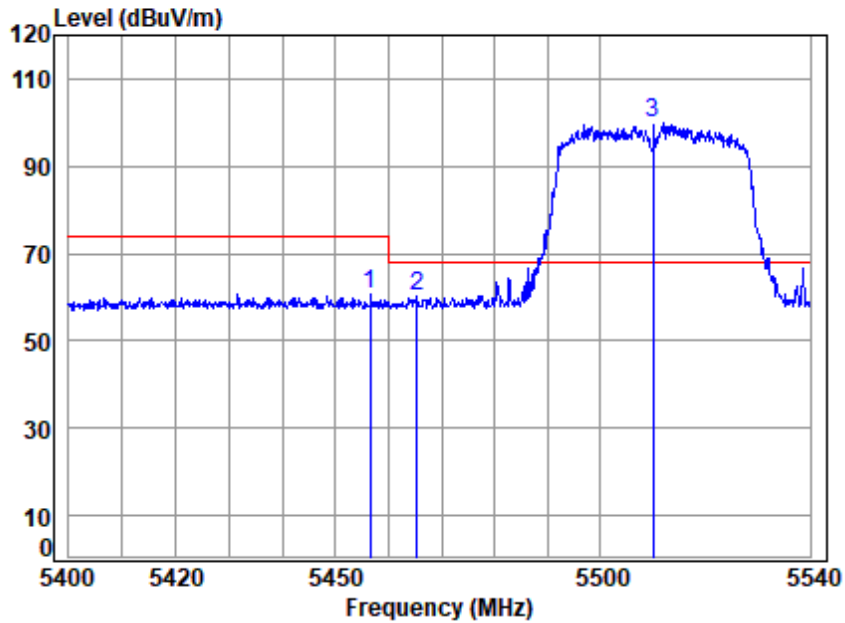

Site : chamber
 Condition: 3m HORIZONTAL
 Job No : 00028CR/00029CR
 Mode : 5510 Band edge
 : 5G WIFI 11AC40

	Cable	Ant	Preamp	Read	Limit	Over		
Freq	Loss	Factor	Factor	Level	Level	Line	Limit	Remark
MHz	dB	dB/m	dB	dBuV	dBuV/m	dBuV/m	dB	
1	5456.548	8.11	34.57	42.35	60.30	60.63	74.00	-13.37 peak
2	5465.354	8.12	34.57	42.35	59.76	60.10	68.20	-8.10 peak
3 *	5510.000	8.18	34.61	42.35	99.54	99.98	68.20	31.78 peak



Unless otherwise agreed in writing, this document is issued by the Company subject to its General Conditions of Service printed overleaf, available on request or accessible at <http://www.sgs.com/en/Terms-and-Conditions.aspx> and, for electronic format documents, subject to Terms and Conditions for Electronic Documents at <http://www.sgs.com/en/Terms-and-Conditions/Terms-e-Documents.aspx>. Attention is drawn to the limitation of liability, indemnification and jurisdiction issues defined therein. Any holder of this document is advised that information contained hereon reflects the Company's findings at the time of its intervention only and within the limits of Client's instructions, if any. The Company's sole responsibility is to its Client and this document does not exonerate parties to a transaction from exercising all their rights and obligations under the transaction documents. This document cannot be reproduced except in full, without prior written approval of the Company. Any unauthorized alteration, forgery or falsification of the content or appearance of this document is unlawful and offenders may be prosecuted to the fullest extent of the law. Unless otherwise stated the results shown in this test report refer only to the sample(s) tested and such sample(s) are retained for 30 days only.
 Attention: To check the authenticity of testing / inspection report & certificate, please contact us at telephone: (86-755) 8307 1443, or email: CN.Doccheck@sgs.com

Test Mode: 04; Polarity: Horizontal; Modulation:802.11ac; Bandwidth:40MHz; Channel:Low

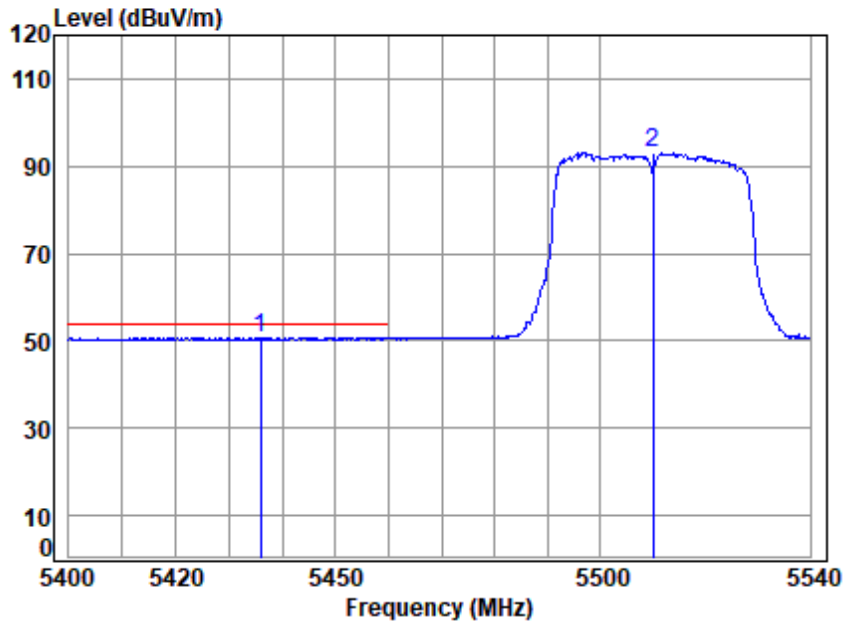

Site : chamber
 Condition: 3m HORIZONTAL
 Job No : 00028CR/00029CR
 Mode : 5510 Band edge
 : 5G WIFI 11AC40

	Freq	Cable Loss	Ant Factor	Preamp Factor	Read Level	Limit Level	Over Limit	Remark
	MHz	dB	dB/m	dB	dBuV	dBuV/m	dBuV/m	dB
1	5435.917	8.07	34.55	42.35	50.41	50.68	54.00	-3.32 Average
2	5510.000	8.18	34.61	42.35	92.71	93.15	-----	----- Average



Unless otherwise agreed in writing, this document is issued by the Company subject to its General Conditions of Service printed overleaf, available on request or accessible at <http://www.sgs.com/en/Terms-and-Conditions.aspx> and, for electronic format documents, subject to Terms and Conditions for Electronic Documents at <http://www.sgs.com/en/Terms-and-Conditions/Terms-e-Documents.aspx>. Attention is drawn to the limitation of liability, indemnification and jurisdiction issues defined therein. Any holder of this document is advised that information contained hereon reflects the Company's findings at the time of its intervention only and within the limits of Client's instructions, if any. The Company's sole responsibility is to its Client and this document does not exonerate parties to a transaction from exercising all their rights and obligations under the transaction documents. This document cannot be reproduced except in full, without prior written approval of the Company. Any unauthorized alteration, forgery or falsification of the content or appearance of this document is unlawful and offenders may be prosecuted to the fullest extent of the law. Unless otherwise stated the results shown in this test report refer only to the sample(s) tested and such sample(s) are retained for 30 days only.
 Attention: To check the authenticity of testing /inspection report & certificate, please contact us at telephone: (86-755) 8307 1443, or email: CN.Doccheck@sgs.com

Test Mode: 04; Polarity: Vertical; Modulation:802.11ac; Bandwidth:40MHz; Channel:Low

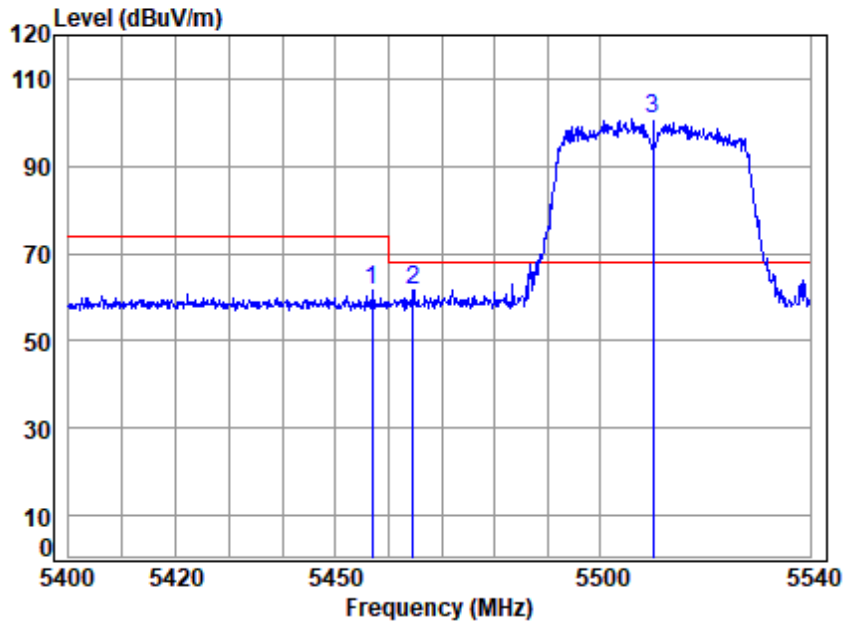

Site : chamber
 Condition: 3m VERTICAL
 Job No : 00028CR/00029CR
 Mode : 5510 Band edge
 : 5G WIFI 11AC40

	Cable	Ant	Preamp	Read	Limit	Over		
Freq	Loss	Factor	Factor	Level	Level	Line	Limit	Remark
MHz	dB	dB/m	dB	dBuV	dBuV/m	dBuV/m	dB	
1	5456.827	8.11	34.57	42.35	61.14	61.47	74.00	-12.53 Peak
2	5464.654	8.12	34.57	42.35	61.22	61.56	68.20	-6.64 peak
3 *	5510.000	8.18	34.61	42.35	100.20	100.64	68.20	32.44 Peak



Unless otherwise agreed in writing, this document is issued by the Company subject to its General Conditions of Service printed overleaf, available on request or accessible at <http://www.sgs.com/en/Terms-and-Conditions.aspx> and, for electronic format documents, subject to Terms and Conditions for Electronic Documents at <http://www.sgs.com/en/Terms-and-Conditions/Terms-e-Documents.aspx>. Attention is drawn to the limitation of liability, indemnification and jurisdiction issues defined therein. Any holder of this document is advised that information contained hereon reflects the Company's findings at the time of its intervention only and within the limits of Client's instructions, if any. The Company's sole responsibility is to its Client and this document does not exonerate parties to a transaction from exercising all their rights and obligations under the transaction documents. This document cannot be reproduced except in full, without prior written approval of the Company. Any unauthorized alteration, forgery or falsification of the content or appearance of this document is unlawful and offenders may be prosecuted to the fullest extent of the law. Unless otherwise stated the results shown in this test report refer only to the sample(s) tested and such sample(s) are retained for 30 days only.
 Attention: To check the authenticity of testing /inspection report & certificate, please contact us at telephone: (86-755) 8307 1443, or email: CN.Doccheck@sgs.com

Test Mode: 04; Polarity: Vertical; Modulation:802.11ac; Bandwidth:40MHz; Channel:Low

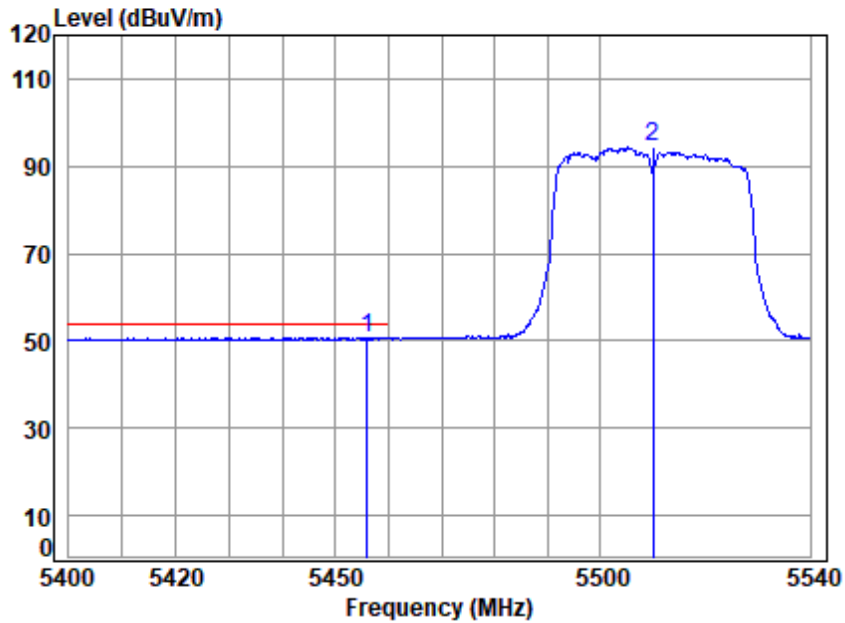

Site : chamber
 Condition: 3m VERTICAL
 Job No : 00028CR/00029CR
 Mode : 5510 Band edge
 : 5G WIFI 11AC40

	Freq	Cable Loss	Ant Factor	Preamp Factor	Read Level	Limit Level	Over Limit	Remark
	MHz	dB	dB/m	dB	dBuV	dBuV/m	dBuV/m	dB
1	5455.850	8.11	34.57	42.35	50.33	50.66	54.00	-3.34 Average
2	5510.000	8.18	34.61	42.35	93.86	94.30	-----	----- Average



Unless otherwise agreed in writing, this document is issued by the Company subject to its General Conditions of Service printed overleaf, available on request or accessible at <http://www.sgs.com/en/Terms-and-Conditions.aspx> and, for electronic format documents, subject to Terms and Conditions for Electronic Documents at <http://www.sgs.com/en/Terms-and-Conditions/Terms-e-Documents.aspx>. Attention is drawn to the limitation of liability, indemnification and jurisdiction issues defined therein. Any holder of this document is advised that information contained hereon reflects the Company's findings at the time of its intervention only and within the limits of Client's instructions, if any. The Company's sole responsibility is to its Client and this document does not exonerate parties to a transaction from exercising all their rights and obligations under the transaction documents. This document cannot be reproduced except in full, without prior written approval of the Company. Any unauthorized alteration, forgery or falsification of the content or appearance of this document is unlawful and offenders may be prosecuted to the fullest extent of the law. Unless otherwise stated the results shown in this test report refer only to the sample(s) tested and such sample(s) are retained for 30 days only.
 Attention: To check the authenticity of testing / inspection report & certificate, please contact us at telephone: (86-755) 8307 1443, or email: CN.Doccheck@sgs.com

Test Mode: 04; Polarity: Horizontal; Modulation:802.11ac; Bandwidth:40MHz; Channel:High

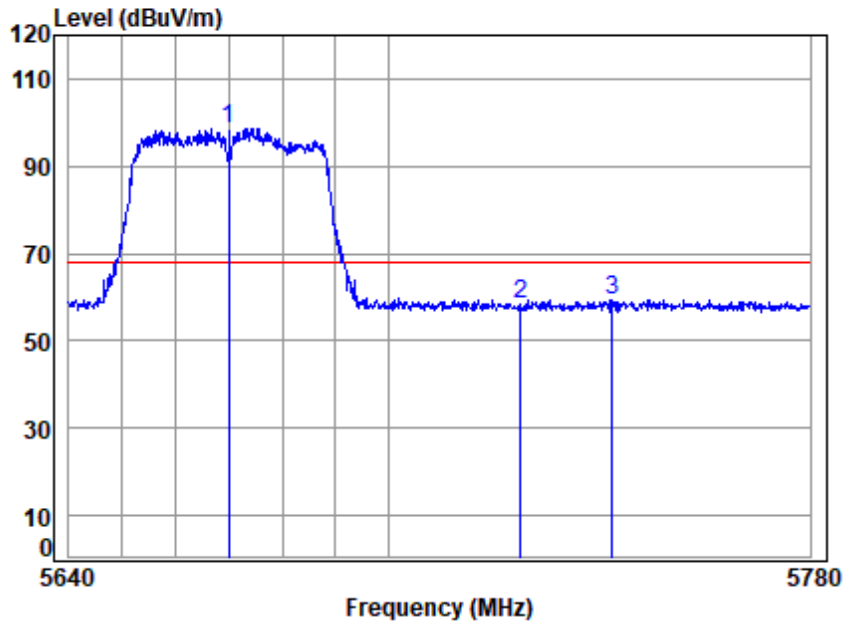

Site : chamber
 Condition: 3m HORIZONTAL
 Job No : 00028CR/00029CR
 Mode : 5670 Band edge
 : 5G WIFI 11AC40

	Cable	Ant	Preamp	Read	Limit	Over	
Freq	Loss	Factor	Factor	Level	Line	Limit	Remark
MHz	dB	dB/m	dB	dBuV	dBuV/m	dBuV/m	dB
1 * 5670.000	8.21	34.77	42.37	98.05	98.66	68.20	30.46 peak
2 5725.000	8.22	34.83	42.37	57.81	58.49	68.20	-9.71 peak
3 5742.284	8.22	34.85	42.38	58.83	59.52	68.20	-8.68 peak



Unless otherwise agreed in writing, this document is issued by the Company subject to its General Conditions of Service printed overleaf, available on request or accessible at <http://www.sgs.com/en/Terms-and-Conditions.aspx> and, for electronic format documents, subject to Terms and Conditions for Electronic Documents at <http://www.sgs.com/en/Terms-and-Conditions/Terms-e-Documents.aspx>. Attention is drawn to the limitation of liability, indemnification and jurisdiction issues defined therein. Any holder of this document is advised that information contained hereon reflects the Company's findings at the time of its intervention only and within the limits of Client's instructions, if any. The Company's sole responsibility is to its Client and this document does not exonerate parties to a transaction from exercising all their rights and obligations under the transaction documents. This document cannot be reproduced except in full, without prior written approval of the Company. Any unauthorized alteration, forgery or falsification of the content or appearance of this document is unlawful and offenders may be prosecuted to the fullest extent of the law. Unless otherwise stated the results shown in this test report refer only to the sample(s) tested and such sample(s) are retained for 30 days only.
 Attention: To check the authenticity of testing / inspection report & certificate, please contact us at telephone: (86-755) 8307 1443, or email: CN.Doccheck@sgs.com

Test Mode: 04; Polarity: Vertical; Modulation:802.11ac; Bandwidth:40MHz; Channel:High

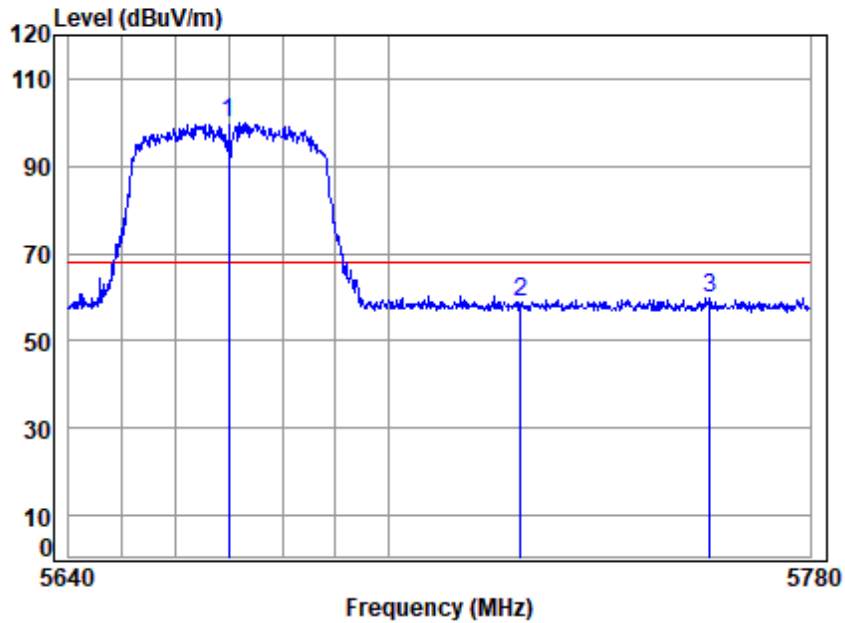

Site : chamber
 Condition: 3m VERTICAL
 Job No : 00028CR/00029CR
 Mode : 5670 Band edge
 : 5G WIFI 11AC40

Freq	Cable Loss	Ant Factor	Preamp Factor	Read Level	Level	Limit Line	Over Limit	Remark
MHz	dB	dB/m	dB	dBuV	dBuV/m	dBuV/m	dB	
1 * 5670.000	8.21	34.77	42.37	99.30	99.91	68.20	31.71	Peak
2 5725.000	8.22	34.83	42.37	58.04	58.72	68.20	-9.48	Peak
3 5760.899	8.22	34.87	42.38	59.17	59.88	68.20	-8.32	Peak



Unless otherwise agreed in writing, this document is issued by the Company subject to its General Conditions of Service printed overleaf, available on request or accessible at <http://www.sgs.com/en/Terms-and-Conditions.aspx> and, for electronic format documents, subject to Terms and Conditions for Electronic Documents at <http://www.sgs.com/en/Terms-and-Conditions/Terms-e-Documents.aspx>. Attention is drawn to the limitation of liability, indemnification and jurisdiction issues defined therein. Any holder of this document is advised that information contained hereon reflects the Company's findings at the time of its intervention only and within the limits of Client's instructions, if any. The Company's sole responsibility is to its Client and this document does not exonerate parties to a transaction from exercising all their rights and obligations under the transaction documents. This document cannot be reproduced except in full, without prior written approval of the Company. Any unauthorized alteration, forgery or falsification of the content or appearance of this document is unlawful and offenders may be prosecuted to the fullest extent of the law. Unless otherwise stated the results shown in this test report refer only to the sample(s) tested and such sample(s) are retained for 30 days only.
 Attention: To check the authenticity of testing / inspection report & certificate, please contact us at telephone: (86-755) 8307 1443, or email: CN.Doccheck@sgs.com

Test Mode: 04; Polarity: Horizontal; Modulation:802.11ac; Bandwidth:80MHz; Channel:Low

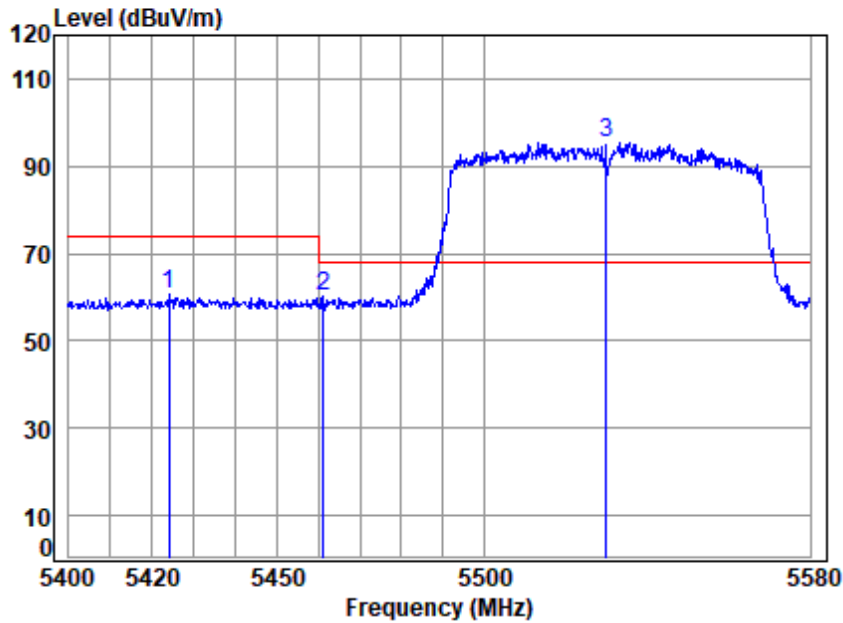

Site : chamber
 Condition: 3m HORIZONTAL
 Job No : 00028CR/00029CR
 Mode : 5530 Band edge
 : 5G WIFI 11AC80

	Cable	Ant	Preamp	Read	Limit	Over		
Freq	Loss	Factor	Factor	Level	Level	Line	Limit	Remark
MHz	dB	dB/m	dB	dBuV	dBuV/m	dBuV/m	dB	
1	5423.957	8.05	34.54	42.34	60.28	60.53	74.00	-13.47 peak
2	5461.076	8.11	34.57	42.35	60.00	60.33	68.20	-7.87 peak
3 *	5530.000	8.19	34.63	42.36	94.94	95.40	68.20	27.20 peak



Unless otherwise agreed in writing, this document is issued by the Company subject to its General Conditions of Service printed overleaf, available on request or accessible at <http://www.sgs.com/en/Terms-and-Conditions.aspx> and, for electronic format documents, subject to Terms and Conditions for Electronic Documents at <http://www.sgs.com/en/Terms-and-Conditions/Terms-e-Documents.aspx>. Attention is drawn to the limitation of liability, indemnification and jurisdiction issues defined therein. Any holder of this document is advised that information contained hereon reflects the Company's findings at the time of its intervention only and within the limits of Client's instructions, if any. The Company's sole responsibility is to its Client and this document does not exonerate parties to a transaction from exercising all their rights and obligations under the transaction documents. This document cannot be reproduced except in full, without prior written approval of the Company. Any unauthorized alteration, forgery or falsification of the content or appearance of this document is unlawful and offenders may be prosecuted to the fullest extent of the law. Unless otherwise stated the results shown in this test report refer only to the sample(s) tested and such sample(s) are retained for 30 days only.
 Attention: To check the authenticity of testing /inspection report & certificate, please contact us at telephone: (86-755) 8307 1443, or email: CN.Doccheck@sgs.com

Test Mode: 04; Polarity: Horizontal; Modulation:802.11ac; Bandwidth:80MHz; Channel:Low

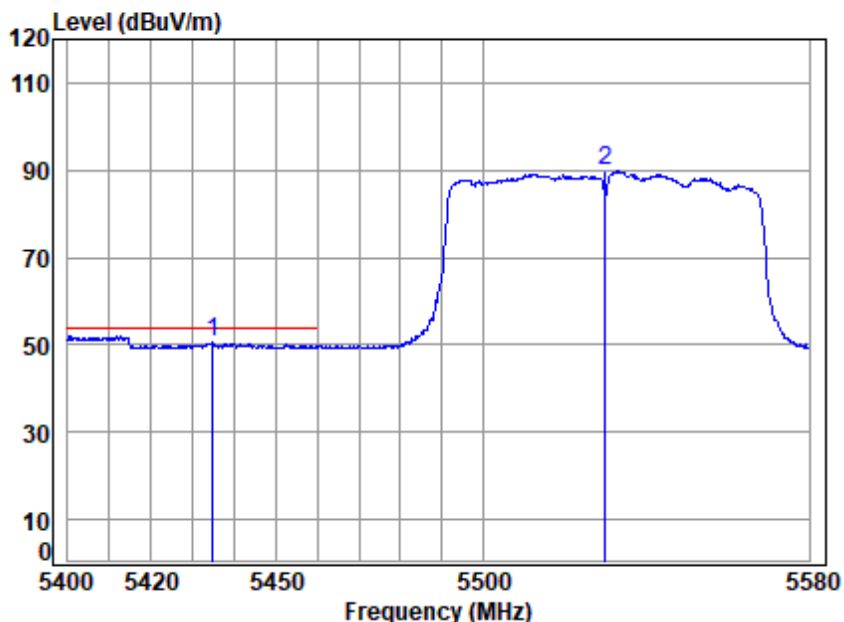

Site : chamber
 Condition: 3m HORIZONTAL
 Job No : 00028CR/00029CR
 Mode : 5530 Band edge
 : 5G WIFI 11AC80

	Cable	Ant	Preamp	Read	Limit	Over		
Freq	Loss	Factor	Factor	Level	Level	Line	Limit	Remark
MHz	dB	dB/m	dB	dBuV	dBuV/m	dBuV/m	dB	
1	5434.638	8.07	34.55	42.35	50.18	50.45	54.00	-3.55 Average
2	5530.000	8.19	34.63	42.36	89.27	89.73	-----	----- Average



Unless otherwise agreed in writing, this document is issued by the Company subject to its General Conditions of Service printed overleaf, available on request or accessible at <http://www.sgs.com/en/Terms-and-Conditions.aspx> and, for electronic format documents, subject to Terms and Conditions for Electronic Documents at <http://www.sgs.com/en/Terms-and-Conditions/Terms-e-Documents.aspx>. Attention is drawn to the limitation of liability, indemnification and jurisdiction issues defined therein. Any holder of this document is advised that information contained hereon reflects the Company's findings at the time of its intervention only and within the limits of Client's instructions, if any. The Company's sole responsibility is to its Client and this document does not exonerate parties to a transaction from exercising all their rights and obligations under the transaction documents. This document cannot be reproduced except in full, without prior written approval of the Company. Any unauthorized alteration, forgery or falsification of the content or appearance of this document is unlawful and offenders may be prosecuted to the fullest extent of the law. Unless otherwise stated the results shown in this test report refer only to the sample(s) tested and such sample(s) are retained for 30 days only.
 Attention: To check the authenticity of testing /inspection report & certificate, please contact us at telephone: (86-755) 8307 1443, or email: CN.Doccheck@sgs.com

Test Mode: 04; Polarity: Vertical; Modulation:802.11ac; Bandwidth:80MHz; Channel:Low

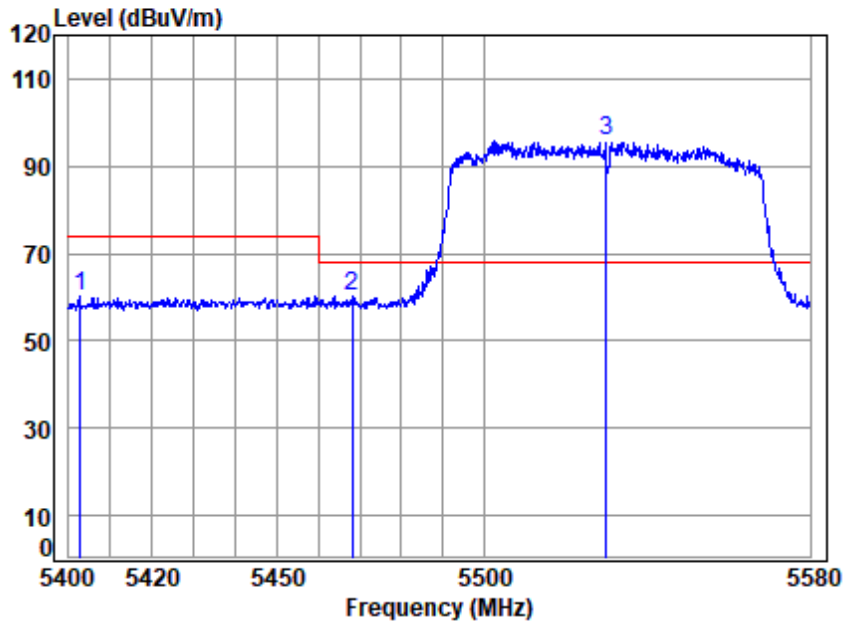

Site : chamber
 Condition: 3m VERTICAL
 Job No : 00028CR/00029CR
 Mode : 5530 Band edge
 : 5G WIFI 11AC80

	Cable	Ant	Preamp	Read	Limit	Over	
Freq	Loss	Factor	Factor	Level	Level	Line	Limit Remark
MHz	dB	dB/m	dB	dBuV	dBuV/m	dBuV/m	dB
1	5402.657	8.02	34.53	42.34	59.95	60.16	74.00 -13.84 Peak
2	5468.244	8.13	34.58	42.35	59.89	60.25	68.20 -7.95 peak
3 *	5530.000	8.19	34.63	42.36	95.34	95.80	68.20 27.60 Peak



Unless otherwise agreed in writing, this document is issued by the Company subject to its General Conditions of Service printed overleaf, available on request or accessible at <http://www.sgs.com/en/Terms-and-Conditions.aspx> and, for electronic format documents, subject to Terms and Conditions for Electronic Documents at <http://www.sgs.com/en/Terms-and-Conditions/Terms-e-Documents.aspx>. Attention is drawn to the limitation of liability, indemnification and jurisdiction issues defined therein. Any holder of this document is advised that information contained hereon reflects the Company's findings at the time of its intervention only and within the limits of Client's instructions, if any. The Company's sole responsibility is to its Client and this document does not exonerate parties to a transaction from exercising all their rights and obligations under the transaction documents. This document cannot be reproduced except in full, without prior written approval of the Company. Any unauthorized alteration, forgery or falsification of the content or appearance of this document is unlawful and offenders may be prosecuted to the fullest extent of the law. Unless otherwise stated the results shown in this test report refer only to the sample(s) tested and such sample(s) are retained for 30 days only.
 Attention: To check the authenticity of testing / inspection report & certificate, please contact us at telephone: (86-755) 8307 1443, or email: CN.Doccheck@sgs.com

Test Mode: 04; Polarity: Vertical; Modulation:802.11ac; Bandwidth:80MHz; Channel:Low

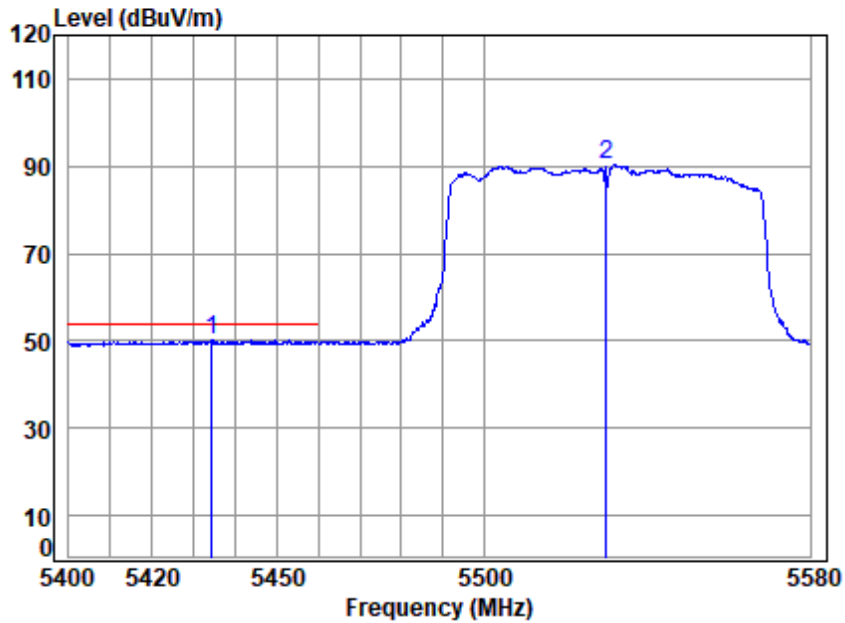

Site : chamber
 Condition: 3m VERTICAL
 Job No : 00028CR/00029CR
 Mode : 5530 Band edge
 : 5G WIFI 11AC80

	Freq	Cable Loss	Ant Factor	Preamp Factor	Read Level	Limit Level	Over Line	Over Limit	Remark
	MHz	dB	dB/m	dB	dBuV	dBuV/m	dBuV/m	dB	
1	5434.282	8.07	34.55	42.35	49.88	50.15	54.00	-3.85	Average
2	5530.000	8.19	34.63	42.36	89.83	90.29	-----	-----	Average



Test Mode: 04; Polarity: Horizontal; Modulation:802.11ac; Bandwidth:80MHz; Channel:High

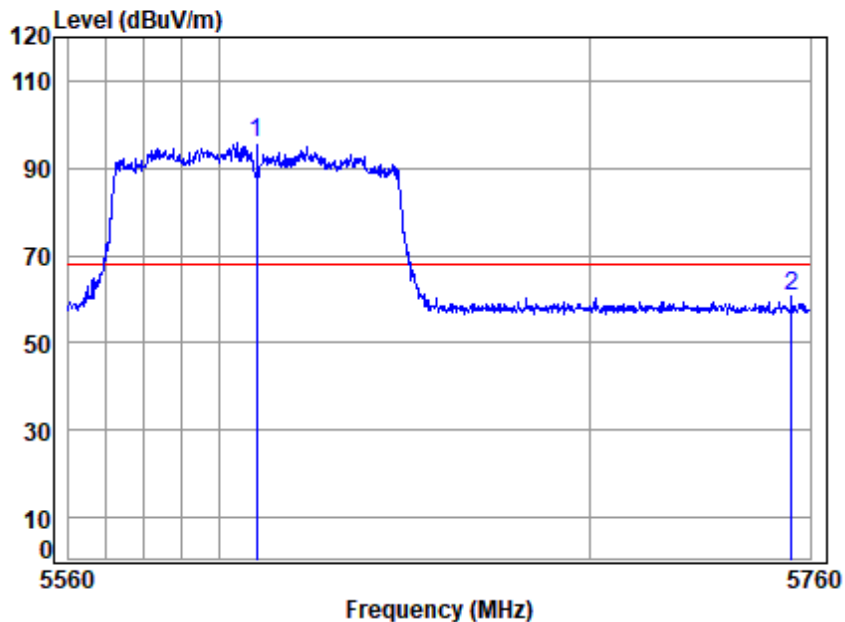

Site : chamber
 Condition: 3m HORIZONTAL
 Job No : 00028CR/00029CR
 Mode : 5610 Band edge
 : 5G WIFI 11AC80

	Cable	Ant	Preamp	Read	Limit	Over	
Freq	Loss	Factor	Factor	Level	Level	Line	Limit Remark
MHz	dB	dB/m	dB	dBuV	dBuV/m	dBuV/m	dB
1 * 5610.000	8.20	34.71	42.36	95.27	95.82	68.20	27.62 peak
2 5754.914	8.22	34.86	42.38	59.97	60.67	68.20	-7.53 peak



Unless otherwise agreed in writing, this document is issued by the Company subject to its General Conditions of Service printed overleaf, available on request or accessible at <http://www.sgs.com/en/Terms-and-Conditions.aspx> and, for electronic format documents, subject to Terms and Conditions for Electronic Documents at <http://www.sgs.com/en/Terms-and-Conditions/Terms-e-Documents.aspx>. Attention is drawn to the limitation of liability, indemnification and jurisdiction issues defined therein. Any holder of this document is advised that information contained hereon reflects the Company's findings at the time of its intervention only and within the limits of Client's instructions, if any. The Company's sole responsibility is to its Client and this document does not exonerate parties to a transaction from exercising all their rights and obligations under the transaction documents. This document cannot be reproduced except in full, without prior written approval of the Company. Any unauthorized alteration, forgery or falsification of the content or appearance of this document is unlawful and offenders may be prosecuted to the fullest extent of the law. Unless otherwise stated the results shown in this test report refer only to the sample(s) tested and such sample(s) are retained for 30 days only.
 Attention: To check the authenticity of testing / inspection report & certificate, please contact us at telephone: (86-755) 8307 1443, or email: CN.Doccheck@sgs.com

Test Mode: 04; Polarity: Vertical; Modulation:802.11ac; Bandwidth:80MHz; Channel:High

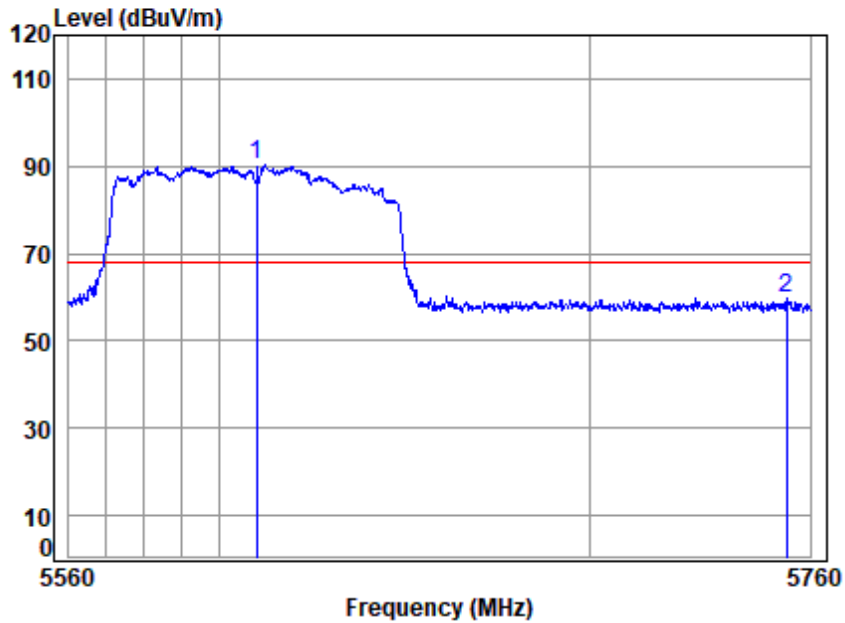

Site : chamber
 Condition: 3m VERTICAL
 Job No : 00028CR/00029CR
 Mode : 5610 Band edge
 : 5G WIFI 11AC80

	Cable	Ant	Preamp	Read	Limit	Over	
Freq	Loss	Factor	Factor	Level	Level	Line	Limit
MHz	dB	dB/m	dB	dBuV	dBuV/m	dBuV/m	dB
1 * 5610.000	8.20	34.71	42.36	89.73	90.28	68.20	22.08 Peak
2 5753.490	8.22	34.86	42.38	58.92	59.62	68.20	-8.58 Peak



Unless otherwise agreed in writing, this document is issued by the Company subject to its General Conditions of Service printed overleaf, available on request or accessible at <http://www.sgs.com/en/Terms-and-Conditions.aspx> and, for electronic format documents, subject to Terms and Conditions for Electronic Documents at <http://www.sgs.com/en/Terms-and-Conditions/Terms-e-Documents.aspx>. Attention is drawn to the limitation of liability, indemnification and jurisdiction issues defined therein. Any holder of this document is advised that information contained hereon reflects the Company's findings at the time of its intervention only and within the limits of Client's instructions, if any. The Company's sole responsibility is to its Client and this document does not exonerate parties to a transaction from exercising all their rights and obligations under the transaction documents. This document cannot be reproduced except in full, without prior written approval of the Company. Any unauthorized alteration, forgery or falsification of the content or appearance of this document is unlawful and offenders may be prosecuted to the fullest extent of the law. Unless otherwise stated the results shown in this test report refer only to the sample(s) tested and such sample(s) are retained for 30 days only.
 Attention: To check the authenticity of testing / inspection report & certificate, please contact us at telephone: (86-755) 8307 1443, or email: CN.Doccheck@sgs.com

Test Mode: 05; Polarity: Horizontal; Modulation:802.11a; Bandwidth:20MHz; Channel:Low

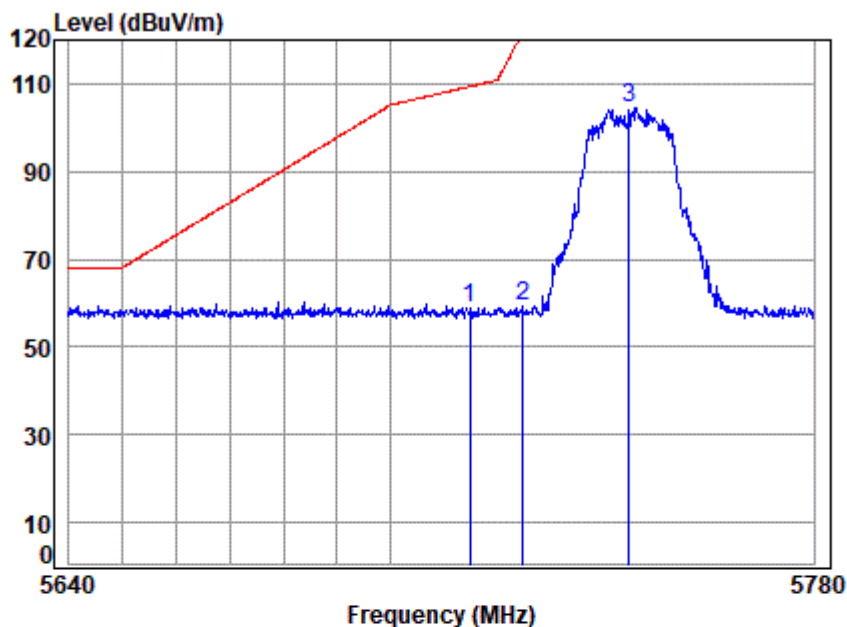

Site : chamber
 Condition: 3m HORIZONTAL
 Job No : 00028CR/00029CR
 Mode : 5745 Band edge
 : 5G WIFI 11A

	Cable	Ant	Preamp	Read	Limit	Over		
Freq	Loss	Factor	Factor	Level	Level	Line	Limit	Remark
MHz	dB	dB/m	dB	dBuV	dBuV/m	dBuV/m	dB	
1	5715.000	8.22	34.82	42.37	58.27	58.94	109.40	-50.46 peak
2	5725.000	8.22	34.83	42.37	58.73	59.41	122.20	-62.79 peak
3	5745.000	8.22	34.85	42.38	103.81	104.50	-----	----- peak



Unless otherwise agreed in writing, this document is issued by the Company subject to its General Conditions of Service printed overleaf, available on request or accessible at <http://www.sgs.com/en/Terms-and-Conditions.aspx> and, for electronic format documents, subject to Terms and Conditions for Electronic Documents at <http://www.sgs.com/en/Terms-and-Conditions/Terms-e-Documents.aspx>. Attention is drawn to the limitation of liability, indemnification and jurisdiction issues defined therein. Any holder of this document is advised that information contained hereon reflects the Company's findings at the time of its intervention only and within the limits of Client's instructions, if any. The Company's sole responsibility is to its Client and this document does not exonerate parties to a transaction from exercising all their rights and obligations under the transaction documents. This document cannot be reproduced except in full, without prior written approval of the Company. Any unauthorized alteration, forgery or falsification of the content or appearance of this document is unlawful and offenders may be prosecuted to the fullest extent of the law. Unless otherwise stated the results shown in this test report refer only to the sample(s) tested and such sample(s) are retained for 30 days only.
 Attention: To check the authenticity of testing / inspection report & certificate, please contact us at telephone: (86-755) 8307 1443, or email: CN.Doccheck@sgs.com

Test Mode: 05; Polarity: Vertical; Modulation:802.11a; Bandwidth:20MHz; Channel:Low

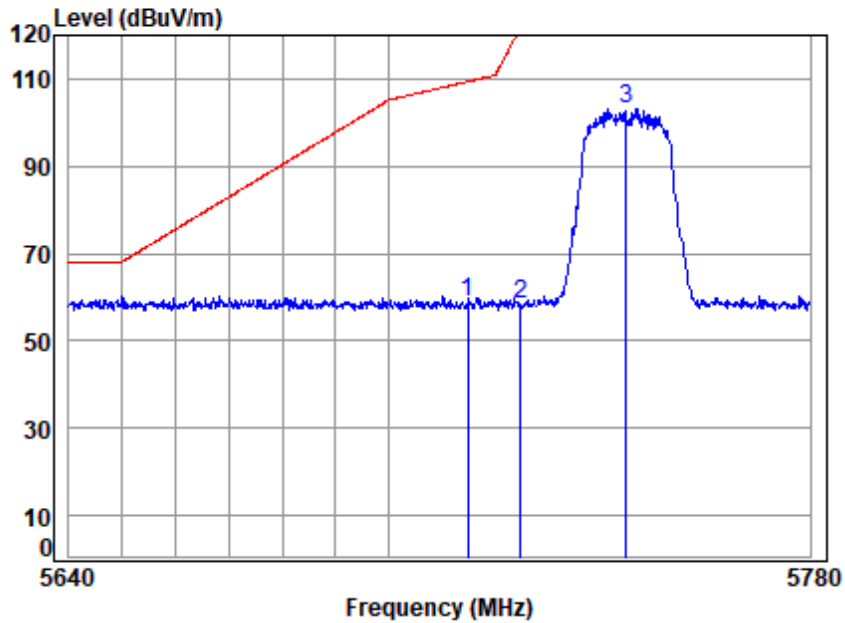

Site : chamber
 Condition: 3m VERTICAL
 Job No : 00028CR/00029CR
 Mode : 5745 Band edge
 : 5G WIFI 11A

	Freq	Cable Loss	Ant Factor	Preamp Factor	Read Level	Limit Level	Limit Line	Over Limit	Remark
	MHz	dB	dB/m	dB	dBuV	dBuV/m	dBuV/m	dB	
1	5715.000	8.22	34.82	42.37	58.02	58.69	109.40	-50.71	peak
2	5725.000	8.22	34.83	42.37	57.50	58.18	122.20	-64.02	peak
3	5745.000	8.22	34.85	42.38	102.60	103.29	-----	-----	peak



Unless otherwise agreed in writing, this document is issued by the Company subject to its General Conditions of Service printed overleaf, available on request or accessible at <http://www.sgs.com/en/Terms-and-Conditions.aspx> and, for electronic format documents, subject to Terms and Conditions for Electronic Documents at <http://www.sgs.com/en/Terms-and-Conditions/Terms-e-Documents.aspx>. Attention is drawn to the limitation of liability, indemnification and jurisdiction issues defined therein. Any holder of this document is advised that information contained hereon reflects the Company's findings at the time of its intervention only and within the limits of Client's instructions, if any. The Company's sole responsibility is to its Client and this document does not exonerate parties to a transaction from exercising all their rights and obligations under the transaction documents. This document cannot be reproduced except in full, without prior written approval of the Company. Any unauthorized alteration, forgery or falsification of the content or appearance of this document is unlawful and offenders may be prosecuted to the fullest extent of the law. Unless otherwise stated the results shown in this test report refer only to the sample(s) tested and such sample(s) are retained for 30 days only.
 Attention: To check the authenticity of testing / inspection report & certificate, please contact us at telephone: (86-755) 8307 1443, or email: CN.Doccheck@sgs.com

Test Mode: 05; Polarity: Horizontal; Modulation:802.11a; Bandwidth:20MHz; Channel:High

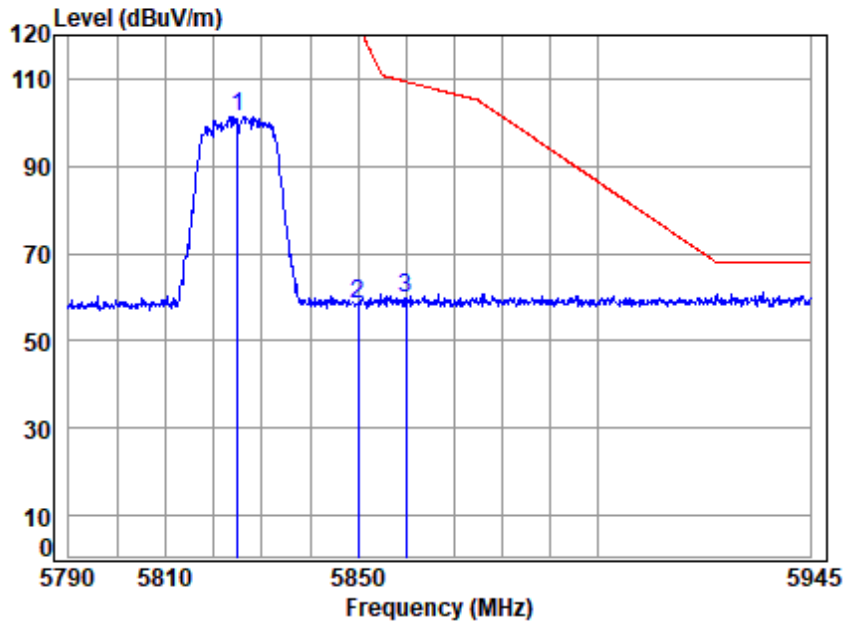

Site : chamber
 Condition: 3m HORIZONTAL
 Job No : 00028CR/00029CR
 Mode : 5825 Band edge
 : 5G WIFI 11A

	Cable	Ant	Preamp	Read	Limit	Over		
Freq	Loss	Factor	Factor	Level	Level	Line	Limit	
MHz	dB	dB/m	dB	dBuV	dBuV/m	dBuV/m	dB	
1 5825.000	8.23	34.93	42.38	100.71	101.49	-----	-----	peak
2 5850.000	8.24	34.95	42.39	57.67	58.47	122.20	-63.73	peak
3 5860.000	8.24	34.96	42.39	58.94	59.75	109.40	-49.65	peak



Unless otherwise agreed in writing, this document is issued by the Company subject to its General Conditions of Service printed overleaf, available on request or accessible at <http://www.sgs.com/en/Terms-and-Conditions.aspx> and, for electronic format documents, subject to Terms and Conditions for Electronic Documents at <http://www.sgs.com/en/Terms-and-Conditions/Terms-e-Documents.aspx>. Attention is drawn to the limitation of liability, indemnification and jurisdiction issues defined therein. Any holder of this document is advised that information contained hereon reflects the Company's findings at the time of its intervention only and within the limits of Client's instructions, if any. The Company's sole responsibility is to its Client and this document does not exonerate parties to a transaction from exercising all their rights and obligations under the transaction documents. This document cannot be reproduced except in full, without prior written approval of the Company. Any unauthorized alteration, forgery or falsification of the content or appearance of this document is unlawful and offenders may be prosecuted to the fullest extent of the law. Unless otherwise stated the results shown in this test report refer only to the sample(s) tested and such sample(s) are retained for 30 days only.
 Attention: To check the authenticity of testing /inspection report & certificate, please contact us at telephone: (86-755) 8307 1443, or email: CN.Doccheck@sgs.com

Test Mode: 05; Polarity: Vertical; Modulation:802.11a; Bandwidth:20MHz; Channel:High

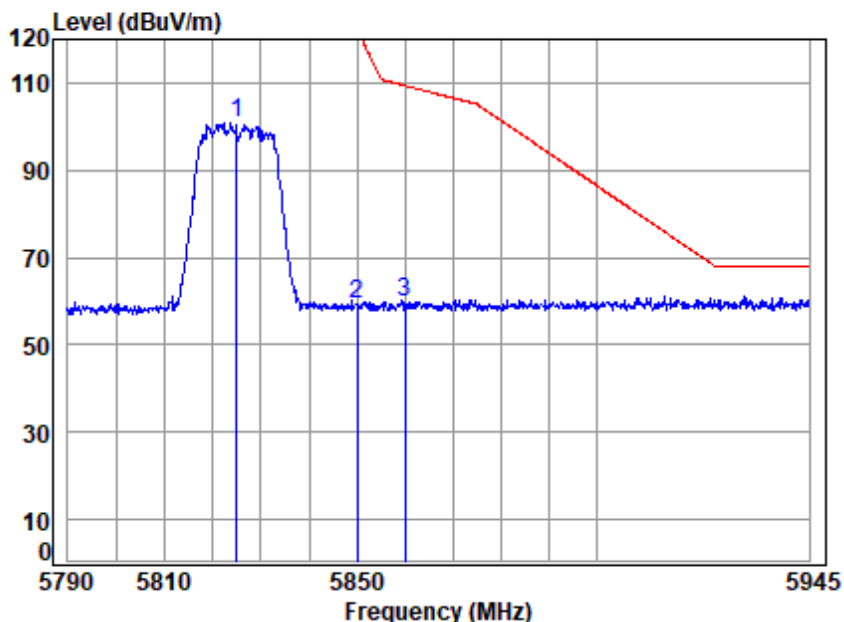

Site : chamber
 Condition: 3m VERTICAL
 Job No : 00028CR/00029CR
 Mode : 5825 Band edge
 : 5G WIFI 11A

	Freq	Cable Loss	Ant Factor	Preamp Factor	Read Level	Limit Level	Limit Line	Over Limit	Remark
	MHz	dB	dB/m	dB	dBuV	dBuV/m	dBuV/m	dB	
1	5825.000	8.23	34.93	42.38	100.05	100.83	-----	-----	peak
2	5850.000	8.24	34.95	42.39	58.29	59.09	122.20	-63.11	peak
3	5860.000	8.24	34.96	42.39	59.11	59.92	109.40	-49.48	peak



Unless otherwise agreed in writing, this document is issued by the Company subject to its General Conditions of Service printed overleaf, available on request or accessible at <http://www.sgs.com/en/Terms-and-Conditions.aspx> and, for electronic format documents, subject to Terms and Conditions for Electronic Documents at <http://www.sgs.com/en/Terms-and-Conditions/Terms-e-Documents.aspx>. Attention is drawn to the limitation of liability, indemnification and jurisdiction issues defined therein. Any holder of this document is advised that information contained hereon reflects the Company's findings at the time of its intervention only and within the limits of Client's instructions, if any. The Company's sole responsibility is to its Client and this document does not exonerate parties to a transaction from exercising all their rights and obligations under the transaction documents. This document cannot be reproduced except in full, without prior written approval of the Company. Any unauthorized alteration, forgery or falsification of the content or appearance of this document is unlawful and offenders may be prosecuted to the fullest extent of the law. Unless otherwise stated the results shown in this test report refer only to the sample(s) tested and such sample(s) are retained for 30 days only.
 Attention: To check the authenticity of testing / inspection report & certificate, please contact us at telephone: (86-755) 8307 1443, or email: CN.Doccheck@sgs.com

Test Mode: 05; Polarity: Horizontal; Modulation:802.11n; Bandwidth:20MHz; Channel:Low

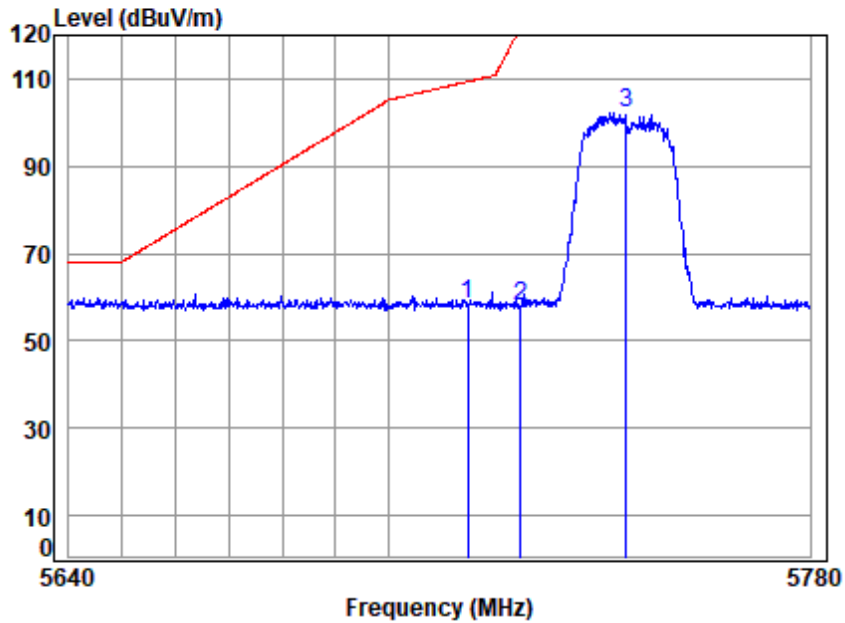

Site : chamber
 Condition: 3m HORIZONTAL
 Job No : 00028CR/00029CR
 Mode : 5745 Band edge
 : 5G WIFI 11N20

	Cable	Ant	Preamp	Read	Limit	Over	
Freq	Loss	Factor	Factor	Level	Level	Line	Limit Remark
MHz	dB	dB/m	dB	dBuV	dBuV/m	dBuV/m	dB
1 5715.000	8.22	34.82	42.37	57.82	58.49	109.40	-50.91 peak
2 5725.000	8.22	34.83	42.37	57.37	58.05	122.20	-64.15 peak
3 5745.000	8.22	34.85	42.38	101.39	102.08	-----	----- peak



Unless otherwise agreed in writing, this document is issued by the Company subject to its General Conditions of Service printed overleaf, available on request or accessible at <http://www.sgs.com/en/Terms-and-Conditions.aspx> and, for electronic format documents, subject to Terms and Conditions for Electronic Documents at <http://www.sgs.com/en/Terms-and-Conditions/Terms-e-Documents.aspx>. Attention is drawn to the limitation of liability, indemnification and jurisdiction issues defined therein. Any holder of this document is advised that information contained hereon reflects the Company's findings at the time of its intervention only and within the limits of Client's instructions, if any. The Company's sole responsibility is to its Client and this document does not exonerate parties to a transaction from exercising all their rights and obligations under the transaction documents. This document cannot be reproduced except in full, without prior written approval of the Company. Any unauthorized alteration, forgery or falsification of the content or appearance of this document is unlawful and offenders may be prosecuted to the fullest extent of the law. Unless otherwise stated the results shown in this test report refer only to the sample(s) tested and such sample(s) are retained for 30 days only.
 Attention: To check the authenticity of testing / inspection report & certificate, please contact us at telephone: (86-755) 8307 1443, or email: CN.Doccheck@sgs.com

Test Mode: 05; Polarity: Vertical; Modulation:802.11n; Bandwidth:20MHz; Channel:Low

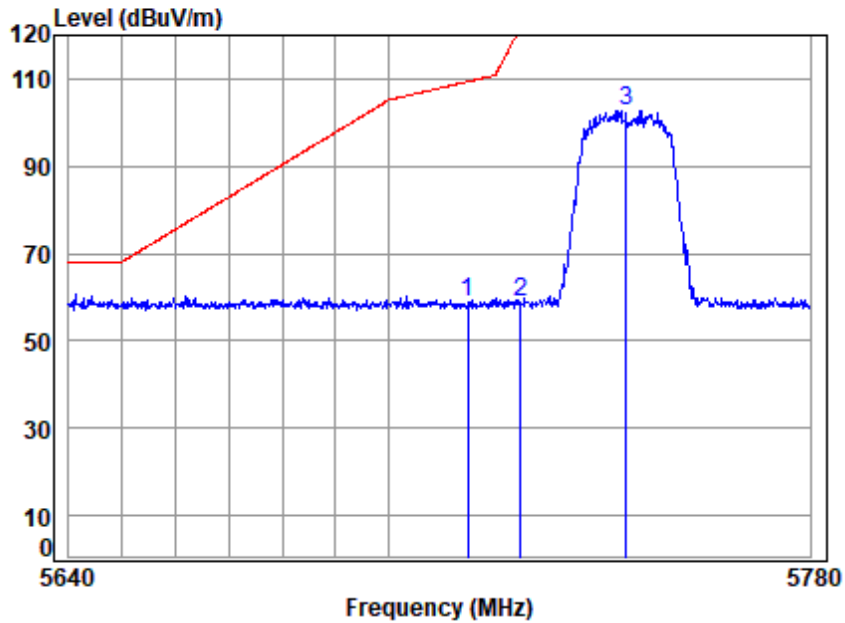

Site : chamber
 Condition: 3m VERTICAL
 Job No : 00028CR/00029CR
 Mode : 5745 Band edge
 : 5G WIFI 11N20

	Freq	Cable Loss	Ant Factor	Preamp Factor	Read Level	Limit Level	Limit Line	Over Limit	Remark
	MHz	dB	dB/m	dB	dBuV	dBuV/m	dBuV/m	dB	
1	5715.000	8.22	34.82	42.37	58.29	58.96	109.40	-50.44	peak
2	5725.000	8.22	34.83	42.37	58.26	58.94	122.20	-63.26	peak
3	5745.000	8.22	34.85	42.38	102.12	102.81	-----	-----	peak



Test Mode: 05; Polarity: Horizontal; Modulation:802.11n; Bandwidth:20MHz; Channel:High

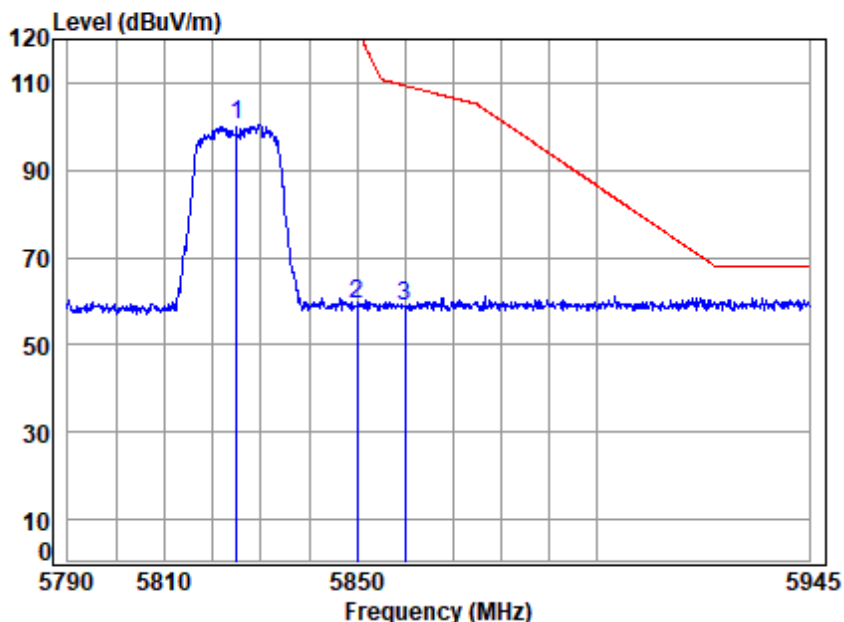

Site : chamber
 Condition: 3m HORIZONTAL
 Job No : 00028CR/00029CR
 Mode : 5825 Band edge
 : 5G WIFI 11N20

	Freq	Cable Loss	Ant Factor	Preamp Factor	Read Level	Limit Level	Limit Line	Over Limit	Remark
	MHz	dB	dB/m	dB	dBuV	dBuV/m	dBuV/m	dB	
1	5825.000	8.23	34.93	42.38	99.78	100.56	-----	-----	peak
2	5850.000	8.24	34.95	42.39	58.34	59.14	122.20	-63.06	peak
3	5860.000	8.24	34.96	42.39	58.04	58.85	109.40	-50.55	peak



Test Mode: 05; Polarity: Vertical; Modulation:802.11n; Bandwidth:20MHz; Channel:High

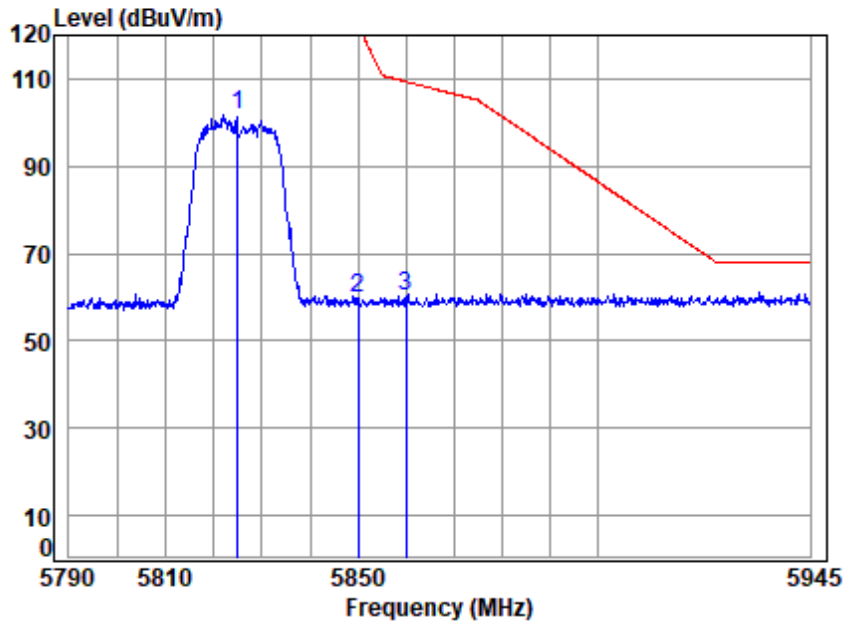

Site : chamber
 Condition: 3m VERTICAL
 Job No : 00028CR/00029CR
 Mode : 5825 Band edge
 : 5G WIFI 11N20

	Freq	Cable Loss	Ant Factor	Preamp Factor	Read Level	Limit Level	Limit Line	Over Limit	Remark
	MHz	dB	dB/m	dB	dBuV	dBuV/m	dBuV/m	dB	
1	5825.000	8.23	34.93	42.38	100.77	101.55	-----	-----	peak
2	5850.000	8.24	34.95	42.39	58.81	59.61	122.20	-62.59	peak
3	5860.000	8.24	34.96	42.39	59.57	60.38	109.40	-49.02	peak



Unless otherwise agreed in writing, this document is issued by the Company subject to its General Conditions of Service printed overleaf, available on request or accessible at <http://www.sgs.com/en/Terms-and-Conditions.aspx> and, for electronic format documents, subject to Terms and Conditions for Electronic Documents at <http://www.sgs.com/en/Terms-and-Conditions/Terms-e-Documents.aspx>. Attention is drawn to the limitation of liability, indemnification and jurisdiction issues defined therein. Any holder of this document is advised that information contained hereon reflects the Company's findings at the time of its intervention only and within the limits of Client's instructions, if any. The Company's sole responsibility is to its Client and this document does not exonerate parties to a transaction from exercising all their rights and obligations under the transaction documents. This document cannot be reproduced except in full, without prior written approval of the Company. Any unauthorized alteration, forgery or falsification of the content or appearance of this document is unlawful and offenders may be prosecuted to the fullest extent of the law. Unless otherwise stated the results shown in this test report refer only to the sample(s) tested and such sample(s) are retained for 30 days only.
 Attention: To check the authenticity of testing / inspection report & certificate, please contact us at telephone: (86-755) 8307 1443, or email: CN.Doccheck@sgs.com

Test Mode: 05; Polarity: Horizontal; Modulation:802.11n; Bandwidth:40MHz; Channel:Low

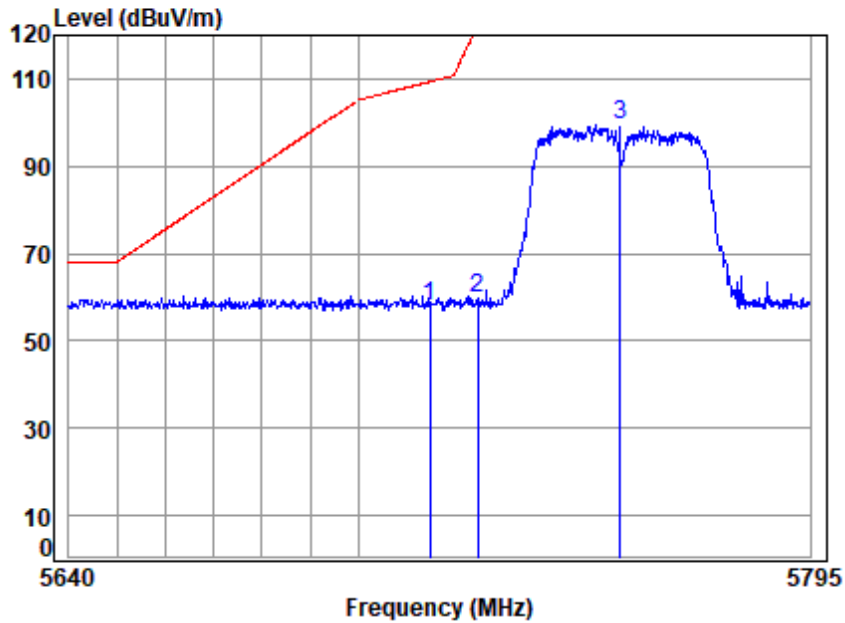

Site : chamber
 Condition: 3m HORIZONTAL
 Job No : 00028CR/00029CR
 Mode : 5755 Band edge
 : 5G WIFI 11N40

	Freq	Cable Loss	Ant Factor	Preamp Factor	Read Level	Limit Level	Limit Line	Over Limit	Remark
	MHz	dB	dB/m	dB	dBuV	dBuV/m	dBuV/m	dB	
1	5715.000	8.22	34.82	42.37	57.47	58.14	109.40	-51.26	peak
2	5725.000	8.22	34.83	42.37	59.15	59.83	122.20	-62.37	peak
3	5755.000	8.22	34.86	42.38	98.67	99.37	-----	-----	peak



Test Mode: 05; Polarity: Vertical; Modulation:802.11n; Bandwidth:40MHz; Channel:Low

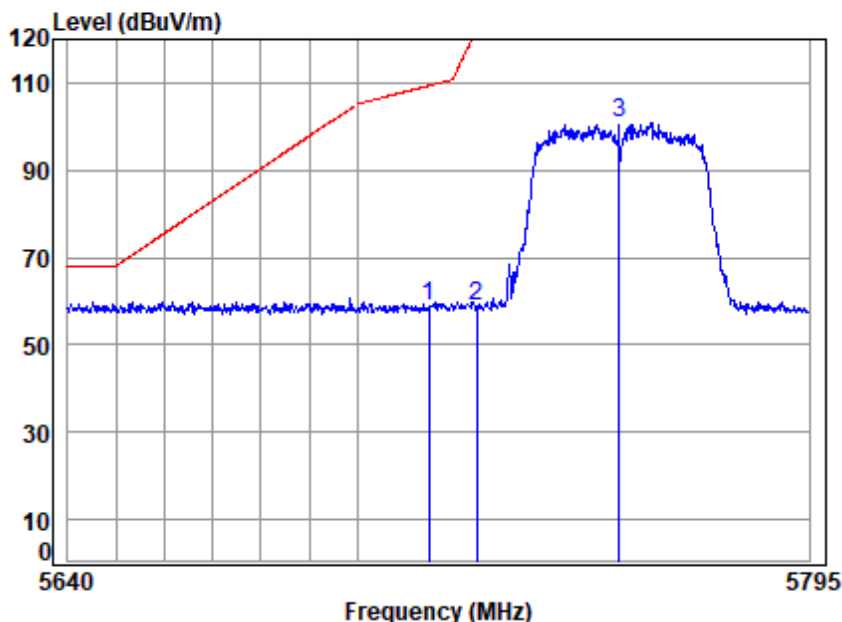

Site : chamber
 Condition: 3m VERTICAL
 Job No : 00028CR/00029CR
 Mode : 5755 Band edge
 : 5G WIFI 11N40

	Cable	Ant	Preamp	Read	Limit	Over	
Freq	Loss	Factor	Factor	Level	Level	Line	Limit Remark
MHz	dB	dB/m	dB	dBuV	dBuV/m	dBuV/m	dB
1	5715.000	8.22	34.82	42.37	58.02	58.69	109.40 -50.71 peak
2	5725.000	8.22	34.83	42.37	58.01	58.69	122.20 -63.51 peak
3	5755.000	8.22	34.86	42.38	100.17	100.87	----- ----- peak



Test Mode: 05; Polarity: Horizontal; Modulation:802.11n; Bandwidth:40MHz; Channel:High

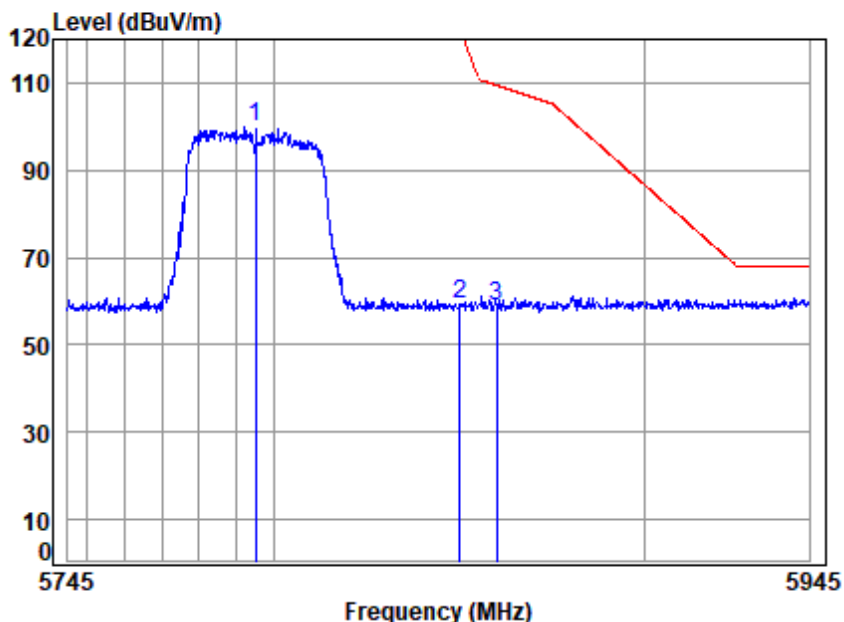

Site : chamber
 Condition: 3m HORIZONTAL
 Job No : 00028CR/00029CR
 Mode : 5795 Band edge
 : 5G WIFI 11N40

	Cable	Ant	Preamp	Read	Limit	Over		
Freq	Loss	Factor	Factor	Level	Level	Line	Limit	
MHz	dB	dB/m	dB	dBuV	dBuV/m	dBuV/m	dB	
1	5795.000	8.23	34.90	42.38	99.07	99.82	-----	peak
2	5850.000	8.24	34.95	42.39	58.44	59.24	122.20	-62.96 peak
3	5860.000	8.24	34.96	42.39	58.19	59.00	109.40	-50.40 peak



Unless otherwise agreed in writing, this document is issued by the Company subject to its General Conditions of Service printed overleaf, available on request or accessible at <http://www.sgs.com/en/Terms-and-Conditions.aspx> and, for electronic format documents, subject to Terms and Conditions for Electronic Documents at <http://www.sgs.com/en/Terms-and-Conditions/Terms-e-Documents.aspx>. Attention is drawn to the limitation of liability, indemnification and jurisdiction issues defined therein. Any holder of this document is advised that information contained hereon reflects the Company's findings at the time of its intervention only and within the limits of Client's instructions, if any. The Company's sole responsibility is to its Client and this document does not exonerate parties to a transaction from exercising all their rights and obligations under the transaction documents. This document cannot be reproduced except in full, without prior written approval of the Company. Any unauthorized alteration, forgery or falsification of the content or appearance of this document is unlawful and offenders may be prosecuted to the fullest extent of the law. Unless otherwise stated the results shown in this test report refer only to the sample(s) tested and such sample(s) are retained for 30 days only.
 Attention: To check the authenticity of testing /inspection report & certificate, please contact us at telephone: (86-755) 8307 1443, or email: CN.Doccheck@sgs.com

Test Mode: 05; Polarity: Vertical; Modulation:802.11n; Bandwidth:40MHz; Channel:High

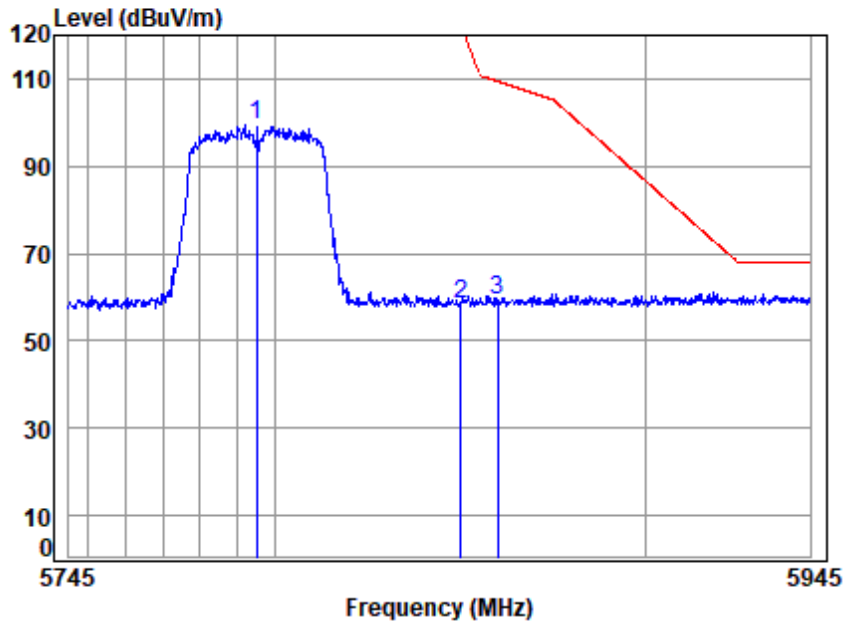

Site : chamber
 Condition: 3m VERTICAL
 Job No : 00028CR/00029CR
 Mode : 5795 Band edge
 : 5G WIFI 11N40

	Cable	Ant	Preamp	Read	Limit	Over		
Freq	Loss	Factor	Factor	Level	Level	Line	Limit	
MHz	dB	dB/m	dB	dBuV	dBuV/m	dBuV/m	dB	
1	5795.000	8.23	34.90	42.38	98.53	99.28	-----	peak
2	5850.000	8.24	34.95	42.39	57.48	58.28	122.20	-63.92 peak
3	5860.000	8.24	34.96	42.39	58.68	59.49	109.40	-49.91 peak



Unless otherwise agreed in writing, this document is issued by the Company subject to its General Conditions of Service printed overleaf, available on request or accessible at <http://www.sgs.com/en/Terms-and-Conditions.aspx> and, for electronic format documents, subject to Terms and Conditions for Electronic Documents at <http://www.sgs.com/en/Terms-and-Conditions/Terms-e-Documents.aspx>. Attention is drawn to the limitation of liability, indemnification and jurisdiction issues defined therein. Any holder of this document is advised that information contained hereon reflects the Company's findings at the time of its intervention only and within the limits of Client's instructions, if any. The Company's sole responsibility is to its Client and this document does not exonerate parties to a transaction from exercising all their rights and obligations under the transaction documents. This document cannot be reproduced except in full, without prior written approval of the Company. Any unauthorized alteration, forgery or falsification of the content or appearance of this document is unlawful and offenders may be prosecuted to the fullest extent of the law. Unless otherwise stated the results shown in this test report refer only to the sample(s) tested and such sample(s) are retained for 30 days only.
 Attention: To check the authenticity of testing / inspection report & certificate, please contact us at telephone: (86-755) 8307 1443, or email: CN.Doccheck@sgs.com

Test Mode: 05; Polarity: Horizontal; Modulation:802.11ac; Bandwidth:20MHz; Channel:Low

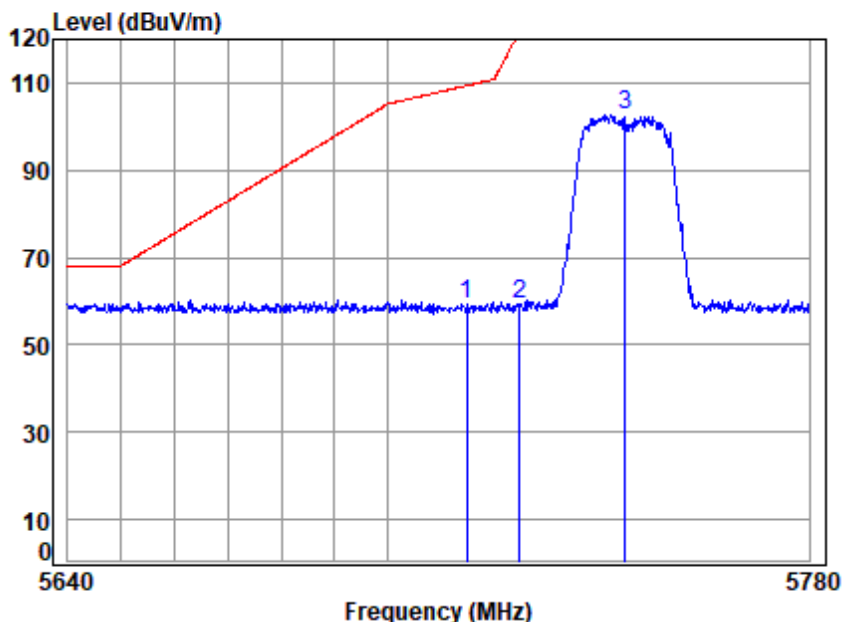

Site : chamber
 Condition: 3m HORIZONTAL
 Job No : 00028CR/00029CR
 Mode : 5745 Band edge
 : 5G WIFI 11AC20

	Cable	Ant	Preamp	Read	Limit	Over			
Freq	Loss	Factor	Factor	Level	Level	Line	Limit		
MHz	dB	dB/m	dB	dBuV	dBuV/m	dBuV/m	dB		
1	5715.000	8.22	34.82	42.37	58.69	59.36	109.40	-50.04	peak
2	5725.000	8.22	34.83	42.37	58.72	59.40	122.20	-62.80	peak
3	5745.000	8.22	34.85	42.38	101.85	102.54	-----	-----	peak



Unless otherwise agreed in writing, this document is issued by the Company subject to its General Conditions of Service printed overleaf, available on request or accessible at <http://www.sgs.com/en/Terms-and-Conditions.aspx> and, for electronic format documents, subject to Terms and Conditions for Electronic Documents at <http://www.sgs.com/en/Terms-and-Conditions/Terms-e-Documents.aspx>. Attention is drawn to the limitation of liability, indemnification and jurisdiction issues defined therein. Any holder of this document is advised that information contained hereon reflects the Company's findings at the time of its intervention only and within the limits of Client's instructions, if any. The Company's sole responsibility is to its Client and this document does not exonerate parties to a transaction from exercising all their rights and obligations under the transaction documents. This document cannot be reproduced except in full, without prior written approval of the Company. Any unauthorized alteration, forgery or falsification of the content or appearance of this document is unlawful and offenders may be prosecuted to the fullest extent of the law. Unless otherwise stated the results shown in this test report refer only to the sample(s) tested and such sample(s) are retained for 30 days only.
 Attention: To check the authenticity of testing / inspection report & certificate, please contact us at telephone: (86-755) 8307 1443, or email: CN.Doccheck@sgs.com

Test Mode: 05; Polarity: Vertical; Modulation:802.11ac; Bandwidth:20MHz; Channel:Low

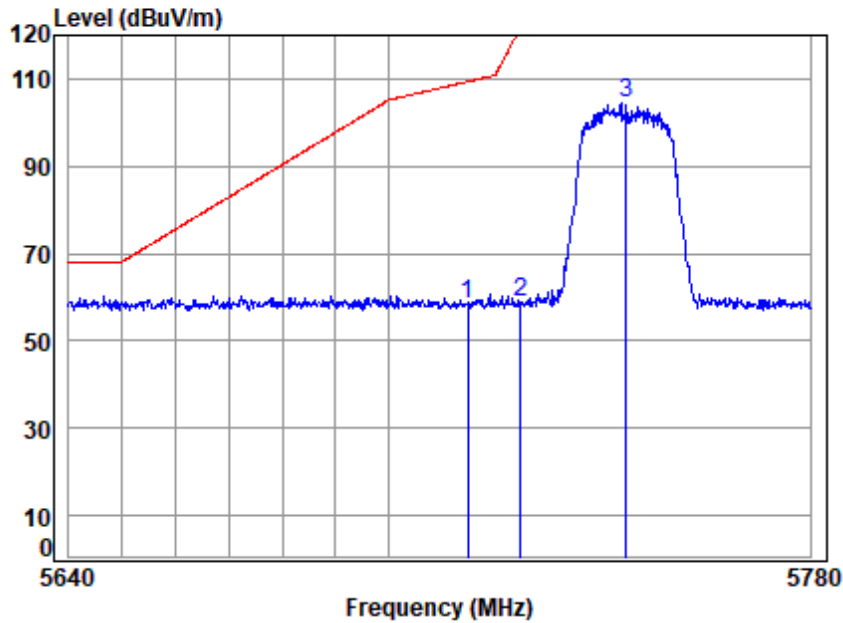

Site : chamber
 Condition: 3m VERTICAL
 Job No : 00028CR/00029CR
 Mode : 5745 Band edge
 : 5G WIFI 11AC20

	Cable	Ant	Preamp	Read	Limit	Over			
Freq	Loss	Factor	Factor	Level	Level	Line	Limit		
MHz	dB	dB/m	dB	dBuV	dBuV/m	dBuV/m	dB		
1	5715.000	8.22	34.82	42.37	57.71	58.38	109.40	-51.02	peak
2	5725.000	8.22	34.83	42.37	58.12	58.80	122.20	-63.40	peak
3	5745.000	8.22	34.85	42.38	103.60	104.29	-----	-----	peak



Unless otherwise agreed in writing, this document is issued by the Company subject to its General Conditions of Service printed overleaf, available on request or accessible at <http://www.sgs.com/en/Terms-and-Conditions.aspx> and, for electronic format documents, subject to Terms and Conditions for Electronic Documents at <http://www.sgs.com/en/Terms-and-Conditions/Terms-e-Documents.aspx>. Attention is drawn to the limitation of liability, indemnification and jurisdiction issues defined therein. Any holder of this document is advised that information contained hereon reflects the Company's findings at the time of its intervention only and within the limits of Client's instructions, if any. The Company's sole responsibility is to its Client and this document does not exonerate parties to a transaction from exercising all their rights and obligations under the transaction documents. This document cannot be reproduced except in full, without prior written approval of the Company. Any unauthorized alteration, forgery or falsification of the content or appearance of this document is unlawful and offenders may be prosecuted to the fullest extent of the law. Unless otherwise stated the results shown in this test report refer only to the sample(s) tested and such sample(s) are retained for 30 days only.
 Attention: To check the authenticity of testing / inspection report & certificate, please contact us at telephone: (86-755) 8307 1443, or email: CN.Doccheck@sgs.com

Test Mode: 05; Polarity: Horizontal; Modulation:802.11ac; Bandwidth:20MHz; Channel:High

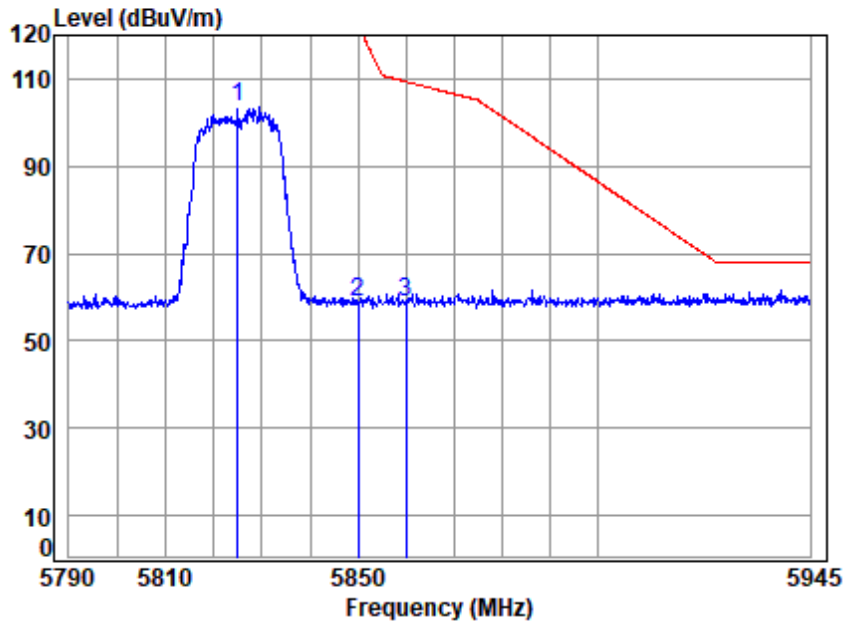

Site : chamber
 Condition: 3m HORIZONTAL
 Job No : 00028CR/00029CR
 Mode : 5825 Band edge
 : 5G WIFI 11AC20

	Freq	Cable Loss	Ant Factor	Preamp Factor	Read Level	Limit Level	Limit Line	Over Limit	Remark
	MHz	dB	dB/m	dB	dBuV	dBuV/m	dBuV/m	dB	
1	5825.000	8.23	34.93	42.38	102.60	103.38	-----	-----	peak
2	5850.000	8.24	34.95	42.39	58.15	58.95	122.20	-63.25	peak
3	5860.000	8.24	34.96	42.39	58.12	58.93	109.40	-50.47	peak



Test Mode: 05; Polarity: Vertical; Modulation:802.11ac; Bandwidth:20MHz; Channel:High

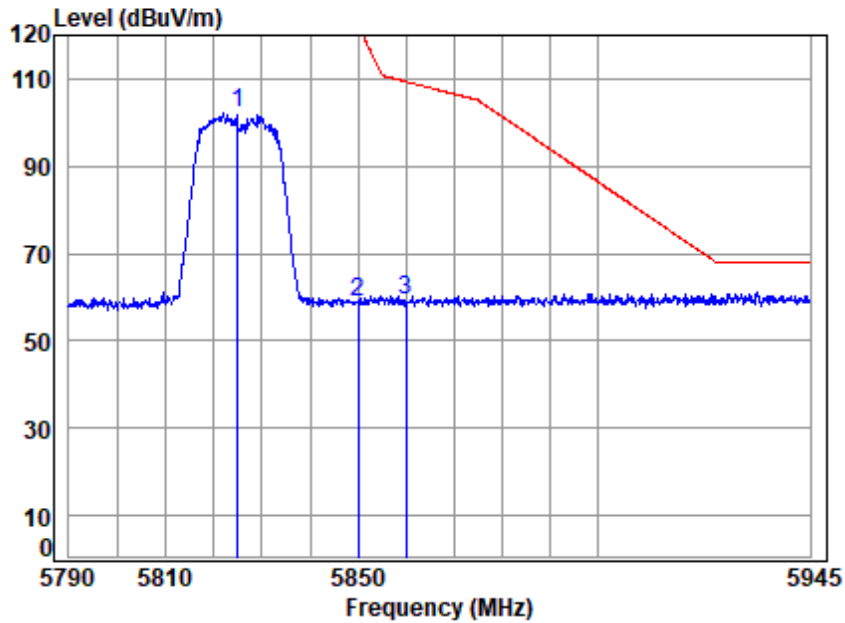

Site : chamber
 Condition: 3m VERTICAL
 Job No : 00028CR/00029CR
 Mode : 5825 Band edge
 : 5G WIFI 11AC20

	Cable	Ant	Preamp	Read	Limit	Over		
Freq	Loss	Factor	Factor	Level	Level	Line	Limit	
MHz	dB	dB/m	dB	dBuV	dBuV/m	dBuV/m	dB	
1 5825.000	8.23	34.93	42.38	101.31	102.09	-----	-----	peak
2 5850.000	8.24	34.95	42.39	58.17	58.97	122.20	-63.23	peak
3 5860.000	8.24	34.96	42.39	58.64	59.45	109.40	-49.95	peak



Test Mode: 05; Polarity: Horizontal; Modulation:802.11ac; Bandwidth:40MHz; Channel:Low

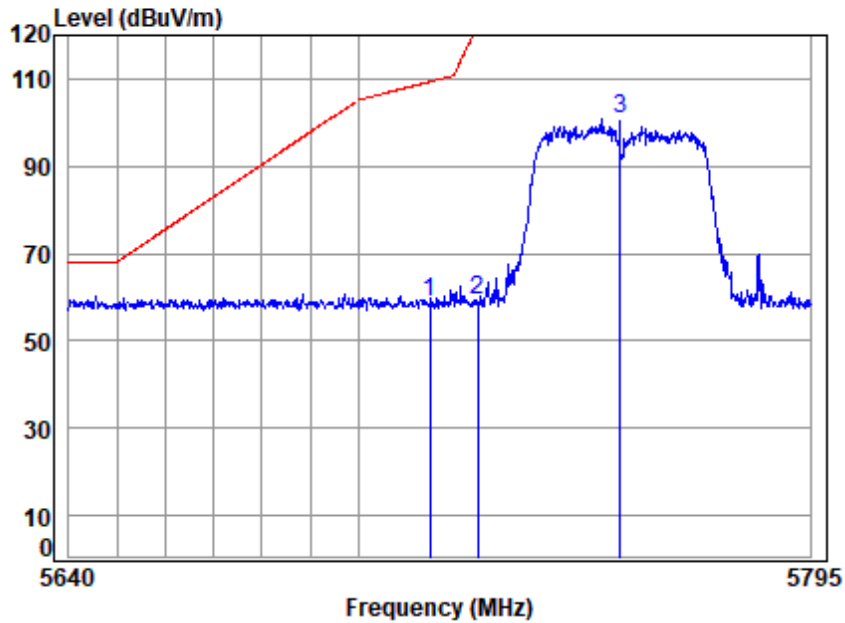

Site : chamber
 Condition: 3m HORIZONTAL
 Job No : 00028CR/00029CR
 Mode : 5755 Band edge
 : 5G WIFI 11AC40

	Freq	Cable Loss	Ant Factor	Preamp Factor	Read Level	Limit Level	Over Limit	Remark
	MHz	dB	dB/m	dB	dBuV	dBuV/m	dBuV/m	dB
1	5715.000	8.22	34.82	42.37	58.02	58.69	109.40	-50.71 peak
2	5725.000	8.22	34.83	42.37	58.83	59.51	122.20	-62.69 peak
3	5755.000	8.22	34.86	42.38	100.33	101.03	-----	----- peak



Test Mode: 05; Polarity: Vertical; Modulation:802.11ac; Bandwidth:40MHz; Channel:Low

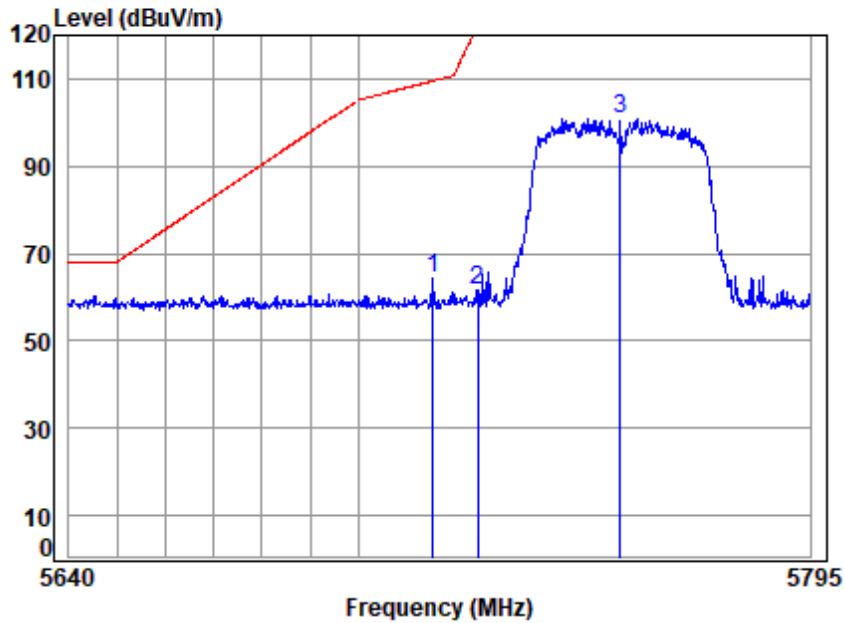

Site : chamber
 Condition: 3m VERTICAL
 Job No : 00028CR/00029CR
 Mode : 5755 Band edge
 : 5G WIFI 11AC40

	Cable	Ant	Preamp	Read	Limit	Over	
Freq	Loss	Factor	Factor	Level	Level	Line	Limit Remark
MHz	dB	dB/m	dB	dBuV	dBuV/m	dBuV/m	dB
1	5715.580	8.22	34.82	42.37	63.84	64.51	109.56 -45.05 Peak
2	5725.000	8.22	34.83	42.37	60.98	61.66	122.20 -60.54 peak
3	5755.000	8.22	34.86	42.38	100.06	100.76	----- -60.54 peak



Unless otherwise agreed in writing, this document is issued by the Company subject to its General Conditions of Service printed overleaf, available on request or accessible at <http://www.sgs.com/en/Terms-and-Conditions.aspx> and, for electronic format documents, subject to Terms and Conditions for Electronic Documents at <http://www.sgs.com/en/Terms-and-Conditions/Terms-e-Documents.aspx>. Attention is drawn to the limitation of liability, indemnification and jurisdiction issues defined therein. Any holder of this document is advised that information contained hereon reflects the Company's findings at the time of its intervention only and within the limits of Client's instructions, if any. The Company's sole responsibility is to its Client and this document does not exonerate parties to a transaction from exercising all their rights and obligations under the transaction documents. This document cannot be reproduced except in full, without prior written approval of the Company. Any unauthorized alteration, forgery or falsification of the content or appearance of this document is unlawful and offenders may be prosecuted to the fullest extent of the law. Unless otherwise stated the results shown in this test report refer only to the sample(s) tested and such sample(s) are retained for 30 days only.
 Attention: To check the authenticity of testing / inspection report & certificate, please contact us at telephone: (86-755) 8307 1443, or email: CN.Doccheck@sgs.com

Test Mode: 05; Polarity: Horizontal; Modulation:802.11ac; Bandwidth:40MHz; Channel:High

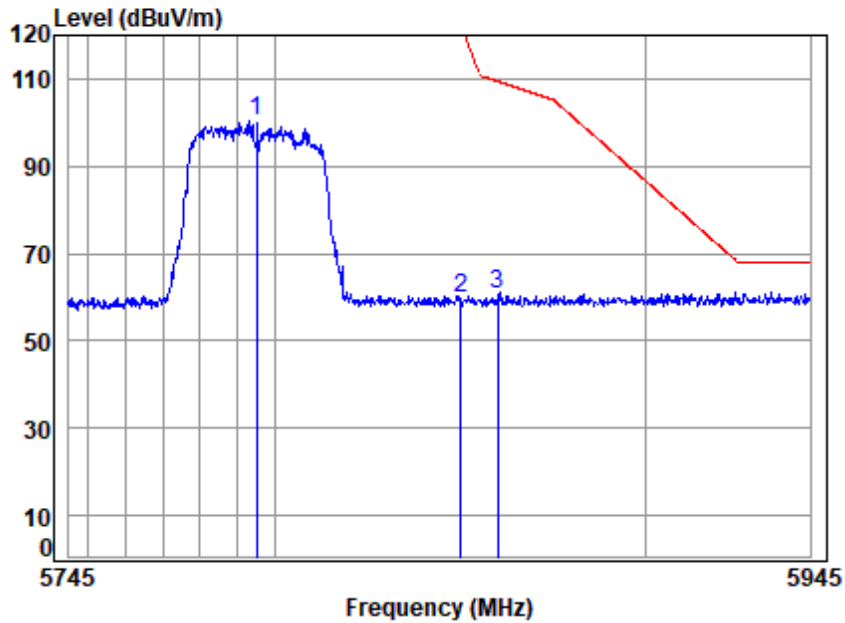

Site : chamber
 Condition: 3m HORIZONTAL
 Job No : 00028CR/00029CR
 Mode : 5795 Band edge
 : 5G WIFI 11AC40

	Cable	Ant	Preamp	Read	Limit	Over		
Freq	Loss	Factor	Factor	Level	Level	Line	Limit	Remark
MHz	dB	dB/m	dB	dBuV	dBuV/m	dBuV/m	dB	
1 5795.000	8.23	34.90	42.38	99.52	100.27	-----	-----	peak
2 5850.000	8.24	34.95	42.39	59.16	59.96	122.20	-62.24	peak
3 5860.000	8.24	34.96	42.39	59.76	60.57	109.40	-48.83	peak



Unless otherwise agreed in writing, this document is issued by the Company subject to its General Conditions of Service printed overleaf, available on request or accessible at <http://www.sgs.com/en/Terms-and-Conditions.aspx> and, for electronic format documents, subject to Terms and Conditions for Electronic Documents at <http://www.sgs.com/en/Terms-and-Conditions/Terms-e-Documents.aspx>. Attention is drawn to the limitation of liability, indemnification and jurisdiction issues defined therein. Any holder of this document is advised that information contained hereon reflects the Company's findings at the time of its intervention only and within the limits of Client's instructions, if any. The Company's sole responsibility is to its Client and this document does not exonerate parties to a transaction from exercising all their rights and obligations under the transaction documents. This document cannot be reproduced except in full, without prior written approval of the Company. Any unauthorized alteration, forgery or falsification of the content or appearance of this document is unlawful and offenders may be prosecuted to the fullest extent of the law. Unless otherwise stated the results shown in this test report refer only to the sample(s) tested and such sample(s) are retained for 30 days only.
 Attention: To check the authenticity of testing / inspection report & certificate, please contact us at telephone: (86-755) 8307 1443, or email: CN.Doccheck@sgs.com

Test Mode: 05; Polarity: Vertical; Modulation:802.11ac; Bandwidth:40MHz; Channel:High

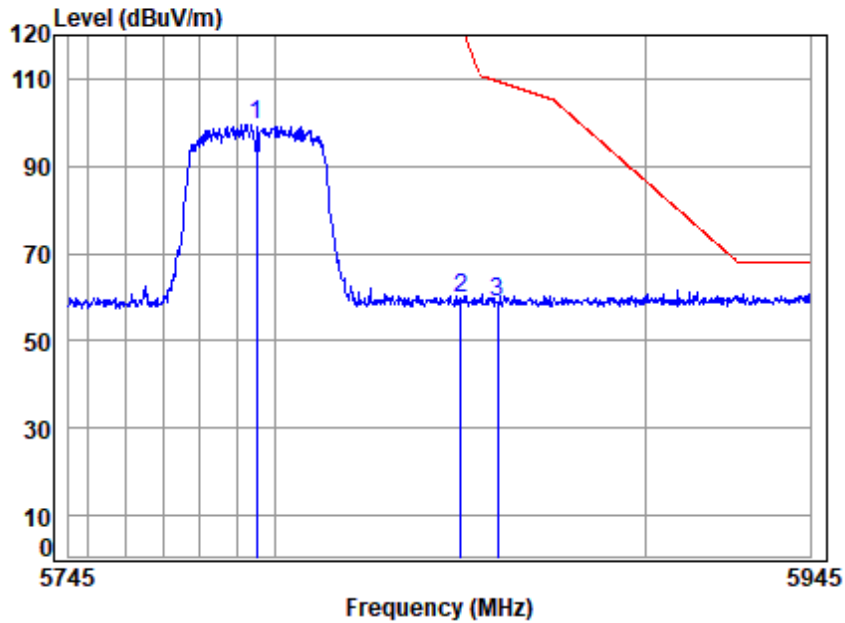

Site : chamber
 Condition: 3m VERTICAL
 Job No : 00028CR/00029CR
 Mode : 5795 Band edge
 : 5G WIFI 11AC40

	Cable	Ant	Preamp	Read	Limit	Over		
Freq	Loss	Factor	Factor	Level	Level	Line	Limit	Remark
MHz	dB	dB/m	dB	dBuV	dBuV/m	dBuV/m	dB	
1 5795.000	8.23	34.90	42.38	98.70	99.45	-----	-----	peak
2 5850.000	8.24	34.95	42.39	59.06	59.86	122.20	-62.34	peak
3 5860.000	8.24	34.96	42.39	58.22	59.03	109.40	-50.37	peak



Test Mode: 05; Polarity: Horizontal; Modulation:802.11ac; Bandwidth:80MHz; Channel:middle

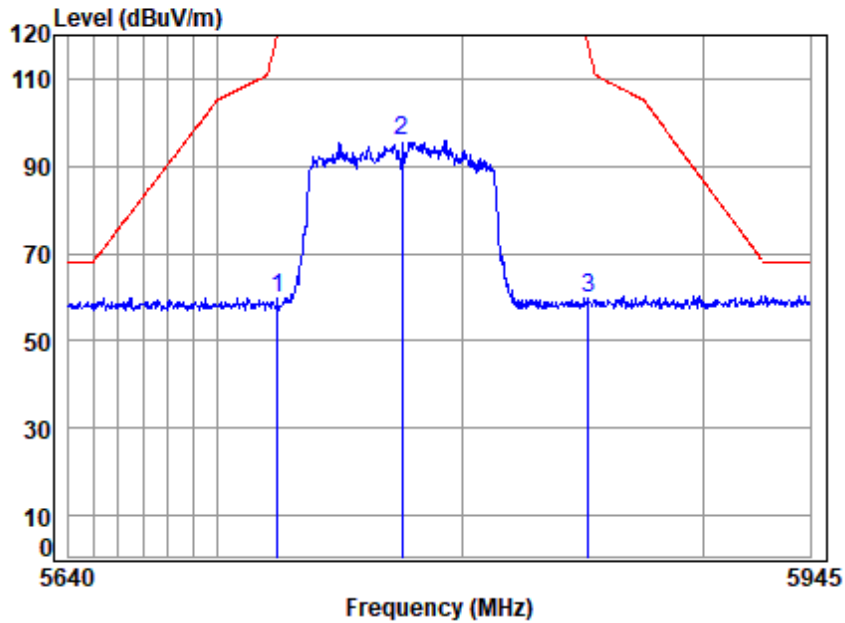

Site : chamber
 Condition: 3m HORIZONTAL
 Job No : 00028CR/00029CR
 Mode : 5775 Band edge
 : 5G WIFI 11AC80

	Freq	Cable Loss	Ant Factor	Preamp Factor	Read Level	Limit Level	Limit Line	Over Limit	Remark
	MHz	dB	dB/m	dB	dBuV	dBuV/m	dBuV/m	dB	
1	5724.088	8.22	34.83	42.37	59.09	59.77	120.12	-60.35	peak
2	5775.000	8.22	34.88	42.38	94.93	95.65	-----	-----	peak
3	5852.116	8.24	34.96	42.39	58.81	59.62	117.37	-57.75	peak



Unless otherwise agreed in writing, this document is issued by the Company subject to its General Conditions of Service printed overleaf, available on request or accessible at <http://www.sgs.com/en/Terms-and-Conditions.aspx> and, for electronic format documents, subject to Terms and Conditions for Electronic Documents at <http://www.sgs.com/en/Terms-and-Conditions/Terms-e-Documents.aspx>. Attention is drawn to the limitation of liability, indemnification and jurisdiction issues defined therein. Any holder of this document is advised that information contained hereon reflects the Company's findings at the time of its intervention only and within the limits of Client's instructions, if any. The Company's sole responsibility is to its Client and this document does not exonerate parties to a transaction from exercising all their rights and obligations under the transaction documents. This document cannot be reproduced except in full, without prior written approval of the Company. Any unauthorized alteration, forgery or falsification of the content or appearance of this document is unlawful and offenders may be prosecuted to the fullest extent of the law. Unless otherwise stated the results shown in this test report refer only to the sample(s) tested and such sample(s) are retained for 30 days only.
 Attention: To check the authenticity of testing /inspection report & certificate, please contact us at telephone: (86-755) 8307 1443, or email: CN.Doccheck@sgs.com

Test Mode: 05; Polarity: Vertical; Modulation:802.11ac; Bandwidth:80MHz; Channel:middle

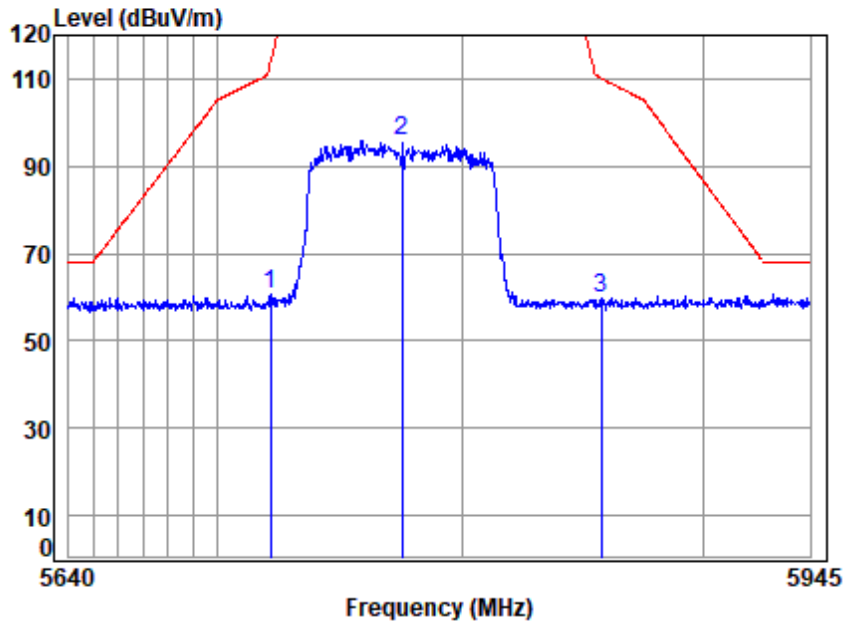

Site : chamber
 Condition: 3m VERTICAL
 Job No : 00028CR/00029CR
 Mode : 5775 Band edge
 : 5G WIFI 11AC80

	Cable	Ant	Preamp	Read	Limit	Over	
Freq	Loss	Factor	Factor	Level	Level	Line	Limit Remark
MHz	dB	dB/m	dB	dBuV	dBuV/m	dBuV/m	dB
1	5721.376	8.22	34.83	42.37	60.06	60.74	113.94 -53.20 peak
2	5775.000	8.22	34.88	42.38	95.26	95.98	----- peak
3	5857.357	8.24	34.96	42.39	58.86	59.67	110.14 -50.47 peak



Unless otherwise agreed in writing, this document is issued by the Company subject to its General Conditions of Service printed overleaf, available on request or accessible at <http://www.sgs.com/en/Terms-and-Conditions.aspx> and, for electronic format documents, subject to Terms and Conditions for Electronic Documents at <http://www.sgs.com/en/Terms-and-Conditions/Terms-e-Documents.aspx>. Attention is drawn to the limitation of liability, indemnification and jurisdiction issues defined therein. Any holder of this document is advised that information contained hereon reflects the Company's findings at the time of its intervention only and within the limits of Client's instructions, if any. The Company's sole responsibility is to its Client and this document does not exonerate parties to a transaction from exercising all their rights and obligations under the transaction documents. This document cannot be reproduced except in full, without prior written approval of the Company. Any unauthorized alteration, forgery or falsification of the content or appearance of this document is unlawful and offenders may be prosecuted to the fullest extent of the law. Unless otherwise stated the results shown in this test report refer only to the sample(s) tested and such sample(s) are retained for 30 days only.
 Attention: To check the authenticity of testing / inspection report & certificate, please contact us at telephone: (86-755) 8307 1443, or email: CN.Doccheck@sgs.com

7.10 Frequency Stability

Test Requirement 47 CFR Part 15, Subpart C 15.407 (g)
 Test Method: ANSI C63.10 (2013) Section 6.8

7.10.1 E.U.T. Operation

Operating Environment:
 Temperature: 24.6 °C Humidity: 41.0 % RH Atmospheric Pressure: 1010 mbar

7.10.2 Test Mode Description

Pre-scan / Final test	Mode Code	Description
Final test	02	TX mode (U-NII-1)_Keep the EUT in continuously transmitting mode with all modulation types. All data rates for each modulation type have been tested and found the data rate @ 6Mbps is the worst case of IEEE 802.11a; data rate @ MCS0 is the worst case of IEEE 802.11n(HT20); data rate @ MCS0 is the worst case of IEEE 802.11n(HT40); data rate @ MCS0 is the worst case of IEEE 802.11ac(VHT20); data rate @ MCS0 is the worst case of IEEE 802.11ac(VHT40); data rate @ MCS0 is the worst case of IEEE 802.11ac(VHT80). Only the data of worst case is recorded in the report.
Final test	03	TX mode (U-NII-2A)_Keep the EUT in continuously transmitting mode with all modulation types.All data rates for each modulation type have been tested and found the data rate @ 6Mbps is the worst case of IEEE 802.11a; data rate @ MCS0 is the worst case of IEEE 802.11n(HT20); data rate @ MCS0 is the worst case of IEEE 802.11n(HT40); data rate @ MCS0 is the worst case of IEEE 802.11ac(VHT20); data rate @ MCS0 is the worst case of IEEE 802.11ac(VHT40); data rate @ MCS0 is the worst case of IEEE 802.11ac(VHT80). Only the data of worst case is recorded in the report.
Final test	04	TX mode (U-NII-2C)_Keep the EUT in continuously transmitting mode with all modulation types.All data rates for each modulation type have been tested and found the data rate @ 6Mbps is the worst case of IEEE 802.11a; data rate @ MCS0 is the worst case of IEEE 802.11n(HT20); data rate @ MCS0 is the worst case of IEEE 802.11n(HT40); data rate @ MCS0 is the worst case of IEEE 802.11ac(VHT20); data rate @ MCS0 is the worst case of IEEE 802.11ac(VHT40); data rate @ MCS0 is the worst case of IEEE 802.11ac(VHT80). Only the data of worst case is recorded in the report.
Final test	05	TX mode (U-NII-3)_Keep the EUT in continuously transmitting mode with all modulation types.All data rates for each modulation type have been tested and found the data rate @ 6Mbps is the worst case of IEEE 802.11a; data rate @ MCS0 is the worst case of IEEE 802.11n(HT20); data rate @ MCS0 is the worst case of IEEE 802.11n(HT40); data rate @ MCS0 is the worst case of IEEE 802.11ac(VHT20); data rate @ MCS0 is the worst case of IEEE 802.11ac(VHT40); data rate @ MCS0 is the worst case of IEEE 802.11ac(VHT80). Only the data of worst case is recorded in the report.



Unless otherwise agreed in writing, this document is issued by the Company subject to its General Conditions of Service printed overleaf, available on request or accessible at <http://www.sgs.com/en/Terms-and-Conditions.aspx> and, for electronic format documents, subject to Terms and Conditions for Electronic Documents at <http://www.sgs.com/en/Terms-and-Conditions/Terms-e-Documents.aspx>. Attention is drawn to the limitation of liability, indemnification and jurisdiction issues defined therein. Any holder of this document is advised that information contained hereon reflects the Company's findings at the time of its intervention only and within the limits of Client's instructions, if any. The Company's sole responsibility is to its Client and this document does not exonerate parties to a transaction from exercising all their rights and obligations under the transaction documents. This document cannot be reproduced except in full, without prior written approval of the Company. Any unauthorized alteration, forgery or falsification of the content or appearance of this document is unlawful and offenders may be prosecuted to the fullest extent of the law. Unless otherwise stated the results shown in this test report refer only to the sample(s) tested and such sample(s) are retained for 30 days only.
 Attention: To check the authenticity of testing / inspection report & certificate, please contact us at telephone: (86-755) 8307 1443, or email: CN_Doccheck@sgs.com
 No.1 Workshop, M-10, Middle Section, Science & Technology Park, Shenzhen, China 518057 t (86-755) 26012053 f (86-755) 26710594 www.sgsgroup.com.cn
 中国·深圳·科技园中区M-10栋一号厂房 邮编: 518057 t (86-755) 26012053 f (86-755) 26710594 sgs.china@sgs.com

7.10.3 Test Setup Diagram

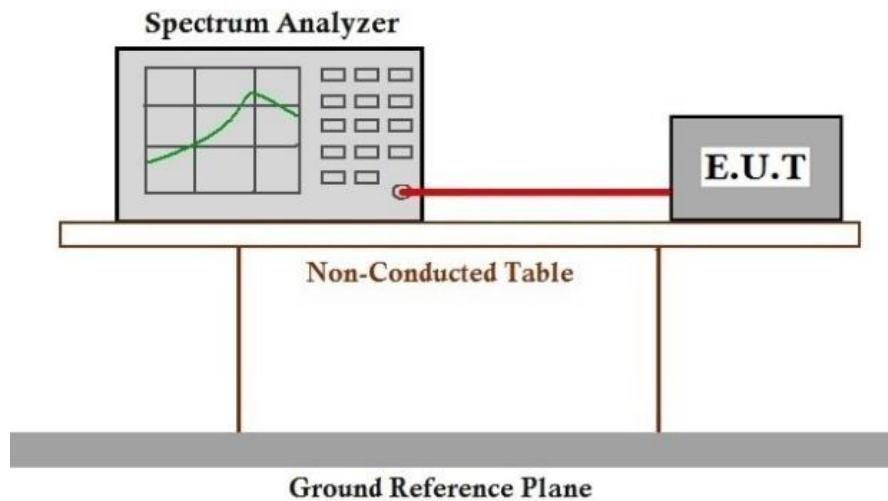

7.10.4 Measurement Procedure and Data

The applicant declares that the emissions are maintained within the band of operation under all conditions of normal operation as specified in the user's manual and meets Section 15.407(g) requirements.



7.11 Non-occupancy period

Test Requirement KDB 905462 D02 Section 5.1
 Test Method: KDB 905462 D02 Section 7.8.3
 Limit:

Test item	Limit	Applicability	
		Master Device or client with Radar Detection	Client without Radar Detection
Non-occupancy period	Minimum 30 minutes	Yes	Not required
Channel Availability Check Time	60 seconds	Yes	Not required
Channel Move Time	10 seconds See Note 1.	Yes	Yes
Channel Closing Transmission Time	200 milliseconds + an aggregate of 60 milliseconds over remaining 10 second period. See Notes 1 and 2.	Yes	Yes
U-NII Detection Bandwidth	Minimum 100% of the U-NII 99% transmission power bandwidth. See Note 3.	Yes	Not required

Note 1: Channel Move Time and the Channel Closing Transmission Time should be performed with Radar Type 0. The measurement timing begins at the end of the Radar Type 0 burst.

Note 2: The Channel Closing Transmission Time is comprised of 200 milliseconds starting at the beginning of the Channel Move Time plus any additional intermittent control signals required to facilitate a Channel move (an aggregate of 60 milliseconds) during the remainder of the 10 second period. The aggregate duration of control signals will not count quiet periods in between transmissions.

Note 3: During the U-NII Detection Bandwidth detection test, radar type 0 should be used. For each frequency step the minimum percentage of detection is 90 percent. Measurements are performed with no data traffic.

7.11.1 E.U.T. Operation

Operating Environment:

Temperature: 20.7 °C Humidity: 44.5 % RH Atmospheric Pressure: 1010 mbar



Unless otherwise agreed in writing, this document is issued by the Company subject to its General Conditions of Service printed overleaf, available on request or accessible at <http://www.sgs.com/en/Terms-and-Conditions.aspx> and, for electronic format documents, subject to Terms and Conditions for Electronic Documents at <http://www.sgs.com/en/Terms-and-Conditions/Terms-e-Documents.aspx>. Attention is drawn to the limitation of liability, indemnification and jurisdiction issues defined therein. Any holder of this document is advised that information contained hereon reflects the Company's findings at the time of its intervention only and within the limits of Client's instructions, if any. The Company's sole responsibility is to its Client and this document does not exonerate parties to a transaction from exercising all their rights and obligations under the transaction documents. This document cannot be reproduced except in full, without prior written approval of the Company. Any unauthorized alteration, forgery or falsification of the content or appearance of this document is unlawful and offenders may be prosecuted to the fullest extent of the law. Unless otherwise stated the results shown in this test report refer only to the sample(s) tested and such sample(s) are retained for 30 days only.
 Attention: To check the authenticity of testing / inspection report & certificate, please contact us at telephone: (86-755) 8307 1443, or email: CN_Doccheck@sgs.com

7.11.2 Test Setup Diagram

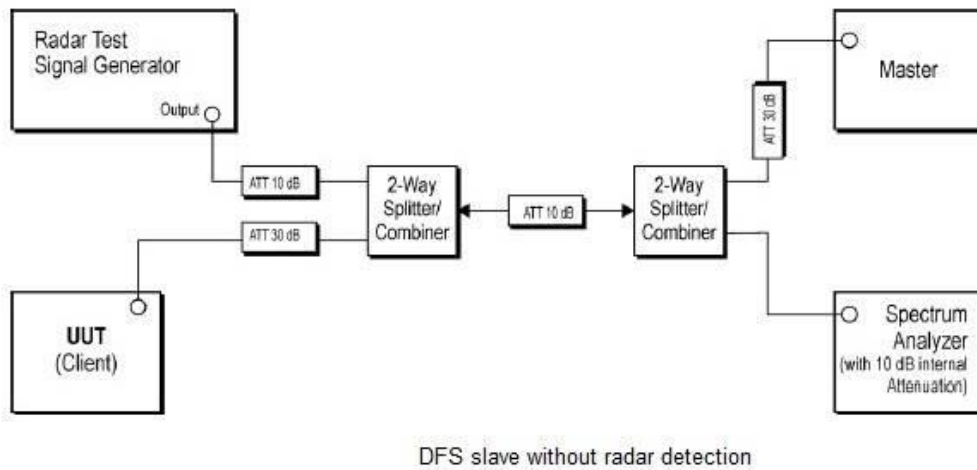
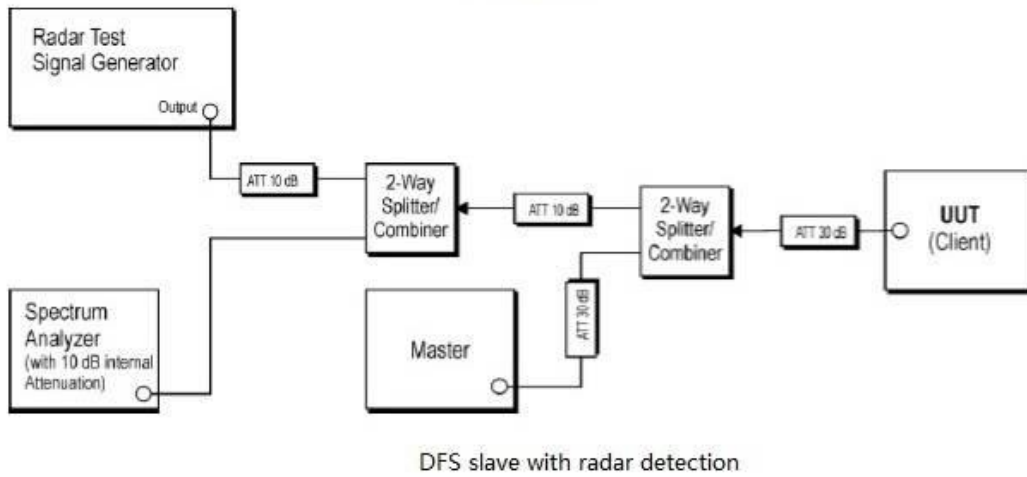
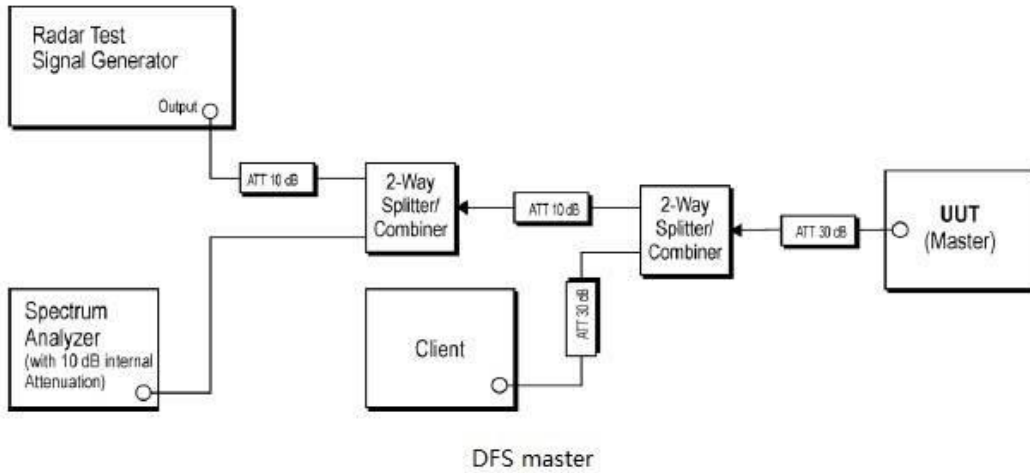

7.11.3 Measurement Procedure and Data

- 1) The radar pulse generator is setup to provide a pulse at frequency that the master and client are operating. A type 0 radar pulse with a 1us pulse width and a 1428us PRI is used for the testing.
- 2) The vector signal generator is adjusted to provide the radar burst (18 pulses) at the level of approximately -61dBm at the antenna port of the master device.
- 3) A trigger is provided from the pulse generator to the DFS monitoring system in order to capture the traffic and the occurrence of the radar pulse.
- 4) EUT will associate with the master at channel. The file "iperf.exe" specified by the FCC is streamed from the PC 2 through the master and the client device to the PC 1 and played in full motion video using Media Player Classic Ver. 6.4.8.6 in order to properly load the network for the entire period of the test.
- 5) When radar burst with a level equal to the DFS Detection Threshold +1dB is generated on the operating channel of the U-NII device. At time T0 the radar waveform generator sends a burst of pulse of the radar waveform at Detection Threshold +1dB.
- 6) Observe the transmissions of the EUT at the end of the radar Burst on the Operating Channel. Measure and record the transmissions from the UUT during the observation time (Channel Move Time). One 15 seconds plot is reported for the Short Pulse Radar Type 0. The plot for the Short Pulse Radar Types start at the end of the radar burst. The Channel Move Time will be calculated based on the zoom in 600ms plot of the Short Pulse Radar Type.
- 7) Measurement of the aggregate duration of the Channel Closed Transmission Time method. With the spectrum analyzer set to zero span tuned to the center frequency of the EUT operating channel at the radar simulated frequency, peak detection, and max hold, the dwell time per bin is given by: $Dwell (0.3ms) = S (12000ms) / B (4000)$; where Dwell is the dwell time per spectrum analyzer sampling bin, S is sweep time and B is the number of spectrum analyzer sampling bins. An upper bound of the aggregate duration of the intermittent control signals of Channel Closing Transmission Time is calculated by: $C (ms) = N \times Dwell (0.3ms)$; where C is the Closing Time, N is the number of spectrum analyzer sampling bins (intermittent control signals) showing a U-NII transmission and Dwell is the dwell time per bin.
- 8) Measurement the EUT for more than 30 minutes following the channel move time to verify that no transmission or beacons occur on this channel.

Please Refer To Appendix For Details



Unless otherwise agreed in writing, this document is issued by the Company subject to its General Conditions of Service printed overleaf, available on request or accessible at <http://www.sgs.com/en/Terms-and-Conditions.aspx> and, for electronic format documents, subject to Terms and Conditions for Electronic Documents at <http://www.sgs.com/en/Terms-and-Conditions/Terms-e-Documents.aspx>. Attention is drawn to the limitation of liability, indemnification and jurisdiction issues defined therein. Any holder of this document is advised that information contained hereon reflects the Company's findings at the time of its intervention only and within the limits of Client's instructions, if any. The Company's sole responsibility is to its Client and this document does not exonerate parties to a transaction from exercising all their rights and obligations under the transaction documents. This document cannot be reproduced except in full, without prior written approval of the Company. Any unauthorized alteration, forgery or falsification of the content or appearance of this document is unlawful and offenders may be prosecuted to the fullest extent of the law. Unless otherwise stated the results shown in this test report refer only to the sample(s) tested and such sample(s) are retained for 30 days only.
Attention: To check the authenticity of testing / inspection report & certificate, please contact us at telephone: (86-755) 8307 1443, or email: CN.Doccheck@sgs.com

7.12 Channel Move Time

Test Requirement KDB 905462 D02 Section 5.1
 Test Method: KDB 905462 D02 Section 7.8.3
 Limit:

Test item	Limit	Applicability	
		Master Device or client with Radar Detection	Client without Radar Detection
Non-occupancy period	Minimum 30 minutes	Yes	Not required
Channel Availability Check Time	60 seconds	Yes	Not required
Channel Move Time	10 seconds See Note 1.	Yes	Yes
Channel Closing Transmission Time	200 milliseconds + an aggregate of 60 milliseconds over remaining 10 second period. See Notes 1 and 2.	Yes	Yes
U-NII Detection Bandwidth	Minimum 100% of the U-NII 99% transmission power bandwidth. See Note 3.	Yes	Not required

Note 1: Channel Move Time and the Channel Closing Transmission Time should be performed with Radar Type 0. The measurement timing begins at the end of the Radar Type 0 burst.

Note 2: The Channel Closing Transmission Time is comprised of 200 milliseconds starting at the beginning of the Channel Move Time plus any additional intermittent control signals required to facilitate a Channel move (an aggregate of 60 milliseconds) during the remainder of the 10 second period. The aggregate duration of control signals will not count quiet periods in between transmissions.

Note 3: During the U-NII Detection Bandwidth detection test, radar type 0 should be used. For each frequency step the minimum percentage of detection is 90 percent. Measurements are performed with no data traffic.

7.12.1 E.U.T. Operation

Operating Environment:
 Temperature: 20.7 °C Humidity: 44.4 % RH Atmospheric Pressure: 1010 mbar



Unless otherwise agreed in writing, this document is issued by the Company subject to its General Conditions of Service printed overleaf, available on request or accessible at <http://www.sgs.com/en/Terms-and-Conditions.aspx> and, for electronic format documents, subject to Terms and Conditions for Electronic Documents at <http://www.sgs.com/en/Terms-and-Conditions/Terms-e-Documents.aspx>. Attention is drawn to the limitation of liability, indemnification and jurisdiction issues defined therein. Any holder of this document is advised that information contained hereon reflects the Company's findings at the time of its intervention only and within the limits of Client's instructions, if any. The Company's sole responsibility is to its Client and this document does not exonerate parties to a transaction from exercising all their rights and obligations under the transaction documents. This document cannot be reproduced except in full, without prior written approval of the Company. Any unauthorized alteration, forgery or falsification of the content or appearance of this document is unlawful and offenders may be prosecuted to the fullest extent of the law. Unless otherwise stated the results shown in this test report refer only to the sample(s) tested and such sample(s) are retained for 30 days only.
 Attention: To check the authenticity of testing / inspection report & certificate, please contact us at telephone: (86-755) 8307 1443, or email: CN.Doccheck@sgs.com

No.1 Workshop, M-10, Middle Section, Science & Technology Park, Shenzhen, China 518057 t (86-755) 26012053 f (86-755) 26710594 www.sgs.com.cn
 中国·深圳·科技园中区M-10栋一号厂房 邮编: 518057 t (86-755) 26012053 f (86-755) 26710594 sgs.china@sgs.com

7.12.2 Test Setup Diagram

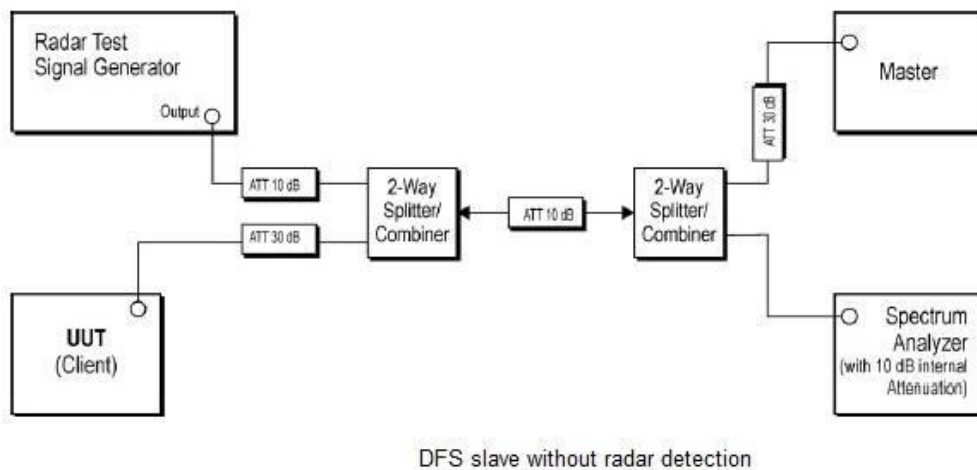
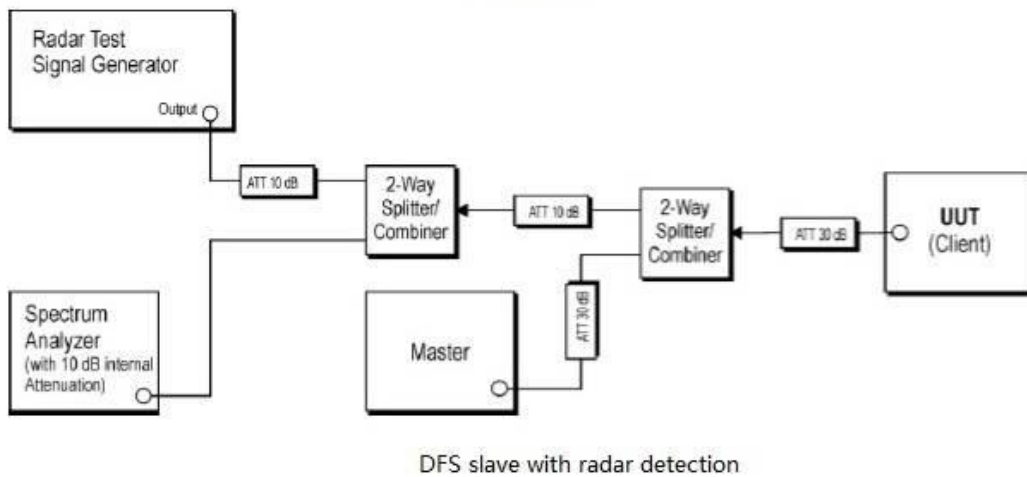
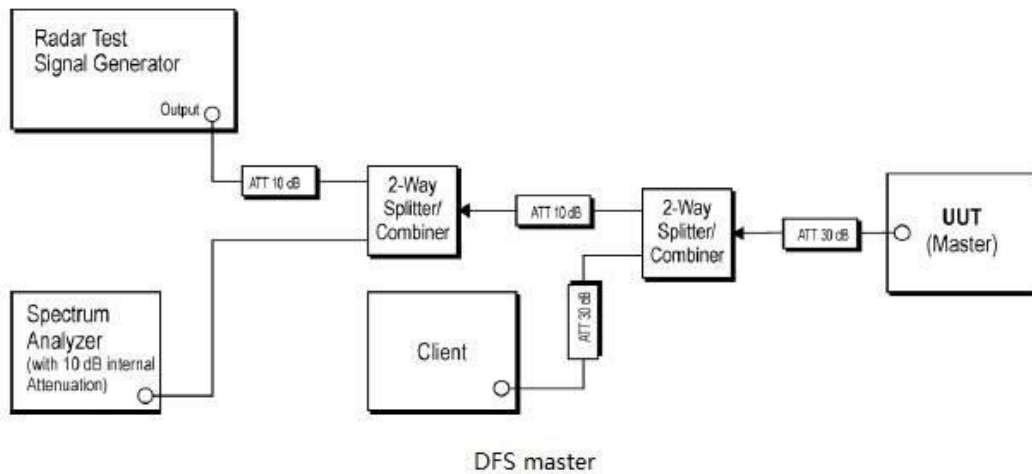

7.12.3 Measurement Procedure and Data

- 1) The radar pulse generator is setup to provide a pulse at frequency that the master and client are operating. A type 0 radar pulse with a 1us pulse width and a 1428us PRI is used for the testing.
- 2) The vector signal generator is adjusted to provide the radar burst (18 pulses) at the level of approximately -61dBm at the antenna port of the master device.
- 3) A trigger is provided from the pulse generator to the DFS monitoring system in order to capture the traffic and the occurrence of the radar pulse.
- 4) EUT will associate with the master at channel. The file "iperf.exe" specified by the FCC is streamed from the PC 2 through the master and the client device to the PC 1 and played in full motion video using Media Player Classic Ver. 6.4.8.6 in order to properly load the network for the entire period of the test.
- 5) When radar burst with a level equal to the DFS Detection Threshold +1dB is generated on the operating channel of the U-NII device. At time T0 the radar waveform generator sends a burst of pulse of the radar waveform at Detection Threshold +1dB.
- 6) Observe the transmissions of the EUT at the end of the radar Burst on the Operating Channel. Measure and record the transmissions from the UUT during the observation time (Channel Move Time). One 15 seconds plot is reported for the Short Pulse Radar Type 0. The plot for the Short Pulse Radar Types start at the end of the radar burst. The Channel Move Time will be calculated based on the zoom in 600ms plot of the Short Pulse Radar Type.
- 7) Measurement of the aggregate duration of the Channel Closed Transmission Time method. With the spectrum analyzer set to zero span tuned to the center frequency of the EUT operating channel at the radar simulated frequency, peak detection, and max hold, the dwell time per bin is given by: $Dwell (0.3ms) = S (12000ms) / B (4000)$; where Dwell is the dwell time per spectrum analyzer sampling bin, S is sweep time and B is the number of spectrum analyzer sampling bins. An upper bound of the aggregate duration of the intermittent control signals of Channel Closing Transmission Time is calculated by: $C (ms) = N \times Dwell (0.3ms)$; where C is the Closing Time, N is the number of spectrum analyzer sampling bins (intermittent control signals) showing a U-NII transmission and Dwell is the dwell time per bin.
- 8) Measurement the EUT for more than 30 minutes following the channel move time to verify that no transmission or beacons occur on this channel.

Please Refer To Appendix For Details



Unless otherwise agreed in writing, this document is issued by the Company subject to its General Conditions of Service printed overleaf, available on request or accessible at <http://www.sgs.com/en/Terms-and-Conditions.aspx> and, for electronic format documents, subject to Terms and Conditions for Electronic Documents at <http://www.sgs.com/en/Terms-and-Conditions/Terms-e-Documents.aspx>. Attention is drawn to the limitation of liability, indemnification and jurisdiction issues defined therein. Any holder of this document is advised that information contained hereon reflects the Company's findings at the time of its intervention only and within the limits of Client's instructions, if any. The Company's sole responsibility is to its Client and this document does not exonerate parties to a transaction from exercising all their rights and obligations under the transaction documents. This document cannot be reproduced except in full, without prior written approval of the Company. Any unauthorized alteration, forgery or falsification of the content or appearance of this document is unlawful and offenders may be prosecuted to the fullest extent of the law. Unless otherwise stated the results shown in this test report refer only to the sample(s) tested and such sample(s) are retained for 30 days only.
Attention: To check the authenticity of testing / inspection report & certificate, please contact us at telephone: (86-755) 8307 1443, or email: CN.Doccheck@sgs.com

7.13 Channel Closing Transmission Time

Test Requirement KDB 905462 D02 Section 5.1
 Test Method: KDB 905462 D02 Section 7.8.3
 Limit:

Test item	Limit	Applicability	
		Master Device or client with Radar Detection	Client without Radar Detection
Non-occupancy period	Minimum 30 minutes	Yes	Not required
Channel Availability Check Time	60 seconds	Yes	Not required
Channel Move Time	10 seconds See Note 1.	Yes	Yes
Channel Closing Transmission Time	200 milliseconds + an aggregate of 60 milliseconds over remaining 10 second period. See Notes 1 and 2.	Yes	Yes
U-NII Detection Bandwidth	Minimum 100% of the U-NII 99% transmission power bandwidth. See Note 3.	Yes	Not required

Note 1: Channel Move Time and the Channel Closing Transmission Time should be performed with Radar Type 0. The measurement timing begins at the end of the Radar Type 0 burst.

Note 2: The Channel Closing Transmission Time is comprised of 200 milliseconds starting at the beginning of the Channel Move Time plus any additional intermittent control signals required to facilitate a Channel move (an aggregate of 60 milliseconds) during the remainder of the 10 second period. The aggregate duration of control signals will not count quiet periods in between transmissions.

Note 3: During the U-NII Detection Bandwidth detection test, radar type 0 should be used. For each frequency step the minimum percentage of detection is 90 percent. Measurements are performed with no data traffic.

7.13.1 E.U.T. Operation

Operating Environment:

Temperature: 20.7 °C Humidity: 44.5 % RH Atmospheric Pressure: 1010 mbar



Unless otherwise agreed in writing, this document is issued by the Company subject to its General Conditions of Service printed overleaf, available on request or accessible at <http://www.sgs.com/en/Terms-and-Conditions.aspx> and, for electronic format documents, subject to Terms and Conditions for Electronic Documents at <http://www.sgs.com/en/Terms-and-Conditions/Terms-e-Documents.aspx>. Attention is drawn to the limitation of liability, indemnification and jurisdiction issues defined therein. Any holder of this document is advised that information contained hereon reflects the Company's findings at the time of its intervention only and within the limits of Client's instructions, if any. The Company's sole responsibility is to its Client and this document does not exonerate parties to a transaction from exercising all their rights and obligations under the transaction documents. This document cannot be reproduced except in full, without prior written approval of the Company. Any unauthorized alteration, forgery or falsification of the content or appearance of this document is unlawful and offenders may be prosecuted to the fullest extent of the law. Unless otherwise stated the results shown in this test report refer only to the sample(s) tested and such sample(s) are retained for 30 days only.
 Attention: To check the authenticity of testing / inspection report & certificate, please contact us at telephone: (86-755) 8307 1443, or email: CN_Doccheck@sgs.com

7.13.2 Test Setup Diagram

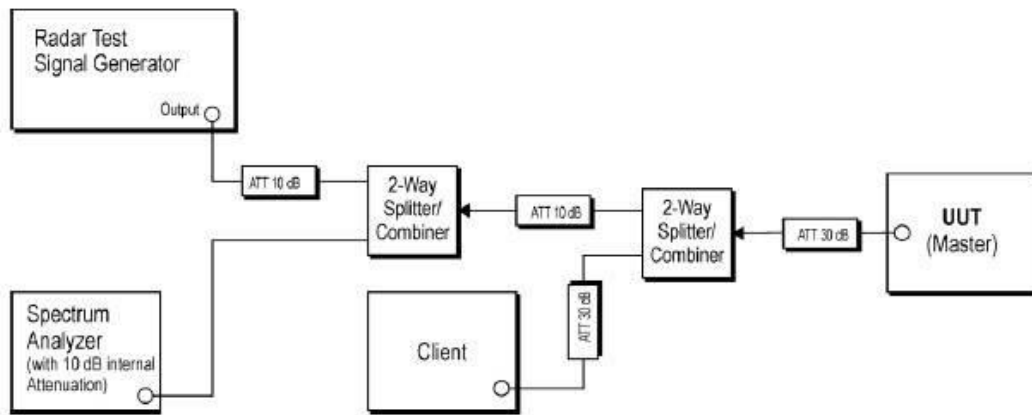

DFS master

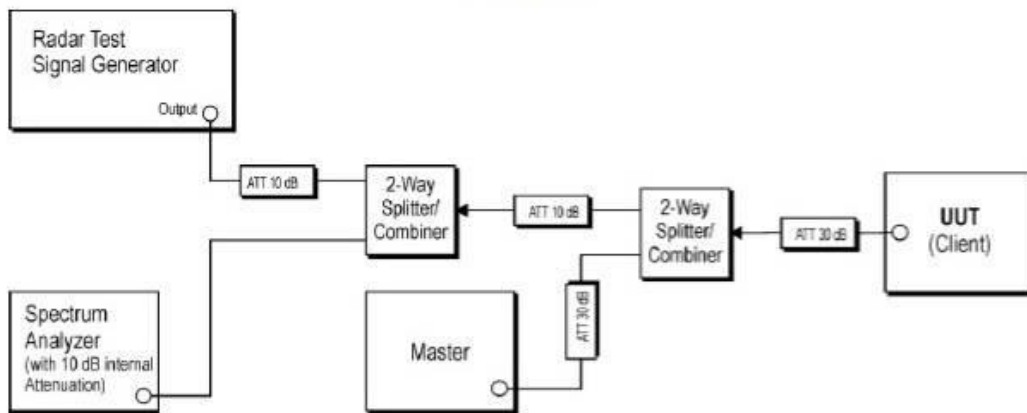

DFS slave with radar detection

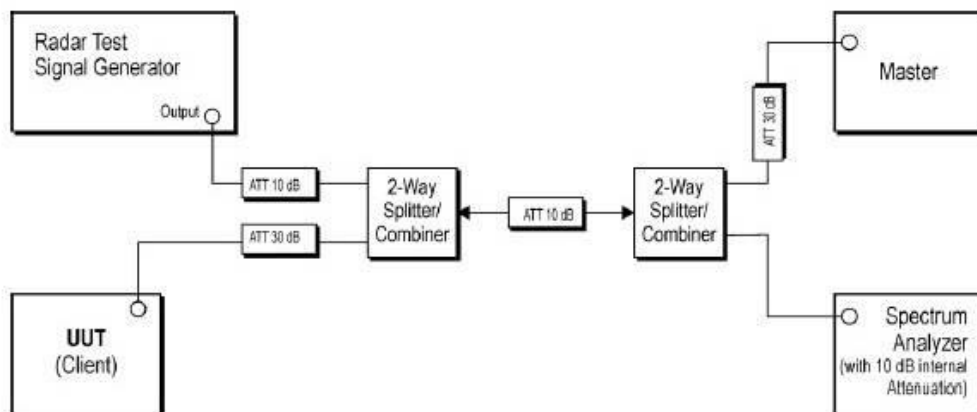

DFS slave without radar detection



7.13.3 Measurement Procedure and Data

- 1) The radar pulse generator is setup to provide a pulse at frequency that the master and client are operating. A type 0 radar pulse with a 1us pulse width and a 1428us PRI is used for the testing.
- 2) The vector signal generator is adjusted to provide the radar burst (18 pulses) at the level of approximately -61dBm at the antenna port of the master device.
- 3) A trigger is provided from the pulse generator to the DFS monitoring system in order to capture the traffic and the occurrence of the radar pulse.
- 4) EUT will associate with the master at channel. The file "iperf.exe" specified by the FCC is streamed from the PC 2 through the master and the client device to the PC 1 and played in full motion video using Media Player Classic Ver. 6.4.8.6 in order to properly load the network for the entire period of the test.
- 5) When radar burst with a level equal to the DFS Detection Threshold +1dB is generated on the operating channel of the U-NII device. At time T0 the radar waveform generator sends a burst of pulse of the radar waveform at Detection Threshold +1dB.
- 6) Observe the transmissions of the EUT at the end of the radar Burst on the Operating Channel. Measure and record the transmissions from the UUT during the observation time (Channel Move Time). One 15 seconds plot is reported for the Short Pulse Radar Type 0. The plot for the Short Pulse Radar Types start at the end of the radar burst. The Channel Move Time will be calculated based on the zoom in 600ms plot of the Short Pulse Radar Type.
- 7) Measurement of the aggregate duration of the Channel Closed Transmission Time method. With the spectrum analyzer set to zero span tuned to the center frequency of the EUT operating channel at the radar simulated frequency, peak detection, and max hold, the dwell time per bin is given by: $Dwell (0.3ms) = S (12000ms) / B (4000)$; where Dwell is the dwell time per spectrum analyzer sampling bin, S is sweep time and B is the number of spectrum analyzer sampling bins. An upper bound of the aggregate duration of the intermittent control signals of Channel Closing Transmission Time is calculated by: $C (ms) = N \times Dwell (0.3ms)$; where C is the Closing Time, N is the number of spectrum analyzer sampling bins (intermittent control signals) showing a U-NII transmission and Dwell is the dwell time per bin.
- 8) Measurement the EUT for more than 30 minutes following the channel move time to verify that no transmission or beacons occur on this channel.

Please Refer To Appendix For Details



Unless otherwise agreed in writing, this document is issued by the Company subject to its General Conditions of Service printed overleaf, available on request or accessible at <http://www.sgs.com/en/Terms-and-Conditions.aspx> and, for electronic format documents, subject to Terms and Conditions for Electronic Documents at <http://www.sgs.com/en/Terms-and-Conditions/Terms-e-Documents.aspx>. Attention is drawn to the limitation of liability, indemnification and jurisdiction issues defined therein. Any holder of this document is advised that information contained hereon reflects the Company's findings at the time of its intervention only and within the limits of Client's instructions, if any. The Company's sole responsibility is to its Client and this document does not exonerate parties to a transaction from exercising all their rights and obligations under the transaction documents. This document cannot be reproduced except in full, without prior written approval of the Company. Any unauthorized alteration, forgery or falsification of the content or appearance of this document is unlawful and offenders may be prosecuted to the fullest extent of the law. Unless otherwise stated the results shown in this test report refer only to the sample(s) tested and such sample(s) are retained for 30 days only.
Attention: To check the authenticity of testing / inspection report & certificate, please contact us at telephone: (86-755) 8307 1443, or email: CN.Doccheck@sgs.com

8 Test Setup Photo

Please refer to setup photos.

9 EUT Constructional Details (EUT Photos)

Please Refer to external and internal photos for details.

