



6+



Asst.M9639
N1927/N1928-0729G1

CAUTION To prevent entanglement keep hair away from wheels.

CAUTION Surfaces may become hot and cause burns if electronics get wet. Do not operate vehicle through water or snow.

Keep these instructions for future reference: as they contain important information. **IMPORTANT:** Please read all "Consumer Information" before operating your vehicle.

I. CONTENTS/FEATURES

- Vehicle
- Transmitter

Vehicle

- q ON/OFF switch
- w Battery door
- e Battery door latch
- r AA Battery adaper

Transmitter

- A Antenna
- B Battery door
- C Driving controls(left button)
- D Driving controls(right button)
- E Turbo botton

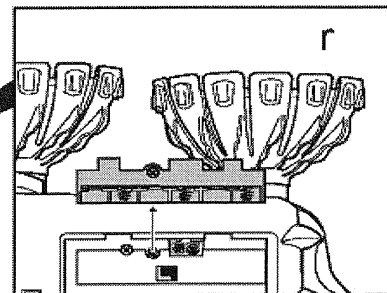
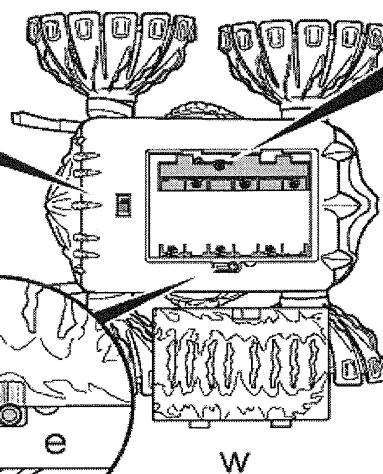
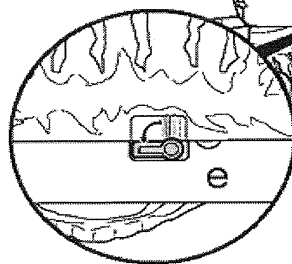
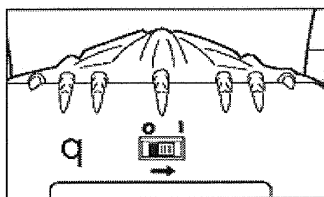
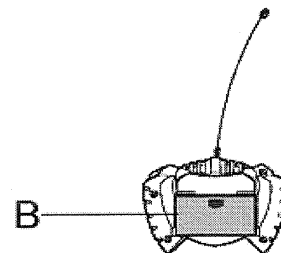
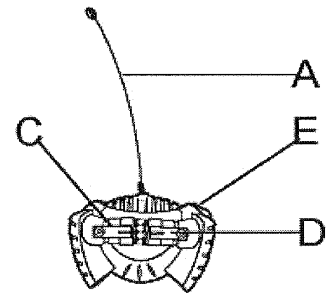
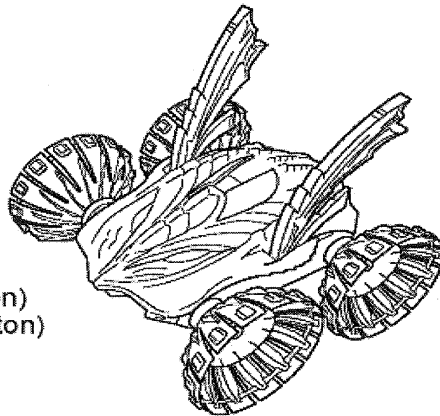

w

II. BATTERY INSTALLATION

Note: Your vehicle can be used with a Tyco® R/C 9.6V NiMH battery pack or 6 AA alkaline batteries.

Requires a Tyco® R/C 9.6V NiMH battery pack or 6 AA alkaline batteries for vehicle and 2 AA alkaline batteries for transmitter.

 Though your vehicle can run on both 9.6V or 6 x AA batteries it will run up to 30% faster when using a 9.6V rechargeable battery.

Vehicle

9.6V NiMH battery pack

1. Rotate the battery latches, as shown, to unlock the battery cover. Swing the battery cover up and away from the vehicle.
2. Use a screwdriver (not included) to unscrew and remove the AA battery adapter. Store in a safe place for later usage.
3. Insert the 9.6V NiMH battery pack (not included), with polarity (+/-) as shown inside the battery compartment.
4. Plug the wire connector into the battery compartment as shown.
5. Replace the battery cover.
6. Turn "ON" the Power Switch.

6 AA alkaline batteries

1. Rotate the battery latches, as shown, to unlock the battery cover. Swing the battery cover up and away from the vehicle.
2. Make sure the AA battery adapter is firmly in place. If it's not, position the adapter in the box and fasten it with the screw.
3. Insert the 6 AA batteries (not included), with polarity (+/-) as shown inside the battery compartment.
4. Replace the battery cover.
5. Turn "ON" the Power Switch.

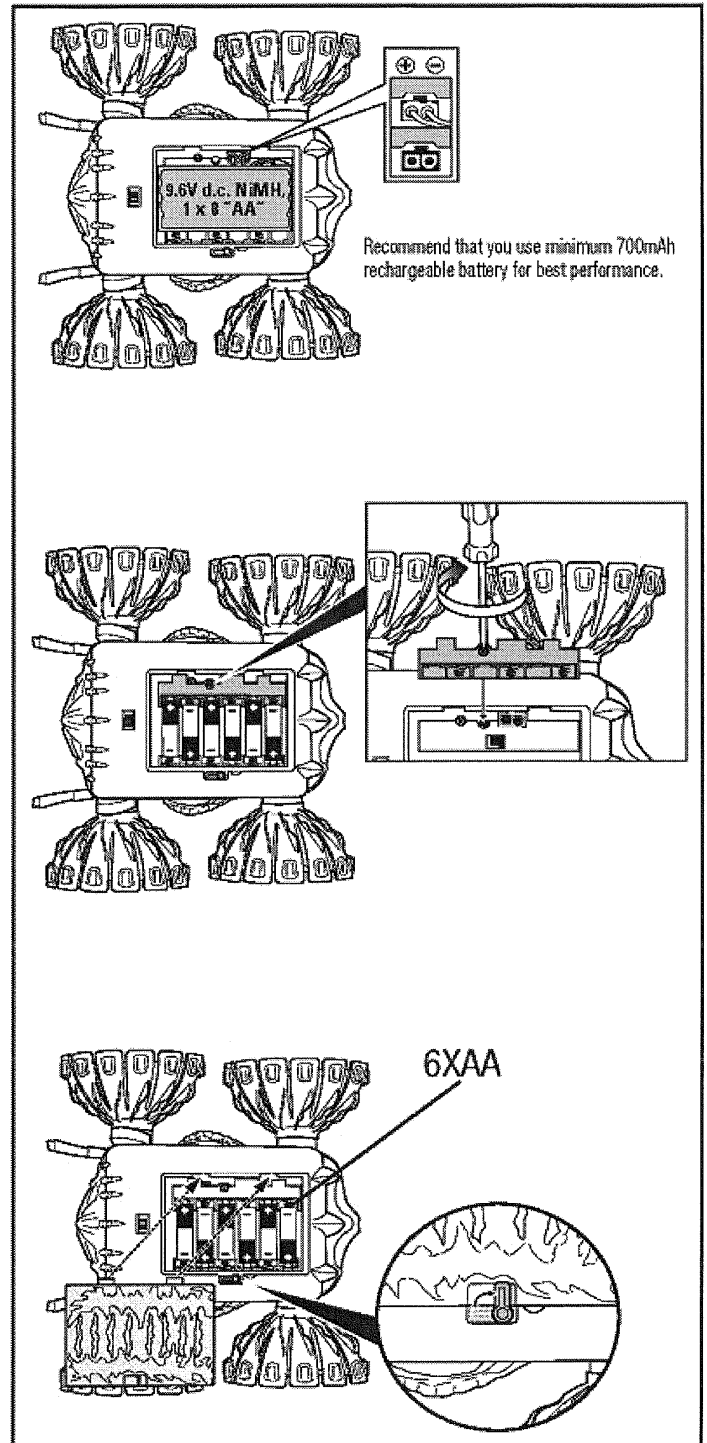

Transmitter

1. Remove the battery cover as shown.
2. Install 2 AA batteries (not included), with polarity (+/-) as shown inside the battery compartment.
3. Replace the battery cover.

 Your transmitter is equipped with a special automatic ON battery-saving feature. Just turn your vehicle ON. Then push either transmitter control to run and control your vehicle.

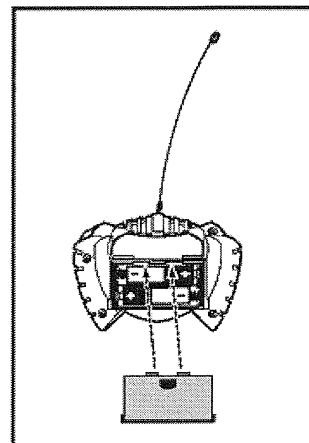

III. VEHICLE OPERATION

💡 If your vehicle doesn't move when you use the transmitter there's a good chance your vehicle's battery is ready for a recharge.

Pushing two buttons forwards makes vehicle move forwards, pushing two buttons backwards makes vehicle move backwards.

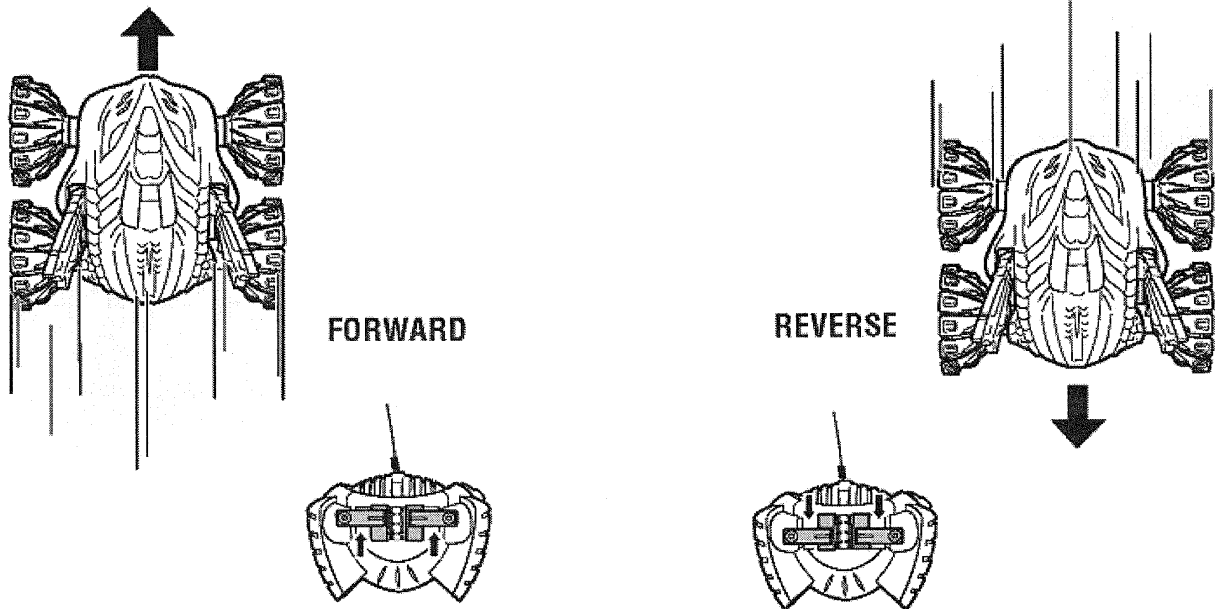

The left and right button of TX control left and right wheels of vehicle.

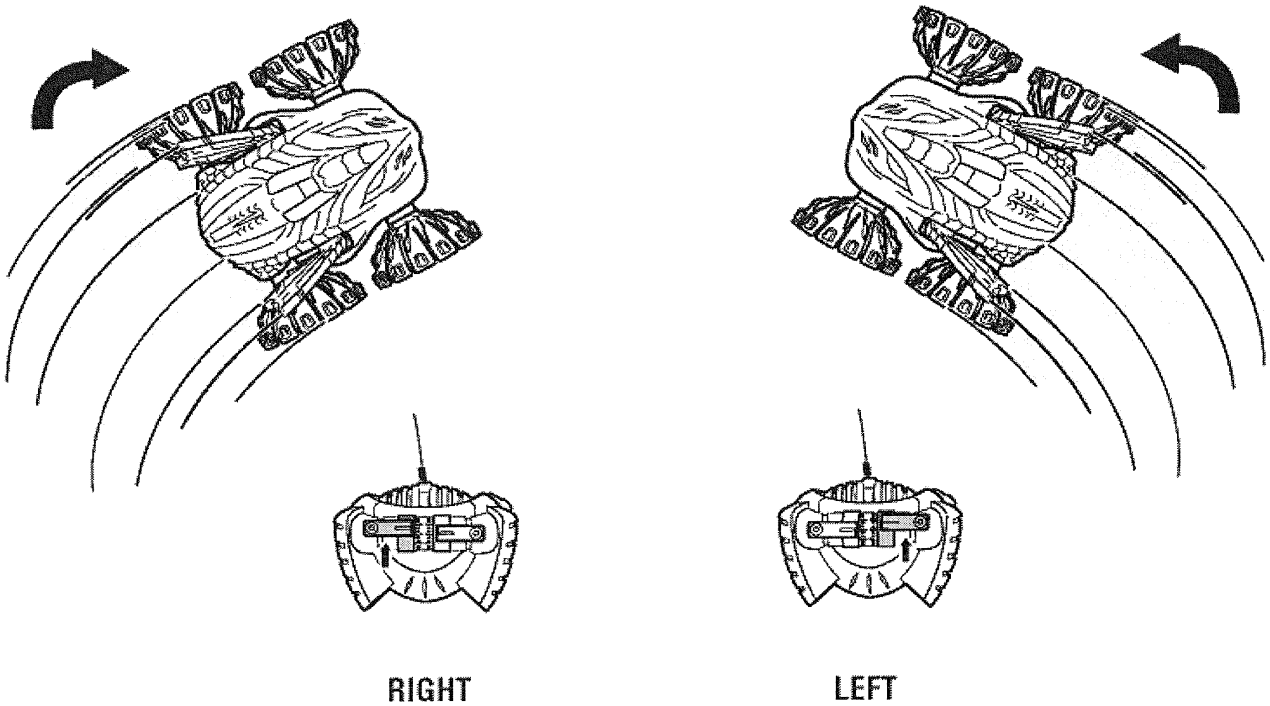

IV. CRAZY SPINS

Pushing one button forwards while pushing the other backwards makes the vehicle spin.

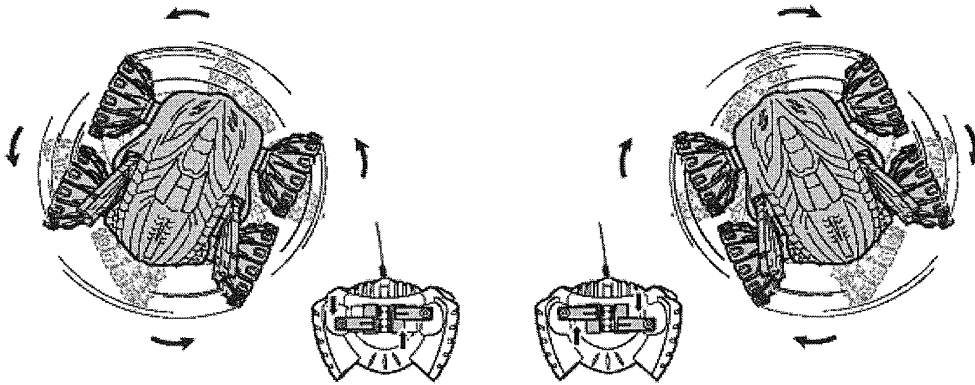

V. USING TURBO

The TURBO button allows you to boost your speed but you'll need to push both controller buttons in the same direction in order for the TURBO to be activated.

Pushing two buttons forwards or backwards and pressing turbo button at the same time can make your vehicle flip over!

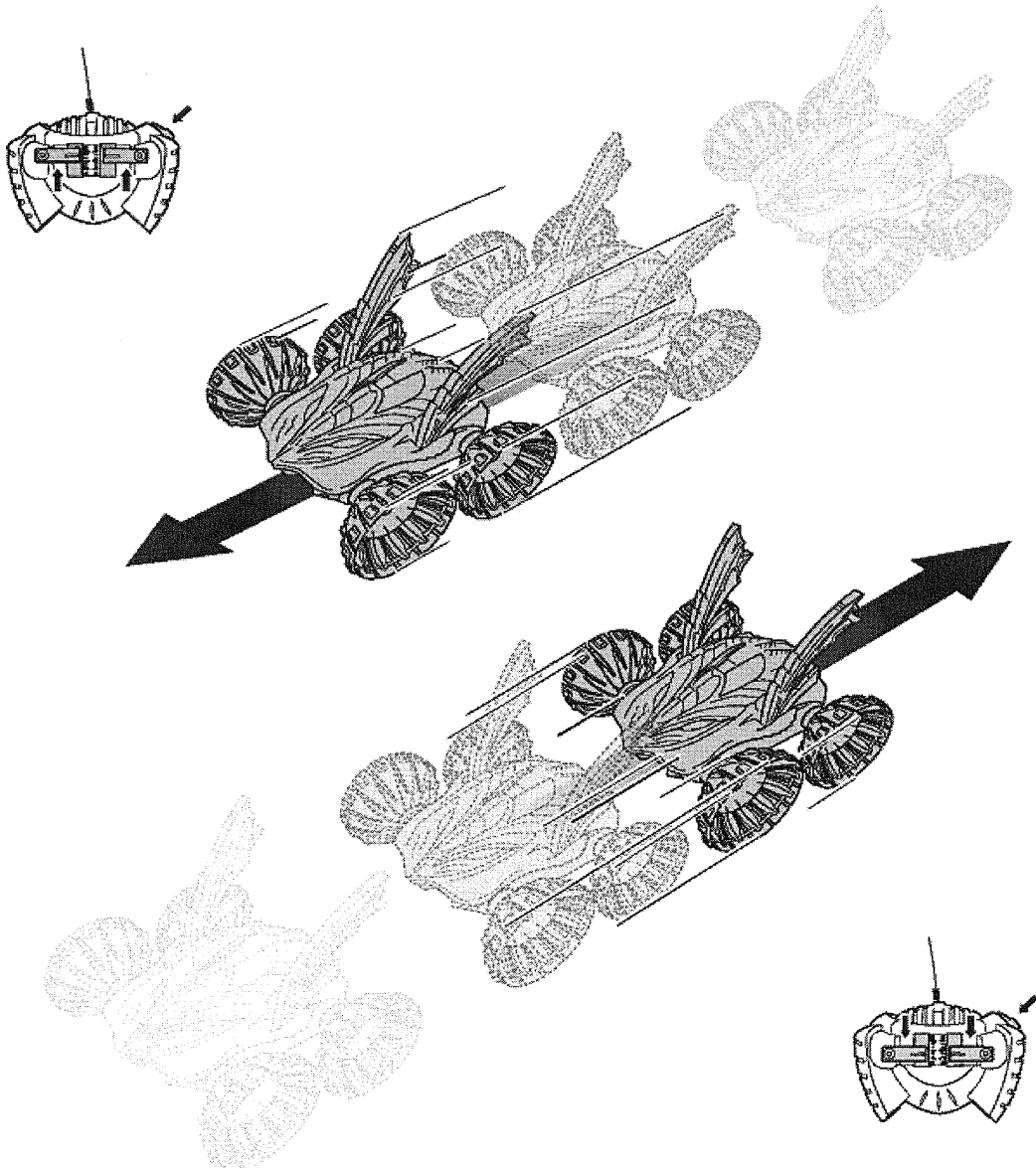

VI. QUICK TIPS

1. When your vehicle starts to lose power, it may lose functions or performance. It's time for fresh batteries (or a recharge). Your vehicle's running time may change depending on your driving style.
2. Radio interference can effect your vehicle's performance. Interference can be caused by other R/C vehicles running on the same frequency, electrical wires, large buildings or CB radios. Try to stay away from these!
3. Point your transmitter antenna up - not down toward your vehicle. If your vehicle gets too far away, it won't work properly. If your transmitter has an antenna carry-loop feature, make sure the antenna is removed from the holder and straightened before operating.
4. Don't drive your vehicle in sand or through water or snow.
5. Don't store your vehicle near heat or in direct sunlight. Always turn switches OFF and remove all batteries for storage.

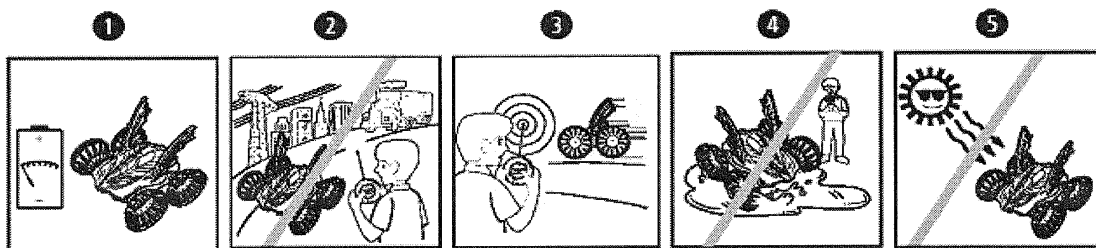

VII. BATTERY SAFETY INFORMATION

In exceptional circumstances batteries may leak fluids that can cause a chemical burn injury or ruin your product. To avoid battery leakage:

- Non-rechargeable batteries are not to be recharged.
- Rechargeable batteries are to be removed from the product before being charged (if designed to be removable).
- Rechargeable batteries are only to be charged under adult supervision (if designed to be removable).
- Do not mix alkaline, standard (carbon-zinc), or rechargeable (nickel-cadmium) batteries.
- Do not mix old and new batteries.
- Only batteries of the same or equivalent type as recommended are to be used.
- Batteries are to be inserted with the correct polarity.
- Exhausted batteries are to be removed from the product.
- The supply terminals are not to be short-circuited.
- Dispose of battery(ies) safely.
- Do not dispose of this product in a fire. The batteries inside may explode or leak.

Battery Performance Note:

For best performance use regular or high-performance alkaline batteries (where disposable batteries are called for). If your vehicle is supplied with standard (carbon-zinc) batteries for initial use and/or demonstration purposes, we recommend replacing them with alkaline batteries when necessary. Battery life may vary depending on battery brand.

ⓘ CONSUMER INFORMATION

Note to Adults: To ensure that the child's play is both safe and fun, please review all operating instructions and safety rules with your child.

Safety Tips

- NEVER drive your vehicle on streets! They're for real cars!
- DO NOT pick up the vehicle while in motion.
- Keep fingers, hair and loose clothing away from the tires and the wheel hubs while the vehicle is switched ON.
- Adult supervision is recommended when this vehicle is being operated.
- To avoid accidental operation, remove all batteries when not in use.

This device complies with Part 15 of the FCC Rules. Operation is subject to the following two conditions:

(1) This device may not cause harmful interference, and (2) this device must accept any interference received, including interference that may cause undesired operation.

This equipment has been tested and found to comply with the limits for a Class B digital device, pursuant to part 15 of the FCC rules. These limits are designed to provide reasonable protection against harmful interference in a residential installation. This equipment generates, uses and can radiate radio frequency energy and, if not installed and used in accordance with the instructions, may cause harmful interference to radio communications. However, there is no guarantee that interference will not occur in a particular installation. If this equipment does cause harmful interference to radio or television reception, which can be determined by turning the equipment off and on, the user is encouraged to try to correct the interference by one or more of the following measures:

- Reorient or relocate the receiving antenna.
- Increase the separation between the equipment and receiver.
- Connect the equipment into an outlet on a circuit different from that to which the receiver is connected.
- Consult the dealer or an experienced radio/TV technician for help.

90 DAY LIMITED WARRANTY

This product is thoroughly tested and inspected before shipment and is guaranteed to be free from factory defects in material and workmanship for a period of 90 days from the date of purchase. Mattel will repair or replace any defective part or unit free of charge during this period. This warranty is valid provided the product has been operated in accordance with the instructions and proof of purchase is furnished. This warranty does not apply to worn or defective batteries, or to items which have been damaged or abused by the consumer. This warranty gives you specific legal rights and is in addition to and does not diminish your statutory or other legal rights. **IMPORTANT:** Please return your product in its original package and keep a record of what you return.

? † AUSTRALIA: 1300 135 312



Protect the environment by not disposing of this product with household waste (2002/96/EC). Check your local authority for recycling advice and facilities.

© 2008 Mattel, Inc., 333 Continental Blvd., El Segundo, CA 90245 U.S.A. All Rights Reserved. Consumer Relations 1-888-557-8926 service.mattel.com • Mattel Canada Inc., Mississauga, Ontario L5R 3W2. Retain this address for future reference Mattel U.K. Ltd., Vanwall Business Park, Maidenhead SL6 4UB. Helpline 01628500303 • Mattel Australia Pty., Ltd., Richmond, Victoria. 3121. Consumer Advisory Service - 1300 135 312. • Mattel East Asia Ltd., Room 1106, South Tower, World Finance Centre, Harbour City, Tsimshatsui, HK, China. • Diimport & Diedarkan Oleh: Mattel SEA Ptd Ltd.(993532-P) Lot 13.5, 13th Floor, Menara Lien Hoe, Persiaran Tropicana Golf Country Resort, 47410 PJ. Tel:03-78803817, Fax:03-78803867. service.mattel.com

COMPLIANCE WITH FCC REGULATIONS (VALID IN U.S. ONLY - VALABLE AUX É.-U. SEULEMENT)

This device complies with Part 15 of the FCC Rules. Operation is subject to the following two conditions: (1) This device may not cause harmful interference, and (2) this device must accept any interference received, including interference that may cause undesired operation.

This equipment has been tested and found to comply with the limits for a Class B digital device, pursuant to part 15 of the FCC rules. These limits are designed to provide reasonable protection against harmful interference in a residential installation. This equipment generates, uses and can radiate radio frequency energy and, if not installed and used in accordance with the instructions, may cause harmful interference to radio communications. However, there is no guarantee that interference will not occur in a particular installation. If this equipment does cause harmful interference to radio or television reception, which can be determined by turning the equipment off and on, the user is encouraged to try to correct the interference by one or more of the following measures:

- Reorient or relocate the receiving antenna.
- Increase the separation between the equipment and receiver.
- Connect the equipment into an outlet on a circuit different from that to which the receiver is connected.
- Consult the dealer or an experienced radio/TV technician for help.

NOTE: Changes or modifications not expressly approved by the manufacturer responsible for compliance could void the user's authority to operate the equipment.

RSS - 310 (Canada) (VALID FOR CANADA ONLY - VALABLE AU CANADA SEULEMENT)

This Category II radiocommunication device complies with Industry Canada Standard RSS-310. Operation is subject to the following two conditions: (1) this device may not cause interference, and (2) this device must accept any interference, including interference that may cause undesired operation of the device.

Ce dispositif de radiocommunication de catégorie II respecte la norme CNR-310 d'Industrie Canada. L'utilisation de ce dispositif est autorisée seulement aux deux conditions suivantes : (1) il ne doit pas produire de brouillage, et (2) l'utilisateur du dispositif doit être prêt à accepter tout brouillage radioélectrique reçu, même si ce brouillage est susceptible de compromettre le fonctionnement du dispositif.

CNR-310 d'Industrie Canada (CANADA SEULEMENT)

Frequency Channel: 27.145MHz
Field Strength: 75.2dBmV/m @ 3m
Frequency Channel: 49.860MHz
Field Strength: 72.7dBmV/m @ 3m