



---

# FCC Part 90 Test Report

---

Report No.: AGC02X121201F2

**FCC ID** : PH3-DR138  
**PRODUCT DESIGNATION** : VHF FM MOBILE TRANSCEIVER  
**BRAND NAME** : ALINCO  
**MODEL NAME** : DR-138  
**CLIENT** : Alinco Incorporated, Electronics Division  
**DATE OF ISSUE** : Dec.17, 2012  
**STANDARD(S)** : FCC Part 90 Rules  
**REPORT VERSION** : V 1.0

Attestation of Global Compliance (Shenzhen) Co., Ltd.

**CAUTION:** This report shall not be reproduced except in full without the written permission of the test laboratory and shall not be quoted out of context.

The results shown in this test report refer only to the sample(s) tested unless otherwise stated and the sample(s) are retained for 30 days only. The document is issued by AGC, this document cannot be reproduced except in full with our prior written permission. The document is available on request and the brief information for its validation can be assessable and confirmed at <http://www.agc-cert.com/rzcx.asp>



### VERIFICATION OF COMPLIANCE

Applicant:	Alinco Incorporated, Electronics Division
	Yodoyabashi Dai-Bldg 13F, 4-4-9 Koraibashi, Chuo-Ku, Osaka 541-0043, Japan
Manufacturer:	Alinco Incorporated, Electronics Division
	Yodoyabashi Dai-Bldg 13F, 4-4-9 Koraibashi, Chuo-Ku, Osaka 541-0043, Japan
Product Designation:	VHF FM MOBILE TRANSCEIVER
Brand Name:	ALINCO
Model Name:	DR-138
Hardware Version:	V1.00
Software Version:	V1.00
Report No.:	AGC02X121201F2
Date of Test:	Dec.10, 2012 to Dec.15, 2012

### WE HEREBY CERTIFY THAT:

The above equipment was tested by Attestation of Global Compliance (Shenzhen) Co., Ltd. The data evaluation, test procedures, and equipment configurations shown in this report were made in accordance with the procedures given in ANSI C 63.4:2003. The sample tested as described in this report is in compliance with the FCC Rules Part 90 requirements

The test results of this report relate only to the tested sample identified in this report.

Tested by

Wall Huang

Dec.17, 2012

Checked By

Forrest Lei

Dec.17, 2012

Authorized By

Solger Zhang

Dec.17, 2012

The results shown in this test report refer only to the sample(s) tested unless otherwise stated and the sample(s) are retained for 30 days only. The document is issued by AGC, this document cannot be reproduced except in full with our prior written permission. The document is available on request and the brief information for its validation can be assessable and confirmed at <http://www.agc-cert.com/rzcx.asp>





## TABLE OF CONTENTS

<b>1. GENERAL INFORMATION</b>	<b>5</b>
1.1 PRODUCT DESCRIPTION	5
1.3 TEST METHODOLOGY	6
1.4 TEST FACILITY	6
1.5 SPECIAL ACCESSORIES	6
1.6 EQUIPMENT MODIFICATIONS	6
<b>2. SYSTEM TEST CONFIGURATION</b>	<b>7</b>
2.1 EUT CONFIGURATION	7
2.2 EUT EXERCISE	7
2.3 GENERAL TECHNICAL REQUIREMENTS	7
2.4 CONFIGURATION OF TESTED SYSTEM	7
<b>3. SUMMARY OF TEST RESULTS</b>	<b>8</b>
<b>4. DESCRIPTION OF TEST MODES</b>	<b>9</b>
<b>5. CONDUCTED LIMITS</b>	<b>10</b>
5.1 PROVISIONS APPLICABLE	10
5.2 MEASUREMENT PROCEDURE	10
5.3 TEST SETUP BLOCK DIAGRAM	11
5.4 TEST EQUIPMENT USED	11
5.5 TEST RESULT	12
<b>6. FREQUENCY TOLERANCE</b>	<b>13</b>
6.1 PROVISIONS APPLICABLE	13
6.2 MEASUREMENT PROCEDURE	13
6.3 TEST SETUP BLOCK DIAGRAM	14
6.4 TEST EQUIPMENT USED:	14
6.5 TEST RESULT	15
<b>7. EMISSION BANDWIDTH</b>	<b>18</b>
7.1 PROVISIONS APPLICABLE	18
7.2 MEASUREMENT PROCEDURE	18
7.3 TEST SETUP BLOCK DIAGRAM	18
7.4 MEASUREMENT EQUIPMENT USED:	18
7.5 MEASUREMENT RESULT:	19
<b>8. UNWANTED RADIATION</b>	<b>20</b>
8.1 PROVISIONS APPLICABLE	20
8.2 MEASUREMENT PROCEDURE	20

The results shown in this test report refer only to the sample(s) tested unless otherwise stated and the sample(s) are retained for 30 days only. The document is issued by AGC, this document cannot be reproduced except in full with our prior written permission. The document is available on request and the brief information for its validation can be assessable and confirmed at <http://www.agc-cert.com/rzcx.asp>



8.3 TEST SETUP BLOCK DIAGRAM ..... 21

8.4 MEASUREMENT EQUIPMENT USED: ..... 23

8.5 MEASUREMENT RESULTS: ..... 23

8.6 EMISSION MASK PLOT ..... 25

**9. MODULATION CHARACTERISTICS ..... 26**

9.1 PROVISIONS APPLICABLE ..... 26

9.2 MEASUREMENT METHOD ..... 26

9.3 MEASUREMENT INSTRUMENTS ..... 26

9.4 MEASUREMENT RESULT ..... 27

**10. MAXIMUM TRANSMITTER POWER (CONDUCTED OUTPUT POWER)..... 30**

10.1 PROVISIONS APPLICABLE ..... 30

10.2 TEST PROCEDURE ..... 30

10.3 TEST INSTRUMENTS ..... 30

10.4 TEST CONFIGURATION ..... 30

10.5 TEST RESULT ..... 30

10.6 CONDUCT SPURIOUS PLOT ..... 31

**11. TRANSMITTER FREQUENCY BEHAVIOR ..... 32**

11.1 PROVISIONS APPLICABLE ..... 32

11.2 TEST METHOD ..... 32

11.3 TEST INSTRUMENTS ..... 32

11.4 DESCRIBE LIMIT LINE OF TRANSMITTER FREQUENCY BEHAVIOR ..... 33

11.5 MEASURE RESULT ..... 35

**12. RADIATED EMISSION ON RECEIVING MODE ..... 36**

12.1 PROVISIONS APPLICABLE ..... 36

12.2 TEST METHOD ..... 36

12.3 TEST INSTRUMENTS ..... 36

12.4 MEASURE RESULT (MEASURED AT 3M USING FCC PART15 B LIMITS) ..... 37

**13. AUDIO LOW PASS FILTER RESPONSE ..... 39**

13.1 LIMITS ..... 39

13.2. METHOD OF MEASUREMENTS ..... 39

13.3 TEST DATA ..... 40

**APPENDIX I ..... 42**

**PHOTOGRAPHS OF SETUP ..... 42**

**APPENDIX II ..... 43**

**EXTERNAL VIEW OF EUT ..... 43**

The results shown in this test report refer only to the sample(s) tested unless otherwise stated and the sample(s) are retained for 30 days only. The document is issued by AGC, this document cannot be reproduced except in full with our prior written permission. The document is available on request and the brief information for its validation can be assessable and confirmed at <http://www.agc-cert.com/rzcx.asp>

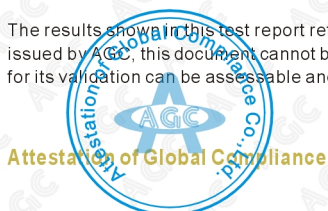





## 1. GENERAL INFORMATION

### 1.1 PRODUCT DESCRIPTION

The EUT is a VHF FM MOBILE TRANSCEIVER designed for voice communication. It is designed by way of utilizing the FM modulation achieves the system operating.

A major technical description of EUT is described as following:

Communication Type	Voice / Tone only
Modulation	FM
Emission Type	F3E
Emission Bandwidth	10.76KHz
Peak Frequency Deviation	1.84 KHz
Audio Frequency Response	10.93dB
Maximum Transmitter Power	47.75dBm(Max)
Output power Modification	60W (It was fixed by the manufacturer, any individual can't arbitrarily change it)
Antenna Designation	Detachable
Power Supply	DC 13.8V by DC source
Limiting Voltage	DC 11.73V
Operation Frequency Range and Channel	Frequency Range: 136.000MHz to 173.9975MHz Channel Separation: 12.5KHz
	Top Channel: 173.9975MHz, Centre Channel: 155.025MHz, Bottom Channel:136.000MHz,
Frequency Tolerance	0.652ppm for 12.5 KHz Channel Separation

The results shown in this test report refer only to the sample(s) tested unless otherwise stated and the sample(s) are retained for 30 days only. The document is issued by AGC, this document cannot be reproduced except in full with our prior written permission. The document is available on request and the brief information for its validation can be assessable and confirmed at <http://www.agc-cert.com/rzcx.asp>



## 1.2 RELATED SUBMITTAL(S) / GRANT (S)

This submittal(s) (test report) is intended for **FCC ID: PH3-DR138**, filing to comply with the FCC Part 90 requirements.

## 1.3 TEST METHODOLOGY

The radiated emission testing was performed according to the procedures of ANSI C 63.4: 2009; TIA/EIA 603 and FCC CFR 47 Rules of 2.1046, 2.1047, 2.1049, 2.1051, 2.1053, 2.1055, 2.1057.

## 1.4 TEST FACILITY

The test site used to collect the radiated data is located on the address of Attestation of Global Compliance (Shenzhen) Co., Ltd. 2/F., Building 2, No.1-No.4, Chaxi Sanwei Technical Industrial Park, Gushu, Xixiang, Bao'an District, Shenzhen, Guangdong, China. The test site is constructed and calibrated to meet the FCC requirements in documents ANSI C63.4: 2003 and IC requirements in documents RS212.

FCC register No.: 259865

## 1.5 SPECIAL ACCESSORIES

Not available for this EUT intended for grant.

## 1.6 EQUIPMENT MODIFICATIONS

Not available for this EUT intended for grant.

The results shown in this test report refer only to the sample(s) tested unless otherwise stated and the sample(s) are retained for 30 days only. The document is issued by AGC, this document cannot be reproduced except in full with our prior written permission. The document is available on request and the brief information for its validation can be assessable and confirmed at <http://www.agc-cert.com/rzcx.asp>







## 2. SYSTEM TEST CONFIGURATION

### 2.1 EUT CONFIGURATION

The EUT configuration for testing is installed on RF field strength measurement to meet the Commission's requirement and operating in a manner which intends to maximize its emission characteristics in a continuous normal application.

### 2.2 EUT EXERCISE

The Transmitter was operated in the normal operating mode. The TX frequency was fixed which was for the purpose of the measurements.

### 2.3 GENERAL TECHNICAL REQUIREMENTS

- (1). Section 15.207: Conducted Limits
- (2). Section 90.205: Maximum ERP is dependent upon the station's antenna HAAT and required service area
- (3). Section 90.207: Modulation Characteristic
- (4). Section 90.209: Occupied Bandwidth
- (5). Section 90.210: Emission Mask
- (6). Section 90.213: Frequency Tolerance
- (7). Section 90.214: Transient Frequency Behavior
- (8). Section 15.109: Radiated Emission

### 2.4 CONFIGURATION OF TESTED SYSTEM

Fig. 2-1 Configuration of Tested System



Table 2-1 Equipment Used in Tested System

Item	Equipment	Model No.	Identifier	Note
1	VHF FM MOBILE TRANSCEIVER	DR-138	FCC ID: PH3-DR138	EUT

The results shown in this test report refer only to the sample(s) tested unless otherwise stated and the sample(s) are retained for 30 days only. The document is issued by AGC, this document cannot be reproduced except in full with our prior written permission. The document is available on request and the brief information for its validation can be assessable and confirmed at <http://www.agc-cert.com/rzcx.asp>

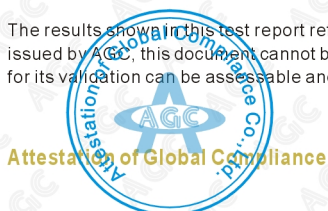



### 3. SUMMARY OF TEST RESULTS

FCC Rules	Description Of Test	Result
§15.207	Conducted Emission	N/A
§90.205	Maximum Transmitter Power	Compliant
§90.207	Modulation Characteristic	Compliant
§90.209	Occupied Bandwidth	Compliant
§90.210	Emission Mask	Compliant
§90.213	Frequency Tolerance	Compliant
§90.214	Transient Frequency Behavior	Compliant
§15.109	Radiated Emission	Compliant

**NOTE:**

1. N/A- Not Applicable.

The results shown in this test report refer only to the sample(s) tested unless otherwise stated and the sample(s) are retained for 30 days only. The document is issued by AGC, this document cannot be reproduced except in full with our prior written permission. The document is available on request and the brief information for its validation can be assessable and confirmed at <http://www.agc-cert.com/rzcx.asp>





#### 4. DESCRIPTION OF TEST MODES

##### RF TEST MODES

The EUT (VHF FM MOBILE TRANSCEIVER) has been tested under normal operating condition. (The top channel, the middle channel and the bottom channel) are chosen for testing at each channel separation (12.5 KHz).

No.	TEST MODES	CHANNEL SEPARATION
1	Low Channel	12.5 KHz
2	Middle Channel	12.5 KHz
3	High Channel	12.5 KHz

##### EMC TEST MODES

No.	TEST MODES
1	Standby Mode + (Charging)

**Note:** Only the result of the worst case was recorded in the report.

The results shown in this test report refer only to the sample(s) tested unless otherwise stated and the sample(s) are retained for 30 days only. The document is issued by AGC, this document cannot be reproduced except in full with our prior written permission. The document is available on request and the brief information for its validation can be assessable and confirmed at <http://www.agc-cert.com/rzcx.asp>





## 5. CONDUCTED LIMITS

### 5.1 PROVISIONS APPLICABLE

For an intentional radiator that is designed to be connected to the public utility (AC) power line, the, the radio frequency voltage that is conducted back onto the AC power line on any frequencies within the band 150 KHz to 30 MHz shall not exceed the limits in the following table, as measured using a 50uH/50 ohms line impedance stabilization network (LISN). Compliance with the provisions of this paragraph shall be based on the measurement of the radio frequency voltage between each power line and ground at the power terminal. The lower limit applies at the boundary between the frequencies ranges.

Frequency of Emission (MHz)	Conducted Limit(dBuV)	
	Quasi-Peak	Average
0.15 – 0.5	66 to 56 *	56 to 46 *
0.5 – 5	56	46
5 – 30	60	50

\* Decreases with the logarithm of the frequency.

### 5.2 MEASUREMENT PROCEDURE

- (1) The equipment was set up as per the test configuration to simulate typical actual usage per the user's manual. When the EUT is a tabletop system, a wooden table with a height of 0.8 meters is used and is placed on the ground plane as per ANSI C63.4 (see Test Facility for the dimensions of the ground plane used). When the EUT is a floor-standing equipment, it is placed on the ground plane which has a 3-12 mm non-conductive covering to insulate the EUT from the ground plane.
- (2) Support equipment, if needed, was placed as per ANSI C63.4.
- (3) All I/O cables were positioned to simulate typical actual usage as per ANSI C63.4.
- (4) The EUT received power through a Line Impedance Stabilization Network (LISN) which supplied power source and was grounded to the ground plane.
- (5) All support equipments received AC power from a second LISN, if any.
- (6) The EUT test program was started. Emissions were measured on each current carrying line of the EUT using a spectrum Analyzer / Receiver connected to the LISN powering the EUT. The LISN has two monitoring points: Line 1 (Hot Side) and Line 2 (Neutral Side). Two scans were taken: one with Line 1 connected to Analyzer / Receiver and Line 2 connected to a 50 ohm load; the second scan had Line 1 connected to a 50 ohm load and Line 2 connected to the Analyzer / Receiver.
- (7) Analyzer / Receiver scanned from 150 KHz to 30MHz for emissions in each of the test modes.  
During the above scans, the emissions were maximized by cable manipulation.

The results shown in this test report refer only to the sample(s) tested unless otherwise stated and the sample(s) are retained for 30 days only. The document is issued by AGC, this document cannot be reproduced except in full with our prior written permission. The document is available on request and the brief information for its validation can be assessable and confirmed at <http://www.agc-cert.com/rzcx.asp>



### 5.3 TEST SETUP BLOCK DIAGRAM

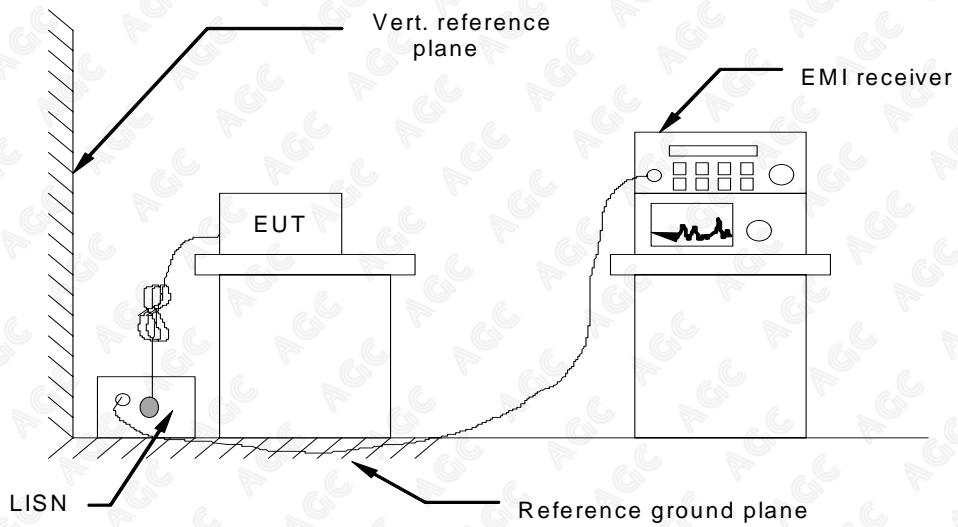

### 5.4 TEST EQUIPMENT USED

Conducted Emission Test Site					
Name of Equipment	Manufacturer	Model	Serial Number	Cal. Date	Cal. Due
TEST RECEIVER	R&S	ESCI	N/A	07/18/2012	07/17/2013
LISN	R&S	ESH3-Z5	N/A	07/18/2012	07/17/2013

The results shown in this test report refer only to the sample(s) tested unless otherwise stated and the sample(s) are retained for 30 days only. The document is issued by AGC, this document cannot be reproduced except in full with our prior written permission. The document is available on request and the brief information for its validation can be assessable and confirmed at <http://www.agc-cert.com/rzcx.asp>



**5.5 TEST RESULT**  
N/A

The results shown in this test report refer only to the sample(s) tested unless otherwise stated and the sample(s) are retained for 30 days only. The document is issued by AGC, this document cannot be reproduced except in full with our prior written permission. The document is available on request and the brief information for its validation can be assessable and confirmed at <http://www.agc-cert.com/rzcx.asp>







## 6. FREQUENCY TOLERANCE

### 6.1 PROVISIONS APPLICABLE

- a). According to FCC Part 2 Section 2.1055(a)(1), the frequency stability shall be measured with variation of ambient temperature from  $-30^{\circ}\text{C}$  to  $+50^{\circ}\text{C}$  centigrade.
- b). According to FCC Part 2 Section 2.1055(d)(2), for battery powered equipment, the frequency stability shall be measured with reducing primary supply voltage to the battery operating end point, which is specified by the manufacturer.
- c). According to FCC Part 90 Section 90.213, the frequency tolerance must be maintained within 0.00025% for 12.5KHz channel separation.

### 6.2 MEASUREMENT PROCEDURE

#### 6.2.1 Frequency stability versus environmental temperature

1. Setup the configuration per figure 1 for frequencies measurement inside an environment chamber, Install new battery in the EUT.
2. Turn on EUT and set SA center frequency to the EUT radiated frequency. Set SA Resolution Bandwidth to 1KHz and Video Resolution Bandwidth to 1KHz and Frequency Span to 50KHz. Record this frequency as reference frequency.
3. Set the temperature of chamber to  $50^{\circ}\text{C}$ . Allow sufficient time (approximately 30 min) for the temperature of the chamber to stabilize. While maintaining a constant temperature inside the chamber, turn the EUT on and measure the EUT operating frequency.
4. Repeat step 2 with a  $10^{\circ}\text{C}$  decreased per stage until the lowest temperature  $-30^{\circ}\text{C}$  is measured, record all measured frequencies on each temperature step.

#### 6.2.2 Frequency stability versus input voltage

1. Setup the configuration per figure 1 for frequencies measured at temperature if it is within  $15^{\circ}\text{C}$  to  $25^{\circ}\text{C}$ . Otherwise, an environment chamber set for a temperature of  $20^{\circ}\text{C}$  shall be used. The EUT shall be powered by DC 13.8V
2. Set SA center frequency to the EUT radiated frequency. Set SA Resolution Bandwidth to 1 KHz and Video Resolution Bandwidth to 1KHz. Record this frequency as reference frequency.
3. Supply the EUT primary voltage at the operating end point which is specified by manufacturer and record the frequency.

The results shown in this test report refer only to the sample(s) tested unless otherwise stated and the sample(s) are retained for 30 days only. The document is issued by AGC, this document cannot be reproduced except in full with our prior written permission. The document is available on request and the brief information for its validation can be assessable and confirmed at <http://www.agc-cert.com/rzcx.asp>

### 6.3 TEST SETUP BLOCK DIAGRAM

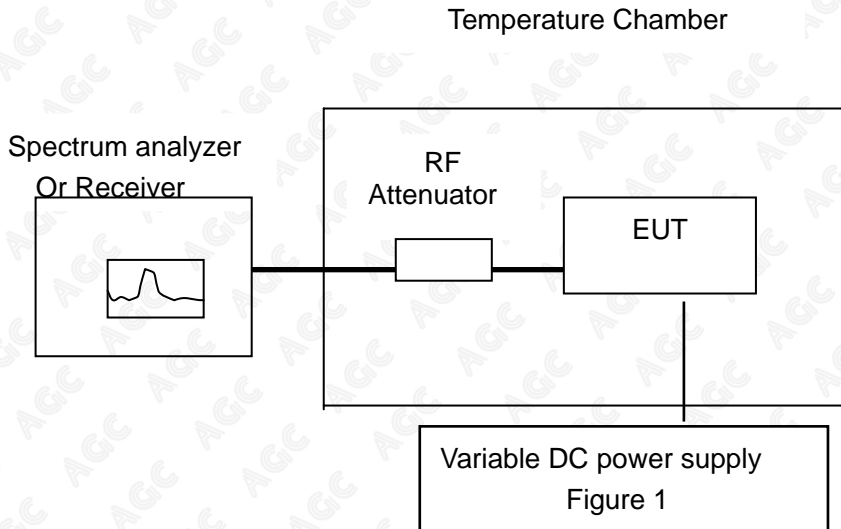

### 6.4 TEST EQUIPMENT USED:

NAME OF EQUIPMENT	MANUFACTURER	MODEL	SERIAL NUMBER	Cal. Date	Cal. Due
Receiver	R&S	ESCI	N/A	07/18/2012	07/17/2013
Climate Chamber	EXPERY	TN-400	N/A	07/18/2012	07/17/2013

The results shown in this test report refer only to the sample(s) tested unless otherwise stated and the sample(s) are retained for 30 days only. The document is issued by AGC, this document cannot be reproduced except in full with our prior written permission. The document is available on request and the brief information for its validation can be assessed and confirmed at <http://www.agc-cert.com/rzcx.asp>





## 6.5 TEST RESULT

(1) Frequency stability versus input voltage (Supply nominal voltage is 13.8V)

### Bottom Channel @ 12.5 KHz Channel Separation

Reference Frequency:	136.000 MHz	Limit:	2.5ppm
Environment Temperature	Power Supply	Frequency Deviation	
(°C)	(V)	(MHz)	ppm
50	DC 13.8 V	136.000067	0.493
40	DC 13.8 V	136.000051	0.375
30	DC 13.8 V	136.000042	0.309
20	DC 13.8 V	136.000031	0.228
10	DC 13.8 V	136.000022	0.162
0	DC 13.8 V	136.000019	0.140
-10	DC 13.8 V	136.000027	0.199
-20	DC 13.8 V	136.000038	0.279
-30	DC 13.8 V	136.000044	0.324

### Middle Channel @ 12.5 KHz Channel Separation

Reference Frequency:	155.025 MHz	Limit:	2.5ppm
Environment Temperature	Power Supply	Frequency Deviation	
(°C)	(V)	(MHz)	ppm
50	DC 13.8 V	155.025077	0.497
40	DC 13.8 V	155.025068	0.439
30	DC 13.8 V	155.025056	0.361
20	DC 13.8 V	155.025044	0.284
10	DC 13.8 V	155.025039	0.252
0	DC 13.8 V	155.025025	0.161
-10	DC 13.8 V	155.025033	0.213
-20	DC 13.8 V	155.025043	0.277
-30	DC 13.8 V	155.025055	0.355

### Top Channel @ 12.5KHz Channel Separation

Reference Frequency:	173.9975	Limit:	2.5ppm
Environment Temperature	Power Supply	Frequency Deviation	
(°C)	(V)	(MHz)	ppm
50	DC 13.8 V	173.997579	0.454
40	DC 13.8 V	173.997567	0.385
30	DC 13.8 V	173.997552	0.299
20	DC 13.8 V	173.997546	0.264
10	DC 13.8 V	173.997534	0.195
0	DC 13.8 V	173.997528	0.161
-10	DC 13.8 V	173.997536	0.207
-20	DC 13.8 V	173.997538	0.218
-30	DC 13.8 V	173.997541	0.236

The results shown in this test report refer only to the sample(s) tested unless otherwise stated and the sample(s) are retained for 30 days only. The document is issued by AGC, this document cannot be reproduced except in full with our prior written permission. The document is available on request and the brief information for its validation can be assessable and confirmed at <http://www.agc-cert.com/rzcx.asp>





(2) Frequency stability versus input voltage (Battery limiting voltage is 11.73V)

**Bottom Channel @ 12.5 KHz Channel Separation**

Reference Frequency:	136.000 MHz	Limit:	2.5ppm
Environment Temperature	Power Supply	Frequency Deviation	
(°C)	(V)	(MHz)	ppm
50	DC 11.73 V	136.000087	0.640
40	DC 11.73 V	136.000075	0.551
30	DC 11.73 V	136.000063	0.463
20	DC 11.73 V	136.000058	0.426
10	DC 11.73 V	136.000044	0.324
0	DC 11.73 V	136.000032	0.235
-10	DC 11.73 V	136.000043	0.316
-20	DC 11.73 V	136.000055	0.404
-30	DC 11.73 V	136.000068	0.500

**Middle Channel @ 12.5 KHz Channel Separation**

Reference Frequency:	155.025 MHz	Limit:	2.5ppm
Environment Temperature	Power Supply	Frequency Deviation	
(°C)	(V)	(MHz)	ppm
50	DC 11.73 V	155.025101	0.652
40	DC 11.73 V	155.025096	0.619
30	DC 11.73 V	155.025084	0.542
20	DC 11.73 V	155.025073	0.471
10	DC 11.73 V	155.025064	0.413
0	DC 11.73 V	155.025053	0.342
-10	DC 11.73 V	155.025069	0.445
-20	DC 11.73 V	155.025075	0.484
-30	DC 11.73 V	155.025088	0.568

**Top Channel @ 12.5KHz Channel Separation**

Reference Frequency:	173.9975	Limit:	2.5ppm
Environment Temperature	Power Supply	Frequency Deviation	
(°C)	(V)	(MHz)	ppm
50	DC 11.73 V	173.997596	0.552
40	DC 11.73 V	173.997583	0.477
30	DC 11.73 V	173.997579	0.454
20	DC 11.73 V	173.997567	0.385
10	DC 11.73 V	173.997553	0.305
0	DC 11.73 V	173.997547	0.270
-10	DC 11.73 V	173.997555	0.316
-20	DC 11.73 V	173.997569	0.397
-30	DC 11.73 V	173.997573	0.420

The results shown in this test report refer only to the sample(s) tested unless otherwise stated and the sample(s) are retained for 30 days only. The document is issued by AGC, this document cannot be reproduced except in full with our prior written permission. The document is available on request and the brief information for its validation can be assessable and confirmed at <http://www.agc-cert.com/rzcx.asp>

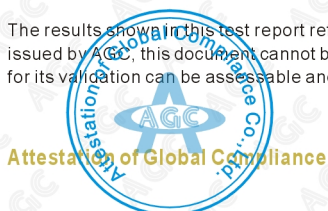





(3) Frequency stability versus input voltage (Battery Fully Charged voltage is 15.87V)

**Bottom Channel @ 12.5 KHz Channel Separation**

Reference Frequency:	136.000 MHz	Limit:	2.5ppm
Environment Temperature	Power Supply	Frequency Deviation	
(°C)	(V)	(MHz)	ppm
50	DC 15.87 V	136.000079	0.581
40	DC 15.87 V	136.000071	0.522
30	DC 15.87 V	136.000066	0.485
20	DC 15.87 V	136.000057	0.419
10	DC 15.87 V	136.000041	0.301
0	DC 15.87 V	136.000039	0.287
-10	DC 15.87 V	136.000046	0.338
-20	DC 15.87 V	136.000052	0.382
-30	DC 15.87 V	136.000058	0.426

**Middle Channel @ 12.5 KHz Channel Separation**

Reference Frequency:	155.025 MHz	Limit:	2.5ppm
Environment Temperature	Power Supply	Frequency Deviation	
(°C)	(V)	(MHz)	ppm
50	DC 15.87 V	155.025096	0.619
40	DC 15.87 V	155.025084	0.542
30	DC 15.87 V	155.025073	0.471
20	DC 15.87 V	155.025062	0.400
10	DC 15.87 V	155.025054	0.348
0	DC 15.87 V	155.025047	0.303
-10	DC 15.87 V	155.025051	0.329
-20	DC 15.87 V	155.025063	0.406
-30	DC 15.87 V	155.025072	0.464

**Top Channel @ 12.5KHz Channel Separation**

Reference Frequency:	173.9975	Limit:	2.5ppm
Environment Temperature	Power Supply	Frequency Deviation	
(°C)	(V)	(MHz)	ppm
50	DC 15.87 V	173.997582	0.471
40	DC 15.87 V	173.997577	0.443
30	DC 15.87 V	173.997566	0.379
20	DC 15.87 V	173.997553	0.305
10	DC 15.87 V	173.997549	0.282
0	DC 15.87 V	173.997541	0.236
-10	DC 15.87 V	173.997551	0.293
-20	DC 15.87 V	173.997564	0.368
-30	DC 15.87 V	173.997576	0.437

The results shown in this test report refer only to the sample(s) tested unless otherwise stated and the sample(s) are retained for 30 days only. The document is issued by AGC, this document cannot be reproduced except in full with our prior written permission. The document is available on request and the brief information for its validation can be assessable and confirmed at <http://www.agc-cert.com/rzcx.asp>

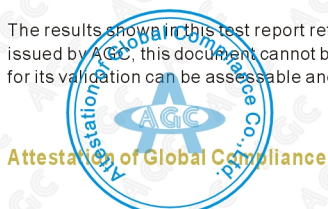

## 7. EMISSION BANDWIDTH

### 7.1 PROVISIONS APPLICABLE

According to FCC Part 90 Section 90.209: The authorized bandwidth shall be 11.25 KHz for 12.5 KHz

### 7.2 MEASUREMENT PROCEDURE

- 1). The EUT was placed on a turn table which is 0.8m above ground plane.
- 2). The EUT was modulated by 2.5 KHz Sine wave audio signal, The level of the audio signal employed is 16 dB greater than that necessary to produce 50% of rated system deviation. Rated system deviation is 2.5 kHz (12.5 kHz channel spacing).
- 3). Set SPA Center Frequency = fundamental frequency, RBW=VBW= 300 Hz, Span =50 KHz.
- 4). Set SPA Max hold. Mark peak, -26 dB.

### 7.3 TEST SETUP BLOCK DIAGRAM

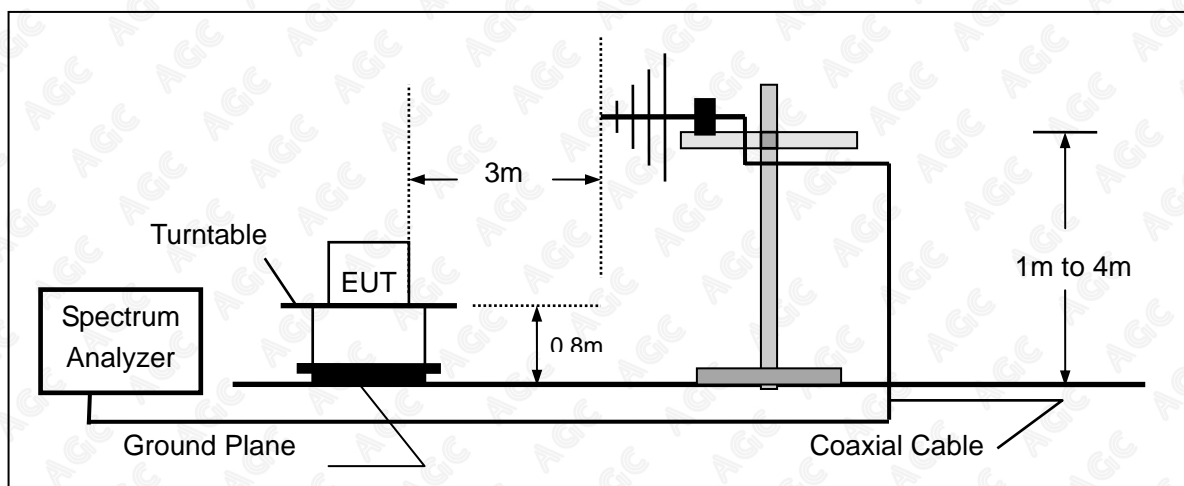

### 7.4 MEASUREMENT EQUIPMENT USED:

NAME OF EQUIPMENT	MANUFACTURER	MODEL	SERIAL NUMBER	Cal. Date	Cal. Due
SPECTRUM ANALYZER	AGILENT	E4440A	US44300399	07/18/2012	07/17/2013
MODULATION ANALYZER	HP	8920B	3104A03367	07/18/2012	07/17/2013
BROADBAND ANT.	A.H.	SAS-521-4	A0304224	07/18/2012	07/17/2013

The results shown in this test report refer only to the sample(s) tested unless otherwise stated and the sample(s) are retained for 30 days only. The document is issued by AGC, this document cannot be reproduced except in full with our prior written permission. The document is available on request and the brief information for its validation can be assessable and confirmed at <http://www.agc-cert.com/rzcx.asp>





**7.5 MEASUREMENT RESULT:**

26 dB Bandwidth Measurement Result			
Operating Frequency	12.5 KHz Channel Separation		
	Test Data	Limits	Result
136.000MHz	10.74 KHz	11.25 KHz	Pass
155.025MHz	10.76KHz	11.25 KHz	Pass
173.9975MHz	10.73 KHz	11.25 KHz	Pass

**Occupied bandwidth of Middle Channel (Maximum) @ 12.5KHz Channel Separation**

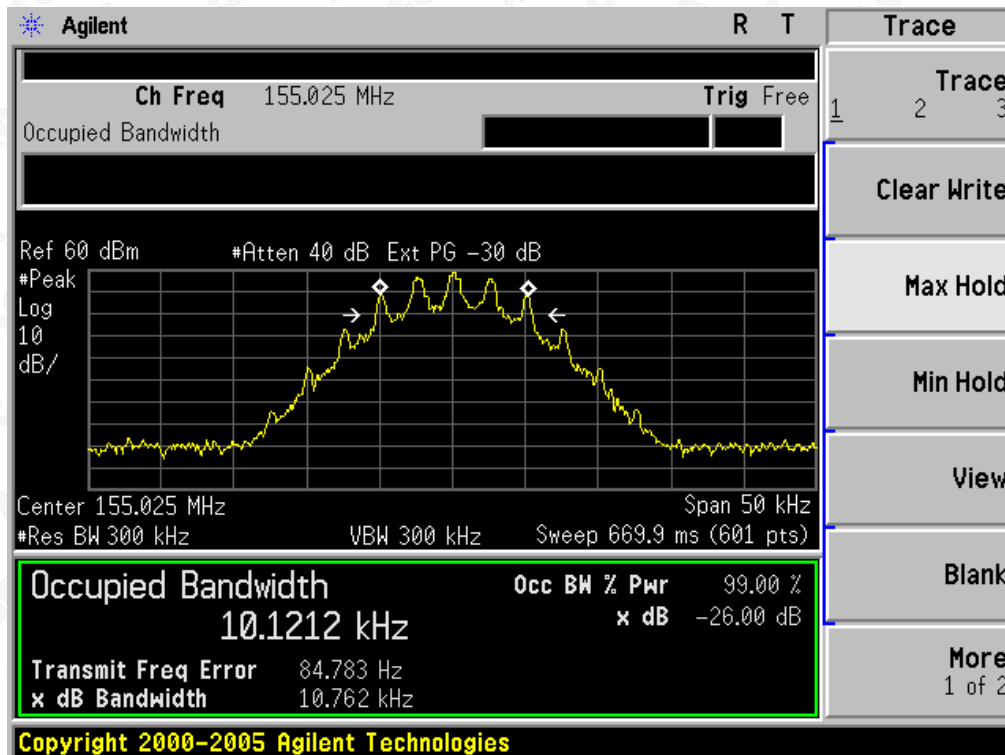

The results shown in this test report refer only to the sample(s) tested unless otherwise stated and the sample(s) are retained for 30 days only. The document is issued by AGC, this document cannot be reproduced except in full with our prior written permission. The document is available on request and the brief information for its validation can be assessable and confirmed at <http://www.agc-cert.com/rzcx.asp>



## 8. UNWANTED RADIATION

### 8.1 PROVISIONS APPLICABLE

8.1.1 According to Section 90.210, the power of each unwanted emission shall be less than Transmitted Power as specified below for transmitters designed to operate with 12.5 KHz channel bandwidth:

- (1). On any frequency removed from the center of the authorized bandwidth  $f_0$  to 5.625 KHz removed from  $f_0$ : Zero dB
- (2). On any frequency removed from the center of the authorized bandwidth by a displacement frequency  $(f_d \text{ in KHz})f_0$  of more than 5.625 KHz but no more than 12.5 KHz: At least  $7.27(f_d - 2.88 \text{ KHz})$  dB
- (3). On any frequency removed from the center of the authorized bandwidth by a displacement Frequency  $(f_d \text{ in KHz})f_0$  of more than 12.5 KHz: At least  $50 + 10 \log(P)$  dB or 70 dB, which ever is lesser attenuation.

### 8.2 MEASUREMENT PROCEDURE

- (1) On a test site, the EUT shall be placed on a turntable, and in the position closest to the normal use as declared by the user.
- (2) The test antenna shall be oriented initially for vertical polarization located 3m from the EUT to correspond to the transmitter.
- (3) The output of the antenna shall be connected to the measuring receiver and either a peak or quasi-peak detector was used for the measurement as indicated on the report. The detector selection is based on how close the emission level was approaching the limit.
- (4) The transmitter shall be switched on; if possible, without the modulation and the measurement receiver shall be tuned to the frequency of the transmitter under test.
- (5) The test antenna shall be raised and lowered through the specified range of height until the measuring receiver detects a maximum signal level.
- (6) The transmitter shall then be rotated through  $360^\circ$  in the horizontal plane, until the maximum signal level is detected by the measuring receiver.
- (7) The test antenna shall be raised and lowered again through the specified range of height until the measuring receiver detects a maximum signal level.
- (8) The maximum signal level detected by the measuring receiver shall be noted.
- (9) The measurement shall be repeated with the test antenna set to horizontal polarization.
- (10) Replace the antenna with a proper Antenna (substitution antenna).
- (11) The substitution antenna shall be oriented for vertical polarization and, if necessary, the length of the substitution antenna shall be adjusted to correspond to the frequency of transmitting.
- (12) The substitution antenna shall be connected to a calibrated signal generator.
- (13) If necessary, the input attenuator setting of the measuring receiver shall be adjusted in order to increase the sensitivity of the measuring receiver.
- (14) The test antenna shall be raised and lowered through the specified range of the height to ensure that the maximum signal is received.
- (15) The input signal to substitution antenna shall be adjusted to the level that produces a level detected by

The results shown in this test report refer only to the sample(s) tested unless otherwise stated and the sample(s) are retained for 30 days only. The document is issued by AGC, this document cannot be reproduced except in full with our prior written permission. The document is available on request and the brief information for its validation can be assessable and confirmed at <http://www.agc-cert.com/rzcx.asp>



the measuring receiver, that is equal to the level noted while the transmitter radiated power was measured, corrected for the change of input attenuation setting of the measuring receiver.

(16) The input level to the substitution antenna shall be recorded as power level in dBm, corrected for any change of input attenuator setting of the measuring receiver.

(17) The measurement shall be repeated with the test antenna and the substitution antenna oriented for horizontal polarization.

### 8.3 TEST SETUP BLOCK DIAGRAM

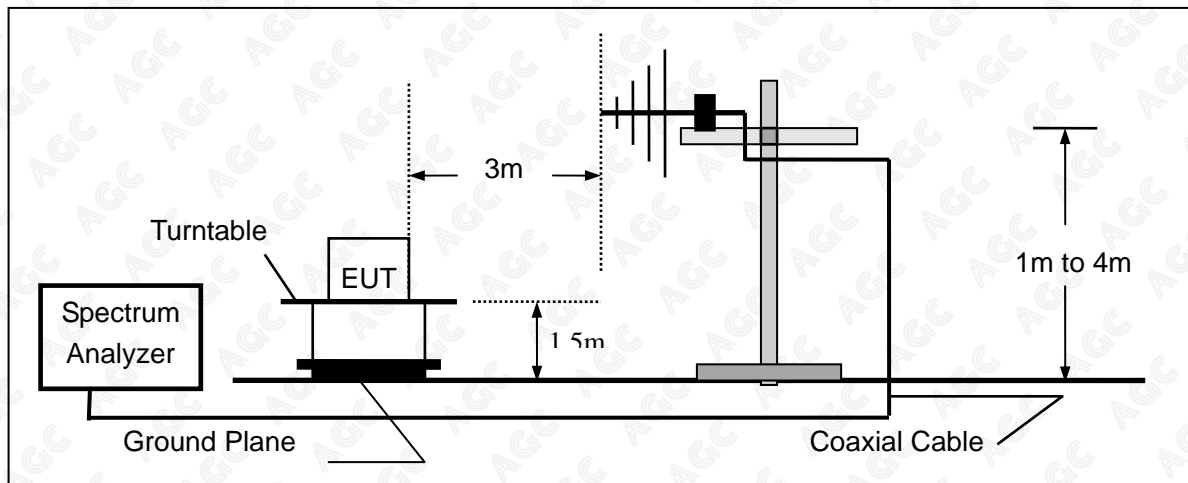

The results shown in this test report refer only to the sample(s) tested unless otherwise stated and the sample(s) are retained for 30 days only. The document is issued by AGC, this document cannot be reproduced except in full with our prior written permission. The document is available on request and the brief information for its validation can be assessable and confirmed at <http://www.agc-cert.com/rzcx.asp>

**SUBSTITUTION METHOD: (Radiated Emissions)**

**Radiated Below 1GHz**

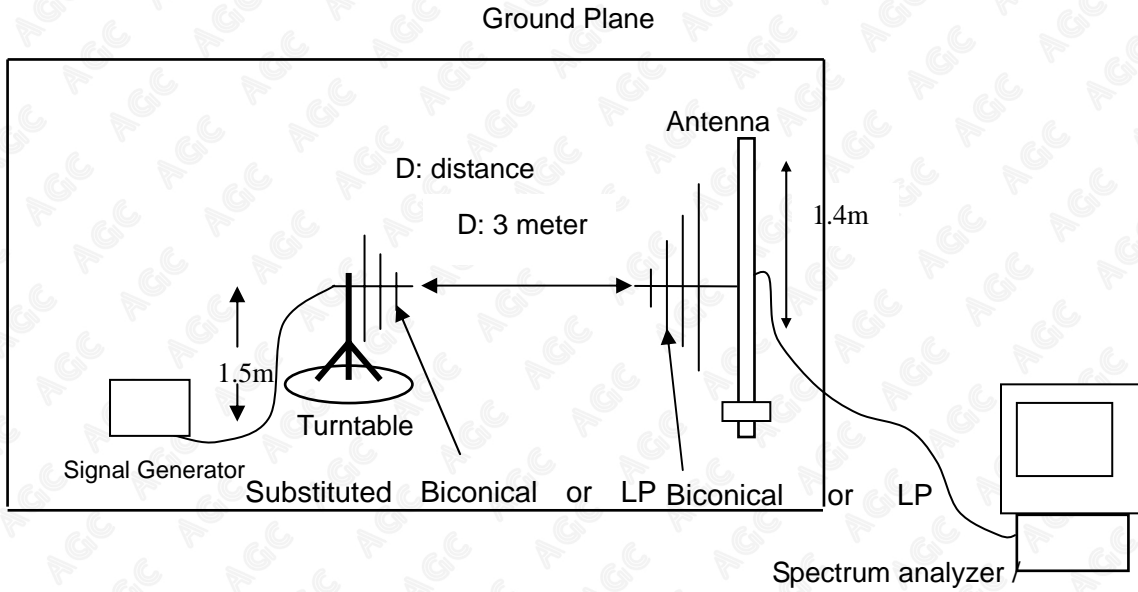

**Radiated Above 1 GHz**

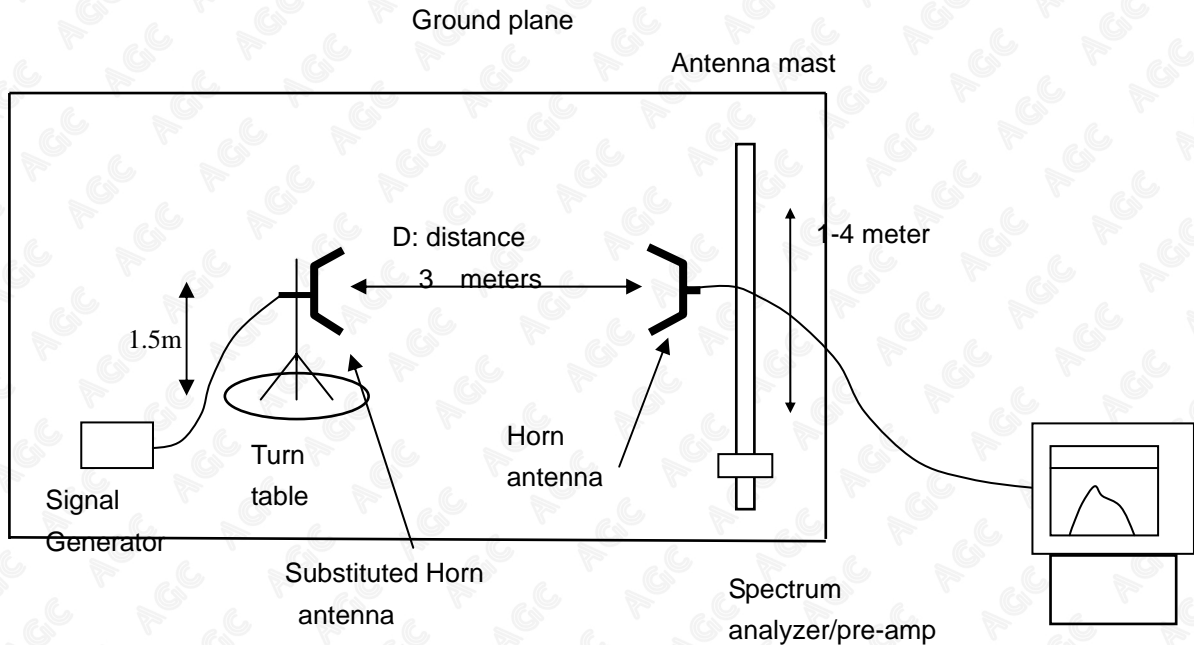

The results shown in this test report refer only to the sample(s) tested unless otherwise stated and the sample(s) are retained for 30 days only. The document is issued by AGC, this document cannot be reproduced except in full with our prior written permission. The document is available on request and the brief information for its validation can be assessable and confirmed at <http://www.agc-cert.com/rzcx.asp>





#### 8.4 MEASUREMENT EQUIPMENT USED:

NAME OF EQUIPMENT	MANUFACTURER	MODEL	SERIAL NUMBER	Cal. Date	Cal. Due
SPECTRUM ANALYZER	AGILENT	E4440A	US44300399	07/18/2012	07/17/2013
TEST RECEIVER	R&S	ESIC	A0304218	07/18/2012	07/17/2013
LOOP ANTENNA	A.H.	SAS-562B	A0304220	07/18/2012	07/17/2013
HORN ANT.	EM	EM-AH-10180	100150	07/18/2012	07/17/2013
BROADBAND ANT.	A.H.	SAS-521-4	A0304224	07/18/2012	07/17/2013

#### 8.5 MEASUREMENT RESULTS:

##### Measurement Result for 12.5 KHz Channel Separation-60W

On any frequency removed from the center of the authorized bandwidth by a displacement Frequency ( $f_d$  in KHz)  $f_o$  of more than 12.5 KHz: At least  $50+10 \log(P)$  dB or 70 dB, which ever is lesser attenuation.

**Limit: At least  $50+10 \log(P) = 50+10 \log(60) = 68$  (dB)**

The results shown in this test report refer only to the sample(s) tested unless otherwise stated and the sample(s) are retained for 30 days only. The document is issued by AGC, this document cannot be reproduced except in full with our prior written permission. The document is available on request and the brief information for its validation can be assessable and confirmed at <http://www.agc-cert.com/rzcx.asp>

**Measurement Result for 12.5 KHz Channel Separation @ 136.000MHz**

Emission Frequency (MHz)	Ant. Polarity(H/V)	Measurement Result Below carrier(dBc)	Limit	Result(P/F)
136.025	v	0		pass
272.050	v	94.31(-46.53dBm)	68	pass
408.08	v	98.52(-50.74dBm)	68	pass
544.100	v	100.23(-52.45dBm)	68	pass
680.125	v	104.74	68	pass
816.150	v	106.41	68	pass
952.175	v	108.32	68	pass
1088.200	v	109.14	68	pass
1224.225	v	109.79	68	pass
1360.250	v	111.24	68	pass

**Measurement Result for 12.5 KHz Channel Separation @ 155.025MHz**

Emission Frequency (MHz)	Ant. Polarity(H/V)	Measurement Result Below carrier(dBc)	Limit	Result(P/F)
155.025	v	0		pass
310.050	v	95.13(-47.35dBm)	68	pass
465.075	v	99.26(-51.486dBm)	68	pass
620.100	v	100.57(-52.79dBm)	68	pass
775.125	v	104.82	68	pass
930.150	v	105.62	68	pass
1085.175	v	107.28	68	pass
1240.200	v	108.74	68	pass
1395.225	v	109.63	68	pass
1550.250	v	111.85	68	pass

**Measurement Result for 12.5 KHz Channel Separation @ 173.9975MHz**

Emission Frequency (MHz)	Ant. Polarity(H/V)	Measurement Result Below carrier(dBc)	Limit	Result(P/F)
173.995	v	0		pass
347.990	v	99.34(-51.56dBm)	68	pass
521.985	v	100.25(-52.47dBm)	68	pass
695.980	v	105.67	68	pass
869.975	v	106.32	68	pass
1043.970	v	102.57	68	pass
1217.965	v	107.66	68	pass
1391.960	v	109.27	68	pass
1565.955	v	111.63	68	pass
1739.950	v	113.41	68	pass

**Notes: The emissions were scanned from 30 MHz to 10th harmonics;**

The results shown in this test report refer only to the sample(s) tested unless otherwise stated and the sample(s) are retained for 30 days only. The document is issued by AGC, this document cannot be reproduced except in full with our prior written permission. The document is available on request and the brief information for its validation can be assessable and confirmed at <http://www.agc-cert.com/rzcx.asp>





### 8.6 EMISSION MASK PLOT

The detailed procedure employed for Emission Mask measurements are specified as following:

- The transmitter shall be modulated by a 2.5 kHz audio signal,
- The level of the audio signal employed is 16 dB greater than that necessary to produce 50% of rated system deviation. Rated system deviation is 2.5 kHz (12.5 kHz channel spacing)

#### The Worst Emission Mask for 12.5 KHz channel Separation (60W)

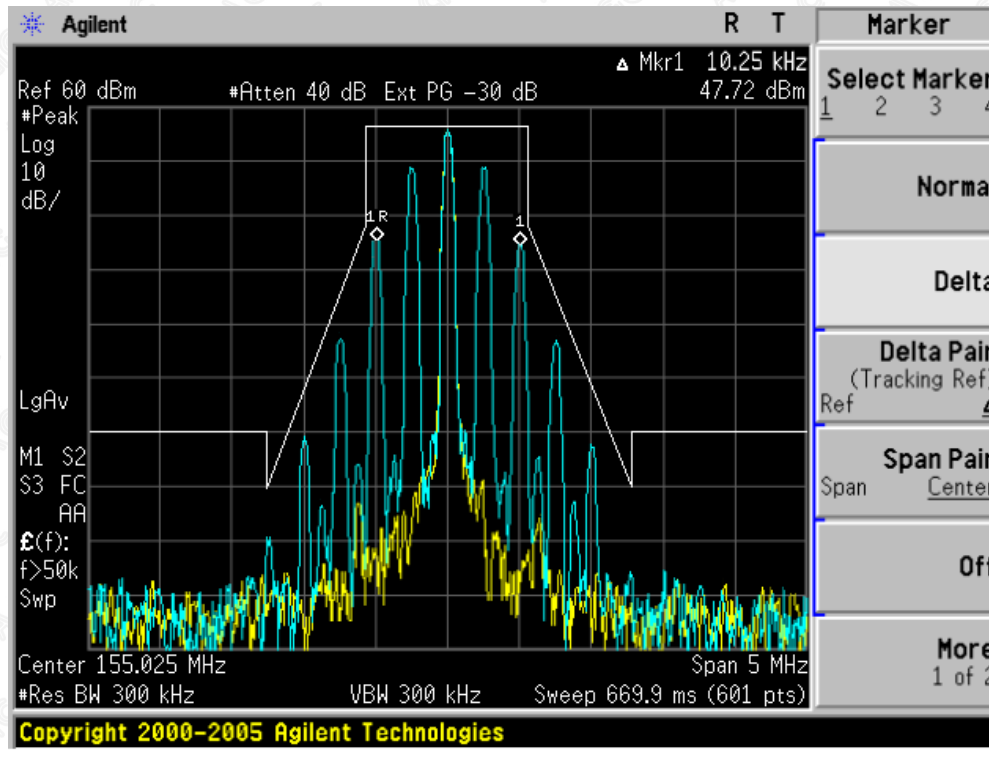

The results shown in this test report refer only to the sample(s) tested unless otherwise stated and the sample(s) are retained for 30 days only. The document is issued by AGC, this document cannot be reproduced except in full with our prior written permission. The document is available on request and the brief information for its validation can be assessable and confirmed at <http://www.agc-cert.com/rzcx.asp>

## 9. MODULATION CHARACTERISTICS

### 9.1 PROVISIONS APPLICABLE

According to CFR 47 section 2.1047(a), for Voice Modulation Communication Equipment, the frequency response of the audio modulation circuit over a range of 100 to 5000Hz shall be measured.

### 9.2 MEASUREMENT METHOD

#### 9.2.1 Modulation Limit

- (1). Configure the EUT as shown in figure 1, adjust the audio input for 60% of rated system deviation at 1KHz using this level as a reference (0dB) and vary the input level from -20 to +20dB. Record the frequency deviation obtained as a function of the input level.
- (2). Repeat step 1 with input frequency changing to 300, 1000, 1500 and 3000Hz in sequence.

#### 9.2.2 Audio Frequency Response

- (1). Configure the EUT as shown in figure 1.
- (2). Adjust the audio input for 20% of rated system deviation at 1 KHz using this level as a reference (0 dB).
- (3). Vary the Audio frequency from 100 Hz to 10 KHz and record the frequency deviation.
- (4). Audio Frequency Response =  $20\log_{10}(\text{Deviation of test frequency}/\text{Deviation of 1 KHz reference})$ .

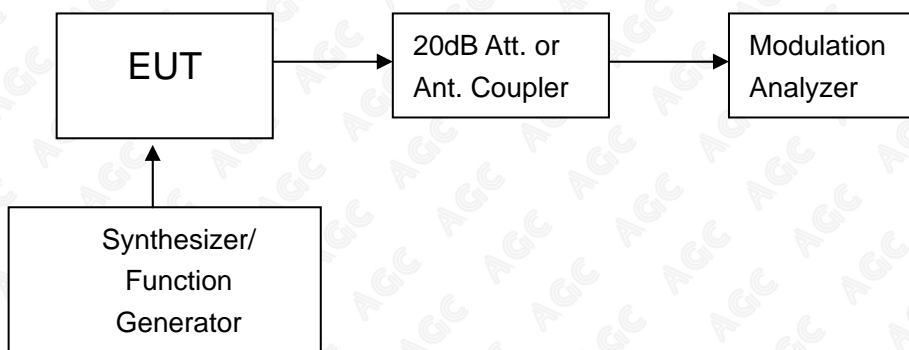

**Figure 1: Modulation characteristic measurement configuration**

### 9.3 MEASUREMENT INSTRUMENTS

NAME OF EQUIPMENT	MANUFACTURER	MODEL	SERIAL NUMBER	Cal. Date	Cal. Due
Modulation Analyzer	HP	8920B	3104A03367	07/18/2012	07/17/2013

NOTE: 8920B can generate audio modulation frequency.





### 9.4 MEASUREMENT RESULT

#### (A). MODULATION LIMIT:

#### Middle Channel @ 12.5 KHz Channel Separations

Modulation Level (dB)	Peak Freq. Deviation At 300 Hz	Peak Freq. Deviation At 1000 Hz	Peak Freq. Deviation At 1500 Hz	Peak Freq. Deviation At 3000 Hz
-20	0.28	0.82	0.85	0.89
-15	0.37	0.92	0.98	1.02
-10	0.46	1.25	1.27	1.33
-5	0.59	1.39	1.41	1.46
0	0.65	1.50	1.51	1.55
+5	0.77	1.68	1.72	1.81
+10	0.83	1.77	1.79	1.84
+15	0.96	1.64	1.71	1.76
+20	0.84	1.52	1.68	1.72

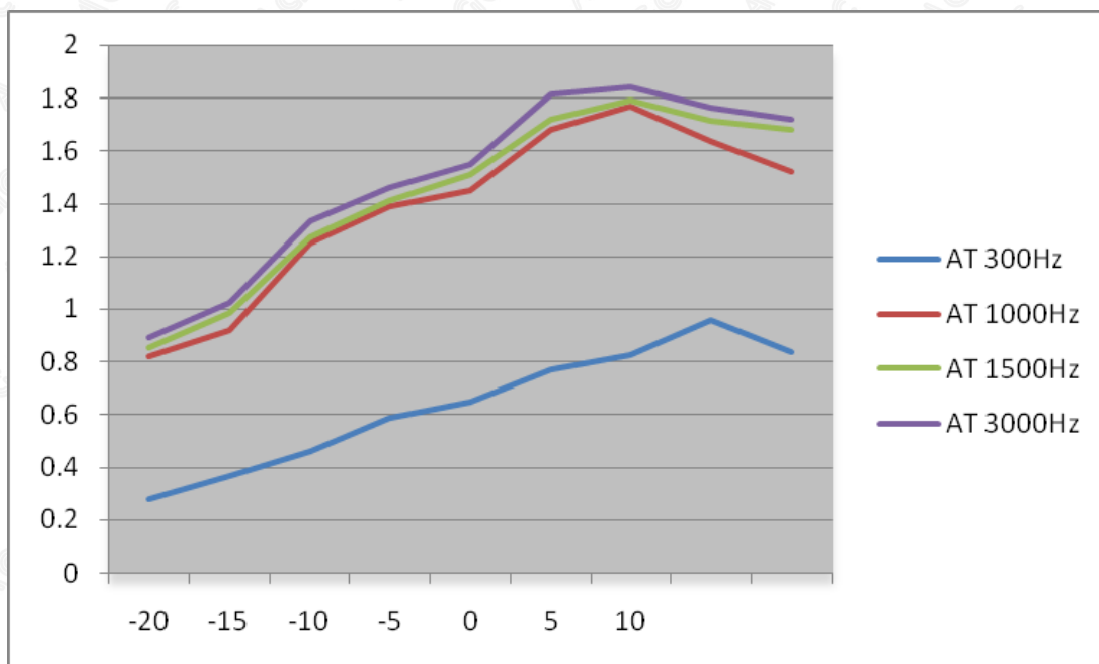

The results shown in this test report refer only to the sample(s) tested unless otherwise stated and the sample(s) are retained for 30 days only. The document is issued by AGC, this document cannot be reproduced except in full with our prior written permission. The document is available on request and the brief information for its validation can be assessable and confirmed at <http://www.agc-cert.com/rzcx.asp>



**(B). AUDIO FREQUENCY RESPONSE:**

**Middle Channel @ 12.5 KHz Channel Separations**

Frequency (Hz)	Deviation (KHz)	Audio Frequency Response(dB)
100	--	--
200	--	--
300	0.13	-11.70
400	0.16	-9.90
500	0.21	-7.54
600	0.23	-6.74
700	0.27	-5.35
800	0.32	-3.88
900	0.41	-1.72
1000	0.5	0.00
1200	0.57	1.14
1400	0.68	2.67
1600	0.78	3.86
1800	0.89	5.01
2000	0.99	5.93
2400	1.26	8.03
2500	1.41	9.00
2800	1.65	10.37
3000	1.76	10.93
3200	1.74	10.83
3600	1.54	9.77
4000	1.08	6.69
4500	0.81	4.19
5000	0.73	3.29
5500	0.52	0.34
6000	0.16	-9.90
6500	0.07	-17.08
7000	0.03	-24.44
7500	0.02	-27.96
9000	--	--
10000	--	--
14000	--	--
18000	--	--
20000	--	--
30000	--	--

The results shown in this test report refer only to the sample(s) tested unless otherwise stated and the sample(s) are retained for 30 days only. The document is issued by AGC, this document cannot be reproduced except in full with our prior written permission. The document is available on request and the brief information for its validation can be assessable and confirmed at <http://www.agc-cert.com/rzcx.asp>







**Frequency Response of Middle Channel**

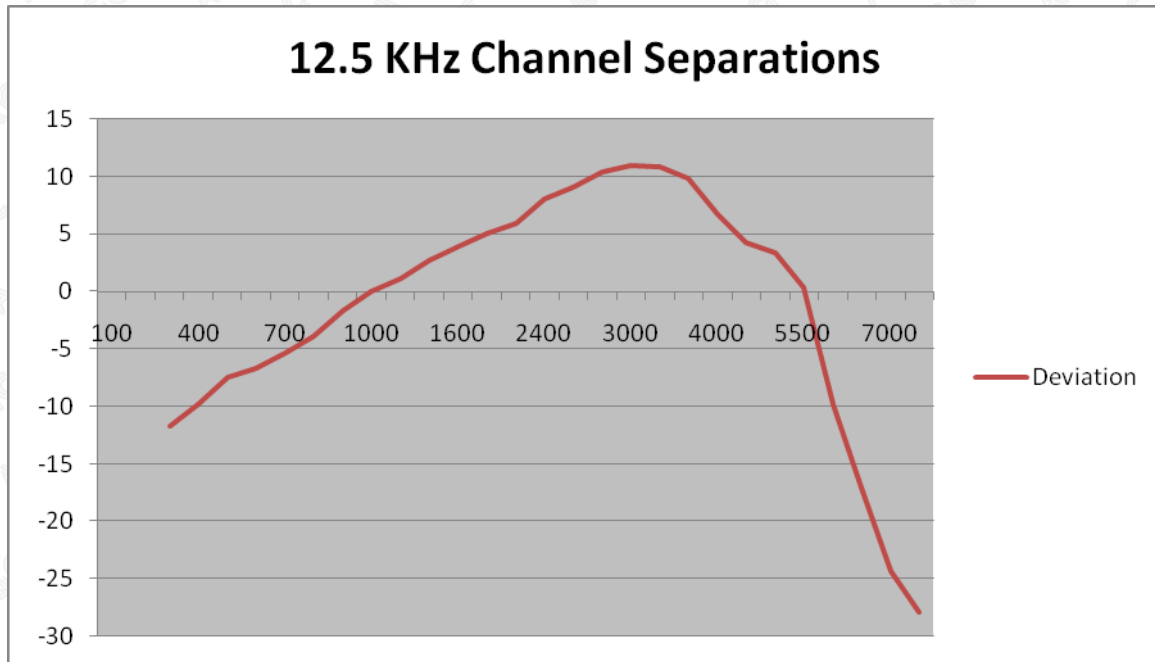

The results shown in this test report refer only to the sample(s) tested unless otherwise stated and the sample(s) are retained for 30 days only. The document is issued by AGC, this document cannot be reproduced except in full with our prior written permission. The document is available on request and the brief information for its validation can be assessable and confirmed at <http://www.agc-cert.com/rzcx.asp>





## 10. MAXIMUM TRANSMITTER POWER (CONDUCTED OUTPUT POWER)

### 10.1 PROVISIONS APPLICABLE

Per FCC §2.1046 and §90.205 AND RSS 119 Part 4.1: Maximum ERP is dependent upon the station's antenna HAAT and required service area.

### 10.2 TEST PROCEDURE

The RF output of Two-way Radio was conducted to a spectrum analyzer through an appropriate attenuator.

### 10.3 TEST INSTRUMENTS

NAME OF EQUIPMENT	MANUFACTURER	MODEL	SERIAL NUMBER	Cal. Date	Cal. Due
SPECTRUM ANALYZER	AGILENT	E4440A	US44300399	07/18/2012	07/17/2013

### 10.4 TEST CONFIGURATION

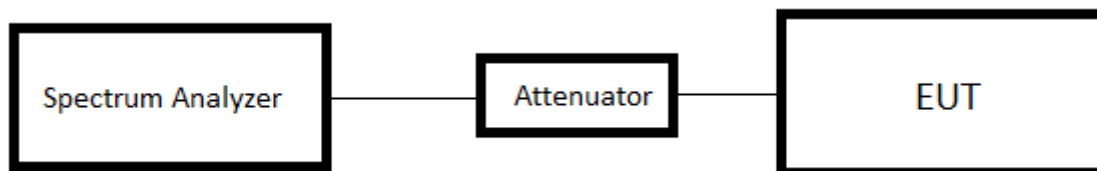

### 10.5 TEST RESULT

The maximum Conducted Power (CP) is  
60 W for 12.5 KHz Channel Separation

Calculation Formula:  $CP = R + A + L$

\* Note:

CP: The final Conducted Power

R : The reading value from spectrum analyzer

A : The attenuation value of the used attenuator

L : The loss of all connection cables

Conducted Power Measurement Results		
Channel Separation	Channel	Measurement Result (dBm)
		For 47.78dBm(60W)
12.5 KHz	Bottom(136.000MHz)	47.75
	Middle(155.025MHz)	47.72
	Top (173.9975MHz)	47.73

The results shown in this test report refer only to the sample(s) tested unless otherwise stated and the sample(s) are retained for 30 days only. The document is issued by AGC, this document cannot be reproduced except in full with our prior written permission. The document is available on request and the brief information for its validation can be assessable and confirmed at <http://www.agc-cert.com/rzcx.asp>





10.6 CONDUCT SPURIOUS PLOT

**Conducted Spurious Emission(worst) @ 155.025MHz (30MHz-1GHz)**

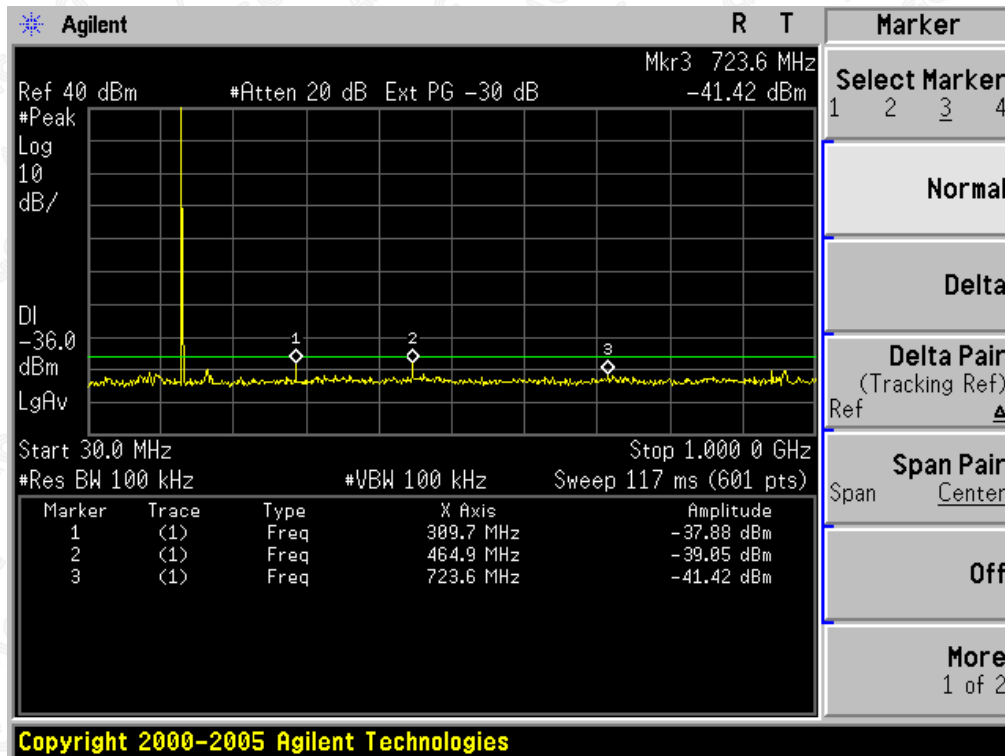

**Conduct Spurious Emission(worst) @ 155.025MHz (1GHz-12.75GHz)**

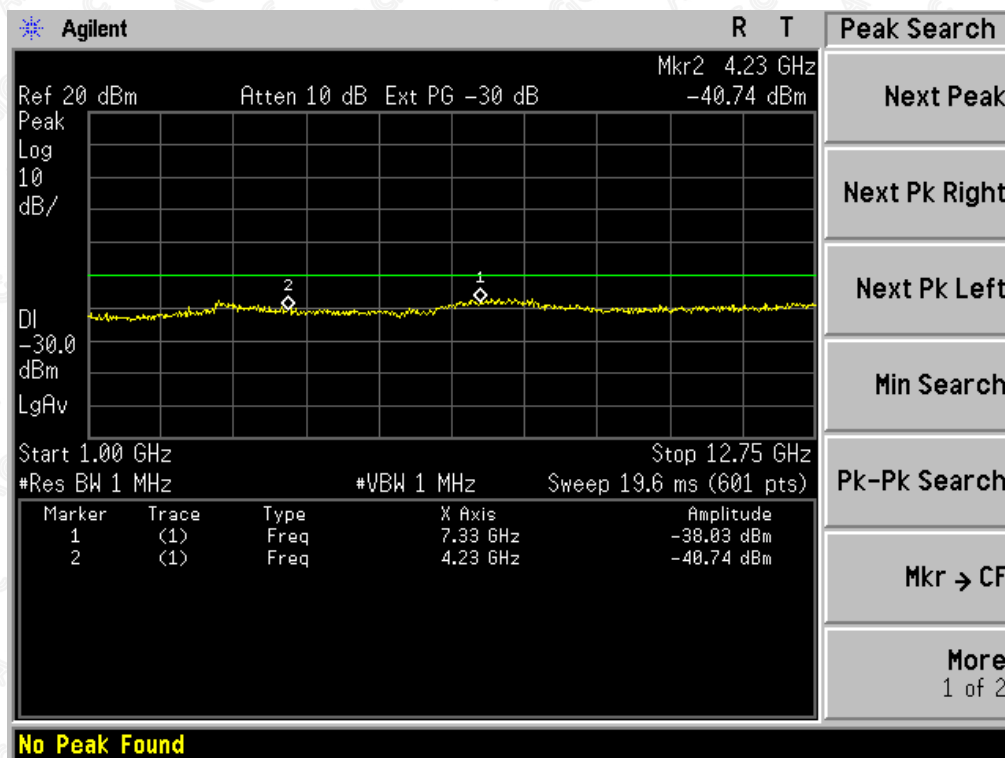

The results shown in this test report refer only to the sample(s) tested unless otherwise stated and the sample(s) are retained for 30 days only. The document is issued by AGC, this document cannot be reproduced except in full with our prior written permission. The document is available on request and the brief information for its validation can be assessable and confirmed at <http://www.agc-cert.com/rzcx.asp>



## 11. TRANSMITTER FREQUENCY BEHAVIOR

### 11.1 PROVISIONS APPLICABLE

Section 90.214

Time intervals <sup>1, 2</sup>	Maximum frequency difference <sup>3</sup>	All equipment	
		150 to 174 MHz	421 to 512 MHz
Transient Frequency Behavior for Equipment Designed to Operate on 25 kHz Channels			
t <sub>1</sub> <sup>4</sup> .....	± 25.0 kHz	5.0 ms	10.0 ms
t <sub>2</sub> .....	± 12.5 kHz	20.0 ms	25.0 ms
t <sub>3</sub> <sup>4</sup> .....	± 25.0 kHz	5.0 ms	10.0 ms
Transient Frequency Behavior for Equipment Designed to Operate on 12.5 kHz Channels			
t <sub>1</sub> <sup>4</sup> .....	± 12.5 kHz	5.0 ms	10.0 ms
t <sub>2</sub> .....	± 6.25 kHz	20.0 ms	25.0 ms
t <sub>3</sub> <sup>4</sup> .....	± 12.5 kHz	5.0 ms	10.0 ms
Transient Frequency Behavior for Equipment Designed to Operate on 6.25 kHz Channels			
t <sub>1</sub> <sup>4</sup> .....	± 6.25 kHz	5.0 ms	10.0 ms
t <sub>2</sub> .....	± 3.125 kHz	20.0 ms	25.0 ms
t <sub>3</sub> <sup>4</sup> .....	± 6.25 kHz	5.0 ms	10.0 ms

<sup>1</sup> t<sub>on</sub> is the instant when a 1 kHz test signal is completely suppressed, including any capture time due to phasing.

t<sub>1</sub> is the time period immediately following t<sub>on</sub>.

t<sub>2</sub> is the time period immediately following t<sub>1</sub>.

t<sub>3</sub> is the time period from the instant when the transmitter is turned off until t<sub>off</sub>.

t<sub>off</sub> is the instant when the 1 kHz test signal starts to rise.

<sup>2</sup> During the time from the end of t<sub>2</sub> to the beginning of t<sub>3</sub>, the frequency difference must not exceed the limits specified in §90.213.

<sup>3</sup> Difference between the actual transmitter frequency and the assigned transmitter frequency.

<sup>4</sup> If the transmitter carrier output power rating is 6 watts or less, the frequency difference during this time period may exceed the maximum frequency difference for this time period.

### 11.2 TEST METHOD

TIA/EIA-603 2.2.19

### 11.3 TEST INSTRUMENTS

NAME OF EQUIPMENT	MANUFACTURER	MODEL	SERIAL NUMBER	Cal. Date	Cal. Due
Signal Generator	AGILENT	E4412B	LR114196	07/18/2012	07/17/2013
Storage Oscilloscope	Tektronix	TDS3052	B017447	07/18/2012	07/17/2013

The results shown in this test report refer only to the sample(s) tested unless otherwise stated and the sample(s) are retained for 30 days only. The document is issued by AGC, this document cannot be reproduced except in full with our prior written permission. The document is available on request and the brief information for its validation can be assessable and confirmed at <http://www.agc-cert.com/rzcx.asp>







### 11.4 DESCRIBE LIMIT LINE OF TRANSMITTER FREQUENCY BEHAVIOR

**ton**: The switch-on instant  $t_{on}$  of a transmitter is defined by the condition when the output power, measured at the antenna terminal, exceeds 0,1 % of the full output power (-30 dBc).

**t1**: period of time starting at  $t_{on}$  and finishing according to above 11.1

**t2**: period of time starting at the end of  $t_1$  and finishing according to above 11.1

**toff**: switch-off instant defined by the condition when the output power falls below 0,1 % of the full output power (-30 dBc).

**t3**: period of time that finishing at  $t_{off}$  and starting according to above 11.1

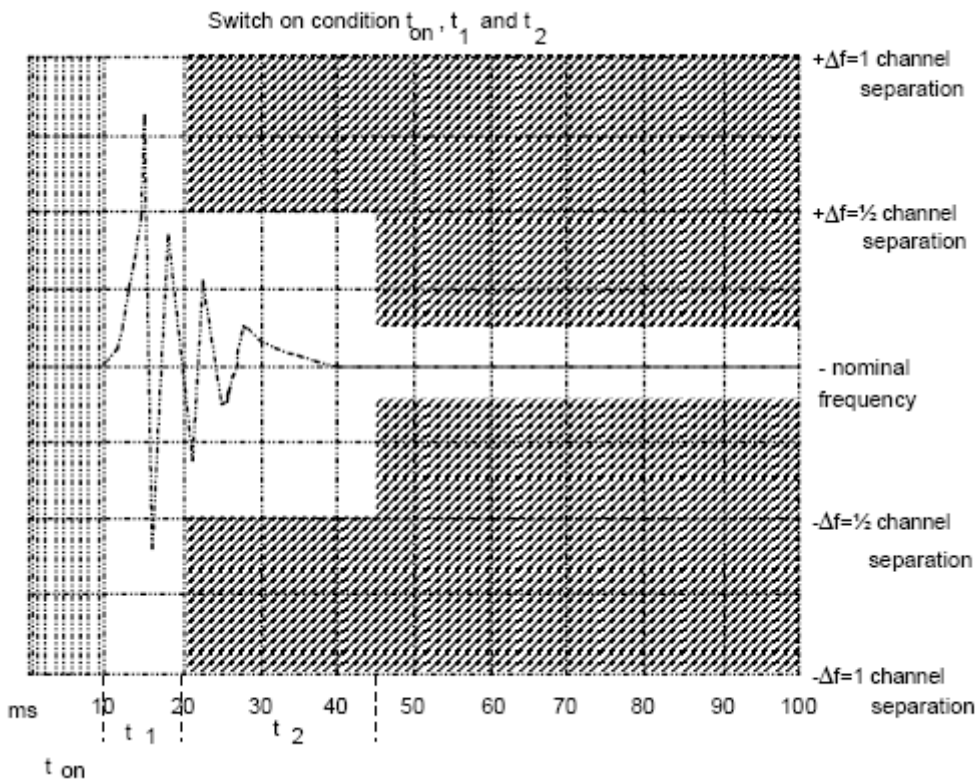

The results shown in this test report refer only to the sample(s) tested unless otherwise stated and the sample(s) are retained for 30 days only. The document is issued by AGC, this document cannot be reproduced except in full with our prior written permission. The document is available on request and the brief information for its validation can be assessable and confirmed at <http://www.agc-cert.com/rzcx.asp>

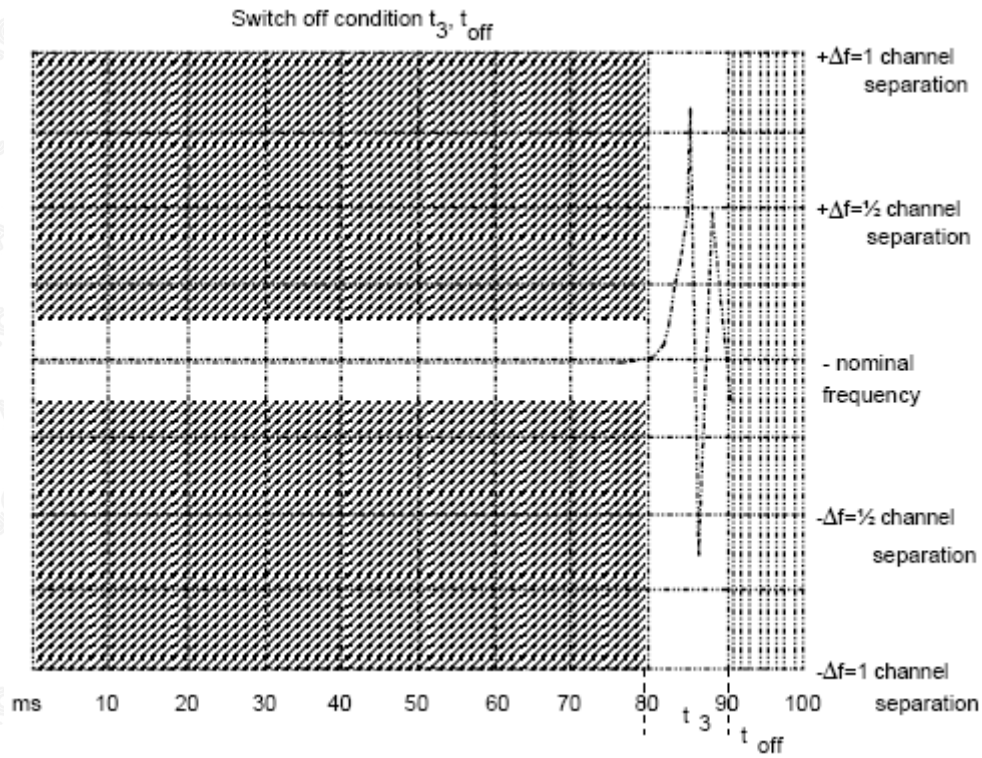

The results shown in this test report refer only to the sample(s) tested unless otherwise stated and the sample(s) are retained for 30 days only. The document is issued by AGC, this document cannot be reproduced except in full with our prior written permission. The document is available on request and the brief information for its validation can be assessable and confirmed at <http://www.agc-cert.com/rzcx.asp>

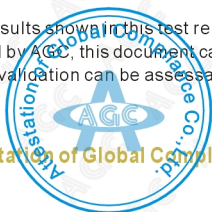



### 11.5 MEASURE RESULT

Transmitter Frequency Behaviour @ 12.5 KHz Channel Separation--Off to On

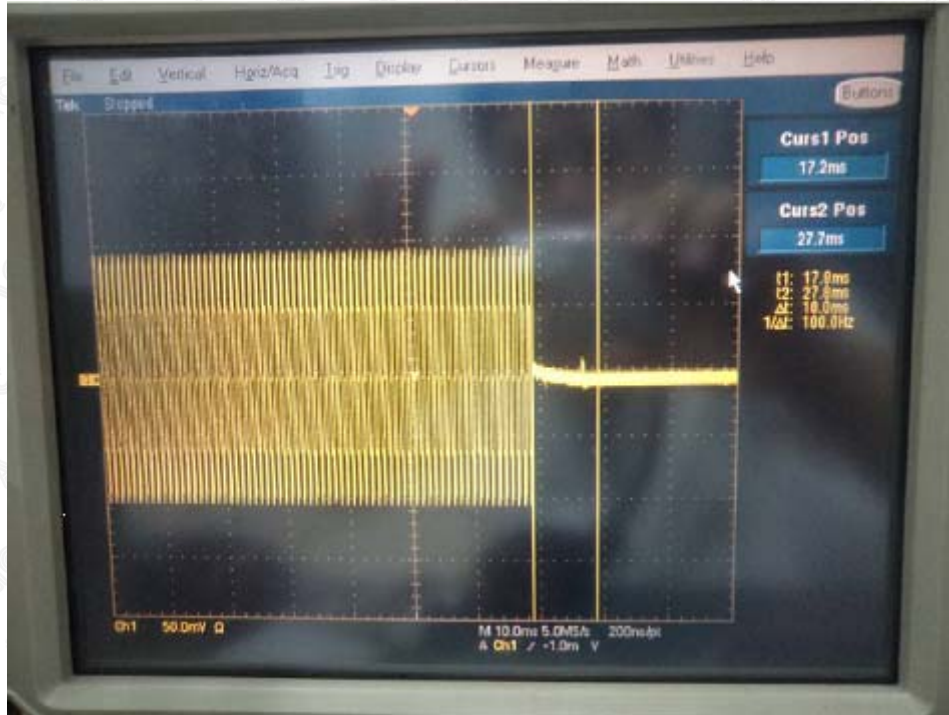

Transmitter Frequency Behaviour @ 12.5 KHz Channel Separation--On to Off

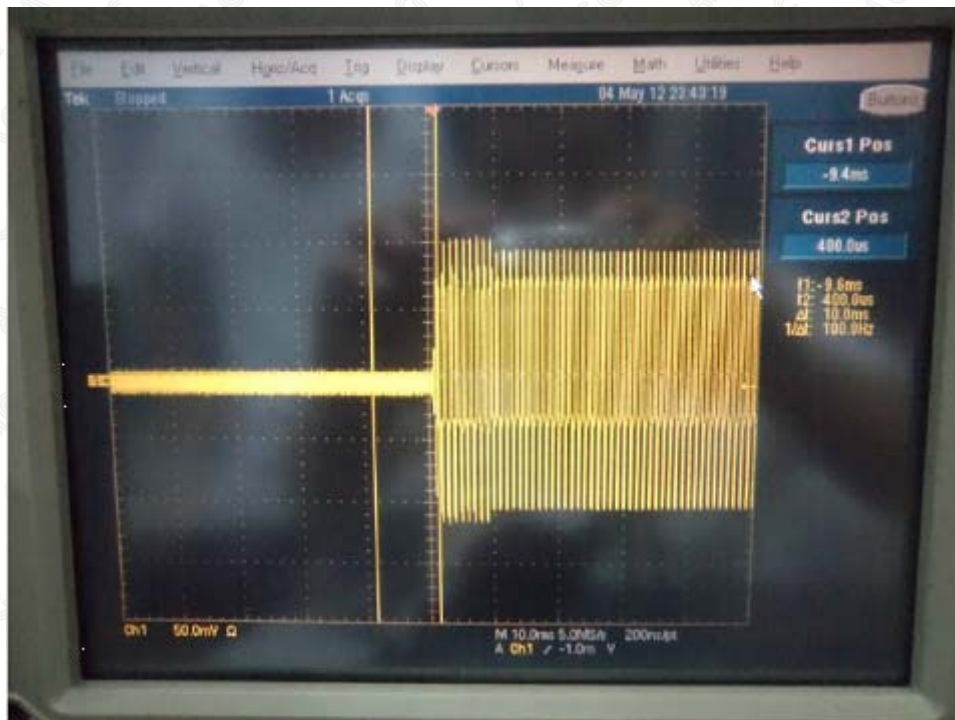

The results shown in this test report refer only to the sample(s) tested unless otherwise stated and the sample(s) are retained for 30 days only. The document is issued by AGC, this document cannot be reproduced except in full with our prior written permission. The document is available on request and the brief information for its validation can be assessable and confirmed at <http://www.agc-cert.com/rzcx.asp>



## 12. RADIATED EMISSION ON RECEIVING MODE

### 12.1 PROVISIONS APPLICABLE

FCC Part 15 Subpart B Section 15.109

### 12.2 TEST METHOD

ANSI C 63.4: 2003

### 12.3 TEST INSTRUMENTS

NAME OF EQUIPMENT	MANUFACTURER	MODEL	SERIAL NUMBER	Cal. Date	Cal. Due
SPECTRUM ANALYZER	AGILENT	E4440A	US44300399	07/18/2012	07/17/2013
TEST RECEIVER	R&S	ESIC	A0304218	07/18/2012	07/17/2013
LOOP ANTENNA	A.H.	SAS-562B	N/A	07/18/2012	07/17/2013
HORN ANT.	EM	EM-AH-10180	100150	07/18/2012	07/17/2013
BROADBAND ANT.	A.H.	SAS-521-4	A0304224	07/18/2012	07/17/2013

The results shown in this test report refer only to the sample(s) tested unless otherwise stated and the sample(s) are retained for 30 days only. The document is issued by AGC, this document cannot be reproduced except in full with our prior written permission. The document is available on request and the brief information for its validation can be assessable and confirmed at <http://www.agc-cert.com/rzcx.asp>

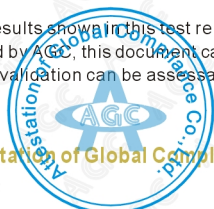







RADIATED EMISSION TEST RESULTS – VERTICAL

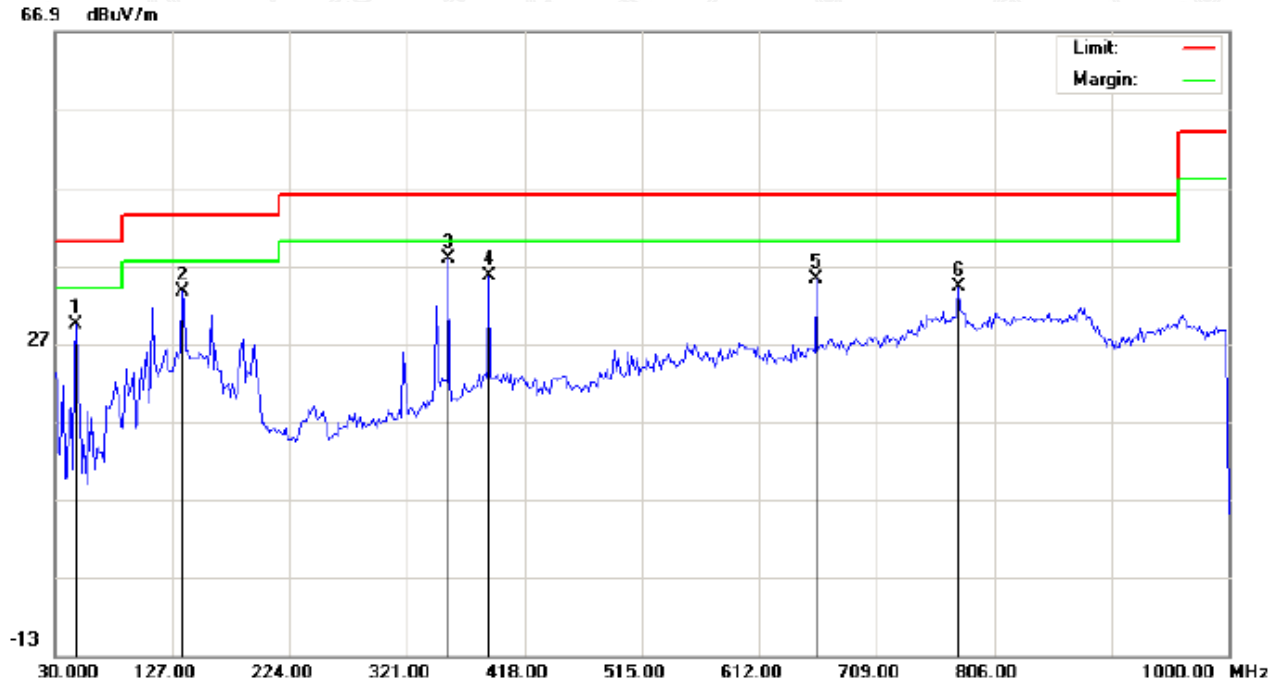

Site: site #1      Polarization: **Vertical**      Temperature: 26  
 Limit: FCC Class B 3M Radiation      Power:      Humidity: 60 %  
 EUT: VHF FM MOBILE TRANSCEIVER      Distance: 3m  
 M/N: DR-138  
 Mode: Mode 1  
 Note:

No.	Mk	Freq.	Reading	Factor	Measurement	Limit	Over	Detector	Antenna	Table	Comment
		MHz	dBuV	dB/m	dBuV/m	dBuV/m	dB		Height	Degree	
									cm	degree	
1		47.7832	25.00	4.45	29.45	40.00	-10.55	peak			
2		135.0833	23.04	10.58	33.62	43.50	-9.88	peak			
3	*	354.9499	18.74	19.08	37.82	46.00	-8.18	peak			
4		388.8999	16.56	19.06	35.62	46.00	-10.38	peak			
5		658.8832	9.40	25.76	35.16	46.00	-10.84	peak			
6		776.8999	7.10	27.19	34.29	46.00	-11.71	peak			

The results shown in this test report refer only to the sample(s) tested unless otherwise stated and the sample(s) are retained for 30 days only. The document is issued by AGC, this document cannot be reproduced except in full with our prior written permission. The document is available on request and the brief information for its validation can be assessable and confirmed at <http://www.agc-cert.com/rzcx.asp>

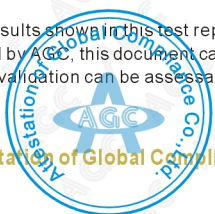





### 13. AUDIO LOW PASS FILTER RESPONSE

#### 13.1 LIMITS

**2.1047(a):** Voice modulated communication equipment. A curve or equivalent data showing the frequency response of the audio modulating circuit over a range of 100 to 5000 Hz shall be submitted. For equipment required to have an audio low-pass filter, a curve showing the frequency response of the filter or of all circuitry installed between the modulation limiter and the modulated stage shall be submitted.

**90.242(b)(8):** Recommended audio filter attenuation characteristics are given below:

Audio band	Minimum Attenuation Rel. to 1 KHz Attenuation
3 –20 KHz 20 – 30 KHz	$60 \log_{10}(f/3)$ dB where f is in KHz 50dB

#### 13.2. METHOD OF MEASUREMENTS

The rated audio input signal was applied to the input of the audio low-pass filter (or of all modulation stages) using an audio oscillator, this input signal level and its corresponding output signal were then measured and recorded using the FFT Digital Spectrum Analyzer. Tests were repeated at different audio signal frequencies from 0 to 50 KHz.

The results shown in this test report refer only to the sample(s) tested unless otherwise stated and the sample(s) are retained for 30 days only. The document is issued by AGC, this document cannot be reproduced except in full with our prior written permission. The document is available on request and the brief information for its validation can be assessable and confirmed at <http://www.agc-cert.com/rzcx.asp>



13.3 TEST DATA

12.5 KHZ CHANNEL SPACING, F3E, FREQUENCY OF ALL MODULATION STATES

Frequency (KHz)	Audio In (dBV)	Audio out (dBV)	Attenuation (Out_In) dB	Attenuation Rel. to 3 KHz (dB)	Recommended Attenuation (dB)
0.1	-75.76	-30.27	45.8	-36.2	
0.2	-75.76	-18.88	57.5	-25.3	
0.4	-75.76	-5.24	70.4	-12.5	
0.6	-75.76	0.23	76.2	-6.5	
0.8	-75.76	4.07	79.6	-2.7	
1.0	-75.76	6.67	82.3	0.0	
1.5	-75.76	8.79	84.2	2.1	
2.0	-75.76	8.57	84.5	1.9	
2.5	-75.76	7.13	82.7	0.5	
3.0	-75.76	5.34	81.2	-1.5	0
3.5	-75.76	2.08	77.3	-4.4	-4
4.0	-75.76	-2.62	73.7	-9.6	-7
4.5	-75.76	-8.46	67.3	-15.3	-11
5.0	-75.76	-14.04	61.6	-20.2	-13
6.0	-75.76	-22.64	53.2	-29.5	-18
7.0	-75.76	-30.68	45.8	-37.3	-22
8.0	-75.76	-38.94	36.2	-45.2	-26
9.0	-75.76	-61.00	14.3	-66.2	-29
10.0	-75.76	-61.00	14.3	-66.7	-31
12.0	-75.76	-61.00	14.3	-66.7	-36
14.0	-75.76	-61.00	14.3	-66.7	-40
16.0	-75.76	-61.00	14.3	-66.7	-44
18.0	-75.76	-61.00	14.3	-66.7	-47
20.0	-75.76	-61.00	14.3	-66.7	-50
25.0	-75.76	-61.00	14.3	-66.7	-50
30.0	-75.76	-61.00	14.3	-66.7	-50
35.0	-75.76	-61.00	14.3	-66.7	-50
40.0	-75.76	-61.00	14.3	-66.7	-50
45.0	-75.76	-61.00	14.3	-66.7	-50
50.0	-75.76	-61.00	14.3	-66.7	-50

**Note:** Due to the difficulty of measuring the Frequency Response of the internal low-pass filter, the Frequency Response of All Modulation States is performed to show the roll-off at 3 KHz in comparison with the recommended audio filter attenuation.

The results shown in this test report refer only to the sample(s) tested unless otherwise stated and the sample(s) are retained for 30 days only. The document is issued by AGC, this document cannot be reproduced except in full with our prior written permission. The document is available on request and the brief information for its validation can be assessable and confirmed at <http://www.agc-cert.com/rzcx.asp>





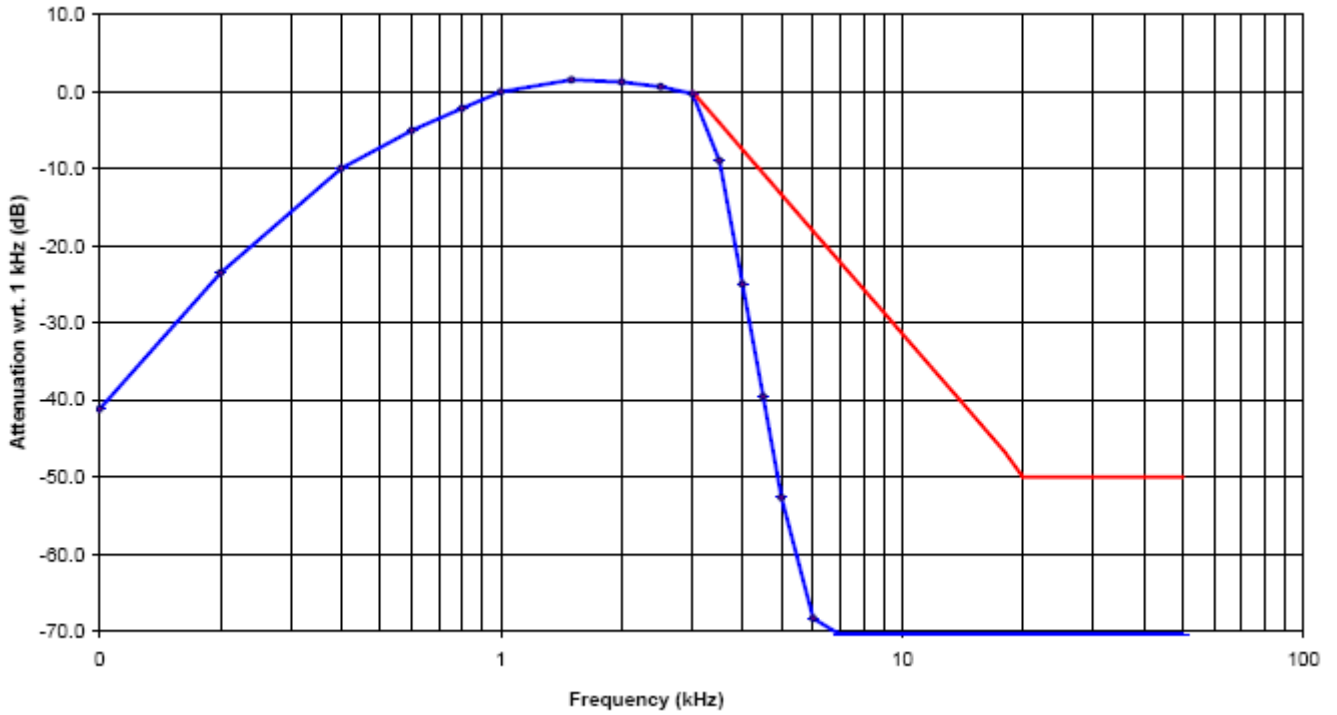

The results shown in this test report refer only to the sample(s) tested unless otherwise stated and the sample(s) are retained for 30 days only. The document is issued by AGC, this document cannot be reproduced except in full with our prior written permission. The document is available on request and the brief information for its validation can be assessable and confirmed at <http://www.agc-cert.com/rzcx.asp>

**APPENDIX I**  
**PHOTOGRAPHS OF SETUP**  
**RADIATED TEST SETUP**

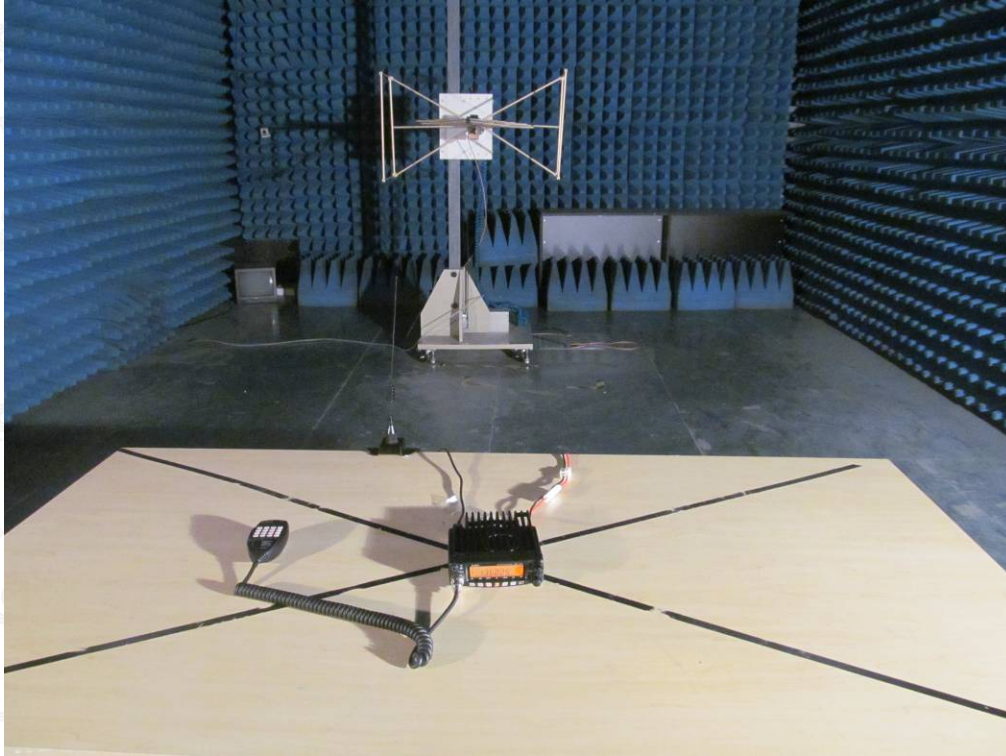

The results shown in this test report refer only to the sample(s) tested unless otherwise stated and the sample(s) are retained for 30 days only. The document is issued by AGC, this document cannot be reproduced except in full with our prior written permission. The document is available on request and the brief information for its validation can be assessable and confirmed at <http://www.agc-cert.com/rzcx.asp>



**APPENDIX II**  
**EXTERNAL VIEW OF EUT**  
**WHOLE VIEW OF EUT**



**TOP VIEW OF EUT**

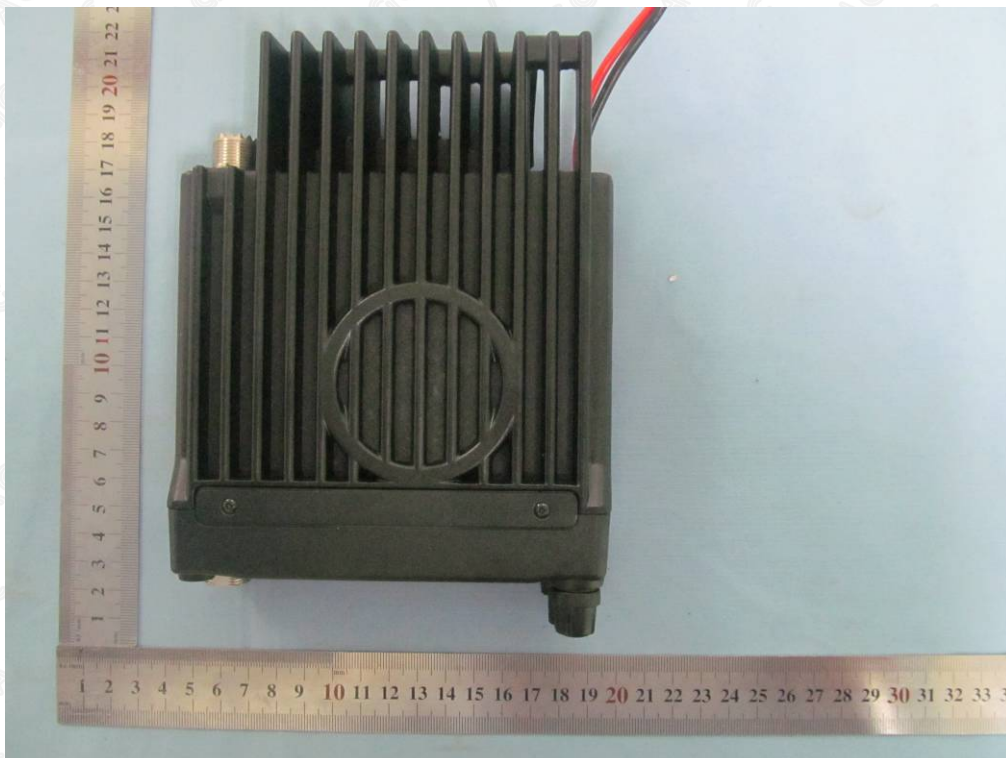

The results shown in this test report refer only to the sample(s) tested unless otherwise stated and the sample(s) are retained for 30 days only. The document is issued by AGC, this document cannot be reproduced except in full with our prior written permission. The document is available on request and the brief information for its validation can be assessable and confirmed at <http://www.agc-cert.com/rzcx.asp>



### BOTTOM VIEW OF EUT



### FRONT VIEW OF EUT



The results shown in this test report refer only to the sample(s) tested unless otherwise stated and the sample(s) are retained for 30 days only. The document is issued by AGC, this document cannot be reproduced except in full with our prior written permission. The document is available on request and the brief information for its validation can be assessable and confirmed at <http://www.agc-cert.com/rzcx.asp>

BACK VIEW OF EUT

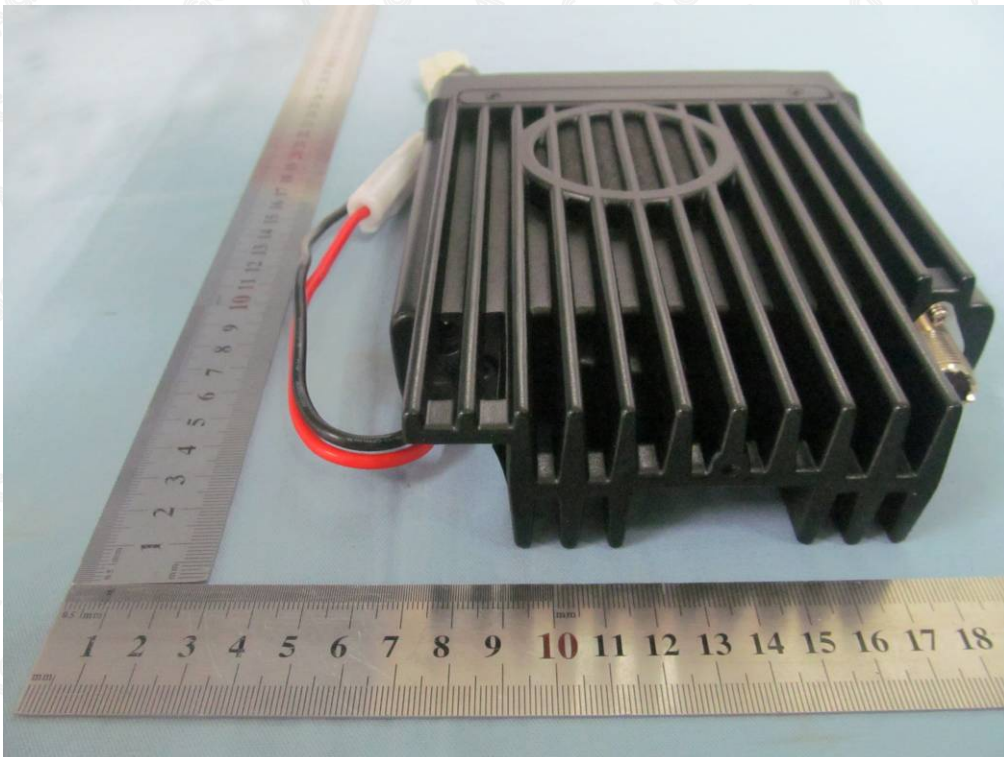

LEFT VIEW OF EUT



The results shown in this test report refer only to the sample(s) tested unless otherwise stated and the sample(s) are retained for 30 days only. The document is issued by AGC, this document cannot be reproduced except in full with our prior written permission. The document is available on request and the brief information for its validation can be assessable and confirmed at <http://www.agc-cert.com/rzcx.asp>



RIGHT VIEW OF EUT



OPEN VIEW-1 OF EUT

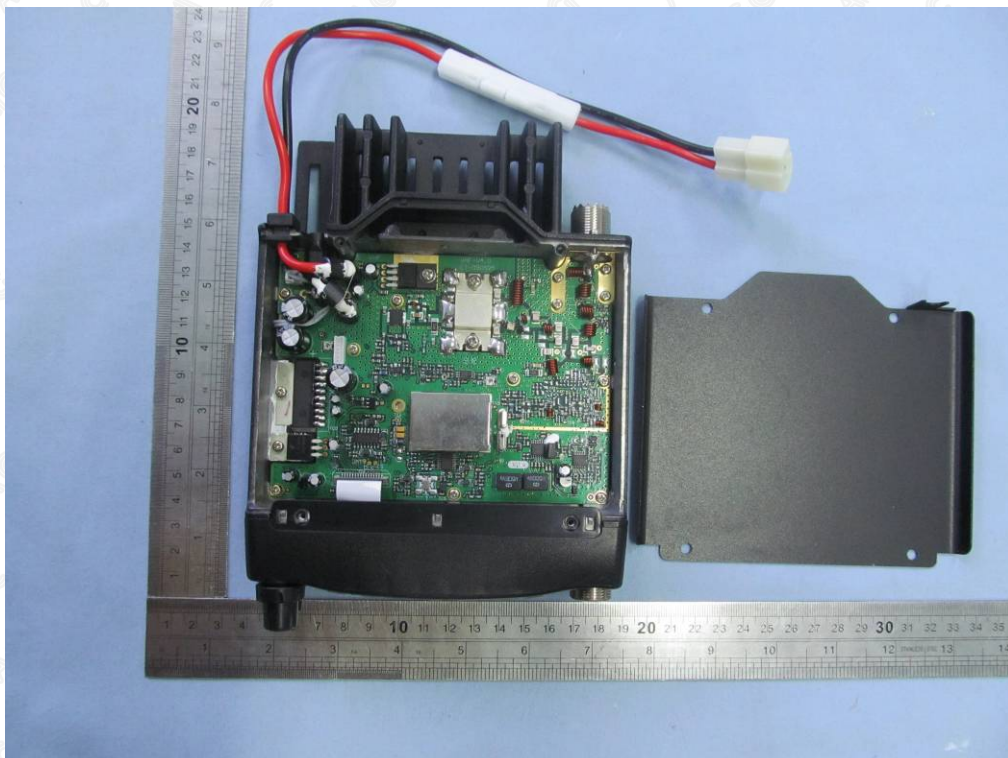

The results shown in this test report refer only to the sample(s) tested unless otherwise stated and the sample(s) are retained for 30 days only. The document is issued by AGC, this document cannot be reproduced except in full with our prior written permission. The document is available on request and the brief information for its validation can be assessable and confirmed at <http://www.agc-cert.com/rzcx.asp>



### OPEN VIEW-2 OF EUT

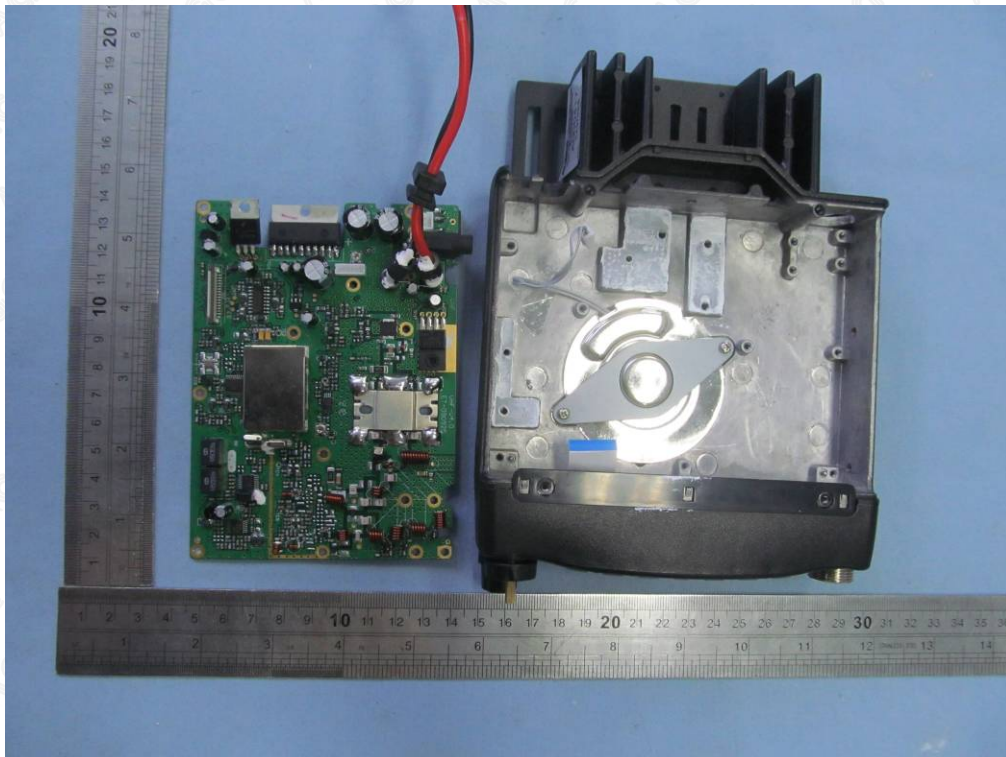

### INTERNAL VIEW-1 OF EUT

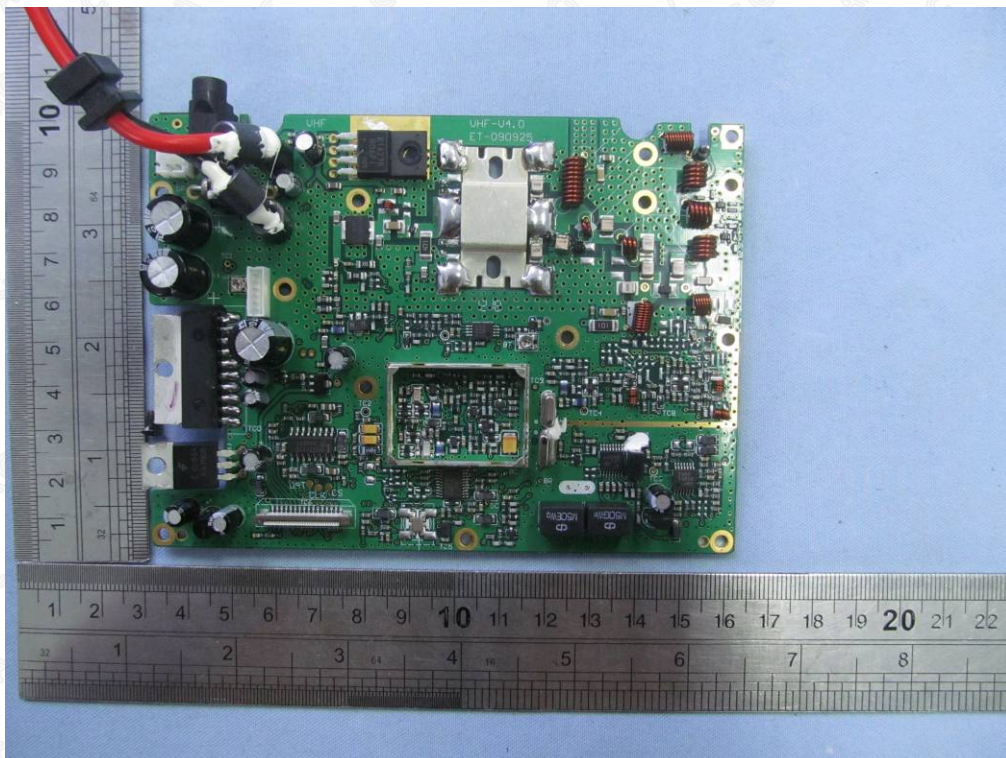

The results shown in this test report refer only to the sample(s) tested unless otherwise stated and the sample(s) are retained for 30 days only. The document is issued by AGC, this document cannot be reproduced except in full with our prior written permission. The document is available on request and the brief information for its validation can be assessable and confirmed at <http://www.agc-cert.com/rzcx.asp>



### INTERNAL VIEW-2 OF EUT

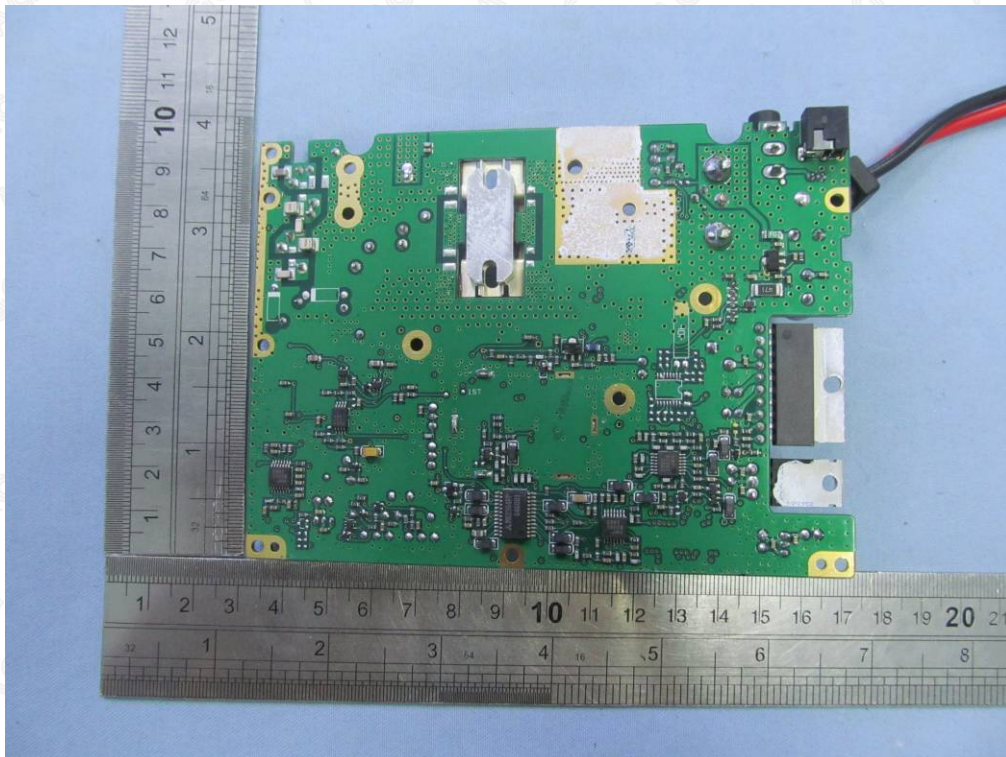

### INTERNAL VIEW-3 OF EUT

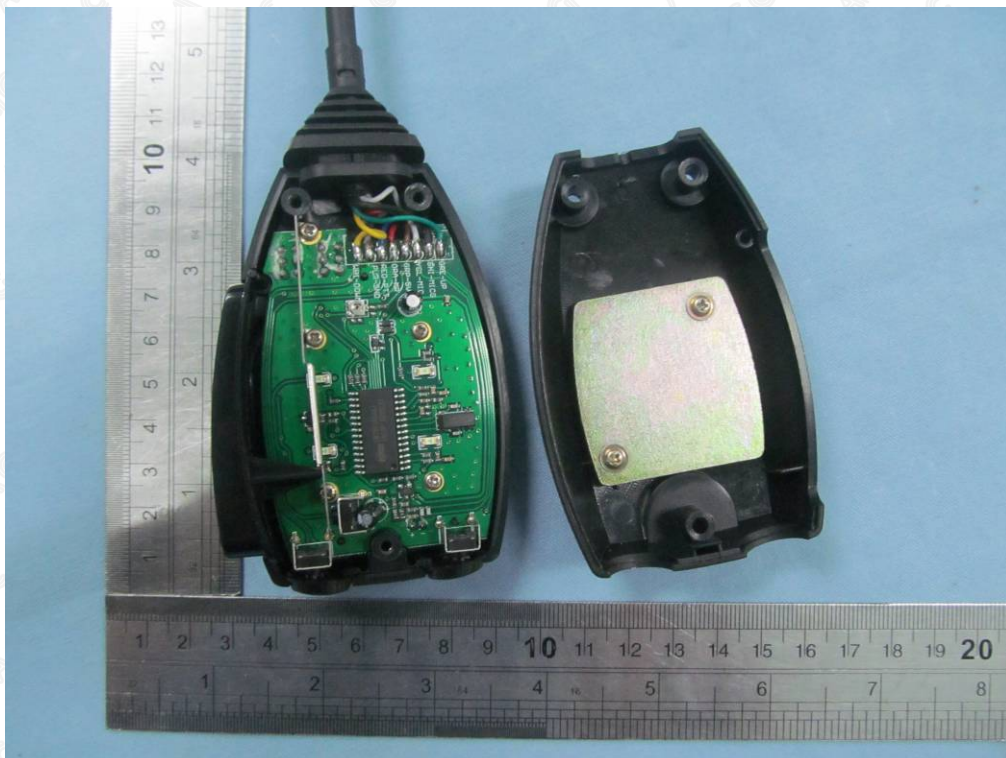

The results shown in this test report refer only to the sample(s) tested unless otherwise stated and the sample(s) are retained for 30 days only. The document is issued by AGC, this document cannot be reproduced except in full with our prior written permission. The document is available on request and the brief information for its validation can be assessable and confirmed at <http://www.agc-cert.com/rzcx.asp>



### INTERNAL VIEW-4 OF EUT

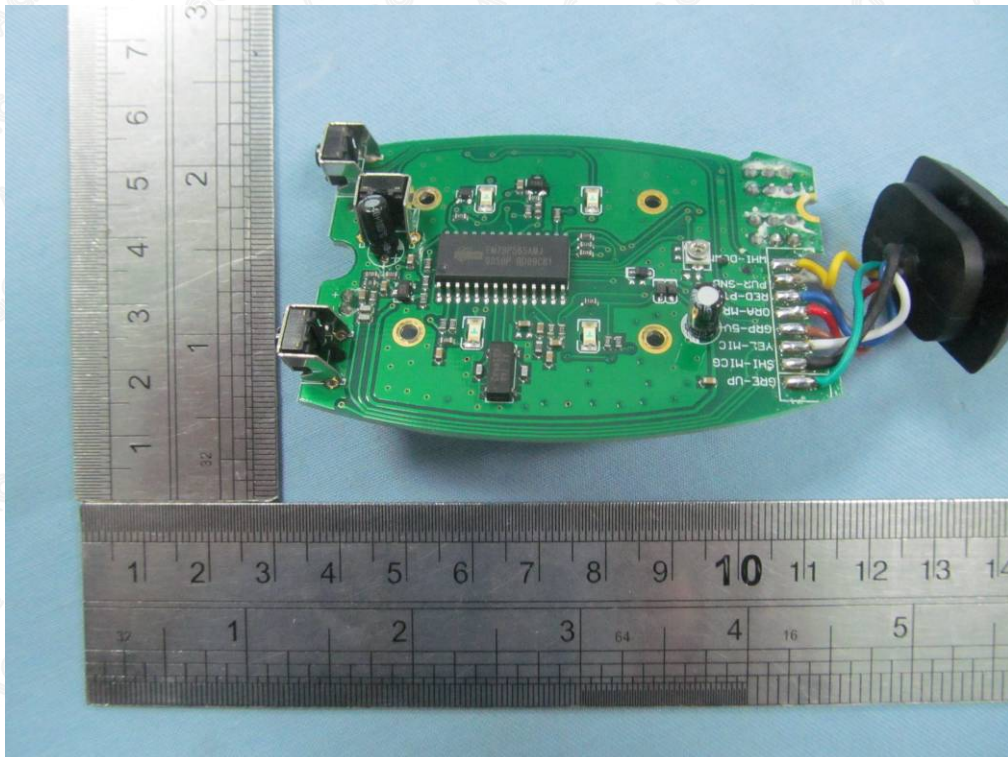

### INTERNAL VIEW-5 OF EUT

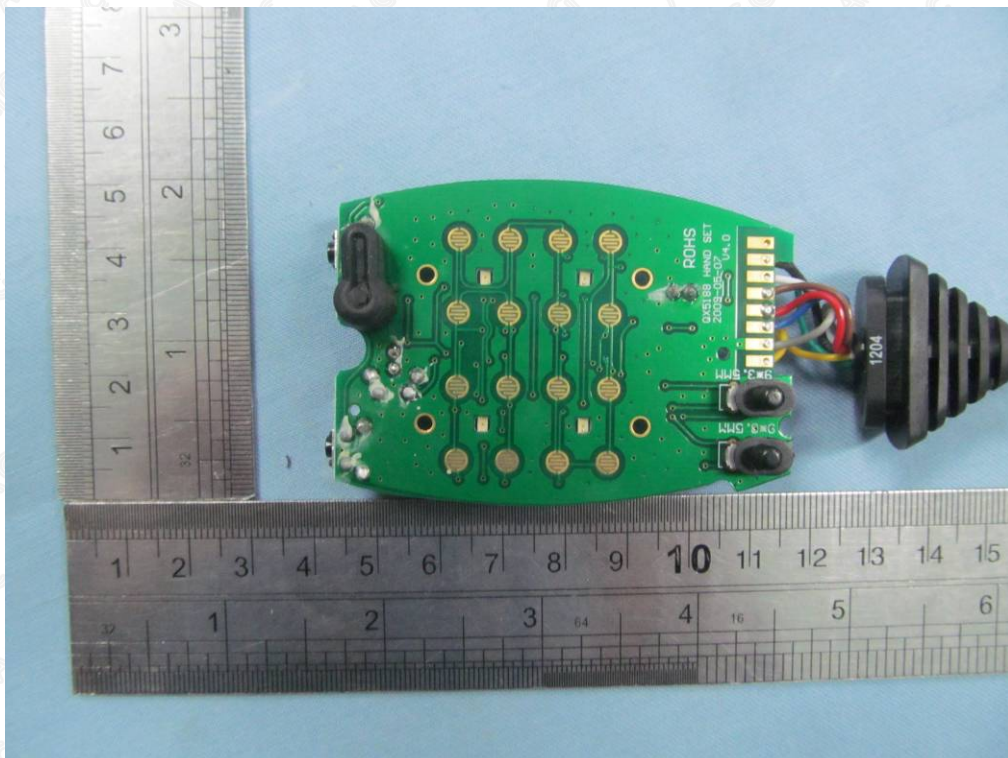

The results shown in this test report refer only to the sample(s) tested unless otherwise stated and the sample(s) are retained for 30 days only. The document is issued by AGC, this document cannot be reproduced except in full with our prior written permission. The document is available on request and the brief information for its validation can be assessable and confirmed at <http://www.agc-cert.com/rzcx.asp>



INTERNAL VIEW-6 OF EUT

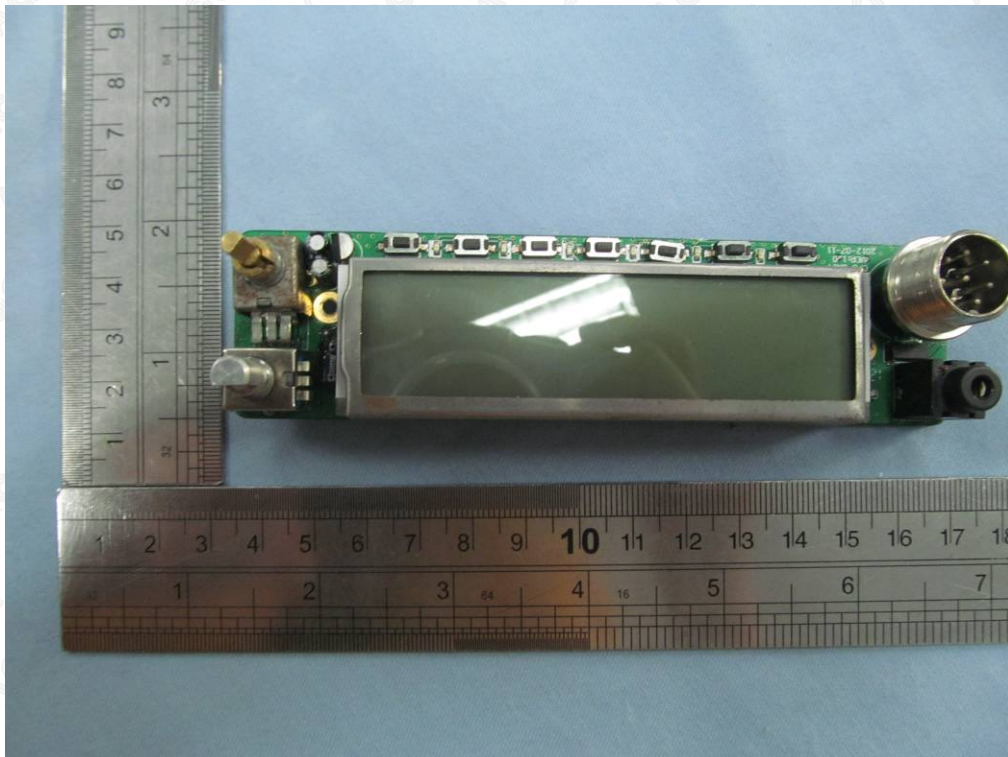

INTERNAL VIEW-7 OF EUT

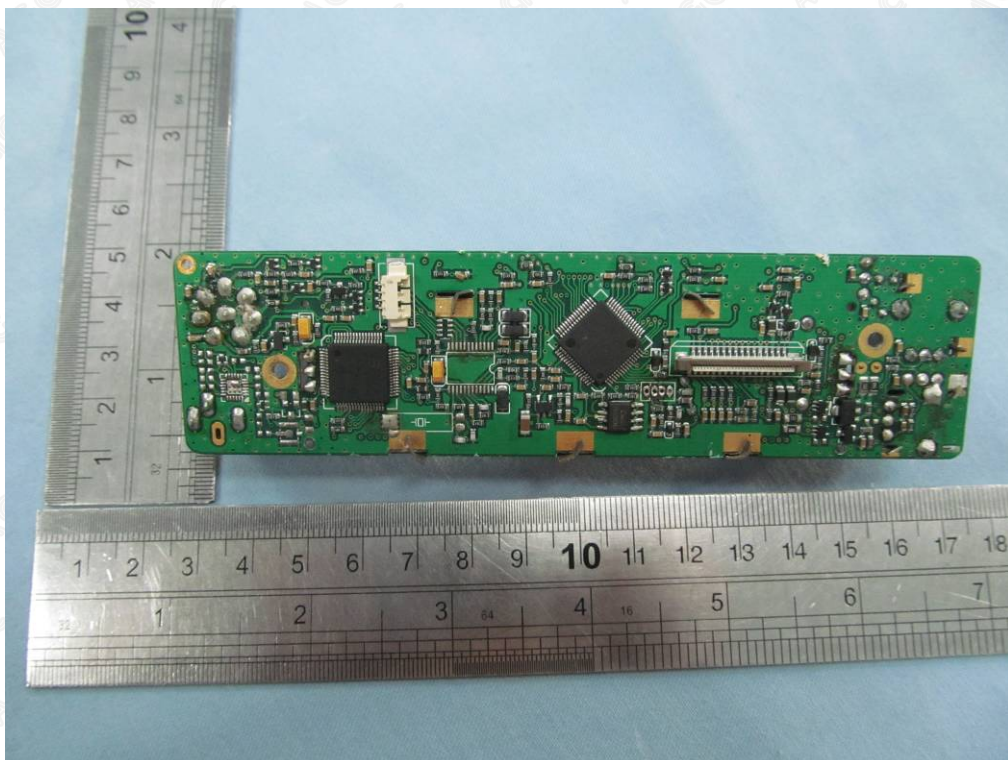

----END OF REPORT----

The results shown in this test report refer only to the sample(s) tested unless otherwise stated and the sample(s) are retained for 30 days only. The document is issued by AGC, this document cannot be reproduced except in full with our prior written permission. The document is available on request and the brief information for its validation can be assessable and confirmed at <http://www.agc-cert.com/rzcx.asp>