



TÜVRheinland[®]
Precisely Right.

Emissions Test Report

EUT Name: Wireless ADSL Residential Gateway

Model No.: HomePortal 4011G/4010G

CFR 47 Part 15.247:2008 and RSS 210:2007

Prepared for:

Mark Rieger
2Wire, Inc.
310 Providence Mine Road
Nevada City, CA 95959
Tel: (530) 274-5440
Fax: (530) 273-6340

Prepared by:

TUV Rheinland of North America, Inc.
1279 Quarry Lane
Pleasanton, CA 94566
Tel: (925) 249-9123
Fax: (925) 249-9124
<http://www.tuv.com/>

Report/Issue Date: October 8 2009

Report Number: 30952981.001

Statement of Compliance

Manufacturer: 2Wire, Inc.
310 Providence Mine Road
Nevada City, CA 95959
(530) 274-5440

Requester / Applicant: Mark Rieger
Name of Equipment: Wireless ADSL Residential Gateway
Model No. HomePortal 4011G/4010G
Type of Equipment: Intentional Radiator
Application of Regulations: CFR 47 Part 15.247:2008 and RSS 210:2007
Test Dates: 22 September 2009 to 7 October 2009

Guidance Documents:

Emissions: AN C63.4: 2003

Test Methods:

Emissions: AN C63.4: 2003

The electromagnetic compatibility test and documented data described in this report has been performed and recorded by TUV Rheinland, in accordance with the standards and procedures listed herein. As the responsible authorized agent of the EMC laboratory, I hereby declare that the equipment described above has been shown to be compliant with the EMC requirements of the stated regulations and standards based on these results. If any special accessories and/or modifications were required for compliance, they are listed in the Executive Summary of this report.

This report must not be used to claim product endorsement by NVLAP or any agency of the U.S. Government. This report contains data that are not covered by NVLAP accreditation. This report shall not be reproduced except in full, without the written authorization of TUV Rheinland of North America.



Jeremy Luong 7 October 2009
Test Engineer Date

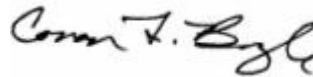

Conan Boyle 17 December 2009
NVLAP Signatory Date



NVLAPCODE 500011-0



US5254

Industry Canada

2932M-1

Table of Contents

1	Executive Summary	6
1.1	Scope	6
1.2	Purpose	6
1.3	Summary of Test Results	6
1.4	Special Accessories	7
1.5	Equipment Modifications	7
2	Laboratory Information	8
2.1	Accreditations & Endorsements	8
2.1.1	US Federal Communications Commission	8
2.1.2	NIST / NVLAP	8
2.1.3	Canada – Industry Canada	8
2.1.4	Japan – VCCI	8
2.1.5	Acceptance by Mutual Recognition Arrangement	8
2.2	Test Facilities	9
2.2.1	Emission Test Facility	9
2.2.2	Immunity Test Facility	9
2.3	Measurement Uncertainty	9
2.4	Calibration Traceability	10
3	Product Information	11
3.1	Product Description	11
3.2	Equipment Configuration	11
3.3	Operating Mode	11
3.4	Unique Antenna Connector	12
3.4.1	Results	12
4	Emissions	13
4.1	Output Power Requirements	13
4.1.1	Test Method	13
4.1.2	Results	14
4.2	Occupied Bandwidth	21
4.2.1	Test Method	21
4.2.2	Results	22
4.3	Band Edge Requirements	35
4.4	Peak Power Spectral Density	59
4.4.1	Test Method	59
4.4.2	Results	60
4.5	Maximum Permissible Exposure	67
4.5.1	Test Methodology	67
4.5.2	RF Exposure Limit	67
4.5.3	EUT Operating Condition	67
4.5.4	Classification	68

Table of Contents

4.5.5	Test Results	68
4.5.6	Sample Calculation	68
4.6	Transmitter Spurious Emissions	69
4.6.1	Test Methodology	69
4.6.2	Transmitter Spurious Emission Limit	70
4.6.3	Test Results	70
4.6.4	Sample Calculation	79
4.7	Receiver Spurious Emissions	80
4.7.1	Test Methodology	80
4.7.2	Receiver Spurious Emission Limit	81
4.7.3	Test Results	81
4.8	AC Conducted Emissions	86
4.8.1	Test Methodology	86
4.8.2	Test Results	86
5	Test Equipment List	91
5.1	Equipment List	91
	<i>* Calibration of equipment past due for re-calibration will be performed expeditiously. If any equipment is found to be out of tolerance at that time, affected customers will be notified accordingly.</i>	91
6	EMC Test Plan	92
6.1	Introduction	92
6.2	Customer	92
6.3	Equipment Under Test (EUT)	93
6.4	Test Specifications	95

Index of Tables

Table 1: Summary of Test Results	6
Table 2: Summary of Uncertainties	10
Table 3: RF Power – Test Results.....	14
Table 4: Occupied Bandwidth – Test Results	22
Table 5: Band-Edge Requirements – Test Results.....	35
Table 6: Out of band Emission – Test Results.....	36
Table 7: Peak Power Spectral Density – Test Results	60
Table 8: AC Conducted Emissions – Test Results.....	86
Table 9: Customer Information.....	92
Table 10: Technical Contact Information	92
Table 11: EUT Specifications	93
Table 12: Interface Specifications.....	93
Table 13: Supported Equipment.....	94
Table 14: Description of Sample used for Testing.....	94
Table 15: Description of Test Configuration used for Radiated Measurement.	94
Table 16: EUT Designation	95

1 Executive Summary

1.1 Scope

This report is intended to document the status of conformance with the requirements of the CFR 47 Part 15.247:2008 and RSS 210:2007 based on the results of testing performed on 22 September 2009 through 7 October 2009 on the Wireless ADSL Residential Gateway Model HomePortal 4011G/4010G manufactured by 2Wire, Inc.. This report only applies to the specific samples tested under the stated test conditions. It is the responsibility of the manufacturer to assure that additional production units of this model are manufactured with identical or EMI equivalent electrical and mechanical components. This report is further intended to document changes and modifications to the EUT throughout its life cycle. All documentation will be included as a supplement.

1.2 Purpose

Testing was performed to evaluate the EMC performance of the EUT in accordance with the applicable requirements, procedures, and criteria defined in the application of regulations and application of standards listed in this report.

1.3 Summary of Test Results

Table 1: Summary of Test Results

Test	Test Method ANSI C63.4	Test Parameters (from Standard)	Result
Spurious Emission in Received Mode	CFR47 15.109, RSS-GEN Sect.7.2.3	Class B	Complied
Spurious Emission in Transmitted Mode	CFR47 15.209, RSS-GEN Sect.7.2.3	Class B	Complied
Restricted Bands of Operation	CFR47 15.205, RSS 210 Sect.2.6	Class B	Complied
AC Power Conducted Emission	CFR47 15.207, RSS-GEN Sect.7.2.2	Class B	Complied
Occupied Bandwidth	CFR47 15.247 (a2), RSS GEN Sect.4.4.1	500 kHz Minimum	Complied
Maximum Transmitted Power	CFR47 15.247 (b3), RSS 210 Sect. A.8.4	30 dBm w/ 6 dBi antenna	Complied
Peak Power Spectral Density	CFR47 15.247 (e), RSS 210 Sect. A.8.2	8 dBm/ 3 kHz.	Complied
Band Edge Measurement	CFR47 15.247 (d), RSS 210 Sect. A.8.5	20 dB	Complied
RF Exposure	CFR47 15.247 (i), 2.1091	General Population	Complied

1.4 *Special Accessories*

No special accessories were necessary in order to achieve compliance.

1.5 *Equipment Modifications*

None.

2 Laboratory Information

2.1 Accreditations & Endorsements

2.1.1 US Federal Communications Commission



TUV Rheinland of North America at 1279 Quarry Lane, Ste. A., Pleasanton, CA 94566, is accredited by the commission for performing testing services for the general public on a fee basis. These laboratory test facilities have been fully described in reports submitted to and accepted by the FCC (FRN # US5254). The laboratory scope of accreditation includes: Title 47 CFR Parts 15, 18, and 90. The accreditation is updated every 3 years.

2.1.2 NIST / NVLAP



TUV Rheinland of North America is accredited by the National Voluntary Laboratory Accreditation Program, which is administered under the auspices of the National Institute of Standards and Technology. The laboratory has been assessed and accredited in accordance with ISO Guide 17025:2005 and ISO 9002 (Lab Code 500011-0). The scope of laboratory accreditation includes emission and immunity testing. The accreditation is updated annually.

2.1.3 Canada – Industry Canada



TUV Rheinland of North America at the 1279 Quarry Ln, Pleasanton, CA 94566 address is accredited by Industry Canada for performing testing services for the general public on a fee basis. This laboratory test facilities have been fully described in reports submitted to and accepted by Industry Canada (File Number 2932M-1). This reference number is the indication to the Industry Canada Certification Officers that the site meets the requirements of RSS 212, Issue 1 (Provisional). The accreditation is updated every 3 years.

2.1.4 Japan – VCCI



The Voluntary Control Council for Interference by Information Technology Equipment (VCCI) is a group that consists of Information Technology Equipment (ITE) manufacturers and EMC test laboratories. The purpose of the Council is to take voluntary control measures against electromagnetic interference from Information Technology Equipment, and thereby contribute to the development of a socially beneficial and responsible state of affairs in the realm of Information Technology Equipment in Japan. TUV Rheinland of North America at 1279 Quarry Lane, Pleasanton, CA 94566 has been assessed and approved in accordance with the Regulations for Voluntary Control Measures. (Registration No. R-2366, C-2585, C-2586).

2.1.5 Acceptance by Mutual Recognition Arrangement



The United States has an established agreement with specific countries under the Asia Pacific Laboratory Accreditation Corporation (APLAC) Mutual Recognition Arrangement. Under this agreement, all TUV Rheinland at 1279 Quarry Lane, Pleasanton, CA 94566 test results and test reports within the scope of the laboratory

NIST / NVLAP accreditation will be accepted by each member country.

2.2 Test Facilities

All of the test facilities are located at 1279 Quarry Lane, Ste. A, Pleasanton, California 94566, USA. The 2305 Mission College, Santa Clara, 95054, USA location is considered a Pleasanton annex.

2.2.1 Emission Test Facility

The Semi-Anechoic chamber and AC Line Conducted measurement facility used to collect the radiated and conducted data has been constructed in accordance with ANSI C63.7:1992. The site has been measured in accordance with and verified to comply with the theoretical normalized site attenuation requirements of ANSI C63.4:2003, at test distances of 3 and 5 meters. This site has been described in reports dated May 12, 1997, submitted to the FCC, and accepted by letter dated June 25, 1997 (31040/SIT 1300F2). The site is listed with the FCC and accredited by NVLAP (Lab Code 500011-0). The 5-meter semi-anechoic chamber used to collect the radiated data has been verified to comply with the theoretical normalized site attenuation requirements of ANSI C63.4:2003, at test distances of 3 meter and 5 meters. A report detailing this site can be obtained from TUV Rheinland of North America.

2.2.2 Immunity Test Facility

ESD, EFT, Surge, PQF: These tests are performed in an environmentally controlled room with a 3.7 m x 4.8 m x 3.175 mm thick aluminum floor connected to PE ground.

For ESD testing, tabletop equipment is placed on an insulated mat with a surface resistivity of 10^9 Ohms/square on a 1.6 m x 0.8 m x 0.8 m high non-conductive table with a 3.175 mm aluminum top (Horizontal Coupling Plane). The HCP is connected to the main ground plane via a low impedance ground strap through two 470-k Ω resistors. The Vertical Coupling Plane consists of an aluminum plate 50 cm x 50 cm x 3.175 mm thick. The VCP is connected to the main ground plane via a low impedance ground strap through two 470-k Ω resistors.

For EFT, Surge, PQF, the HCP and VCP are removed.

RF Field Immunity testing is performed in a 7.3m x 4.3m x 4.1m anechoic chamber.

RF Conducted and Magnetic Field Immunity testing is performed on a 4.8m x 3.7m x 3.175mm thick aluminum ground plane.

All test areas allow a minimum distance of 1 meter from the EUT to walls or conducting objects.

2.3 Measurement Uncertainty

Two types of measurement uncertainty are expressed in this report, per *ISO Guide To The Expression Of Uncertainty In Measurement*, 1st Edition, 1995.

The Combined Standard Uncertainty is the standard uncertainty of the result of a measurement when that result is obtained from the values of a number of other quantities; it is equal to the positive square root of the sum of the variances or co-variances of these other quantities, weighted according to how the measurement result varies with changes in these quantities. The term *standard uncertainty* is the result of a measurement expressed as a standard deviation.

The *Expanded Uncertainty* defines an interval about the result of a measurement that may be expected to encompass a large fraction of the distribution of values that could reasonably be attributed to the measurand. The fraction may be viewed as the coverage probability or level of confidence of the interval.

Table 2: Summary of Uncertainties

Test	System	Combined Standard Uncertainty
Conducted Emissions	LISN, spectrum analyzer, coaxial cables, and pads	± 1.2 dB
Radiated Emissions	antenna, spectrum analyzer, pre-amplifier, coaxial cables, and pads	± 1.6 dB
Radiated Immunity	antenna, amplifier, cables, signal generator field probe, and spectrum analyzer	± 2.7 dB
Conducted Immunity	coupling/decoupling device, amplifier, cables, signal generator, and spectrum analyzer	± 1.5 dB
Voltage Dips, Drops, and Interruptions	AC power source and interruptions generator	± 4.3 dB
Electrical Fast Transient Immunity	AC power output source and fast transient generator	± 5.8 dB
Lightning Surge Immunity	AC power output source and lightning surge generator	± 8.0 dB
Electrostatic Discharge Immunity	air and contact discharge generators	± 4.1 dB
Power Frequency Magnetic Field Immunity	AC voltage source	± 0.58 dB
Damped Oscillatory Wave Immunity	AC power output source and oscillatory wave generator	± 8.7 dB
Harmonic Current and Voltage Flicker	AC power source and detection devices	± 11.6 dB

The expanded uncertainty at a level of 95% confidence is obtained by multiplying the combined standard uncertainty by a coverage factor of 2. Compliance criteria are not based on measurement uncertainty.

2.4 Calibration Traceability

All measurement instrumentation is traceable to the National Institute of Standards and Technology (NIST). The measurement method complies with ANSI/NCSL Z540-1-1994 and ISO Standard 17025:2005.

3 Product Information

3.1 Product Description

The HomePortal 4011G/4010G is a Wireless ADSL Residential Gateway. This features:

- 1 ADSL (Ethernet) Broadband Modem Port
- 4 Ethernet Ports (1 Ethernet Port on 4010G)
- 802.11b/g Wireless Access Point

3.2 Equipment Configuration

A description of the equipment configuration is given in Table 14 and Table 15. The EUT was tested as called for in the test standard and was configured and operated in a manner consistent with its intended use. The EUT was connected to rated power and allowed to reach intended operating conditions. The placement of the EUT system components was guided by the test standard and selected to represent typical installation conditions.

In the case of an EUT that can operate in more than one configuration, preliminary testing was performed to determine the configuration that produced maximum radiation.

The final configuration was selected to produce the worst case radiation for emissions testing and to place the EUT in the most susceptible state for immunity testing.

3.3 Operating Mode

A description of the operation mode is given in Table 14 and Table 15. In the case of an EUT that can operate in more than one state, preliminary testing was performed to determine the operating mode that produced maximum radiation.

The final operating mode was selected to produce the worst case radiation for emissions testing and to place the EUT in the most susceptible state for immunity testing.

3.4 Unique Antenna Connector

An intentional radiator shall be designed to ensure that no antenna other than that furnished by the responsible party shall be used with the device. The use of a permanently attached antenna or of an antenna that uses a unique coupling to the intentional radiator shall be considered sufficient to comply with the provisions of this section. The manufacturer may design the unit so that a broken antenna can be replaced by the user, but the use of a standard antenna jack or electrical connector is prohibited. This requirement does not apply to carrier current devices or to devices operated under the provisions of CFR47 Parts 15.211, 15.213, 15.217, 15.219, or 15.221.

3.4.1 Results

The HomePortal 4011G/4010G uses the permanently attached antenna inside the device.

4 Emissions

Testing was performed in accordance with CFR 47 Part 15.247:2008 and RSS 210 Annex 8:2007. These test methods are listed under the laboratory's NVLAP Scope of Accreditation. This test measures the levels emanating from the EUT, thus evaluating the potential for the EUT to cause radio frequency interference to other electronic devices. Procedures described in Section 8 of the standard were used.

4.1 Output Power Requirements

The maximum peak output power requirement is the maximum equivalent isotropic radiated power delivering at the transmitting antenna under specified conditions of measurements in the presence of modulation.

The maximum output power and harmonics shall not exceed CFR47 Part 15.247 (b3):2008 and RSS 210 A.8.4

The maximum transmitted power is +30 dBm or 1 Watt.

4.1.1 Test Method

The conducted method was used to measure the channel power output.

The measurement was performed with modulation per CFR47 Part15.247 (b3):2008 and RSS 210 A.8.4. This test was conducted on 3 channels of Sample with MAC Address 00:25:3C:91:43:00. The worst sample result indicated below.

Test Setup:

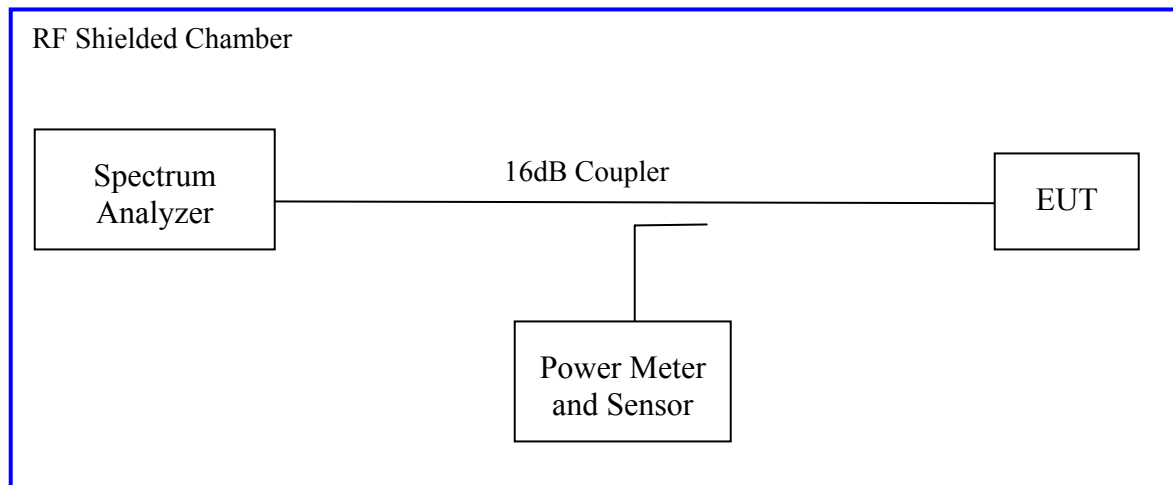

4.1.2 Results

As originally tested, the EUT was found to be compliant to the requirements of the test standard(s).

Table 3: RF Power – Test Results

Test Conditions: Conducted Measurement, Normal Temperature					
Antenna Type: Integrated			Power Setting: +20 dBm		
Max. Antenna Gain: 2.0 dBi			Signal State: Modulated		
Ambient Temp.: 23° C			Relative Humidity: 35%		
Test Results					
Operating Channel	Limit [dBm]	802.11b Output Level [dBm]	802.11b Margin [dB]	802.11g Output Level [dBm]	802.11g Margin [dB]
2412 MHz	+30.00	+23.77	-6.23	+25.73	-4.27
2437 MHz	+30.00	+23.67	-6.33	+25.54	-4.46
2462 MHz	+30.00	+23.77	-6.23	+23.38	-6.62

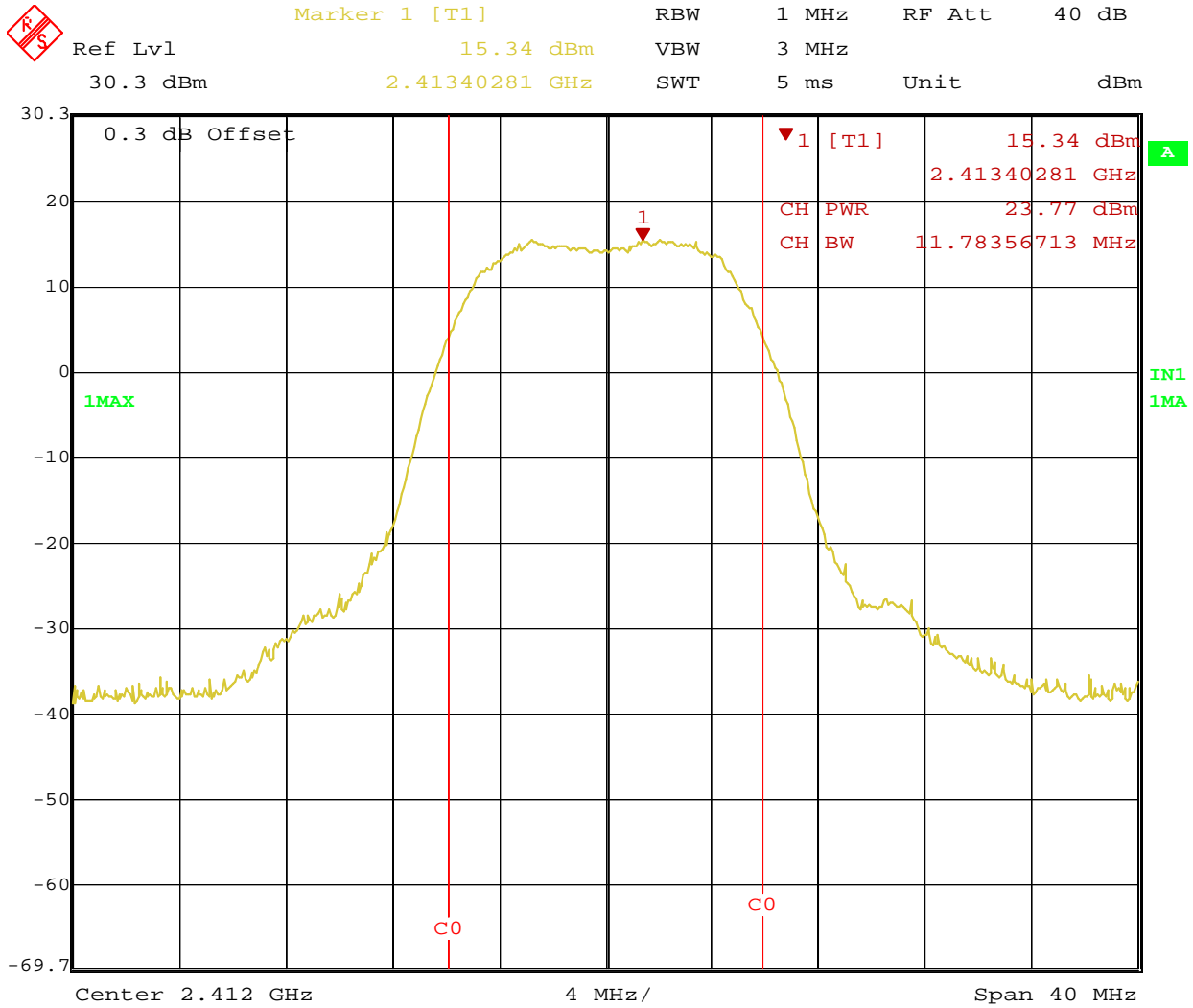

Date: 28.SEP.2009 18:38:37

Figure 1: Maximum Transmitted Power at Lowest Channel 2412 MHz – 802.11b Mode

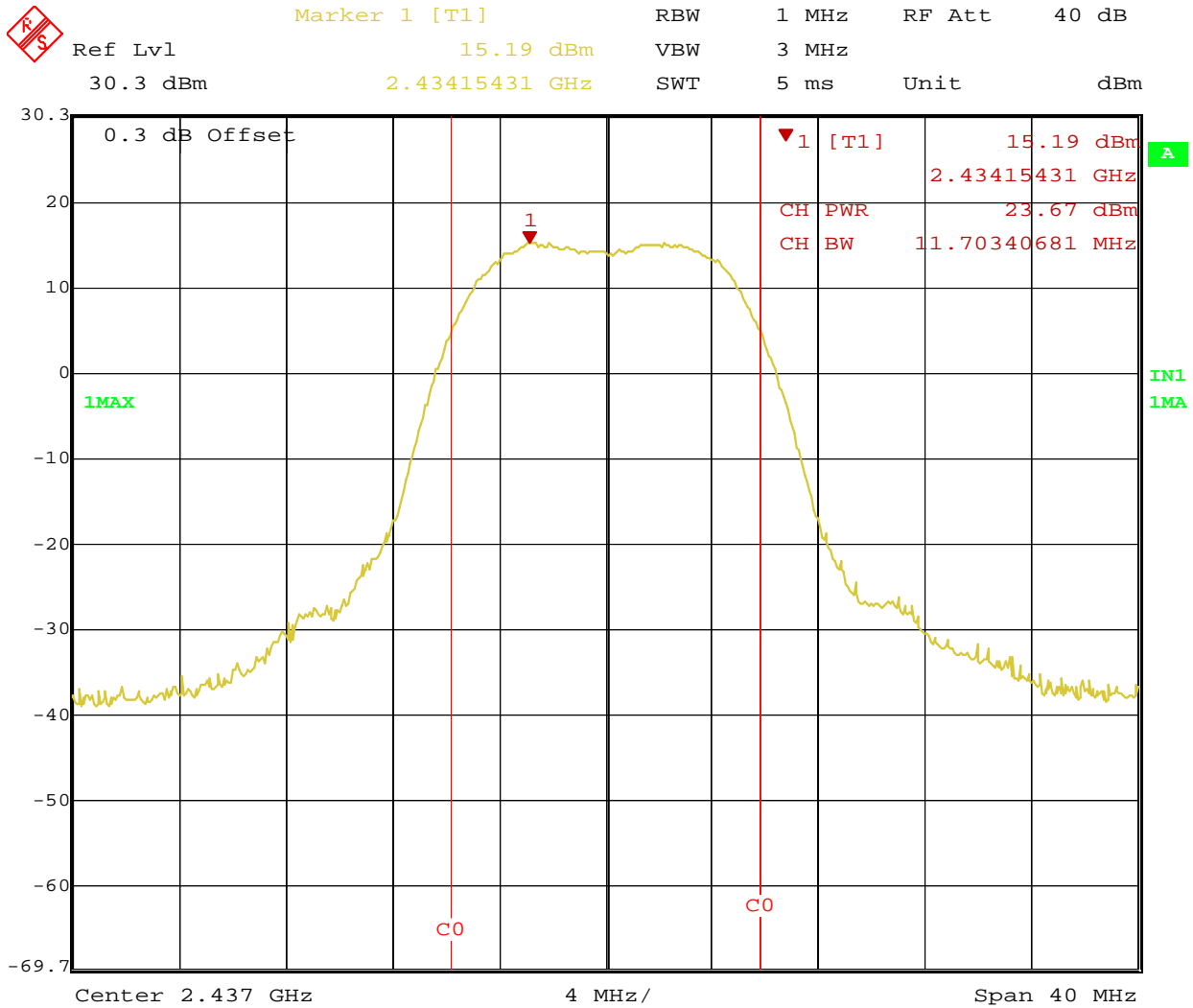

Date: 28.SEP.2009 18:40:22

Figure 2: Maximum Transmitted Power at Middle Channel 2437 MHz – 802.11b Mode

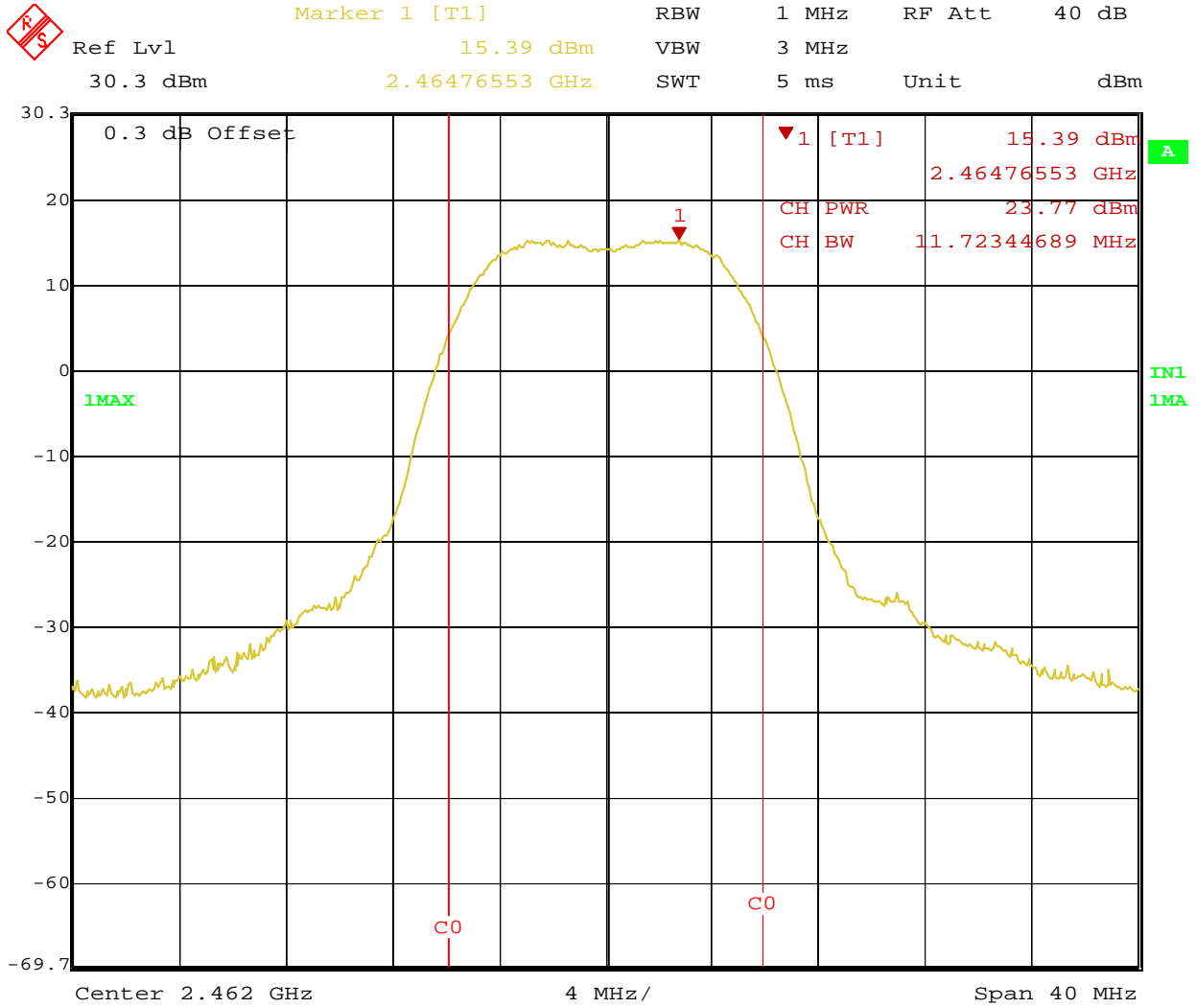

Date: 28.SEP.2009 18:42:23

Figure 3: Maximum Transmitted Power at Highest Channel 2462 MHz – 802.11b Mode

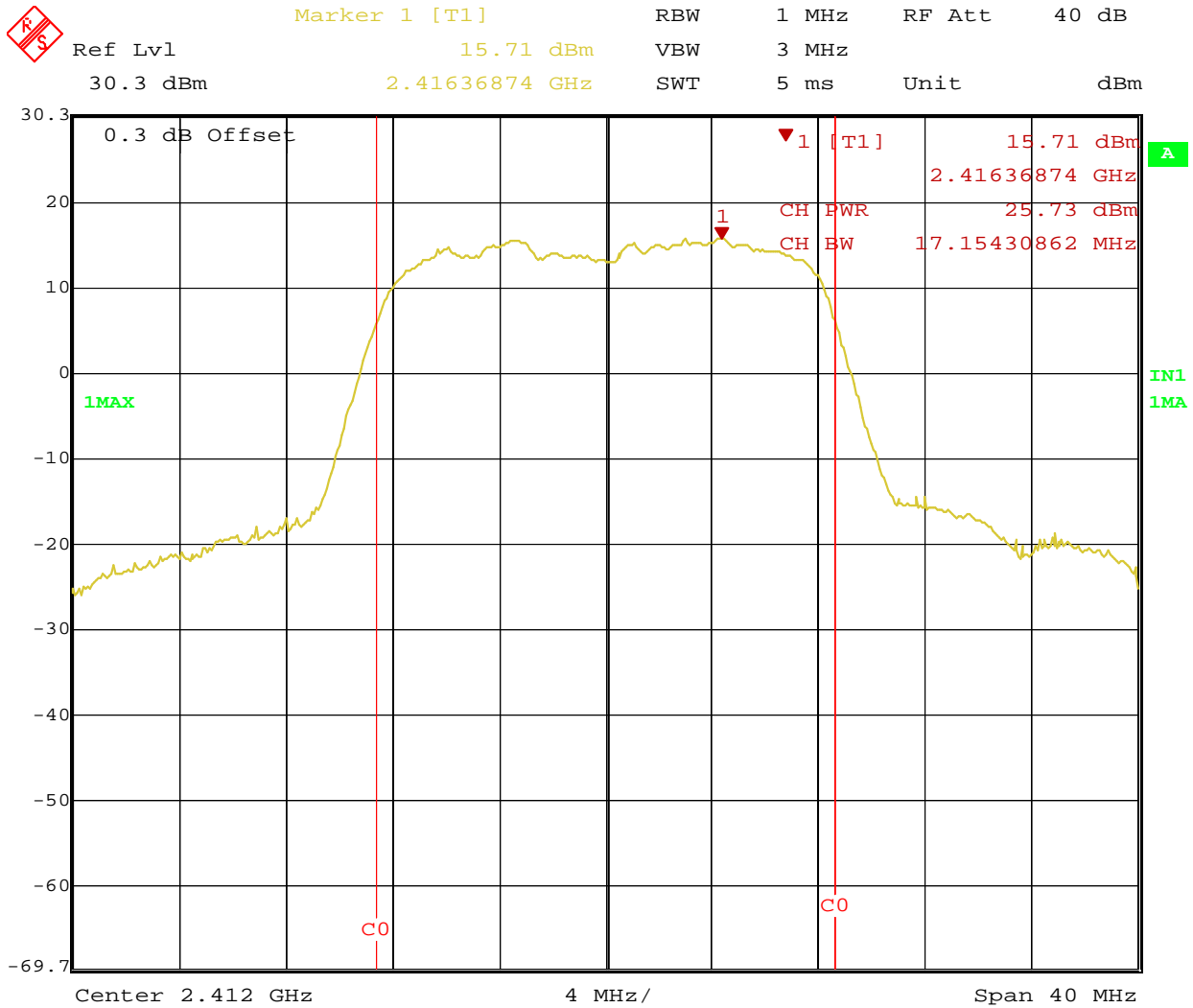

Date: 28.SEP.2009 18:48:00

Figure 4: Maximum Transmitted Power at Lowest Channel 2412 MHz – 802.11g Mode

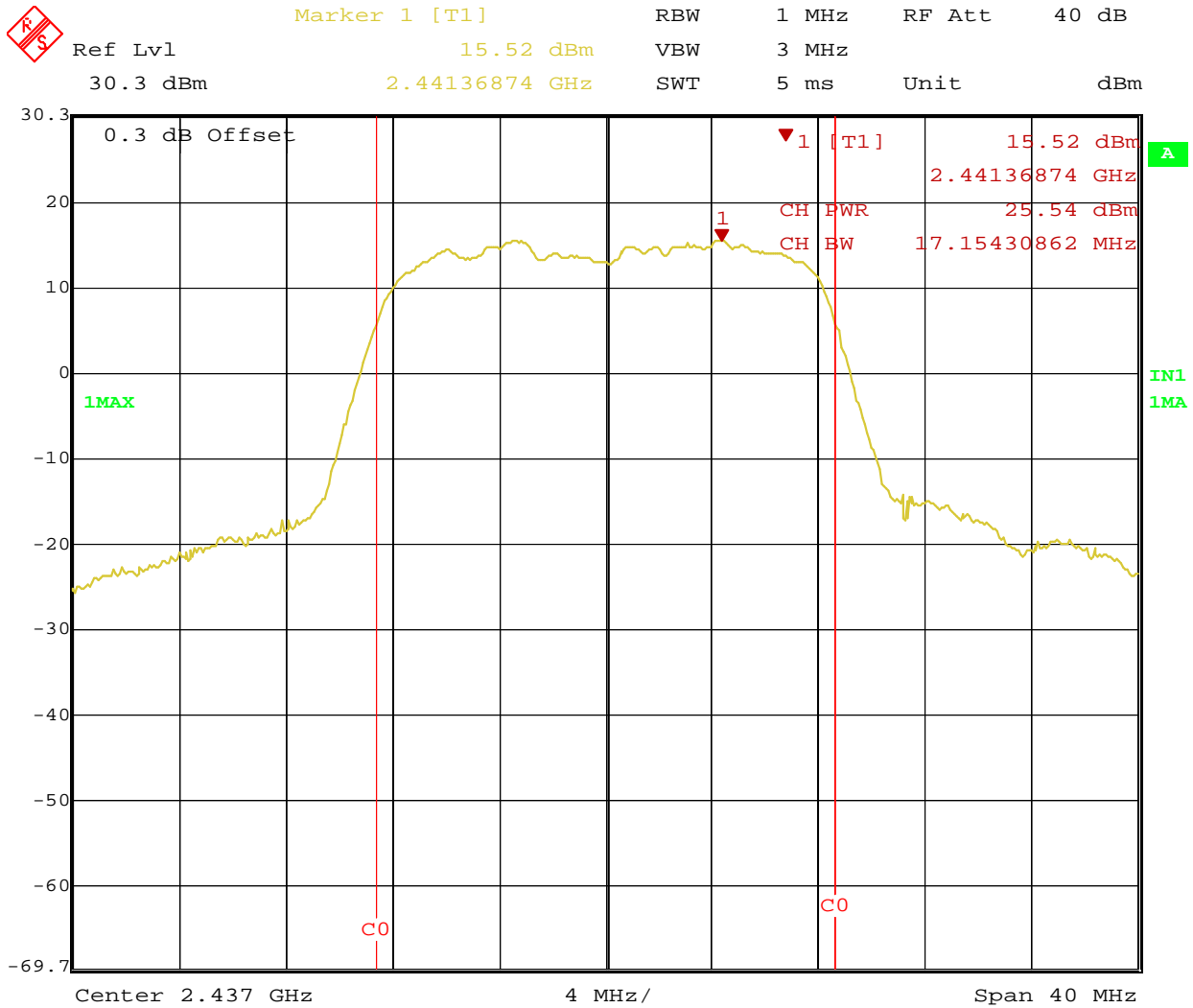

Date: 28.SEP.2009 18:50:54

Figure 5: Maximum Transmitted Power at Highest Channel 2437 MHz – 802.11g Mode

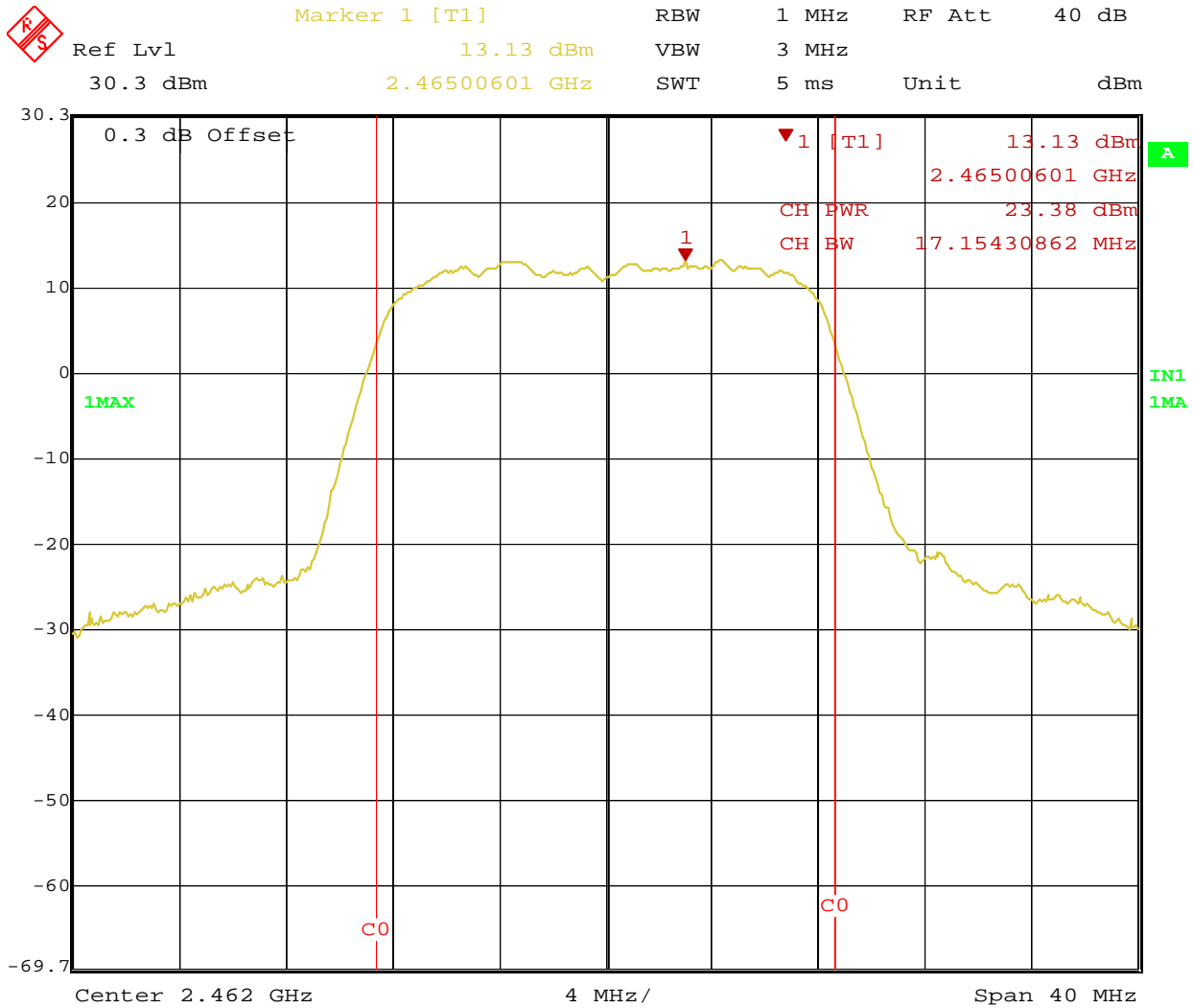

Date: 28.SEP.2009 18:57:21

Figure 6: Maximum Transmitted Power at Highest Channel 2462 MHz – 802.11g Mode

4.2 Occupied Bandwidth

The occupied bandwidth is measured at an amplitude level reduced from the reference level by a specified ratio. The reference level is the level of the highest amplitude signal observed from the transmitter at the fundamental frequency.

The 99% bandwidth is the bandwidth in which 99% of the transmitted power occupied.

The 6 dB bandwidth is defined the bandwidth of 6 dB from highest transmitted level of the fundamental frequency.

The bandwidth shall be at least 500 kHz per Section CFR47 15.247(a2) 2008 and RSS Gen Sect. 4.4.1.

4.2.1 Test Method

The conducted method was used to measure the channel power output.

The measurement was performed with modulation per CFR47 15.247(a2) 2008 and RSS Gen Sect. 4.4.1.

This test was conducted on 3 channels of Sample with MAC Address 00:25:3C:91:43:00. The worst sample result indicated below.

Test Setup:

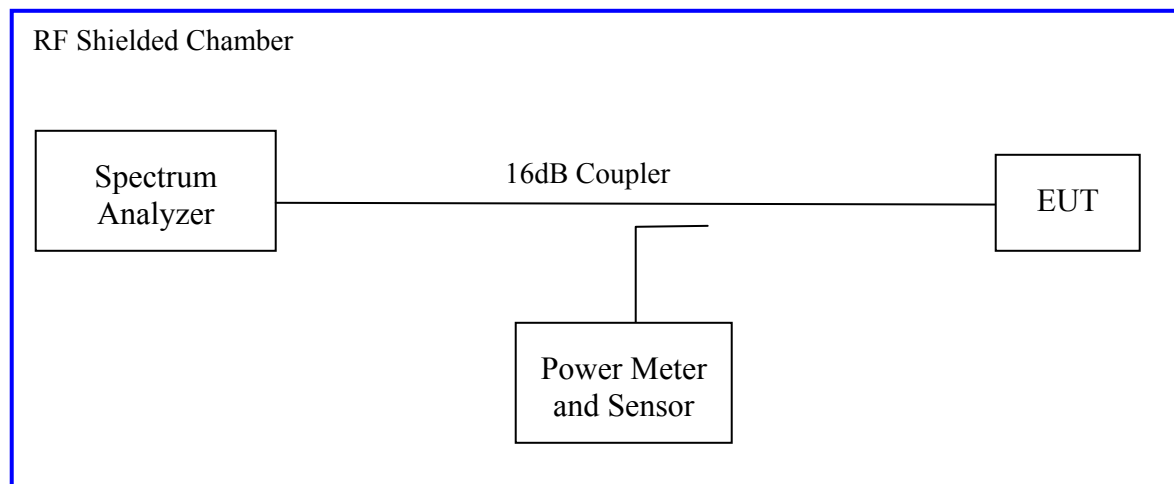

4.2.2 Results

As originally tested, the EUT was found to be compliant to the requirements of the test standard(s).

Table 4: Occupied Bandwidth – Test Results

Test Conditions: Conducted Measurement, Normal Temperature and Voltage only				
Antenna Type: Integrated		Power Setting: +20 dBm		
Max. Antenna Gain: 2 dBi		Signal State: Modulated		
Ambient Temp.: 23° C		Relative Humidity: 35%		
99% Bandwidth (MHz)				
Operating Channel	Limit	802.11b @ 1 Mbps	802.11g @ 6 Mbps	Results
2412 MHz	Na	10.74148297	16.31262525	Na
2437 MHz	Na	10.74148297	16.35270541	Na
2462 MHz	Na	10.70140281	16.35270541	Na
6dB Bandwidth (MHz)				
Operating Channel	Limit	802.11b @ 11 Mbps	802.11g @ 6 Mbps	Results
2412 MHz	500 kHz	9.05971944	16.11222445	Pass
2437 MHz	500 kHz	9.77955912	16.11222445	Pass
2462 MHz	500 kHz	10.02004000	16.35270541	Pass

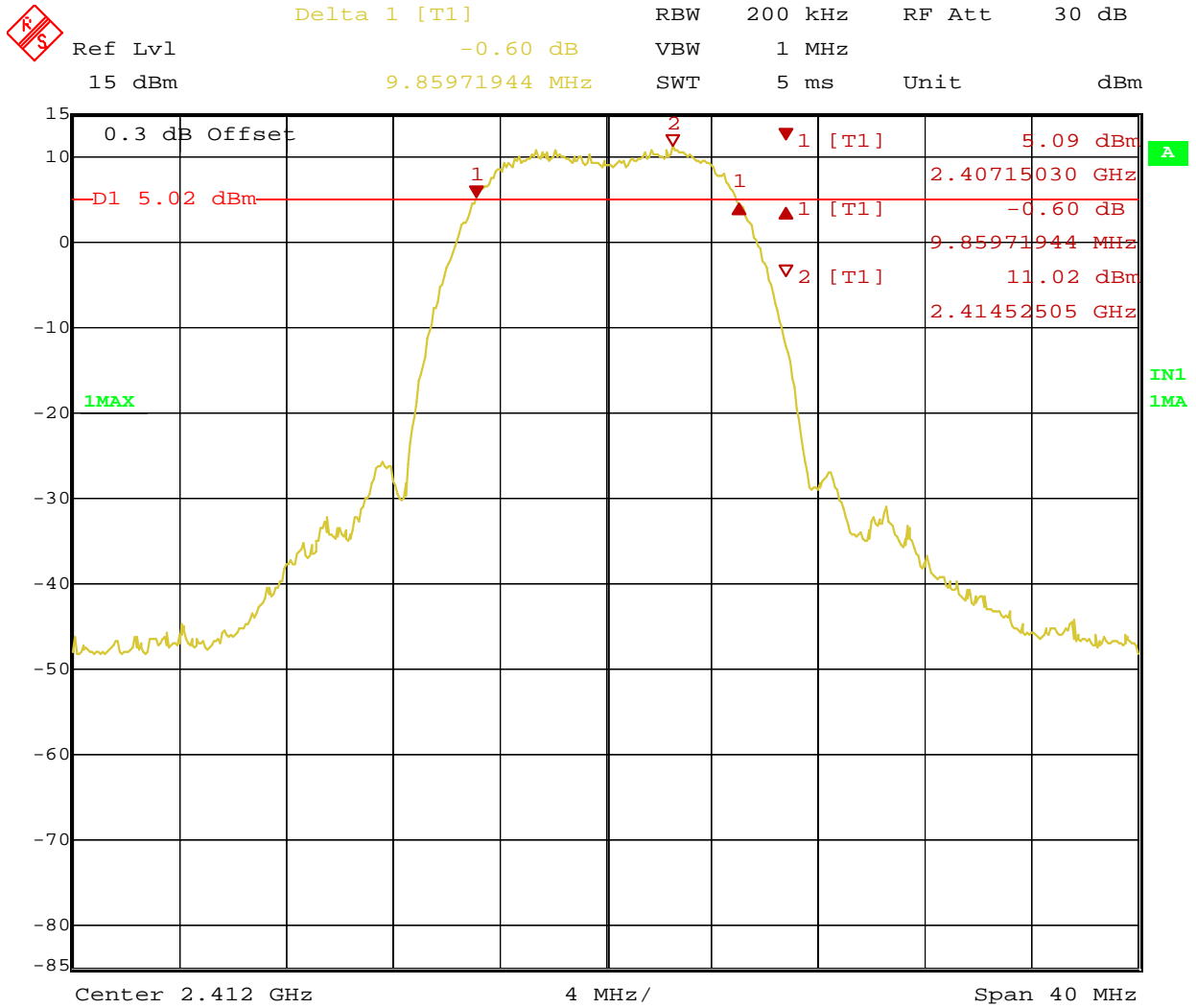
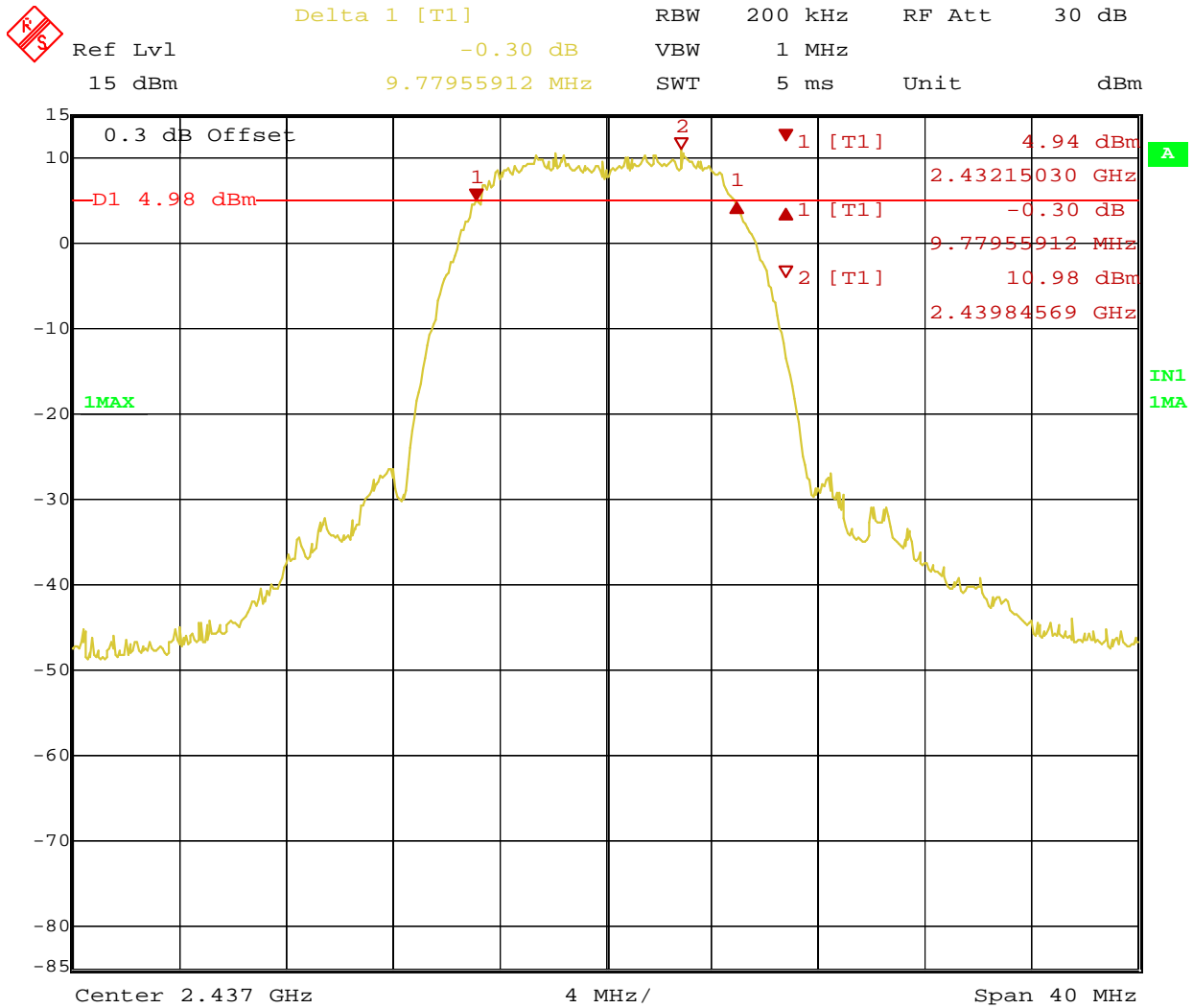
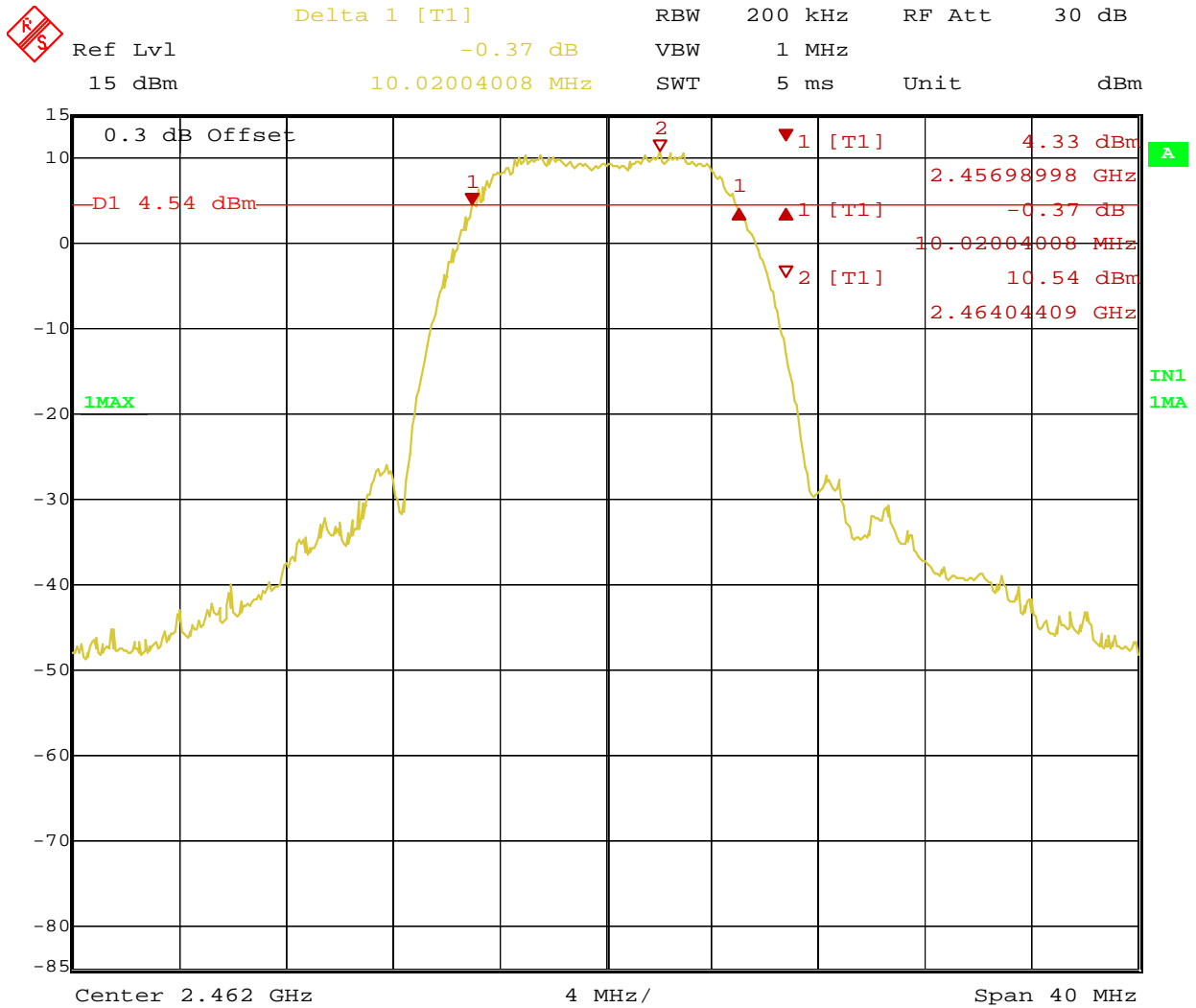

Figure 7: 6 dB Bandwidth at 11 Mbit/s – Operating Channel 2412 MHz



Date: 28.SEP.2009 15:48:11

Figure 8: 6 dB Bandwidth at 11 Mbit/s – Operating Channel 2437 MHz



Date: 28.SEP.2009 15:45:51

Figure 9: 6 dB Bandwidth at 11 Mbit/s – Operating Channel 2462 MHz

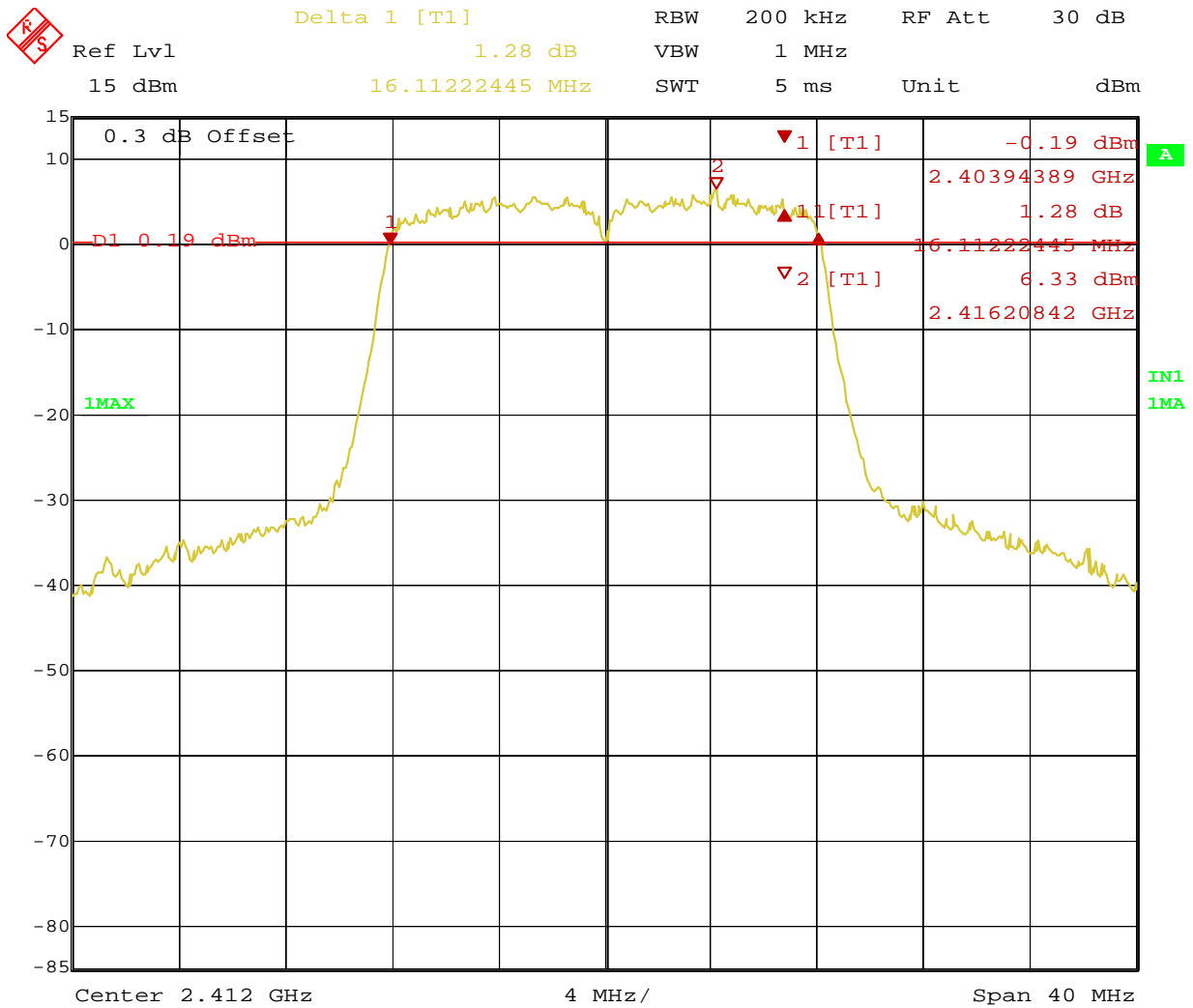

Date: 28.SEP.2009 17:34:08

Figure 10: 6 dB Bandwidth at 6 Mbit/s – Operating Channel 2412 MHz

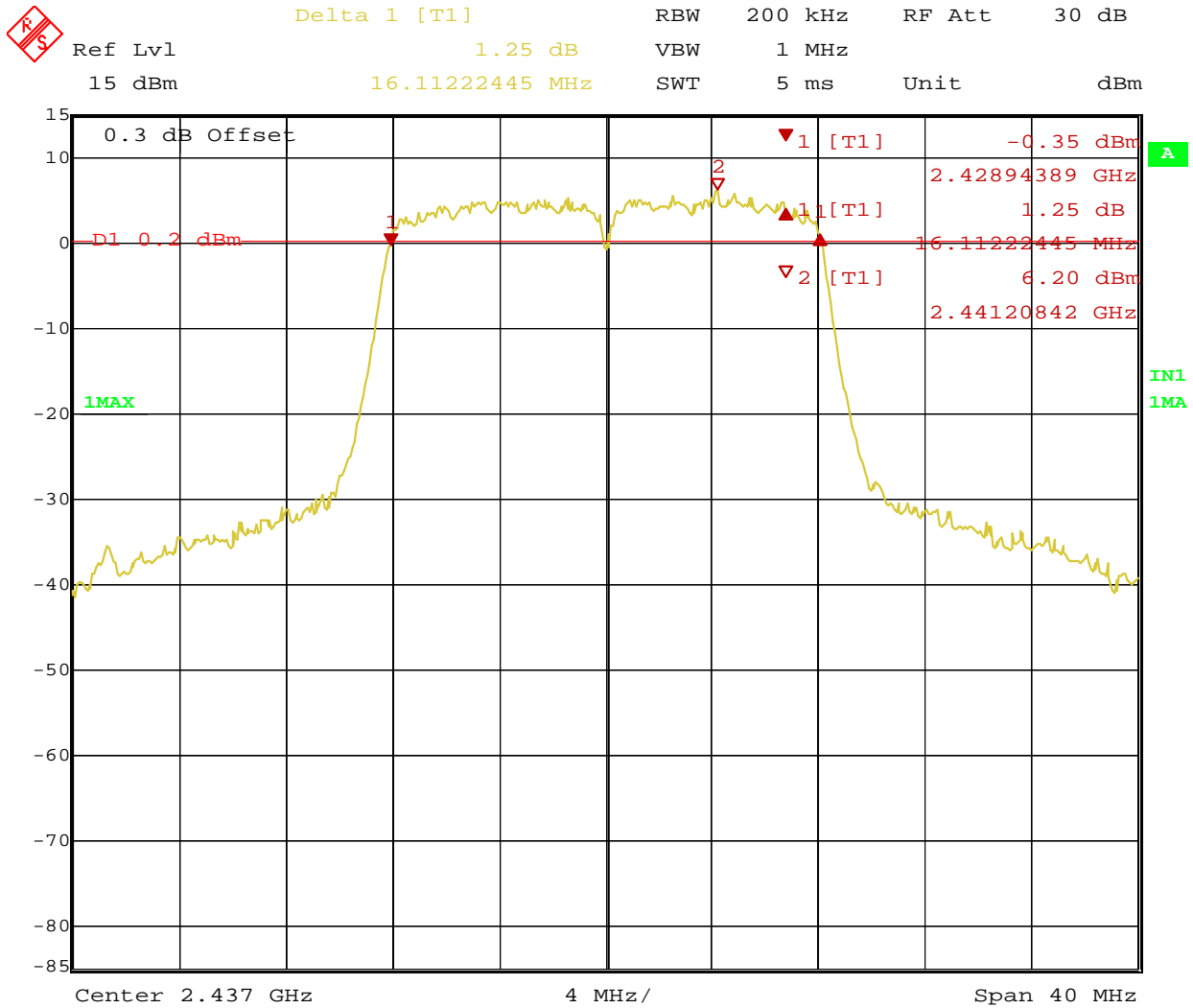

Date: 28.SEP.2009 16:59:09

Figure 11: 6 dB Bandwidth at 6 Mbit/s – Operating Channel 2437 MHz

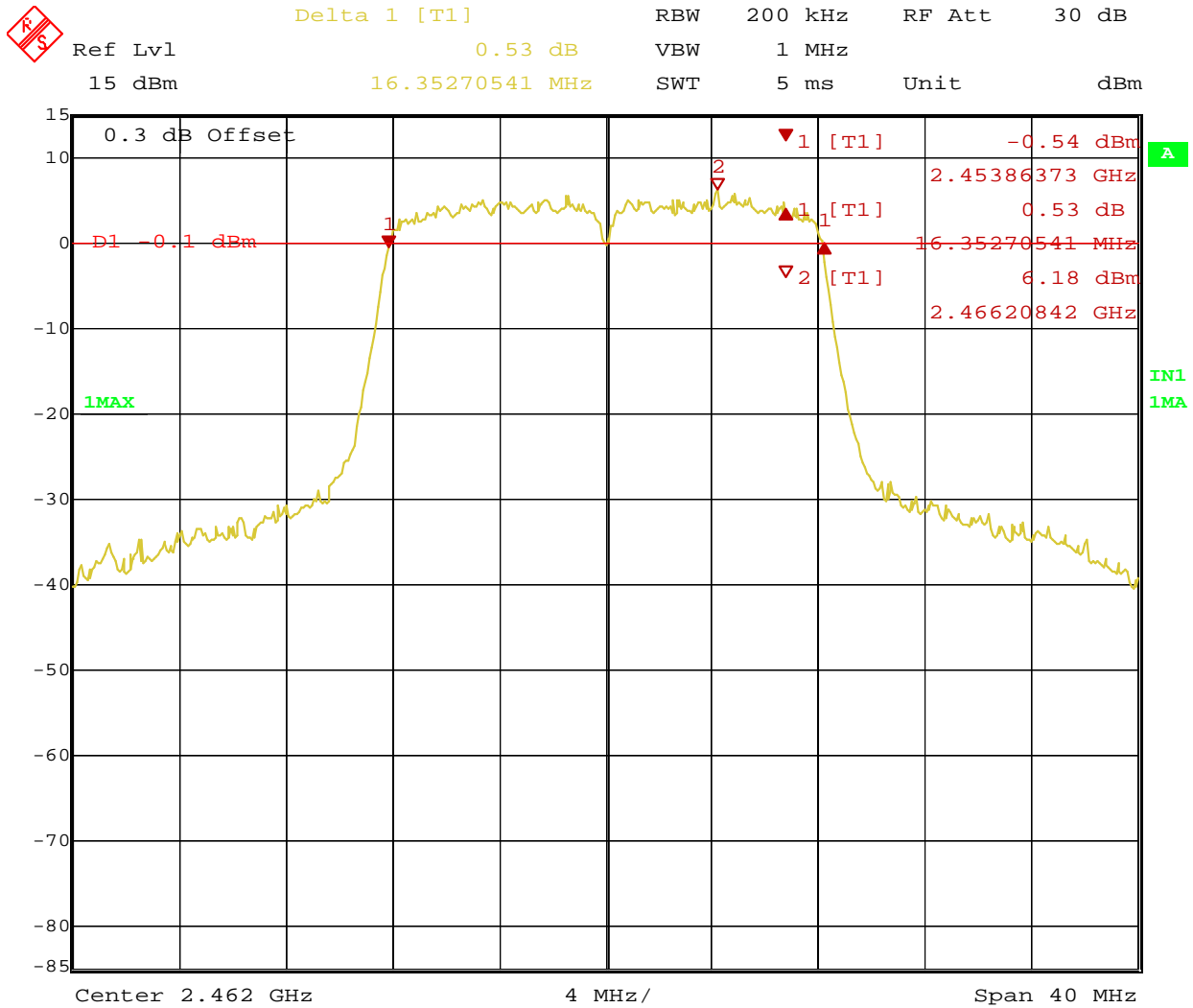

Date: 28.SEP.2009 17:11:42

Figure 12: 6 dB Bandwidth at 6 Mbit/s – Operating Channel 2462 MHz

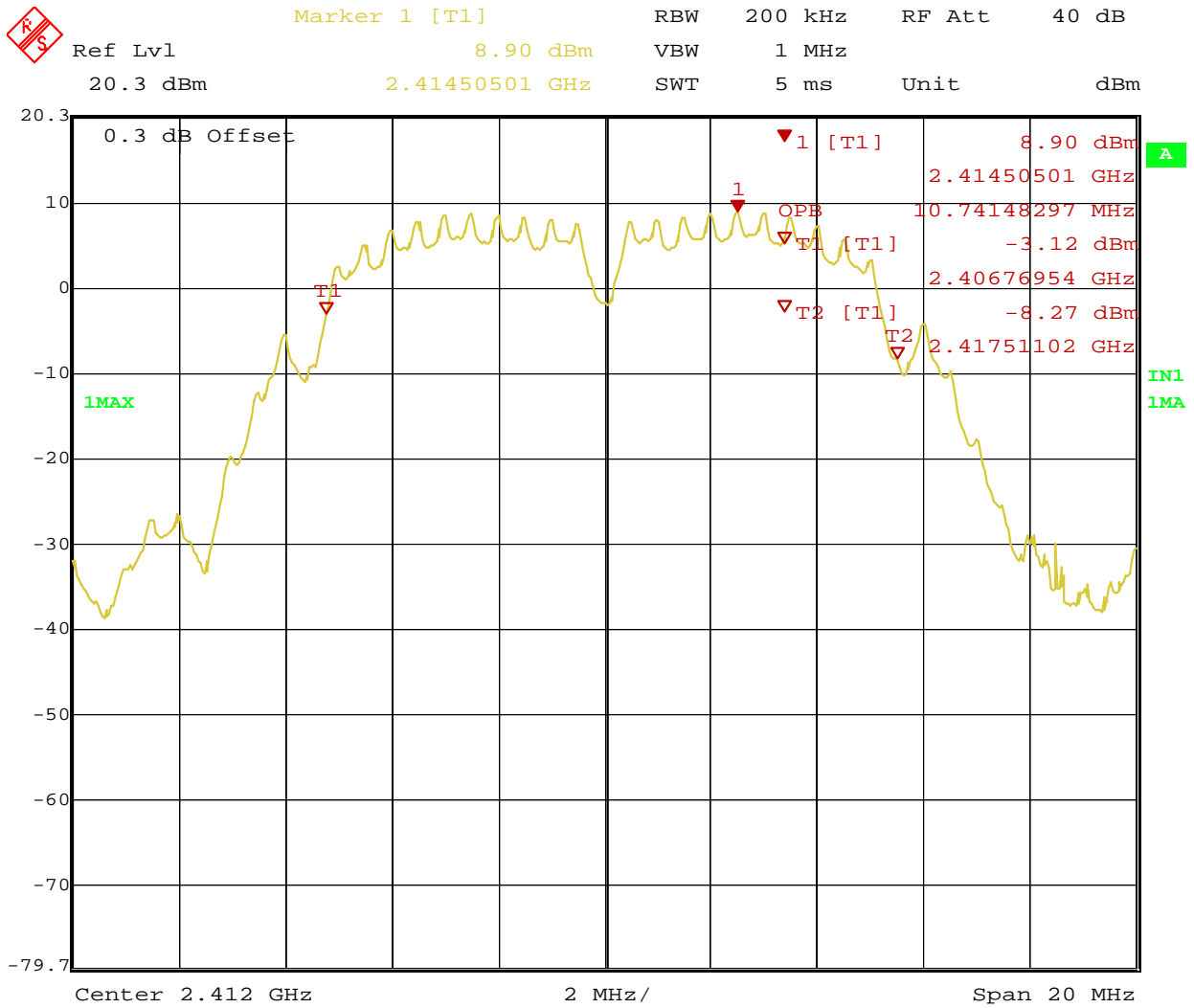

Date: 6.NOV.2009 20:35:01

Figure 13: 99% Bandwidth at 1 Mbit/s – Operating Channel 2412 MHz

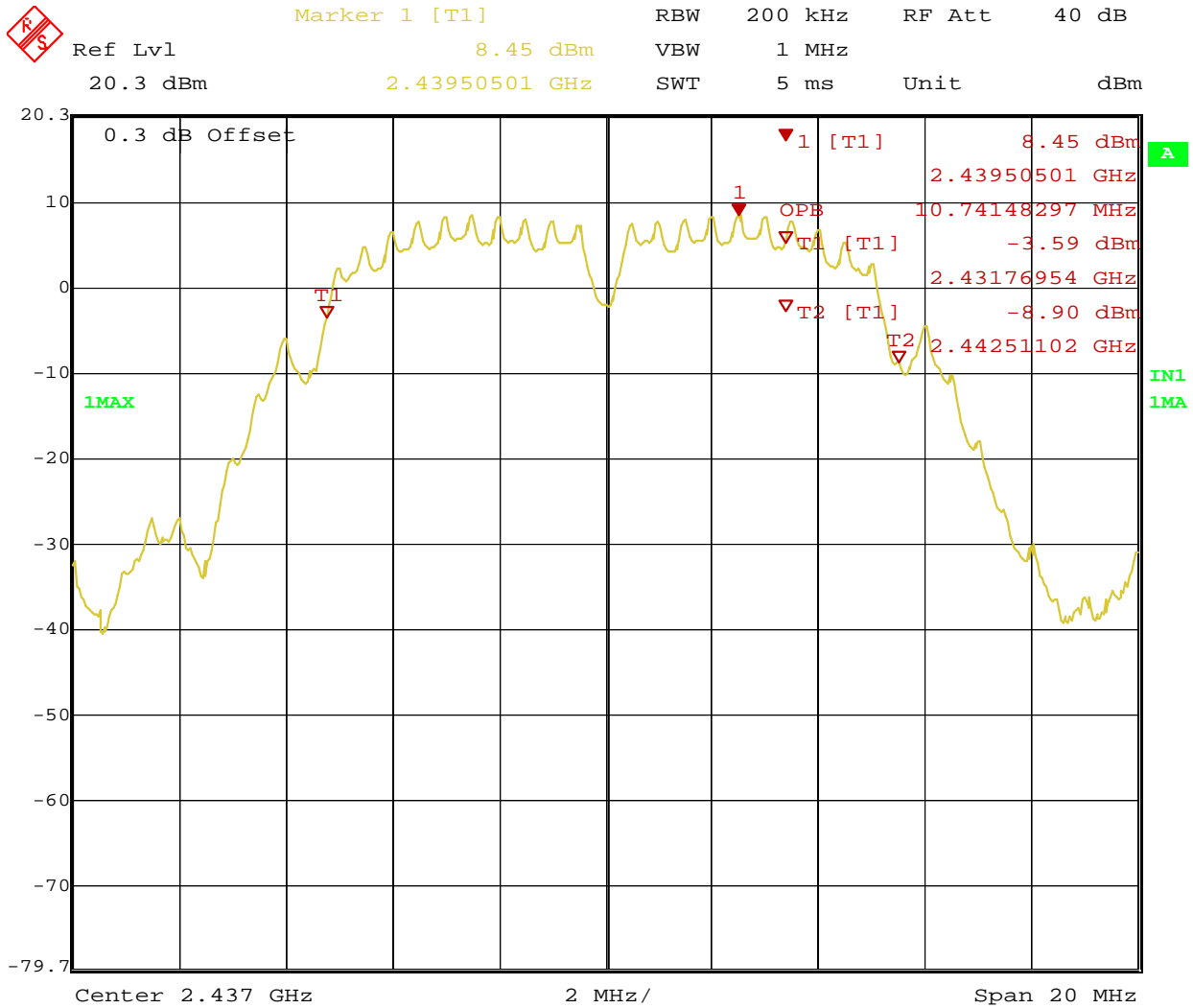

Date: 6.NOV.2009 20:38:08

Figure 14: 99% Bandwidth at 1 Mbit/s – Operating Channel 2437 MHz

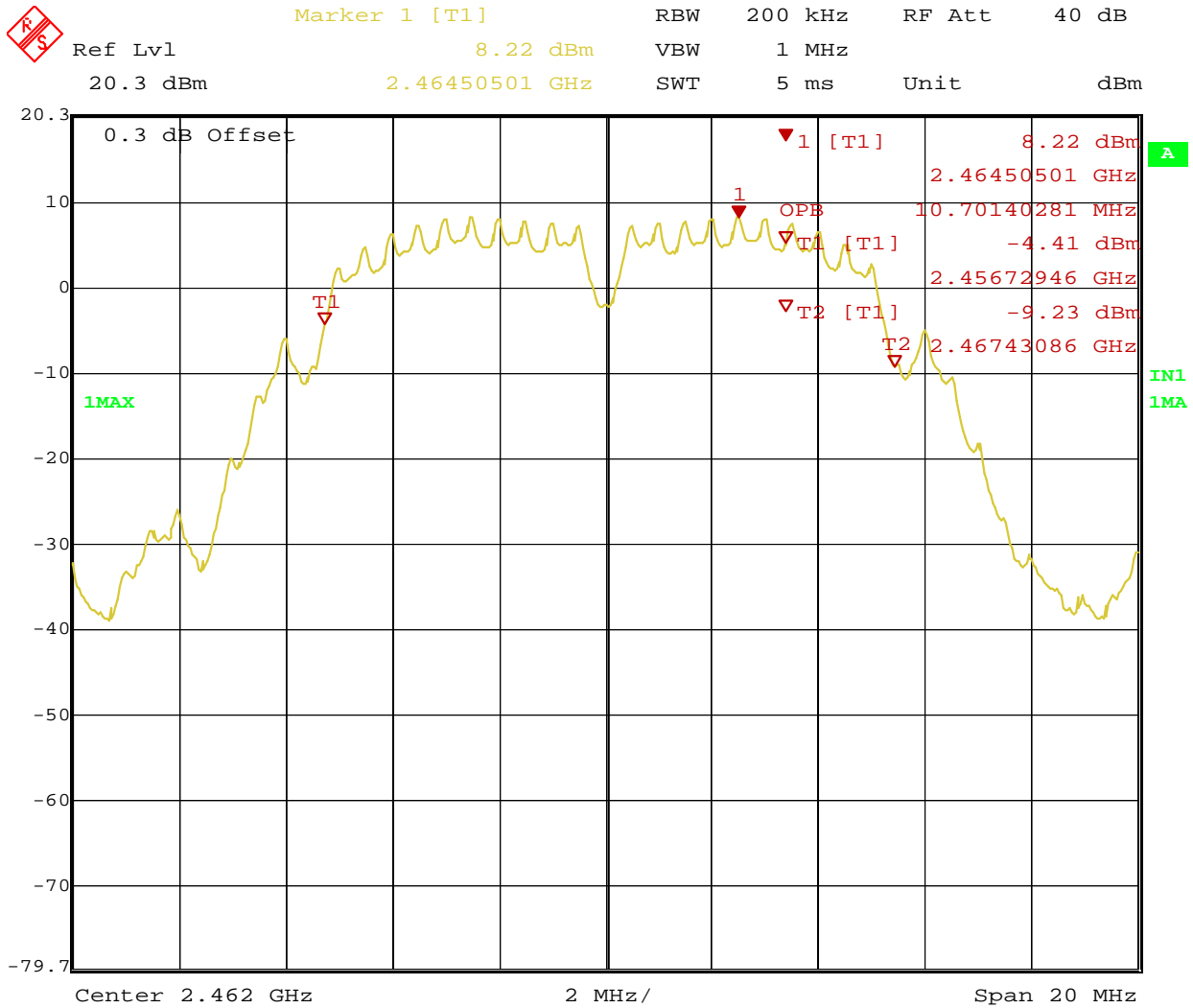

Date: 6.NOV.2009 20:39:49

Figure 15: 99% Bandwidth at 1 Mbit/s – Operating Channel 2462 MHz

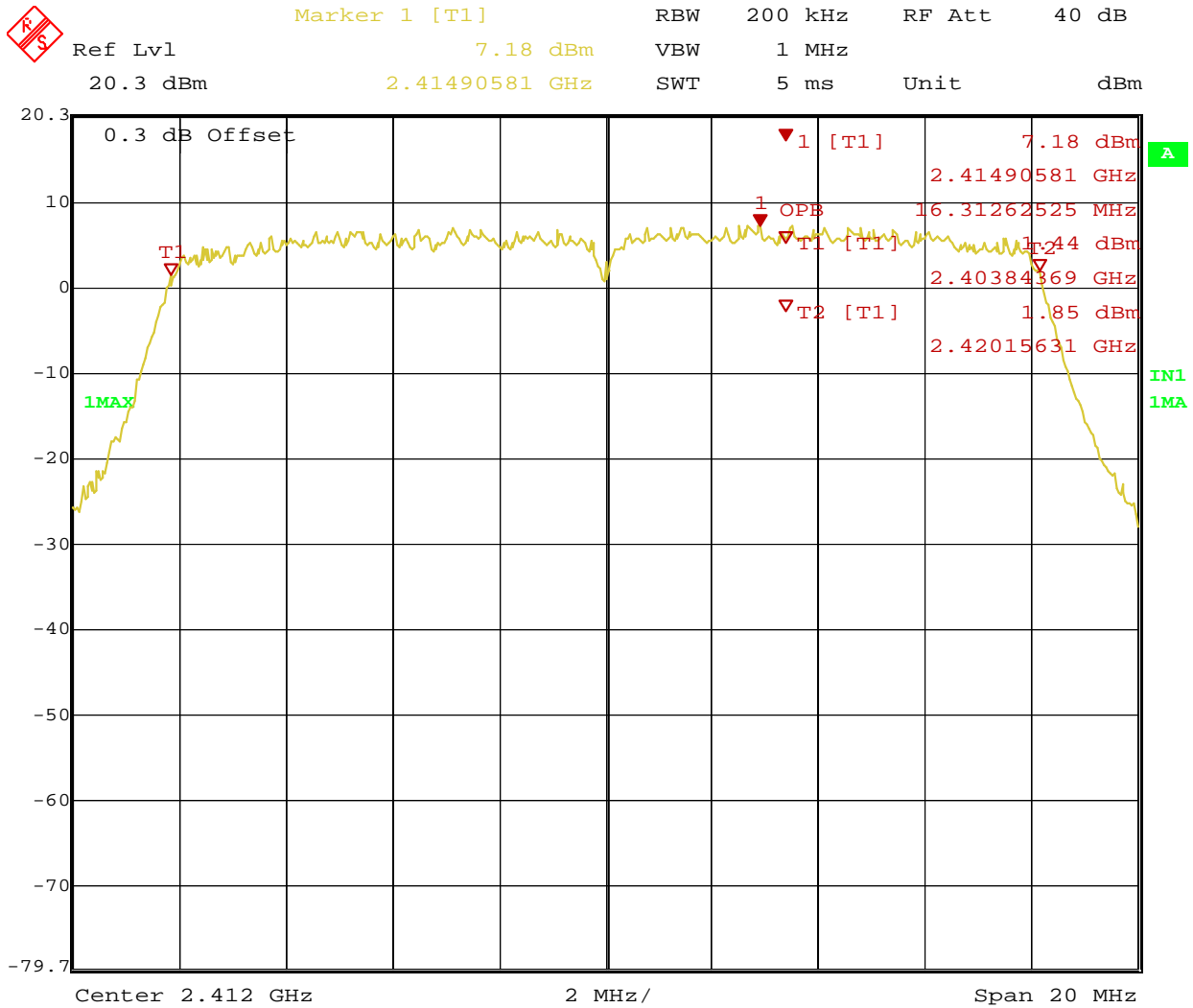

Date: 6.NOV.2009 20:41:45

Figure 16: 99% Bandwidth at 6 Mbit/s – Operating Channel 2412 MHz

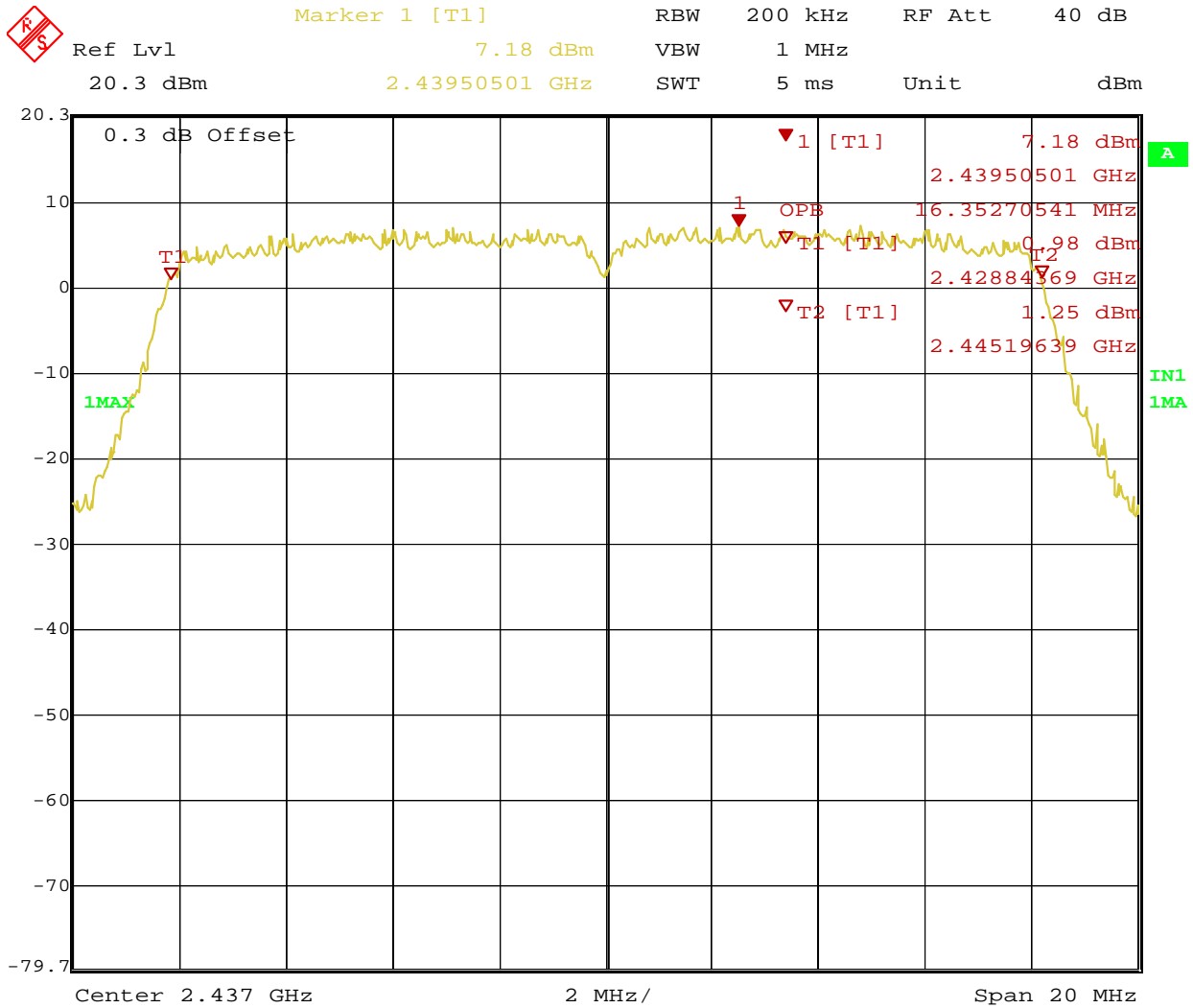

Date: 6.NOV.2009 20:43:35

Figure 17: 99% Bandwidth at 6 Mbit/s – Operating Channel 2437 MHz

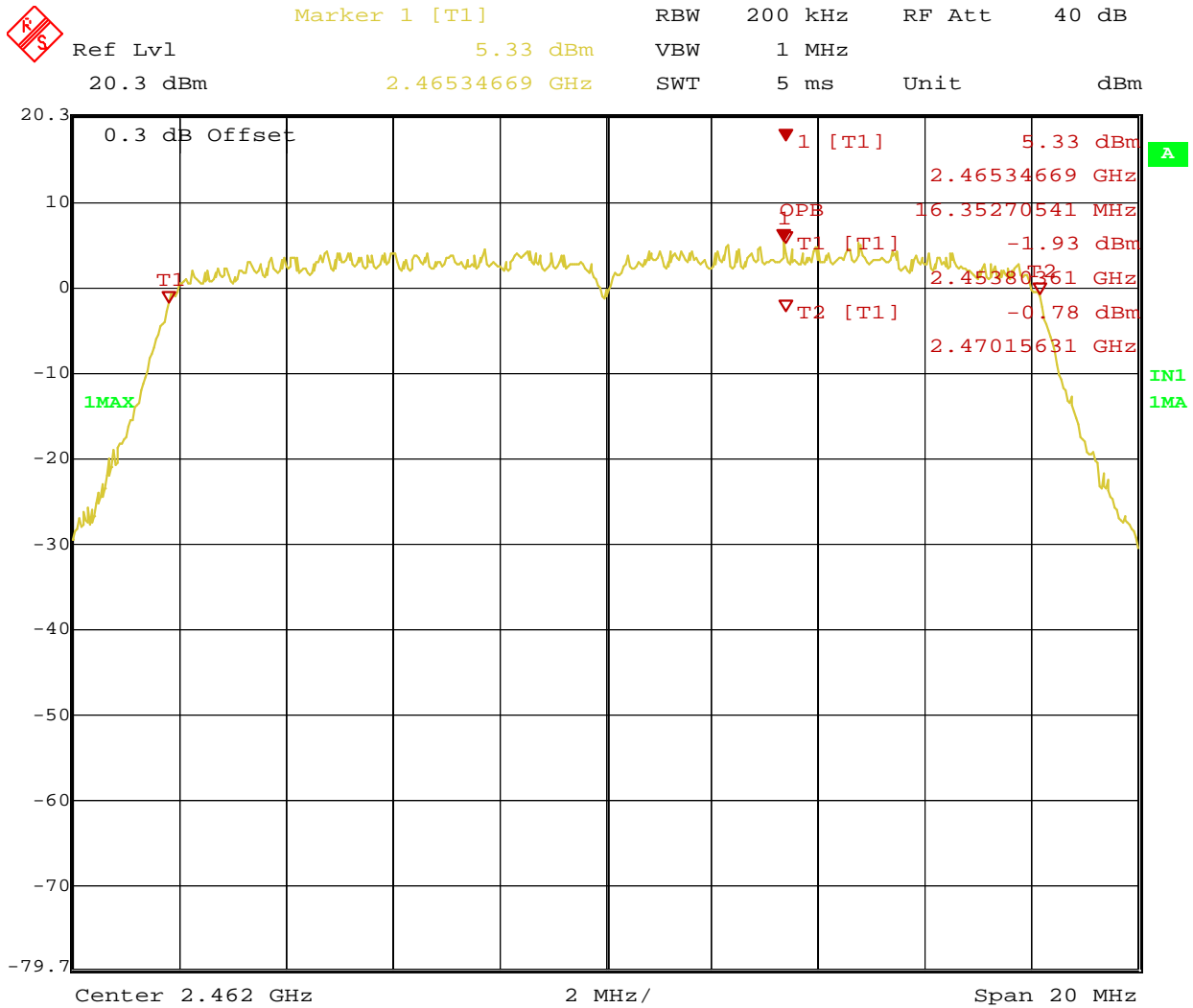

Date: 6.NOV.2009 20:45:35

Figure 18: 99% Bandwidth at 6 Mbit/s – Operating Channel 2462 MHz

4.3 Band Edge Requirements

The setup was identical to RF output power measurement. Intentional radiators operating under the alternative provisions to the general emission limits, must be designed to ensure that the 20 dB bandwidth of the emission, or whatever bandwidth may otherwise be specified in the specific rule section under which the equipment operates, is contained within the frequency band designated in the rule section under which the equipment is operated. The requirement to contain the designated bandwidth of the emission within the specified frequency band includes the effects from frequency sweeping, frequency hopping and other modulation techniques that may be employed as well as the frequency stability of the transmitter over expected variations in temperature and supply voltage. If the frequency stability is not specified in the regulations, it is recommended that the fundamental emission be kept within at least the central 80% of the permitted band in order to minimize the possibility of out-of-band operation.

Any frequency outside the band of 2400 MHz to 2483.5 MHz, the power output level must be below 20 db from the in-band transmitting signal; CFR 47 Part 15.215, 15.247(d) and RSS 210 A8.5

As originally tested, the EUT was found to be compliant to the requirements of the test standard(s).

Table 5: Band-Edge Requirements – Test Results

Test Conditions: Conducted Measurement, Normal Temperature and Voltage only				
Antenna Type: Integrated		Power Setting: +20 dBm		
Signal State: Modulated		Data Rate: 11 Mbps and 54 Mbps		
Ambient Temp.: 23° C		Relative Humidity: 35%		
Band-Edge Results				
Operating Channel	Mode	Band Edge Level (dBm)	20 dB Level (dBm)	Margin (dB)
2412 MHz	11Mbps	-37.83	-12.39	-25.44
2462 MHz	11Mbps	-41.71	-12.38	-29.33
2412 MHz	54Mbps	-32.16	-13.16	-19.00
2462 MHz	54Mbps	-41.55	-16.18	-25.37

Table 6: Out of band Emission – Test Results

Test Conditions: Conducted Measurement, Normal Temperature and Voltage only					
Antenna Type: Integrated			Power Setting: +20 dBm		
Signal State: Modulated			Data Rate: 11 Mbit/s and 54 Mbit/s		
Ambient Temp.: 23° C			Relative Humidity: 35%		
Output of Band Results					
Operating Channel	Mode	Band 1 30 MHz- 2.4835GHz	Band 2 2.4835GHz-10GHz	Band 3 10GHz-25 GHz	Result
2412 MHz	11Mbps	Figure 23	Figure 24	Figure 25	Pass
2437 MHz	11Mbps	Figure 26	Figure 27	Figure 28	Pass
2462 MHz	11Mbps	Figure 29	Figure 30	Figure 31	Pass
2412 MHz	54Mbps	Figure 32	Figure 33	Figure 34	Pass
2437 MHz	54Mbps	Figure 35	Figure 36	Figure 37	Pass
2462 MHz	54Mbps	Figure 38	Figure 39	Figure 40	Pass

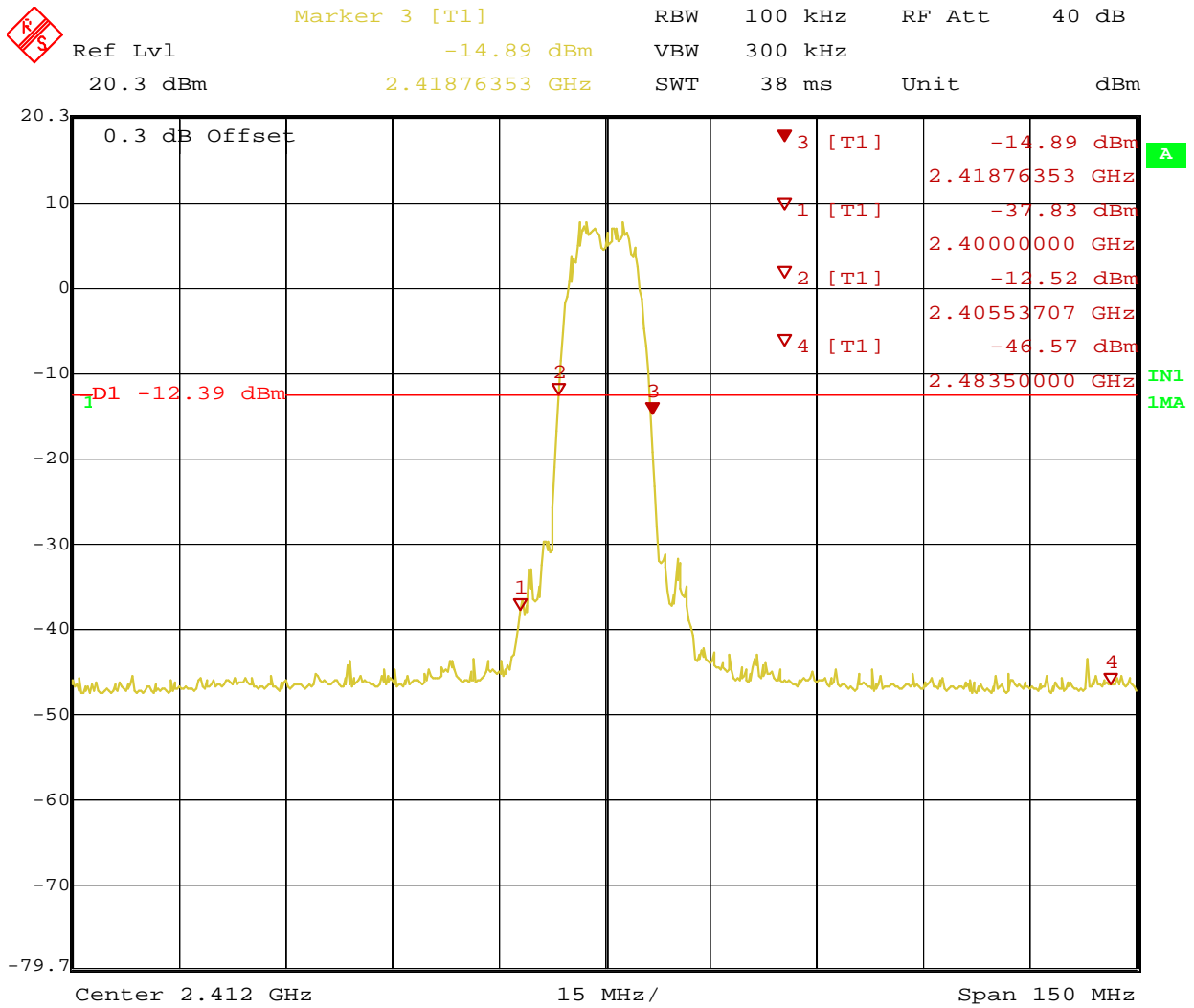

Date: 29.SEP.2009 17:09:16

Figure 19: Band Edge Requirement for Operating Channel 2412 MHz – 802.11b

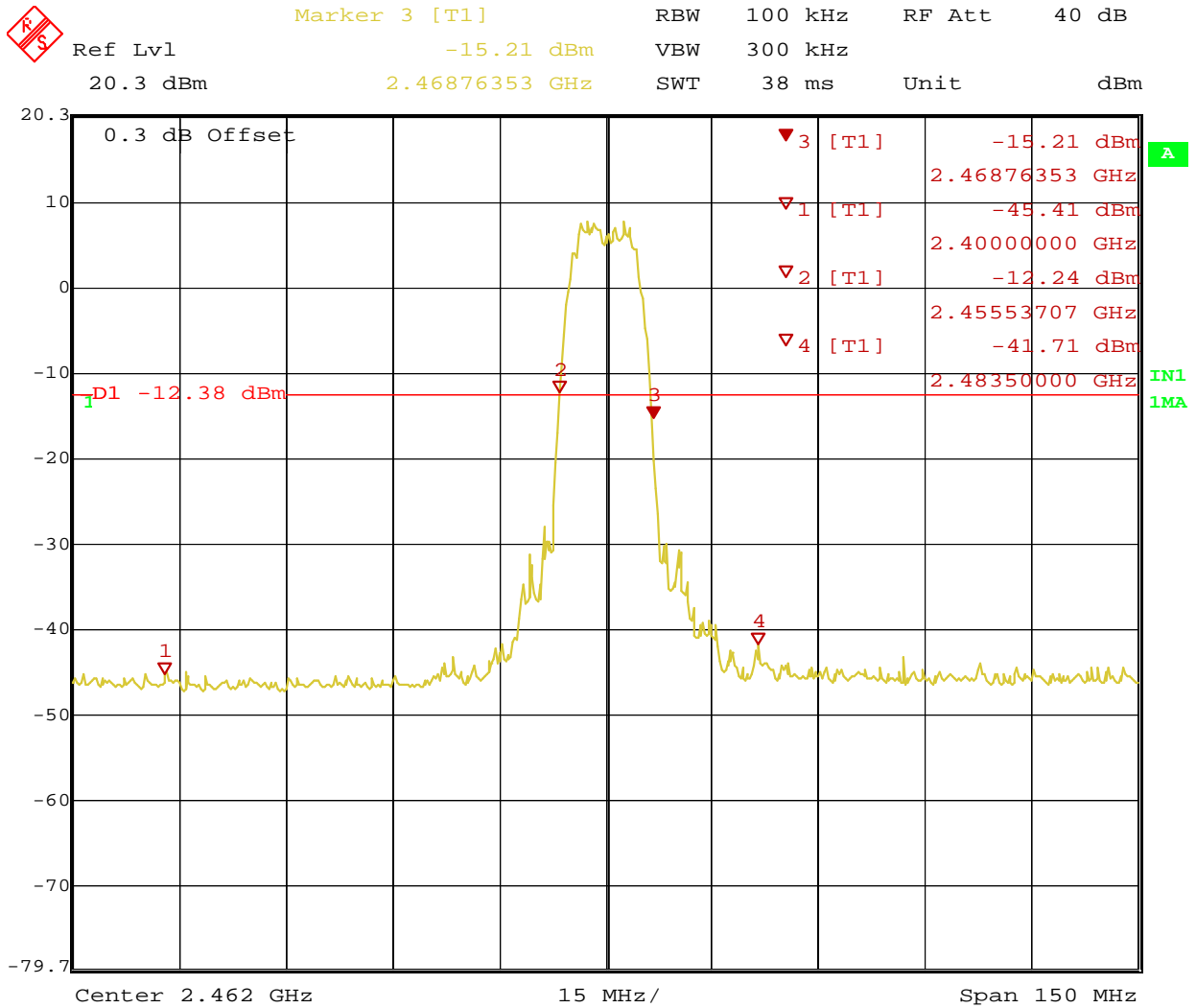

Date: 29.SEP.2009 16:56:22

Figure 20: Band Edge Requirement for Operating Channel 2462 MHz – 802.11b

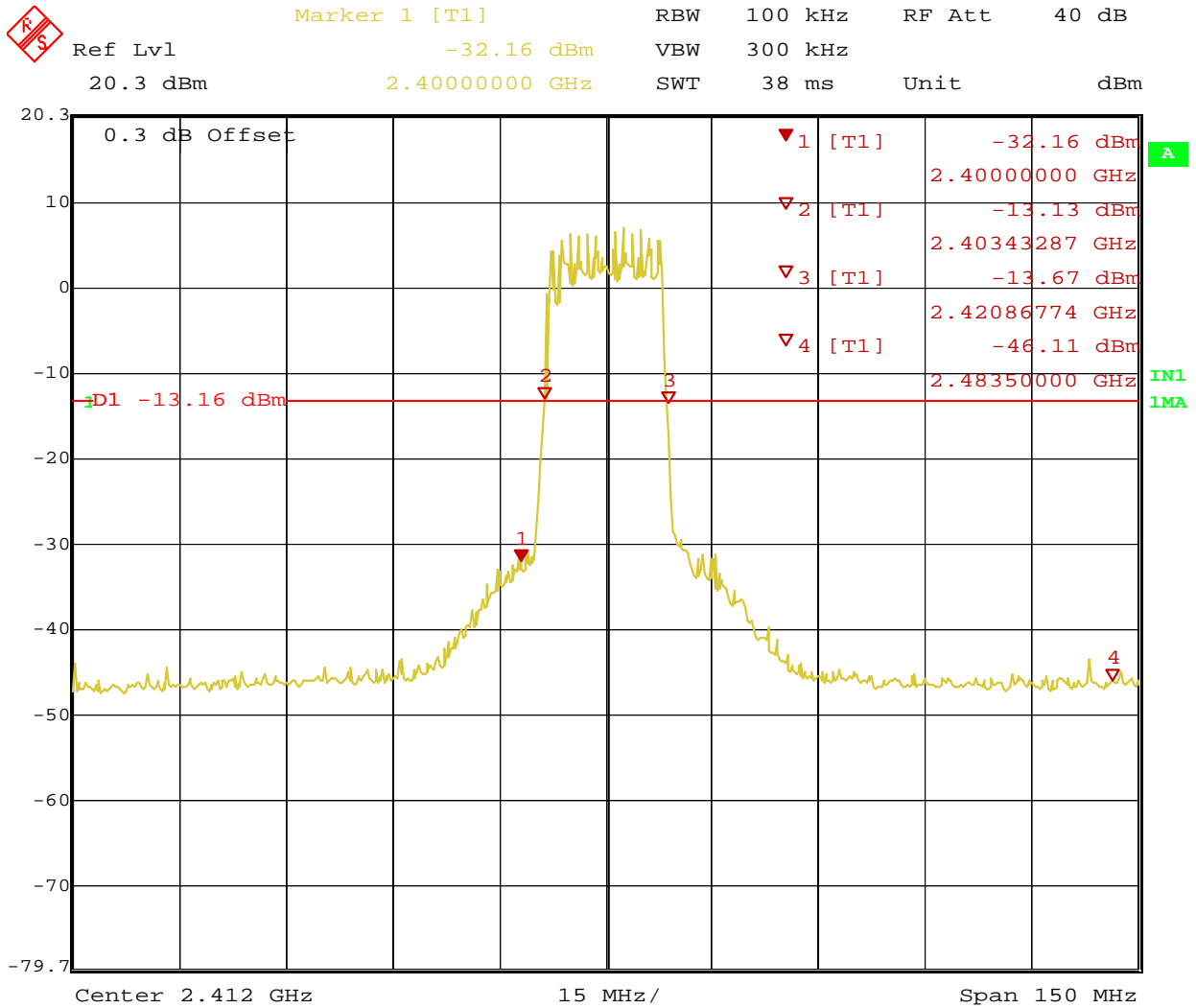

Date: 29.SEP.2009 16:36:29

Figure 21: Band Edge Requirement for Operating Channel 2412 MHz – 802.11g

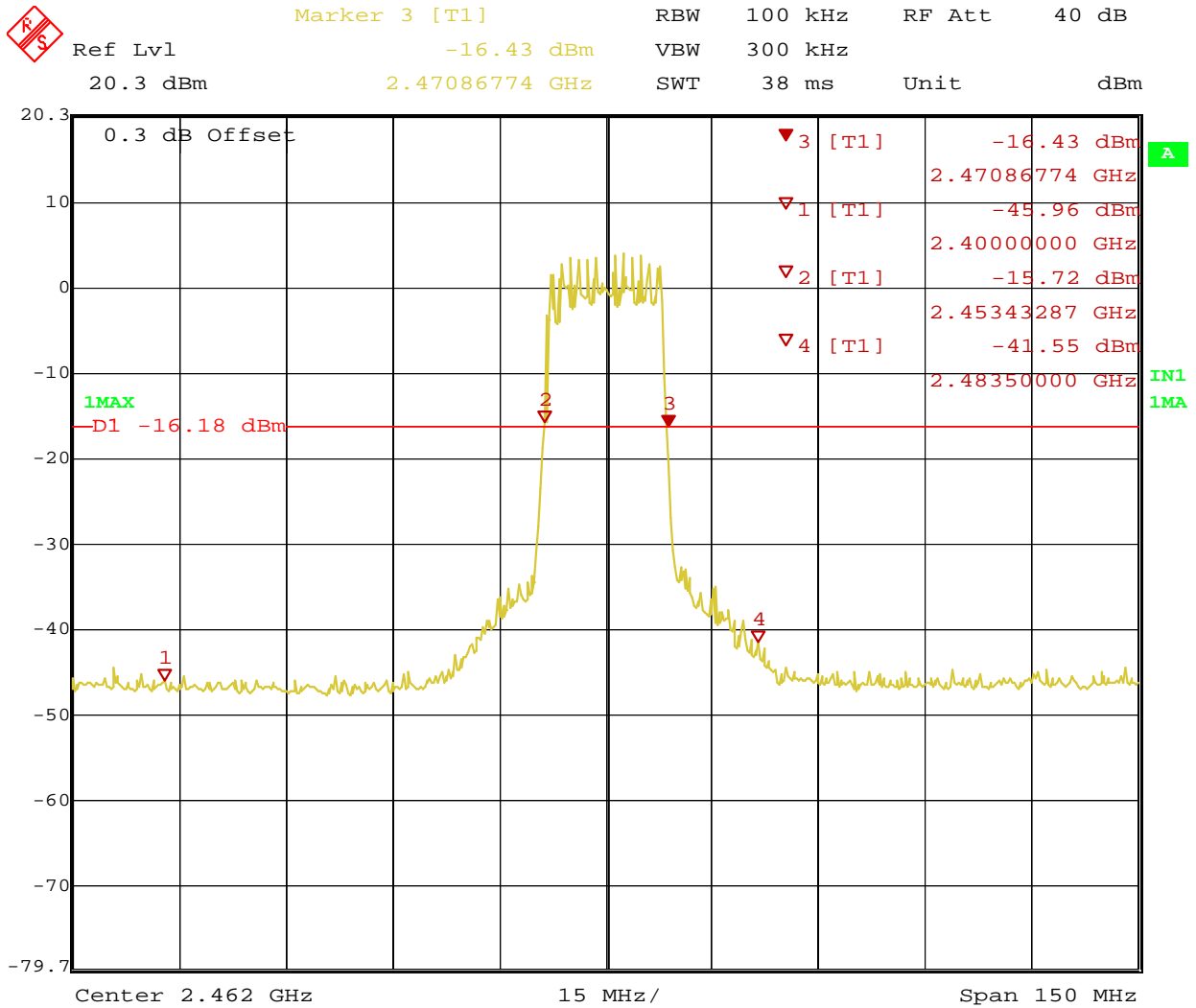

Date: 29.SEP.2009 16:49:36

Figure 22: Band Edge Requirement for Operating Channel 2462 MHz – 802.11g

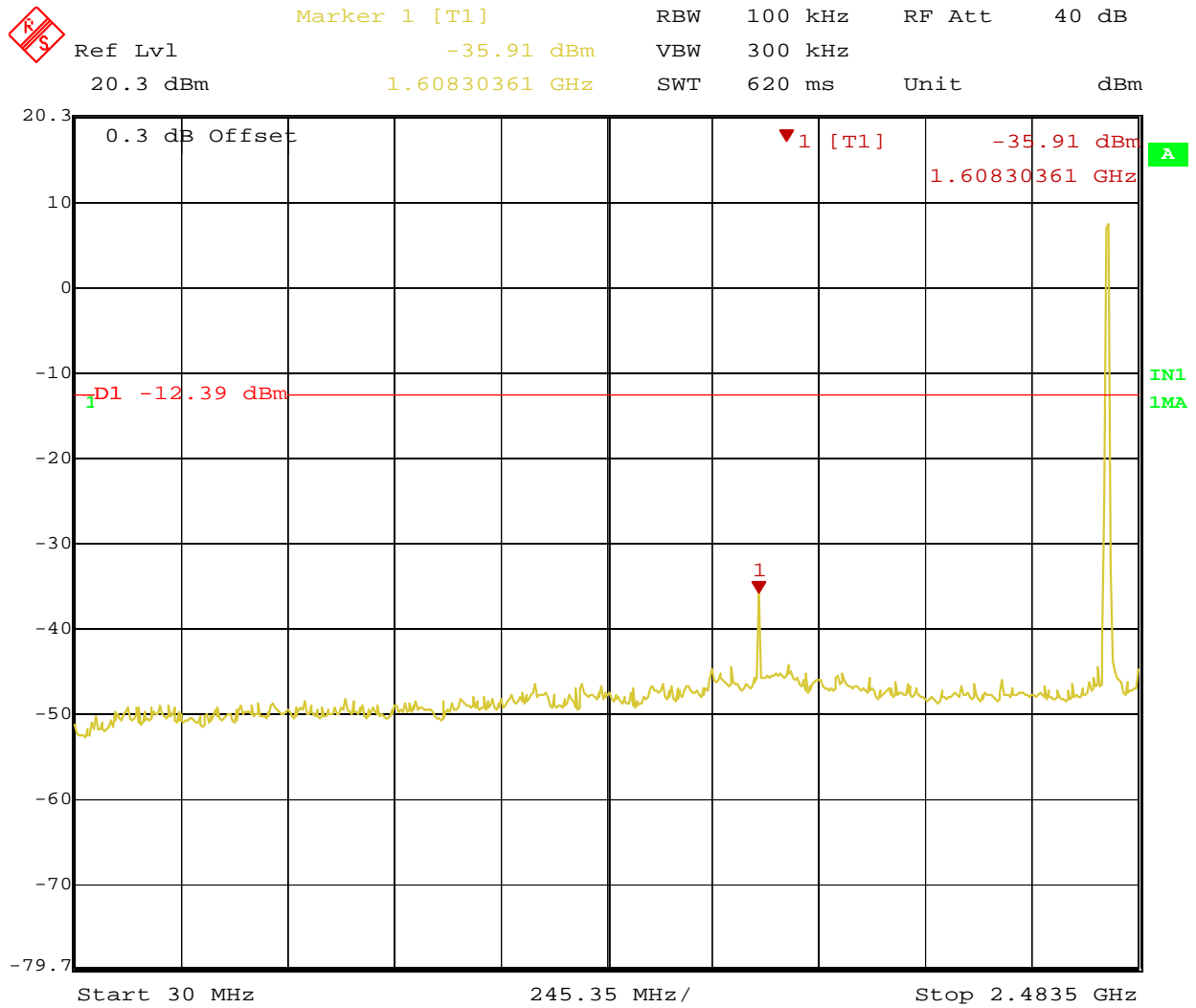

Date: 29.SEP.2009 17:10:21

Figure 23: Out of Band Emission for Channel 2412 MHz at 11 Mbit/s – Band 1

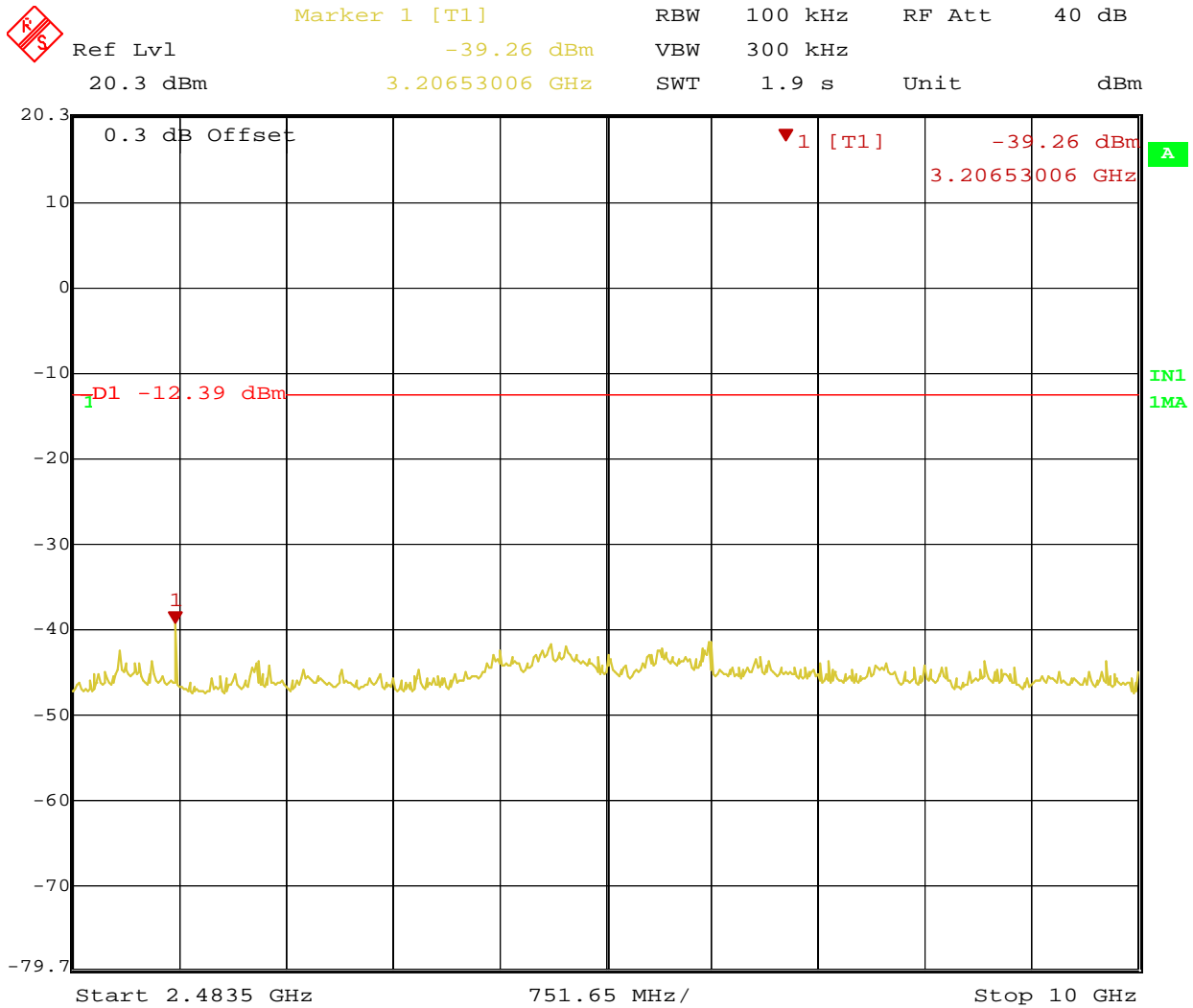

Date: 29.SEP.2009 17:11:07

Figure 24: Out of Band Emission for Channel 2412 MHz at 11 Mbit/s – Band 2

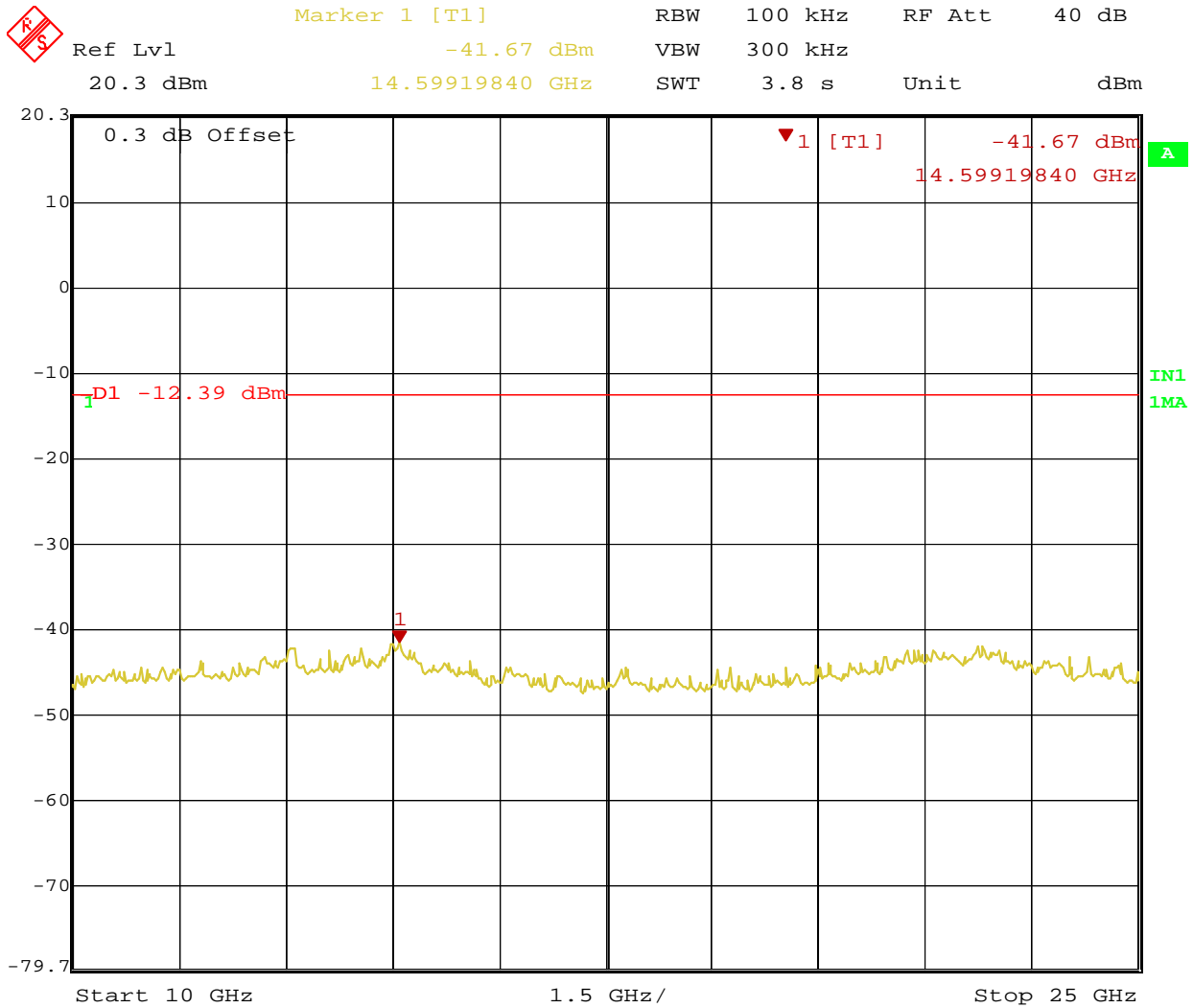

Date: 29.SEP.2009 17:11:39

Figure 25: Out of Band Emission for Channel 2412 MHz at 11 Mbit/s – Band 3

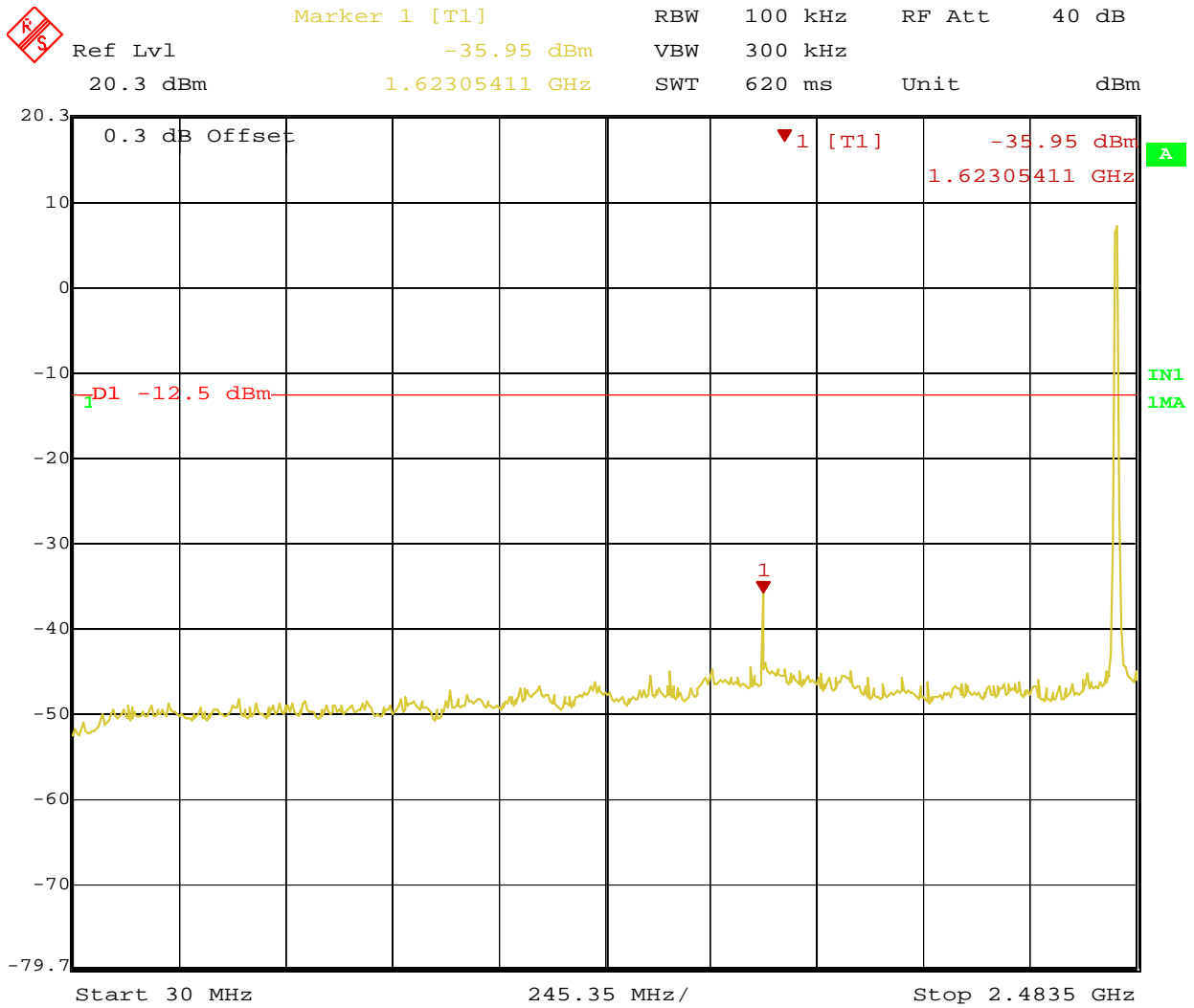

Date: 29.SEP.2009 17:05:23

Figure 26: Out of Band Emission for Channel 2437 MHz at 11 Mbit/s – Band 1

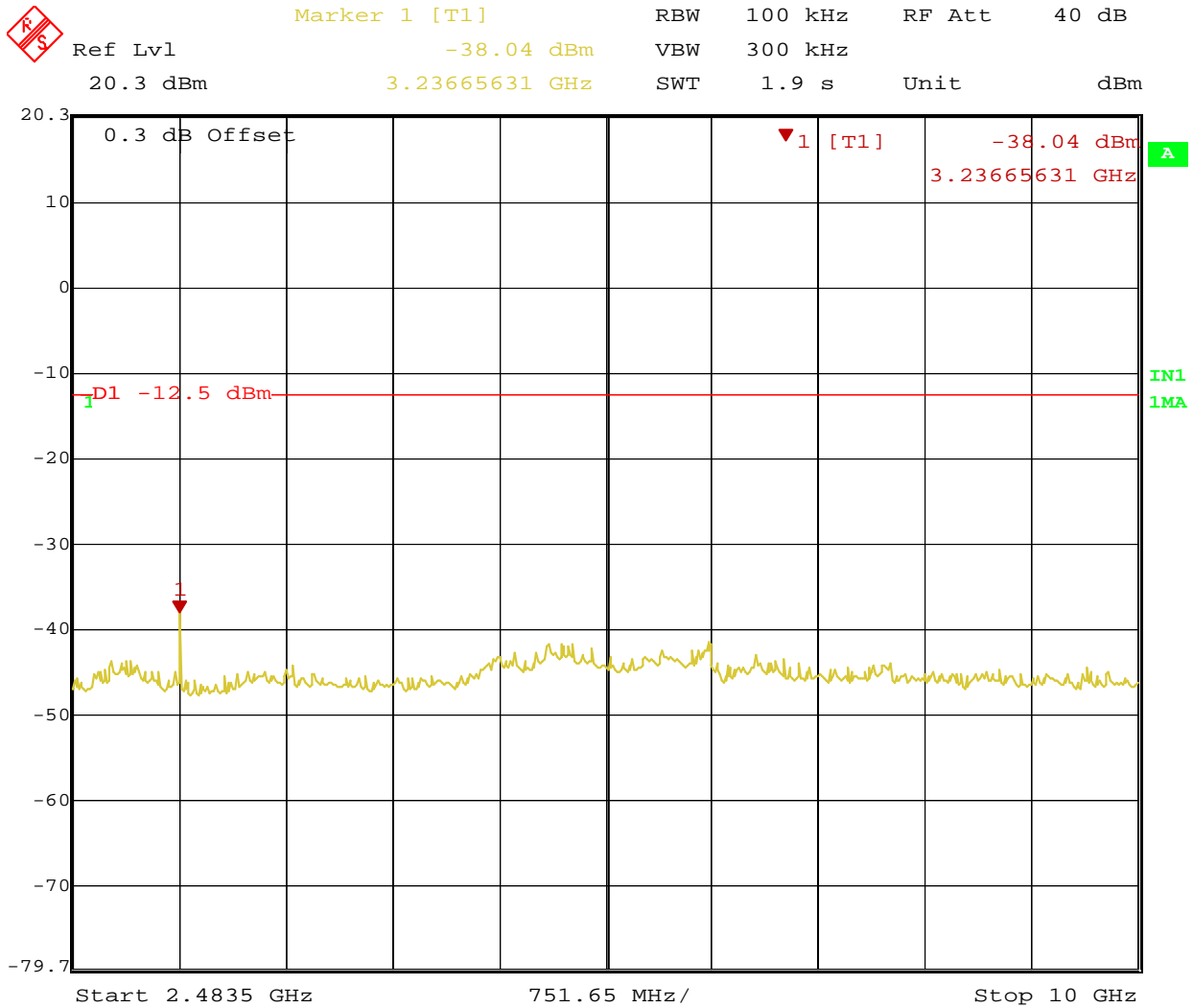

Date: 29.SEP.2009 17:06:12

Figure 27: Out of Band Emission for Channel 2437 MHz at 11 Mbit/s – Band 2

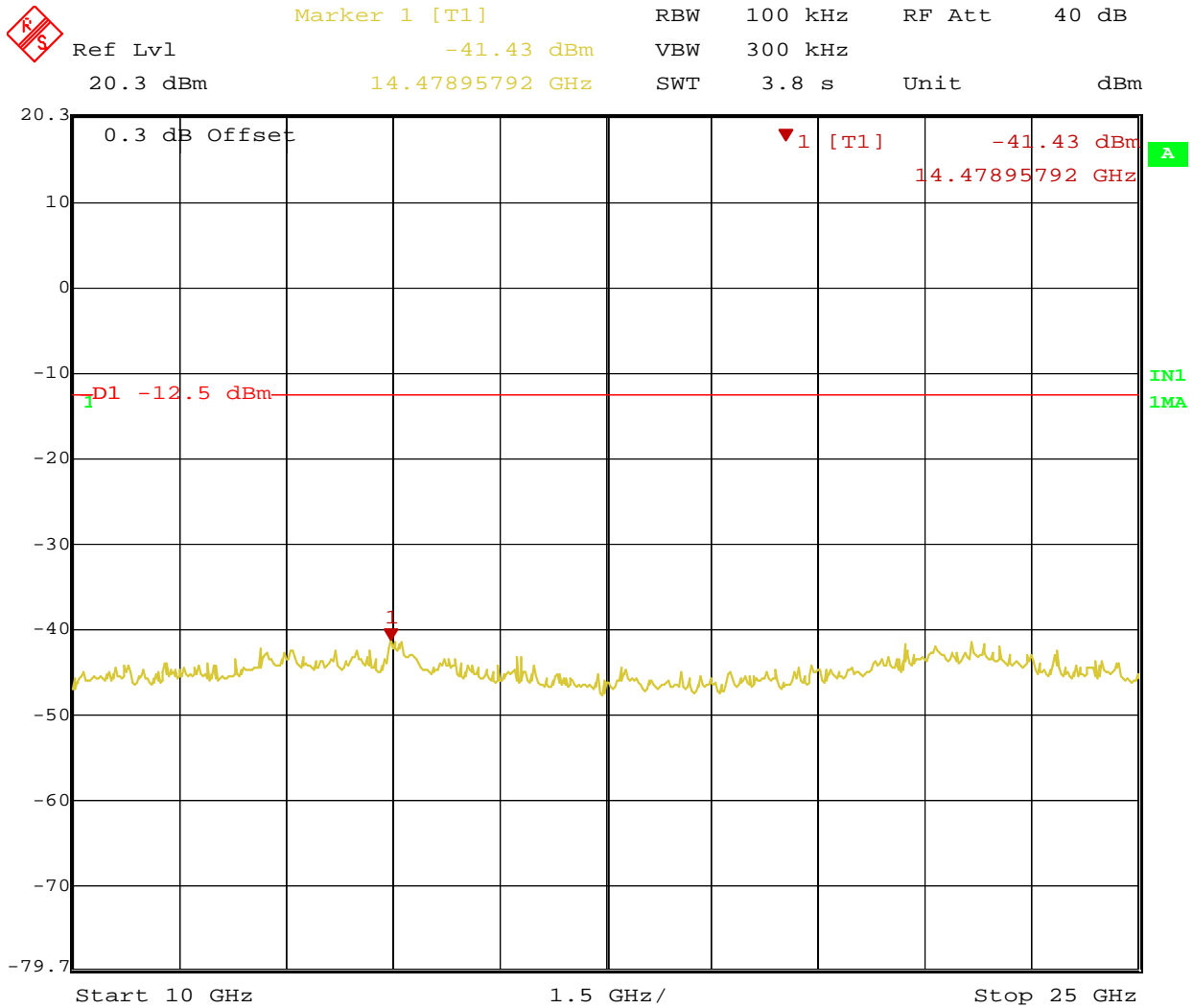

Date: 29.SEP.2009 17:06:47

Figure 28: Out of Band Emission for Channel 2437 MHz at 11 Mbit/s – Band 3

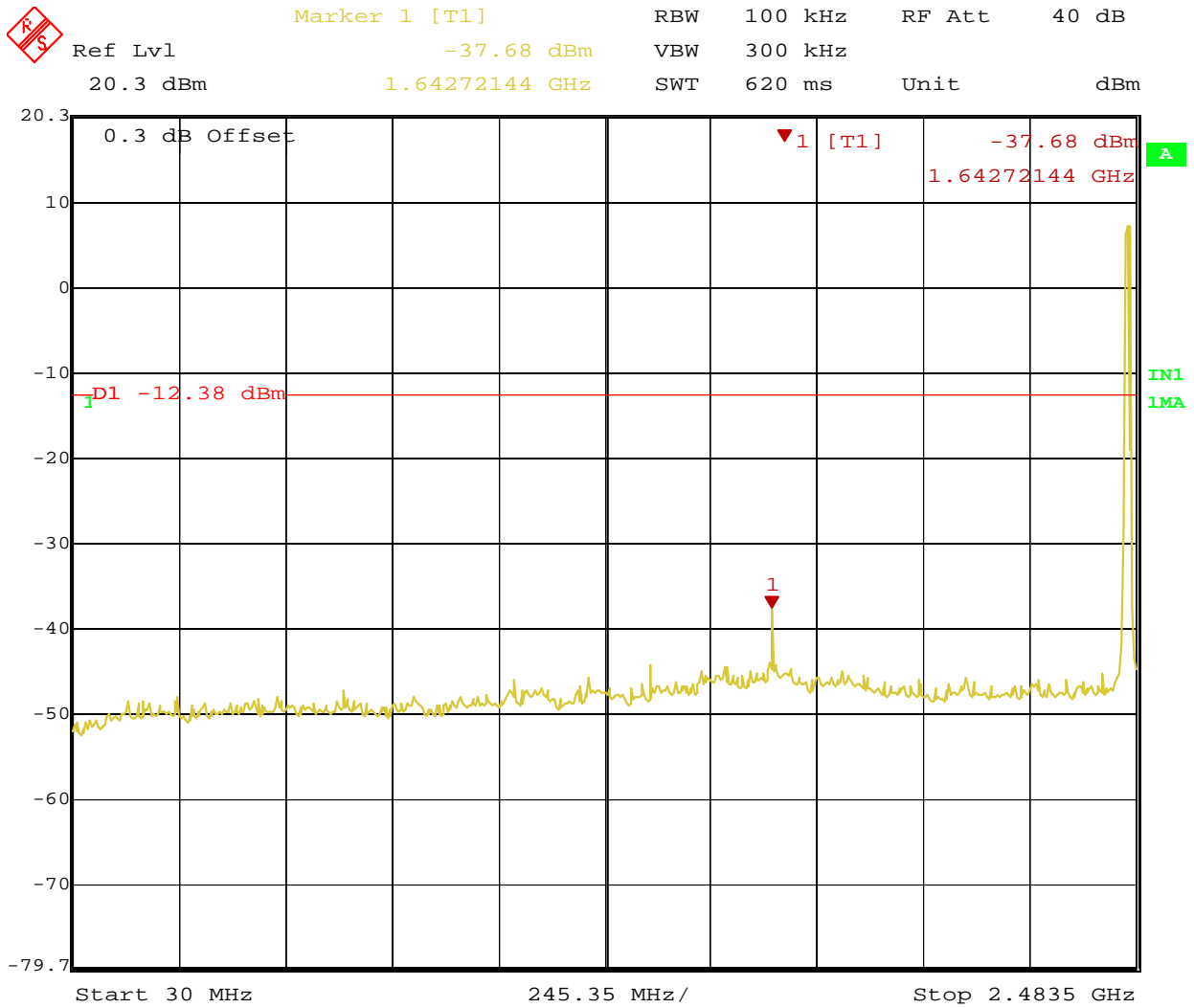

Date: 29.SEP.2009 16:57:16

Figure 29: Out of Band Emission for Channel 2462 MHz at 11 Mbit/s – Band 1

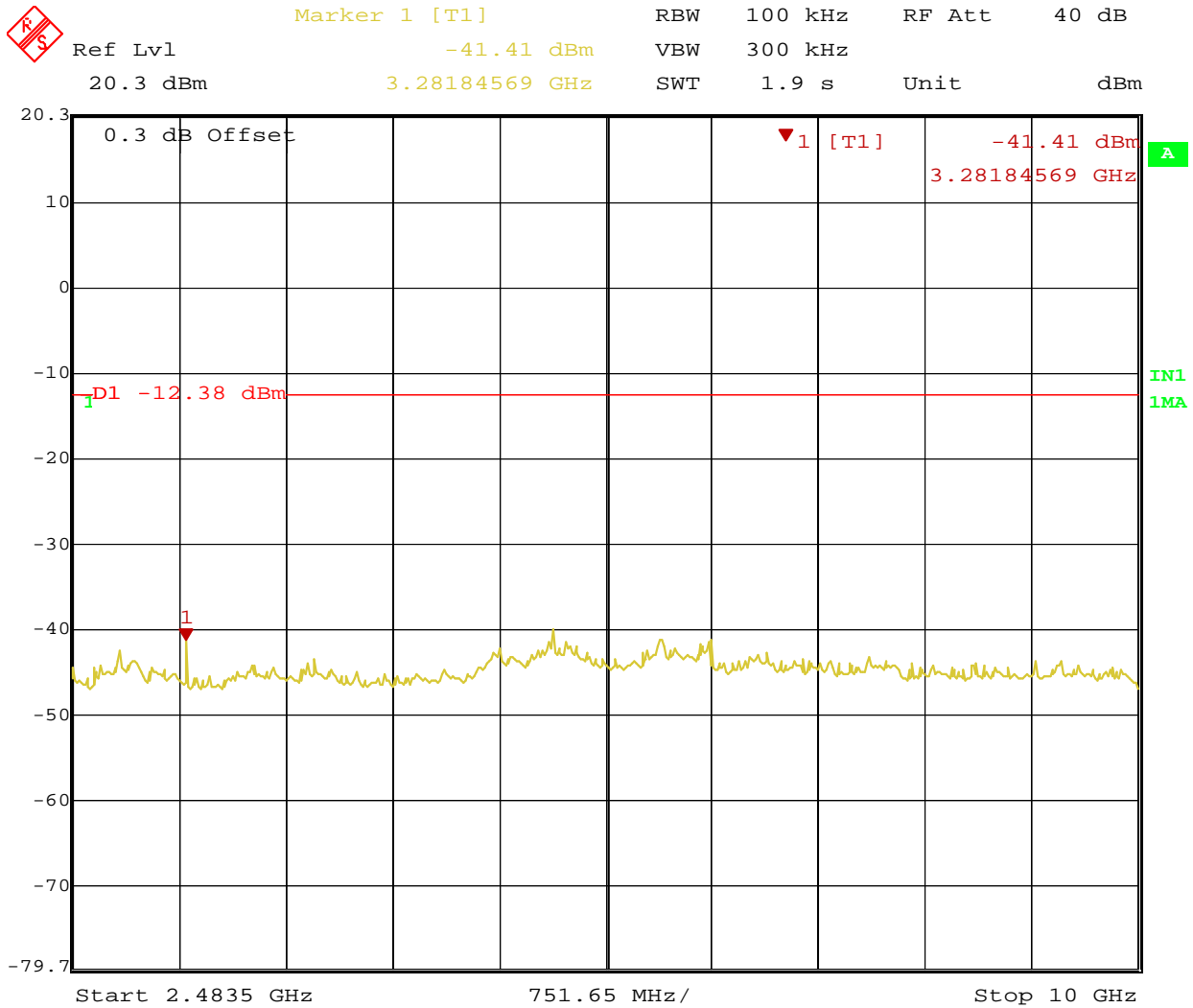

Date: 29.SEP.2009 16:58:56

Figure 30: Out of Band Emission for Channel 2462 MHz at 11 Mbit/s – Band 2

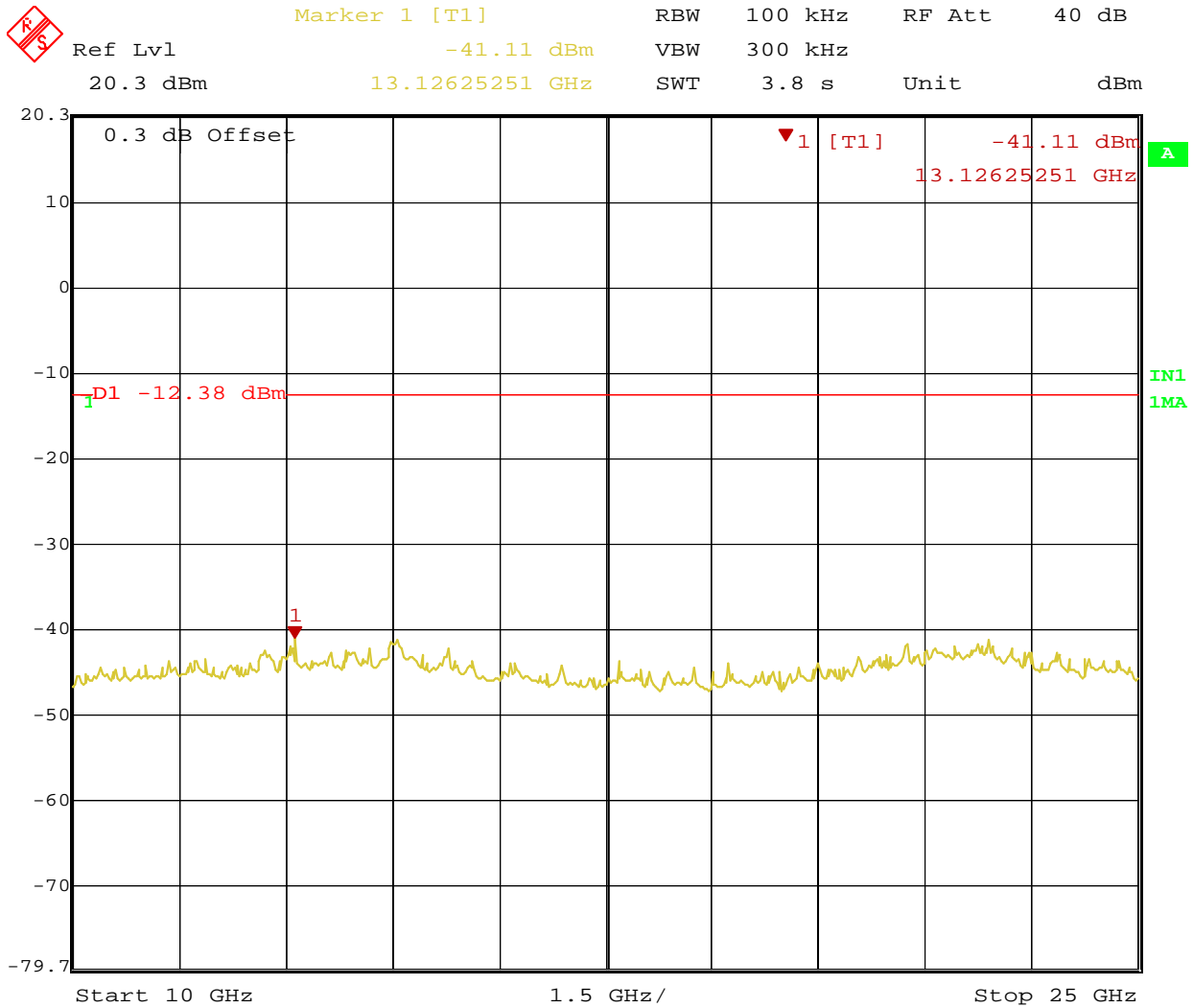

Date: 29.SEP.2009 16:59:43

Figure 31: Out of Band Emission for Channel 2462 MHz at 11 Mbit/s – Band 3

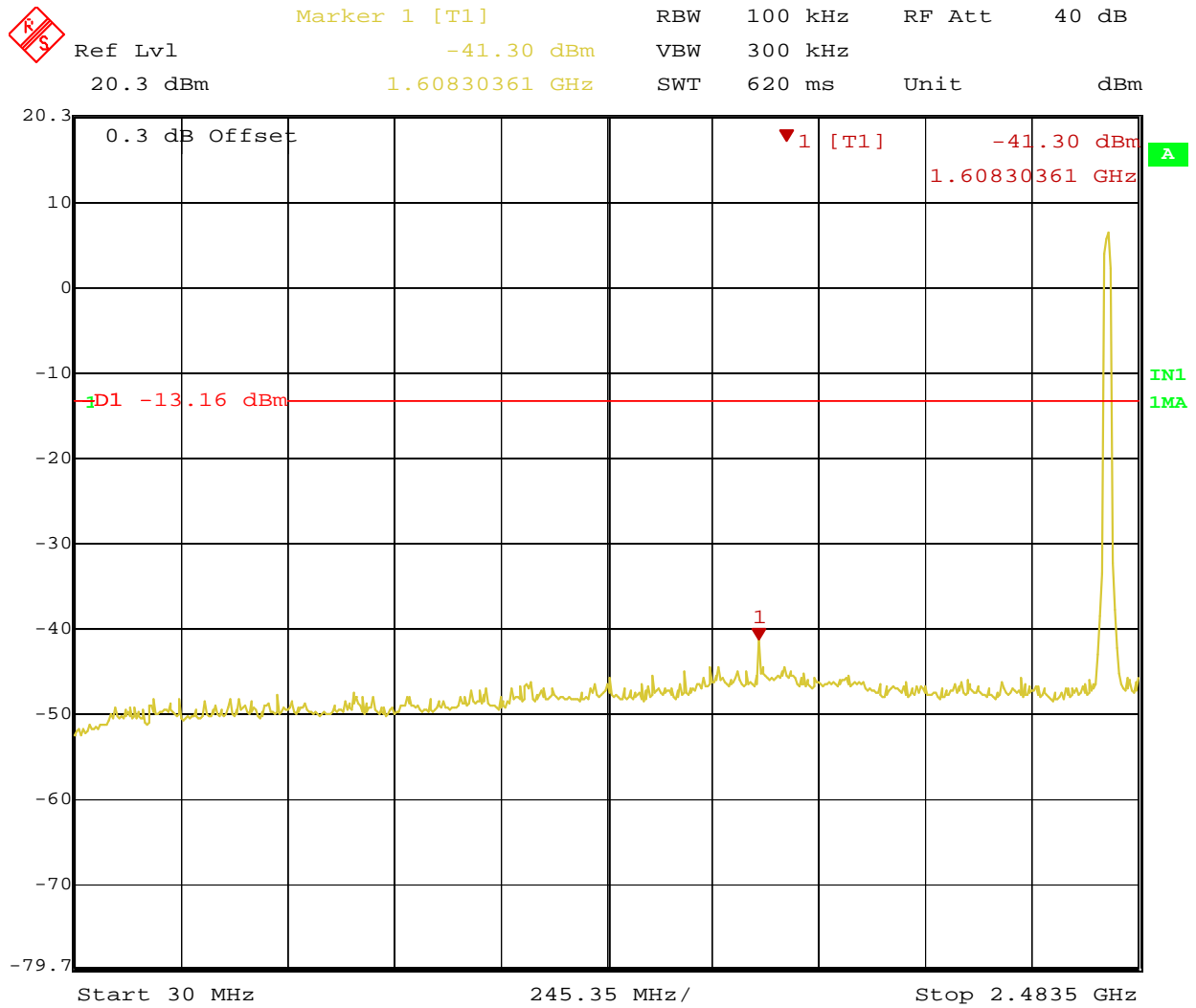

Date: 29.SEP.2009 16:37:57

Figure 32: Out of Band Emission for Channel 2412 MHz at 54 Mbit/s – Band 1

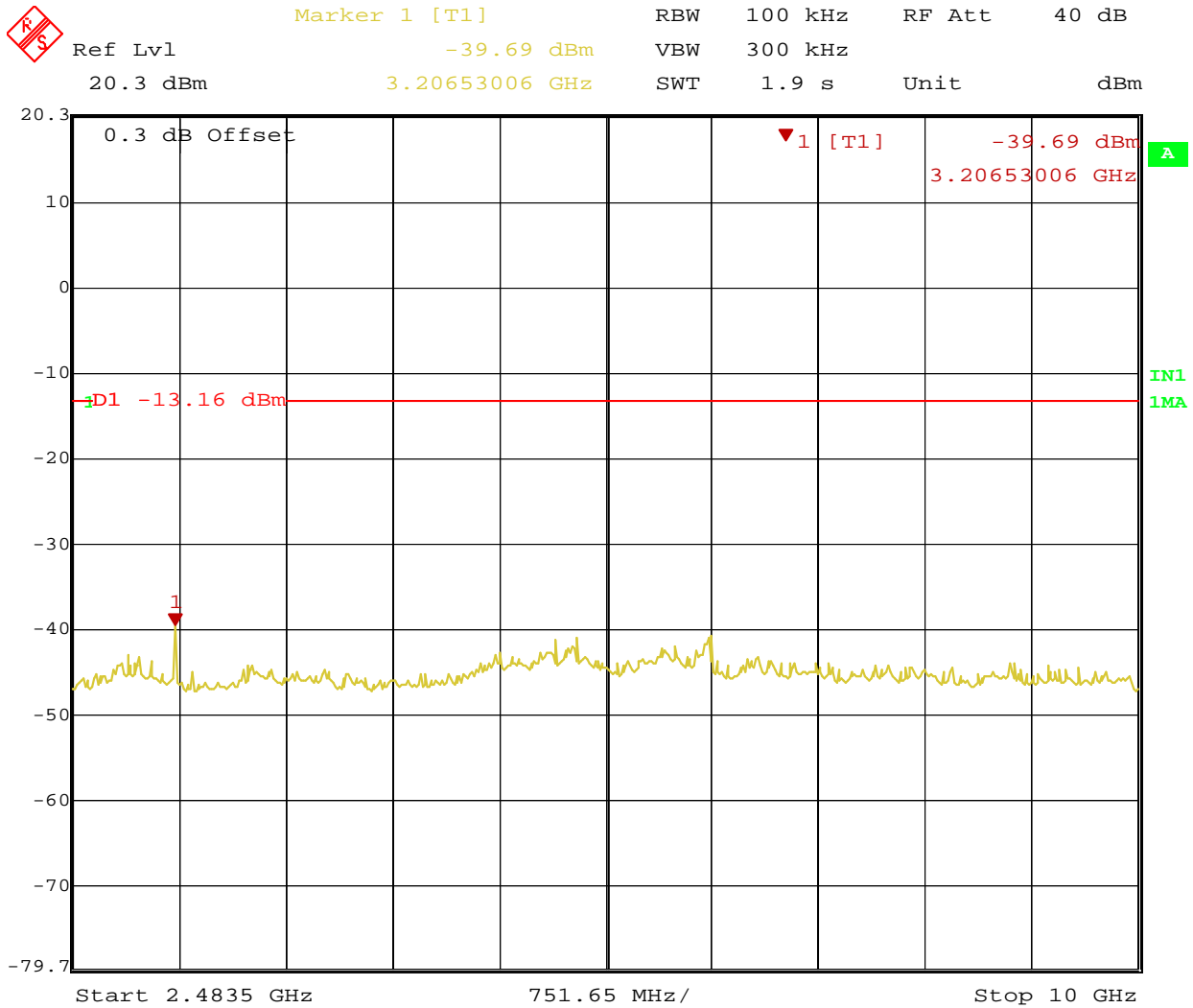

Date: 29.SEP.2009 16:38:55

Figure 33: Out of Band Emission for Channel 2412 MHz at 54 Mbit/s – Band 2

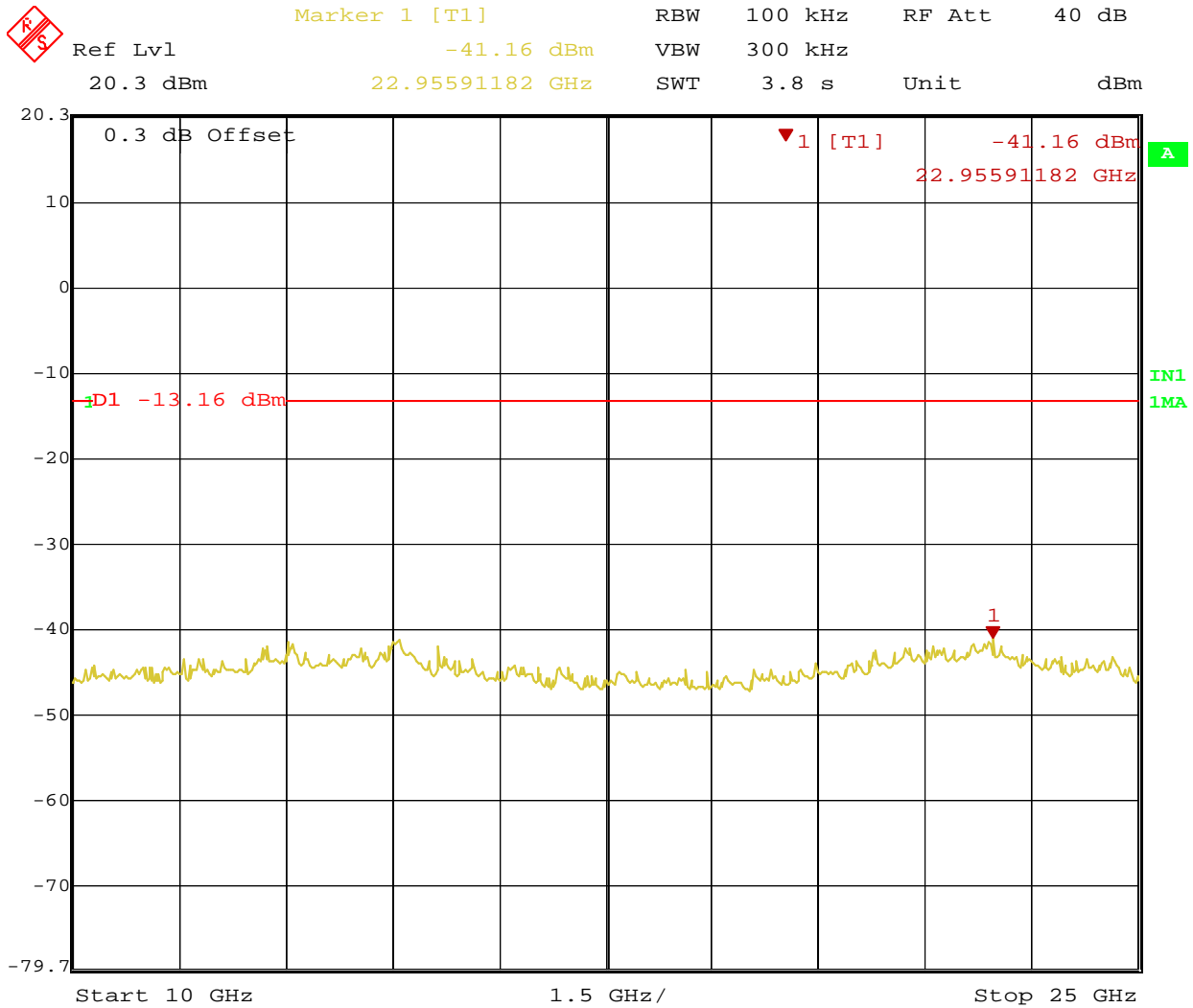

Date: 29.SEP.2009 16:39:44

Figure 34: Out of Band Emission for Channel 2412 MHz at 54 Mbit/s – Band 3

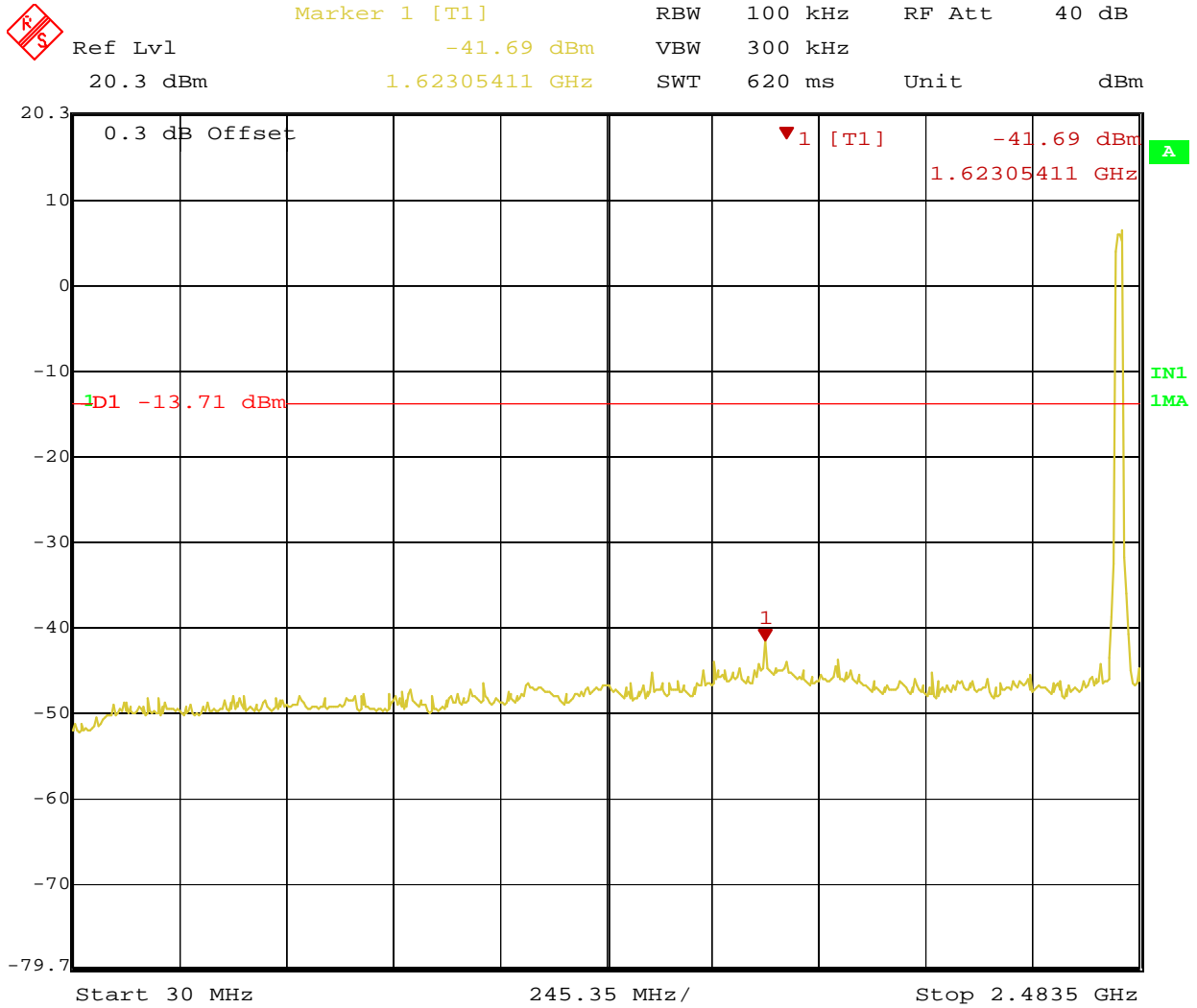

Date: 29.SEP.2009 16:45:54

Figure 35: Out of Band Emission for Channel 2437 MHz at 54 Mbit/s – Band 1

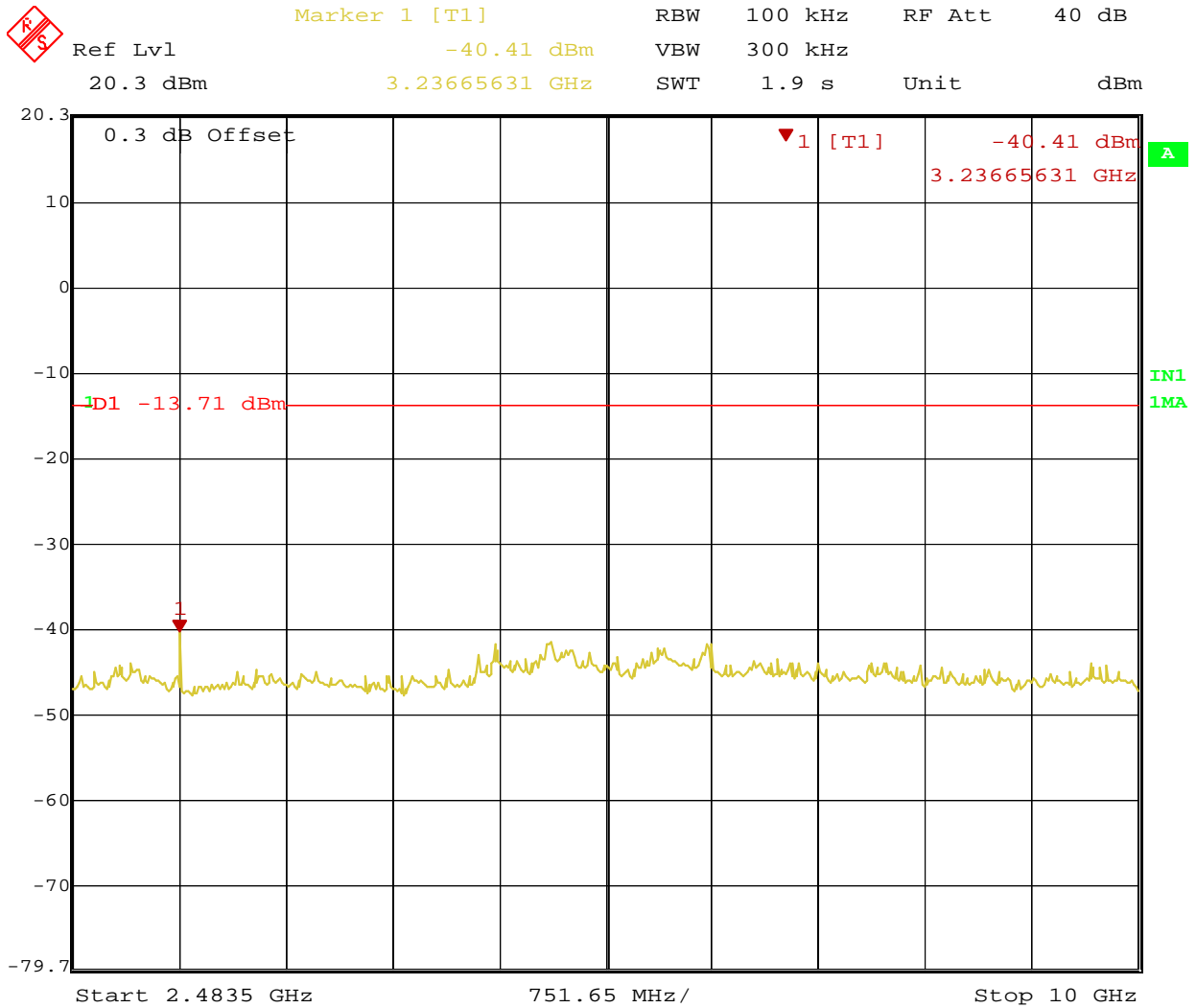
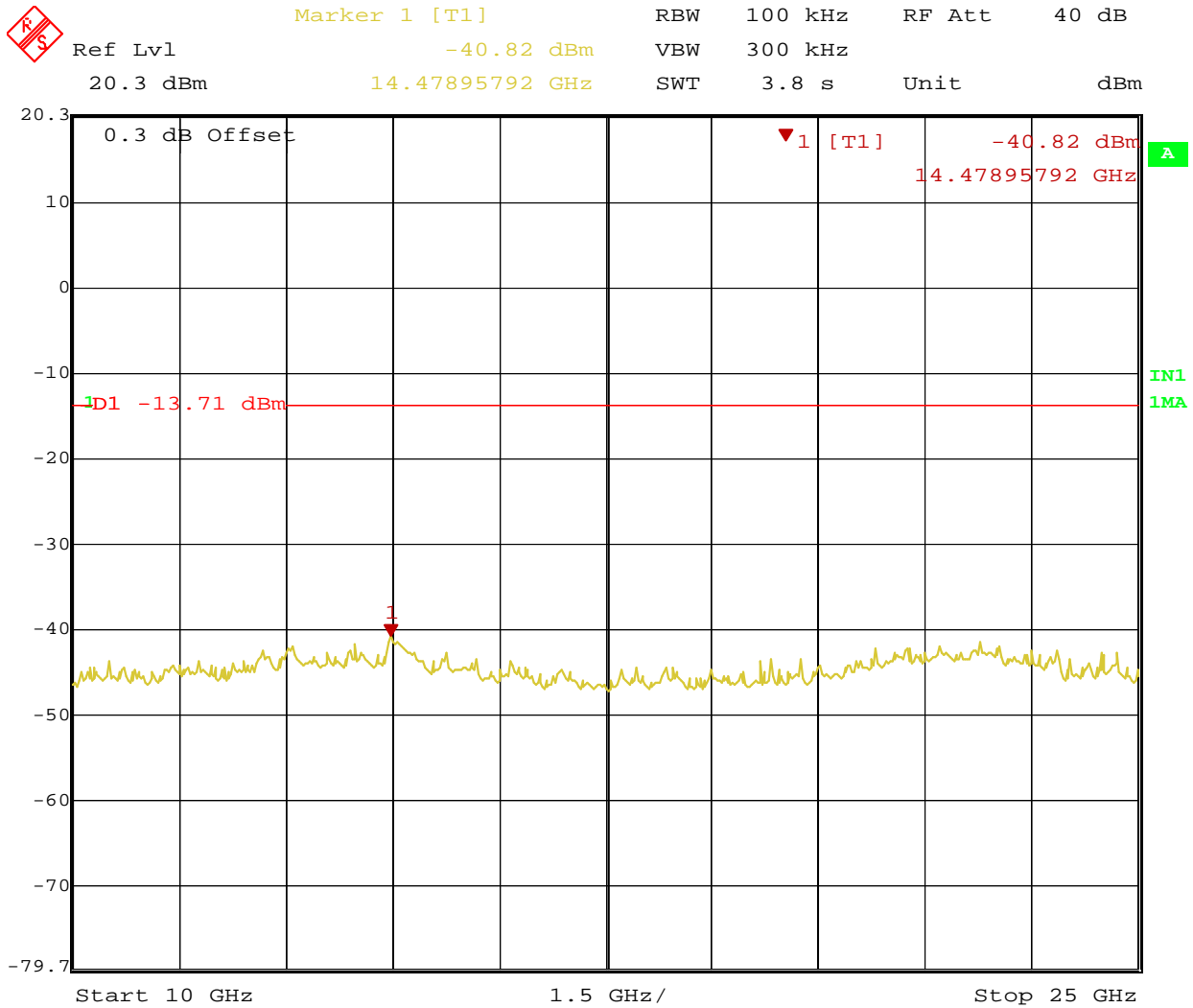
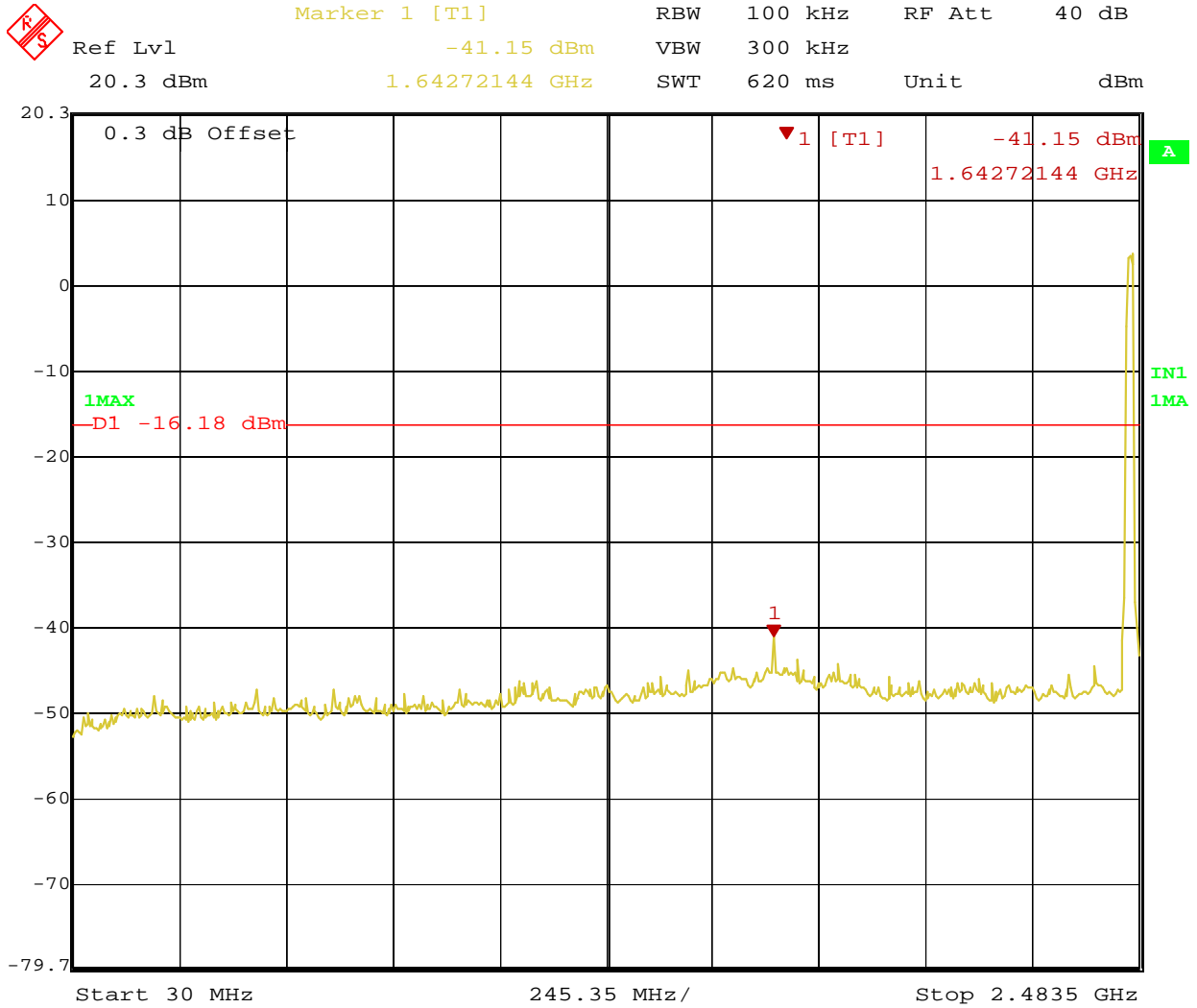

Figure 36: Out of Band Emission for Channel 2437 MHz at 54 Mbit/s – Band 2



Date: 29.SEP.2009 16:47:37

Figure 37: Out of Band Emission for Channel 2437 MHz at 54 Mbit/s – Band 3



Date: 29.SEP.2009 16:50:34

Figure 38: Out of Band Emission for Channel 2462 MHz at 54 Mbit/s – Band 1

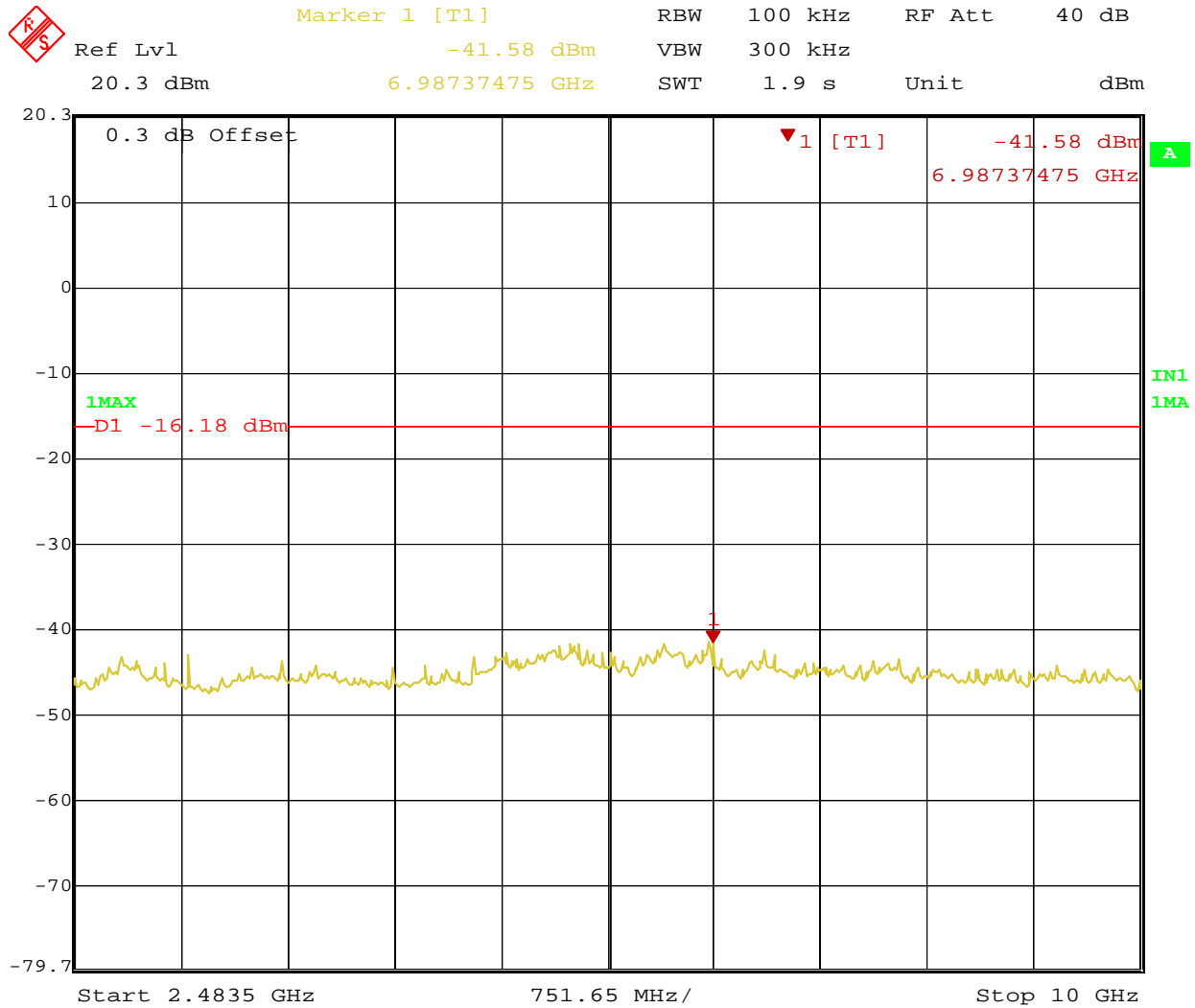

Date: 29.SEP.2009 16:51:46

Figure 39: Out of Band Emission for Channel 2462 MHz at 54 Mbit/s – Band 2

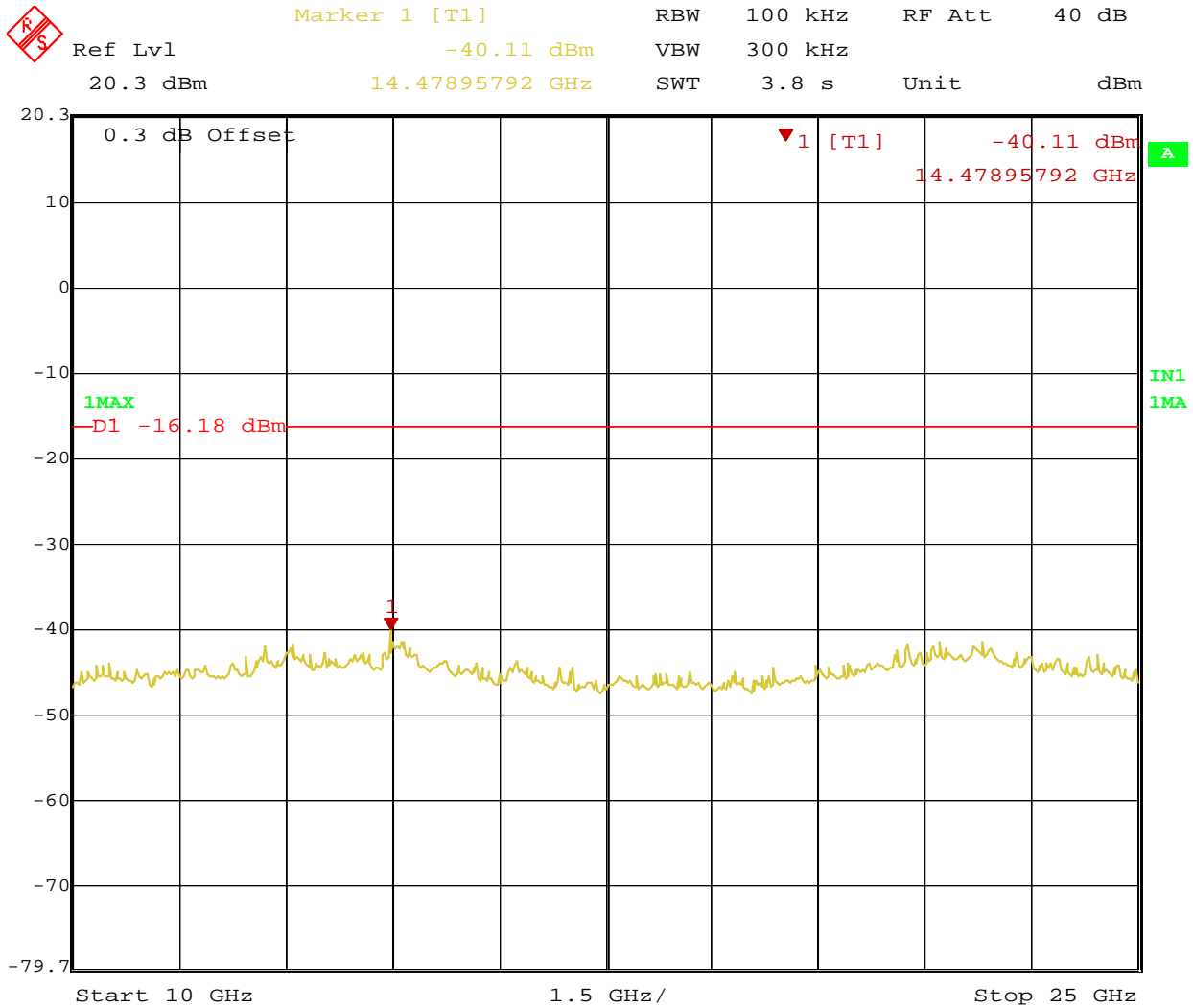

Date: 29.SEP.2009 16:52:19

Figure 40: Out of Band Emission for Channel 2462 MHz at 54 Mbit/s – Band 3

4.4 Peak Power Spectral Density

According to the CFR47 Part 15.247 (e) and RSS 210 (A8.2), the spectral power density output of the antenna port shall be less than 8 dBm in any 3 kHz band during any time interval of continuous transmission.

4.4.1 Test Method

The conducted method was used to measure the channel power output.

The measurement was performed with modulation per CFR47 Part 15.247 (e) and RSS 210 (A8.2). This test was conducted on 3 channels of Sample with MAC Address 00:25:3C:91:43:00. The worst sample result indicated below.

Test Setup:

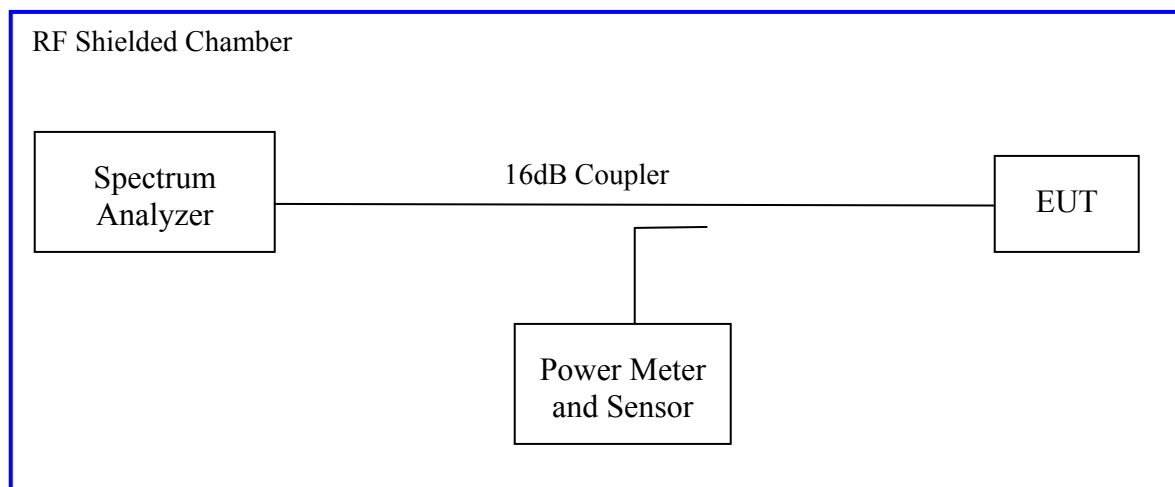

4.4.2 Results

As originally tested, the EUT was found to be compliant to the requirements of the test standard(s).

Table 7: Peak Power Spectral Density – Test Results

Test Conditions: Conducted Measurement, Normal Temperature and Voltage only				
Antenna Type: Integrated		Power Setting: +20dBm		
Signal State: Modulated		Data Rate: 11 Mbps and 54 Mbps		
Ambient Temp: 23° C		Relative Humidity: 35%		
Peak Power Spectral Density Test Results				
Operating Channel	Mode	PPSD [dBm]	Limit [dBm]	Margin [dB]
2412 MHz	11 Mbps	-5.62	8.0	-13.62
2437 MHz	11 Mbps	-5.63	8.0	-13.63
2462 MHz	11 Mbps	-5.46	8.0	-13.46
Operating Channel	Mode	PPSD [dBm]	Limit [dBm]	Margin [dB]
2412 MHz	54 Mbps	-3.03	8.0	-11.03
2437 MHz	54 Mbps	-3.30	8.0	-11.30
2462 MHz	54 Mbps	-5.74	8.0	-13.74

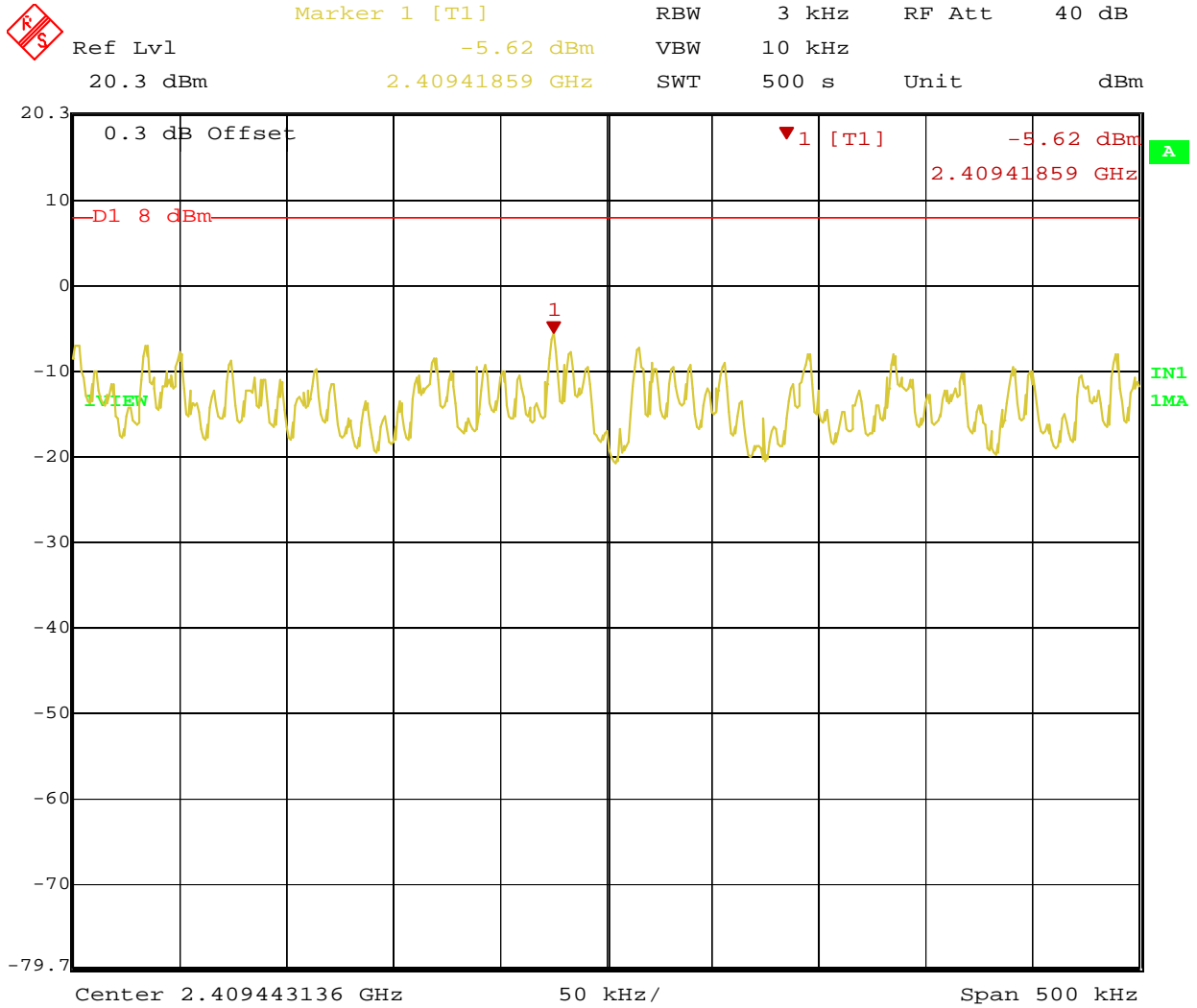

Date: 29.SEP.2009 12:18:54

Figure 41: Peak Power Spectral Density for Operating Channel 2412 MHz – 11 Mbit/s

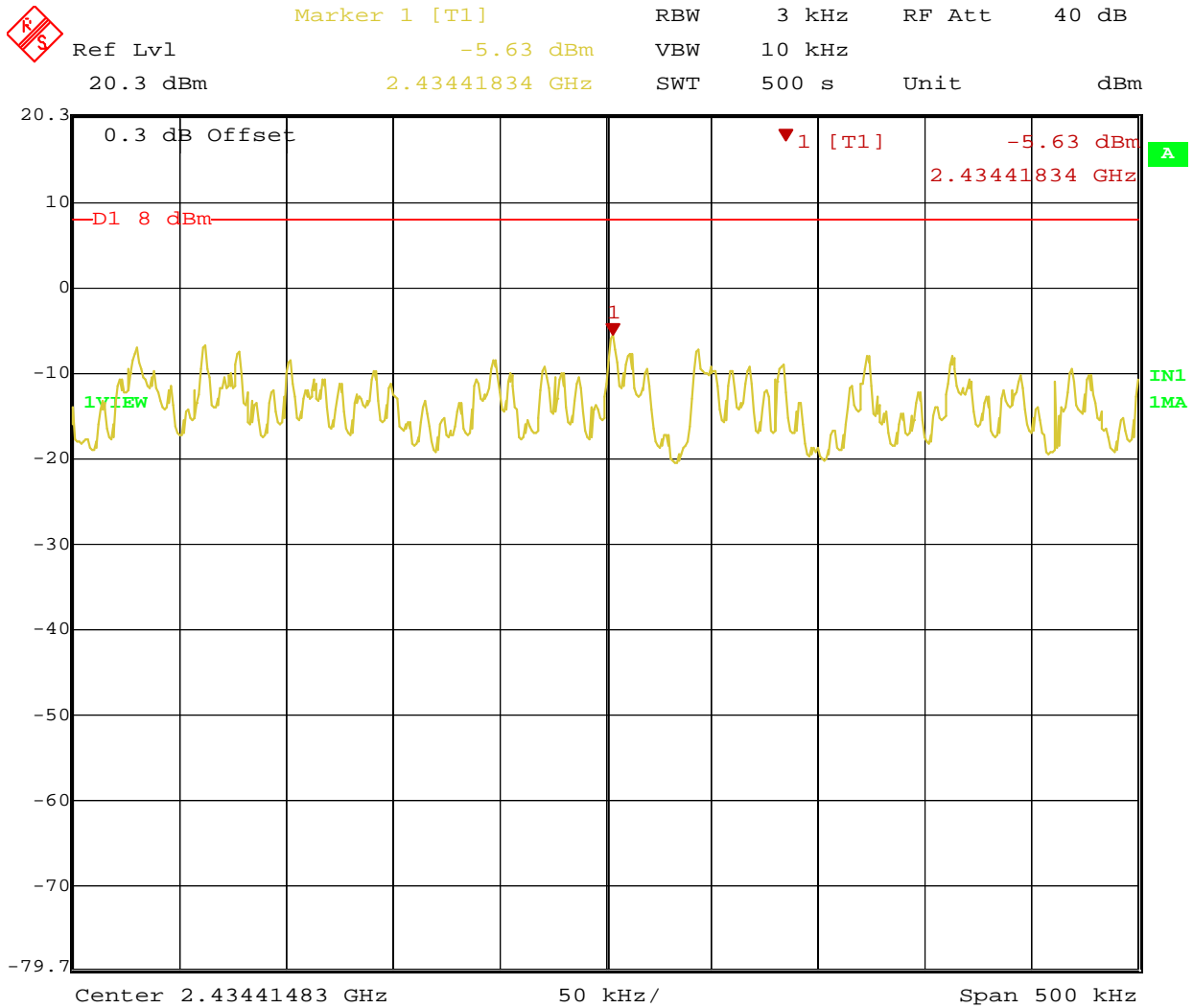

Date: 29.SEP.2009 12:32:31

Figure 42: Peak Power Spectral Density for Operating Channel 2437 MHz – 11 Mbit/s

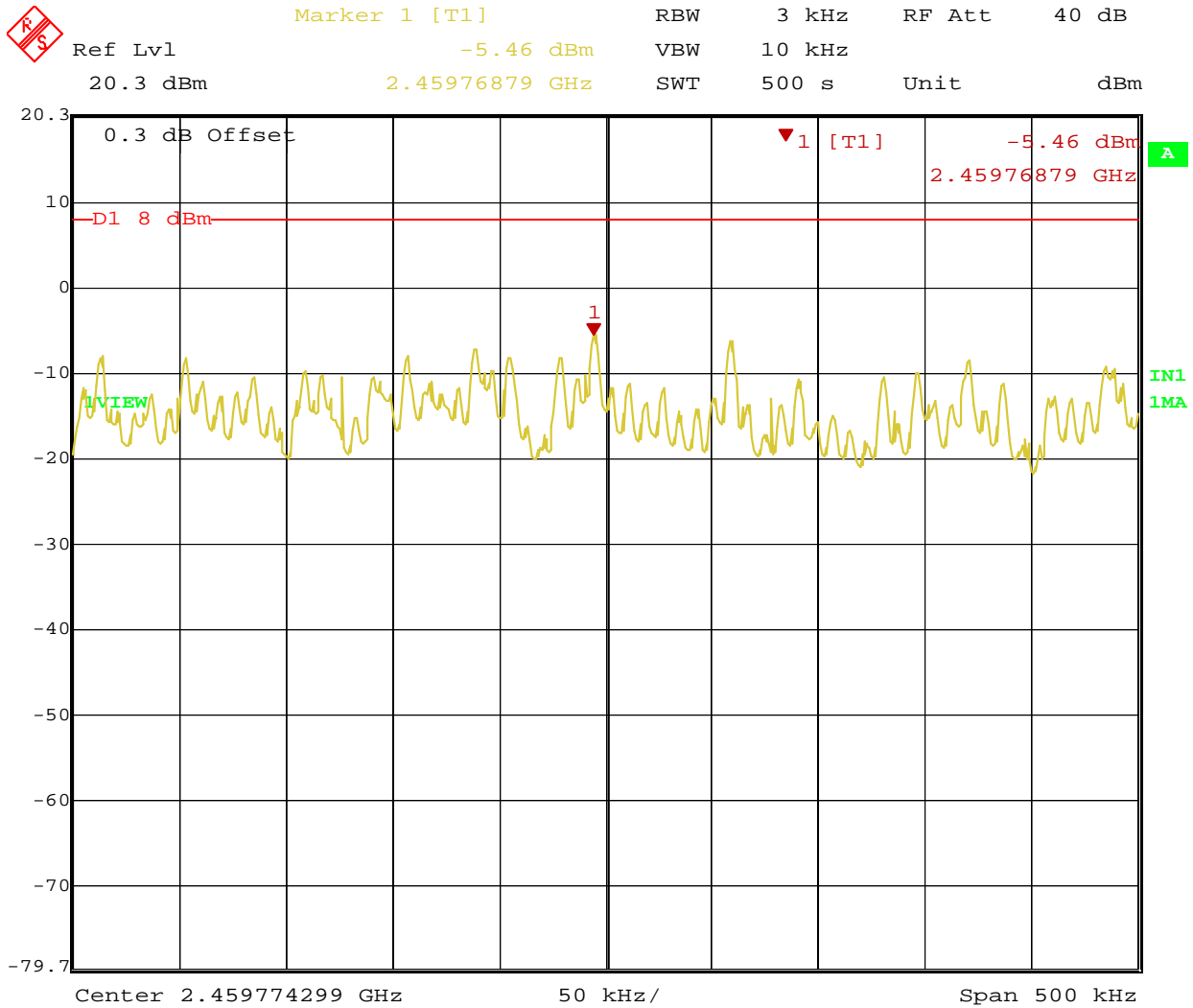

Date: 29.SEP.2009 12:45:47

Figure 43: Peak Power Spectral Density for Operating Channel 2462 MHz – 11 Mbit/s

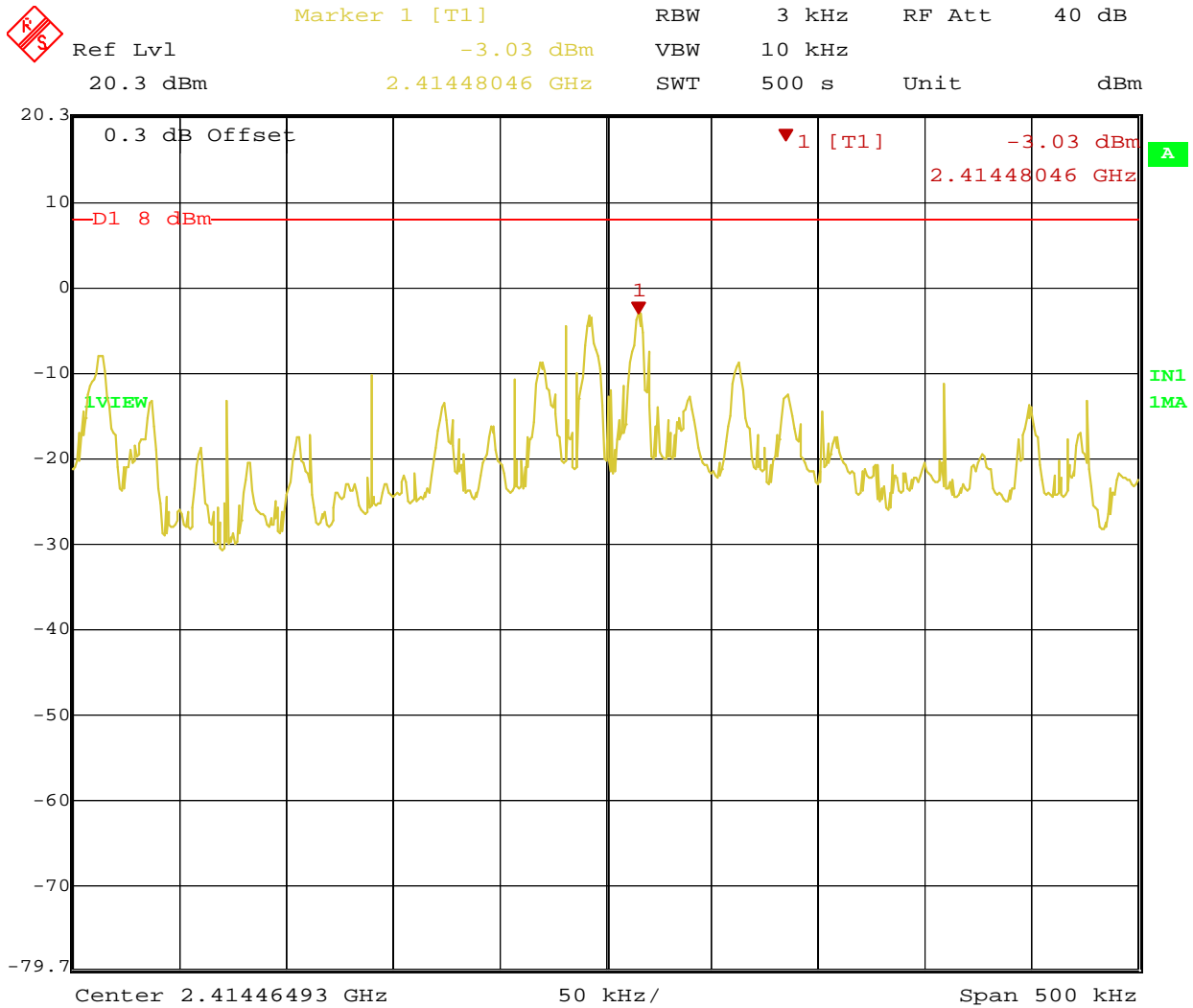

Date: 29.SEP.2009 13:39:28

Figure 44: Peak Power Spectral Density for Operating Channel 2412 MHz – 54 Mbit/s

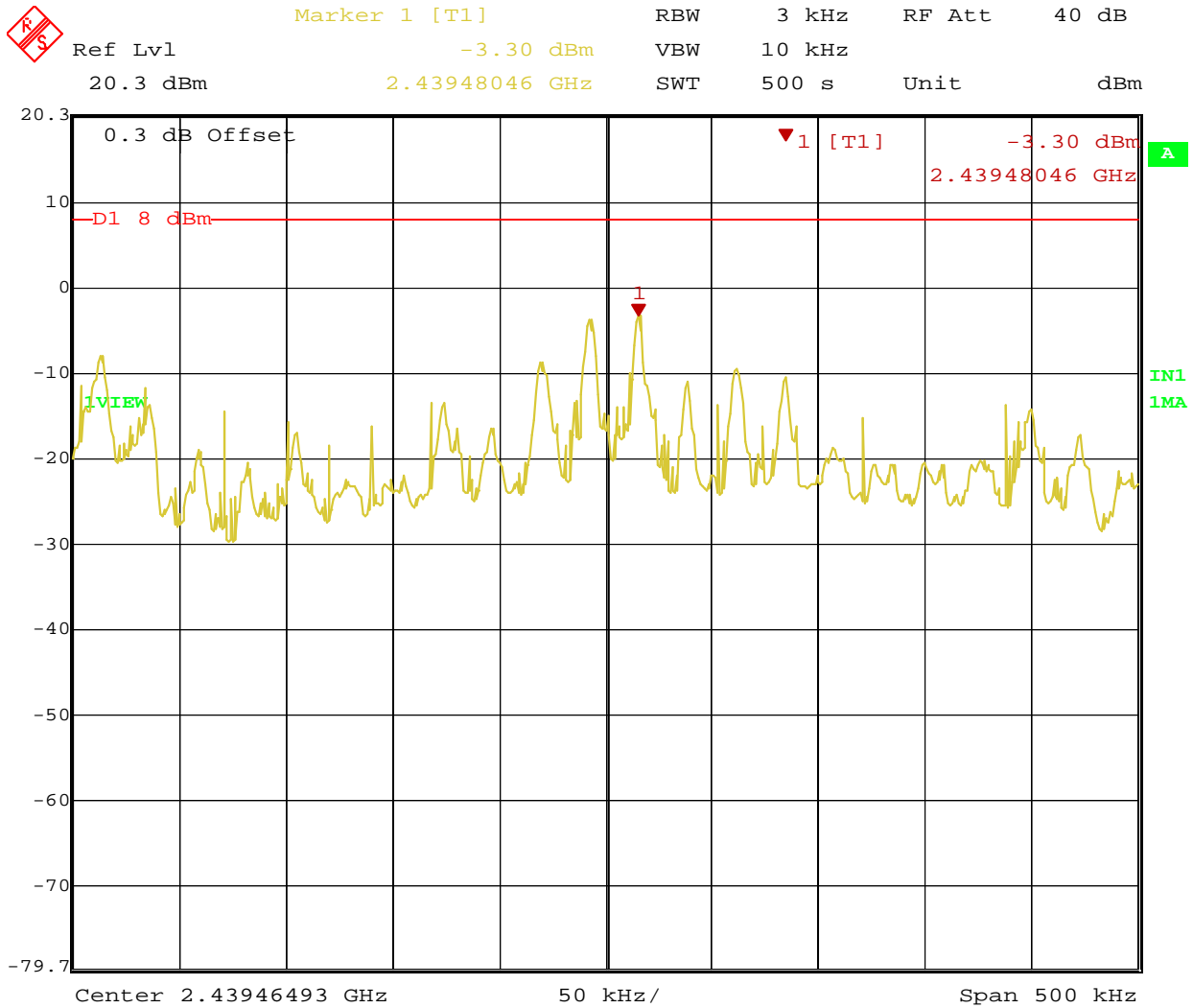

Date: 29.SEP.2009 13:16:04

Figure 45: Peak Power Spectral Density for Operating Channel 2437 MHz – 54 Mbit/s

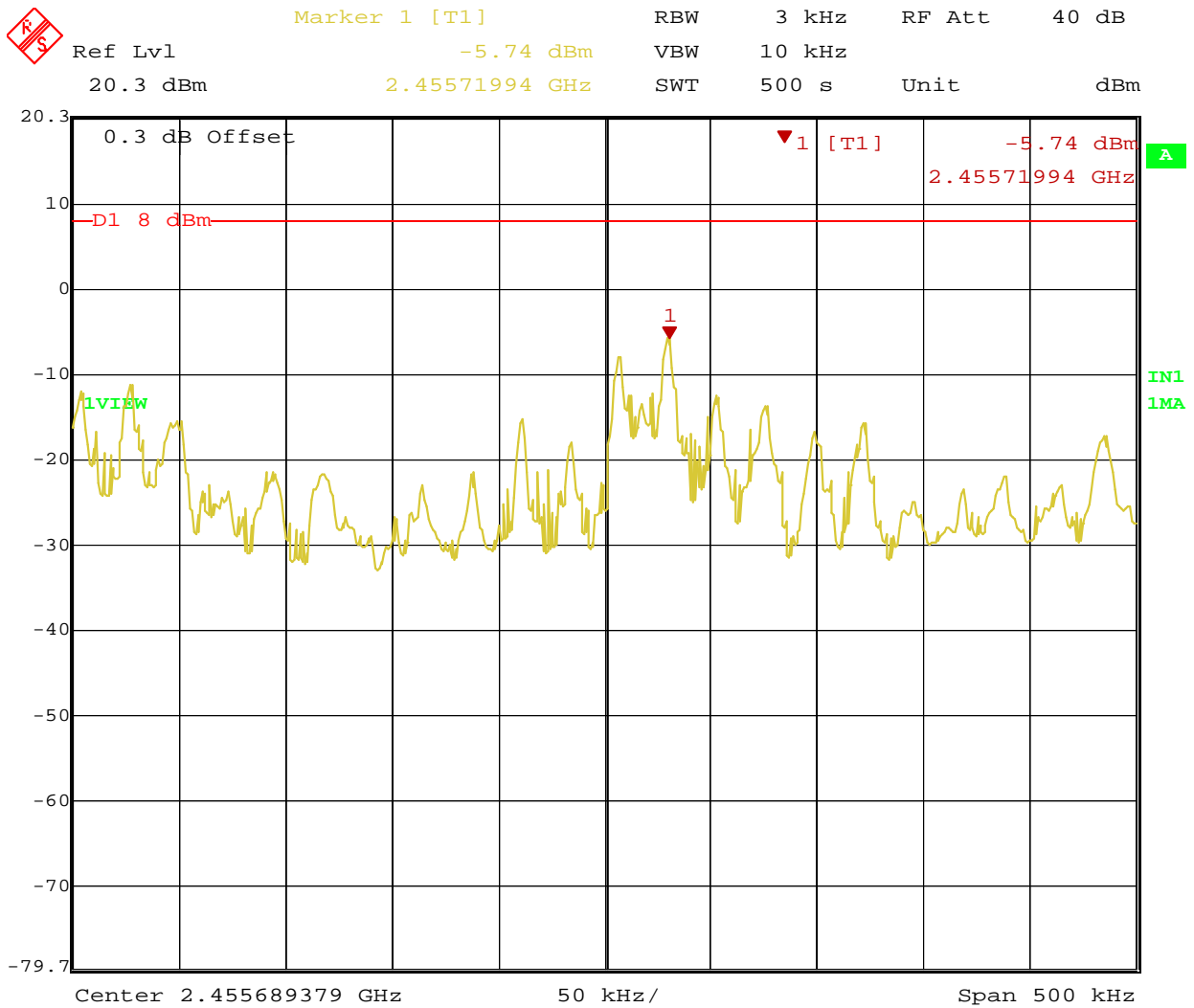

Date: 29.SEP.2009 12:59:57

Figure 46: Peak Power Spectral Density for Operating Channel 2462 MHz – 54 Mbit/s

4.5 Maximum Permissible Exposure

4.5.1 Test Methodology

In this document, we try to prove the safety of radiation harmfulness to the human body for our product. The limit for Maximum Permissible Exposure (MPE) specified in FCC 1.1310 is followed. The Gain of the antenna used in this product is measured in a Semi-Anechoic Chamber, and also the maximum total power input to the antenna is measured. Through the Friis transmission formula and the maximum gain of the antenna, we can calculate the distance, away from the product, where the limit of MPE is reached.

Although the Friis transmission formula is a far field assumption, the calculated result of that is an over-prediction for near field power density. We will take that as the worst case to specify the safety range.

4.5.2 RF Exposure Limit

According to FCC 1.1310 table 1: The criteria listed in the following table shall be used to evaluate the environmental impact of human exposure to radio-frequency (RF) radiation as specified in 1.1307(b)

LIMITS FOR MAXIMUM PERMISSIBLE EXPOSURE (MPE)

Frequency Range (MHz)	Electric Field Strength (V/m)	Magnetic Field Strength (A/m)	Power Density (mW/cm ²)	Average Time (minutes)
(A)Limits For Occupational / Control Exposures				
300 - 1500	F/300	6
1500 - 100,000	5	6
(B)Limits For General Population / Uncontrolled Exposure				
300 - 1500	F/1500	6
1500 - 100,000	1.0	30

F = Frequency in MHz

4.5.3 EUT Operating Condition

The software provided by Manufacturer enabled the EUT to transmit data at lowest, middle and highest channel individually.

4.5.4 Classification

The antenna of the product, under normal use condition, is at least 20cm away from the body of the user. Warning statement to the user for keeping at least 20cm or more separation distance with the antenna should be included in users manual. So, this device is classified as a **Mobile Device**.

4.5.5 Test Results

4.5.5.1 Antenna Gain

The transmitting antenna was integrated. The antenna gain was +2.0 dBi or 1.58 (numeric).

4.5.5.2 Output Power into Antenna & RF Exposure value at distance 20cm:

Calculations for this report are based on highest power measurement.

Limit for MPE (from FCC part 1.1310 table1) is 1.0 mW/cm²

The highest measured EIRP power is +25.73 dBm or 374.11 mW

Using the Friis transmission formula, the EIRP is Pout*G, and R is 20cm.

$P_d = (374.11 * 1.58) / (1600\pi) = 0.1176 \text{ mW/cm}^2$, which is 0.8823 mW/cm² below to the limit.

As originally tested, the EUT was found to be compliant to the requirements of the test standard(s).

4.5.6 Sample Calculation

The Friis transmission formula: $P_d = (P_{out} * G) / (4 * \pi * R^2)$

Where;

Pd = power density in mW/cm²

Pout = output power to antenna in mW

G = gain of antenna in linear scale

$\pi \approx 3.1416$

R = distance between observation point and center of the radiator in cm

Ref. : David K. Cheng, *Field and Wave Electromagnetics*, Second Edition, Page 640, Eq. (11-133).

4.6 Transmitter Spurious Emissions

Transmitter spurious emissions are emissions outside the frequency range of the equipment when the equipment is in transmit mode; per requirement of CFR47 15.205, 15.209, 15.247(d), RSS 210 Sect. A.8.5

4.6.1 Test Methodology

4.6.1.1 Preliminary Test

A test program that controls instrumentation and data logging was used to automate the preliminary RF emission test procedure. The frequency range of interest was divided into sub-ranges to yield a frequency resolution of approximately 120 kHz and provide a reading at each frequency for no more than 12° of turntable rotation. For each frequency sub-range the turntable was rotated 360° while peak emission data was recorded and plotted over the frequency range of interest in horizontal and vertical antenna polarization's.

Preliminary emission profile testing was performed inside the anechoic chamber. The EUT was placed on a 1.0m x 1.5m non-conductive table 80cm above the floor. The EUT was positioned as shown in the setup photographs. The receiving antenna was placed at a distance of 3m at a fixed height of 1m. Measurement equipment was located outside of the chamber. A video camera was placed inside the chamber to view the EUT.

The preliminary tests performed for both 802.11b and g modes at different data rate and positions. The worst mode was 802.11b at 1 Mbps on horizontal position.

4.6.1.2 Final Test

For each frequency measured, the peak emission was maximized by manipulating the receiving antenna from 1 to 4 meters above the ground plane and placing it at the position that produced the maximum signal strength reading. The turntable was then rotated through 360° while observing the peak signal and placing the EUT at the position that produced maximum radiation. The six highest emissions relative to the limit were measured unless such emissions were more than 20 dB below the limit. If less than six emissions are within 20 dB of the limit, than the noise level of the receiver is measured at frequencies where emissions are expected. Multiples of all oscillator and microprocessor frequencies were also checked.

Final testing was performed on an NSA compliant test site. The EUT was placed on a 1.0m x 1.5m non-conductive table 80cm above the ground plane. The placement of EUT and cables were the same as for preliminary testing and is shown in the setup photographs.

The final scans performed for three operating channels; 2412 MHz, 2437 MHz, and 2462 MHz at 1 Mbps on horizontal position.

4.6.1.3 Deviations

None.

4.6.2 Transmitter Spurious Emission Limit

The spurious emissions of the transmitter shall not exceed the values in CFR47 Part 15.205, 15.209: 2008 and RSS 210 A1.1.2 2007.

Frequency (MHz)	Field strength (microvolts/meter)	Measurement distance (meters)
0.009-0.490.....	2400/F (kHz)	300
0.490-1.705.....	24000/F (kHz)	30
1.705-30.0.....	30	30
30-88.....	100 **	3
88-216.....	150 **	3
216-960.....	200 **	3
Above 960.....	500	3

All harmonics and spurious emission which are outside of the restricted band shall be 20dB below the in-band emission.

4.6.3 Test Results

The final measurement data was taken under the worst case operating modes, configurations, and/or cable positions. It also reflects the results including any modifications and/or special accessories listed in Sections 1.4 and 1.5.

As originally tested, the EUT was found to be compliant to the requirements of the test standard(s).

SOP 1 Radiated Emissions							Tracking # 30952981.001 Page 1 of 8				
EUT Name	Wireless ADSL Residential Gateway						Date	September 25, 2009			
EUT Model	HomePortal 4011G/4010G						Temp / Hum in	22° C / 35% rh			
EUT Serial	MAC - 00:25:3C:91:43:00						Temp / Hum out	N/A			
EUT Config.	Integrated Antenna, Tabletop						Line AC / Freq	120Vac/60Hz			
Standard	CFR47 Part 15 Subpart C						RBW / VBW	120kHz / 300kHz			
Dist/Ant Used	3m / JB3						Performed by	Jeremy Luong			
Emission Freq (MHz)	ANT Polar (H/V)	Table Pos (deg)	ANT Pos (cm)	FIM (Pk) (dBuV/m)	FIM (QP) (dBuV/m)	Total CF (dBuV)	E-Field (dBuV/m)	Spec Limit (dBuV/m)	Spec Margin (dB)	Type	
Transmitted Data at 2412 MHz											
360.01	H	4	133	41.71	41.12	-7.27	33.85	46.02	-12.17	Spurious	
375.01	H	265	103	40.98	40.18	-7.21	32.97	46.02	-13.05	Spurious	
625.00	H	336	147	41.20	40.59	-3.20	37.39	46.02	-8.63	Spurious	
73.64	V	68	133	49.65	42.70	-16.18	26.52	40.00	-13.48	Spurious	
120.01	V	322	110	44.60	42.93	-9.96	32.97	43.52	-10.55	Spurious	
600.01	V	307	111	41.62	41.08	-3.91	37.17	46.02	-8.85	Spurious	
Transmitted Data at 2437 MHz											
60.20	V	351	166	48.85	44.24	-16.78	27.46	40.00	-12.54	Spurious	
101.90	V	302	107	50.72	44.67	-14.12	30.55	43.52	-12.97	Spurious	
600.01	V	341	108	41.55	41.21	-3.91	37.30	46.02	-8.72	Spurious	
375.01	H	132	108	42.43	42.07	-7.21	34.86	46.02	-11.16	Spurious	
500.00	H	172	110	36.55	35.53	-5.56	29.97	46.02	-16.05	Spurious	
600.00	H	331	175	41.54	40.36	-3.91	36.45	46.02	-9.57	Spurious	
Transmitted Data at 2462 MHz											
359.97	H	35	106	41.71	42.36	-7.27	35.09	46.02	-10.93	Spurious	
375.00	H	130	106	45.76	45.45	-7.21	38.24	46.02	-7.78	Spurious	
624.99	H	323	149	41.66	41.02	-3.20	37.82	46.02	-8.20	Spurious	
73.64	V	174	195	28.17	24.60	-16.18	8.42	40.00	-31.58	Spurious	
120.00	V	270	108	45.03	43.36	-9.96	33.40	43.52	-10.12	Spurious	
600.00	V	324	108	41.98	41.53	-3.91	37.62	46.02	-8.40	Spurious	
Spec Margin = E-Field QP - Limit, E-Field QP = FIM QP+ Total CF ± Uncertainty											
Total CF= Amp Gain + Cable Loss + ANT Factor											
Combined Standard Uncertainty $u_c(y) = \pm 1.6\text{dB}$ Expanded Uncertainty $U = ku_c(y)$ $k = 2$ for 95% confidence											
Notes: Tested at worst case at 1MBit/s.											

SOP 1 Radiated Emissions							Tracking # 30952981.001 Page 2 of 8			
EUT Name	Wireless ADSL Residential Gateway					Date	September 23, 2009			
EUT Model	HomePortal 4011G/4010G					Temp / Hum in	22° C / 38% rh			
EUT Serial	MAC - 00:25:3C:91:43:00					Temp / Hum out	N/A			
EUT Config.	Integrated Antenna, Tabletop Position					Line AC / Freq	120Vac/60Hz			
Standard	CFR47 Part 15 Subpart C					RBW / VBW	1MHz / 3MHz			
Dist/Ant Used	3m / EMCO3115					Performed by	Jeremy Luong			
Emission Freq (MHz)	ANT Polar (H/V)	Table Pos (deg)	ANT Pos (cm)	FIM (Pk) (dBuV/m)	FIM Ave (dBuV/m)	Total CF (dBuV)	E-Field Ave (dBuV/m)	Spec Limit (dBuV/m)	Spec Margin (dB)	Type
Transmitted Data at 2412 MHz										
1607.93	H	276	149	50.81	49.00	-3.87	45.13	53.98	-8.85	Spurious
1608.00	V	163	148	50.52	48.51	-3.91	44.60	53.98	-9.38	Spurious
3216.00	H	320	128	49.26	47.02	1.98	49.00	53.98	-4.98	Spurious
3216.04	V	301	238	49.47	46.97	1.87	48.84	53.98	-5.14	Spurious
Transmitted Data at 2437 MHz										
1624.64	H	349	218	51.7	49.9	-3.79	46.11	53.98	-7.87	Spurious
1624.69	V	335	217	50.82	48.86	-3.84	45.02	53.98	-8.96	Spurious
3249.27	V	272	202	51.03	49.39	1.98	51.37	53.98	-2.61	Spurious
3249.32	H	324	237	50.92	49.14	2.08	51.22	53.98	-2.76	Spurious
Transmitted Data at 2462 MHz										
1641.27	V	221	212	48.02	46.12	-3.76	42.36	53.98	-11.62	Spurious
1641.27	H	184	213	51.72	50.46	-3.71	46.75	53.98	-7.23	Spurious
3282.66	V	278	142	49.39	47.03	2.11	49.14	53.98	-4.84	Spurious
3282.69	H	74	149	46.22	42.72	2.19	44.91	53.98	-9.07	Spurious
Spec Margin = E-Field QP - Limit, E-Field QP = FIM QP+ Total CF ± Uncertainty										
Total CF= Amp Gain + Cable Loss + ANT Factor										
Combined Standard Uncertainty $u_c(y) = \pm 1.6\text{dB}$ Expanded Uncertainty $U = ku_c(y)$ $k = 2$ for 95% confidence										
Notes: Tested at worst case at 1MBit/s.										

SOP 1 Radiated Emissions

Tracking # 30952981.001 Page 3 of 8

EUT Name	Wireless ADSL Residential Gateway	Date	September 25, 2009
EUT Model	HomePortal 4011G/4010G	Temp / Hum in	22° C / 38% rh
EUT Serial	MAC - 00:04:20:26:00:32	Temp / Hum out	N/A
EUT Config.	Integrated Antenna, Tabletop Position	Line AC	120Vac 60Hz
Standard	CFR47 Part 15 Subpart C	RBW / VBW	120kHz / 300kHz
Dist/Ant Used	3m / JB3	Performed by	Jeremy Luong

30 MHz to 1000 MHz Plot for Transmit Mode at 2412 MHz

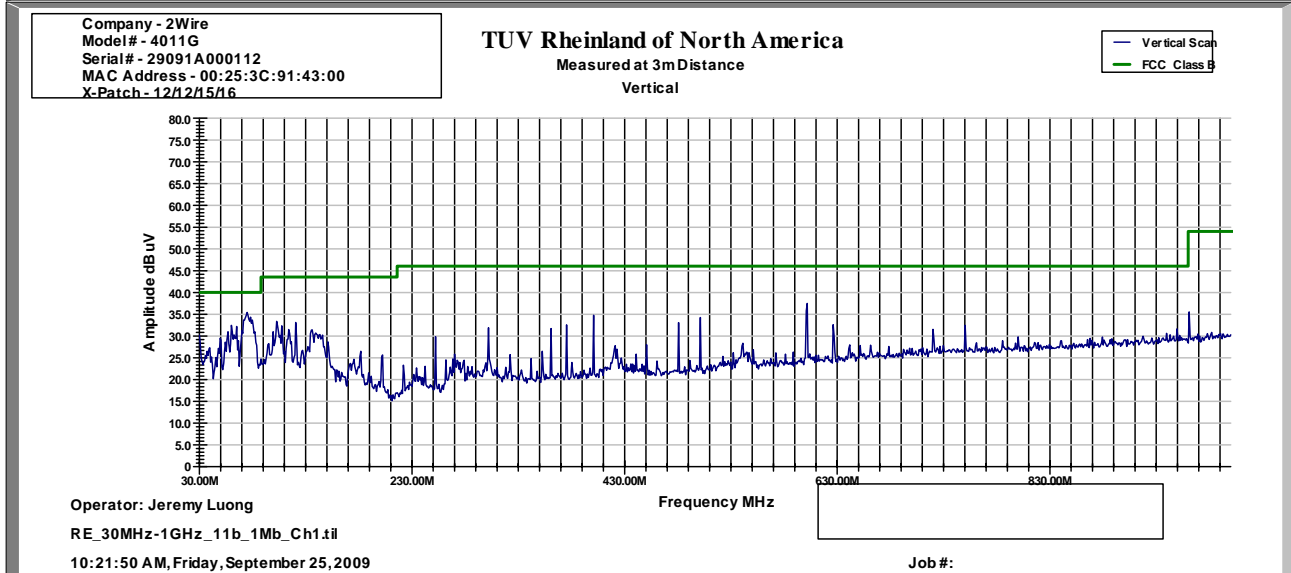
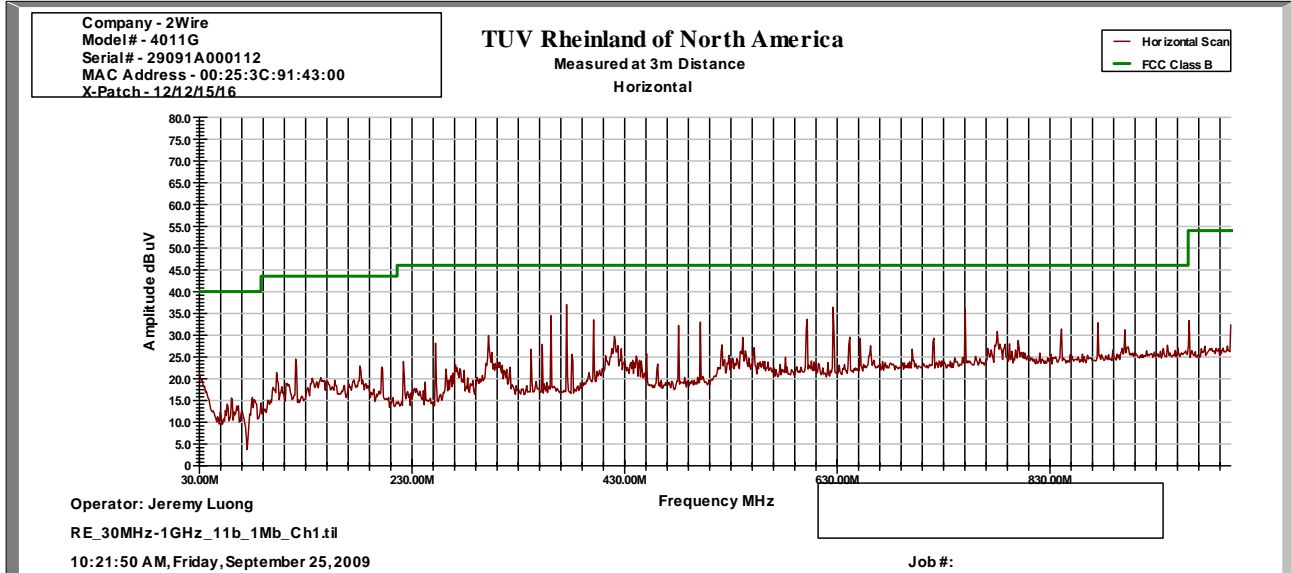

Notes: None.

SOP 1 Radiated Emissions

Tracking # 30952981.001 Page 4 of 8

EUT Name	Wireless ADSL Residential Gateway	Date	September 25, 2009
EUT Model	HomePortal 4011G/4010G	Temp / Hum in	23° C / 35% rh
EUT Serial	MAC - 00:25:3C:91:43:00	Temp / Hum out	N/A
EUT Config.	Integrated Antenna, Tabletop Position	Line AC	120Vac 60Hz
Standard	CFR47 Part 15 Subpart C	RBW / VBW	120kHz / 300kHz
Dist/Ant Used	3m / JB3	Performed by	Jeremy Luong

30 MHz to 1000 MHz Plot for Transmit Mode at 2437 MHz

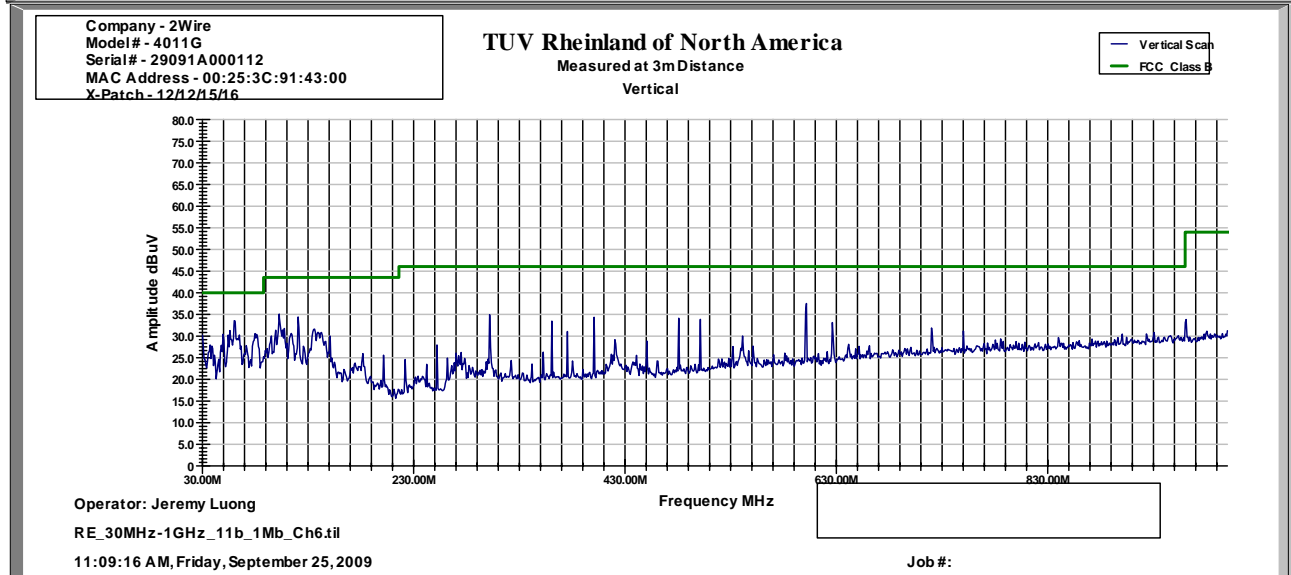
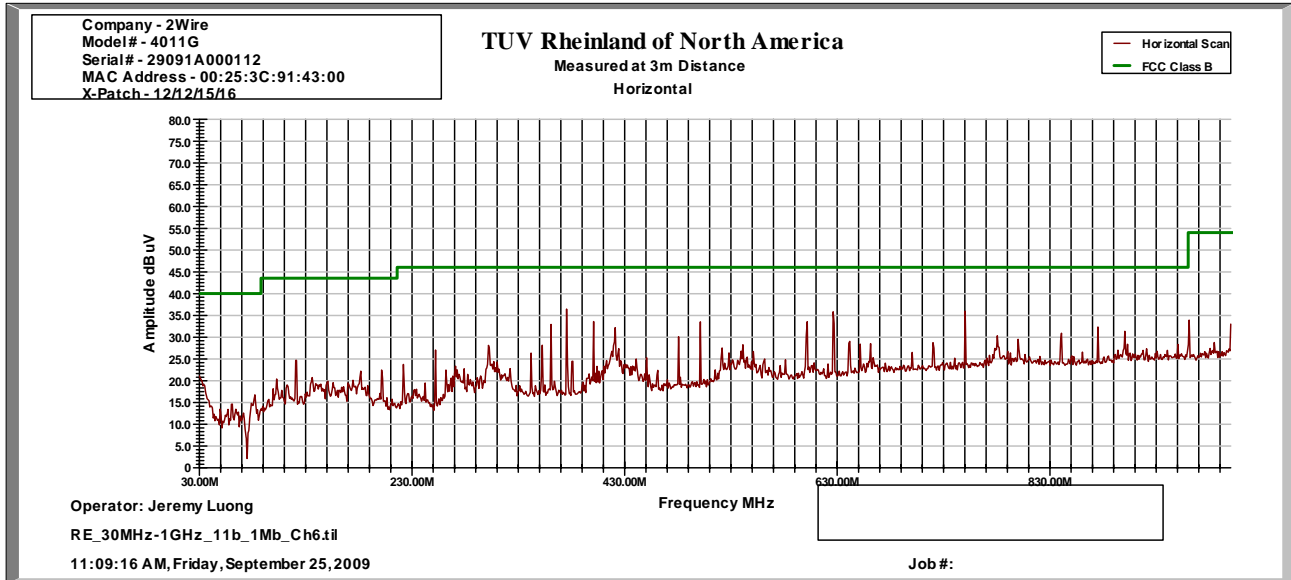

Notes: None.

SOP 1 Radiated Emissions

Tracking # 30952981.001 Page 5 of 8

EUT Name	Wireless ADSL Residential Gateway	Date	September 25, 2009
EUT Model	HomePortal 4011G/4010G	Temp / Hum in	22° C / 35% rh
EUT Serial	MAC - 00:25:3C:91:43:00	Temp / Hum out	N/A
EUT Config.	Integrated Antenna, Tabletop Position	Line AC	120Vac 60Hz
Standard	CFR47 Part 15 Subpart C	RBW / VBW	120kHz / 300kHz
Dist/Ant Used	3m / JB3	Performed by	Jeremy Luong

30 MHz to 1000 MHz Plot for Transmit Mode at 2462 MHz

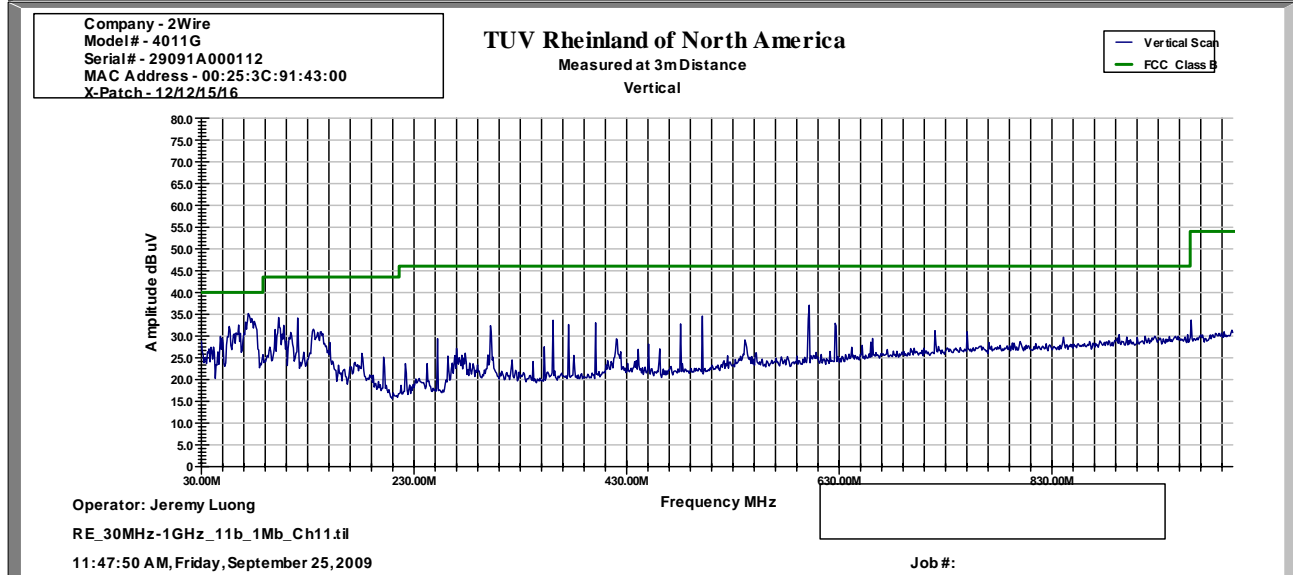
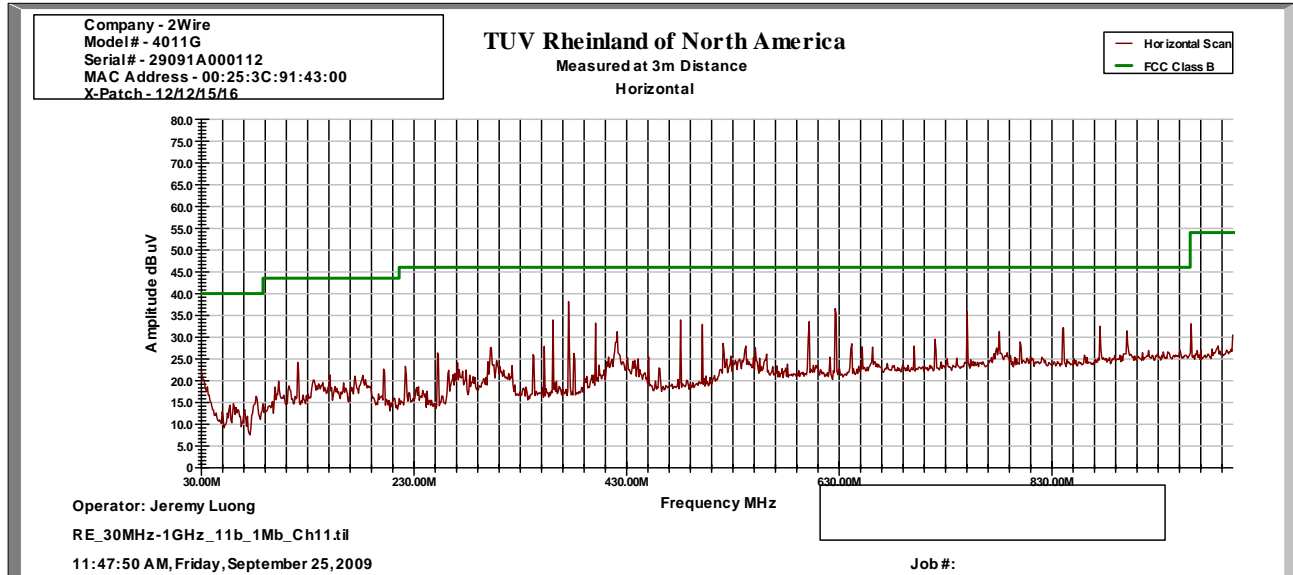

Notes: None.

SOP 1 Radiated Emissions

Tracking # 30952981.001 Page 6 of 8

EUT Name	Wireless ADSL Residential Gateway	Date	September 24, 2009
EUT Model	HomePortal 4011G/4010G	Temp / Hum in	22° C / 38% rh
EUT Serial	MAC - 00:25:3C:91:43:00	Temp / Hum out	N/A
EUT Config.	Integrated Antenna, Tabletop Position	Line AC	120Vac/60Hz
Standard	CFR47 Part 15 Subpart C	RBW / VBW	1MHz / 3MHz
Dist/Ant Used	1m and 3m / EMCO3115 & RA42-K-F-4B-C	Performed by	Jeremy Luong

1 GHz to 25 GHz Plots for Transmit Mode at 2412 MHz

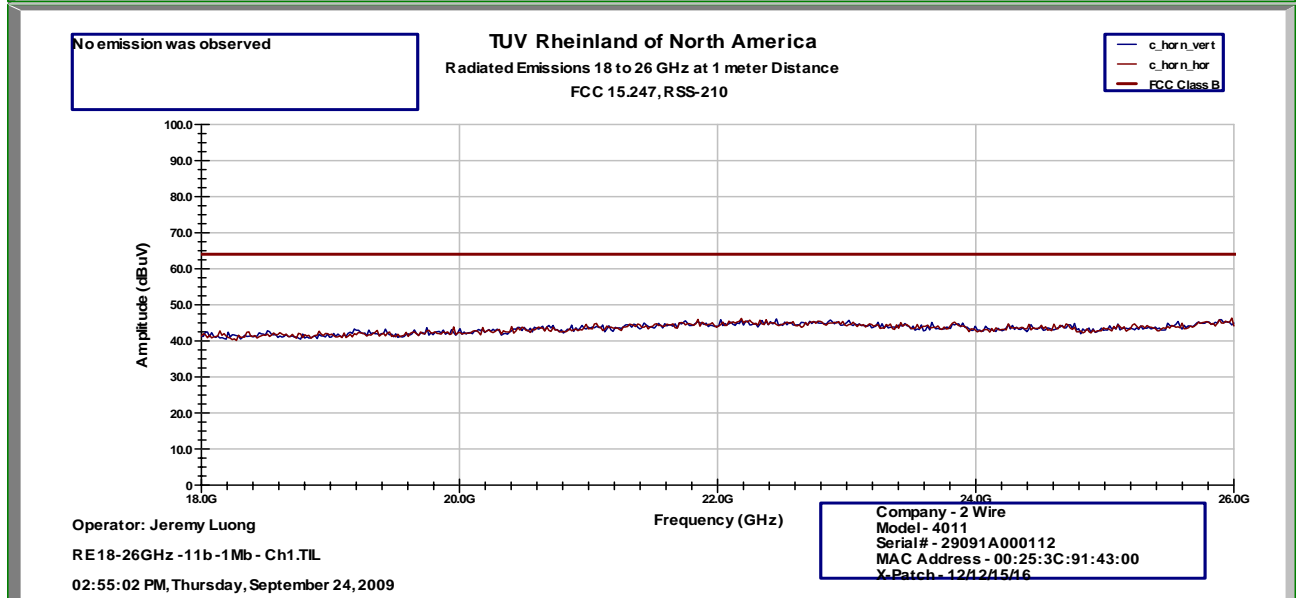
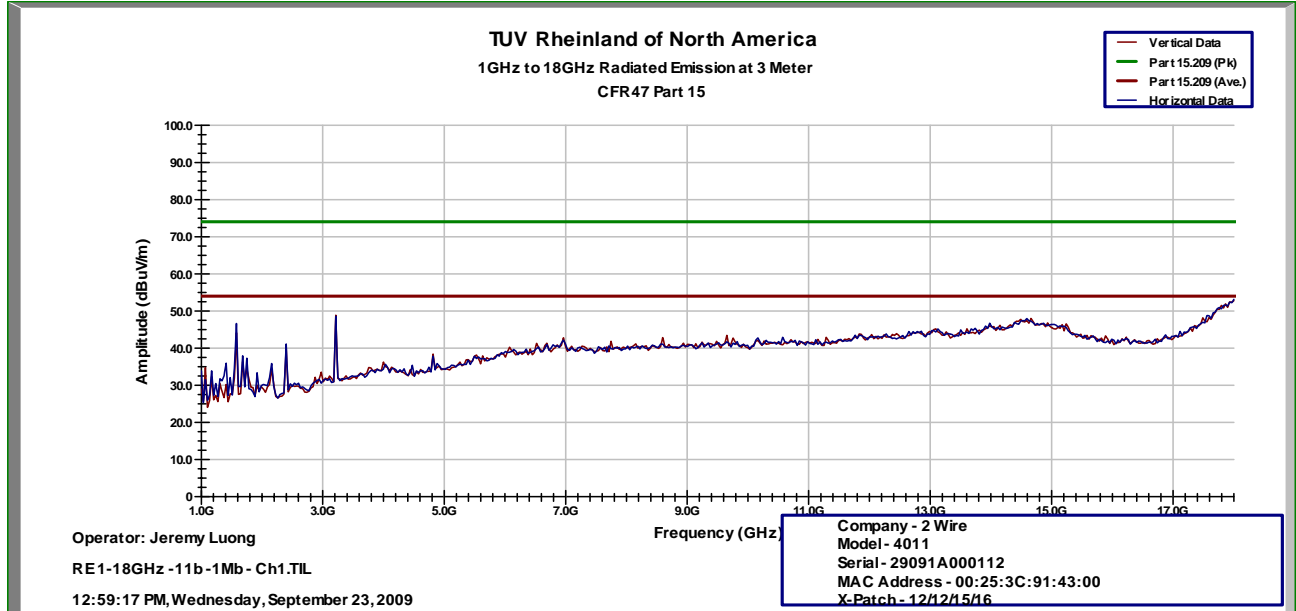

Notes: None.

SOP 1 Radiated Emissions

Tracking # 30952981.001 Page 7 of 8

EUT Name	Wireless ADSL Residential Gateway	Date	September 25, 2009
EUT Model	HomePortal 4011G/4010G	Temp / Hum in	23° C / 38% rh
EUT Serial	MAC - 00:25:3C:91:43:00	Temp / Hum out	N/A
EUT Config.	Integrated Antenna, Tabletop Position	Line AC	120Vac 60Hz
Standard	CFR47 Part 15 Subpart C	RBW / VBW	1MHz / 3MHz
Dist/Ant Used	1m and 3m / EMCO3115 & RA42-K-F-4B-C	Performed by	Jeremy Luong

1 GHz to 25 GHz Plots for Transmit Mode at 2437 MHz

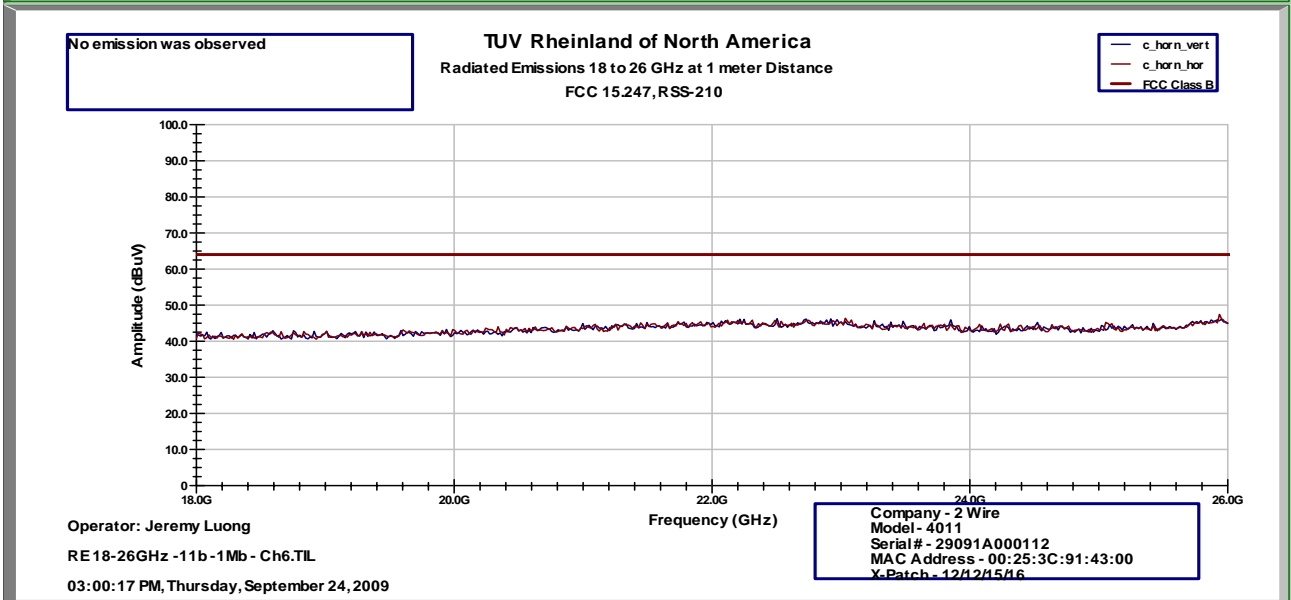
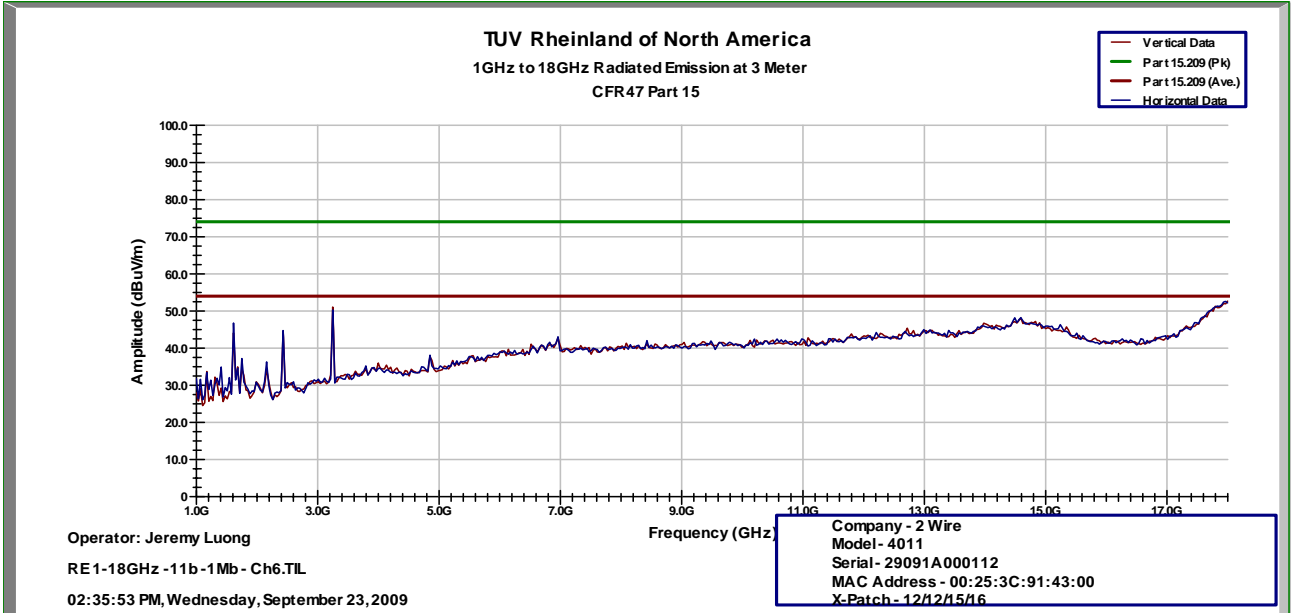

Notes: None.

SOP 1 Radiated Emissions

Tracking # 30952981.001 Page 8 of 8

EUT Name	Wireless ADSL Residential Gateway	Date	September 25, 2009
EUT Model	HomePortal 4011G/4010G	Temp / Hum in	23° C / 38% rh
EUT Serial	MAC - 00:25:3C:91:43:00	Temp / Hum out	N/A
EUT Config.	Integrated Antenna, Tabletop Position	Line AC	120Vac/60Hz
Standard	CFR47 Part 15 Subpart C	RBW / VBW	1MHz / 3MHz
Dist/Ant Used	1m and 3m / EMCO3115 & RA42-K-F-4B-C	Performed by	Jeremy Luong

1 GHz to 25 GHz Plots for Transmit Mode at 2462 MHz

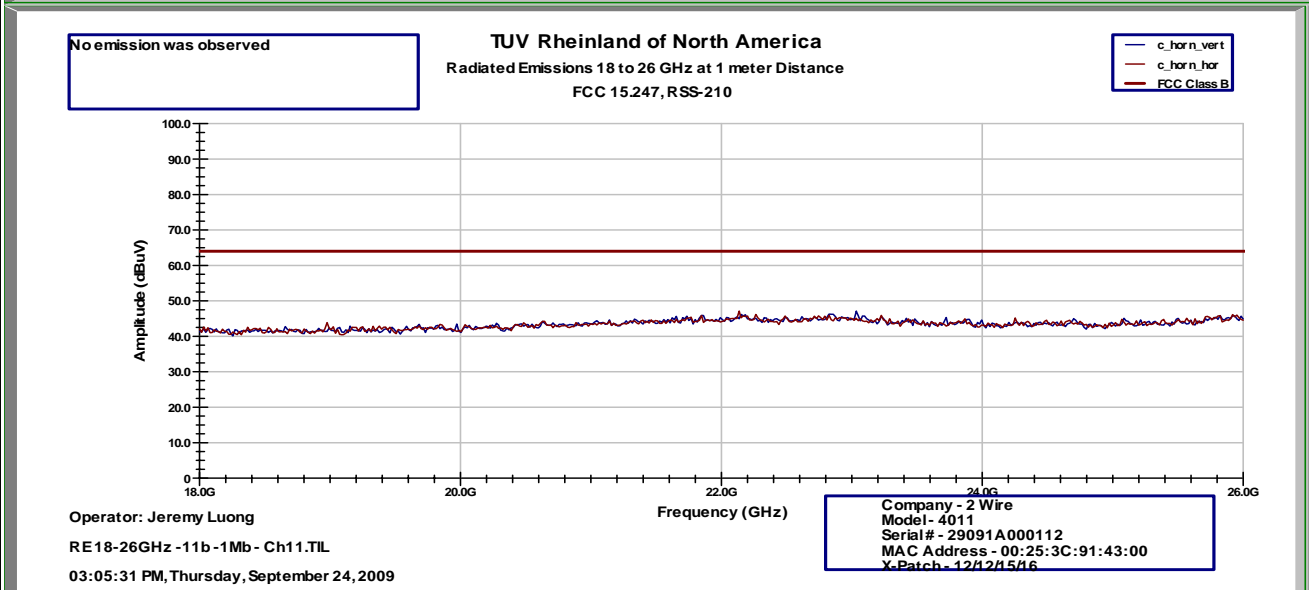
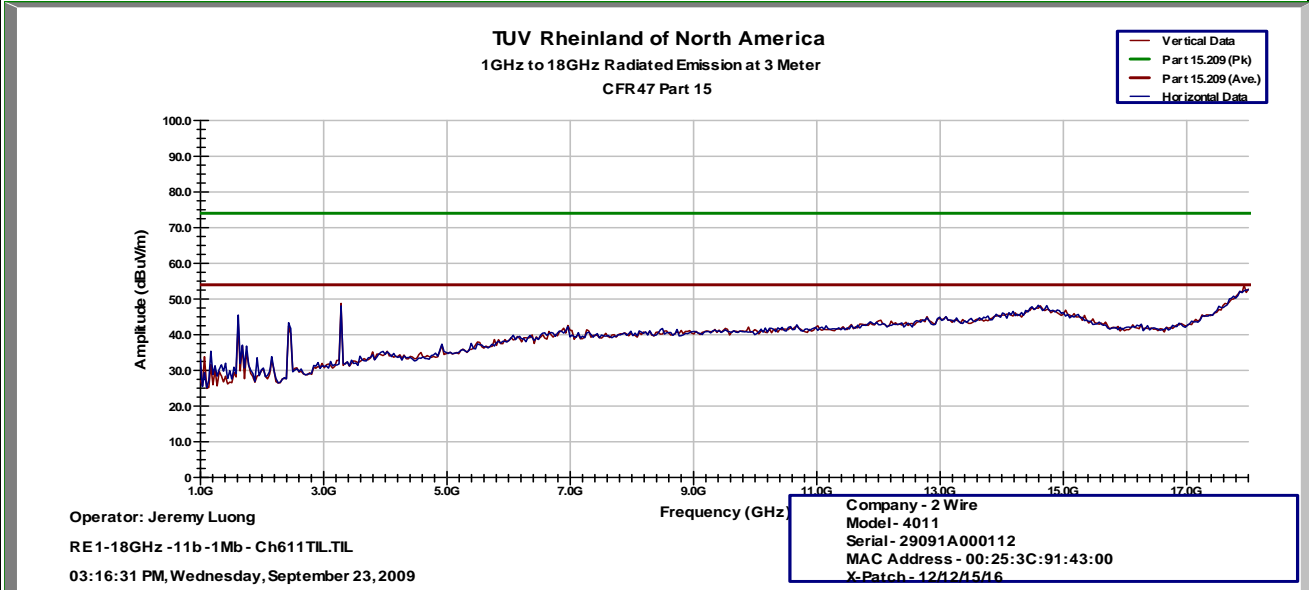

Notes: None.

4.6.4 Sample Calculation

The field strength is calculated by subtracting the Amplifier Gain and adding the Cable Loss and Antenna Correction Factor to the measured reading. The basic equation is as follows:

$$\text{Field Strength (dB}\mu\text{V/m)} = \text{FIM} - \text{AMP} + \text{CBL} + \text{ACF}$$

Where: FIM = Field Intensity Meter (dB μ V)
AMP = Amplifier Gain (dB)
CBL = Cable Loss (dB)
ACF = Antenna Correction Factor (dB/m)

$$\mu\text{V/m} = 10^{\frac{\text{dB}\mu\text{V / m}}{20}}$$

4.7 Receiver Spurious Emissions

Receiver spurious emissions are emissions at any frequency when the equipment is in receive mode.

The spurious emissions of the receiver shall not exceed the values in CFR47 Part 15.109 and RSS 210 Sect 2.7.

4.7.1 Test Methodology

4.7.1.1 Preliminary Test

A test program that controls instrumentation and data logging was used to automate the preliminary RF emission test procedure. The frequency range of interest was divided into sub-ranges to yield a frequency resolution of approximately 120 kHz and provide a reading at each frequency for no more than 12° of turntable rotation. For each frequency sub-range the turntable was rotated 360° while peak emission data was recorded and plotted over the frequency range of interest in horizontal and vertical antenna polarization's.

Preliminary emission profile testing was performed inside the anechoic chamber. The EUT was placed on a 1.0m x 1.5m non-conductive table 80cm above the floor. The EUT was positioned as shown in the setup photographs. The receiving antenna was placed at a distance of 3m at a fixed height of 1m. Measurement equipment was located outside of the chamber. A video camera was placed inside the chamber to view the EUT.

Preliminary scans performed with EUT positioned horizontal and vertically. Horizontal position was worse.

4.7.1.2 Final Test

For each frequency measured, the peak emission was maximized by manipulating the receiving antenna from 1 to 4 meters above the ground plane and placing it at the position that produced the maximum signal strength reading. The turntable was then rotated through 360° while observing the peak signal and placing the EUT at the position that produced maximum radiation. The six highest emissions relative to the limit were measured unless such emissions were more than 20 dB below the limit. If less than six emissions are within 20 dB of the limit, than the noise level of the receiver is measured at frequencies where emissions are expected. Multiples of all oscillator and microprocessor frequencies were also checked.

Final testing was performed on an NSA compliant test site. The EUT was placed on a 1.0m x 1.5m non-conductive table 80cm above the ground plane. The placement of EUT and cables were the same as for preliminary testing and is shown in the setup photographs.

The final scans performed on Channel 6; 2437 MHz with EUT positioned horizontally.

4.7.1.3 Deviations

None.

4.7.2 Receiver Spurious Emission Limit

The spurious emissions of the receiver shall not exceed the values in CFR47 Part 15.205, 15.209: 2008 and RSS 210 A1.1.2 2007.

Frequency (MHz)	Field strength (microvolts/meter)	Measurement distance (meters)
0.009-0.490.....	2400/F(kHz)	300
0.490-1.705.....	24000/F(kHz)	30
1.705-30.0.....	30	30
30-88.....	100 **	3
88-216.....	150 **	3
216-960.....	200 **	3
Above 960.....	500	3

4.7.3 Test Results

The final measurement data indicates the worst case operating modes, configurations, and/or cable positions. It also reflects the results including any modifications and/or special accessories listed in Sections 1.4 and 1.5.

As originally tested, the EUT was found to be compliant to the requirements of the test standard(s).

4.7.3.1 Final Data

The data recorded in this section contains the final results under the worst-case conditions and without any modifications or special accessories implemented as the manufacturer intends.

SOP 1 Radiated Emissions											Tracking # 30952981.001 Page 1 of 4
EUT Name	Wireless ADSL Residential Gateway					Date	September 25, 2009				
EUT Model	HomePortal 4011G/4010G					Temp / Hum in	22° C / 35% rh				
EUT Serial	MAC - 00:25:3C:91:43:00					Temp / Hum out	N/A				
EUT Config.	Integrated Antenna, Tabletop Position					Line AC / Freq	120Vac 60Hz				
Standard	CFR47 Part 15 Subpart C					RBW / VBW	120kHz / 300kHz				
Dist/Ant Used	3m / JB3					Performed by	Jeremy Luong				
Emission Freq (MHz)	ANT Polar (H/V)	Table Pos (deg)	ANT Pos (cm)	FIM (Pk) (dBuV/m)	FIM (QP) (dBuV/m)	Total CF (dBuV)	E-Field (dBuV/m)	Spec Limit (dBuV/m)	Spec Margin (dB)	Type	
Receive Mode at 2437 MHz											
47.795	V	69	124	48.80	47.59	-15.49	32.10	40.00	-7.90	Spurious	
110.839	V	268	112	45.58	44.85	-11.57	33.28	43.52	-10.24	Spurious	
120.002	V	299	106	45.32	43.85	-9.96	33.89	43.52	-9.63	Spurious	
599.986	V	329	113	41.89	41.48	-3.91	37.57	46.02	-8.45	Spurious	
359.995	H	15	161	43.45	42.65	-7.27	35.38	46.02	-10.64	Spurious	
375.003	H	147	104	45.34	44.90	-7.21	37.69	46.02	-8.33	Spurious	
625.012	H	321	136	40.61	40.57	-3.20	37.37	46.02	-8.65	Spurious	
Spec Margin = E-Field QP - Limit, E-Field QP = FIM QP+ Total CF ± Uncertainty											
Total CF= Amp Gain + Cable Loss + ANT Factor											
Combined Standard Uncertainty $u_c(y) = \pm 1.6\text{dB}$ Expanded Uncertainty $U = ku_c(y)$ $k = 2$ for 95% confidence											
Notes: RX mode at 1MBit/s											

SOP 1 Radiated Emissions							Tracking # 30952981.001 Page 2 of 4			
EUT Name	Wireless ADSL Residential Gateway					Date	September 24, 2009			
EUT Model	HomePortal 4011G/4010G					Temp / Hum in	22° C / 38% rh			
EUT Serial	MAC - 00:25:3C:91:43:00					Temp / Hum out	N/A			
EUT Config.	Integrated Antenna, Tabletop Position					Line AC / Freq	120Vac/60Hz			
Standard	CFR47 Part 15 Subpart C					RBW / VBW	1MHz / 3MHz			
Dist/Ant Used	3m / EMCO3115					Performed by	Jeremy Luong			
Emission Freq (MHz)	ANT Polar (H/V)	Table Pos (deg)	ANT Pos (cm)	FIM (Pk) (dBuV/m)	FIM Ave (dBuV/m)	Total CF (dBuV)	E-Field Ave (dBuV/m)	Spec Limit (dBuV/m)	Spec Margin (dB)	Type
Transmitted Data at 2437 MHz										
1079.99	V	76	194	43.55	27.6	-5.74	21.86	53.98	-32.12	Spurious
1080.03	H	52	167	44.05	37.22	-5.74	31.48	53.98	-22.5	Spurious
1500.22	H	31	159	45.9	39.88	-4.42	35.46	53.98	-18.52	Spurious
1799.97	V	171	194	43.01	35.54	-2.91	32.63	53.98	-21.35	Spurious
Spec Margin = E-Field Ave - Limit, E-Field Ave = FIM Ave+ Total CF ± Uncertainty										
Total CF= Amp Gain + Cable Loss + ANT Factor										
Combined Standard Uncertainty $u_c(y) = \pm 1.6$ dB Expanded Uncertainty $U = ku_c(y)$ $k = 2$ for 95% confidence										
Notes: None										

SOP 1 Radiated Emissions

Tracking # 30952981.001 Page 3 of 4

EUT Name	Wireless ADSL Residential Gateway	Date	September 25, 2009
EUT Model	HomePortal 4011G/4010G	Temp / Hum in	22° C / 35% rh
EUT Serial	MAC - 00:25:3C:91:43:00	Temp / Hum out	N/A
EUT Config.	Integrated Antenna, Tabletop Position	Line AC	120Vac 60Hz
Standard	CFR47 Part 15 Subpart C	RBW / VBW	120kHz / 300kHz
Dist/Ant Used	3m / JB3	Performed by	Jeremy Luong

30 MHz to 1000 MHz Plot for Receive Mode at 2437 MHz

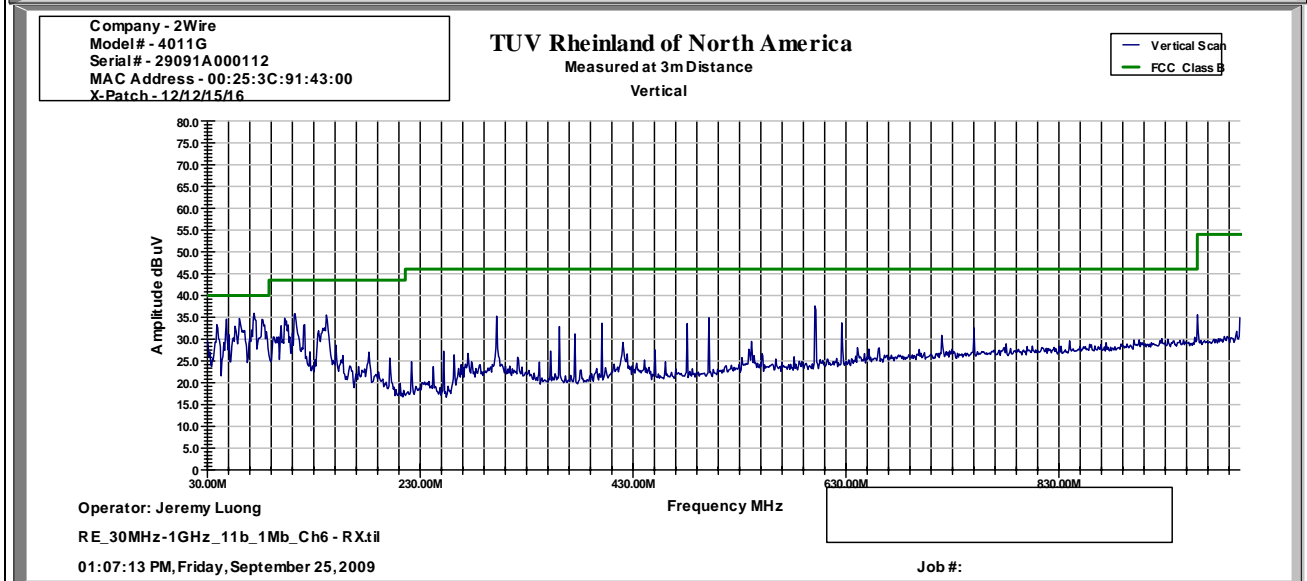
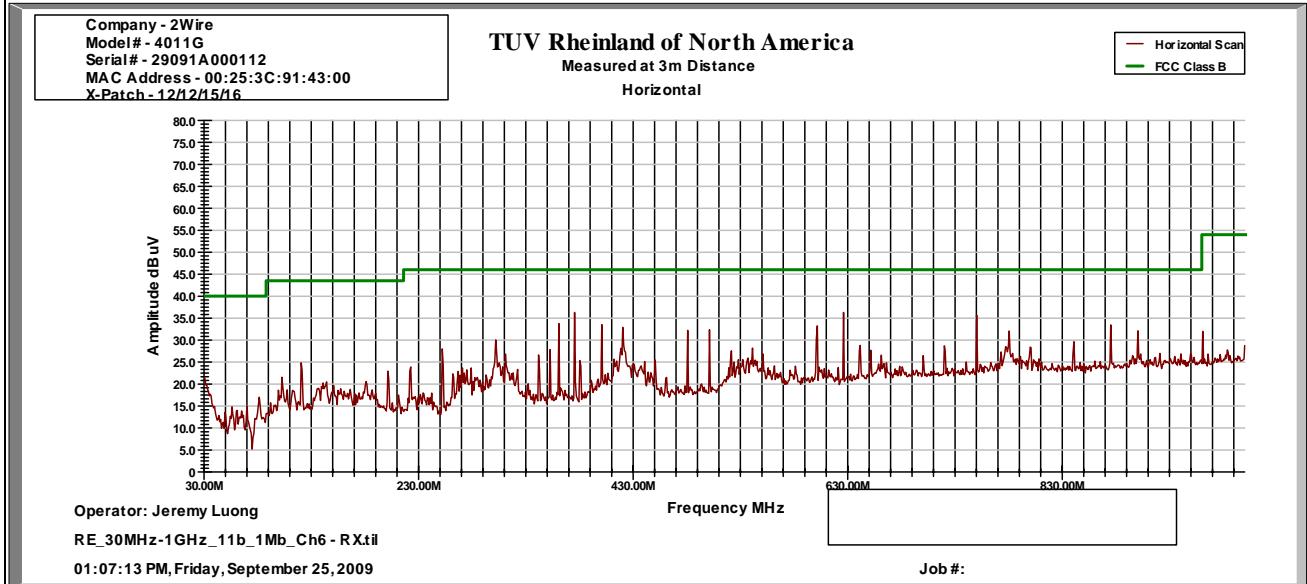

Notes: None.

SOP 1 Radiated Emissions

Tracking # 30952981.001 Page 4 of 4

EUT Name	Wireless ADSL Residential Gateway	Date	September 24, 2009
EUT Model	HomePortal 4011G/4010G	Temp / Hum in	21° C / 38% rh
EUT Serial	MAC - 00:25:3C:91:43:00	Temp / Hum out	N/A
EUT Config.	Integrated Antenna, Tabletop Position	Line AC	120Vac 60Hz
Standard	CFR47 Part 15 Subpart C	RBW / VBW	1MHz / 3MHz
Dist/Ant Used	3m / EMCO3115	Performed by	Jeremy Luong

1 GHz to 18 GHz Plot for Receive Mode at 2437 MHz

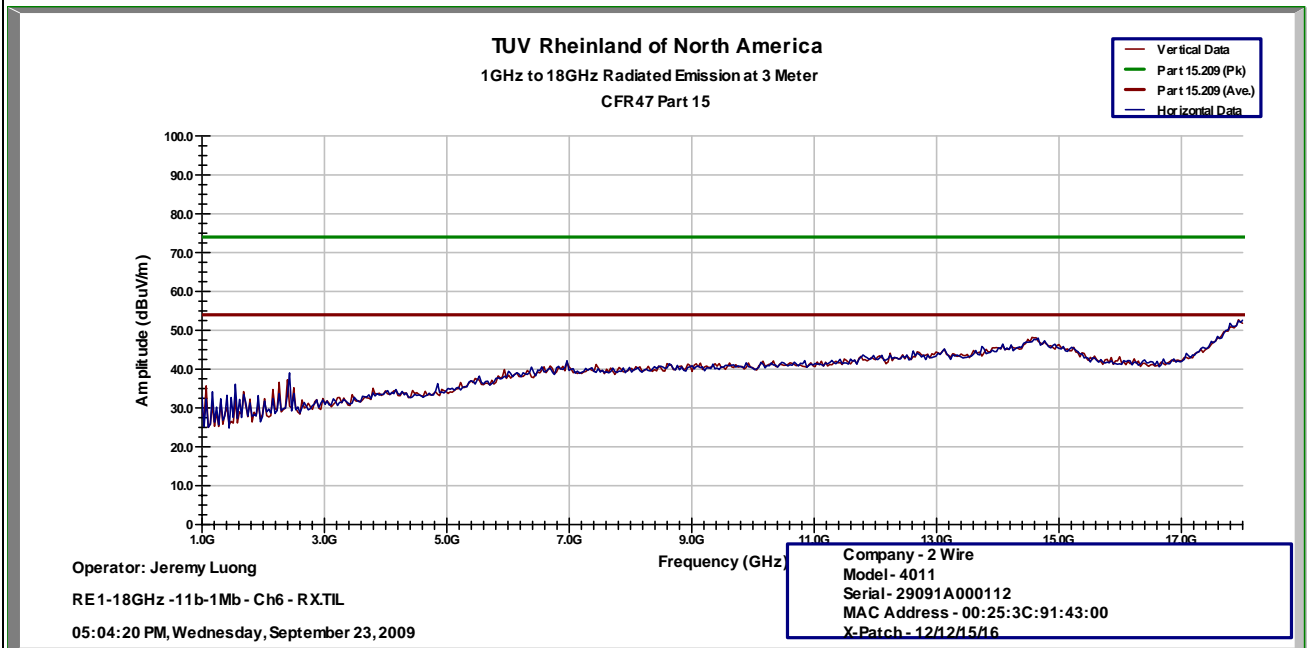

Notes: None.

4.8 AC Conducted Emissions

Testing was performed in accordance with ANSI C63.4:2003, RSS-210. These test methods are listed under the laboratory's NVLAP Scope of Accreditation.

This test measures the levels emanating from the EUT's AC input port, thus evaluating the potential for the EUT to cause radio frequency interference to other electronic devices.

The AC conducted emissions of equipment under test shall not exceed the values in CFR47 Part 15.107

4.8.1 Test Methodology

A test program that controls instrumentation and data logging was used to automate the AC Power Line Conducted emission test procedure. The frequency range of interest was divided into sub-ranges such as to yield a frequency resolution of 9 kHz. Each phase and neutral of the AC power line were measured with respect to ground. Measurements were performed using a set of 50 μ H / 50 Ω LISNs.

Testing is either performed in the semi-anechoic chamber or Lab 2. The setup photographs clearly identify which site was used. The vertical ground plane used in the semi-anechoic chamber is a 2m x 2m solid aluminum frame and panel, and it is bonded to the horizontal ground plane.

In the case of tabletop equipment, the EUT is placed on a 1.0m x 1.5m non-conductive table 80cm above the ground plane and 40cm from a vertical ground reference plane. The rear of the EUT was positioned flush with the backside of the table and directly over the LISNs. The power and I/O cables were routed over the edge of the table and bundled approximately 40cm from the ground plane. Support equipment was powered from a separate LISN.

4.8.1.1 Deviations

There were no deviations from this test methodology.

4.8.2 Test Results

As originally tested, the EUT was found to be compliant to the requirements of the test standard(s).

Table 8: AC Conducted Emissions – Test Results

Test Conditions: Conducted Measurement at Normal Conditions only		
Antenna Type: Attached		Power Level: +20 dBm
AC Power: 120 Vac/60 Hz		Configuration: Tabletop
Ambient Temperature: 22° C		Relative Humidity: 36% RH
Configuration	Frequency Range	Test Result
Line 1 (Hot)	0.15 to 30 MHz	Pass
Line 2 (Neutral)	0.15 to 30 MHz	Pass

SOP 2 Conducted Emissions				Tracking # 30952981.001 Page 1 of 4		
EUT Name	Wireless ADSL Residential Gateway			Date	October 7, 2009	
EUT Model	HomePortal 4011G/4010G			Temp / Hum in	23° C / 36% rh	
EUT Serial	28091A000050			Temp / Hum out	N/A	
EUT Config.	Attached Antenna			Line AC / Freq	120Vac/60Hz	
Standard	CFR47 Part 15.107			RBW / VBW	9kHz / 30kHz	
Lab/LISN	Lab #5 / Solar 9348-50-R-24-BNC, Line 1			Performed by	Jeremy Luong	
Frequency MHz	Quasi-Peak dBuV	QP Limit dBuV	QP Margin dB	Average dBuV	Ave Limit dBuV	Ave Margin dB
0.16543	47.59	65.56	-17.73	32.23	55.56	-23.09
0.4642	39.12	57.02	-17.72	33.60	47.02	-13.23
0.494	38.92	56.17	-17.08	32.64	46.17	-13.35
2.368	38.16	56.00	-17.74	32.80	46.00	-13.10
2.931	38.18	56.00	-17.71	33.80	46.00	-12.09
5.856	45.65	60.00	-14.21	44.38	50.00	-5.47
Spec Margin = QP./Ave. - Limit, ± Uncertainty						
Combined Standard Uncertainty $u_c(y) = \pm 1.2$ dB Expanded Uncertainty $U = ku_c(y)$ $k = 2$ for 95% confidence						
Notes: EUT was setup as table top equipment.						

SOP 2 Conducted Emissions

Tracking # 30952981.001 Page 2 of 4

EUT Name	Wireless ADSL Residential Gateway	Date	October 7, 2009
EUT Model	HomePortal 4011G/4010G	Temp / Hum in	23° C / 36% rh
EUT Serial	28091A000050	Temp / Hum out	N/A
EUT Config.	Attached Antenna	Line AC	120Vac/60Hz
Standard	CFR47 Part 15.107	RBW / VBW	9kHz / 30kHz
Lab/LISN	Lab #5 / Solar 9348-50-R-24-BNC, Line 1	Performed by	Jeremy Luong

150kHz to 30 MHz Plot for Line 1 (Hot)

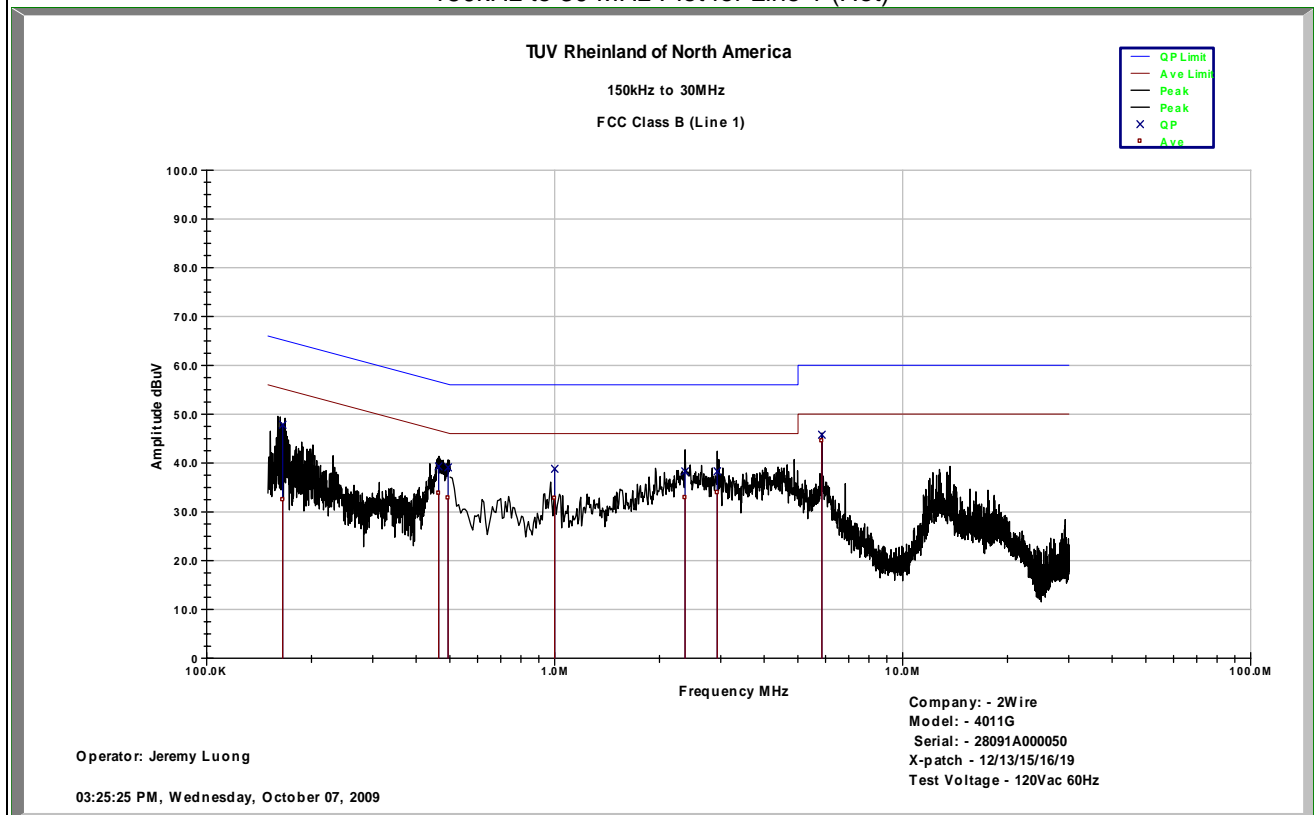

Notes: Using CISPR Class B Limit.

SOP 2 Conducted Emissions				Tracking # 30952981.001 Page 3 of 4		
EUT Name	Wireless ADSL Residential Gateway		Date	October 7, 2009		
EUT Model	HomePortal 4011G/4010G		Temp / Hum in	23° C / 36% rh		
EUT Serial	28091A000050		Temp / Hum out	N/A		
EUT Config.	Attached Antenna		Line AC / Freq	120Vac/60Hz		
Standard	CFR47 Part 15.107		RBW / VBW	9kHz / 30kHz		
Lab/LISN	Lab #5 / Solar 9348-50-R-24-BNC, Line 2		Performed by	Jeremy Luong		
Frequency MHz	Quasi-Peak dBuV	QP Limit dBuV	QP Margin dB	Average dBuV	Ave Limit dBuV	Ave Margin dB
0.165	47.03	65.57	-18.31	32.44	55.57	-22.89
0.495	38.55	56.14	-17.41	32.72	46.14	-13.25
2.367	38.04	56.00	-17.85	32.76	46.00	-13.13
2.928	40.11	56.00	-15.77	36.51	46.00	-9.38
4.576	34.42	56.00	-21.45	28.42	46.00	-17.45
5.861	39.57	60.00	-20.29	34.69	50.00	-15.16
Spec Margin = QP./Ave. - Limit, ± Uncertainty						
Combined Standard Uncertainty $u_c(y) = \pm 1.2$ dB Expanded Uncertainty $U = k u_c(y)$ $k = 2$ for 95% confidence						
Notes: EUT was setup as table top equipment.						

SOP 2 Conducted Emissions

Tracking # 30952981.001 Page 4 of 4

EUT Name	Wireless ADSL Residential Gateway	Date	October 7, 2009
EUT Model	HomePortal 4011G/4010G	Temp / Hum in	23° C / 36% rh
EUT Serial	28091A000050	Temp / Hum out	N/A
EUT Config.	Attached Antenna	Line AC	120Vac/60Hz
Standard	CFR47 Part 15.107	RBW / VBW	9kHz / 30kHz
Lab/LISN	Lab #5/ Solar 9348-50-R-24-BNC, Line 2	Performed by	Jeremy Luong

150 kHz to 30 MHz Plot for Line 2 (Neutral)

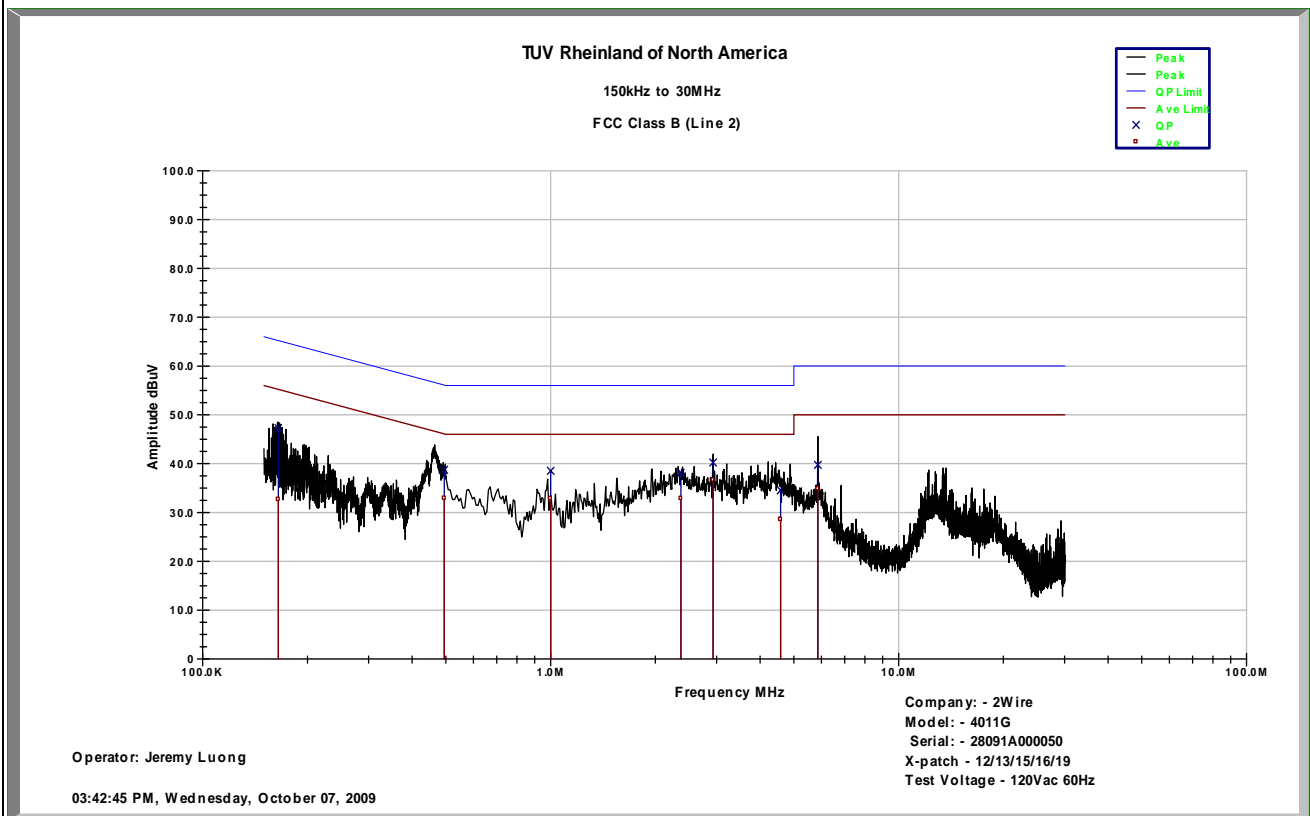

Notes: Using CISPR Class B Limit.

5 Test Equipment List

5.1 Equipment List

Equipment	Manufacturer	Model #	Serial/Inst #	Last Cal dd/mm/yy	Next Cal dd/mm/yy
Antenna Bilog	Sunol Science	JB3	A102606	02/06/08	02/06/10
Tuned Dipole Antenna	A.H Systems, Inc.	TDS-200/535-1	154	01/09/09	01/09/10
Tuned Dipole Antenna	A.H Systems, Inc.	TDS-200/535-2	154	01/09/09	01/09/10
Tuned Dipole Antenna	A.H Systems, Inc.	TDS-200/535-3	154	01/09/09	01/09/10
Tuned Dipole Antenna	A.H Systems, Inc.	TDS-200/535-4	154	01/09/09	01/09/10
Antenna Horn (1-18 GHz)	EMCO	3115	9602-4676	07/03/08	07/03/10
Antenna Horn (1-18 GHz)	EMCO	3115	9710-5301	07/03/08	07/03/10
Antenna Horn (18-26 GHz)	CMT	RA42-K-F-4B-C	020131-004	08/14/08	08/14/10
Antenna Horn (18-26 GHz)	CMT	RA42-K-F-4B-C	961178-001	08/14/08	08/14/10
EMI Receiver	Hewlett Packard	8546A	3325A00166	01/21/09	01/21/10
Preselector	Hewlett Packard	85460A	3330A00162	01/21/09	01/21/10
Amplifier	Hewlett Packard	8447D	2944A07486	1/23/09	1/23/10
Spectrum Analyzer	Rhode&Schwarz	ESIB	100180	08/19/09	08/19/10
Amplifier	Rhode&Schwarz	TS-PR18	100019	08/14/08	08/14/10
Amplifier	Rhode&Schwarz	TS-PR26	100011	08/14/08	08/14/10
Signal Generator	Hewlett Packard	83620B	3844A01375	01/21/09	01/21/10
Thermo Chamber	Associated Environmental	SK-3102	5999	01/22/09	01/22/10
Notch Filter	Micro-Tronics	BRM50702	037	01/24/09	01/24/10
High Pass Filter (3.5 GHz)	Hewlett Packard	84300-80038	82004	01/24/09	01/24/10
High Pass Filter (8.5 GHz)	Hewlett Packard	84300-80039	002	01/24/09	01/24/10
Power Supplier	Kikosui	PCR8000W	CM000912	01/21/09	01/21/10
Digital Multimeter	Fluke	77	55960854	01/22/09	01/22/10
Thermometer	Fluke	52II	96480032	07/28/09	07/28/10

* Calibration of equipment past due for re-calibration will be performed expeditiously. If any equipment is found to be out of tolerance at that time, affected customers will be notified accordingly.

6 EMC Test Plan

6.1 Introduction

This section provides a description of the Equipment Under Test (EUT), configurations, operating conditions, and performance acceptance criteria. It is an overview of information provided by the manufacturer so that the test laboratory may perform the requested testing.

6.2 Customer

Table 9: Customer Information

Company Name	2Wire, Inc.
Address	310 Providence Mine Road
City, State, Zip	Nevada City, CA 95959
Country	USA
Phone	(530) 274-5440
Fax	(530) 273-6340

Table 10: Technical Contact Information

Name	Mark Rieger
E-mail	"Mark Rieger" <mrieger@2wire.com>
Phone	(530) 274-5440
Fax	(530) 273-6340

6.3 Equipment Under Test (EUT)

Table 11: EUT Specifications

4011G/4010G Dimensions	6.77" x 5.64" x 1.32"
PHIHONG AC Adapter (M/N: PSM12R-145)	Input Voltage: 100 – 240 Vac Input Current: 500 mA Output Voltage: 14.5 Vdc Output Current: 0.83 A
Environment	Indoor
Operating Temperature Range:	0 to 40 degrees C
Multiple Feeds:	<input type="checkbox"/> Yes and how many <input checked="" type="checkbox"/> No
Operating Mode	802.11b, g
Transmitter Frequency Band	2.412 GHz to 2.462 GHz (DSSS)
Rated Power Output	100 mW (+20dBm)
Operating Channel	2412 MHz, 2417 MHz, 2422 MHz, 2427 MHz, 2432 MHz, 2437 MHz, 2442 MHz, 2447 MHz, 2452 MHz, 2457 MHz, 2462 MHz.
Antenna Type	Attached on board
Modulation Type	<input type="checkbox"/> AM <input type="checkbox"/> FM <input type="checkbox"/> Phase <input checked="" type="checkbox"/> Other describe: DSSS
Type of Equipment	<input checked="" type="checkbox"/> Table Top <input type="checkbox"/> Wall-mount <input type="checkbox"/> Floor standing cabinet <input type="checkbox"/> Other <i>describe:</i>

Table 12: Interface Specifications

Interface Type	Cabled with what type of cable?	Is the cable shielded?	Maximum potential length of the cable?	Metallic (M), Coax (C), Fiber (F), or Not Applicable?
Ethernet (x4)	CAT-5	<input checked="" type="checkbox"/> No	<input checked="" type="checkbox"/> Metric: 30m	<input checked="" type="checkbox"/> M
ADSL	Telephone (RJ11)	<input checked="" type="checkbox"/> No	<input checked="" type="checkbox"/> Metric: 1.8m	<input checked="" type="checkbox"/> M

Table 13: Supported Equipment

Equipment	Manufacturer	Model	Serial	Used for
Laptop	Dell Computer	PP23LB	32894765713	Set test mode

Table 14: Description of Sample used for Testing

Device	MAC Address	Configuration	Used For
4011G	00:25:3C:91:43:00	Radiated Sample	Radiated Emission
4011G	00:25:3C:91:45:30	Conducted Sample	Output Power, Bandwidth, Conducted Spurious Emission, Peak Power Spectral Density,

Note: 4011G and 4010G are similar to each other. 4011G has 4 Ethernet ports, and 4010G has 1 Ethernet port. 4011G was selected for testing base on engineering judgment.

Table 15: Description of Test Configuration used for Radiated Measurement.

Device	Antenna	Mode	Setup Description
4011G	Attached	Transmit & Receive	Tabletop. 4011G positioned horizontally.
4011G	Attached	Transmit & Receive	Tabletop. 4011G positioned vertically.

Note: Test configuration was used in the preliminary testing.

6.4 Test Specifications

Testing requirements

Table 16: EUT Designation

Emissions and Immunity	
Standard	Requirement
CFR 47 Part 15.247	All
RSS 210	All