



TEST REPORT

EUT Description	Wireless Module installed in Convertible PC
Brand Name	Intel®
Model Name	BE201NGW
FCC ID	PD9BE201NG
Date of Test Start/End	2024-09-18 / 2024-09-27
Features	2x2 Wi-Fi- Bluetooth® (see section 5)
Description	Platform: HSN-I61C + Vendor 1 & Vendor 2 antenna

Applicant	Intel Corporation SAS
Address	425 Rue de Goa – Le Cargo B6 – 06600 Antibes, FRANCE
Contact Person	Benjamin Lavenant
Telephone/Fax/ Email	Benjamin.lavenant@intel.com

Reference Standards	FCC 47 CFR Part §2.1093 (see section 1)	
RF Exposure Environment	Portable devices - General population/uncontrolled exposure	
Exposure Conditions	Body worn	
	SAR Result	SAR Limit
Maximum Power Density Result & Limit	6.01 W/m ² (4cm ²)	10 W/m ² (4cm ²)
Maximum SAR Result & Limit	0.79 W/kg (1g)	1.6 W/kg (1g)
Min. test separation distance	0mm to phantom, 1.9mm to antenna edge (SAR), 2mm to probe tip (PD)	

Test Report identification	240813-01.TR01
Revision Control	Rev. 02 This test report revision replaces any previous test report revision (see section 8)

The test results relate only to the samples tested.
Reference to accreditation shall be used only by full reproduction of test report.

Issued by _____

Robin LUCIANI
(Test Engineer)

Intel Corporation S.A.S – WRF Lab
425 rue de Goa – Le Cargo B6 - 06600 Antibes, France
Tel. +33493001400 / Fax +33493001401

Table of Contents

1.	Standards, reference documents and applicable test methods	4
2.	General conditions, competences and guarantees	4
3.	Environmental Conditions.....	5
4.	Test samples.....	5
5.	EUT Features	6
6.	Remarks and comments	12
7.	Test Verdicts summary.....	12
8.	Document Revision History	12
9.	SAR Definition	13
10.	Power Density Definition	13
11.	SAR Test & System Description	14
11.1.	SPEAG SAR MEASUREMENT SYSTEM	14
11.2.	TEST EQUIPMENT LIST.....	21
11.3.	TISSUE SIMULANT LIQUID.....	21
11.4.	MEASUREMENT UNCERTAINTY EVALUATION.....	22
11.5.	RF EXPOSURE LIMITS.....	23
12.	PD Test & System Description.....	24
12.1.	SPEAG FREE SPACE MEASUREMENT SYSTEM.....	24
12.2.	TEST EQUIPMENT LIST.....	28
12.3.	MEASUREMENT UNCERTAINTY EVALUATION.....	29
12.4.	RF EXPOSURE LIMITS.....	30
Annex A.	Test Results	31
A.1	TEST CONDITIONS.....	31
A.1.1	Test SAR Test positions relative to the phantom.....	31
A.1.2	Test signal, Output power and Test Frequencies	31
A.1.3	Evaluation Exclusion and Test Reductions.....	32
A.2	CONDUCTED POWER MEASUREMENTS.....	35
A.2.1	WLAN 2.4GHz.....	35
A.2.2	WLAN 5GHz (U-NII)	37
A.2.3	WLAN 6-7GHz (U-NII)	43
A.3	TISSUE PARAMETERS MEASUREMENT	45
A.4	SYSTEM CHECK MEASUREMENTS	45
A.4.1	E-Field	46
A.4.2	H-Field.....	46
A.4.3	Local Power Density	46
A.4.4	Averaged Power Density	47
A.5	SAR TEST RESULTS	48
A.5.1	Bluetooth & 802.11b/g/n/ax/be – 2.4GHz - DTS.....	48
A.5.2	802.11a/n/ac/ax/be – 5.3 GHz – U-NII-2A	48
A.5.3	802.11a/n/ac/ax/be – 5.6 GHz – U-NII-2C.....	48
A.5.4	802.11a/n/ac/ax/be – 5.8 GHz – U-NII-3.....	48
A.5.5	802.11a/n/ac/ax/be – 5.9 GHz – U-NII-4.....	49
A.5.6	802.11ax/be – 6.2 GHz – U-NII-5.....	49
A.5.7	802.11ax/be – 6.5 GHz – U-NII-6.....	49
A.5.8	802.11ax/be – 6.7 GHz – U-NII-7.....	50
A.5.9	802.11ax/be – 7.0 GHz – U-NII-8.....	50

A.6	PD TEST RESULTS.....	51
A.6.1	802.11ax/be – 6.2 GHz – U-NII-5.....	51
A.6.2	802.11ax/be – 6.5 GHz – U-NII-6.....	51
A.6.3	802.11ax/be – 6.7 GHz – U-NII-7.....	51
A.6.4	802.11ax/be – 7.0 GHz – U-NII-8.....	51
A.7	SAR MEASUREMENT VARIABILITY.....	52
A.8	SIMULTANEOUS TRANSMISSION SAR EVALUATION	53
Annex B.	Test System Plots.....	54
Annex C.	TSL Dielectric Parameters.....	81
C.1	HEAD 2450MHZ	81
C.2	HEAD 5200MHZ-5900MHZ	82
C.3	HEAD 6500MHZ	83
Annex D.	Calibration Certificates.....	84
Annex E.	Photographs	86
E.1	TEST SAMPLE	86
E.2	TEST POSITIONS.....	88
E.3	ANTENNA HOST PLATFORM LOCATION AND ADJACENT EDGE POSITIONS RELATIVE TO THE BODY.....	89
E.4	PHANTOM LIQUID LEVEL DURING MEASUREMENTS	90

1. Standards, reference documents and applicable test methods

FCC	<ol style="list-style-type: none"> 1. FCC Title 47 CFR Part §2.1093 – Radiofrequency radiation exposure evaluation: portable devices. 2023-10-01 Edition 2. FCC OET KDB 447498 D04 interim v01 General RF Exposure Guidance v01– RF Exposure Procedures and Equipment Authorization Policies for Mobile and Portable Devices. 3. FCC OET KDB 616217 D04 v01r02 – SAR Evaluation Considerations for Laptop, Notebook, Netbook and Tablet Computers. 4. FCC OET KDB 865664 D01 v01r04 – SAR Measurement Requirements for 100 MHz to 6 GHz. 5. FCC OET KDB 865664 D02 v01r02 – RF Exposure Compliance Reporting and Documentation Considerations. 6. IEEE Std 1528-2013 – IEEE Recommended Practice Determining the Peak Spatial-Average Specific Absorption Rate (SAR) in the Human Head from Wireless Communication Devices: Measurement Techniques. 7. RF Exposure Policies and Procedures: TCB Workshop – April 2021 8. IEC/IEEE 62209-1528:2020 Measurement procedure for the assessment of specific absorption rate of human exposure to radio frequency fields from hand-held and body-mounted wireless communication devices – Part 1528: Human models, instrumentation, and procedures (Frequency range of 4 MHz to 10 GHz) 9. 987594 D04 UN6GHZ Pre-Approval Guidance Checklist v01 10. SPEAG Application Note – 5G Compliance Testing with DASY6 (5GModule V1.0Beta) 11. SPEAG Application Note – 5G Compliance Testing with DASY6/8 (5GModule V5.0)
-----	---

2. General conditions, competences and guarantees

- ✓ Tests performed under FCC standards identified in section 1 are covered by A2LA accreditation.
- ✓ Intel Corporation SAS Wireless RF Lab (Intel WRF Lab) is an ISO/IEC 17025:2017 laboratory accredited by the American Association for Laboratory Accreditation (A2LA) with the certificate number 3478.01.
- ✓ Intel Corporation SAS Wireless RF Lab (Intel WRF Lab) is an Accredited Test Firm recognized by the FCC, with Designation Number FR0011.
- ✓ Intel WRF Lab only provides testing services and is committed to providing reliable, unbiased test results and interpretations.
- ✓ Intel WRF Lab is liable to the client for the maintenance of the confidentiality of all information related to the item under test and the results of the test.
- ✓ Intel WRF Lab has developed calibration and proficiency programs for its measurement equipment to ensure correlated and reliable results to its customers.
- ✓ This report is only referred to the item that has undergone the test.
- ✓ This report does not imply an approval of the product by the Certification Bodies or competent Authorities.

3. Environmental Conditions

- ✓ At the site where the measurements were performed the following limits were not exceeded during the tests:

Temperature	21.3°C ± 2°C
Humidity	39.8% ± 7.6%
Liquid Temperature	21.1°C ± 2°C

4. Test samples

Sample	Control #	Description	Model	Serial #	Date of receipt	Note
#01	240813-01.S01	Wireless Module installed in Convertible PC	HSN-I61C	0004770B49	2024-09-05	Vendor 1 Antenna
#02	240813-01.S03	Wireless Module installed in Convertible PC	HSN-I61C	0004770B52	2024-09-05	Vendor 2 antenna

5. EUT Features

The herein information is provided by the customer

Intel WRF Lab declines any responsibility for the accuracy of the stated customer provided information, especially if it has any impact on the correctness of test results presented in this report.

Brand Name	Intel®			
Model Name	BE201NGW			
Software Version	DRTU_06929.23.60.0			
Driver Version	23.60.5.14			
Prototype / Production	Production			
Host Identification	HSN-I61C			
Supported Radios	802.11b/g/n/ax/be	2.4GHz (2400.0 – 2483.5 MHz)		
	802.11a/n/ac/ax/be	5.2GHz (5150.0 – 5350.0 MHz)		
		5.6GHz (5470.0 – 5725.0 MHz)		
		5.8GHz (5725.0 – 5850.0 MHz)		
		5.9GHz (5850.0 – 5895.0 MHz)		
	802.11ax/be	6.0GHz (5925.0 – 7125.0 MHz)*		
	Bluetooth	2.4GHz (2400.0 – 2483.5 MHz)		
Antenna Information	Transmitter	Main (Ant 2/Tx2) / Chain B(2)	Aux (Ant 1/Tx1) / Chain A(1)	
	Manufacturer	Vendor 1	Vendor 1	
	Antenna type	PIFA	PIFA	
	Part number	6036B0344801 (81EAB815.G01)	6036B0345201 (81EAB815.G02)	
	Transmitter	Main (Ant 2/Tx2) / Chain B(2)	Aux (Ant 1/Tx1) / Chain A(1)	
	Manufacturer	Vendor 2	Vendor 2	
	Antenna type	PIFA	PIFA	
	Part number	6036B0346501 (00-2602754650)	6036B0346801 (00-2602754550)	
	See Annex E for more details on antennas location.			
	Simultaneous Transmission Configurations	WLAN 2.4GHz Main + BT Aux WLAN 2.4GHz Main + WLAN 2.4GHz Aux WLAN 5GHz Main + BT Aux WLAN 5GHz Main + WLAN 5GHz Aux WLAN 5GHz Main + WLAN 5GHz Aux + BT Aux WLAN 6GHz Main + BT Aux WLAN 6GHz Main + WLAN 6GHz Aux WLAN 6GHz Main + WLAN 6GHz Aux + BT Aux		
Additional Information	No WWAN transmitter is considered in this report			
	5.60-5.65 GHz band (TDWR) is supported by the device			
	Band gap is supported by the device			

Supported Radios

Mode	Duty Cycle	Modulation	Band	UL Freq Range (MHz)	Measured Max. Conducted Power (dBm)
BDR/EDR	77%	GFSK $\pi/4$ DQPSK 8DPSK	2.4GHz	2400-2483.5	14.98
Bluetooth LE	31%	GFSK	2.4GHz	2400-2483.5	NM
802.11b/g/n/ax/be	100%	BPSK QPSK 16QAM 64QAM	2.4GHz	2400-2483.5	17.50
802.11a/n/ac/ax/be	100%	BPSK QPSK 16QAM 64QAM 256QAM	5.2GHz	5150-5250	NM
			5.3GHz	5250-5350	13.30
			5.6GHz	5475-5725	13.38
			5.8GHz	5725-5850	13.62
			5.9GHz	5850-5895	13.31
802.11ax/be	100%	BPSK QPSK 16QAM 64QAM 256QAM	6.2GHz	5955-6415	14.84
			6.5GHz	6435-6515	13.29
			6.7GHz	6535-6855	13.78
			7.0GHz	6875-7125	13.50

NM: Not Measured

Maximum Output power specification + Tune up tolerance limit, as specified by the client			SISO mode Tablet	
Equipment Class	Mode	BW (MHz)	Aux (dBm)	Main (dBm)
DTS	802.11b	20	14.00	17.50
	802.11g	20	14.00	17.50
	802.11n20	20	14.00	17.50
	802.11ax20/be20	20	14.00	17.50
	802.11n40	40	14.00	17.50
	802.11ax40/be40	40	14.00	17.50
U-NII-1	802.11a	20	13.00	14.00
	802.11n20	20	13.00	14.00
	802.11ax20/be20	20	13.00	14.00
	802.11n40	40	13.00	14.00
	802.11ax40/be40	40	13.00	14.00
	802.11ac80	80	13.00	14.00
	802.11ax80/be80	80	13.00	14.00
U-NII-2A	802.11a	20	13.00	14.00
	802.11n20	20	13.00	14.00
	802.11ax20/be20	20	13.00	14.00
	802.11n40	40	13.00	14.00
	802.11ax40/be40	40	13.00	14.00
	802.11ac80	80	13.00	14.00
	802.11ax80/be80	80	13.00	14.00
	802.11ac160	160	13.00	14.00
	802.11ax160/be160	160	13.00	14.00
U-NII-2C	802.11a	20	13.00	14.00
	802.11n20	20	13.00	14.00
	802.11ax20/be20	20	13.00	14.00
	802.11n40	40	13.00	14.00
	802.11ax40/be40	40	13.00	14.00
	802.11ac80	80	13.00	14.00
	802.11ax80/be80	80	13.00	14.00
	802.11ac160	160	13.00	14.00
	802.11ax160/be160	160	13.00	14.00
U-NII-3	802.11a	20	13.00	14.00
	802.11n20	20	13.00	14.00
	802.11ax20/be20	20	13.00	14.00
	802.11n40	40	13.00	14.00
	802.11ax40/be40	40	13.00	14.00
	802.11ac80	80	13.00	14.00
	802.11ax80/be80	80	13.00	14.00

U-NII-4	802.11a	20	13.00	14.00
	802.11n20	20	13.00	14.00
	802.11ax20/be20	20	13.00	14.00
	802.11n40	40	13.00	14.00
	802.11ax40/be40	40	13.00	14.00
	802.11ac80	80	13.00	14.00
	802.11ax80/be80	80	13.00	14.00
	802.11ac160	160	13.00	14.00
	802.11ax160/be160	160	13.00	14.00
U-NII-5	802.11ax/be	20	14.00	15.50
		40	14.00	15.50
		80	14.00	15.50
		160	14.00	15.50
	802.11be	320	14.00	15.50
U-NII-6	802.11ax/be	20	5.50	5.50
		40	8.50	8.50
		80	11.50	11.50
		160	14.00	14.25
U-NII-7	802.11ax/be	20	14.00	14.50
		40	14.00	14.50
		80	14.00	14.50
		160	14.00	14.50
	802.11be	320	14.00	14.50
U-NII-8	802.11ax/be	20	5.50	5.50
		40	8.50	8.50
		80	11.50	11.50
		160	14.00	14.50
	802.11be	320	14.00	13.50
BT	Bluetooth BDR	1		15.00
	Bluetooth EDR2	1		12.75
	Bluetooth EDR3	1		12.50
	BLE	2		15.00

Maximum Output power specification + Tune up tolerance limit, as specified by the client			SISO Mode Notebook	
Equipment Class	Mode	BW (MHz)	Aux (dBm)	Main (dBm)
DTS	802.11b	20	22.25	21.50
	802.11g	20	20.50	21.75
	802.11n20	20	20.50	21.75
	802.11ax20/be20	20	20.50	21.75
	802.11n40	40	19.25	20.00
	802.11ax40/be40	40	19.25	20.00
U-NII-1	802.11a	20	21.00	21.00
	802.11n20	20	21.00	21.00
	802.11ax20/be20	20	21.00	21.00
	802.11n40	40	19.00	19.00
	802.11ax40/be40	40	19.00	19.00
	802.11ac80	80	19,50	19.00
U-NII-2A	802.11ax80/be80	80	19,50	19.00
	802.11a	20	21.00	21.00
	802.11n20	20	21.00	21.00
	802.11ax20/be20	20	21.00	21.00
	802.11n40	40	20.00	20.00
	802.11ax40/be40	40	20.00	20.00
	802.11ac80	80	18.75	18.25
	802.11ax80/be80	80	18.75	18.25
U-NII-2C	802.11ac160	160	16.75	16.75
	802.11ax160/be160	160	16.75	16.75
	802.11a	20	20.50	20.50
	802.11n20	20	20.50	20.50
	802.11ax20/be20	20	20.50	20.50
	802.11n40	40	23.00	22.75
	802.11ax40/be40	40	23.00	22.75
	802.11ac80	80	21.00	21.25
	802.11ax80/be80	80	21.00	21.25
U-NII-3	802.11ac160	160	17.25	17.25
	802.11ax160/be160	160	17.25	17.25
	802.11a	20	23.50	23.50
	802.11n20	20	23.50	23.50
	802.11ax20/be20	20	23.50	23.50
	802.11n40	40	23.00	23.00
	802.11ax40/be40	40	23.00	23.00
U-NII-3	802.11ac80	80	22.00	22.00
	802.11ax80/be80	80	22.00	22.00

U-NII-4	802.11a	20	19.25	19.00
	802.11n20	20	19.25	19.00
	802.11ax20/be20	20	19.25	19.00
	802.11n40	40	22.75	22.75
	802.11ax40/be40	40	22.75	22.75
	802.11ac80	80	21.50	22.00
	802.11ax80/be80	80	21.50	22.00
	802.11ac160	160	17.00	18.00
	802.11ax160/be160	160	17.00	18.00
U-NII-5	802.11ax/be	20	14.00	15.50
		40	14.00	15.50
		80	14.00	15.50
		160	14.00	15.50
	802.11be	320	14.00	15.50
U-NII-6	802.11ax/be	20	5.50	5.50
		40	8.50	8.50
		80	11.50	11.50
		160	14.00	14.25
U-NII-7	802.11ax/be	20	14.00	14.50
		40	14.00	14.50
		80	14.00	14.50
		160	14.00	14.50
	802.11be	320	14.00	14.50
U-NII-8	802.11ax/be	20	5.50	5.50
		40	8.50	8.50
		80	11.50	11.50
		160	14.00	14.50
	802.11be	320	14.00	13.50
BT	Bluetooth BDR	1		15.00
	Bluetooth EDR2	1		12.75
	Bluetooth EDR3	1		12.50
	BLE	2		15.00

6. Remarks and comments

1. The conducted values are obtained by applying the BIOS SAR power values to the BE201NGW Intel module installed in the HSN-I61C identified in this report, as requested by the customer.
2. For both platforms with different antenna manufacturers, the same module is swapped between platforms.
3. Variability and simultaneous transmission results shown in this report are based on the highest SAR/PD value obtained among all antenna manufacturers.
4. Only the plots for the test positions with the highest measured SAR/PD per band/mode are included in Annex B as required per FCC OET KDB 865664 D02, paragraph 2.3.8.

7. Test Verdicts summary

The statement of conformity to applicable standards in the table below are based on the measured values, without taking into account the measurement uncertainties.

Standard	Band	Highest Reported SAR (1g) (W/kg)	Verdict
802.11b/g/n/ax	2.4GHz	0.79	P
Bluetooth	2.4GHz	0.09	P
802.11a/n/ac/ax/be	5.2GHz	NM	NA
	5.3GHz	0.27	P
	5.6GHz	0.40	P
	5.8GHz	0.39	P
	5.9GHz	0.37	P
802.11ax/be	6.2GHz	0.65	P
	6.5GHz	0.38	P
	6.7GHz	0.51	P
	7.0GHz	0.39	P

Standard	Band	Highest Reported PStot avg [W/m2] 4cm2	Verdict
802.11ax/be	6.2GHz	6.01	P
	6.5GHz	3.05	P
	6.7GHz	4.59	P
	7.0GHz	3.32	P

P: Pass
 F: Fail
 NM: Not Measured
 NA: Not Applicable

According to the FCC OET KDB 690783 D01, this is the summary of the values for the Grant Listing:

Exposure Condition	Highest Reported SAR (1g) (W/kg)		
	Equipment Class		
	DTS	DSS	U-NII
Body Worn	0.79	0.09	0.65
Simultaneous Tx	Sum-SAR: 1.08 SPLSR: NA	Sum-SAR: 1.11 SPLSR: NA	Sum-SAR: 1.11 SPLSR: NA

Considering the results of the performed test according to FCC 47CFR Part 2.1093 the item under test is IN COMPLIANCE with the requested specifications specified in Section 1. Standards, reference documents and applicable test methods

8. Document Revision History

Revision #	Modified by	Revision Details
Rev. 00	M.Farhan	First Issue
Rev. 01	R LUCIANI	DTS Target power corrected in section A.1.3.1, upon authority's request.
Rev. 02	R LUCIANI	NFC colocation note added in section A.8, upon authority's request.

9. SAR Definition

Specific Absorption rate is defined as the time derivative of the incremental energy (dW) absorbed by (dissipated in) and incremental mass (dm) contained in a volume element (dV) of a given density (ρ).

$$SAR = \frac{d}{dt} \cdot \left(\frac{dW}{dm} \right) = \frac{d}{dt} \cdot \left(\frac{dW}{\rho \cdot dV} \right)$$

SAR is expressed in units of watts per kilogram (W/kg). SAR can be related to the electric field at a point by

$$SAR = \frac{\sigma |E|^2}{\rho}$$

Where:

σ = Conductivity of the tissue (S/m)
 ρ = Mass density of the tissue (kg/m³)
 E = RMS electric field strength (V/m)

10. Power Density Definition

The power density for an electromagnetic field represents the rate of energy transfer per unit area.

The local power density (i.e. Poynting vector) at a given spatial point is deduced from electromagnetic fields by the following formula:

$$\vec{P}_{local} = \frac{1}{2} \text{Re} (\vec{E} \times \vec{H}^*)$$

Where \vec{E} is the complex electric field peak phasor and \vec{H}^* is the complex conjugate magnetic field peak phasor.

This power density is also called "single-point" or "spot power density".

Considering that the FCC's Maximum Permissible Exposure (MPE) limit is applicable on the average power density inside 1cm² area, the single point power densities in the evaluation plane should be averaged inside the 1cm² area.

11. SAR Test & System Description

11.1. SPEAG SAR Measurement System

SAR Measurement Setup:

The DASY6/8 system for performing compliance tests consists of the following items:

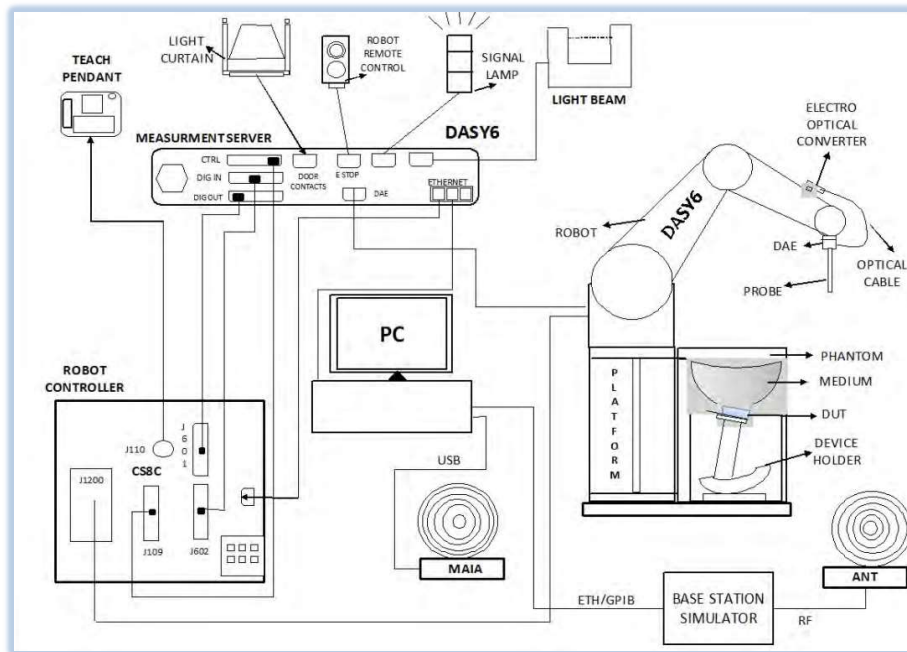

- ✓ A standard high precision 6-axis robot (Stäubli TX/RX family) with controller, teach pendant and software. It includes an arm extension for accommodating the data acquisition electronics (DAE)
- ✓ An isotropic field probe optimized and calibrated for the targeted measurements.
- ✓ A data acquisition electronics (DAE) which performs the signal amplification, signal multiplexing, AD-conversion, offset measurements, mechanical surface detection, collision detection, etc. The signal is optically transmitted to the EOC.
- ✓ The Electro-optical Converter (EOC) performs the conversion from optical to electrical signals for the digital communication to the DAE. The EOC signal is transmitted to the measurement server.
- ✓ The function of the measurement server is to perform the time critical tasks such as signal filtering, control of the robot operation and fast movements interrupts.
- ✓ The Light Beam used is for probe alignment. This improves the (absolute) accuracy of the probe positioning.
- ✓ A computer running Windows professional operating system and the DASY6/8 software.
- ✓ Remote control and teach pendant as well as additional circuitry for robot safety such as warning lamps, etc.
- ✓ The phantom, the device holder and other accessories according to the targeted measurement.
- ✓ MAIA is a hardware interface (Antenna) used to evaluate the modulation and audio interference characteristics of RF signals.
- ✓ ANT is an ultra-wideband antenna for use with the base station simulators over 698 MHz to 6GHz.
- ✓ The base station simulator is an equipment used for SAR cellular tests in order to emulate the cellular signals characteristics and behavior between a regular base station and the equipment under test.
- ✓ Tissue simulating liquid.
- ✓ System Validation dipoles.
- ✓ Network emulator or RF test tool.

E-Field Measurement Probe:

The probe is constructed using three orthogonal dipole sensors arranged on an interlocking, triangular prism core. The probe has built-in shielding against static charges and is contained within a PEEK cylindrical enclosure material at the tip.



The probe's characteristics are:

Frequency Range	30MHz – 6GHz
Length	337 mm
Probe tip external diameter	2.5 mm
Typical distance between dipoles and the probe tip	1 mm
Axial Isotropy (in human-equivalent liquids)	±0.3 dB
Hemispherical Isotropy (in human-equivalent liquids)	±0.5 dB
Linearity	±0.2 dB
Maximum operating SAR	100 W/kg
Lower SAR detection threshold	0.001 W/kg

Flat Phantom:

Phantom for compliance testing of handheld and body-mounted wireless devices in the frequency range of 30 MHz to 6 GHz. ELI is fully compatible with the IEC 62209-2 standard and all known tissue simulating liquids. ELI has been optimized regarding its performance and can be integrated into our standard phantom tables. A cover prevents evaporation of the liquid. Reference markings on the phantom allow installation of the complete setup, including all predefined phantom positions and measurement grids, by teaching three points. The phantom is compatible with all SPEAG dosimetric probes and dipoles.

The phantom's characteristics are:

Material	Vinylester, glass fiber reinforced (VE-GF)
Shell thickness	2 mm ± 0.2 mm
Filling volume	30 Liters approx.
Dimensions	Major axis: 600mm / Minor axis: 400mm

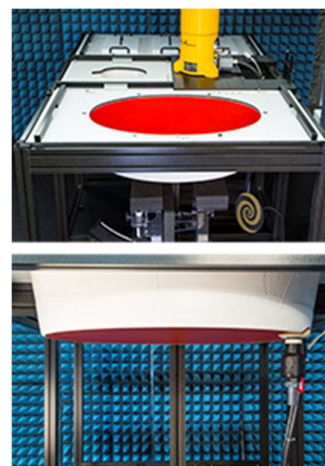

Device Positioner:

The SAR in the phantom is approximately inversely proportional to the square of the distance between the source and the liquid surface. For a source at 5 mm distance, a positioning uncertainty of 0.5 mm would produce a SAR uncertainty of 20%. Accurate device positioning is therefore crucial for accurate and repeatable measurements. The positions in which the devices must be measured are defined by the standards.



The DASY device holder is designed to cope with the different positions given in the standard. It has two scales for device rotation (with respect to the body axis) and device inclination (with respect to the line between the ear reference points). The rotation center for both scales is the ear reference point (ERP). Thus the device needs no repositioning when changing the angles.

The DASY device holder is constructed of low-loss POM material having the following dielectric parameters: relative permittivity $\epsilon=3$ and loss tangent $\delta=0.02$. The amount of dielectric material has been reduced in the closest vicinity of the device, since measurements have suggested that the influence of the clamp on the test results could thus be lowered.

A simple but effective and easy-to-use extension for the Mounting Device; facilitates testing of larger devices according to IEC 62209-2 (e.g., laptops, cameras, etc.); lightweight and fits easily on the upper part of the Mounting Device in place of the phone positioner. The extension is fully compatible with the Twin SAM, ELI and other Flat Phantoms.



Data Evaluation:**• Power Reference measurement**

The robot measures the E field in a specified reference position that can be either the selected section's grid reference point or a user point in this section at 4mm of the inner surface of the phantom, 2mm for frequencies above 3GHz.

• Area Scan

Measurement procedures for evaluating SAR from wireless handsets typically start with a coarse measurement grid to determine the approximate location of the local peak SAR values. This is known as the area-scan procedure. The SAR distribution is scanned along the inside surface of one side of the phantom head, at least for an area larger than the projection of the handset and antenna. The distance between the measured points and phantom surface should be less than 8 mm, and should remain constant (with variation less than ± 1 mm) during the entire scan in order to determine the locations of the local peak SAR with sufficient accuracy. The angle between the probe axis and the surface normal line is recommended but not required to be less than 30° . If this angle is larger than 30° and the closest point on the probe-tip housing to the phantom surface is closer than a probe diameter, the boundary effect may become larger and polarization dependent. This additional uncertainty needs to be analyzed and accounted for. To achieve this, modified test procedures and additional uncertainty analyses not described in this recommended practice may be required. The measurement and interpolation point spacing should be chosen such as to allow identification of the local peak locations to within one-half of the linear dimension of a side of the zoom-scan volume. Because a local peak having specific amplitude and steep gradients may produce a lower peak spatial-average SAR compared to peaks with slightly lower amplitude and less steep gradients, it is necessary to evaluate these other peaks as well. However, since the spatial gradients of local SAR peaks are a function of the wavelength inside the tissue-equivalent liquid and the incident magnetic field strength, it is not necessary to evaluate local peaks that are less than 2 dB or more below the global maximum peak. Two-dimensional spline algorithms (Brishoual et al. 2001; Press et al., 1996) are typically used to determine the peaks and gradients within the scanned area. If a peak is found at a distance from the scan border of less than one-half the edge dimension of the desired 1 g or 10 g cube, the measurement area should be enlarged if possible.

• Zoom Scan

To evaluate the peak spatial-average SAR values for 1 g or 10 g cubes, fine resolution volume scans, called zoom scans, are performed at the peak SAR locations identified during the area scan. The minimum zoom scan volume size should extend at least 1.5 times the edge dimension of a 1 g cube in all directions from the center of the scan volume, for both 1 g and 10 g peak spatial-average SAR evaluations. Along the phantom curved surfaces, the front face of the volume facing the tissue/liquid interface conforms to the curved boundary, to ensure that all SAR peaks are captured. The back face should be equally distorted to maintain the correct averaging mass. The flatness and orientation of the four side faces are unchanged from that of a cube whose orientation is within $\pm 30^\circ$ of the line normal to the phantom at the center of the cube face next to the phantom surface. The peak local SAR locations that were determined in the area scan (interpolated values) should be used for the centers of the zoom scans. If a scan volume cannot be centered due to proximity of a phantom shape feature, the probe should be tilted to allow scan volume enlargement. If probe tilt is not feasible, the zoom-scan origin may be shifted, but not by more than half of the 1 g or 10 g cube edge dimension.

After the zoom-scan measurement, extrapolations from the closest measured points to the surface, for example along lines parallel to the zoom-scan centerline, and interpolations to a finer resolution between all measured and extrapolated points are performed. Extrapolation algorithm considerations are described in 6.5.3, and 3-D spline methods (Brishoual et al., 2001; Kreyszig, 1983; Press et al., 1996) can be used for interpolation. The peak spatial-average SAR is finally determined by a numerical averaging of the local SAR values in the interpolation grid, using for example a trapezoidal algorithm for the integration (averaging).

In some areas of the phantom, such as the jaw and upper head regions, the angle of the probe with respect to the line normal to the surface may be relatively large, e.g., greater than $\pm 30^\circ$, which could increase the boundary effect error to a larger level. In these cases, during the zoom scan a change in the orientation of the probe, the phantom, or both is recommended but not required for the duration of the zoom scan, so that the angle between the probe axis and the line normal to the surface is within 30° for all measurement points.

- **Power Drift measurement**

The robot re-measures the E-Field in the same reference location measured at the Power Reference. The drift measurement gives the field difference in dB from the first to the last reference reading. This allows a user to monitor the power drift of the device under test that must remain within a maximum variation of $\pm 5\%$.

- **Post-processing**

The procedure for spatial peak SAR evaluation has been implemented according to the IEEE1528 and IEC 62209-1/2 and IEC/IEEE 62209-1528:2020 standards. It can be conducted for 1g and 10g.

The software allows evaluations that combine measured data and robot positions, such as:

- ✓ Maximum search
- ✓ Extrapolation
- ✓ Boundary correction
- ✓ Peak search for averaged SAR

Interpolation between the measured points is performed when the resolution of the grid is not fine enough to compute the average SAR over a given mass.

Extrapolation routines are used to obtain SAR values between the lowest measurement points and the inner phantom surface. The extrapolation is determined by the surface detection distance and the probe sensor offset. Several measurements at different distances are necessary for the extrapolation.

System and Liquid Check:

System Check

The system performance check verifies that the system operates within its specifications. System and operator errors can be detected and corrected. It is recommended that the system performance check be performed prior to any usage of the system in order to guarantee reproducible results.

The system performance check uses normal SAR measurements in a simplified setup with a well characterized source. This setup was selected to give a high sensitivity to all parameters that might fail or vary over time. The system check does not intend to replace the calibration of the components, but indicates situations where the system uncertainty is exceeded due to drift or failure.

In the simplified setup for system check, the EUT is replaced by a calibrated dipole and the power source is replaced by a controlled continuous wave generated by a signal generator. The calibrated dipole must be placed beneath the flat phantom section of the phantom at the correct distance.

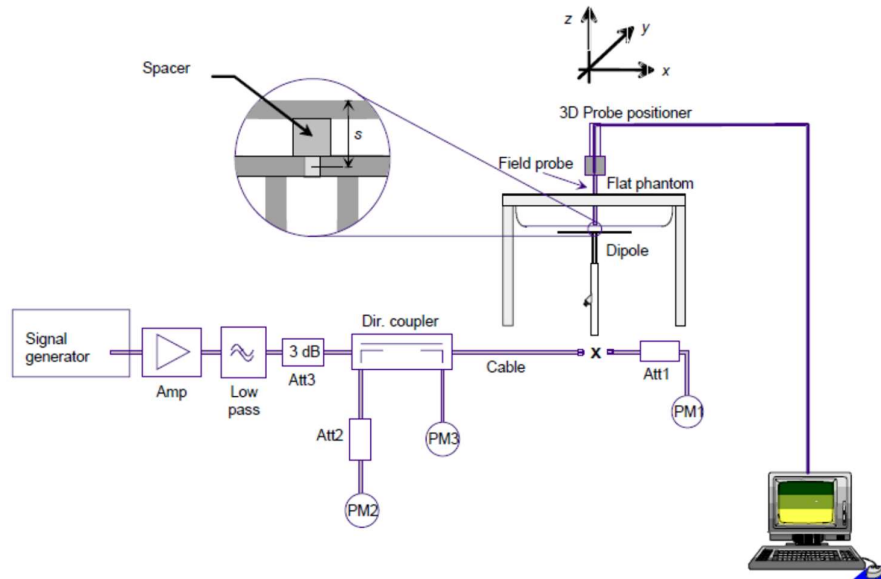

The equipment setup is shown below:

- ✓ Signal Generator
- ✓ Amplifier
- ✓ Directional coupler
- ✓ Power meter
- ✓ Calibrated dipole

First, the power meter PM1 (including attenuator Att1) is connected to the cable to measure the forward power at the location of the connector (x) to the system check source. The signal generator is adjusted for the desired forward power at the connector as read by power meter PM1 after attenuation Att1 and also as coupled through Att2 to PM2. After connecting the cable to the source, the signal generator is readjusted for the same reading at power meter PM2.

SAR results are normalized to a forward power of 1W to compare the values with the calibration reports results as described at IEEE 1528, IEC 62209 and IEC/IEEE 62209-1528:2020 standards

Liquid Check

The dielectric parameters check is done prior to the use of the tissue simulating liquid. The verification is made by comparing the relative permittivity and conductivity to the values recommended by the applicable standards.

The liquid verification was performed using the following test setup:

- ✓ VNA (Vector Network Analyzer)
- ✓ Open-Short-Load calibration kit
- ✓ RF Cable
- ✓ Open-Ended Coaxial probe
- ✓ DAK software tool
- ✓ SAR Liquid
- ✓ De-ionized water
- ✓ Thermometer

These are the target dielectric properties of the tissue-equivalent liquid material as defined in FCC OET KDB 865664 D01.

Frequency (MHz)	Head SAR	
	ϵ_r (F/m)	σ (S/m)
150	52.30	0.76
300	45.30	0.87
450	43.50	0.87
835	41.55	0.91
900	41.50	0.97
915	41.50	0.98
1450	40.50	1.20
1610	40.30	1.29
1800-2000	40.00	1.40
2450	39.20	1.80
3000	38.50	2.40
5800	35.30	5.27
6000	35.07	5.48
6500	34.46	6.07
7000	33.88	6.65

(ϵ_r = relative permittivity, σ = conductivity and ρ = 1000 kg/m³)

The measurement system implement a SAR error compensation algorithm as documented in IEEE Std 1528-2013 and IEC/IEEE 62209-1528:2020 (equivalent to draft standard IEEE P1528-2011) to automatically compensate the measured SAR results for deviations between the measured and required tissue dielectric parameters (applied to only scale up the measured SAR, and not downward) so, according to FCC OET KDB 865664 D01, the tolerance for ϵ_r and σ may be relaxed to $\pm 10\%$.

11.2. Test Equipment List

SAR system #3

ID #	Device	Type/Model	Serial Number	Manufacturer	Cal. Date	Cal. Due Date
086-000	Dosimetric E-Field probe	EX3DV4	7455	SPEAG	2024-03-08	2025-03-08
004-014	Data Acquisition Electronics	DAEip	1704	SPEAG	2024-03-11	2025-03-11
003-000	6-Axis Robot	TX60 Lspeag	F17/59RCB1/A/01	STAÜBLI	NA	NA
003-001	Robot Controller	CS8C	F17/59RCB1/C/01	STAÜBLI	NA	NA
003-002	Oval Flat Phantom	ELI V5.0	1260	SPEAG	NA	NA
003-003	Light Beam Unit	SE UKS 030 AA	1170	Di-soric	NA	NA
003-004	Measurement Server	DASY6	1547	SPEAG	NA	NA
003-005	Electro Optical Converter	EOC60	1104	SPEAG	NA	NA
004-005	Measurement Software	DASY6 v16.2	9-658E90FA	SPEAG	NA	NA
003-009	Laptop Holder	N/A	N/A	SPEAG	NA	NA

Shared equipment

ID #	Device	Type/Model	Serial Number	Manufacturer	Cal. Date	Cal. Due Date
123-000	USB Power Sensor	NRP-Z81	102278	R&S	2023-04-18	2025-04-18
124-000	USB Power Sensor	NRP-Z81	102279	R&S	2023-04-19	2025-04-19
099-000	Liquid measurement SW	DAK-3.5 V 3.0.2.3	9-2687B491	SPEAG	NA	NA
069-000	Dielectric Probe Kit	DAK-3.5	1037	SPEAG	2023-07-04	2025-07-04
017-004	Coupler	UDC-0.5G-18G-10dB-SF	000813	Amd-group	2024-02-21	2025-02-21
079-001	RF Cable	CBL-0.5M-SMSM+	226527	Mini-Circuits	2024-02-16	2025-02-16
167-001	RF Cable	CBL-2M-SMSM+	233846	Mini-Circuits	2024-02-16	2025-02-16
129-000	Signal Generator	SMB100A	178212	R&S	2024-01-31	2026-01-31
496-000	Temp & Humidity Logger	RA32E-TH1-RAS	RA32-FC8485	AVTECH	2023-04-20	2025-04-20
339-000	VNA Analyzer	ZNB 40	101740	R&S	2023-05-19	2025-05-19
198-000	0.8-21GHz RF amplifier	TVA-82-213A+	2004003	Mini-Circuits	2024-02-16	2025-02-16
384-000	0.1-6GHz RF amplifier	AMT-A0328	1818	Agile Microwave Technology	2024-02-19	2025-02-19
070-000	2450GHz System Validation Dipole	D2450GHzV2	937	SPEAG	2022-05-19	2025-05-19
084-000	5GHz System Validation Dipole	D5GHzv2	1259	SPEAG	2022-03-17	2025-03-17
097-000	System Validation Dipole 7000MHz	D7GHzV2	1008	SPEAG	2022-08-24	2025-08-24
458-000	Measurement Software	SARA V2.3	NA	Intel	NA	NA

11.3. Tissue Simulant Liquid

TSL	Manufacturer / Model	Freq Range (MHz)	Main Ingredients
Head WideBand	SPEAG HBBL600-1000V6 Batch 230425-2	600-10000	Ethandiol, Sodium petroleum sulfonate, Hexylene Glycol / 2-Methyl-pentane-2.4-diol, Alkoxylated alcohol

11.4. Measurement Uncertainty Evaluation

The system uncertainty evaluation is shown in the table below with a coverage factor of $k = 2$ to indicate a 95% level of confidence:

SPEAG DASY6 Uncertainty Budget								
According to IEC/IEEE 62209-1528 (4 MHz - 6 GHz)								
including IEEE 1528-2013 and IEC 62209-1/2016, IEC 62209-2/2010								
Symbol	Error Description	Uncert. Value	Prob Dist.	Div.	(ci) 1g	(ci) 10g	Std Unc. (1g)	Std Unc. (10g)
Measurement System Errors								
CF	<i>Probe Calibration</i>	±14.0 %	N	2	1	1	±7.0 %	±7.0 %
CF _{drift}	Probe Calibration Drift	±1.0 %	N	1	1	1	±1.0 %	±1.0 %
LIN	Probe Linearity	±4.7 %	R	√3	1	1	±2.7 %	±2.7 %
BBS	Broadband Signal	±3.0 %	N	2	1	1	±1.5 %	±1.5 %
ISO	<i>Axial Isotropy</i>	±4.7 %	R	√3	0.5	0.5	±1.4 %	±1.4 %
ISO	Hemispherical Isotropy	±9.6 %	R	√3	0.5	0.5	±2.8 %	±2.8 %
DAE	Data Acquisition	±0.3 %	N	1	1	1	±0.3 %	±0.3 %
AMB	RF Ambient	±1.8 %	N	1	1	1	±1.8 %	±1.8 %
Δ _{sys}	Probe Positioning	±0.2 %	N	1	0.33	0.33	±0.1 %	±0.1 %
DAT	Data Processing	±2.3 %	N	1	1	1	±2.3 %	±2.3 %
Phantom and Device Errors								
LIQ(σ)	Conductivity (meas.) _{DAK}	±2.5 %	N	1	0.78	0.71	±2.0 %	±1.8 %
LIQ(T _σ)	Conductivity (temp.) _{AB}	±3.4 %	R	√3	0.78	0.71	±1.5 %	±1.4 %
EPS	Phantom Permittivity	±14.0 %	R	√3	0.25	0.25	±2.0 %	±2.0 %
DAS	Distance DUT - TSL	±2.0 %	N	1	2	2	±4.0 %	±4.0 %
H	Device Holder	±3.6 %	N	1	1	1	±3.6 %	±3.6 %
MOD	DUT Modulation _m	±2.4 %	R	√3	1	1	±1.4 %	±1.4 %
TAS	Time-average SAR	±2.6 %	R	√3	1	1	±1.5 %	±1.5 %
RF _{drift}	DUT drift	±5.0 %	N	1	1	1	±2.9 %	±2.9 %
Correction to the SAR results								
C(ε, σ)	Deviation to Target	±1.9 %	N	1	1	0.84	±1.9 %	±1.6 %
Combined Std. Uncertainty							±11.5 %	±11.4 %
Expanded STD Uncertainty							±23.1 %	±22.9 %

11.5. RF Exposure Limits

SAR assessments have been made in line with the requirements of FCC 47CFR Part 2.1093 on the limitation of exposure of the general population / uncontrolled exposure for portable devices.

Exposure Type	General Population / Uncontrolled Environment
Peak spatial-average SAR (averaged over any 1 gram of tissue)	1.6 W/kg
Whole body average SAR	0.08 W/kg
Peak spatial-average SAR (extremities) (averaged over any 10 grams of tissue)	4.0 W/kg

12. PD Test & System Description

12.1. SPEAG free space Measurement System

Measurement Setup:

The DASY6/8 system for performing compliance tests consists of the following items:

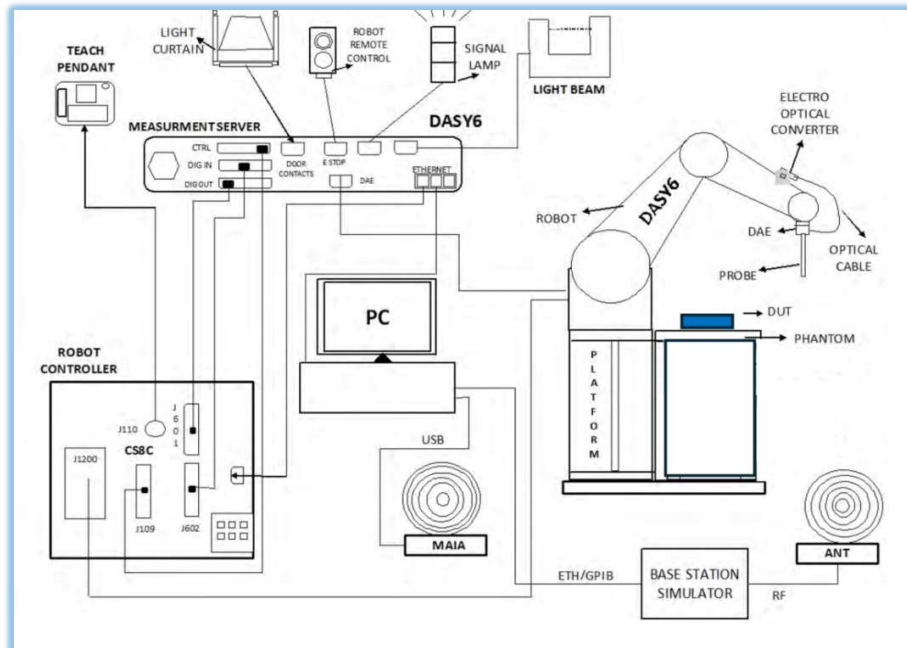

- ✓ A standard high precision 6-axis robot (Stäubli TX/RX family) with controller, teach pendant and software. It includes an arm extension for accommodating the data acquisition electronics (DAE)
- ✓ An mm-wave E-field probe optimized and calibrated for the targeted measurements.
- ✓ A data acquisition electronics (DAE) which performs the signal amplification, signal multiplexing, AD-conversion, offset measurements, mechanical surface detection, collision detection, etc. The signal is optically transmitted to the EOC.
- ✓ The Electro-optical Converter (EOC) performs the conversion from optical to electrical signals for the digital communication to the DAE. The EOC signal is transmitted to the measurement server.
- ✓ The function of the measurement server is to perform the time critical tasks such as signal filtering, control of the robot operation and fast movements interrupts.
- ✓ The Light Beam used is for probe alignment. This improves the (absolute) accuracy of the probe positioning.
- ✓ A computer running Windows professional operating system and the cDASY6/8 software.
- ✓ Remote control and teach pendant as well as additional circuitry for robot safety such as warning lamps, etc.

E-Field Measurement Probe:

The probe consists of two dipoles (0.8 mm length) optimally arranged with different angles (γ_1 and γ_2) to obtain pseudo-vector information, printed on glass substrate protected by high density foam that allows low perturbation of the measured field. Three or more measurements are taken for different probe rotational angles, deriving the amplitude and polarization information.

The probe's characteristics are:

Frequency Range	750 MHz – 110 GHz
Length	320 mm
Probe tip external diameter	8 mm
Probe's two dipoles length	0.9mm – Diode loaded
Probe's substrate	Quartz 0.9 x 20 x 0.18mm ($\epsilon_r=3.8$)
Distance between diode sensors and probe's tip	1.5 mm
Axial Isotropy	± 0.6 dB
Maximum operating E-field	3000 V/m
Lower E-field detection threshold	5 V/m @ 60 GHz
Minimum Mechanical separation between probe tip and a Surface	0.5mm
Calibration reference point	Diode Sensor

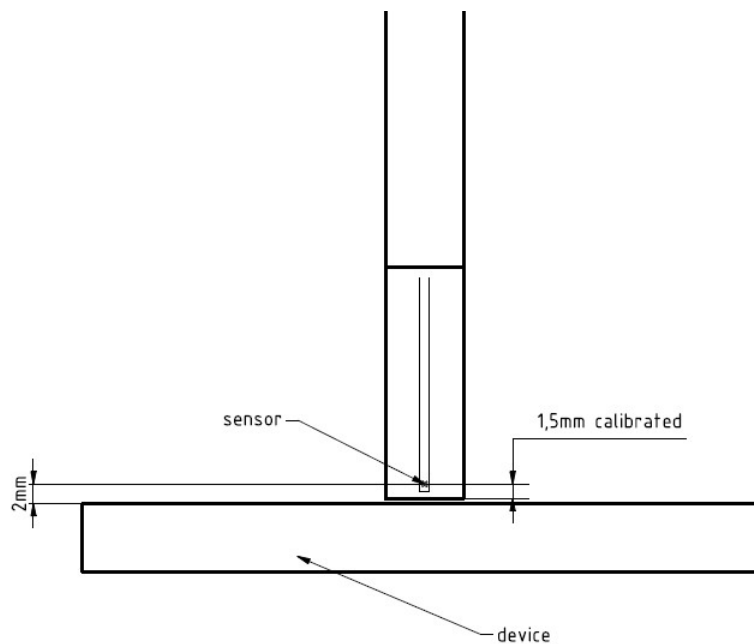

Worst Case Linearization Error:

For continuously transmitting signals (100% duty cycle), the worst case linearization error is given by the difference between non linearized voltage and linearized voltage using CW parameters. The error is increasing with the voltage levels. In our particular case, the measured voltages averaged over the signal period are below 1mV. We use 1mV in the below calculation to have the worst case condition. The signal PAR (Peak to Average Ratio) is 6dB and the diode compression point 100mV.

The maximum voltage through the diode is given by:

$$v_{peak} = v_{meas\ avg} \times PAR_{linear}$$

$$v_{peak} = 1 * 4 = 4\ mV$$

The linearized voltage using CW parameter is given by:

$$v_{lin\ peak} = v_{peak} + \frac{v_{peak}^2}{diode\ compression\ point}$$

$$v_{lin\ peak} = 4 + \frac{4^2}{100} = 4.16\ mV$$

The worst case linearization error is:

$$lin\ error = \frac{v_{lin\ peak} - v_{peak}}{v_{peak}} = \frac{4.16 - 4}{4} = 1.04 = 4\%$$

Data Evaluation:**Scan**

The scan involves the measurement of two planes with three different probe rotations. The grid steps are optimized by the software based on the test frequency. The location of the lowest measurement plane is defined by the distance of first measurement layer from device under test (DUT) entered by the user. The DUT location settings can be used to offset the center of the grid.

Total Field and Power Flux Density Reconstruction:

Computation of the power density in general requires knowledge of the electric (E-) and magnetic (H-) field amplitudes and phases in the plane of incidence. Reconstruction of these quantities from pseudo-vector E-field measurements is feasible, as they are constrained by Maxwell's equations.

The reconstruction algorithm developed by the system manufacturer, together with the ability of the probe to measure extremely close to the source without perturbing the field, permits reconstruction of the E- and H-fields, as well as of the power density, on measurement planes located as near as 0.5mm away in the frequency band of 60 GHz.

The average of the reconstructed power density is evaluated over a circular area in each measurement plane. The area of the circle is defined by the user; the default is 1 cm².

System Check

The system performance check verifies that the system operates within its specifications. It is recommended that the system performance check be performed prior to any usage of the system in order to guarantee reproducible results.

The system performance check uses normal E-field measurements in a simplified setup with a well characterized source. This setup was selected to give a high sensitivity to all parameters that might fail or vary over time. The system check does not intend to replace the calibration of the components, but indicates situations where the system uncertainty is exceeded due to drift or failure.

In the simplified setup for system check, the EUT is replaced by a calibrated source and the power source is replaced by a controlled continuous wave generated by a signal generator. The calibrated source must be placed at the correct distance from the E-field probe according to the calibration certificate.



First, the power meter is connected to the output of the signal generator to measure the forward power at the location of the connector to the system check source. The signal generator is adjusted for the desired forward power to match the system check source calibration setup at the connector as read by power meter. Then the power meter is replaced by the system check source.

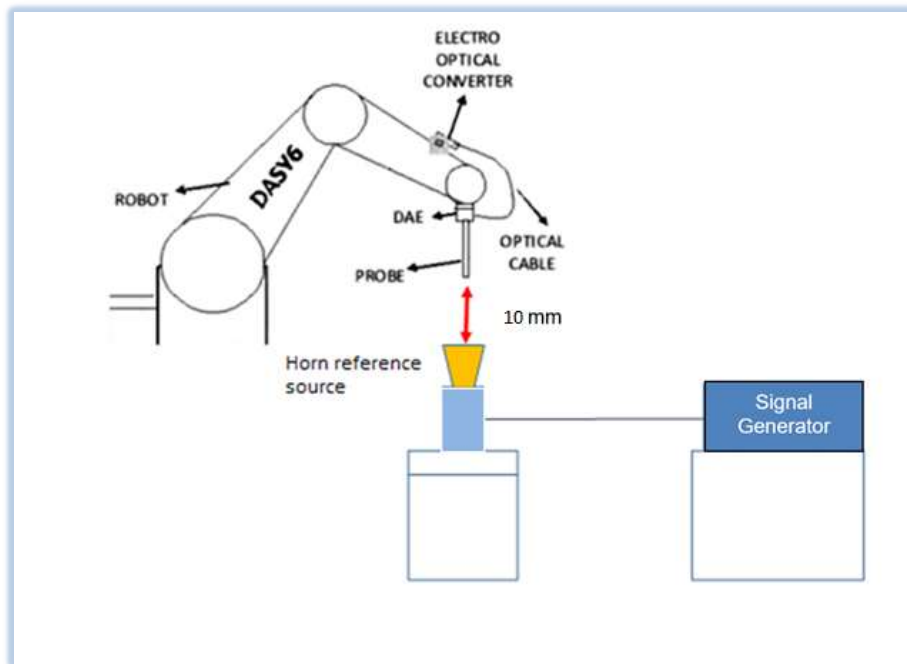

The output power on the reference source is set to 10.0 dBm (10 mW) and the measurement results E, H and Avg PD are compared with the Numerical modeling.

12.2. Test Equipment List

SAR system #4

ID #	Device	Type/Model	Serial Number	Manufacturer	Cal. Date	Cal. Due Date
443-000	E-Field probe	EUmmWV3	9538	SPEAG	2024-05-06	2025-05-06
001-017	Data Acquisition Electronics	DAEip	1703	SPEAG	2024-02-13	2025-02-13
004-000	6-axis Robot	TX90 XL	F11/5JL2A1/A/01	STAÜBLI	n/a	n/a
004-001	Robot Controller	CS8C	F11/5JL2A1/C/01	STAÜBLI	n/a	n/a
004-005	Measurement Server	DASY6 P/N: SE UMS 028 BB	-	SPEAG	n/a	n/a
004-004	Light Beam Unit	SE UKS 030 AA	1030	Di-soric	n/a	n/a
003-002	5G Phantom	mmWave	NA	SPEAG	n/a	n/a
003-006	Measurement Software	DASYmmW v2.4	9-5ED1AC01	SPEAG	n/a	n/a
004-010	Laptop Holder	P/N SM LH1 001 CD	-	SPEAG	n/a	n/a

SAR system #1

ID #	Device	Type/Model	Serial Number	Manufacturer	Cal. Date	Cal. Due Date
002-014	E-Field probe	EUmmWV3	9594	SPEAG	2024-09-10	2025-09-10
002-013	Data Acquisition Electronics	DAEip	1658	SPEAG	2024-08-08	2025-08-08
001-000	6-axis Robot	TX90 XL	F11/5JL2A1/A/01	STAÜBLI	n/a	n/a
001-004	Robot Controller	CS8C	F11/5JL2A1/C/01	STAÜBLI	n/a	n/a
004-005	Measurement Server	DASY6 P/N: SE UMS 028 BB	-	SPEAG	n/a	n/a
001-002	Light Beam Unit	SE UKS 030 AA	1030	Di-soric	n/a	n/a
195-000	5G Phantom	mmWave	NA	SPEAG	n/a	n/a
003-006	Measurement Software	DASYmmW v2.4	9-5ED1AC01	SPEAG	n/a	n/a
004-010	Laptop Holder	P/N SM LH1 001 CD	-	SPEAG	n/a	n/a

Shared equipment

ID #	Device	Type/Model	Serial Number	Manufacturer	Cal. Date	Cal. Due Date
123-000	USB Power Sensor	NRP-Z81	102278	R&S	2023-09-08	2025-04-18
124-000	USB Power Sensor	NRP-Z81	102279	R&S	2023-09-08	2025-04-18
017-004	Coupler	UDC-0.5G-18G-10dB-SF	000813	Amd-group	2024-02-21	2025-02-21
079-001	RF Cable	CBL-0.5M-SMSM+	226527	Mini-Circuits	2024-02-16	2025-04-16
167-001	RF Cable	CBL-2M-SMSM+	233846	Mini-Circuits	2024-02-16	2025-04-16
327-000	Temp & Humidity Logger	RA32E-TH1-RAS	RA32-F0DED9	AVTECH	2023-07-12	2025-07-12
129-000	Signal Generator	SMB100A	178212	R&S	2022-12-19	2024-12-19
198-000	0.8-21GHz RF amplifier	TVA-82-213A+	2004003	Mini-Circuits	2024-02-16	2025-04-16
008-081	Horn reference antenna	PE9859/SF-15	-	PAsternack	NA	NA
458-000	Measurement Software	SARA V2.3	NA	Intel	NA	NA

12.3. Measurement Uncertainty Evaluation

The system uncertainty evaluation is shown in the table below with a coverage factor of $k = 2$ to indicate a 95% level of confidence:

Table 2: DASY6 Uncertainty Budget in Compliance with IEC/IEEE 63195-1 for the cases indicated in the REFERENCE TABLE						
Error Description	Uncertainty Value (\pm dB)	Probability Distribution	Div.	(c_i)	Std. Unc. (\pm dB)	(v_i) V_{eff}
Measurement System						
Probe calibration	0.49	N	1	1	0.49	∞
Hemispherical Isotropy	0.50	R	$\sqrt{3}$	1	0.29	∞
Linearity	0.20	R	$\sqrt{3}$	1	0.12	∞
System Detection Limits	0.04	R	$\sqrt{3}$	1	0.02	∞
Data acquisition	0.03	N	1	1	0.03	∞
Field reconstruction ¹	2	R	$\sqrt{3}$	1	1.15	∞
Probe Positioning Repeatability	0.04	R	$\sqrt{3}$	1	0.02	∞
Probe Positioning offset	0.30	R	$\sqrt{3}$	1	0.17	∞
Amplitude and Phase Noise	0.04	R	$\sqrt{3}$	1	0.02	∞
Spatial Averaging	0.1	R	$\sqrt{3}$	1	0.06	∞
Frequency Response	0.2	R	$\sqrt{3}$	1	0.12	∞
Test Sample Related						
Power Drift	0.21	R	$\sqrt{3}$	1	0.12	∞
Modulation response	0.40	R	$\sqrt{3}$	1	0.23	∞
Device holder influence	0.1	R	$\sqrt{3}$	1	0.06	∞
RF Ambient Noise	0.04	R	$\sqrt{3}$	1	0.02	∞
RF Ambient Reflections	0.04	R	$\sqrt{3}$	1	0.02	∞
Combined Std. Uncertainty					1.34 dB	∞
Expanded Std. Uncertainty 95%					2.68 dB	

The REC at distance d must be modified as follows:

$$unc_{RECdB} = \begin{cases} 2.35 - 8.75d/\lambda & \text{for } d = 0.04 \dots 0.2\lambda \\ 0.6 & \text{for } d \geq 0.2\lambda \end{cases}$$

The minimal distance is 2mm, and the minimal frequency tested is 6 GHz. This corresponds to an MU value of $(2.35 - 8.75 \cdot 0.04 = 2 \text{ dB})$ --
 Ref: Speag, DASY6 Module mmWave Manual, February 2022.

12.4. RF Exposure Limits

Power density assessments have been made in line with the requirements of FCC 47CFR Part 2.1093, in particular chapter 1.1310 specifying the MPE limits, on the limitation of exposure of the general population / uncontrolled exposure for portable devices.

Exposure Type	Power density (S)
Limits for Occupational/Controlled Exposure. 1.5GHz – 100GHz	50.0 W/m²
Limits for General Population/ Uncontrolled Exposure. 1.5GHz – 100GHz	10.0 W/m²

Annex A. Test Results

The herein test results were performed by:

Test case measurement	Test Personnel
Conducted measurement	F. Heurtematte
SAR/PD measurement	M.Farhan

A.1 Test Conditions

A.1.1 Test SAR Test positions relative to the phantom

The device under test was an Intel® card inside a Notebook host platform (HSN-I61C) using a set of PIFA antennas. The card was operated utilizing proprietary software (DRTU version DRTU_06929.23.60.0) and each channel was measured using a broadband power meter to determine the maximum average power.

According to FCC OET KDB 616217 D04, the back surface and edges of the tablet should be tested for SAR compliance with the tablet touching the phantom. The SAR Test Exclusion Threshold in FCC OET KDB 447498 can be applied to determine SAR test exclusion for adjacent edge configurations.

The closest distance from the antenna to an adjacent tablet edge is used to determine if SAR testing is required for the adjacent edges, with the adjacent edge positioned against the phantom and the edge containing the antenna positioned perpendicular to the phantom.

Antenna	Main	Aux
Position	<ul style="list-style-type: none"> • Back Face • Top edge • Right Edge 	<ul style="list-style-type: none"> • Back Face • Top edge • Left Edge

See A.1.3.1 for a more detailed list of the applied reductions.

See E.2 *Test positions* section for more information on the tested positions.

A.1.2 Test signal, Output power and Test Frequencies

For 802.11 transmission modes the device was put into operation by using an own control software to program the test mode required to select the continuous transmission with 100% duty cycle.

The output power of the device was set to transmit at maximum power for all tests.

A.1.3 Evaluation Exclusion and Test Reductions

A.1.3.1 SAR evaluation exclusion

The SAR Test Exclusion Threshold in FCC OET KDB 447498 can be applied to determine SAR test exclusion for adjacent edge configurations. For 100MHz to 6GHz and test separation distances ≤ 50 mm, the 1-g and 10-g SAR test exclusion thresholds are determined by the following formula:

$$\left[\frac{\text{(max. power of channel, including tune – up tolerance, mW)}}{\text{(min. test separation distance, mm)}} \right] \cdot \left[\sqrt{f(\text{GHz})} \right] \quad (1)$$

≤ 3.0 for 1g SAR, and ≤ 7.5 for 10g extremity SAR

Where:

- f(GHz) is the RF channel transmit frequency in GHz
- Power and distance are rounded to the nearest mW and mm before calculation
- The result is rounded to one decimal place for comparison
- The values 3.0 and 7.5 are referred to as numeric thresholds

The test exclusions are applicable only when the minimum test separation distance is ≤ 50 mm, and for transmission frequencies between 100 MHz and 6 GHz. When the minimum test separation distance is < 5 mm, a distance of 5 mm is applied to determine SAR test exclusion.

For test separation distances > 50 mm, the 1-g and 10-g SAR test exclusion thresholds are determined using the following formulas:

$$\left(\left(\text{Power allowed at numeric threshold for 50 mm in (1)} \right) + \left(\text{test separation distance} - 50 \text{ mm} \right) \cdot \left(f_{\text{MHz}} / 150 \right) \right) \text{mW}, \quad (2)$$

for 100MHz to 1500MHz

$$\left(\left(\text{Power allowed at numeric threshold for 50 mm in (1)} \right) + \left(\text{test separation distance} - 50 \text{ mm} \right) \cdot 10 \right) \text{mW}, \quad (3)$$

for 1500MHz and ≤ 6 GHz

WLAN Antenna	Band Name	Output power Tablet config		Output power Notebook config		Laptop	Back face	Top Edge	Right Edge	Left Edge	Bottom Edge	Laptop	Back Face*	Top Edge	Right Edge*	Left Edge*	Bottom Edge
		dBm	mW	dBm	mW												
Main	DTS	17.50	56.23	21.50	149.62	>50	<50	<50	>50	<50	>50	R	R	T	R	R	R
	U-NII-1	14.00	25.12	20.75	118.85	>50	<50	<50	>50	<50	>50	R	R	R	R	R	R
	U-NII-2A	14.00	25.12	22.75	188.36	>50	<50	<50	>50	<50	>50	R	R	T	R	R	R
	U-NII-3	14.00	25.12	23.50	223.87	>50	<50	<50	>50	<50	>50	R	R	T	R	R	R
	U-NII-4	14.50	28.18	22.75	188.85	>50	<50	<50	>50	<50	>50	R	R	T	R	R	R
	U-NII-5	15.50	35.48	15.50	35.48	>50	<50	<50	>50	<50	>50	R	R	T	R	R	R
	U-NII-6	14.50	28.18	14.50	28.18	>50	<50	<50	>50	<50	>50	R	R	T	R	R	R
	U-NII-7	14.50	28.18	14.50	28.18	>50	<50	<50	>50	<50	>50	R	R	T	R	R	R
	U-NII-8	14.50	28.18	14.50	28.18	>50	<50	<50	>50	<50	>50	R	R	T	R	R	R
Aux	DTS	14.00	25.12	22.25	177.83	>50	<50	<50	>50	<50	>50	R	R	T	R	R	R
	U-NII-1	13.00	19.95	21.00	125.89	>50	<50	<50	<50	>50	>50	R	R	T	R	R	R
	U-NII-2A	13.00	19.95	23.00	199.52	>50	<50	<50	<50	>50	>50	R	R	R	R	R	R
	U-NII-3	13.00	19.95	23.50	223.87	>50	<50	<50	<50	>50	>50	R	R	T	R	R	R
	U-NII-4	13.00	19.95	22.75	188.36	>50	<50	<50	<50	>50	>50	R	R	T	R	R	R
	U-NII-5	14.00	25.12	14.00	25.12	>50	<50	<50	<50	>50	>50	R	R	T	R	R	R
	U-NII-6	14.00	25.12	14.00	25.12	>50	<50	<50	<50	>50	>50	R	R	T	R	R	R
	U-NII-7	14.00	25.12	14.00	25.12	>50	<50	<50	<50	>50	>50	R	R	T	R	R	R
	U-NII-8	14.00	25.12	14.00	25.12	>50	<50	<50	<50	>50	>50	R	R	T	R	R	R
BT	15.00	28.18	15.00	28.18	>50	<50	<50	<50	>50	>50	R	R	T	R	R	R	

T: Tested position

R: Reduced

* Back Face, Left Edge and Right Edge positions are covered by following modular reports:

-231109-06.TR01

-231109-06.TR07

See Annex E for a more detailed explanation of the separation distance related to the platform.

General SAR test reduction

According to FCC OET KDB 447498, testing of other required channels within the operating mode of a frequency band is not required when the reported 1-g or 10-g SAR for the mid-band or highest output power channel is:

- ≤ 0.8 W/kg or 2.0 W/kg, for 1-g or 10-g respectively, when the transmission band is ≤ 100 MHz
- ≤ 0.6 W/kg or 1.5 W/kg, for 1-g or 10-g respectively, when the transmission band is between 100 MHz and 200 MHz
- ≤ 0.4 W/kg or 1.0 W/kg, for 1-g or 10-g respectively, when the transmission band is ≥ 200 MHz

WLAN SAR Test reduction

Transmission Mode	SAR test exclusion/reduction
DSSS	<p>According to FCC OET KDB 248227 D01, SAR is measured for 2.4 GHz 802.11b, SAR test reduction is determined according to the following:</p> <ul style="list-style-type: none"> ▪ When the reported SAR of the highest measured maximum output power channel for the exposure configuration is ≤ 0.8 W/kg, no further SAR testing is required for 802.11b DSSS in that exposure configuration. ▪ When the reported SAR is > 0.8 W/kg, SAR is required for that exposure configuration using the next highest measured output power channel. When any reported SAR is > 1.2 W/kg, SAR is required for the third channel. <p>According to FCC OET KDB 248227 D01, SAR is not required for 2.4 GHz OFDM conditions when the highest reported SAR for DSSS is adjusted by the ratio of OFDM to DSSS specified maximum output power and the adjusted SAR is ≤ 1.2 W/kg.</p>
OFDM	<p>According to FCC OET KDB 248227 D01, 802.11a/g/n/ac modes have the same specified maximum output power, largest channel bandwidth, lowest order modulation and lowest data rate, the lowest order 802.11 mode is selected; i.e., 802.11a is chosen over 802.11n then 802.11ac or 802.11g is chosen over 802.11n.</p> <p>According to FCC OET KDB 248227 D01, an <i>initial test configuration</i> is determined for OFDM and DSSS transmission modes according to the channel bandwidth, modulation and data rate combination(s) with the highest maximum output power specified for production units in each standalone and aggregated frequency band. SAR is measured using the highest measured maximum output power channel. SAR test reduction for subsequent highest output test channels is determined according to reported SAR of the initial test configuration.</p> <p>The <i>initial test configuration</i> for 5 GHz OFDM transmission modes is determined by the 802.11 configuration with the highest maximum output power specified for production units, including tune-up tolerance, in each standalone and aggregated frequency band. SAR for the initial test configuration is measured using the highest maximum output power channel determined by the default power measurement procedures.</p> <p>According to FCC OET KDB 248227 D01, when the reported SAR of the initial test configuration is > 0.8 W/kg, SAR measurement is required for subsequent next highest measured output power channel(s) in the initial test configuration until reported SAR is ≤ 1.2 W/kg or all required channels are tested.</p>

A.2 Conducted Power Measurements

A.2.1 WLAN 2.4GHz

Band	Mode	Data Rate	Ch #	Freq (MHz)	Main		Aux	
					Average power (dBm)	Tune-up Pwr (dBm)	Average power (dBm)	Tune-up Pwr (dBm)
2.4GHz (DTS)	802.11b	1Mbps	1	2412	16.33	16.50	12.91	14.00
			6	2437	17.50	17.50	13.85	14.00
			11	2462	17.44	17.50	13.97	14.00
	802.11g	6Mbps	1	2412	NR1,2	17.50	NR1,2	14.00
			6	2437		17.50		14.00
			11	2462		17.50		14.00
	802.11n20	HT0	1	2412		17.50		14.00
			6	2437		17.50		14.00
			11	2462		17.50		14.00
	802.11ax20 /be20	MCS0	1	2412		17.50		14.00
			6	2437		17.50		14.00
			11	2462		17.50		14.00
	802.11n40	HT0	3	2422		17.50		14.00
			6	2437		17.50		14.00
			9	2452		17.50		14.00
	802.11ax40 /be40	MCS0	3	2422		17.50		14.00
			6	2437		17.50		14.00
			9	2452		17.50		14.00

Initial test configuration

1. NR: Not Required
2. As per FCC OET KDB 248227 D01, conducted output power and SAR testing are not required for 802.11g/n/ax channels when the highest reported SAR for DSSS is adjusted by the ratio of OFDM to DSSS specified maximum output power and the adjusted SAR is ≤ 1.2 W/kg.
3. When the reported SAR of the initial test configuration is > 0.8 W/kg, SAR measurement is required for subsequent next highest measured output power channel(s) in the initial test configuration until reported SAR is ≤ 1.2 W/kg or all required channels are tested.

A.2.1.1 Bluetooth

						Average Power (dBm)	
Band	Mode	Data Rate	Channel	Frequency (MHz)	Antenna	Avg Pwr (dBm)	Tune-up Pwr (dBm)
2.4 GHz (BT)	Bluetooth	Basic rate GFSK	0	2402	Aux	14.82	15.00
			39	2441	Aux	14.98	15.00
			78	2480	Aux	14.75	15.00
		Basic rate $\pi/4$ DQPSK	0	2402	Aux	NR ¹	12.75
			39	2441	Aux	NR ¹	12.75
			78	2480	Aux	NR ¹	12.75
		Basic rate 8-DPSK	0	2402	Aux	NR ¹	12.50
			39	2441	Aux	NR ¹	12.50
			78	2480	Aux	NR ¹	12.50
	BLE	Low energy GFSK	0	2402	Aux	NR ¹	15.00
			39	2441	Aux	NR ¹	15.00
			78	2480	Aux	NR ¹	15.00

Initial test configuration

1. NR: Not Required

A.2.2 WLAN 5GHz (U-NII)

A.2.2.1 5.2GHz and 5.3GHz (U-NII-1 and U-NII-2A)

					Average Power (dBm) - Main		Average Power (dBm) - Aux	
Band	Mode	Data Rate	Ch#	Freq (MHz)	Avg Pwr (dBm)	Tune-up Pwr (dBm)	Avg Pwr (dBm)	Tune-up Pwr (dBm)
UNII-1	802.11a20	6	36	5180	NR	14.00	NR	13.00
			40	5200	NR	14.00	NR	13.00
			44	5220	NR	14.00	NR	13.00
			48	5240	NR	14.00	NR	13.00
	802.11n20	HT0	36	5180	NR	14.00	NR	13.00
			40	5200	NR	14.00	NR	13.00
			44	5220	NR	14.00	NR	13.00
			48	5240	NR	14.00	NR	13.00
	802.11ax20/be20	MCS0	36	5180	NR	14.00	NR	13.00
			40	5200	NR	14.00	NR	13.00
			44	5220	NR	14.00	NR	13.00
			48	5240	NR	14.00	NR	13.00
	802.11n40	HT0	38	5190	NR	14.00	NR	13.00
			46	5230	NR	14.00	NR	13.00
	802.11ax40/be40	MCS0	38	5190	NR	14.00	NR	13.00
			46	5230	NR	14.00	NR	13.00
802.11ac80	VHT0	42	5210	NR	14.00	NR	13.00	
802.11ax80/be80	MCS0	42	5210	NR	14.00	NR	13.00	

Initial test configuration

1. NR: Not Required
2. When the same maximum output power is specified for both bands, begin SAR measurement in U-NII-2A band by applying the OFDM SAR requirements. If the highest reported SAR for a test configuration is ≤ 1.2 W/kg, SAR is not required for U-NII-1 band (see §0 in this document).
3. Additional conducted power measurement is required when reported SAR is > 1.2 W/kg. In case the subsequent test configuration and the channel bandwidth is smaller than the initial test configuration, all channels that overlap with the larger channel bandwidth in the initial configuration should be tested.
4. The initial test configuration for 2.4 GHz and 5 GHz OFDM transmission modes is determined by the 802.11 configuration with the highest maximum output power specified for production units, including tune-up tolerance, in each standalone and aggregated frequency band. SAR for the initial test configuration is measured using the highest maximum output power channel determined by the default power measurement procedures. When multiple transmission modes (802.11a/g/n/ac) have the same specified maximum output power, largest channel bandwidth, lowest order modulation and lowest data rate, lowest order 802.11 mode is selected (i.e. a, g, n, ac then ax)
5. When the reported SAR of the initial test configuration is > 0.8 W/kg, SAR measurement is required for the subsequent next highest measured output power channel(s) in the initial test configuration until reported SAR is $= 1.2$ W/kg or all required channels are tested.
6. When the highest reported SAR for the initial test configuration (when applicable, include subsequent highest output channels), according to the initial test position or fixed exposure requirements, is adjusted by the ratio of the subsequent test configuration to the initial test configuration specified maximum output power and the adjusted SAR is ≤ 1.2 W/kg, SAR is not required for that subsequent test configuration
7. SAR for subsequent highest measured maximum output power channels in the subsequent test configuration is required only when the reported SAR of the preceding higher maximum output power channel(s) in the subsequent test configuration is > 1.2 W/kg or until all required channels are tested.

					Average Power (dBm) - Main		Average Power (dBm) - Aux	
Band	Mode	Data Rate	Ch#	Freq (MHz)	Avg Pwr (dBm)	Tune-up Pwr (dBm)	Avg Pwr (dBm)	Tune-up Pwr (dBm)
UNII-2A	802.11a20	6	52	5260	NR	14.00	NR	13.00
			56	5280	NR	14.00	NR	13.00
			60	5300	NR	14.00	NR	13.00
			64	5320	NR	14.00	NR	13.00
	802.11n20	HT0	52	5260	NR	14.00	NR	13.00
			56	5280	NR	14.00	NR	13.00
			60	5300	NR	14.00	NR	13.00
			64	5320	NR	14.00	NR	13.00
	802.11ax20/be20	MCS0	52	5260	NR	14.00	NR	13.00
			56	5280	NR	14.00	NR	13.00
			60	5300	NR	14.00	NR	13.00
			64	5320	NR	14.00	NR	13.00
	802.11n40	HT0	54	5270	NR	14.00	NR	13.00
			62	5310	NR	14.00	NR	13.00
802.11ax40/be40	MCS0	54	5270	NR	14.00	NR	13.00	
		62	5310	NR	14.00	NR	13.00	
802.11ac80	VHT0	58	5290	NR	14.00	NR	13.00	
802.11ax80/be80	MCS0	58	5290	NR	14.00	NR	13.00	
802.11ac160	VHT0	50	5250	13.30	14.00	12.34	13.00	
802.11ax160/be160	MCS0	50	5250	NR	14.00	NR	13.00	

Initial test configuration

A.2.2.2 5.6 (U-NII-2C)

					Average Power (dBm) - Main		Average Power (dBm) - Aux	
Band	Mode	Data Rate	Ch#	Freq (MHz)	Avg Pwr (dBm)	Tune-up Pwr (dBm)	Avg Pwr (dBm)	Tune-up Pwr (dBm)
UNII-2C	802.11a20	6	100	5500	NR	14.00	NR	13.00
			104	5520	NR	14.00	NR	13.00
			108	5540	NR	14.00	NR	13.00
			112	5560	NR	14.00	NR	13.00
			116	5580	NR	14.00	NR	13.00
			120	5600	NR	14.00	NR	13.00
			124	5620	NR	14.00	NR	13.00
			128	5640	NR	14.00	NR	13.00
	802.11n20	HT0	100	5500	NR	14.00	NR	13.00
			104	5520	NR	14.00	NR	13.00
			108	5540	NR	14.00	NR	13.00
			112	5560	NR	14.00	NR	13.00
			116	5580	NR	14.00	NR	13.00
			120	5600	NR	14.00	NR	13.00
			124	5620	NR	14.00	NR	13.00
			128	5640	NR	14.00	NR	13.00
	802.11ax20/be20	MCS0	100	5500	NR	14.00	NR	13.00
			104	5520	NR	14.00	NR	13.00
			108	5540	NR	14.00	NR	13.00
			112	5560	NR	14.00	NR	13.00
			116	5580	NR	14.00	NR	13.00
			120	5600	NR	14.00	NR	13.00
			124	5620	NR	14.00	NR	13.00
			128	5640	NR	14.00	NR	13.00
	802.11n40	HT0	102	5510	NR	14.00	NR	13.00
			110	5550	NR	14.00	NR	13.00
			118	5590	NR	14.00	NR	13.00
			126	5630	NR	14.00	NR	13.00
	802.11ax40/be40	MCS0	102	5510	NR	14.00	NR	13.00
			110	5550	NR	14.00	NR	13.00
			118	5590	NR	14.00	NR	13.00
			126	5630	NR	14.00	NR	13.00
	802.11ac80	VHT0	106	5530	NR	14.00	NR	13.00
			122	5610	NR	14.00	NR	13.00
	802.11ax80/be80	MCS0	106	5530	NR	14.00	NR	13.00
			122	5610	NR	14.00	NR	13.00
	802.11ac160	VHT0	114	5570	13.38	14.00	12.44	13.00



	802.11ax160/be160	MCS0	114	5570	NR	14.00	NR	13.00
--	-------------------	------	-----	------	----	-------	----	-------

Initial test configuration

A.2.2.3 5.8GHz (U-NII-3)

					Average Power (dBm) - Main		Average Power (dBm) - Aux	
Band	Mode	Data Rate	Ch#	Freq (MHz)	Avg Pwr (dBm)	Tune-up Pwr (dBm)	Avg Pwr (dBm)	Tune-up Pwr (dBm)
UNII-3	802.11a20	6	132	5660	NR	14.00	NR	13.00
			136	5680	NR	14.00	NR	13.00
			140	5700	NR	14.00	NR	13.00
			144	5720	NR	14.00	NR	13.00
			149	5745	NR	14.00	NR	13.00
			153	5765	NR	14.00	NR	13.00
			157	5785	NR	14.00	NR	13.00
			161	5805	NR	14.00	NR	13.00
	165	5825	NR	14.00	NR	13.00		
	802.11n20	HT0	132	5660	NR	14.00	NR	13.00
			136	5680	NR	14.00	NR	13.00
			140	5700	NR	14.00	NR	13.00
			144	5720	NR	14.00	NR	13.00
			149	5745	NR	14.00	NR	13.00
			153	5765	NR	14.00	NR	13.00
			157	5785	NR	14.00	NR	13.00
			161	5805	NR	14.00	NR	13.00
	165	5825	NR	14.00	NR	13.00		
	802.11ax20/be20	MCS0	132	5660	NR	14.00	NR	13.00
			136	5680	NR	14.00	NR	13.00
			140	5700	NR	14.00	NR	13.00
			144	5720	NR	14.00	NR	13.00
			149	5745	NR	14.00	NR	13.00
			153	5765	NR	14.00	NR	13.00
			157	5785	NR	14.00	NR	13.00
			161	5805	NR	14.00	NR	13.00
	165	5825	NR	14.00	NR	13.00		
	802.11n40	HT0	134	5670	NR	14.00	NR	13.00
			142	5710	NR	14.00	NR	13.00
			151	5755	NR	14.00	NR	13.00
			159	5795	NR	14.00	NR	13.00
	802.11ax40/be40	MCS0	134	5670	NR	14.00	NR	13.00
142			5710	NR	14.00	NR	13.00	
151			5755	NR	14.00	NR	13.00	
159			5795	NR	14.00	NR	13.00	
802.11ac80	VHT0	138	5690	13.62	14.00	12.33	13.00	
		155	5775	12.73	14.00	12.84	13.00	

	802.11ax80/be80	MCS0	138	5690	NR	14.00	NR	13.00
			155	5775	NR	14.00	NR	13.00

Initial test configuration

A.2.2.4 5.9GHz (U-NII-4)

Band	Mode	Data Rate	Ch #	Freq (MHz)	Main		Aux	
					Avg Pwr (dBm)	Tune-up Pwr (dBm)	Avg Pwr (dBm)	Tune-up Pwr (dBm)
U-NII-4	802.11a	6Mbps	169	5845	NR	14.50	NR	13.00
			173	5865	NR	14.50	NR	13.00
			177	5885	NR	14.50	NR	13.00
	802.11n20	HT0	169	5845	NR	14.50	NR	13.00
			173	5865	NR	14.50	NR	13.00
			177	5885	NR	14.50	NR	13.00
	802.11ax20/be20	MCS0	169	5845	NR	14.50	NR	13.00
			173	5865	NR	14.50	NR	13.00
			177	5885	NR	14.50	NR	13.00
	802.11n40	HT0	167	5835	NR	14.50	NR	13.00
			175	5875	NR	14.50	NR	13.00
	802.11ax40/be40	MCS0	167	5835	NR	14.50	NR	13.00
			175	5875	NR	14.50	NR	13.00
	802.11ac80	VHT0	171	5855	NR	14.50	NR	13.00
802.11ax80/be80	MCS0	171	5855	NR	14.50	NR	13.00	
802.11ac160	VHT0	163	5815	13.31	14.50	12.23	13.00	
802.11ax160/be160	MCS0	163	5815	NR	14.50	NR	13.00	

A.2.3 WLAN 6-7GHz (U-NII)
A.2.3.1 6.2GHz (U-NII-5)

Band	Mode	Data Rate	Ch #	Freq (MHz)	Main		Aux	
					Avg Pwr (dBm)	Declared Max Power (dBm)	Avg Pwr (dBm)	Declared Max Power (dBm)
6GHz	802.11ax20/be20	MCS0	1	5955	NR ¹	15.50	NR ¹	14.00
			49	6195		15.50		14.00
			93	6415		15.50		14.00
	802.11ax40/be40		3	5965		15.50		14.00
			43	6165		15.50		14.00
			91	6405		15.50		14.00
	802.11ax80/be80		7	5985		15.50		14.00
			39	6145		15.50		14.00
			87	6385		15.50		14.00
			15	6025		15.50		14.00
	802.11ax160/be160		47	6185		15.50		14.00
			79	6345	15.50	14.00		
			31	6105	14.82	15.50	12.66	14.00
	802.11be320		63	6265	14.84	15.50	12.72	14.00
95		6425	13.61	15.50	12.22	14.00		

Initial test configuration

A.2.3.2 6.5GHz (U-NII-6)

Band	Mode	Data Rate	Ch #	Freq (MHz)	Main		Aux	
					Avg Pwr (dBm)	Declared Max Power (dBm)	Avg Pwr (dBm)	Declared Max Power (dBm)
6GHz	802.11ax20/be20	MCS0	97	6435	NR1	5.25	NR1	5.25
			105	6475		5.25		5.25
			113	6515		5.25		5.75
	802.11ax40/be40		99	6445		8.50		8.25
			107	6485		8.50		8.50
	802.11ax80/be80		103	6465		11.50		11.50
			119	6545		11.50		11.50
	802.11ax160/be160		111	6505	13.29	14.25	12.22	14.00

Initial test configuration

A.2.3.3 6.7GHz (U-NII-7)

Band	Mode	Data Rate	Ch #	Freq (MHz)	Main		Aux		
					Avg Pwr (dBm)	Declared Max Power (dBm)	Avg Pwr (dBm)	Declared Max Power (dBm)	
6GHz	802.11ax20/be20	MCS0	117	6535	NR1	14.50	NR1	14.00	
			149	6695		14.50		14.00	
			181	6855		14.50		14.00	
	802.11ax40/be40		115	6525		14.50		14.00	
			147	6685		14.50		14.00	
			179	6845		14.50		14.00	
	802.11ax80/be80		135	6625		14.50		14.00	
			151	6705		14.50		14.00	
			167	6785		14.50		14.00	
			143	6665		14.50		14.00	
	802.11ax160/be160		175	6825		14.50		14.00	
			127	6585		13.78		14.50	13.00
	802.11be320		159	6745		13.75		14.50	12.77

Initial test configuration

A.2.3.4 7.0GHz (U-NII-8)

Band	Mode	Data Rate	Ch #	Freq (MHz)	Main		Aux			
					Avg Pwr (dBm)	Avg Pwr (dBm)	Avg Pwr (dBm)	Declared Max Power (dBm)		
6GHz	802.11ax20/be20	MCS0	185	6875	NR ¹	5.50	NR ¹	5.50		
			209	6995		5.50		5.50		
			233	7115		0.00		-0.20		
	802.11ax40/be40		187	6885		8.50		8.50		
			211	7005		8.50		8.45		
			227	7085		8.50		8.50		
	802.11ax80/be80		183	6865		11.25		11.50		
			199	6945		11.50		11.50		
			215	7025		11.50		11.50		
	802.11ax160/be160		207	6985		13.50		14.50	12.32	14.00
	802.11be320		191	6905		13.04		13.50	12.87	14.00

Initial test configuration

A.3 Tissue Parameters Measurement

Freq.(MHz)	Target Parameters		Measured TSL Parameters		Deviation (%)		Date
	ϵ' (F/m)	σ (S/m)	ϵ' (F/m)	σ (S/m)	Deviation ϵ'	Deviation σ	
2450	39.20	1.80	40.45	1.88	3.19	4.44	2024-09-16
5200	35.99	4.66	35.37	4.71	-1.72	1.07	
5300	35.87	4.76	35.20	4.85	-1.87	1.89	
5500	35.64	4.96	34.87	5.08	-2.16	2.42	
5600	35.53	5.07	34.67	5.19	-2.42	2.37	
5800	35.30	5.27	34.29	5.37	-2.86	1.90	
2450	39.20	1.80	40.66	1.90	3.72	5.56	2024-09-19
5200	35.99	4.66	35.44	4.71	-1.53	1.07	
5300	35.87	4.76	35.27	4.85	-1.67	1.89	
5500	35.64	4.96	34.92	5.10	-2.02	2.82	
5600	35.53	5.07	34.71	5.21	-2.31	2.76	
5800	35.30	5.27	34.31	5.40	-2.80	2.47	
7000	33.88	6.65	32.06	6.82	-5.37	2.56	2024-09-16
			31.98	6.87	-5.61	3.31	2024-09-19

See Annex C for more details.

A.4 System Check Measurements

Frequency (MHz)	Average	Target SAR (W/kg)	Measured SAR (W/kg)	Deviation to target (%)	Forwarded Power (mW)	Limit (%)	Date
2450	1g	51.00	53.00	3.92	50.00	± 10	2024-09-19
	10g	23.80	24.80	4.20			2024-09-19
5300	1g	80.40	79.40	-3.05			2024-09-19
	10g	22.90	22.60	-1.74			2024-09-19
5500	1g	85.00	86.00	-0.46			2024-09-19
	10g	24.00	24.60	2.50			2024-09-19
5600	1g	83.50	89.40	5.67			2024-09-19
	10g	23.90	25.40	6.72			2024-09-19
5800	1g	80.50	82.40	0.12			2024-09-19
	10g	22.70	23.40	2.63			2024-09-19
7000	1g	278.00	273.36	-1.67	13.48	2024-09-19	
	10g	48.70	48.61	-0.18		2024-09-19	
7000	1g	278.00	279.67	0.60	13.48	2024-09-18	
	10g	48.70	49.75	2.16		2024-09-18	

See Annex B for more details.

A.4.1 E-Field

Frequency	Signal Type	Target E-field (V/m)	Measured E-field (V/m)	Deviation (%)	Date
6.5 GHz	Continuous Wave	60.60	59.79	-1.32	2024-09-25
6.5 GHz	Continuous Wave	60.60	63.84	5.36	2024-09-23

The E-fields presented in the System Check Measurements table are Peak values. The target E-field value is obtained by simulation. The maximum target E-field value at 10 mm with 10 dBm (10 mW) source power is 60.60 V/m. The maximum measured E-field value at 10 mm with 10 dBm (10 mW) is 59.79 V/m.

The E-fields presented in the System Check Measurements table are Peak values. The target E-field value is obtained by simulation. The maximum target E-field value at 10 mm with 10 dBm (10 mW) source power is 60.60 V/m. The maximum measured E-field value at 10 mm with 10 dBm (10 mW) is 63.84 V/m.

A.4.2 H-Field

Frequency	Signal Type	Target H-field (A/m)	Measured H-field (A/m)	Deviation (%)	Date
6.5 GHz	Continuous Wave	0.17	0.17	0.00	2024-09-25
6.5 GHz	Continuous Wave	0.17	0.16	-7.65	2024-09-23

The H-fields presented in the System Check Measurements table are Peak values. The target H-field value is obtained by simulation. The maximum target H-field value at 10 mm with 10 dBm (10 mW) source power is 0.17 A/m. The maximum measured E-field value at 10 mm with 10 dBm (10 mW) is 0.16 A/m.

The H-fields presented in the System Check Measurements table are Peak values. The target H-field value is obtained by simulation. The maximum target H-field value at 10 mm with 10 dBm (10 mW) source power is 0.17 A/m. The maximum measured E-field value at 10 mm with 10 dBm (10 mW) is 0.17 A/m.

A.4.3 Local Power Density

Frequency	Signal Type	Target Local Power Density (W/m ²)	Measured Local Power Density (W/m ²)	Deviation (%)	Date
6.5 GHz	Continuous Wave	5.12	5.02	-1.95	2024-09-25
6.5 GHz	Continuous Wave	5.12	4.99	-2.64	2024-09-23

The Local Power Density presented in the System Check Measurements table are Peak values. The target Local Power Density value is obtained by simulation. The maximum target Local Power Density value at 10 mm with 10 dBm (10 mW) source power is 5.12 W/m². The maximum measured E-field value at 10 mm with 10 dBm (10 mW) is 5.02 W/m².

The Local Power Density presented in the System Check Measurements table are Peak values. The target Local Power Density value is obtained by simulation. The maximum target Local Power Density value at 10 mm with 10 dBm (10 mW) source power is 5.12 W/m². The maximum measured E-field value at 10 mm with 10 dBm (10 mW) is 4.99 W/m².

A.4.4 Averaged Power Density

Frequency	Signal Type	Target Spatially Averaged Power Density (W/m ²)	Measured Spatially Averaged Power Density (W/m ²)	Deviation (%)	Date
6.5 GHz	Continuous Wave	4.93	4.62	-6.29	2024-09-25
6.5 GHz	Continuous Wave	4.93	4.88	-1.10	2024-09-23

The Spatially Averaged Power Density presented in the System Check Measurements table are Peak values. The target Spatially Averaged Power Density value is obtained by simulation. The maximum target Spatially Averaged Power Density value at 10 mm with 10 dBm (10 mW) source power is 4.93 W/m². The maximum measured Spatially Averaged Power Density value at 10 mm with 10 dBm (10 mW) is 4.62 W/m².

The Spatially Averaged Power Density presented in the System Check Measurements table are Peak values. The target Spatially Averaged Power Density value is obtained by simulation. The maximum target Spatially Averaged Power Density value at 10 mm with 10 dBm (10 mW) source power is 4.93 W/m². The maximum measured Spatially Averaged Power Density value at 10 mm with 10 dBm (10 mW) is 4.88 W/m².

See *Annex B* for more details.

A.5 SAR Test Results

A.5.1 Bluetooth & 802.11b/g/n/ax/be – 2.4GHz - DTS

Antenna	Mode	Data rate	BW (MHz)	Channel Number	Freq (MHz)	Test position mode	Antenna	Scaling Factor (dB)	Measured SAR 1g (W/kg)	Reported SAR 1g (W/kg)	Plot #
Vendor 1	802.15	DH5	1	39	2441	Top edge	Aux	0.02	0.06	0.06	
	802.11b	1Mbps	20	6	2437		Main	0.00	0.67	0.67	
				11	2462		Aux	0.03	0.21	0.21	
Vendor 2	802.15	DH5	1	39	2441	Top edge	Aux	0.02	0.09	0.09	
	802.11b	1Mbps	20	6	2437		Main	0.00	0.79	0.79	1
				11	2462		Aux	0.03	0.29	0.29	

A.5.2 802.11a/n/ac/ax/be – 5.3 GHz – U-NII-2A

Antenna	Mode	Data rate	BW (MHz)	Channel Number	Freq (MHz)	Test position mode	Antenna	Scaling Factor (dB)	Measured SAR 1g (W/kg)	Reported SAR 1g (W/kg)	Plot #
Vendor 1	802.11ac	VHT0	160	50	5250	Top edge	Aux	0.64	0.21	0.25	
	802.11ac	VHT0					Main	0.70	0.23	0.27	2
Vendor 2	802.11ac	VHT0	160	50	5250	Top edge	Aux	0.64	0.18	0.21	
	802.11ac	VHT0					Main	0.70	0.22	0.26	

A.5.3 802.11a/n/ac/ax/be – 5.6 GHz – U-NII-2C

Antenna	Mode	Data rate	BW (MHz)	Channel Number	Freq (MHz)	Test position mode	Antenna	Scaling Factor (dB)	Measured SAR 1g (W/kg)	Reported SAR 1g (W/kg)	Plot #
Vendor 1	802.11ac	VHT0	160	114	5570	Top edge	Aux	0.57	0.23	0.26	
	802.11ac	VHT0					Main	0.62	0.31	0.35	
Vendor 2	802.11ac	VHT0	160	114	5570	Top edge	Aux	0.57	0.29	0.33	
	802.11ac	VHT0					Main	0.62	0.35	0.40	3

A.5.4 802.11a/n/ac/ax/be – 5.8 GHz – U-NII-3

Antenna	Mode	Data rate	BW (MHz)	Channel Number	Freq (MHz)	Test position mode	Antenna	Scaling Factor (dB)	Measured SAR 1g (W/kg)	Reported SAR 1g (W/kg)	Plot #
Vendor 1	802.11ac	VHT0	80	138	5690	Top edge	Aux	0.67	0.20	0.24	
							Main	0.39	0.30	0.33	
Vendor 2	802.11ac	VHT0	80	138	5690	Top edge	Aux	0.67	0.24	0.28	
							Main	0.39	0.36	0.42	4

A.5.5 802.11a/n/ac/ax/be – 5.9 GHz – U-NII-4

Antenna	Mode	Data rate	BW (MHz)	Channel Number	Freq (MHz)	Test position mode	Antenna	Scaling Factor (dB)	Measured SAR 1g (W/kg)	Reported SAR 1g (W/kg)	Plot #
Vendor 1	802.11ac	VHT0	160	163	5815	Top edge	Aux	0.77	0.31	0.37	5
							Main	0.70	0.26	0.31	
Vendor 2	802.11ac	VHT0	160	163	5815	Top edge	Aux	0.77	0.24	0.29	
							Main	0.70	0.21	0.25	

A.5.6 802.11ax/be – 6.2 GHz – U-NII-5

Antenna	Mode Data Rate	BW (MHz)	Channel Number	Freq (MHz)	Test position mode	Ant	Scaling Factor (dB).	Measured SAR 1g. (W/kg)	Reported SAR 1g (W/kg)	SAR 10g (W/kg)	Estimated epithelial PD (W/m ²)*		No Plot
										Measured	1cm ²	4cm ²	
Vendor 1	802.11be MCS0	320	31	6105	Top edge	Aux	1.34	0.24	0.33	0.07			
			63	6265	Top edge						1.28	0.25	0.34
			31	6105	Top edge	Main	0.68	0.52	0.61	0.14			
			63	6265	Top edge						0.66	0.56	0.65
Vendor 2	802.11be MCS0	320	31	6105	Top edge	Aux	1.34	0.16	0.22	0.05			
			63	6265	Top edge						1.28	0.17	0.23
			31	6105	Top edge	Main	0.68	0.45	0.53	0.14			
			63	6265	Top edge						0.66	0.40	0.47

A.5.7 802.11ax/be – 6.5 GHz – U-NII-6

Antenna	Mode Data Rate	BW (MHz)	Channel Number	Freq (MHz)	Test position mode	Ant	Scaling Factor (dB).	Measured SAR 1g. (W/kg)	Reported SAR 1g (W/kg)	SAR 10g (W/kg)	Estimated epithelial PD (W/m ²)		No Plot
										Measured	1cm ²	4cm ²	
Vendor 1	802.11ax MCS0	160	111	6505	Top edge	Aux	1.78	0.21	0.32	0.06			
					Top edge	Main					0.96	0.30	0.38
Vendor 2	802.11ax MCS0	160	111	6505	Top edge	Aux	1.78	0.13	0.20	0.04			
					Top edge	Main					0.96	0.26	0.32

A.5.8 802.11ax/be – 6.7 GHz – U-NII-7

Antenna	Mode Data Rate	BW (MHz)	Channel Number	Freq (MHz)	Test position mode	Ant	Scaling Factor (dB).	Measured SAR 1g. (W/kg)	Reported SAR 1g (W/kg)	SAR 10g (W/kg)	Estimated epithelial PD (W/m ²)		No Plot
										Measured	1cm ²	4cm ²	
Vendor 1	802.11 be MCS0	320	127	6585	Top edge	Aux	1.00	0.24	0.30	0.07			
			127	6585	Top edge	Main	0.72	0.43	0.51	0.12	4.33	2.83	8
Vendor 2	802.11 be MCS0	320	127	6585	Top edge	Aux	1.00	0.13	0.16	0.03			
			127	6585	Top edge	Main	0.72	0.41	0.48	0.10			

A.5.9 802.11ax/be – 7.0 GHz – U-NII-8

Antenna	Mode Data Rate	BW (MHz)	Channel Number	Freq (MHz)	Test position mode	Ant	Scaling Factor (dB).	Measured SAR 1g. (W/kg)	Reported SAR 1g (W/kg)	SAR 10g (W/kg)	Estimated epithelial PD (W/m ²)		No Plot
										Measured	1cm ²	4cm ²	
Vendor 1	802.11 be MCS0	320	191	6905	Top edge	Aux	1.13	0.17	0.22	0.05			
	802.11 ax/ be MCS0	160	207	6985	Top edge	Main	1.00	0.30	0.38	0.09			
Vendor 2	802.11 be MCS0	320	191	6905	Top edge	Aux	1.13	0.13	0.17	0.03			
	802.11 ax/ be MCS0	160	207	6985	Top edge	Main	1.00	0.31	0.39	0.07	3.95	1.71	9

A.6 PD Test Results

A.6.1 802.11ax/be – 6.2 GHz – U-NII-5

Ant.	Mode Data rate	BW (MHz)	Ch #	Freq (MHz)	Position	*Uncertainty Cor. Factor	PStot avg [W/m ²] 1cm ²	**C-PStot avg [W/m ²] 1cm ²	PStot avg [W/m ²] 4cm ²	**C-PStot avg [W/m ²] 4cm ²	EM E [V/m]	EM H [A/m]	Plot #
Main Vendor 1	802.11be	320	31	6105	Top edge	1.55	3.57	5.53	3.15	4.88	70.20	0.20	
			63	6265		1.55	4.85	7.52	3.59	5.56	83.40	0.20	
Main vendor2	802.11be	320	31	6105	Top edge	1.55	5.69	8.82	3.88	6.01	71.50	0.24	10
			63	6265		1.55	2.67	4.14	2.33	3.61	58.90	0.19	

* The correction factor uncertainty in dB corresponds to the difference between the actual uncertainty and the 30% target value, as per the TCB Workshop Oct 20

**C-PStot = Compensated PStot

A.6.2 802.11ax/be – 6.5 GHz – U-NII-6

Ant.	Mode Data rate	BW (MHz)	Ch #	Freq (MHz)	Position	Uncertainty Cor. Factor	PStot avg [W/m ²] 1cm ²	C-PStot avg [W/m ²] 1cm ²	PStot avg [W/m ²] 4cm ²	C-PStot avg [W/m ²] 4cm ²	EM E [V/m]	EM H [A/m]	Plot #
Vendor 1 Main	802.11ax/be	160	111	6505	Top edge	1.55	2.40	3.72	1.97	3.05	68.50	0.16	11
Vendor 2 Main	802.11ax/be	160	111	6505	Top edge	1.55	2.25	3.49	1.64	2.54	43.00	0.07	

A.6.3 802.11ax/be – 6.7 GHz – U-NII-7

Ant.	Mode Data rate	BW (MHz)	Ch #	Freq (MHz)	Position	Uncertainty Cor. Factor	PStot avg [W/m ²] 1cm ²	C-PStot avg [W/m ²] 1cm ²	PStot avg [W/m ²] 4cm ²	C-PStot avg [W/m ²] 4cm ²	EM E [V/m]	EM H [A/m]	Plot #
Vendor 1 Main	802.11be	320	127	6585	Top edge	1.55	4.51	6.99	2.96	4.59	77.20	0.28	12
Vendor 2 Main	802.11be	320	127	6585	Top edge	1.55	2.71	4.20	1.87	2.90	57.10	0.17	

A.6.4 802.11ax/be – 7.0 GHz – U-NII-8

Ant.	Mode Data rate	BW (MHz)	Ch #	Freq (MHz)	Position	Uncertainty Cor. Factor	PStot avg [W/m ²] 1cm ²	C-PStot avg [W/m ²] 1cm ²	PStot avg [W/m ²] 4cm ²	C-PStot avg [W/m ²] 4cm ²	EM E [V/m]	EM H [A/m]	Plot #
Main Vendor 1	802.11ax/be	160	207	6985	Top edge	1.55	1.87	2.90	1.26	1.95	51.80	0.15	
Main Vendor 2	802.11ax/be	160	207	6985	Top edge	1.55	2.73	4.23	2.14	3.32	56.80	0.15	13

A.7 SAR Measurement Variability

According to FCC OET KDB 865664, SAR Measurement variability is assessed when the maximum initial measured SAR is ≥ 0.8 W/kg for a certain band/mode. If the measured SAR value of the initial repeated measurement is < 1.45 W/kg with $< 20\%$ variation, only one repeated measurement is required to confirm that the results are not expected to have substantial variations.

A.8 Simultaneous Transmission SAR Evaluation

According to FCC OET KDB 447498, when the sum of 1g SAR for all simultaneously transmitting antennas in an operating mode and exposure condition combination is within the SAR limit, SAR test exclusion applies to that simultaneous transmission configuration.

All the values stated in the table below are the worst case found for standalone measurement with disregard of the transmission mode or channel where the worst case was found

Antenna	Position	Highest Reported SAR (1g) (W/kg)			
		WLAN 2.4GHz	WLAN 5GHz/6GHz	Bluetooth	NFC*
Main	Top Edge	0.79	0.65		
Aux	Top Edge	0.29	0.37	0.09	<0.01

* Refer to this test report for NFC Wireless Charging Module : NFC_FA2N1807-02_R01_FCC SAR_Inventec_Report

Position	Simultaneous Tx Antenna Combination			Σ SAR 1g (W/kg)	Limit (W/kg)
	Main Antenna	Aux Antenna	NFC		
Back Face	WLAN 5GHz/6GHz	WLAN 5GHz/6GHz	WLC	1.02	1.6
	WLAN 5GHz/6GHz	WLAN 5GHz/6GHz + BT	WLC	1.11	
	WLAN 5GHz/6GHz	BT	WLC	0.74	
	WLAN 2.4GHz	WLAN 2.4GHz	WLC	1.08	
	WLAN 2.4GHz	BT	WLC	0.88	

Considering the results described above and according to the simultaneous transmission evaluation exclusions described in FCC OET KDB 447498, no enlarged zoom scan measurements are required

Annex B. Test System Plots

1.	DTS - 802.11b, CH6, Main – Vendor 2- Top edge (SAR)	55
2.	U-NII-2A - 802.11ac160, CH50, Main – Vendor 1 Top edge (SAR).....	56
3.	U-NII-2C - 802.11ac160, CH114, Main– Vendor 2 – Top edge (SAR).....	57
4.	U-NII-3 - 802.11ac80, CH138, Main– Vendor 2 – Top edge (SAR)	58
5.	U-NII-4- 802.11ax160, CH163, Aux – Vendor 1 – Top edge (SAR).....	60
6.	U-NII-5 - 802.11be320, CH63, Main – Vendor 1 – Top edge (SAR)	60
7.	U-NII-6 - 802.11ax160, CH111, Main – Vendor 1 – Top edge (SAR)	61
8.	U-NII-7 - 802.11be320, CH127, Main – Vendor 1 – Top edge (SAR)	62
9.	U-NII-8 - 802.11ax160, CH207, Main – Vendor 2 – Top edge (SAR)	63
10.	System Check 2450MHz	64
11.	System Check 5300MHz	65
12.	System Check 5500MHz	66
13.	System Check 5600MHz	67
14.	System Check 7000MHz	69
15.	U-NII-5 - 802.11be320, CH31, Main Vendor 2 – Position Top edge (PD)	71
16.	U-NII-6 - 802.11ax/be160, CH111, Main Vendor 1 – Position Top edge (PD)	72
17.	U-NII-7 - 802.11be320, CH127, Aux Vendor 1– Position Top edge (PD).....	73
18.	U-NII-8 - 802.11ax/be160, CH207, Main Vendor 2– Position Top edge (PD)	74
19.	Power Density System Check From 6500MHz-2024-09-25.....	75
20.	Power Density System Check From 6500MHz-2024-09-23.....	75

1. DTS - 802.11b, CH6, Main- Vendor 2- Top edge (SAR)

Device under Test Properties

Model, Manufacturer	Dimensions [mm]	SN	DUT Type
HSN-I61C	310.0 x 215.0 x 15.0	0004770B52	Convertible PC

Exposure Conditions

Phantom Section, TSL	Position, Test Distance [mm]	Band	Group, UID	Frequency [MHz], Channel Number	Conversion Factor	TSL Conductivity [S/m]	TSL Permittivity
Flat, HSL	EDGE TOP, 0.00	WLAN 2.4GHz	WLAN, 10415-AAA	2437.000, 6	6.88	1.89	40.7

Hardware Setup

Phantom	TSL, Measured Date	Probe, Calibration Date	DAE, Calibration Date
ELI V5.0 (20deg probe tilt) -	HBBL-600-10000, 2024-Sep-19	EX3DV4 - SN7455, 2024-03-08	DAE4ip Sn1704, 2024-03-11

Scan Setup

	Area Scan	Zoom Scan
Grid Extents [mm]	140.0 x 160.0	30.0 x 30.0 x 30.0
Grid Steps [mm]	10.0 x 10.0	3.4 x 3.4 x 1.4
Sensor Surface [mm]	3.0	1.4
Graded Grid	N/A	Yes
Grading Ratio	N/A	1.4
MAIA	Confirmed by MAIA	Confirmed by MAIA
Surface Detection	VMS + 6p	VMS + 6p
Scan Method	Measured	Measured

Measurement Results

	Area Scan	Zoom Scan
Date	2024-09-19, 17:57	2024-09-19, 18:12
psSAR1g [W/kg]	0.759	0.794
psSAR10g [W/kg]	0.369	0.338
Power Drift [dB]	-0.01	0.00
Power Scaling	Disabled	Disabled
Scaling Factor [dB]		
TSL Correction	Positive Only	Positive Only
M2/M1 [%]		58.1
Dist 3dB Peak [mm]		4.1

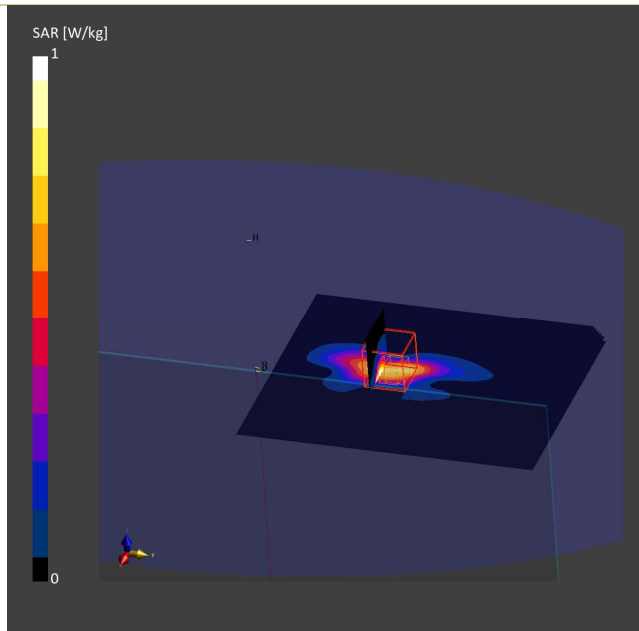

2. U-NII-2A - 802.11ac160, CH50, Aux Vendor 1– Top edge (SAR)

Device under Test Properties

Model, Manufacturer	Dimensions [mm]	SN	DUT Type
HSN-I61C	310.0 x 215.0 x 15.0	0004770B49	Convertible PC

Exposure Conditions

Phantom Section, TSL	Position, Test Distance [mm]	Band	Group, UID	Frequency [MHz], Channel Number	Conversion Factor	TSL Conductivity [S/m]	TSL Permittivity
Flat, HSL	EDGE TOP, 0.00	WLAN 5GHz	WLAN, 10456-AAD	5250.000, 50	5.27	4.78	35.3

Hardware Setup

Phantom	TSL, Measured Date	Probe, Calibration Date	DAE, Calibration Date
ELI V5.0 (20deg probe tilt) -	HBBL-600-10000, 2024-Sep-16	EX3DV4 - SN7455, 2024-03-08	DAE4ip Sn1704, 2024-03-11

Scan Setup

	Area Scan	Zoom Scan
Grid Extents [mm]	160.0 x 160.0	22.0 x 22.0 x 22.0
Grid Steps [mm]	10.0 x 10.0	4.0 x 4.0 x 1.4
Sensor Surface [mm]	3.0	1.4
Graded Grid	N/A	Yes
Grading Ratio	N/A	1.4
MAIA	Confirmed by MAIA	Confirmed by MAIA
Surface Detection	VMS + 6p	VMS + 6p
Scan Method	Measured	Measured

Measurement Results

	Area Scan	Zoom Scan
Date	2024-09-19, 02:28	2024-09-19, 02:37
psSAR1g [W/kg]	0.213	0.232
psSAR10g [W/kg]	0.072	0.073
Power Drift [dB]	0.03	0.03
Power Scaling	Disabled	Disabled
Scaling Factor [dB]		
TSL Correction	Positive Only	Positive Only
M2/M1 [%]		62.2
Dist 3dB Peak [mm]		6.1

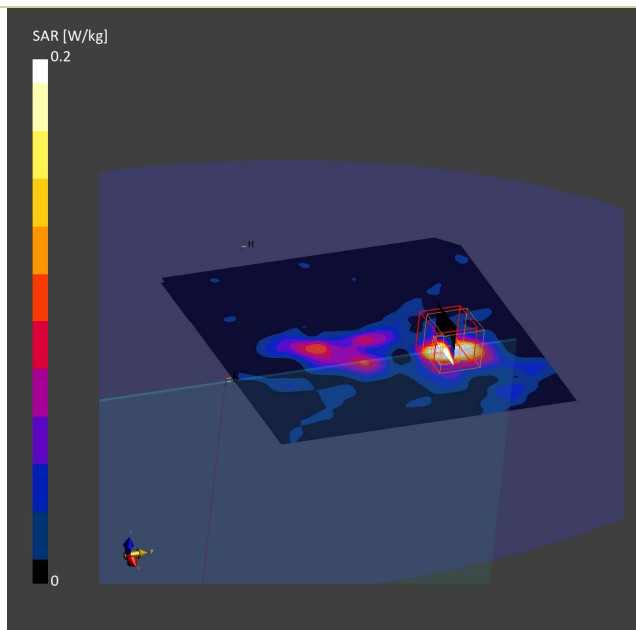

3. U-NII-2C - 802.11ac160, CH114, Main Vendor 2 – Top edge (SAR)

Device under Test Properties

Model, Manufacturer	Dimensions [mm]	SN	DUT Type
HSN-I61C	310.0 x 215.0 x 15.0	0004770B52	Convertible PC

Exposure Conditions

Phantom Section, TSL	Position, Test Distance [mm]	Band	Group, UID	Frequency [MHz], Channel Number	Conversion Factor	TSL Conductivity [S/m]	TSL Permittivity
Flat, HSL	EDGE TOP, 0.00	WLAN 5GHz	WLAN, 10456-AAD	5570.000, 114	4.29	5.18	34.8

Hardware Setup

Phantom	TSL, Measured Date	Probe, Calibration Date	DAE, Calibration Date
ELI V5.0 (20deg probe tilt) -	HBBL-600-10000, 2024-Sep-19	EX3DV4 - SN7455, 2024-03-08	DAE4ip Sn1704, 2024-03-11

Scan Setup

	Area Scan	Zoom Scan
Grid Extents [mm]	140.0 x 160.0	22.0 x 22.0 x 22.0
Grid Steps [mm]	10.0 x 10.0	4.0 x 4.0 x 1.4
Sensor Surface [mm]	3.0	1.4
Graded Grid	N/A	Yes
Grading Ratio	N/A	1.4
MAIA	Confirmed by MAIA	Confirmed by MAIA
Surface Detection	VMS + 6p	VMS + 6p
Scan Method	Measured	Measured

Measurement Results

	Area Scan	Zoom Scan
Date	2024-09-19, 18:40	2024-09-19, 18:49
psSAR1g [W/kg]	0.325	0.350
psSAR10g [W/kg]	0.107	0.102
Power Drift [dB]	0.04	0.03
Power Scaling	Disabled	Disabled
Scaling Factor [dB]		
TSL Correction	Positive Only	Positive Only
M2/M1 [%]		60.9
Dist 3dB Peak [mm]		5.6

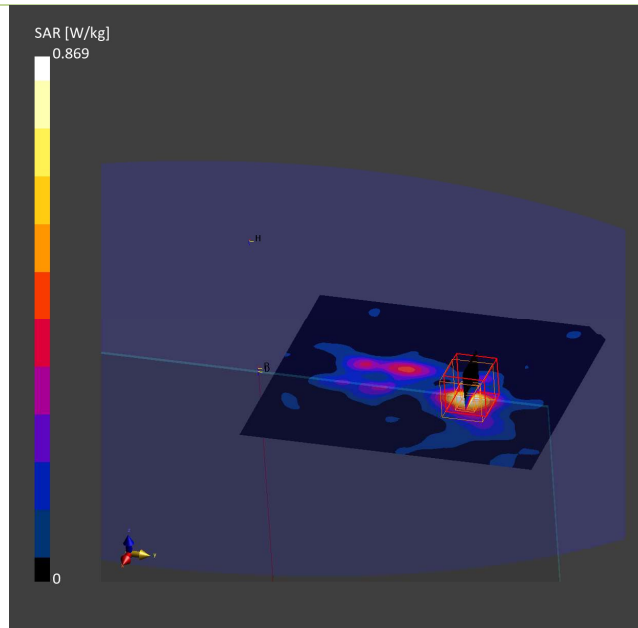

4. U-NII-3 - 802.11ac80, CH138, Main Vendor 2 – Top edge (SAR)

Device under Test Properties

Model, Manufacturer	Dimensions [mm]	SN	DUT Type
HSN-I61C	310.0 x 215.0 x 15.0	0004770B52	Convertible PC

Exposure Conditions

Phantom Section, TSL	Position, Test Distance [mm]	Band	Group, UID	Frequency [MHz], Channel Number	Conversion Factor	TSL Conductivity [S/m]	TSL Permittivity
Flat, HSL	EDGE TOP, 0.00	WLAN 5GHz	WLAN, 10402-AAF	5690.000, 138	4.29	5.30	34.5

Hardware Setup

Phantom	TSL, Measured Date	Probe, Calibration Date	DAE, Calibration Date
ELI V5.0 (20deg probe tilt)	HBBL-600-10000, 2024-Sep-19	EX3DV4 - SN7455, 2024-03-08	DAE4ip Sn1704, 2024-03-11

Scan Setup

	Area Scan	Zoom Scan
Grid Extents [mm]	140.0 x 160.0	22.0 x 22.0 x 22.0
Grid Steps [mm]	10.0 x 10.0	4.0 x 4.0 x 1.4
Sensor Surface [mm]	3.0	1.4
Graded Grid	N/A	Yes
Grading Ratio	N/A	1.4
MAIA	Confirmed by MAIA	Confirmed by MAIA
Surface Detection	VMS + 6p	VMS + 6p
Scan Method	Measured	Measured

Measurement Results

	Area Scan	Zoom Scan
Date	2024-09-19, 19:16	2024-09-19, 19:25
psSAR1g [W/kg]	0.353	0.362
psSAR10g [W/kg]	0.114	0.104
Power Drift [dB]	-0.08	0.03
Power Scaling	Disabled	Disabled
Scaling Factor [dB]		
TSL Correction	Positive Only	Positive Only
M2/M1 [%]		60.2
Dist 3dB Peak [mm]		5.7

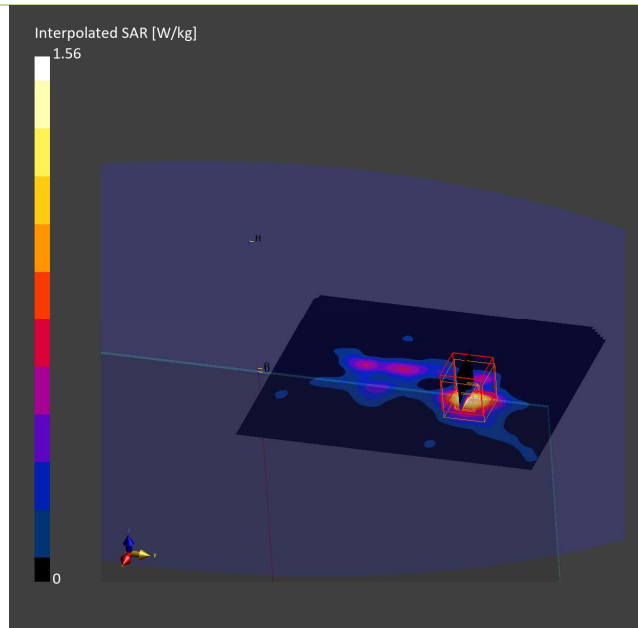

5. U-NII-4 - 802.11ac160, CH163, Aux Vendor 1– Top Edge (SAR)

Device under Test Properties

Model, Manufacturer	Dimensions [mm]	SN	DUT Type
HSN-I61C	310.0 x 215.0 x 15.0	0004770B49	Convertible PC

Exposure Conditions

Phantom Section, TSL	Position, Test Distance [mm]	Band	Group, UID	Frequency [MHz], Channel Number	Conversion Factor	TSL Conductivity [S/m]	TSL Permittivity
Flat, HSL	EDGE TOP, 0.00	Custom Band	CW, 10554-AAE	5815.000, 5815000	4.46	5.41	34.3

Hardware Setup

Phantom	TSL, Measured Date	Probe, Calibration Date	DAE, Calibration Date
ELI V5.0 (20deg probe tilt) -	HBBL-600-10000 , 2024-Sep-19	EX3DV4 - SN7455, 2024-03-08	DAE4ip Sn1704, 2024-03-11

Scan Setup

	Area Scan	Zoom Scan
Grid Extents [mm]	100.0 x 120.0	22.0 x 22.0 x 22.0
Grid Steps [mm]	10.0 x 10.0	4.0 x 4.0 x 1.4
Sensor Surface [mm]	3.0	1.4
Graded Grid	N/A	Yes
Grading Ratio	N/A	1.4
MAIA	Confirmed by MAIA	Confirmed by MAIA
Surface Detection	VMS + 6p	VMS + 6p
Scan Method	Measured	Measured

Measurement Results

	Area Scan	Zoom Scan
Date	2024-09-19, 12:31	2024-09-19, 12:39
psSAR1g [W/kg]	0.292	0.308
psSAR10g [W/kg]	0.108	0.134
Power Drift [dB]	0.01	-0.04
Power Scaling	Disabled	Disabled
Scaling Factor [dB]		
TSL Correction	Positive Only	Positive Only
M2/M1 [%]		63.8
Dist 3dB Peak [mm]		4.8

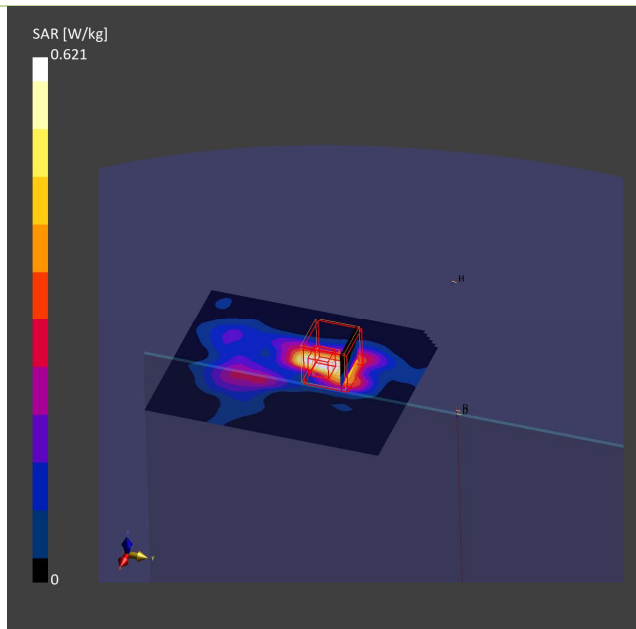

6. U-NII-5 - 802.11be320, CH63, Main Vendor 1 – Top edge (SAR)

Device under Test Properties

Model, Manufacturer	Dimensions [mm]	SN	DUT Type
HSN-I61C	310.0 x 215.0 x 15.0	0004770B49	Convertible PC

Exposure Conditions

Phantom Section, TSL	Position, Test Distance [mm]	Band	Group, UID	Frequency [MHz], Channel Number	Conversion Factor	TSL Conductivity [S/m]	TSL Permittivity
Flat, HSL	EDGE TOP, 0.00	U-NII-5	WLAN, 11026-AAB	6265.000, 63	5.06	5.94	33.4

Hardware Setup

Phantom	TSL, Measured Date	Probe, Calibration Date	DAE, Calibration Date
ELI V5.0 (20deg probe tilt) - xxxx	HBBL-600-10000 , 2024-Sep-16	EX3DV4 - SN7455, 2024-03-08	DAE4ip Sn1704, 2024-03-11

Scan Setup

	Area Scan	Zoom Scan
Grid Extents [mm]	160.0 x 160.0	22.0 x 22.0 x 22.0
Grid Steps [mm]	10.0 x 10.0	3.4 x 3.4 x 1.4
Sensor Surface [mm]	3.0	1.4
Graded Grid	N/A	Yes
Grading Ratio	N/A	1.4
MAIA	Confirmed by MAIA	Confirmed by MAIA
Surface Detection	VMS + 6p	VMS + 6p
Scan Method	Measured	Measured

Measurement Results

	Area Scan	Zoom Scan
Date	2024-09-18, 21:35	2024-09-18, 21:45
psSAR1g [W/kg]	0.481	0.557
psSAR10g [W/kg]	0.145	0.152
Power Drift [dB]	-0.02	-0.04
Power Scaling	Disabled	Disabled
Scaling Factor		
TSL Correction	Positive Only	Positive Only
M2/M1 [%]		51.8
Dist 3dB Peak [mm]		5.5

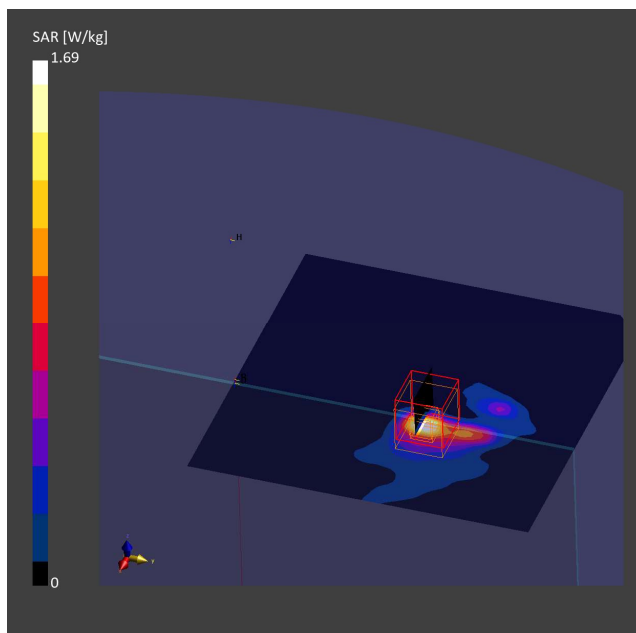

7. U-NII-6 - 802.11ax/be160, CH111, Main Vendor 1 – Top edge (SAR)

Device under Test Properties

Model, Manufacturer	Dimensions [mm]	SN	DUT Type
HSN-I61C	310.0 x 215.0 x 15.0	0004770B49	Convertible PC

Exposure Conditions

Phantom Section, TSL	Position, Test Distance [mm]	Band	Group, UID	Frequency [MHz], Channel Number	Conversion Factor	TSL Conductivity [S/m]	TSL Permittivity
Flat, HSL	EDGE TOP, 0.00	U-NII-6	WLAN, 10755-AAC	6505.000, 111	5.06	6.28	32.9

Hardware Setup

Phantom	TSL, Measured Date	Probe, Calibration Date	DAE, Calibration Date
ELI V5.0 (20deg probe tilt) - xxxx	HBBL-600-10000, 2024-Sep-16	EX3DV4 - SN7455, 2024-03-08	DAE4ip Sn1704, 2024-03-11

Scan Setup

	Area Scan	Zoom Scan
Grid Extents [mm]	160.0 x 160.0	22.0 x 22.0 x 22.0
Grid Steps [mm]	10.0 x 10.0	3.4 x 3.4 x 1.4
Sensor Surface [mm]	3.0	1.4
Graded Grid	N/A	Yes
Grading Ratio	N/A	1.4
MAIA	Confirmed by MAIA	Confirmed by MAIA
Surface Detection	VMS + 6p	VMS + 6p
Scan Method	Measured	Measured

Measurement Results

	Area Scan	Zoom Scan
Date	2024-09-18, 22:20	2024-09-18, 22:30
psSAR1g [W/kg]	0.269	0.304
psSAR10g [W/kg]	0.082	0.081
Power Drift [dB]	-0.01	0.07
Power Scaling	Disabled	Disabled
Scaling Factor		
TSL Correction	Positive Only	Positive Only
M2/M1 [%]		50.5
Dist 3dB Peak [mm]		5.5

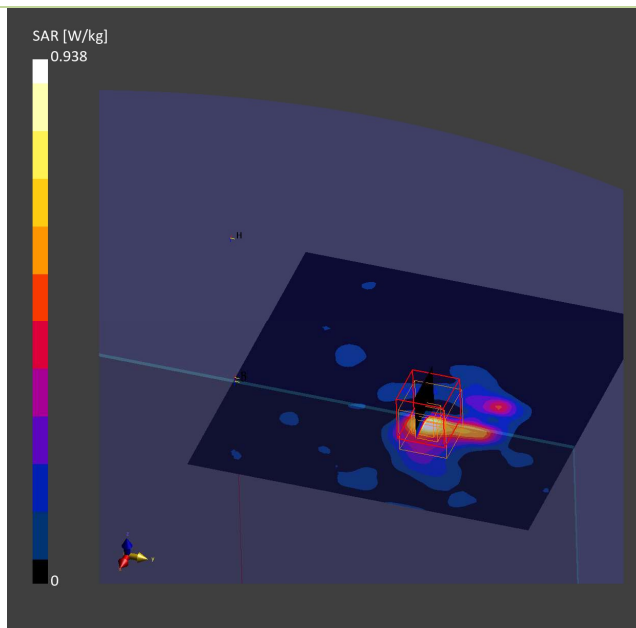

8. U-NII-7 - 802.11be320, CH127 Main Vendor 1 – Top edge (SAR)

Device under Test Properties

Model, Manufacturer	Dimensions [mm]	SN	DUT Type
HSN-I61C	310.0 x 215.0 x 15.0	0004770B49	Convertible PC

Exposure Conditions

Phantom Section, TSL	Position, Test Distance [mm]	Band	Group, UID	Frequency [MHz], Channel Number	Conversion Factor	TSL Conductivity [S/m]	TSL Permittivity
Flat, HSL	EDGE TOP, 0.00	U-NII-7	WLAN, 11026-AAB	6585.000, 127	5.06	6.38	32.7

Hardware Setup

Phantom	TSL, Measured Date	Probe, Calibration Date	DAE, Calibration Date
ELI V5.0 (20deg probe tilt) -	HBBL-600-10000, 2024-Sep-16	EX3DV4 - SN7455, 2024-03-08	DAE4ip Sn1704, 2024-03-11

Scan Setup

	Area Scan	Zoom Scan
Grid Extents [mm]	160.0 x 160.0	22.0 x 22.0 x 22.0
Grid Steps [mm]	10.0 x 10.0	3.4 x 3.4 x 1.4
Sensor Surface [mm]	3.0	1.4
Graded Grid	N/A	Yes
Grading Ratio	N/A	1.4
MAIA	Confirmed by MAIA	Confirmed by MAIA
Surface Detection	VMS + 6p	VMS + 6p
Scan Method	Measured	Measured

Measurement Results

	Area Scan	Zoom Scan
Date	2024-09-19, 08:37	2024-09-19, 08:47
psSAR1g [W/kg]	0.381	0.429
psSAR10g [W/kg]	0.121	0.118
Power Drift [dB]	0.02	0.03
Power Scaling	Disabled	Disabled
Scaling Factor [dB]		
TSL Correction	Positive Only	Positive Only
M2/M1 [%]		50.9
Dist 3dB Peak [mm]		5.5

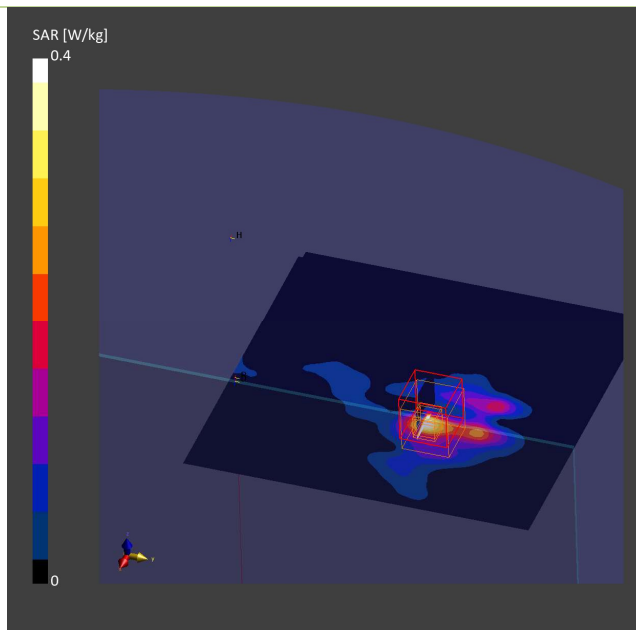

9. U-NII-8 - 802.11ax/be 160, CH207, Main Vendor 2– Top edge (SAR)

Device under Test Properties

Model, Manufacturer	Dimensions [mm]	SN	DUT Type
HSN-I61C	310.0 x 215.0 x 15.0	0004770B52	Convertible PC

Exposure Conditions

Phantom Section, TSL	Position, Test Distance [mm]	Band	Group, UID	Frequency [MHz], Channel Number	Conversion Factor	TSL Conductivity [S/m]	TSL Permittivity
Flat, HSL	EDGE TOP, 0.00	U-NII-8	WLAN, 10755-AAC	6985.000, 207	5.06	6.85	32.0

Hardware Setup

Phantom	TSL, Measured Date	Probe, Calibration Date	DAE, Calibration Date
ELI V5.0 (20deg probe tilt) -	HBBL-600-10000, 2024-Sep-19	EX3DV4 - SN7455, 2024-03-08	DAE4ip Sn1704, 2024-03-11

Scan Setup

	Area Scan	Zoom Scan
Grid Extents [mm]	140.0 x 160.0	22.0 x 22.0 x 22.0
Grid Steps [mm]	10.0 x 10.0	2.9 x 2.9 x 1.2
Sensor Surface [mm]	3.0	1.4
Graded Grid	N/A	Yes
Grading Ratio	N/A	1.2
MAIA	Confirmed by MAIA	Confirmed by MAIA
Surface Detection	VMS + 6p	VMS + 6p
Scan Method	Measured	Measured

Measurement Results

	Area Scan	Zoom Scan
Date	2024-09-19, 23:28	2024-09-19, 23:43
psSAR1g [W/kg]	0.236	0.305
psSAR10g [W/kg]	0.067	0.072
Power Drift [dB]	0.08	0.07
Power Scaling	Disabled	Disabled
Scaling Factor [dB]		
TSL Correction	Positive Only	Positive Only
M2/M1 [%]		51.7
Dist 3dB Peak [mm]		5.2

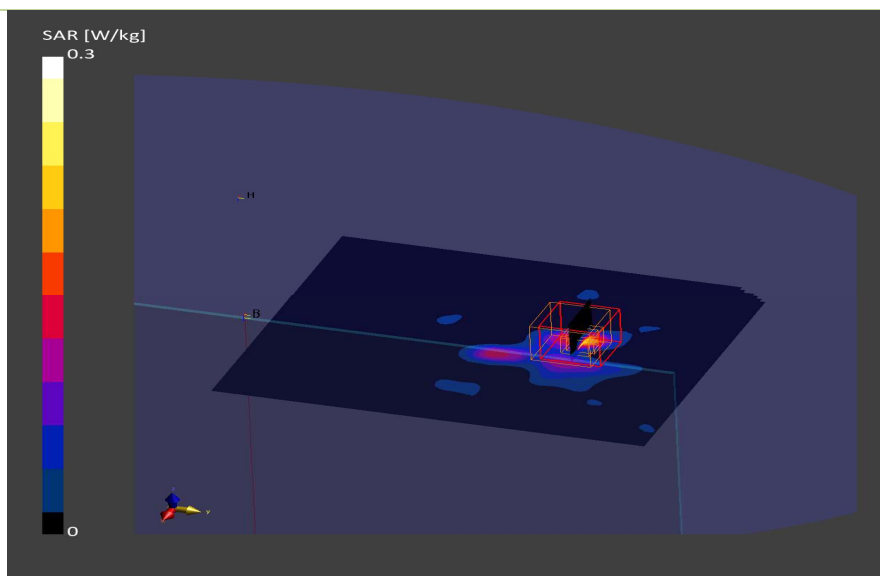

10. System Check 2450MHz

Device under Test Properties

Model, Manufacturer	Dimensions [mm]	SN	DUT Type
D2450GHZV2 , SPEAG	50.0 x 10.0 x 15.0	937	Validation Dipole

Exposure Conditions

Phantom Section, TSL	Position, Test Distance [mm]	Band	Group, UID	Frequency [MHz], Channel Number	Conversion Factor	TSL Conductivity [S/m]	TSL Permittivity
Flat, HSL	,		CW, 0--	2450.000, 0	6.88	1.90	40.7

Hardware Setup

Phantom	TSL, Measured Date	Probe, Calibration Date	DAE, Calibration Date
ELI V5.0 (20deg probe tilt) -	HBBL-600-10000, 2024-Sep-19	EX3DV4 - SN7455, 2024-03-08	DAE4ip Sn1704, 2024-03-11

Scan Setup

	Area Scan	Zoom Scan
Grid Extents [mm]	40.0 x 80.0	30.0 x 30.0 x 30.0
Grid Steps [mm]	10.0 x 10.0	5.0 x 5.0 x 1.5
Sensor Surface [mm]	3.0	1.4
Graded Grid	N/A	Yes
Grading Ratio	N/A	1.5
MAIA	Confirmed by MAIA	Confirmed by MAIA
Surface Detection	VMS + 6p	VMS + 6p
Scan Method	Measured	Measured

Measurement Results

	Area Scan	Zoom Scan
Date	2024-09-19, 10:59	2024-09-19, 11:05
psSAR1g [W/kg]	2.69	2.65
psSAR10g [W/kg]	1.25	1.24
Power Drift [dB]	-0.02	0.00
Power Scaling	Disabled	Disabled
Scaling Factor		
TSL Correction [dB]	Positive Only	Positive Only
M2/M1 [%]		80.2
Dist 3dB Peak [mm]		9.0

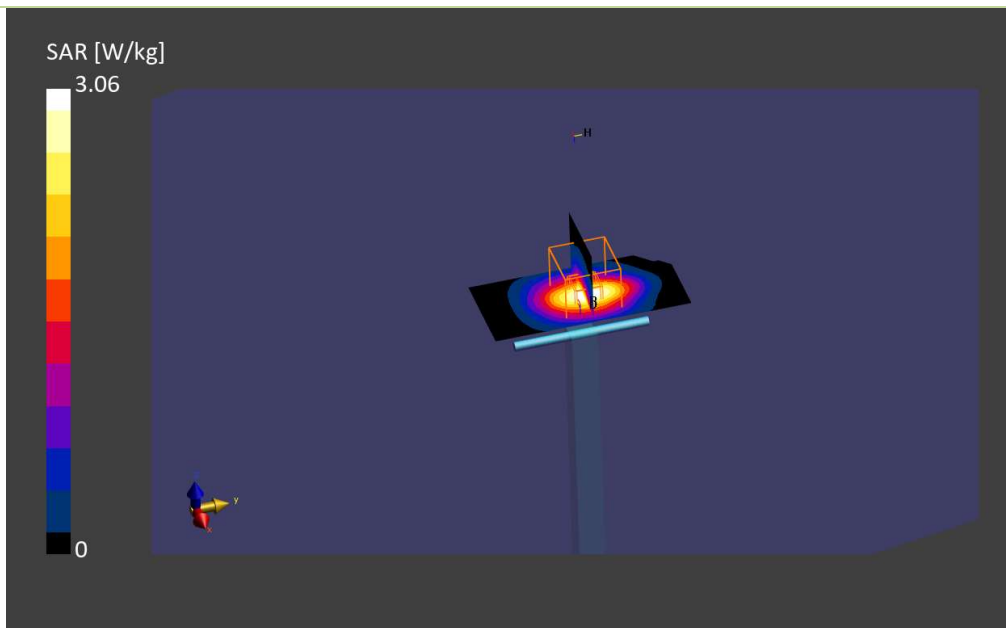

11. System Check 5300MHz

Device under Test Properties

Model, Manufacturer	Dimensions [mm]	SN	DUT Type
D5GHzV2 , SPEAG	50.0 x 10.0 x 15.0	1259	Validation Dipole

Exposure Conditions

Phantom Section, TSL	Position, Test Distance [mm]	Band	Group, UID	Frequency [MHz], Channel Number	Conversion Factor	TSL Conductivity [S/m]	TSL Permittivity
Flat, HSL			CW, 0--	5300.000, 0	5.01	4.85	35.3

Hardware Setup

Phantom	TSL, Measured Date	Probe, Calibration Date	DAE, Calibration Date
ELI V5.0 (20deg probe tilt) -	HBBL-600-10000, 2024-Sep-19	EX3DV4 - SN7455, 2024-03-08	DAE4ip Sn1704, 2024-03-11

Scan Setup

	Area Scan	Zoom Scan
Grid Extents [mm]	40.0 x 80.0	22.0 x 22.0 x 22.0
Grid Steps [mm]	10.0 x 10.0	4.0 x 4.0 x 1.4
Sensor Surface [mm]	3.0	1.4
Graded Grid	N/A	Yes
Grading Ratio	N/A	1.4
MAIA	Confirmed by MAIA	Confirmed by MAIA
Surface Detection	VMS + 6p	VMS + 6p
Scan Method	Measured	Measured

Measurement Results

	Area Scan	Zoom Scan
Date	2024-09-19, 10:00	2024-09-19, 10:06
psSAR1g [W/kg]	3.76	3.97
psSAR10g [W/kg]	1.12	1.13
Power Drift [dB]	-0.17	-0.01
Power Scaling	Disabled	Disabled
Scaling Factor [dB]		
TSL Correction	Positive Only	Positive Only
M2/M1 [%]		64.6
Dist 3dB Peak [mm]		7.6

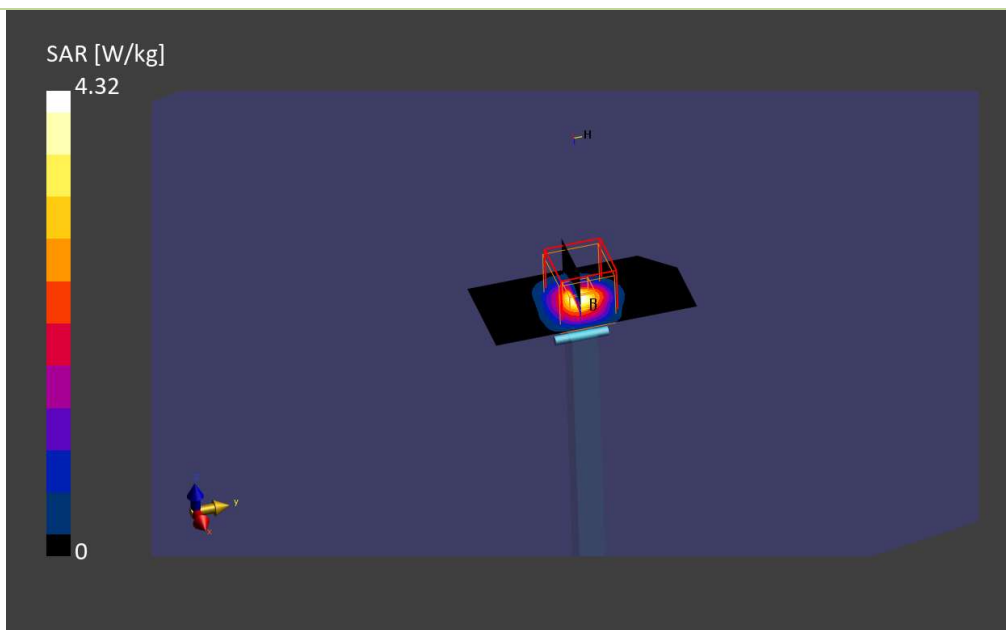

12. System Check 5500MHz

Device under Test Properties

Model, Manufacturer	Dimensions [mm]	SN	DUT Type
D5GHzV2 , SPEAG	50.0 x 10.0 x 15.0	1259	Validation Dipole

Exposure Conditions

Phantom Section, TSL	Position, Test Distance [mm]	Band	Group, UID	Frequency [MHz], Channel Number	Conversion Factor	TSL Conductivity [S/m]	TSL Permittivity
Flat, HSL			CW, 0--	5500.000, 0	4.44	5.10	34.9

Hardware Setup

Phantom	TSL, Measured Date	Probe, Calibration Date	DAE, Calibration Date
ELI V5.0 (20deg probe tilt) -	HBBL-600-10000,2024-Sep-19	EX3DV4 - SN7455, 2024-03-08	DAE4ip Sn1704, 2024-03-11

Scan Setup

	Area Scan	Zoom Scan
Grid Extents [mm]	40.0 x 80.0	22.0 x 22.0 x 22.0
Grid Steps [mm]	10.0 x 10.0	4.0 x 4.0 x 1.4
Sensor Surface [mm]	3.0	1.4
Graded Grid	N/A	Yes
Grading Ratio	N/A	1.4
MAIA	Confirmed by MAIA	Confirmed by MAIA
Surface Detection	VMS + 6p	VMS + 6p
Scan Method	Measured	Measured

Measurement Results

	Area Scan	Zoom Scan
Date	2024-09-19, 10:09	2024-09-19, 10:16
psSAR1g [W/kg]	3.95	4.30
psSAR10g [W/kg]	1.17	1.23
Power Drift [dB]	-0.04	0.10
Power Scaling	Disabled	Disabled
Scaling Factor [dB]		
TSL Correction	Positive Only	Positive Only
M2/M1 [%]		63.2
Dist 3dB Peak [mm]		7.6

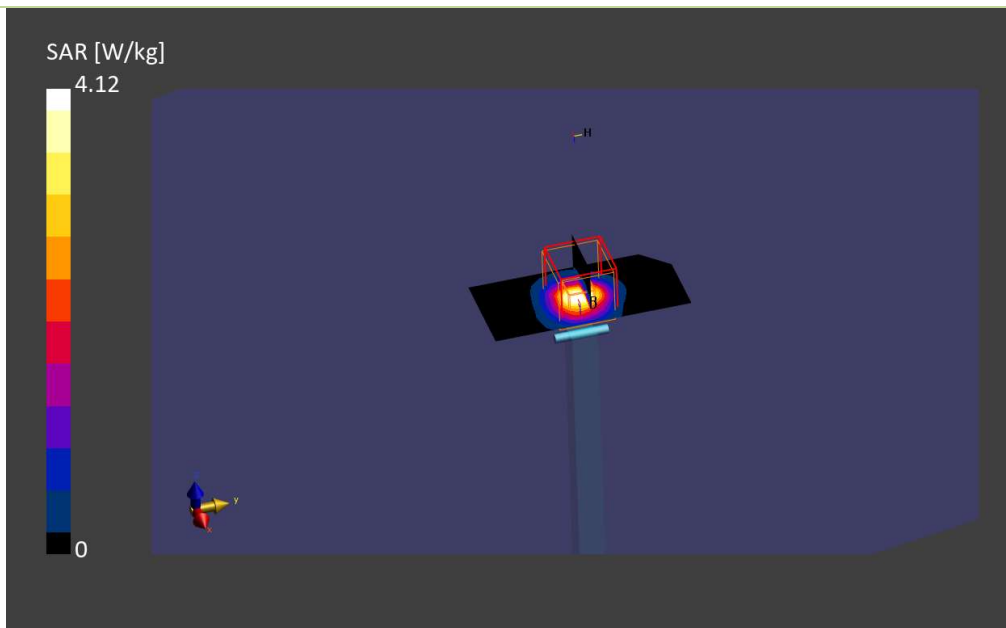

13. System Check 5600MHz

Device under Test Properties

Model, Manufacturer	Dimensions [mm]	SN	DUT Type
D5GHzV2 , SPEAG	50.0 x 10.0 x 15.0	1259	Validation Dipole

Exposure Conditions

Phantom Section, TSL	Position, Test Distance [mm]	Band	Group, UID	Frequency [MHz], Channel Number	Conversion Factor	TSL Conductivity [S/m]	TSL Permittivity
Flat, HSL	,		CW, 0--	5600.000, 0	4.29	5.21	34.7

Hardware Setup

Phantom	TSL, Measured Date	Probe, Calibration Date	DAE, Calibration Date
ELI V5.0 (20deg probe tilt) -	HBBL-600-10000, 2024-Sep-19	EX3DV4 - SN7455, 2024-03-08	DAE4ip Sn1704, 2024-03-11

Scan Setup

	Area Scan	Zoom Scan
Grid Extents [mm]	40.0 x 80.0	22.0 x 22.0 x 22.0
Grid Steps [mm]	10.0 x 10.0	4.0 x 4.0 x 1.4
Sensor Surface [mm]	3.0	1.4
Graded Grid	N/A	Yes
Grading Ratio	N/A	1.4
MAIA	Confirmed by MAIA	Confirmed by MAIA
Surface Detection	VMS + 6p	VMS + 6p
Scan Method	Measured	Measured

Measurement Results

	Area Scan	Zoom Scan
Date	2024-09-19, 10:19	2024-09-19, 10:26
psSAR1g [W/kg]	4.09	4.47
psSAR10g [W/kg]	1.20	1.27
Power Drift [dB]	0.02	0.05
Power Scaling	Disabled	Disabled
Scaling Factor [dB]		
TSL Correction	Positive Only	Positive Only
M2/M1 [%]		62.1
Dist 3dB Peak [mm]		7.6

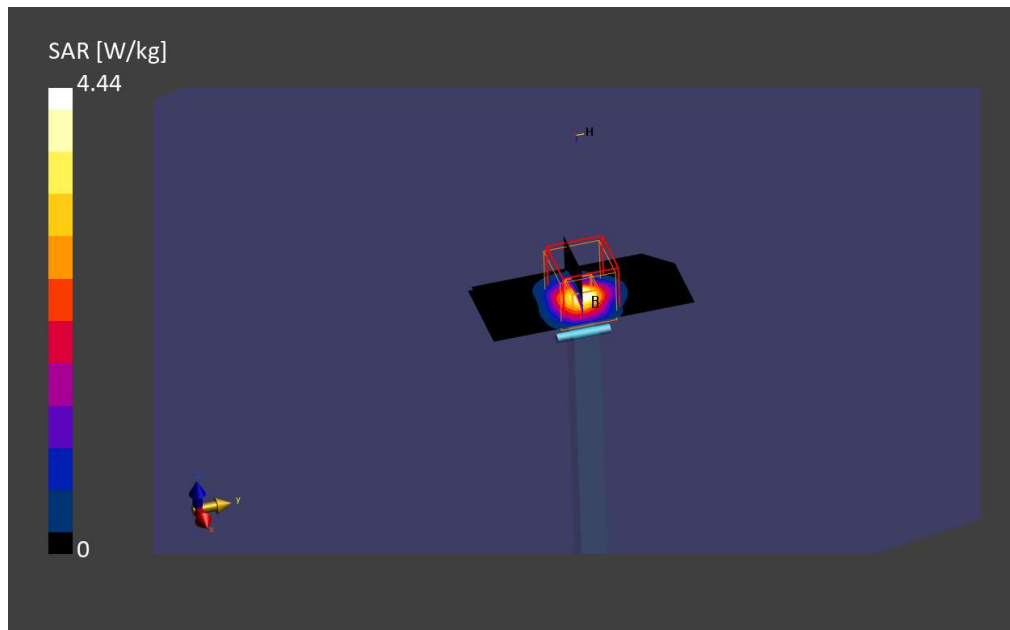

14. System Check 5800MHz

Device under Test Properties

Model, Manufacturer	Dimensions [mm]	SN	DUT Type
D5GHzV2 , SPEAG	50.0 x 10.0 x 15.0	1259	Validation Dipole

Exposure Conditions

Phantom Section, TSL	Position, Test Distance [mm]	Band	Group, UID	Frequency [MHz], Channel Number	Conversion Factor	TSL Conductivity [S/m]	TSL Permittivity
Flat, HSL	,		CW, 0--	5800.000, 0	4.46	5.40	34.3

Hardware Setup

Phantom	TSL, Measured Date	Probe, Calibration Date	DAE, Calibration Date
ELI V5.0 (20deg probe tilt) -	HBBL-600-1000, 2024-Sep-19	EX3DV4 - SN7455, 2024-03-08	DAE4ip Sn1704, 2024-03-11

Scan Setup

	Area Scan	Zoom Scan
Grid Extents [mm]	40.0 x 80.0	22.0 x 22.0 x 22.0
Grid Steps [mm]	10.0 x 10.0	4.0 x 4.0 x 1.4
Sensor Surface [mm]	3.0	1.4
Graded Grid	N/A	Yes
Grading Ratio	N/A	1.4
MAIA	Confirmed by MAIA	Confirmed by MAIA
Surface Detection	VMS + 6p	VMS + 6p
Scan Method	Measured	Measured

Measurement Results

	Area Scan	Zoom Scan
Date	2024-09-19, 10:29	2024-09-19, 10:35
psSAR1g [W/kg]	3.91	4.12
psSAR10g [W/kg]	1.16	1.17
Power Drift [dB]	-0.18	-0.04
Power Scaling	Disabled	Disabled
Scaling Factor		
TSL Correction	Positive Only	Positive Only
M2/M1 [%]		59.4
Dist 3dB Peak [mm]		7.9

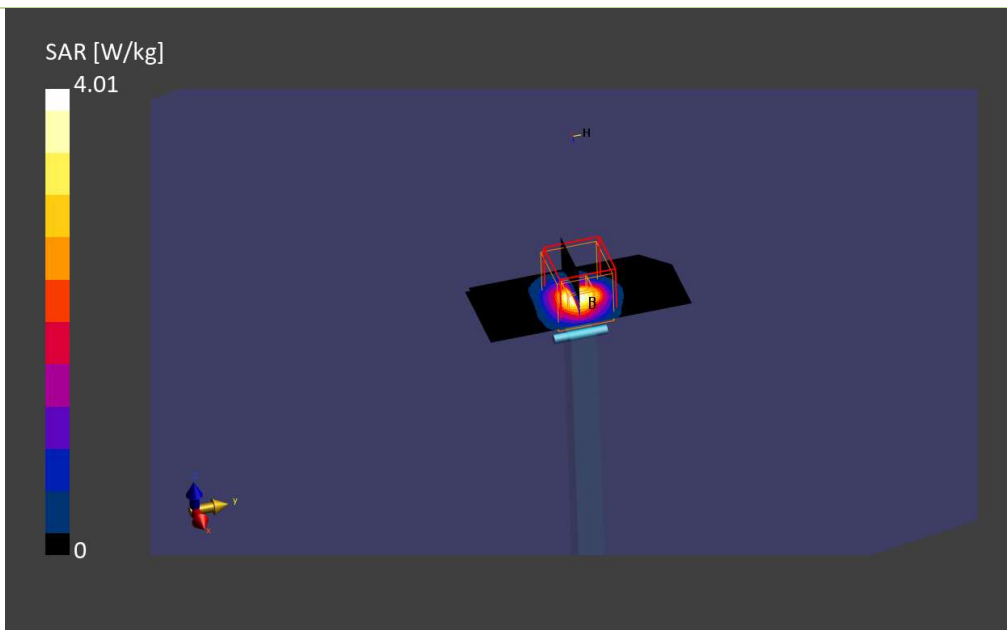

15. System Check 7000MHz-2024-09-19

Device under Test Properties

Model, Manufacturer	Dimensions [mm]	SN	DUT Type
D7.0GHzV2, Speag	50.0 x 10.0 x 8.0	1008	Validation Dipole

Exposure Conditions

Phantom Section, TSL	Position, Test Distance [mm]	Band	Group, UID	Frequency [MHz], Channel Number	Conversion Factor	TSL Conductivity [S/m]	TSL Permittivity
Flat, HSL	,		CW, 0--	7000.000, 0	5.06	6.87	32.0

Hardware Setup

Phantom	TSL, Measured Date	Probe, Calibration Date	DAE, Calibration Date
ELI V5.0 (20deg probe tilt) -	HBBL-600-10000, 2024-Sep-19	EX3DV4 - SN7455, 2024-03-08	DAE4ip Sn1704, 2024-03-11

Scan Setup

	Area Scan	Zoom Scan
Grid Extents [mm]	45.0 x 90.0	22.0 x 22.0 x 22.0
Grid Steps [mm]	7.5 x 7.5	3.0 x 3.0 x 1.4
Sensor Surface [mm]	3.0	1.4
Graded Grid	N/A	Yes
Grading Ratio	N/A	1.4
MAIA	Confirmed by MAIA	Confirmed by MAIA
Surface Detection	VMS + 6p	VMS + 6p
Scan Method	Measured	Measured

Measurement Results

	Area Scan	Zoom Scan
Date	2024-09-19, 09:23	2024-09-19, 09:33
psSAR1g [W/kg]	3.97	4.33
psSAR10g [W/kg]	0.755	0.771
Power Drift [dB]	0.09	0.03
Power Scaling	Disabled	Disabled
Scaling Factor [dB]		
TSL Correction	Positive Only	Positive Only
M2/M1 [%]		46.4
Dist 3dB Peak [mm]		4.6

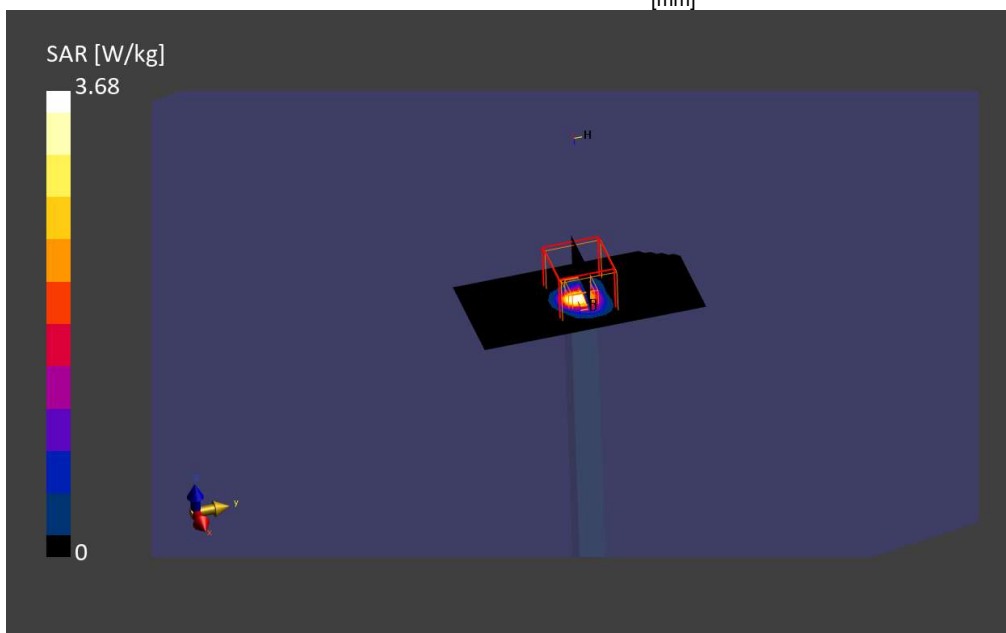

16. System Check 7000MHz-2024-09-18

Device under Test Properties

Model, Manufacturer	Dimensions [mm]	SN	DUT Type
D7.0GHzV2, Speag	50.0 x 10.0 x 8.0	1008	Validation Dipole

Exposure Conditions

Phantom Section, TSL	Position, Test Distance [mm]	Band	Group, UID	Frequency [MHz], Channel Number	Conversion Factor	TSL Conductivity [S/m]	TSL Permittivity
Flat, HSL	,		CW, 0--	7000.000, 0	5.06	6.82	32.1

Hardware Setup

Phantom	TSL, Measured Date	Probe, Calibration Date	DAE, Calibration Date
ELI V5.0 (20deg probe tilt) -	HBBL-600-10000, 2024-Sep-16	EX3DV4 - SN7455, 2024-03-08	DAE4ip Sn1704, 2024-03-11

Scan Setup

	Area Scan	Zoom Scan
Grid Extents [mm]	45.0 x 90.0	22.0 x 22.0 x 22.0
Grid Steps [mm]	7.5 x 7.5	3.0 x 3.0 x 1.4
Sensor Surface [mm]	3.0	1.4
Graded Grid	N/A	Yes
Grading Ratio	N/A	1.4
MAIA	Confirmed by MAIA	Confirmed by MAIA
Surface Detection	VMS + 6p	VMS + 6p
Scan Method	Measured	Measured

Measurement Results

	Area Scan	Zoom Scan
Date	2024-09-18, 18:18	2024-09-18, 18:28
psSAR1g [W/kg]	3.75	4.43
psSAR10g [W/kg]	0.774	0.788
Power Drift [dB]	0.10	0.00
Power Scaling	Disabled	Disabled
Scaling Factor [dB]		
TSL Correction	Positive Only	Positive Only
M2/M1 [%]		46.8
Dist 3dB Peak [mm]		4.8

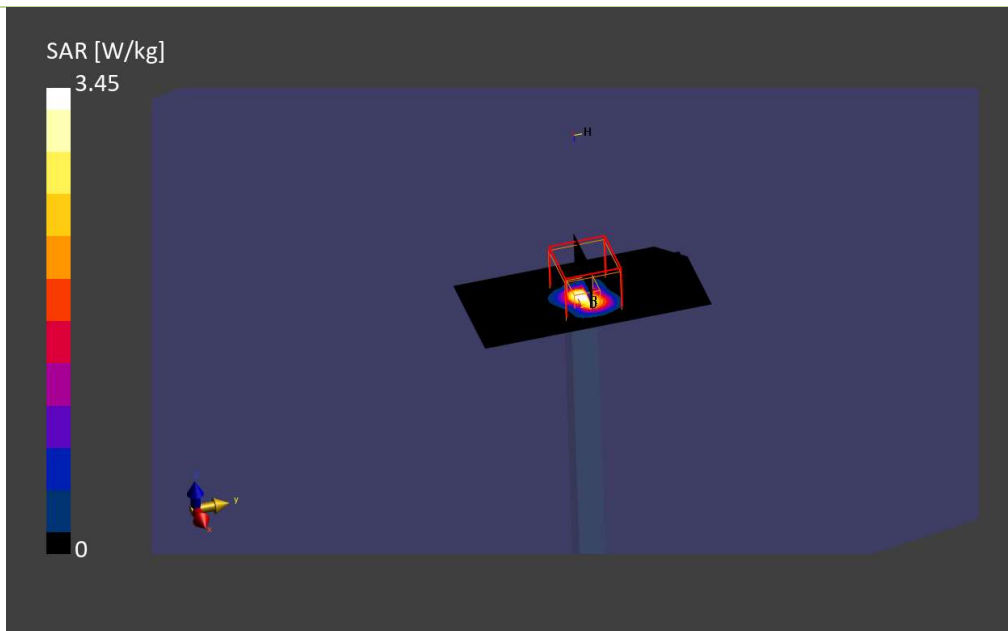

17. U-NII-5 - 802.11be320, CH63, Main Vendor 2– Position Top edge (PD)

DUT: HSN-I61C BE201NGW; Type: PIFA
Signal Source: modulation Custom Channel for 802.11be, level 15.50dBm.

Medium parameters used: $\sigma = 0$ S/m, $\epsilon_r = 1$; $\rho = 0$ kg/m³
 Phantom section: Table Section
 Measurement Standard: DASy6 (IEEE/IEC/ANSI C63.19-2011)

DASy Configuration:

- Probe: EUmmW – SN9594 ; ConvF(1, 1, 1); Calibrated: 2024-09-10;
 - Modulation Compensation:
- Sensor-Surface : 0mm (Fix Surface), z = 2mm
- Electronics: DAE4 Sn1658; Calibrated: 2024-08-08
- Phantom: Cover; Type: SPEAG Phantom Cover
- cDASy6 5G Module v2.4
- Test Date: 2024-09-25

Distance-2mm:

Measurement Resolution = $\lambda/20$ mm
 Measurement Scan area = 120 mm x 120 mm

The plots below show the average PStot (1cm²), PStot (4cm²) the E-field and the H Field

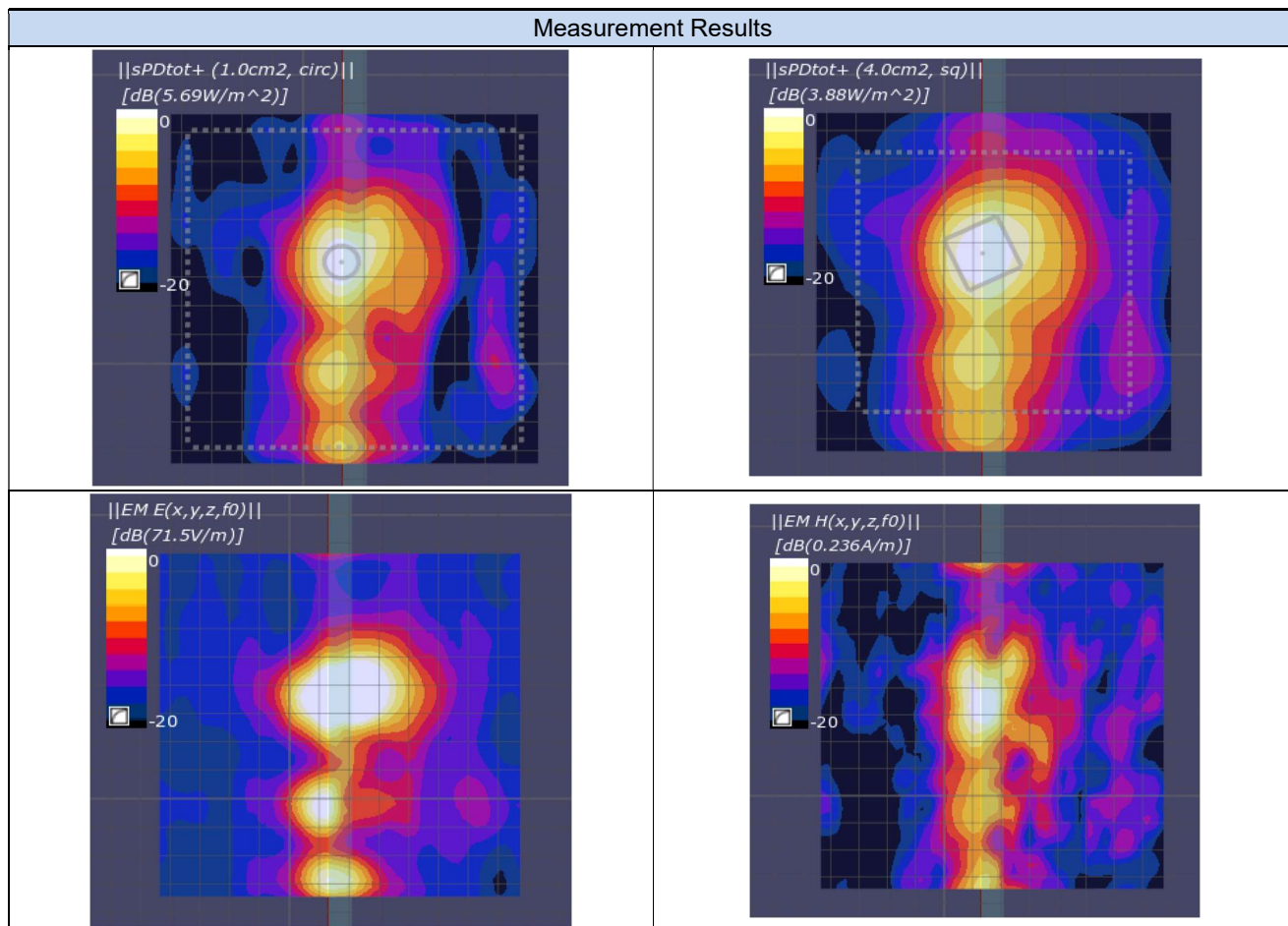

18.U-NII-6 - 802.11ax/be160, CH111, Main Vendor 1 – Position Top edge (PD)

DUT: HSN-I61C BE201NGW; Type: PIFA

Signal Source: modulation Custom Channel for 802.11ax/be, level 14.50dBm.

Medium parameters used: $\sigma = 0$ S/m, $\epsilon_r = 1$; $\rho = 0$ kg/m³

Phantom section: Table Section

Measurement Standard: DASYS6 (IEEE/IEC/ANSI C63.19-2011)

DASY Configuration:

- Probe: EUmmW – SN9538 ; ConvF(1, 1, 1); Calibrated: 2024-05-06;
 - Modulation Compensation:
- Sensor-Surface : 0mm (Fix Surface), z = 2 mm
- Electronics: DAE4 Sn1703; Calibrated: 2024-02-13
- Phantom: Cover; Type: SPEAG Phantom Cover
- cDASY6 5G Module v2.4
- Test Date: 2024-09-17

Distance-2 mm:

Measurement Resolution = $\lambda/20$ mm

Measurement Scan area = 120 mm x 120 mm

The plots below show the average PStot (1cm²), PStot (4cm²) the E-field and the H Field

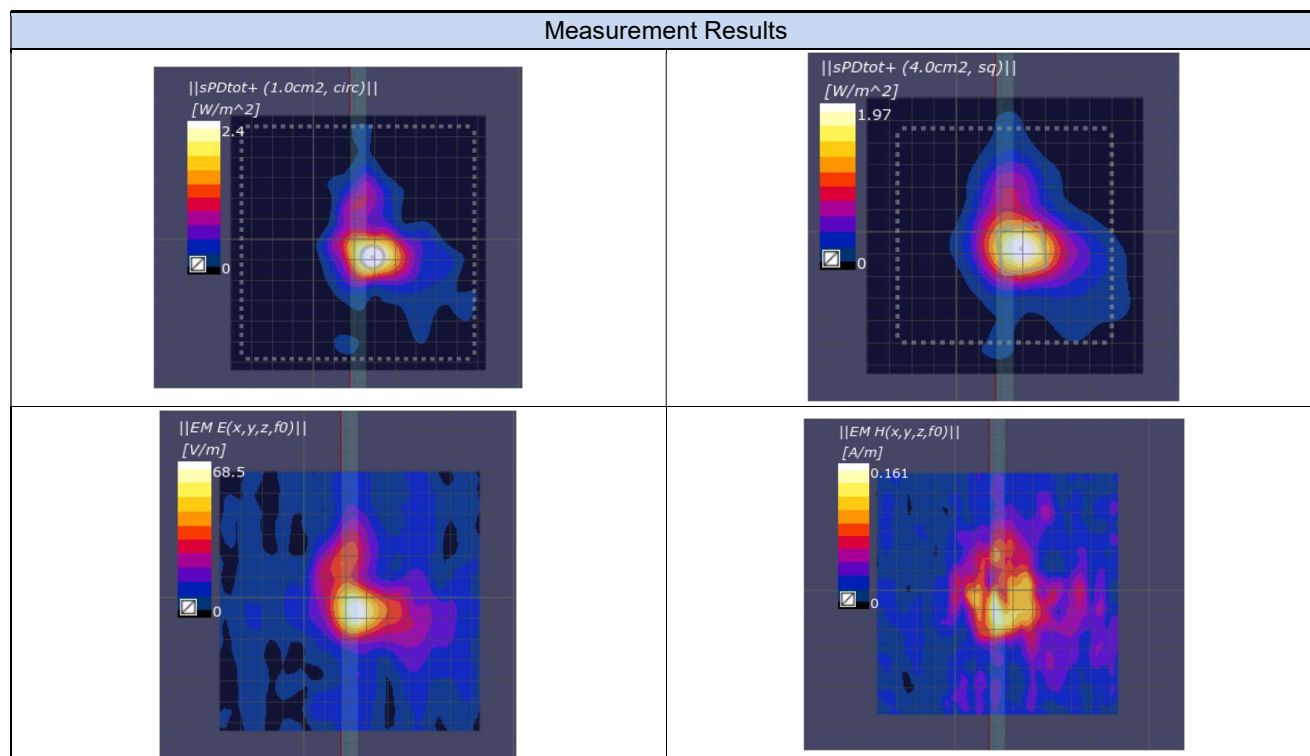

19. U-NII-7 - 802.11be320, CH127, Main Vendor 1– Position Top edge (PD)**DUT: HSN-I61C BE201NGW; Type: PIFA****Signal Source: modulation Custom Channel for 802.11be320, level 14.50dBm.**Medium parameters used: $\sigma = 0$ S/m, $\epsilon_r = 1$; $\rho = 0$ kg/m³

Phantom section: Table Section

Measurement Standard: DASy6 (IEEE/IEC/ANSI C63.19-2011)

DASy Configuration:

- Probe: EUmmW – SN9538 ; ConvF(1, 1, 1); Calibrated: 2024-05-06;
 - Modulation Compensation:
- Sensor-Surface : 0mm (Fix Surface), z = 2 mm
- Electronics: DAE4 Sn1703; Calibrated: 2024-02-13
- Phantom: Cover; Type: SPEAG Phantom Cover
- cDASy6 5G Module v2.4
- Test Date: 2024-09-26

Distance-2 mm:Measurement Resolution = $\lambda/20$ mm

Measurement Scan area = 120 mm x 120 mm

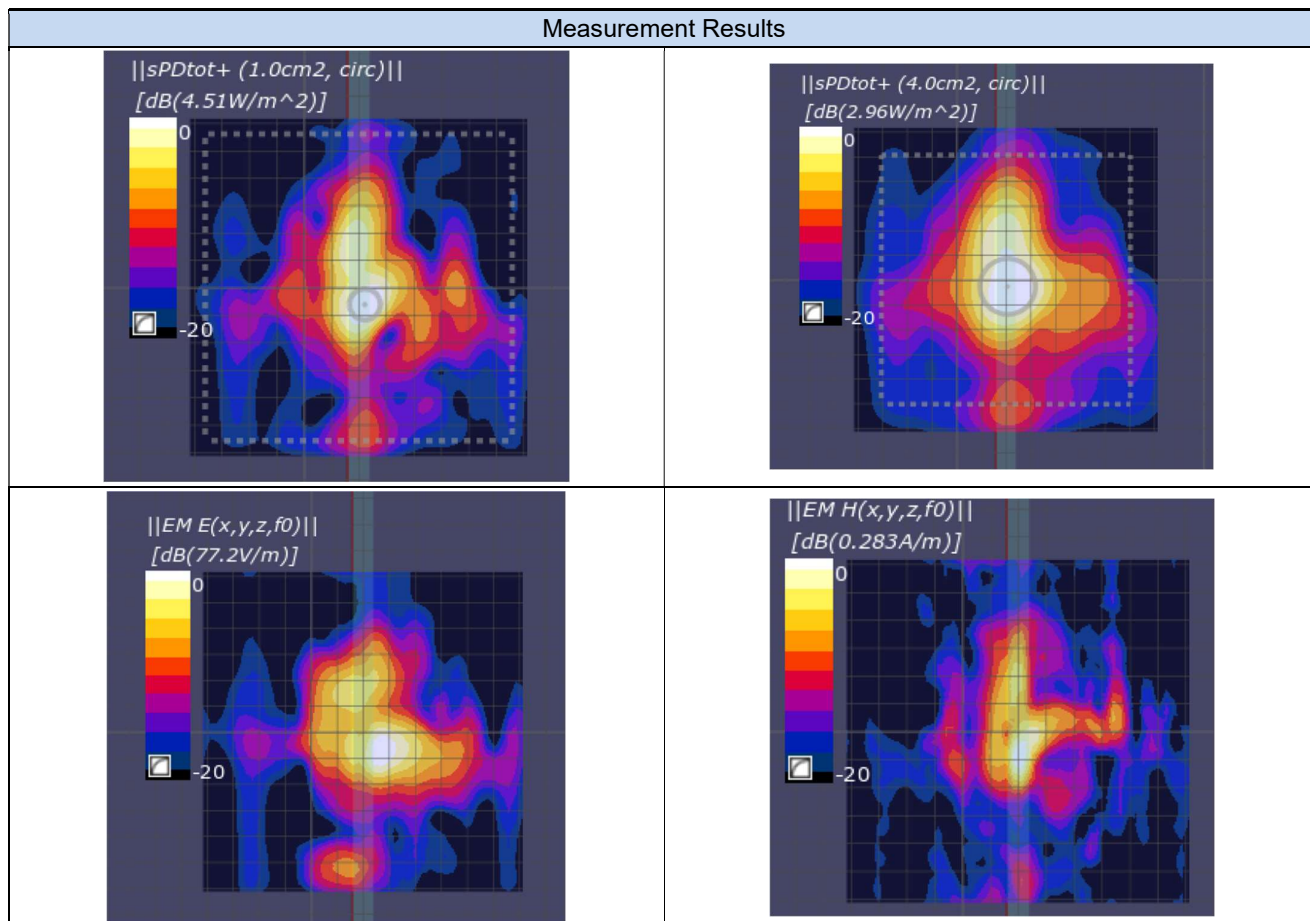
The plots below show the average PStot (1cm²), PStot (4cm²) the E-field and the H Field

20. U-NII-8 - 802.11ax/be160, CH207, Main Vendor 2- Position Top edge (PD)**DUT: HSN-I61C BE201NGW; Type: PIFA****Signal Source: modulation Custom Channel for 802.11ax/be160, level 14.50dBm.**Medium parameters used: $\sigma = 0$ S/m, $\epsilon_r = 1$; $\rho = 0$ kg/m³

Phantom section: Table Section

Measurement Standard: DASy6 (IEEE/IEC/ANSI C63.19-2011)

DASy Configuration:

- Probe: EUmmW – SN9594 ; ConvF(1, 1, 1); Calibrated: 2024-09-10;
 - Modulation Compensation:
- Sensor-Surface : 0mm (Fix Surface), z = 2 mm
- Electronics: DAE4 Sn1658; Calibrated: 2025-08-08
- Phantom: Cover; Type: SPEAG Phantom Cover
- cDASy6 5G Module v2.4
- Test Date: 2024-09-27

Distance-2 mm:Measurement Resolution = $\lambda/20$ mm

Measurement Scan area = 120 mm x 120 mm

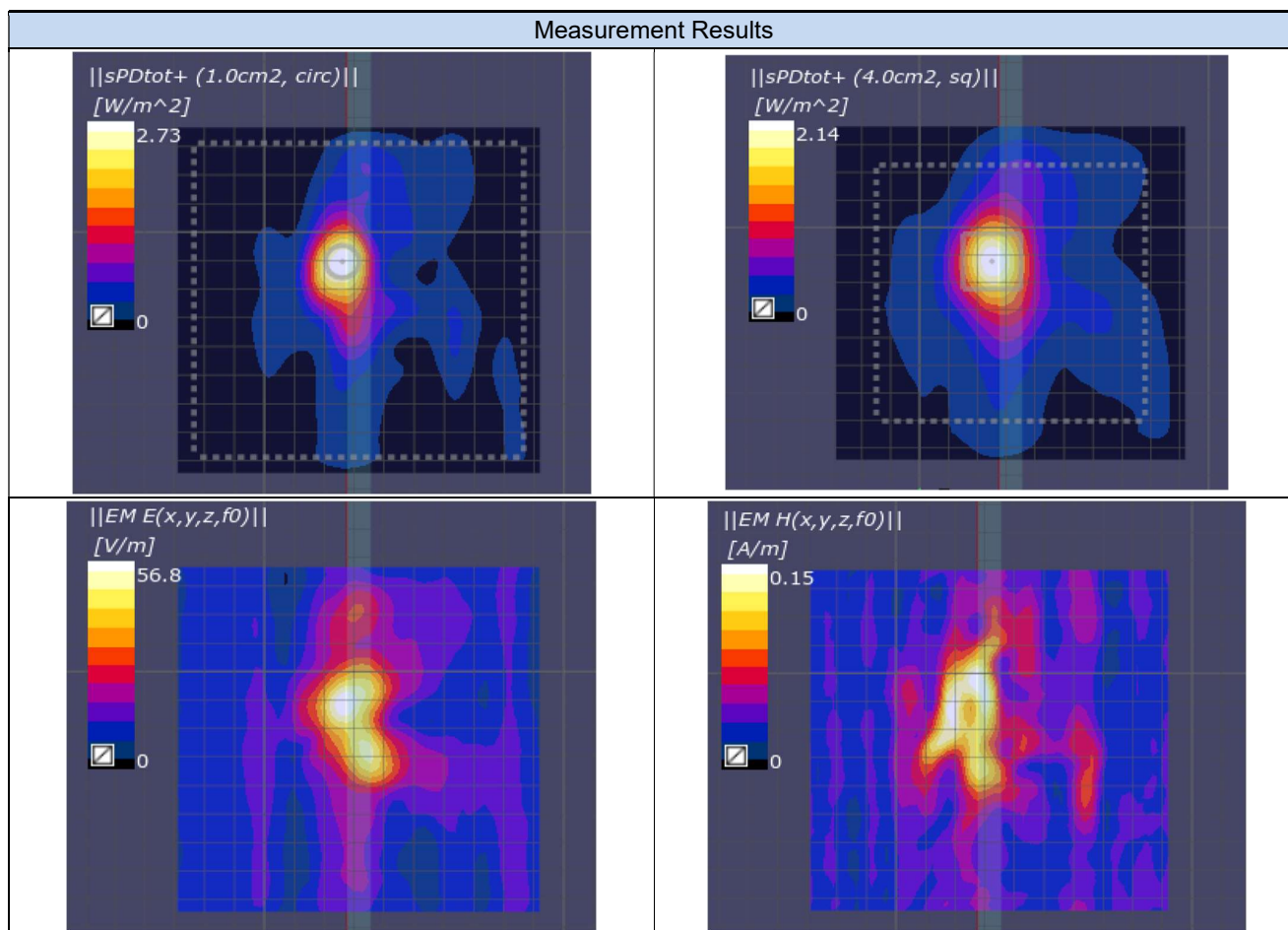
The plots below show the average PStot (1cm²), PStot (4cm²) the E-field and the H Field

21. Power Density System Check From 6500MHz-2024-09-25

DUT: Horn reference source; Type: PE9859/SF-15;

Signal Source: modulation CW, level 10 dBm.

Medium parameters used: $\sigma = 0$ S/m, $\epsilon_r = 1$; $\rho = 0$ kg/m³

Phantom section: Table Section

Measurement Standard: DASYS6 (IEEE/IEC/ANSI C63.19-2011)

DASY Configuration:

- Probe: EUmmW – SN 9594 ; ConvF(1, 1, 1); Calibrated: 2024-09-10
 - Modulation Compensation:
- Sensor-Surface : 0mm (Fix Surface), z = 10 mm
- Electronics: DAE4 Sn1658; Calibrated: 2024-08-08
- Phantom: Cover; Type: SPEAG Phantom Cover
- cDASY6 5G Module v2.4
- Test Date: 2024-09-25

Distance-10mm/Measure Horn reference source (86.9x63.5):

Measurement Resolution = $\lambda/4$ mm

Measurement Scan area = 200 mm x 200 mm

The plots below show the comparison between the Numerical Modeling results and the system check measurement results in terms of E-field, H Field, single point power density and Avg Power density 1cm².

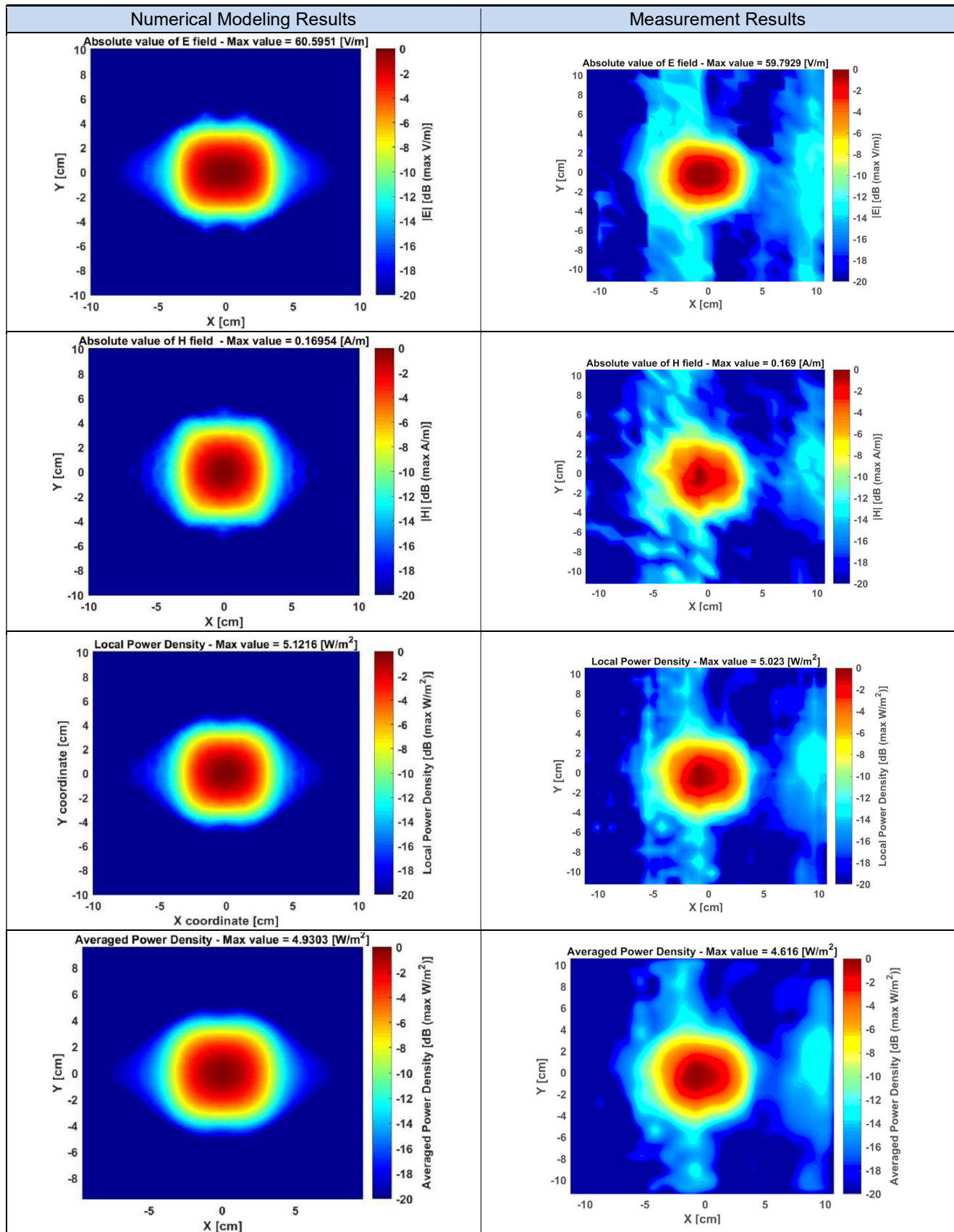

The plots below show the comparison between the numerical modeling and the system check results in terms of normalized E-field distribution and the 1D variation along the two axis of the maximum.

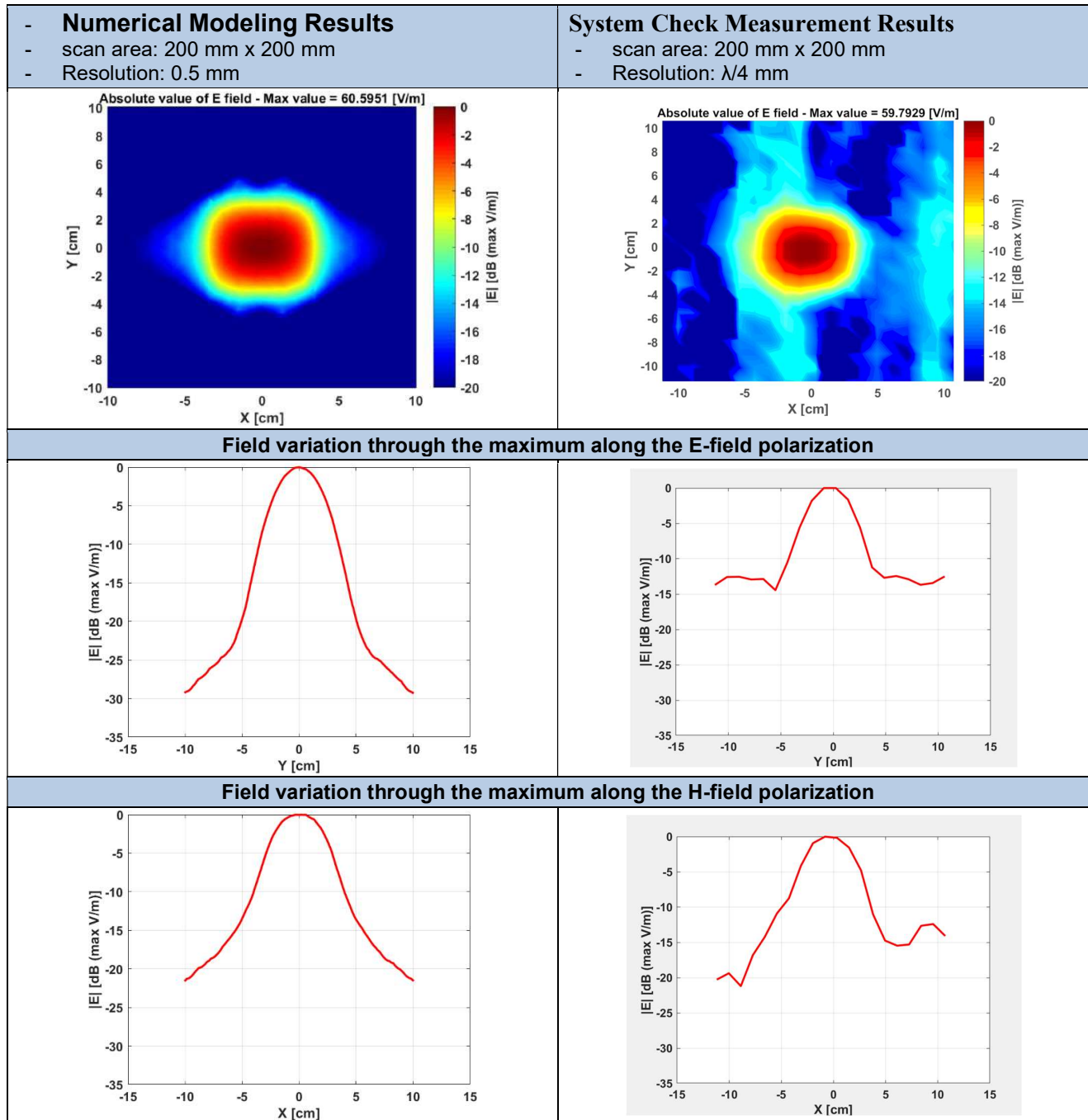

22. Power Density System Check From 6500MHz-2024-09-23

DUT: Horn reference source; Type: PE9859/SF-15;

Signal Source: modulation CW, level 10 dBm.

Medium parameters used: $\sigma = 0$ S/m, $\epsilon_r = 1$; $\rho = 0$ kg/m³

Phantom section: Table Section

Measurement Standard: DASYS6 (IEEE/IEC/ANSI C63.19-2011)

DASY Configuration:

- Probe: EUmmW – SN9538 ; ConvF(1, 1, 1); Calibrated: 2024-05-06;
 - Modulation Compensation:
- Sensor-Surface : 0mm (Fix Surface), z = 10 mm
- Electronics: DAE4 Sn1703; Calibrated: 2024-02-13
- Phantom: Cover; Type: SPEAG Phantom Cover
- cDASY6 5G Module v2.4
- Test Date: 2024-09-23

Distance-10mm/Measure Horn reference source (86.9x63.5):

Measurement Resolution = $\lambda/4$ mm

Measurement Scan area = 200 mm x 200 mm

The plots below show the comparison between the Numerical Modeling results and the system check measurement results in terms of E-field, H Field, single point power density and Avg Power density 1cm².

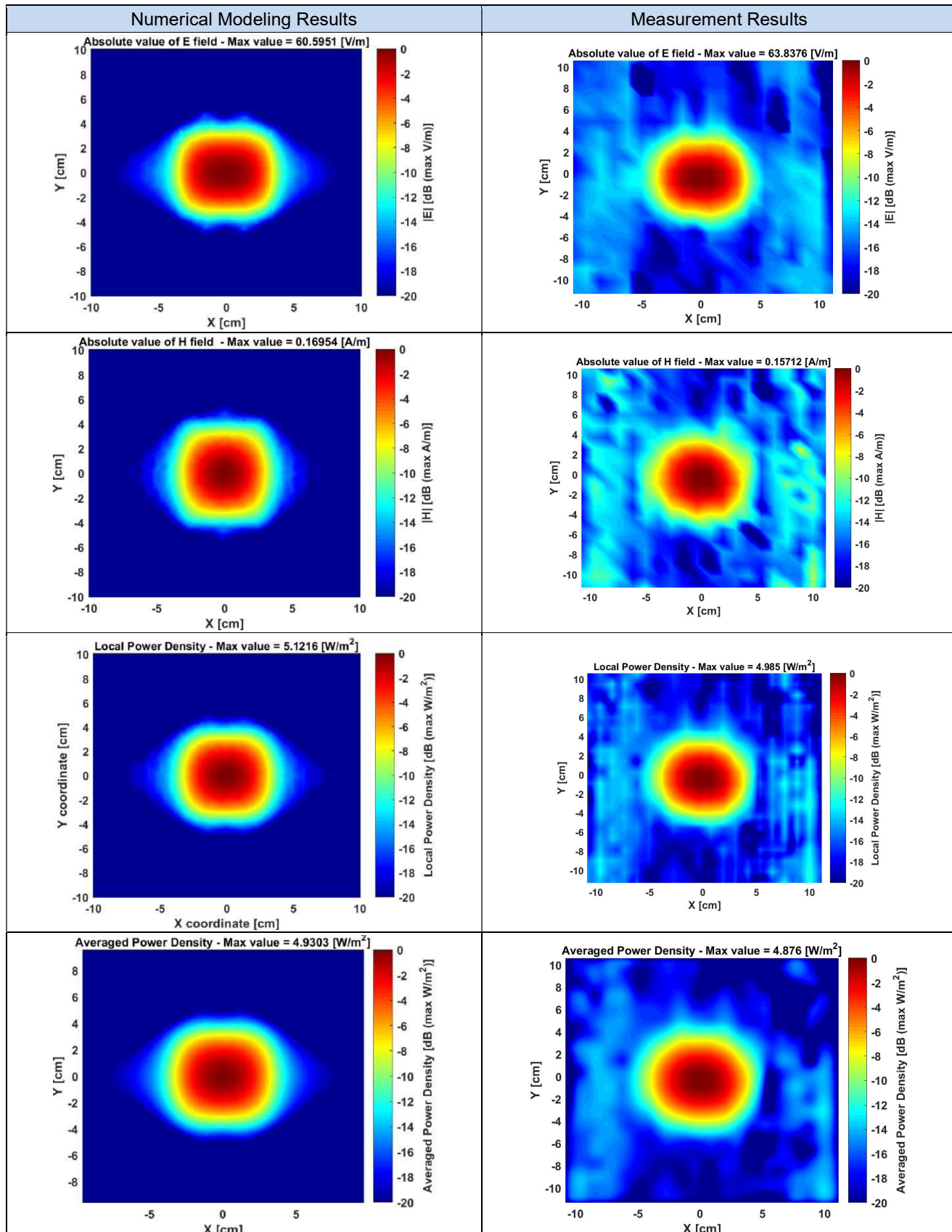

The plots below show the comparison between the numerical modeling and the system check results in terms of normalized E-field distribution and the 1D variation along the two axis of the maximum.

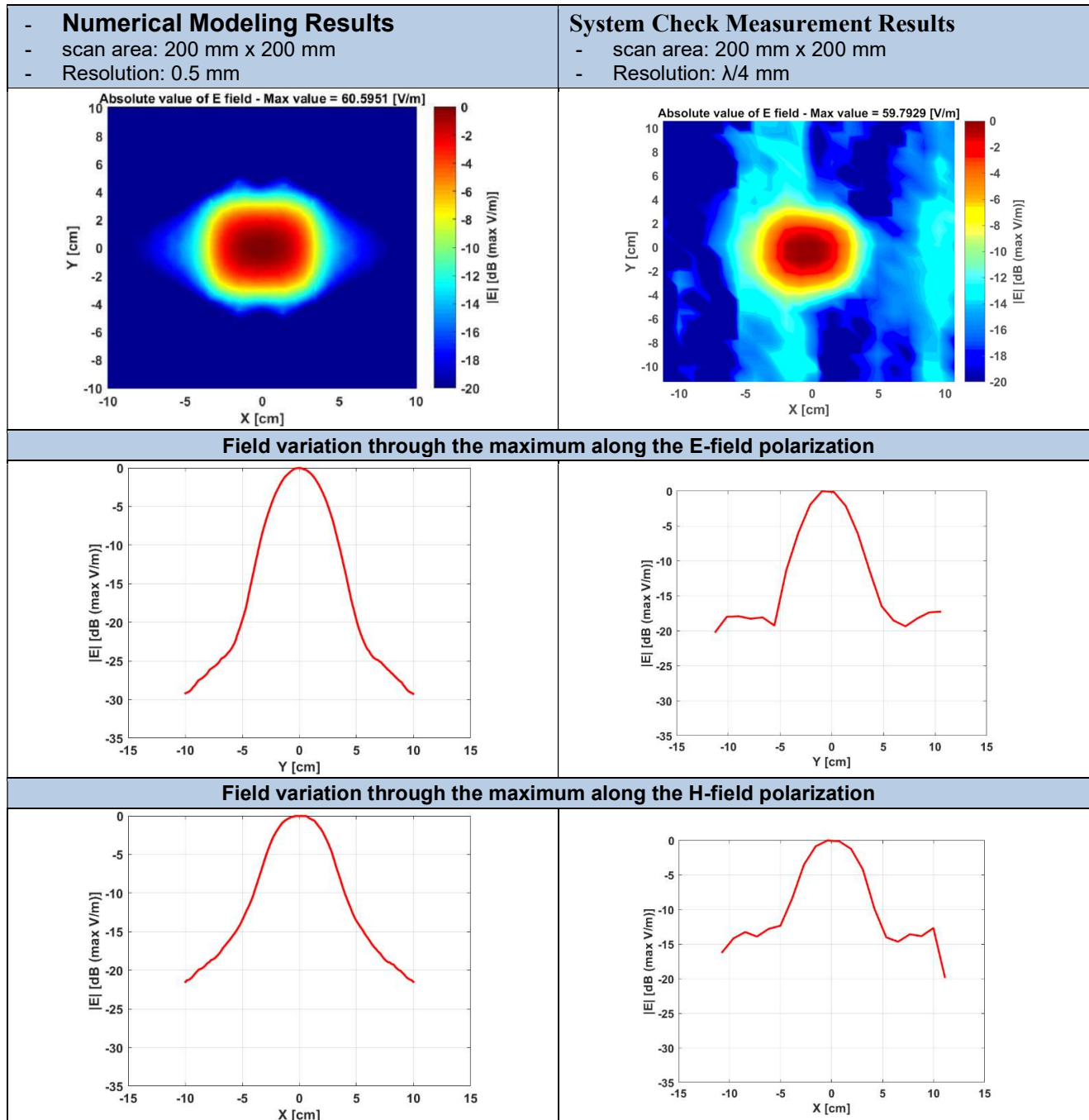

Annex C. TSL Dielectric Parameters

C.1 Head 2450MHz

Freq.(MHz)	Target		Measured 2024-09-19		Measured 2024-09-16	
	ϵ' (F/m)	σ (S/m)	$\epsilon'1$ (F/m)	$\sigma1$ (S/m)	$\epsilon'2$ (F/m)	$\sigma2$ (S/m)
2400	39.29	1.76	40.75	1.86	40.49	1.84
2450	39.20	1.80	40.66	1.90	40.45	1.88
2500	39.14	1.86	40.56	1.94	40.41	1.92

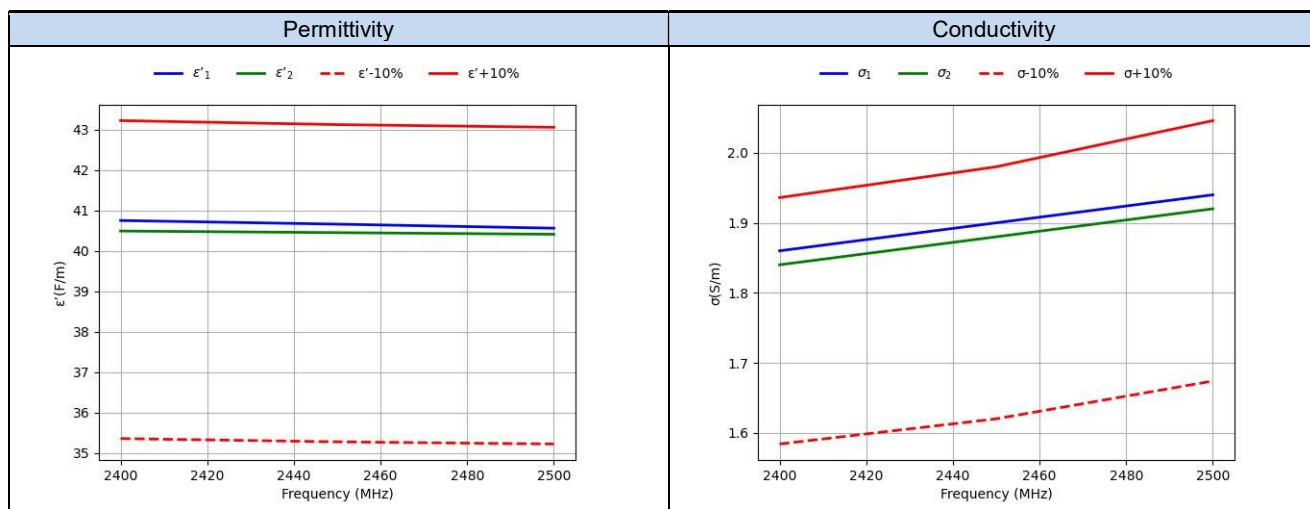

C.2 Head 5200MHz-5900MHz

Freq.(MHz)	Target		Measured 2024-09-19		Measured 2024-09-16	
	ϵ' (F/m)	σ (S/m)	$\epsilon'1$ (F/m)	$\sigma1$ (S/m)	$\epsilon'2$ (F/m)	$\sigma2$ (S/m)
5200	35.99	4.66	35.44	4.71	35.37	4.71
5250	35.93	4.71	35.35	4.78	35.28	4.78
5300	35.87	4.76	35.27	4.85	35.20	4.85
5350	35.81	4.81	35.19	4.92	35.13	4.91
5400	35.76	4.86	35.12	4.98	35.05	4.97
5450	35.70	4.91	35.03	5.04	34.98	5.03
5500	35.64	4.96	34.92	5.10	34.87	5.08
5550	35.59	5.01	34.82	5.16	34.77	5.14
5600	35.53	5.07	34.71	5.21	34.67	5.19
5650	35.47	5.12	34.61	5.26	34.57	5.23
5700	35.41	5.17	34.52	5.31	34.49	5.28
5750	35.36	5.22	34.42	5.35	34.40	5.33
5800	35.30	5.27	34.31	5.40	34.29	5.37
5850	35.24	5.32	34.21	5.44	34.20	5.41
5900	35.19	5.37	34.09	5.48	34.11	5.47

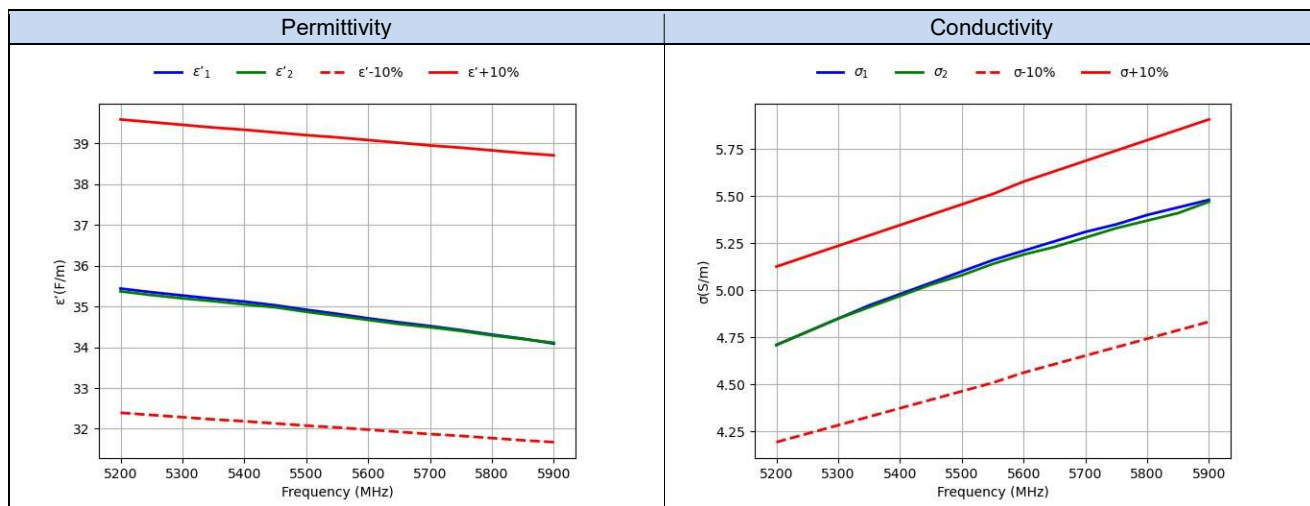

C.3 Head 6500MHz

Freq.(MHz)	Target		Measured 2024-09-19		Measured 2024-09-16	
	ϵ' (F/m)	σ (S/m)	$\epsilon'1$ (F/m)	$\sigma1$ (S/m)	$\epsilon'2$ (F/m)	$\sigma2$ (S/m)
6000	35.07	5.48	33.88	5.59	33.90	5.58
6050	35.01	5.54	33.78	5.66	33.81	5.65
6100	34.95	5.59	33.68	5.72	33.73	5.72
6150	34.89	5.65	33.58	5.78	33.63	5.79
6200	34.83	5.71	33.49	5.84	33.53	5.85
6250	34.77	5.77	33.39	5.91	33.42	5.92
6300	34.70	5.83	33.29	5.99	33.32	5.99
6350	34.64	5.89	33.19	6.07	33.22	6.07
6400	34.58	5.95	33.09	6.15	33.11	6.15
6450	34.52	6.01	33.00	6.23	33.00	6.22
6500	34.46	6.07	32.90	6.30	32.92	6.28
6550	34.40	6.13	32.79	6.36	32.81	6.34
6600	34.34	6.19	32.69	6.43	32.71	6.40
6650	34.29	6.25	32.58	6.49	32.62	6.45
6700	34.23	6.30	32.50	6.55	32.54	6.51
6750	34.17	6.36	32.45	6.60	32.48	6.56
6800	34.11	6.42	32.36	6.65	32.41	6.61
6850	34.05	6.48	32.28	6.70	32.33	6.66
6900	33.99	6.53	32.19	6.76	32.23	6.71
6950	33.94	6.59	32.09	6.81	32.15	6.77
7000	33.88	6.65	31.98	6.87	32.06	6.82

