

ANTENNA INFORMATION

OEM	Lenovo
ODM	LCFC
Platform model name	TP00151B "ThinkPad X1 2-in-1 Gen 10"
Intel platform (ex: Yes, No or NA)	Yes
Platform type (ex: regular NB, convertible PC, AIO...etc)	Regular NB
SAR minimum separation (mm)	2.7mm

Antenna manufacturer	SPEED	
Address	No. 138, Hi-tech District East-river, Huizhou, Guangdong, China	
Antenna Part number	Main: F-0G-JV-0228-005-00	Aux: F-0G-JV-0228-010-00
Antenna type (ex: PIFA, Dipole...etc)	PIFA	

Antenna Peak gain w/ cable loss (dBi)*										
	2.4GHz 2400-2483.5 MHz	5.2GHz 5150-5250MHz	5.3GHz 5250-5350MHz	5.6GHz 5470-5725MHz	5.8GHz 5725-5850MHz	5.9GHz 5850-5895MHz	6.2GHz 5925-6425MHz	6.5GHz 6425-6525MHz	6.7GHz 6525-6875MHz	7.0 GHz 6875-7125MHz
Main	-1.73	2.82	2.69	2.87	2.88	3.91	3.76	2.68	2.92	2.65
Aux	1.68	2.34	1.95	1.90	1.86	1.52	3.84	3.77	3.92	2.94

Cable Assembly Part Number and Information					
	Cable PN	Cable length(cm)	Cable diameter(mm)	Impedance(ohm)	Connector type
Main	SY113L/50-001	14.6	1.13	50	I-PEX
Aux	SY113L/50-016	9.7	1.13	50	I-PEX

* 3D Antenna Peak Gain required being test in system basis.

Table of Contents

Cover page.....	1
1. Intel Reference Gain and Type.....	3
2. Document Revision History.....	3
3. Test & System Description	
3.1 Measurement Method and System.....	4
3.2 Test setup.....	4
3.3 Equipment list.....	4
4. Radiation characteristics of antenna loaded in Host Platform.....	5
Annex A. Photographs	
A.1 Setup Photo.....	15
A.2 Test sample.....	16
Annex B. Antenna Location	
B.1 Antenna Host Platform Location Information.....	18
B.2 Antenna dimensional information for SAR evaluation.....	19

1. Intel Reference Gain and Type

Antenna Peak gain w/ cable loss (dBi)											
Band/Frequency		2.4GHz 2400-2483.5 MHz	5.2GHz 5150-5250MHz	5.3GHz 5250-5350MHz	5.6GHz 5470-5725MHz	5.8GHz 5725-5850MHz	5.9GHz 5850-5895MHz	6.2GHz 5925-6425MHz	6.5GHz 6425-6525MHz	6.7GHz 6525-6875MHz	7.0 GHz 6875-7125MHz
Design	EU/UK	3.00	5.00	5.00	5.00	5.00	5.00	5.00	5.00	5.00	5.00
PIFA	For WiFi 6E and earlier	3.24	3.64	3.73	4.77	4.97	4.72	4.83	4.30	5.37	5.59
	From WiFi 7	2.95	5.11	4.55	5.15	5.13	4.45	5.02	5.02	4.96	4.96
Dipole	For WiFi 6E and earlier	2.89	2.92	3.19	4.41	4.22	4.22	4.83	4.30	4.49	5.34
	From WiFi 7	2.95	4.03	4.11	5.15	5.13	4.45	5.02	4.71	4.49	4.96

3D Peak Antenna gain should be equal or greater than -2 dBi

If a host integrator plans to use a lower gain antenna of the same type, additional CBP(FCC)/EDT(EU) testing need to be performed while the module is installed in the host.

Revision #	Revision Details	Issued Date
Rev. 00	First Issue	2023.09.04

2. Document Revision History

3. Test & System Description

3.1 Measurement Method and System

This test report is prepared for host antenna testing under a Full Anechoic Chamber.

3.2 Test setup

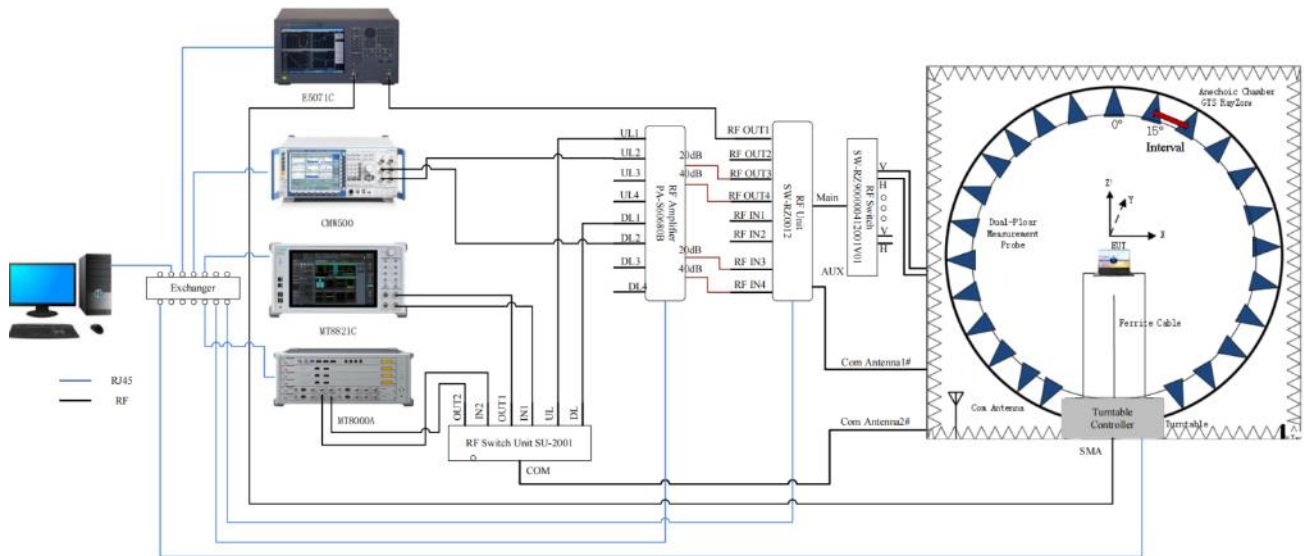

3.3 Equipment list

Radiated Setup

ID#	Device	Type/Model	Manufacturer	Cal.Date	Cal.Due Date
1	Anechoic Chamber	GTS Rayzone 2800	GTS	5-Jan-2022	5-Jan-2024
2	Network Analyzer	E5071C	Keysight	8-Oct-2022	8-Oct-2024
3	Communication Tester	E5515C	Agilent	5-Jan-2022	5-Jan-2024
4	Communication Tester	MT8000A	Anritsu	5-Jan-2022	5-Jan-2024
4	Communication Tester	MT8821C	Anritsu	5-Jan-2022	5-Jan-2024
4	Communication Tester	CMW500	R&S	5-Jan-2022	5-Jan-2024

4. Radiation characteristics of antenna loaded in Host Platform

Main Antenna

Max Antenna 3D Radiation Pattern 2400 – 2483.5 MHz

Frequency (MHz)	Peak Gain w/ Cable Loss (dBi)
2400-2483.5	-1.73

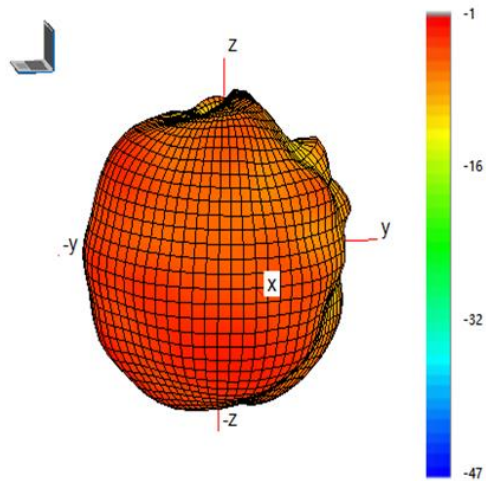

Max Antenna 3D Radiation Pattern 5150-5250 MHz

Frequency (MHz)	Peak Gain w/ Cable Loss (dBi)
5150-5250	2.82

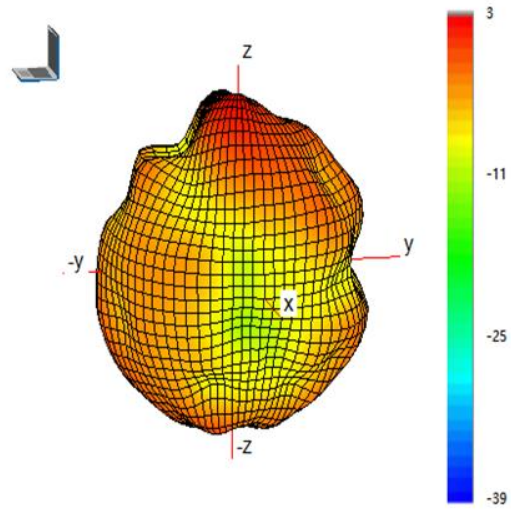

Max Antenna 3D Radiation Pattern 5250-5350 MHz

Frequency (MHz)	Peak Gain w/ Cable Loss (dBi)
5250-5350	2.69

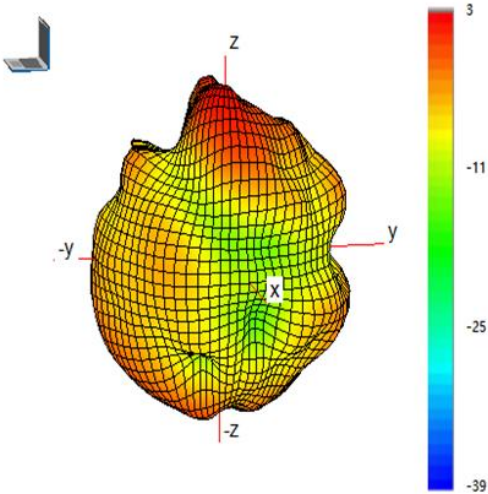

Max Antenna 3D Radiation Pattern 5470-5725 MHz

Frequency (MHz)	Peak Gain w/ Cable Loss (dBi)
5470-5725	2.87

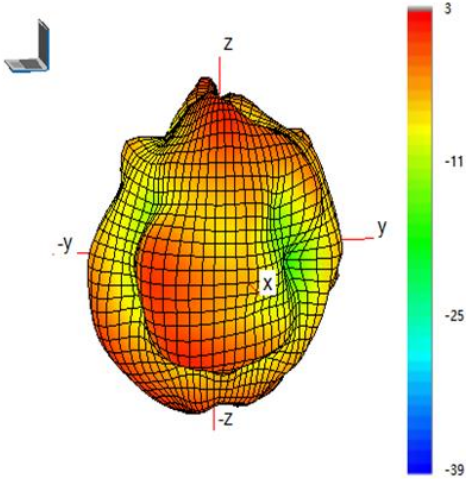

Max Antenna 3D Radiation Pattern 5725-5850 MHz

Frequency (MHz)	Peak Gain w/ Cable Loss (dBi)
5725-5850	2.88

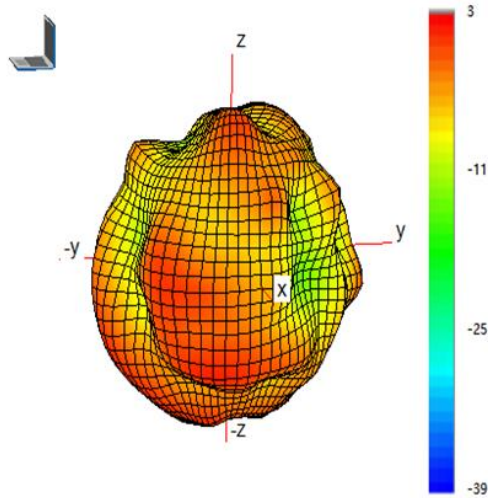

Max Antenna 3D Radiation Pattern 5850-5895 MHz

Frequency (MHz)	Peak Gain w/ Cable Loss (dBi)
5850-5895	3.91

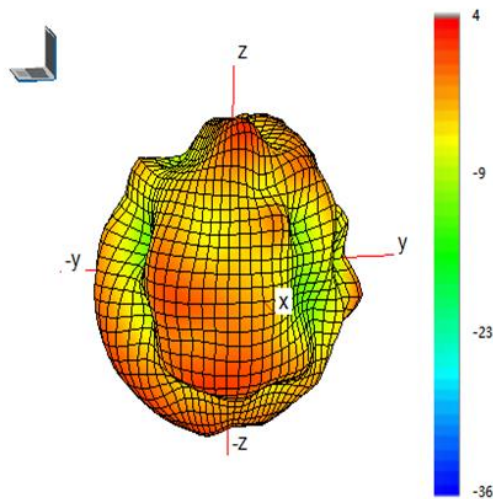

Max Antenna 3D Radiation Pattern 5925-6425 MHz

Frequency (MHz)	Peak Gain w/ Cable Loss (dBi)
5925-6425	3.76

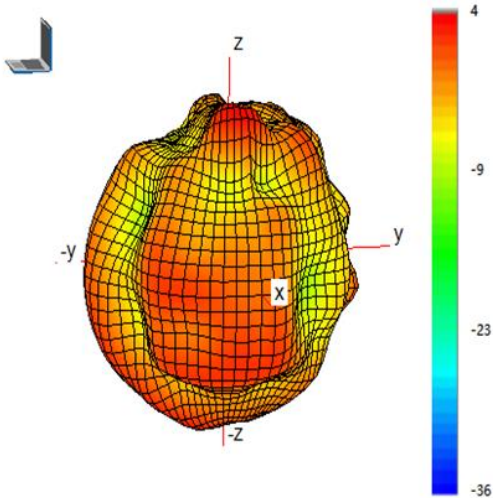

Max Antenna 3D Radiation Pattern 6425-6525 MHz

Frequency (MHz)	Peak Gain w/ Cable Loss (dBi)
6425-6525	2.68

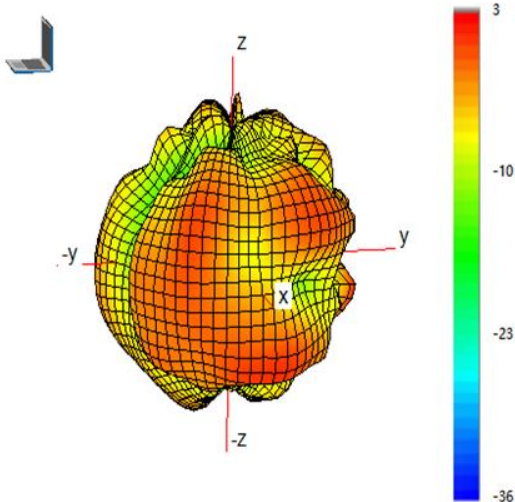

Max Antenna 3D Radiation Pattern 6525-6875 MHz

Frequency (MHz)	Peak Gain w/ Cable Loss (dBi)
6525-6875	2.92

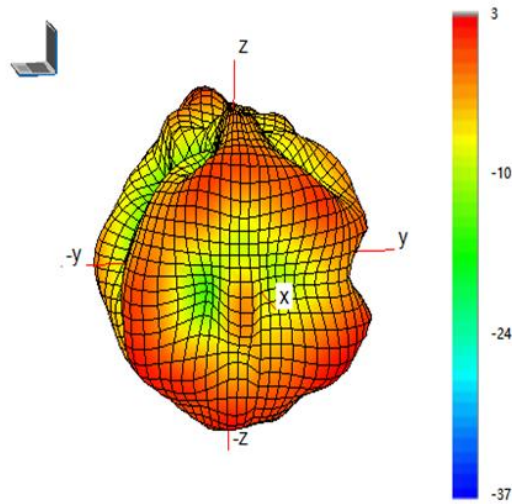

Max Antenna 3D Radiation Pattern 6875-7125 MHz

Frequency (MHz)	Peak Gain w/ Cable Loss (dBi)
6875-7125	2.65

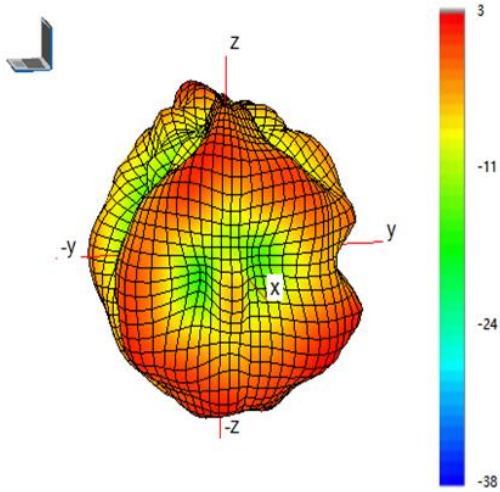

Auxiliary Antenna

Max Antenna 3D Radiation Pattern 2400 – 2483.5 MHz

Frequency (MHz)	Peak Gain w/ Cable Loss (dBi)
2400-2483.5	1.68

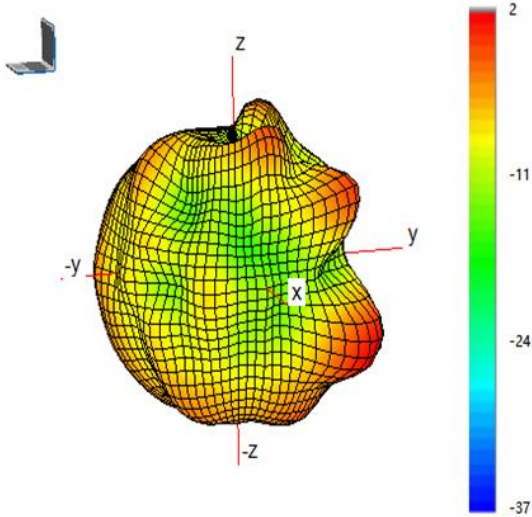

Max Antenna 3D Radiation Pattern 5150-5250 MHz

Frequency (MHz)	Peak Gain w/ Cable Loss (dBi)
5150-5250	2.34

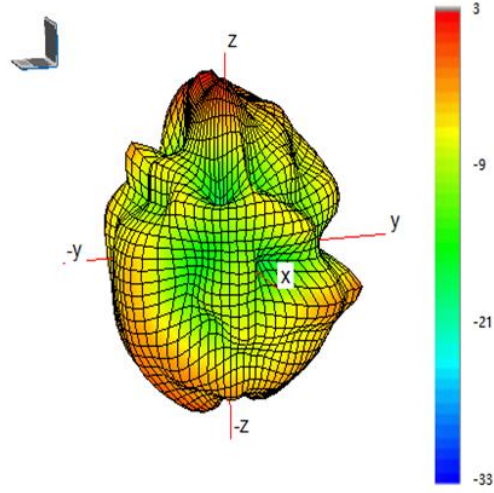

Max Antenna 3D Radiation Pattern 5250-5350 MHz

Frequency (MHz)	Peak Gain w/ Cable Loss (dBi)
5250-5350	1.95

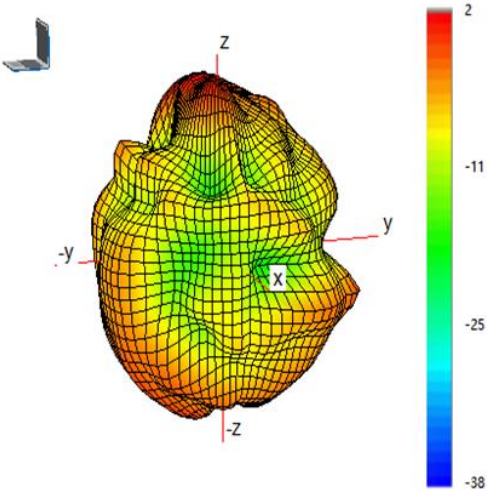

Max Antenna 3D Radiation Pattern 5470-5725 MHz

Frequency (MHz)	Peak Gain w/ Cable Loss (dBi)
5470-5725	1.90

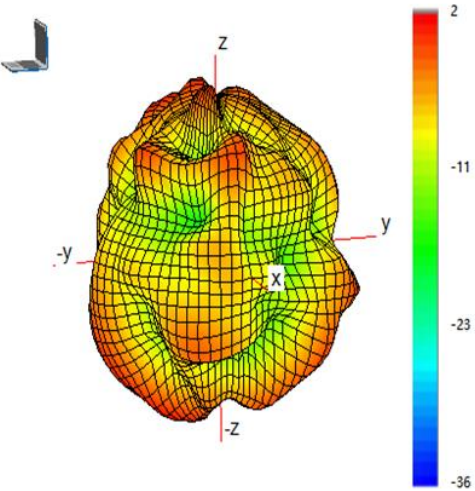

Max Antenna 3D Radiation Pattern 5725-5850 MHz

Frequency (MHz)	Peak Gain w/ Cable Loss (dBi)
5725-5850	1.86

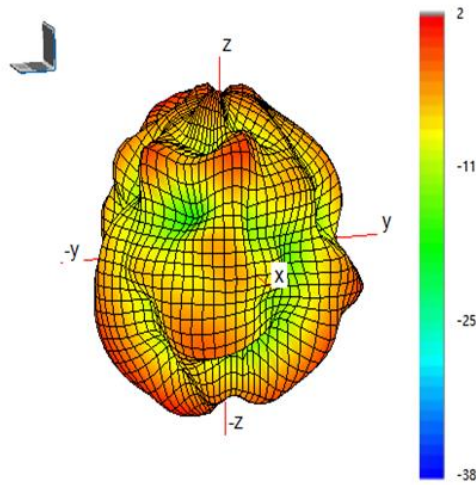

Max Antenna 3D Radiation Pattern 5850-5895 MHz

Frequency (MHz)	Peak Gain w/ Cable Loss (dBi)
5850-5895	1.52

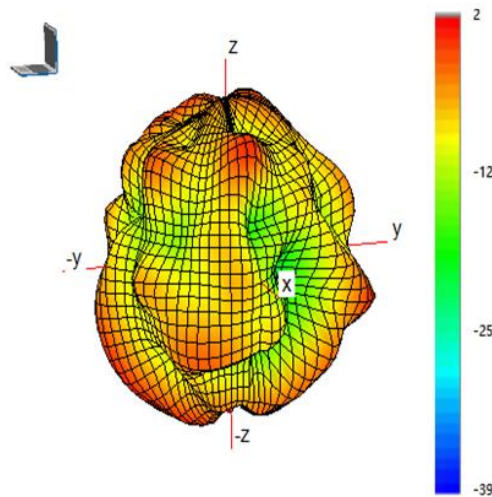

Max Antenna 3D Radiation Pattern 5925-6425 MHz

Frequency (MHz)	Peak Gain w/ Cable Loss (dBi)
5925-6425	3.84

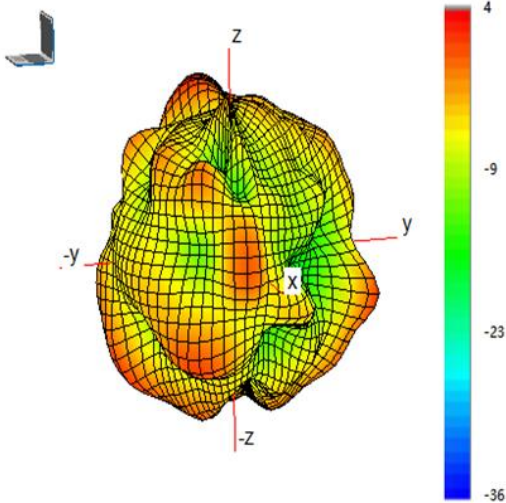

Max Antenna 3D Radiation Pattern 6425-6525 MHz

Frequency (MHz)	Peak Gain w/ Cable Loss (dBi)
6425-6525	3.77

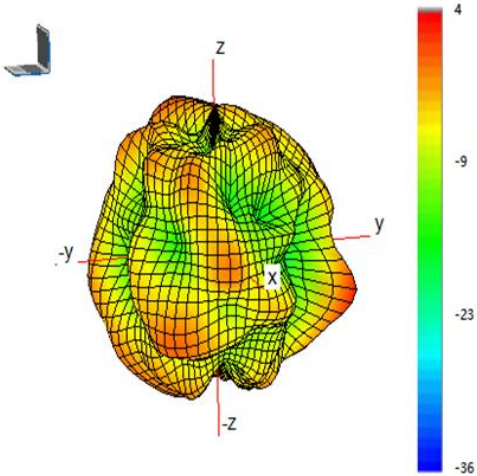

Max Antenna 3D Radiation Pattern 6525-6875 MHz

Frequency (MHz)	Peak Gain w/ Cable Loss (dBi)
6525-6875	3.92

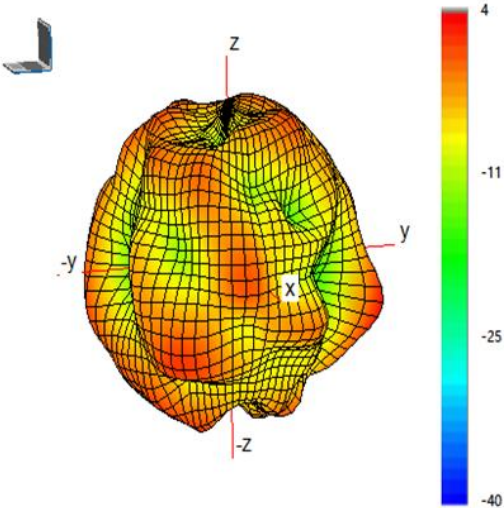

Max Antenna 3D Radiation Pattern 6875-7125 MHz

Frequency (MHz)	Peak Gain w/ Cable Loss (dBi)
6875-7125	2.94

