



TESTING CERT #3478.01



TEST REPORT

EUT Description	Wireless Module installed in 2 in 1 PC/Tablet
Brand Name	Intel® Dual-Band Wireless-AC 8265
Model Name	8265D2W
Serial Number	WF MAC: 34.13.E8.59.DA.70 BT MAC: 34.13.E8.59.DA.6C (see section 4)
FCC/IC ID	FCC ID: PD98265D2 & PD98265NGU IC ID: 1000M-8265D2
Antenna type	Antenna: Slot Antenna, TE Connectivity Main: 2195540-1 Aux : 2195540-1
Hardware/Software Version	DRTU version: 1.8.9-03151 Driver version: 19.0.0.9
Date of Sample Receipt	2016-09-27
Date of Test Start/End	2016-09-28 / 2016-10-07
Features	802.11 a/b/g/n/ac Wireless LAN + Bluetooth v4.2 (see section 7)
Description	Wireless Module: Intel® 8265D2W Platform: P71G series

Applicant	Intel Mobile Communications
Address	100 Center Point Circle, Suite 200 / Columbia, SC 29210 / United States
Contact Person	Steven Hackett
Telephone/Fax/Email	steven.c.hackett@intel.com

Reference Standards	FCC 47 CFR Part §2.1093 RSS-102, Issue 5 (see section 1)	
RF Exposure Environment	Portable devices - General population/uncontrolled exposure	
	SAR Result	SAR Limit
Maximum SAR Result & Limit	1.48 W/kg (1g)	1.6 W/kg (1g)
Min. test separation distance	5.76mm	

Test Report number	160901-01.TR01
Revision Control	Rev. 00 This test report revision replaces any previous test report version (see section 6)

The test results relate only to the samples tested.

The test report shall not be reproduced in full, without written approval of the laboratory.

Issued by

Reviewed by

Rafael QUIROZ
(Test Lead)

Jose M. FORTES
(Technical Officer)

**Intel Mobile Communications France S.A.S – WRF Lab
425 rue de Goa – Le Cargo B6 – 06600, Antibes, France
Tel. +33493001400 / Fax +33493001401**

Table of Contents

1. Standards, reference documents and applicable test methods	3
2. General conditions, competences and guarantees	3
3. Environmental Conditions	4
4. Test samples.....	4
5. Remarks and comments.....	4
6. Document Revision History	4
7. Equipment Under Test.....	5
8. Test Verdicts summary.....	7
Annex A. Test & System Description	8
A.1 SAR DEFINITION	8
A.2 SPEAG SAR MEASUREMENT SYSTEM	9
A.2.1 SAR MEASUREMENT SETUP.....	9
A.2.2 E-FIELD MEASUREMENT PROBE.....	10
A.2.3 SAM PHANTOM	10
A.2.4 FLAT PHANTOM	11
A.2.5 DEVICE POSITIONER.....	11
A.3 DATA EVALUATION.....	12
A.4 SYSTEM AND LIQUID CHECK.....	14
A.4.1 SYSTEM CHECK	14
A.4.2 LIQUID CHECK	15
A.5 TEST EQUIPMENT LIST.....	16
A.6 MEASUREMENT UNCERTAINTY EVALUATION.....	17
A.7 RF EXPOSURE LIMITS	19
Annex B. Test Results.....	20
B.1 TEST CONDITIONS	20
B.1.1 SAR TEST POSITIONS RELATIVE TO THE PHANTOM.....	20
B.1.2 TEST SIGNAL, OUTPUT POWER AND TEST FREQUENCIES	20
B.1.3 EVALUATION EXCLUSION AND TEST REDUCTIONS.....	21
B.2 CONDUCTED POWER MEASUREMENTS	23
B.2.1 WLAN 2.4GHZ (DTS)	23
B.2.2 WLAN 5GHZ (UNII)	24
B.2.3 BLUETOOTH	27
B.3 TISSUE PARAMETERS MEASUREMENT.....	28
B.4 SYSTEM CHECK MEASUREMENTS.....	28
B.5 SAR TEST RESULTS.....	29
B.5.1 802.11B/G/N – 2.4GHZ - DTS	29
B.5.2 802.11A/N/AC – 5.3 GHZ – UNII-2A	29
B.5.3 802.11A/N/AC – 5.6 GHZ – UNII-2C.....	29
B.5.4 802.11A/N/AC – 5.8 GHZ – UNII-3.....	30
B.5.5 BLUETOOTH – 2.4GHZ - DSSS.....	30
B.6 SAR MEASUREMENT VARIABILITY	31
B.7 SIMULTANEOUS TRANSMISSION SAR EVALUATION	32
Annex C. Test System Plots	33
Annex D. TSL Dielectric Parameters	47
Annex E. Calibration Certificates	51
Annex F. Photographs.....	53

1. Standards, reference documents and applicable test methods

1. FCC 47 CFR Part §2.1093 – Radiofrequency radiation exposure evaluation: portable devices.
2. FCC OET KDB 248827 D01 – SAR guidance for IEEE 802.11 (Wi-Fi) transmitters.
3. FCC OET KDB 447498 D01 – Mobile and Portable Devices RF Exposure Procedures and Equipment Authorization Policies.
4. FCC OET KDB 616217 D04 – SAR Evaluation Considerations for Laptop, Notebook, Netbook and Tablet Computers.
5. FCC OET KDB 865664 D01 – SAR Measurement Requirements for 100 MHz to 6 GHz.
6. –FCC OET KDB 865664 D02 – RF Exposure Compliance Reporting and Documentation Considerations.
7. IC RSS 102, Issue 5 – Radio Frequency (RF) Exposure Compliance of Radio communication Apparatus (All Frequency Bands).
8. IC Notice 2012-DRS0529 – SAR correction for measured conductivity and relative permittivity based on IEC 62209-2 standard.
9. IC Notice 2012-DRS1203 – Applicability of latest FCC RF Exposure KDB procedures (publication date October 24, 2012) and other procedures.
10. IC Notice 2013-DRS0911 – Latest publication of IEEE 1528-2013 and power exemption limits.
11. IEEE Std 1528-2013 – IEEE Recommended Practice Determining the Peak Spatial-Average Specific Absorption Rate (SAR) in the Human Head from Wireless Communication Devices: Measurement Techniques.

2. General conditions, competences and guarantees

- ✓ Intel Mobile Communications Wireless RF Lab (Intel WRF Lab) is a testing laboratory accredited by the American Association for Laboratory Accreditation (A2LA).
- ✓ Intel Mobile Communications Wireless RF Lab (Intel WRF Lab) is an Accredited Test Firm listed by the FCC, with Designation Number FR0011.
- ✓ Intel Mobile Communications Wireless RF Lab (Intel WRF Lab) is a Registered Test Site listed by IC, with IC Assigned Code 1000Y.
- ✓ Intel WRF Lab only provides testing services and is committed to providing reliable, unbiased test results and interpretations.
- ✓ Intel WRF Lab is liable to the client for the maintenance of the confidentiality of all information related to the item under test and the results of the test.
- ✓ Intel WRF Lab has developed calibration and proficiency programs for its measurement equipment to ensure correlated and reliable results to its customers.
- ✓ This report is only referred to the item that has undergone the test.
- ✓ This report does not imply an approval of the product by the Certification Bodies or competent Authorities.
- ✓ Complete or partial reproduction of the report cannot be made without written permission of Intel WRF Lab.

3. Environmental Conditions

- ✓ All tests were performed in a laboratory with an environment which avoids influence on SAR measurements by ambient EM sources and any reflection from the environment itself, and the following limits were not exceeded during the tests:

Temperature	23°C ± 2°C
Humidity	40% ± 10%
Liquid Temperature	21°C ± 2°C

4. Test samples

Sample	Test Item #	Description	Model	Serial #	Date of reception
#01	160901-01.S01	Wireless Module installed in Tablet	8265D2W + P71G series	WF MAC 34.13.E8.59.DA.70 BT MAC: 34.13.E8.59.DA.6C	2016-09-27

- ✓ Sample #01 has undergone all the test(s) requested by the applicant, following the standards specified in section 1.

5. Remarks and comments

1. Only the plots for the test positions with the highest measured SAR per band/mode are included in Annex C as required per FCC OET KDB 865664 D02, paragraph 2.3.8.

6. Document Revision History

Revision #	Date	Modified by	Details
Rev. 00	2016-11-16	R. Quiroz	First Issue

7. Equipment Under Test

Brand Name	Intel® Dual-Band Wireless-AC 8265
Model Name	8265D2W
FCC/IC ID	FCC ID: PD98265D2 & PD98265NGU IC ID: 1000M-8265D2
Software Version	1.8.9-03151
Driver Version	19.0.0.9
Prototype / Production	Production
Host Identification	P71G series
Exposure Conditions	Body worn
Supported Radios	802.11a/b/g/n/ac Bluetooth v4.2
Antenna Information	Main WLAN: Slot antenna. WiFi 2.4GHz & 5GHz and BT. Aux WLAN: Slot antenna. WiFi 2.4GHz & 5GHz See <i>Annex F</i> for more details on antennas location.
Simultaneous Transmission Configurations	BT Main + WLAN 2.4GHz Aux WLAN 2.4GHz Main + WLAN 2.4GHz Aux BT Main + WLAN 5GHz Aux WLAN 5GHz Main + WLAN 5GHz Aux WLAN 5GHz Main + BT Main+ WLAN 5GHz Aux
Additional Information	No WWAN transmitter is considered in this report
	5.60-5.65 GHz band (TDWR) is supported by the device
	Band gap is supported by the device

Supported Radios

Mode	Duty Cycle	Modulation	Band	UL Freq Range (MHz)	Measured Max. Conducted Power (dBm)
802.11b/g/n	100%	BPSK QPSK 16QAM 64QAM	2.4GHz	2400-2483.5	19.00
802.11a/n/ac	100%	BPSK QPSK 16QAM 64QAM 256QAM	5.2GHz	5150-5250	19.00
			5.3GHz	5250-5350	19.00
			5.6GHz	5475-5725	17.00
			5.8GHz	5725-5850	17.00
BDR/EDR v4.2	77%	GFSK $\pi/4$ DQPSK 8DPSK	2.4GHz	2400-2483.5	11.04
Bluetooth LE v4.2	62%	GFSK	2.4GHz	2400-2483.5	4.24

Maximum Output power specification + Tune up tolerance limit			Antenna	
Equipment Class	Mode	BW [MHz]	Main [dBm]	Aux [dBm]
DTS	802.11b	20	19.00	19.00
	802.11g	20	19.00	19.00
	802.11n20	20	19.00	19.00
	802.11n40	40	19.00	19.00
UNII-1	802.11a	20	19.00	17.00
	802.11n20	20	19.00	17.00
	802.11n40	40	19.00	17.00
	802.11ac80	80	19.00	17.00
UNII-2A	802.11a	20	19.00	17.00
	802.11n20	20	19.00	17.00
	802.11n40	40	19.00	17.00
	802.11ac80	80	19.00	17.00
UNII-2C	802.11a	20	17.00	15.00
	802.11n20	20	17.00	15.00
	802.11n40	40	17.00	15.00
	802.11ac80	80	17.00	15.00
UNII-3	802.11a	20	17.00	15.00
	802.11n20	20	17.00	15.00
	802.11n40	40	17.00	15.00
	802.11ac80	80	17.00	15.00
BT	Bluetooth v4.2 BDR	2	12	
	Bluetooth v4.2 EDR2	2	9	
	Bluetooth v4.2 EDR3	2	8	
	BLE	-	5	

The conducted values are obtained by applying the BIOS SAR power values to the 8265D2W Intel module installed in the DELL P71G Model identified in this report, as requested by the customer.

8. Test Verdicts summary

Mode	Band	Highest Reported SAR (1g) (W/kg)	Verdict
802.11b/g/n	2.4GHz	0.60	P
802.11a/n/ac	5.3GHz	1.10	P
	5.6GHz	1.16	P
	5.8GHz	1.48	P
Bluetooth	2.4GHz	0.08	P

P: Pass
 F: Fail
 NM: Not Measured
 NA: Not Applicable

According to the FCC OET KDB 690783 D01, this is the summary of the values for the Grant Listing:

Highest Reported SAR (1g) (W/kg)			
Exposure Condition	Equipment Class		
	DTS	DSSS	UNII
Body Worn	0.60	0.08	1.48
Simultaneous Tx	Sum-SAR: 1.05	Sum-SAR: 1.24	Sum-SAR: 2.72 SPLSR: 0.04

Considering the results of the performed test according to FCC 47CFR Part 2.1093 and IC RSS 102, Issue 5 the item under test is **IN COMPLIANCE** with the requested specifications specified in section 1. *Standards, reference documents and applicable test methods.*

Annex A. Test & System Description

A.1 SAR Definition

Specific Absorption rate is defined as the time derivative of the incremental energy (dW) absorbed by (dissipated in) and incremental mass (dm) contained in a volume element (dV) of a given density (ρ).

$$SAR = \frac{d}{dt} \cdot \left(\frac{dW}{dm} \right) = \frac{d}{dt} \cdot \left(\frac{dW}{\rho \cdot dV} \right)$$

SAR is expressed in units of watts per kilogram (W/kg). SAR can be related to the electric field at a point by

$$SAR = \frac{\sigma |E|^2}{\rho}$$

Where:

σ = Conductivity of the tissue (S/m)

ρ = Mass density of the tissue (kg/m³)

E = RMS electric field strength (V/m)

A.2 SPEAG SAR Measurement System

A.2.1 SAR Measurement Setup

The DASY5 system for performing compliance tests consists of the following items:

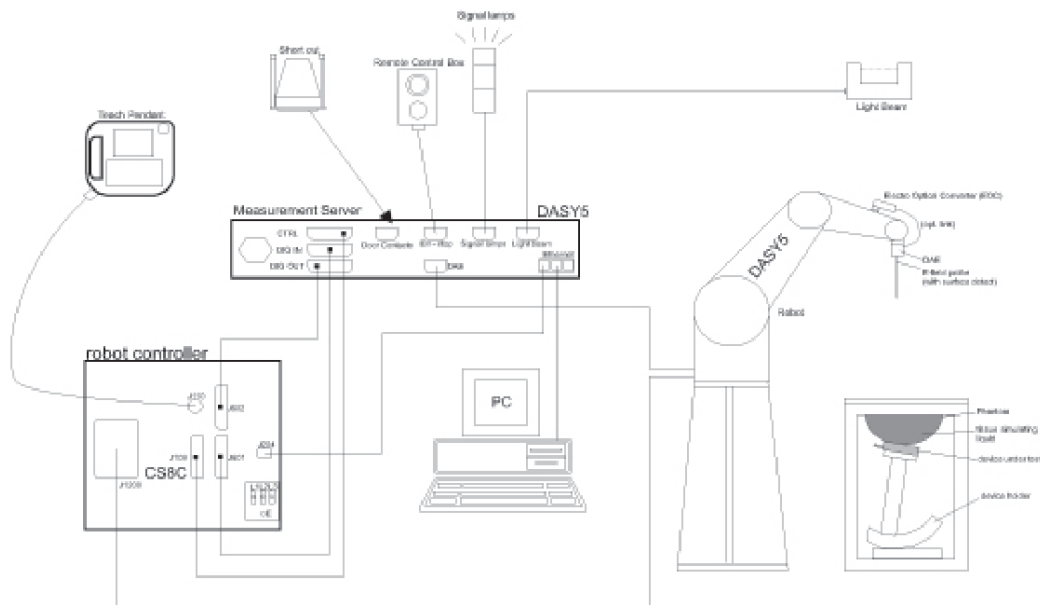

- ✓ A standard high precision 6-axis robot (Stäubli TX/RX family) with controller, teach pendant and software. It includes an arm extension for accommodating the data acquisition electronics (DAE)
- ✓ An isotropic field probe optimized and calibrated for the targeted measurements.
- ✓ A data acquisition electronics (DAE) which performs the signal amplification, signal multiplexing, AD-conversion, offset measurements, mechanical surface detection, collision detection, etc. The unit is battery powered with standard or rechargeable batteries. The signal is optically transmitted to the EOC.
- ✓ The Electro-optical Converter (EOC) performs the conversion from optical to electrical signals for the digital communication to the DAE. The EOC signal is transmitted to the measurement server.
- ✓ The function of the measurement server is to perform the time critical tasks such as signal filtering, control of the robot operation and fast movements interrupts.
- ✓ The Light Beam used is for probe alignment. This improves the (absolute) accuracy of the probe positioning.
- ✓ A computer running Win7 professional operating system and the DASY5 software.
- ✓ Remote control and teach pendant as well as additional circuitry for robot safety such as warning lamps, etc.
- ✓ The phantom, the device holder and other accessories according to the targeted measurement.
- ✓ Tissue simulating liquid.
- ✓ System Validation dipoles.
- ✓ Network emulator or RF test tool

A.2.2 E-Field Measurement Probe

The probe is constructed using three orthogonal dipole sensors arranged on an interlocking, triangular prism core. The probe has built-in shielding against static charges and is contained within a PEEK cylindrical enclosure material at the tip.

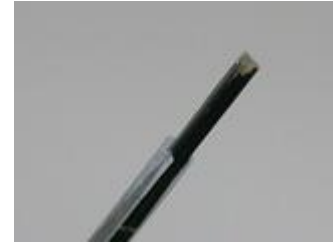

The probe's characteristics are:

Frequency Range	30MHz – 6GHz
Length	337 mm
Probe tip external diameter	2.5 mm
Typical distance between dipoles and the probe tip	1 mm
Axial Isotropy (in human-equivalent liquids)	±0.3 dB
Hemispherical Isotropy (in human-equivalent liquids)	±0.5 dB
Linearity	±0.2 dB
Maximum operating SAR	100 W/kg
Lower SAR detection threshold	0.001 W/kg

A.2.3 SAM Phantom

The shell corresponds to the specifications of the Specific Anthropomorphic Mannequin (SAM) phantom defined in IEEE 1528 and IEC 62209-1. It enables the dosimetric evaluation of left and right hand phone usage as well as body mounted usage at the flat phantom region. A cover prevents evaporation of the liquid. Reference markings on the phantom allow the complete setup of all predefined phantom positions and measurement grids by teaching three points with the robot.

The phantom's characteristics are:



Material	Vinylester, glass fiber reinforced (VE-GF)
Shell thickness	2 mm ± 0.2 mm
Shell thickness at ERP	6 ± 0.2 mm
Filling volume	25 Liters
Dimensions	Length: 1000mm / Width: 500mm

A.2.4 Flat Phantom

Phantom for compliance testing of handheld and body-mounted wireless devices in the frequency range of 30 MHz to 6 GHz. ELI is fully compatible with the IEC 62209-2 standard and all known tissue simulating liquids. ELI has been optimized regarding its performance and can be integrated into our standard phantom tables. A cover prevents evaporation of the liquid. Reference markings on the phantom allow installation of the complete setup, including all predefined phantom positions and measurement grids, by teaching three points. The phantom is compatible with all SPEAG dosimetric probes and dipoles.

The phantom's characteristics are:

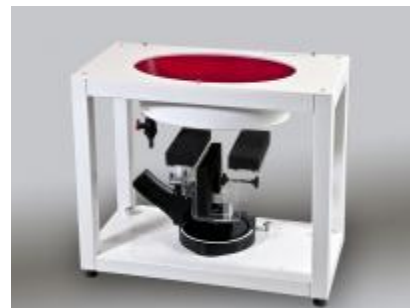

Material	Vinylester, glass fiber reinforced (VE-GF)
Shell thickness	2 mm ± 0.2 mm
Filling volume	30 Liters approx.
Dimensions	Major axis: 600mm / Minor axis: 400mm

A.2.5 Device Positioner

The SAR in the phantom is approximately inversely proportional to the square of the distance between the source and the liquid surface. For a source at 5 mm distance, a positioning uncertainty of 0.5 mm would produce a SAR uncertainty of 20%. Accurate device positioning is therefore crucial for accurate and repeatable measurements. The positions in which the devices must be measured are defined by the standards.



The DASY device holder is designed to cope with the different positions given in the standard. It has two scales for device rotation (with respect to the body axis) and device inclination (with respect to the line between the ear reference points). The rotation center for both scales is the ear reference point (ERP). Thus the device needs no repositioning when changing the angles.

The DASY device holder is constructed of low-loss POM material having the following dielectric parameters: relative permittivity $\epsilon=3$ and loss tangent $\delta=0.02$. The amount of dielectric material has been reduced in the closest vicinity of the device, since measurements have suggested that the influence of the clamp on the test results could thus be lowered.



A simple but effective and easy-to-use extension for the Mounting Device; facilitates testing of larger devices according to IEC 62209-2 (e.g., laptops, cameras, etc.); lightweight and fits easily on the upper part of the Mounting Device in place of the phone positioner. The extension is fully compatible with the Twin SAM, ELI and other Flat Phantoms.

A.3 Data Evaluation

- **Power Reference measurement**

The robot measures the E field in a specified reference position that can be either the selected section's grid reference point or a user point in this section at 4mm of the inner surface of the phantom, 2mm for frequencies above 3GHz.

- **Area Scan**

Measurement procedures for evaluating SAR from wireless handsets typically start with a coarse measurement grid to determine the approximate location of the local peak SAR values. This is known as the area-scan procedure. The SAR distribution is scanned along the inside surface of one side of the phantom head, at least for an area larger than the projection of the handset and antenna. The distance between the measured points and phantom surface should be less than 8 mm, and should remain constant (with variation less than ± 1 mm) during the entire scan in order to determine the locations of the local peak SAR with sufficient accuracy. The angle between the probe axis and the surface normal line is recommended but not required to be less than 30° . If this angle is larger than 30° and the closest point on the probe-tip housing to the phantom surface is closer than a probe diameter, the boundary effect may become larger and polarization dependent. This additional uncertainty needs to be analyzed and accounted for. To achieve this, modified test procedures and additional uncertainty analyses not described in this recommended practice may be required. The measurement and interpolation point spacing should be chosen such as to allow identification of the local peak locations to within one-half of the linear dimension of a side of the zoom-scan volume. Because a local peak having specific amplitude and steep gradients may produce a lower peak spatial-average SAR compared to peaks with slightly lower amplitude and less steep gradients, it is necessary to evaluate these other peaks as well. However, since the spatial gradients of local SAR peaks are a function of the wavelength inside the tissue-equivalent liquid and the incident magnetic field strength, it is not necessary to evaluate local peaks that are less than 2 dB or more below the global maximum peak. Two-dimensional spline algorithms (Brishoual et al. 2001; Press et al., 1996) are typically used to determine the peaks and gradients within the scanned area. If a peak is found at a distance from the scan border of less than one-half the edge dimension of the desired 1 g or 10 g cube, the measurement area should be enlarged if possible.

- **Zoom Scan**

To evaluate the peak spatial-average SAR values for 1 g or 10 g cubes, fine resolution volume scans, called zoom scans, are performed at the peak SAR locations identified during the area scan. The minimum zoom scan volume size should extend at least 1.5 times the edge dimension of a 1 g cube in all directions from the center of the scan volume, for both 1 g and 10 g peak spatial-average SAR evaluations. Along the phantom curved surfaces, the front face of the volume facing the tissue/liquid interface conforms to the curved boundary, to ensure that all SAR peaks are captured. The back face should be equally distorted to maintain the correct averaging mass. The flatness and orientation of the four side faces are unchanged from that of a cube whose orientation is within $\pm 30^\circ$ of the line normal to the phantom at the center of the cube face next to the phantom surface. The peak local SAR locations that were determined in the area scan (interpolated values) should be used for the centers of the zoom scans. If a scan volume cannot be centered due to proximity of a phantom shape feature, the probe should be tilted to allow scan volume enlargement. If probe tilt is not feasible, the zoom-scan origin may be shifted, but not by more than half of the 1 g or 10 g cube edge dimension.

After the zoom-scan measurement, extrapolations from the closest measured points to the surface, for example along lines parallel to the zoom-scan centerline, and interpolations to a finer resolution between all measured and extrapolated points are performed. Extrapolation algorithm considerations are described in 6.5.3, and 3-D spline methods (Brishoual et al., 2001; Kreyszig, 1983; Press et al., 1996) can be used for interpolation. The peak spatial-average SAR is finally determined by a numerical averaging of the local SAR values in the interpolation grid, using for example a trapezoidal algorithm for the integration (averaging).

In some areas of the phantom, such as the jaw and upper head regions, the angle of the probe with respect to the line normal to the surface may be relatively large, e.g., greater than $\pm 30^\circ$, which could increase the boundary effect error to a larger level. In these cases, during the zoom scan a change in the orientation of the probe, the phantom, or both is recommended but not required for the duration of

the zoom scan, so that the angle between the probe axis and the line normal to the surface is within 30° for all measurement points.

- **Power Drift measurement**

The robot re-measures the E-Field in the same reference location measured at the Power Reference. The drift measurement gives the field difference in dB from the first to the last reference reading. This allows a user to monitor the power drift of the device under test that must remain within a maximum variation of $\pm 5\%$.

- **Post-processing**

The procedure for spatial peak SAR evaluation has been implemented according to the IEEE1528 and IEC 62209-1/2 standards. It can be conducted for 1g and 10g.

The software allows evaluations that combine measured data and robot positions, such as:

- ✓ Maximum search
- ✓ Extrapolation
- ✓ Boundary correction
- ✓ Peak search for averaged SAR

Interpolation between the measured points is performed when the resolution of the grid is not fine enough to compute the average SAR over a given mass.

Extrapolation routines are used to obtain SAR values between the lowest measurement points and the inner phantom surface. The extrapolation is determined by the surface detection distance and the probe sensor offset. Several measurements at different distances are necessary for the extrapolation.

A.4 System and Liquid Check

A.4.1 System Check

The system performance check verifies that the system operates within its specifications. System and operator errors can be detected and corrected. It is recommended that the system performance check be performed prior to any usage of the system in order to guarantee reproducible results.

The system performance check uses normal SAR measurements in a simplified setup with a well characterized source. This setup was selected to give a high sensitivity to all parameters that might fail or vary over time. The system check does not intend to replace the calibration of the components, but indicates situations where the system uncertainty is exceeded due to drift or failure.

In the simplified setup for system check, the EUT is replaced by a calibrated dipole and the power source is replaced by a controlled continuous wave generated by a signal generator. The calibrated dipole must be placed beneath the flat phantom section of the phantom at the correct distance.

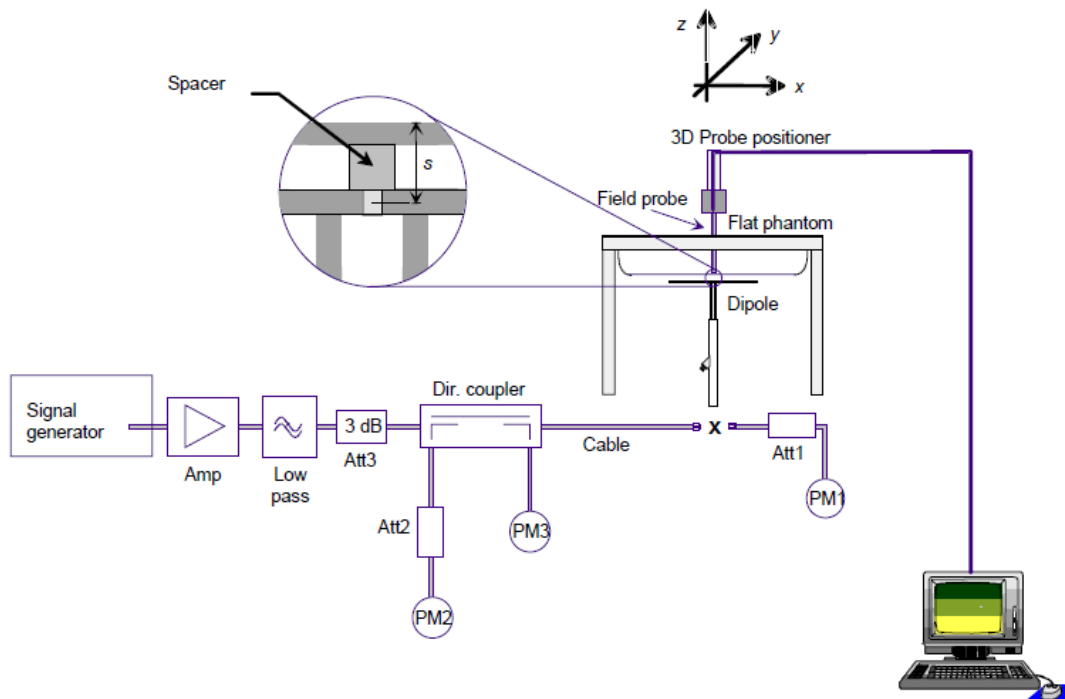

The equipment setup is shown below:

- ✓ Signal Generator
- ✓ Amplifier
- ✓ Directional coupler
- ✓ Power meter
- ✓ Calibrated dipole

First, the power meter PM1 (including attenuator Att1) is connected to the cable to measure the forward power at the location of the connector (x) to the system check source. The signal generator is adjusted for the desired forward power at the connector as read by power meter PM1 after attenuation Att1 and also as coupled through Att2 to PM2. After connecting the cable to the source, the signal generator is readjusted for the same reading at power meter PM2.

SAR results are normalized to a forward power of 1W to compare the values with the calibration reports results as described at IEEE 1528 and IEC 62209 standards.

A.4.2 Liquid Check

The dielectric parameters check is done prior to the use of the tissue simulating liquid. The verification is made by comparing the relative permittivity and conductivity to the values recommended by the applicable standards.

The liquid verification was performed using the following test setup:

- ✓ VNA (Vector Network Analyzer)
- ✓ Open-Short-Load calibration kit
- ✓ RF Cable
- ✓ Open-Ended Coaxial probe
- ✓ DAK software tool
- ✓ SAR Liquid
- ✓ De-ionized water
- ✓ Thermometer

These are the target dielectric properties of the tissue-equivalent liquid material as defined in FCC OET KDB 865664 D01.

Frequency (MHz)	Body SAR	
	ϵ_r	σ (S/m)
150	61.9	0.80
300	58.2	0.92
450	56.7	0.94
835	55.2	0.97
900	55.0	1.05
1450	54.0	1.30
1800-2000	53.3	1.52
2450	52.7	1.95
3000	52.0	2.73
5800	48.2	6.00

(ϵ_r = relative permittivity, σ = conductivity and ρ = 1000 kg/m³)

The measurement system implement a SAR error compensation algorithm as documented in IEEE Std 1528-2013 (equivalent to draft standard IEEE P1528-2011) to automatically compensate the measured SAR results for deviations between the measured and required tissue dielectric parameters (applied to only scale up the measured SAR, and not downward) so, according to FCC OET KDB 865664 D01, the tolerance for ϵ_r and σ may be relaxed to $\pm 10\%$.

A.5 Test Equipment List

SPEAG SAR System 1

ID	Device	Type/Model	Serial Number	Manufacturer	Calibration Date	Calibration Due
0260	Dosimetric E-field Probe	EX3DV4	7325	SPEAG	2015-12-11	2016-12-11
0418	Data Acquisition Electronics	DAE4	1496	SPEAG	2016-05-17	2017-05-17
0243	Electro-Optical Converter	EOC60	-	SPEAG	NA	NA
0229	Light Beam Unit	LB5 / 80	-	di-soric	NA	NA
0231	6-axis Robot	TX60 L	F12/5MZ3A1/A/01	STAÜBLI	NA	NA
0233	Robot Controller	CS8C	F12/5MZ3A1/C/01	STAÜBLI	NA	NA
0235	Measurement Server	DASY5 P/N: SE UMS 011 EA	1444	SPEAG	NA	NA
0221	SAM Phantom	Twin SAM v5.0	1838	SPEAG	NA	NA
0222	Oval Flat Phantom	ELI v5.0	1260	SPEAG	NA	NA
0217	Handset Positioner	P/N SD 000 H01 KA	-	SPEAG	NA	NA
0223	Measurement SW	DASY52	v52.8.8.1258	SPEAG	NA	NA
0225	Post processing SW	SEMCAD X	v14.6.10	SPEAG	NA	NA

Shared Instrumentation

ID	Device	Type/Model	Serial Number	Manufacturer	Calibration Date	Calibration Due
0398	Temperature & Humidity Logger	TR-72NW-H + HHA-3151	Logger: 62180216 / Sensor: 0202622A	TandD	2016-02-01	2018-02-01
0099	USB Power Sensor	NRP-Z81	102278	R&S	2015-09-10	2017-09-10
0098	USB Power Sensor	NRP-Z81	102279	R&S	2015-09-10	2017-09-10
0114	Vector Signal Generator	ESG E4438C	MY45092885	Agilent	NA	NA
0239	2450MHz System Validation Dipole	D2450V2	937	SPEAG	2016-06-22	2018-06-22
0124	5GHz System Validation Dipole	D5GHZv2	1164	SPEAG	2015-06-18	2017-06-18
0230	Vector Reflectometer	PLANAR R140	0131013	Copper Mountain Technologies	2015-08-03	2017-08-03
0237	Dielectric Probe Kit	DAKS-3.5	1037	SPEAG	2016-06-14	2018-06-14
0408	Thermometer	TESTO 922	33622932	Testo	2015-09-29	2017-09-29
0170	Power Amplifier	SAM-01	151922	ETS-Lindgren	NA	NA
0412	Coupler	CD0.5-8-20-30	1251-002	Amd-group	NA	NA

TSL	Manufacturer / Model	Freq Range (MHz)	Main Ingredients
Body WideBand	SPEAG MBBL600-6000V6 Batch 160630-01	600-6000	Ethenediol, Sodium petroleum sulfonate, Hexylene Glycol / 2-Methylpentane-2.4-diol, Alkoxyated alcohol

A.6 Measurement Uncertainty Evaluation

DASY5 Uncertainty Budget According to IEEE 1528-2013 and IEC 62209-1/2011 (3 - 6 GHz range)								
Error Description	Uncert. value	Prob. Dist.	Div.	(ci) 1g	(ci) 10g	Std. Unc. (1g)	Std. Unc. (10g)	(vi) v _{eff}
Measurement System								
Probe Calibration	±6.55 %	N	1	1	1	±6.55 %	±6.55 %	∞
Axial Isotropy	±4.7 %	R	√3	0.7	0.7	±1.9 %	±1.9 %	∞
Hemispherical Isotropy	±9.6 %	R	√3	0.7	0.7	±3.9 %	±3.9 %	∞
Boundary Effects	±2.0 %	R	√3	1	1	±1.2 %	±1.2 %	∞
Linearity	±4.7 %	R	√3	1	1	±2.7 %	±2.7 %	∞
System Detection Limits	±1.0 %	R	√3	1	1	±0.6 %	±0.6 %	∞
Modulation Responsem	±2.4 %	R	√3	1	1	±1.4 %	±1.4 %	∞
Readout Electronics	±0.3 %	N	1	1	1	±0.3 %	±0.3 %	∞
Response Time	±0.8 %	R	√3	1	1	±0.5 %	±0.5 %	∞
Integration Time	±2.6 %	R	√3	1	1	±1.5 %	±1.5 %	∞
RF Ambient Noise	±3.0 %	R	√3	1	1	±1.7 %	±1.7 %	∞
RF Ambient Reflections	±3.0 %	R	√3	1	1	±1.7 %	±1.7 %	∞
Probe Positioner	±0.8 %	R	√3	1	1	±0.5 %	±0.5 %	∞
Probe Positioning	±6.7 %	R	√3	1	1	±3.9 %	±3.9 %	∞
Max. SAR Eval.	±4.0 %	R	√3	1	1	±2.3 %	±2.3 %	∞
Test Sample Related								
Device Positioning	±2.9 %	N	1	1	1	±2.9 %	±2.9 %	145
Device Holder	±3.6 %	N	1	1	1	±3.6 %	±3.6 %	5
Power Drift	±5.0 %	R	√3	1	1	±2.9 %	±2.9 %	∞
Power Scalingp	±0.0 %	R	√3	1	1	±0.0 %	±0.0 %	∞
Phantom and Setup								
Phantom Uncertainty	±6.6 %	R	√3	1	1	±3.8 %	±3.8 %	∞
SAR correction	±1.9 %	R	√3	1	0.84	±1.1 %	±0.9 %	∞
Liquid Conductivity (mea.)DAK	±2.5 %	R	√3	0.78	0.71	±1.1 %	±1.0 %	∞
Liquid Permittivity (mea.) DAK	±2.5 %	R	√3	0.26	0.26	±0.3 %	±0.4 %	∞
Temp. unc. - Conductivity BB	±3.4 %	R	√3	0.78	0.71	±1.5 %	±1.4 %	∞
Temp. unc. - Permittivity BB	±0.4 %	R	√3	0.23	0.26	±0.1 %	±0.1 %	∞
Combined Std. Uncertainty						±12.3 %	±12.2 %	748
Expanded STD Uncertainty						±24.6 %	±24.5 %	

SPEAG System Uncertainty budget (IEEE 1528-2013 & IEC 62209-1:2011)

DASY5 Uncertainty Budget According to IEC 62209-2/2010 [3] (30 MHz - 6 GHz range)								
Error Description	Uncert. value	Prob. Dist.	Div.	(ci) 1g	(ci) 10g	Std. Unc. (1g)	Std. Unc. (10g)	(vi) v _{eff}
Measurement System								
Probe Calibration	±6.55 %	N	1	1	1	±6.55 %	±6.55 %	∞
Axial Isotropy	±4.7 %	R	√3	0.7	0.7	±1.9 %	±1.9 %	∞
Hemispherical Isotropy	±9.6 %	R	√3	0.7	0.7	±3.9 %	±3.9 %	∞
Linearity	±4.7 %	R	√3	1	1	±2.7 %	±2.7 %	∞
Modulation Response	±2.4 %	R	√3	1	1	±1.4 %	±1.4 %	∞
System Detection Limits	±1.0 %	R	√3	1	1	±0.6 %	±0.6 %	∞
Boundary Effects	±2.0 %	R	√3	1	1	±1.2 %	±1.2 %	∞
Readout Electronics	±0.3 %	N	1	1	1	±0.3 %	±0.3 %	∞
Response Time	±0.8 %	R	√3	1	1	±0.5 %	±0.5 %	∞
Integration Time	±2.6 %	R	√3	1	1	±1.5 %	±1.5 %	∞
RF Ambient Noise	±3.0 %	R	√3	1	1	±1.7 %	±1.7 %	∞
RF Ambient Reflections	±3.0 %	R	√3	1	1	±1.7 %	±1.7 %	∞
Probe Positioner	±0.8 %	R	√3	1	1	±0.5 %	±0.5 %	∞
Probe Positioning	±6.7 %	R	√3	1	1	±3.9 %	±3.9 %	∞
Post-processing	±4.0 %	R	√3	1	1	±2.3 %	±2.3 %	∞
Test Sample Related								
Device Holder	±3.6 %	N	1	1	1	±3.6 %	±3.6 %	5
Test sample Positioning	±2.9 %	N	1	1	1	±2.9 %	±2.9 %	145
Power Scaling	±0.0 %	R	√3	1	1	±0.0 %	±0.0 %	∞
Power Drift	±5.0 %	R	√3	1	1	±2.9 %	±2.9 %	∞
Phantom and Setup								
Phantom Uncertainty	±7.9 %	R	√3	1	1	±4.4 %	±4.4 %	∞
SAR correction	±1.9 %	R	√3	1	0.84	±1.1 %	±0.9 %	∞
Liquid Conductivity (mea.)DAK	±2.5 %	R	√3	0.78	0.71	±1.1 %	±1.0 %	∞
Liquid Permittivity (mea.) DAK	±2.5 %	R	√3	0.26	0.26	±0.3 %	±0.4 %	∞
Temp. unc. - Conductivity BB	±3.4 %	R	√3	0.78	0.71	±1.5 %	±1.4 %	∞
Temp. unc. - Permittivity BB	±0.4 %	R	√3	0.23	0.26	±0.1 %	±0.1 %	∞
Combined Std. Uncertainty						±12.5 %	±12.4 %	748
Expanded STD Uncertainty						±25.1 %	±25.0 %	

SPEAG System Uncertainty budget (IEC 62209-2:2010)

A.7 RF Exposure Limits

SAR assessments have been made in line with the requirements of FCC 47 CFR Part §2.1093 and RSS 102, Issue 5 on the limitation of exposure of the general population / uncontrolled exposure for portable devices.

Exposure Type	General Population / Uncontrolled Environment
Peak spatial-average SAR (averaged over any 1 gram of tissue)	1.6 W/kg
Whole body average SAR	0.08 W/kg
Peak spatial-average SAR (extremities) (averaged over any 10 grams of tissue)	4.0 W/kg

Annex B. Test Results

B.1 Test Conditions

B.1.1 SAR Test positions relative to the phantom

The device under test was an Intel® Dual-Band Wireless-AC 8265 card inside a 2 in 1 host platform convertible PC (P71G series) using a set of slot antennas. The card was operated utilizing proprietary software (DRTU version 1.8.9-03151) and each channel was measured using a broadband power meter to determine the maximum average power.

According to FCC OET KDB 616217 D04, the back surface and edges of the tablet should be tested for SAR compliance with the tablet touching the phantom. The SAR Test Exclusion Threshold in FCC OET KDB 447498 D01 v06 can be applied to determine SAR test exclusion for adjacent edge containing the antenna positioned perpendicular to the phantom. The closest distance from the antenna to an adjacent tablet edge is used to determine if SAR testing is required for the adjacent edges, with the adjacent edge positioned against the phantom and the edge containing the antenna positioned perpendicular to the phantom.

Considering the antenna location diagrams in *Annex F* and the test exclusions described before, the surfaces/edges to be measured for each antenna are:

Position	Distance	Antenna	
		Main	Aux
	0mm	<ul style="list-style-type: none"> • Back face • Bottom edge* 	<ul style="list-style-type: none"> • Back face • Bottom edge*

* When the device is in tablet mode position the bottom border of the screen is slightly longer than the keyboard side. Then in the case of bottom edge position, if the sample is placed totally vertical with the keyboard and back screen side totally attached together, the antenna edge located on the bottom of the screen side does not touch completely the phantom surface. Therefore the device was slightly opened to ensure the total contact of the screen edge with the phantom. Several SAR tests revealed that this open position is the worst case. See *Annex F* for more details.

See *B.1.3 Evaluation Exclusion and Test Reductions* for a more detailed list of the applied reductions.

B.1.2 Test signal, Output power and Test Frequencies

The device was put into operation by using an own control software (DRTU version 1.8.9-03151) to program the test mode required for select the continuous transmission with 100% duty cycle.

The output power of the device was set to transmit at maximum power for all tests.

B.1.3 Evaluation Exclusion and Test Reductions

SAR evaluation exclusion

The SAR Test Exclusion Threshold in FCC OET KDB 447498 D01 v06 can be applied to determine SAR test exclusion for adjacent edge configurations. For 100MHz to 6GHz and test separation distances ≤ 50 mm, the 1-g and 10-g SAR test exclusion thresholds are determined by the following formula:

$$\left[\frac{\text{(max. power of channel, including tune – up tolerance, mW)}}{\text{(min. test separation distance, mm)}} \right] \cdot \sqrt{f_{\text{(GHz)}}} \quad (1)$$

≤ 3.0 for 1g SAR, and ≤ 7.5 for 10g extremity SAR

Where:

- f (GHz) is the RF channel transmit frequency in GHz
- Power and distance are rounded to the nearest mW and mm before calculation
- The result is rounded to one decimal place for comparison
- The values 3.0 and 7.5 are referred to as numeric thresholds

The test exclusions are applicable only when the minimum test separation distance is ≤ 50 mm, and for transmission frequencies between 100 MHz and 6 GHz. When the minimum test separation distance is < 5 mm, a distance of 5 mm is applied to determine SAR test exclusion.

For test separation distances > 50 mm, the 1-g and 10-g SAR test exclusion thresholds are determined using the following formulas:

$$\left(\text{(Power allowed at numeric threshold for 50 mm in (1))} + (\text{test separation distance} - 50 \text{ mm}) \cdot (f_{\text{MHz}}/150) \right) \text{mW}, \quad (2)$$

for 100MHz to 1500MHz

$$\left(\text{(Power allowed at numeric threshold for 50 mm in (1))} + (\text{test separation distance} - 50 \text{ mm}) \cdot 10 \right) \text{mW}, \quad (3)$$

for 1500MHz and ≤ 6 GHz

LAN Antenna	Band Name	Output power		Back Face	Top Edge	Right Edge	Left Edge	Bottom Edge	Back Face	Top Edge	Right Edge	Left Edge	Bottom Edge
		dBm	mW										
WLAN Aux	DTS	15.0	31.6	≤ 50	>50	>50	>50	≤ 50	T	R	R	R	T
	UNII-1	13.5	22.4	≤ 50	>50	>50	>50	≤ 50	R	R	R	R	R
	UNII-2A	13.5	22.4	≤ 50	>50	>50	>50	≤ 50	T	R	R	R	T
	UNII-2C	13.5	22.4	≤ 50	>50	>50	>50	≤ 50	T	R	R	R	T
	UNII-3	13.5	22.4	≤ 50	>50	>50	>50	≤ 50	T	R	R	R	T
WLAN WPAN Main	DTS	15.0	31.6	≤ 50	>50	>50	>50	≤ 50	T	R	R	R	T
	UNII-1	13.5	22.4	≤ 50	>50	>50	>50	≤ 50	R	R	R	R	R
	UNII-2A	13.5	22.4	≤ 50	>50	>50	>50	≤ 50	T	R	R	R	T
	UNII-2C	13.5	22.4	≤ 50	>50	>50	>50	≤ 50	T	R	R	R	T
	UNII-3	13.5	22.4	≤ 50	>50	>50	>50	≤ 50	T	R	R	R	T
	BT	12.0	15.8	≤ 50	>50	>50	>50	≤ 50	T	R	R	R	T

T: Tested required

R: Reduced

See Annex F for a more detailed explanation of the separation distance related to the platform.

SAR test reduction

General SAR test reduction

According to FCC OET KDB 447498 D01, testing of other required channels within the operating mode of a frequency band is not required when the reported 1-g or 10-g SAR for the mid-band or highest output power channel is:

- ≤ 0.8 W/kg or 2.0 W/kg, for 1-g or 10-g respectively, when the transmission band is ≤ 100 MHz
- ≤ 0.6 W/kg or 1.5 W/kg, for 1-g or 10-g respectively, when the transmission band is between 100 MHz and 200 MHz
- ≤ 0.4 W/kg or 1.0 W/kg, for 1-g or 10-g respectively, when the transmission band is ≥ 200 MHz

WLAN SAR Test reduction

Transmission Mode	SAR test exclusion/reduction
DSSS	<p>According to FCC OET KDB 248227 D01, SAR is measured for 2.4 GHz 802.11b, SAR test reduction is determined according to the following:</p> <ul style="list-style-type: none"> ▪ When the reported SAR of the highest measured maximum output power channel for the exposure configuration is ≤ 0.8 W/kg, no further SAR testing is required for 802.11b DSSS in that exposure configuration. ▪ When the reported SAR is > 0.8 W/kg, SAR is required for that exposure configuration using the next highest measured output power channel. When any reported SAR is > 1.2 W/kg, SAR is required for the third channel. <p>According to FCC OET KDB 248227 D01, SAR is not required for 2.4 GHz OFDM conditions when the highest reported SAR for DSSS is adjusted by the ratio of OFDM to DSSS specified maximum output power and the adjusted SAR is ≤ 1.2 W/kg.</p>
OFDM	<p>According to FCC OET KDB 248227 D01, 802.11a/g/n/ac modes have the same specified maximum output power, largest channel bandwidth, lowest order modulation and lowest data rate, the lowest order 802.11 mode is selected; i.e., 802.11a is chosen over 802.11n then 802.11ac or 802.11g is chosen over 802.11n.</p> <p>According to FCC OET KDB 248227 D01, an <i>initial test configuration</i> is determined for OFDM and DSSS transmission modes according to the channel bandwidth, modulation and data rate combination(s) with the highest maximum output power specified for production units in each standalone and aggregated frequency band. SAR is measured using the highest measured maximum output power channel. SAR test reduction for subsequent highest output test channels is determined according to reported SAR of the initial test configuration.</p> <p>The <i>initial test configuration</i> for 5 GHz OFDM transmission modes is determined by the 802.11 configuration with the highest maximum output power specified for production units, including tune-up tolerance, in each standalone and aggregated frequency band. SAR for the initial test configuration is measured using the highest maximum output power channel determined by the default power measurement procedures.</p> <p>When the specified maximum output power is the same for both UNII-1 and UNII-2A, begin SAR measurement in UNII-2A and if the highest reported SAR for UNII-2A is ≤ 1.2W/kg, SAR is not required for UNII-1 if reported SAR is ≥ 1.2W/kg, both UNII-1 and UNII-2A shall be tested independently for SAR.</p> <p>According to FCC OET KDB 248227 D01, when the reported SAR of the initial test configuration is > 0.8 W/kg, SAR measurement is required for subsequent next highest measured output power channel(s) in the initial test configuration until reported SAR is ≤ 1.2 W/kg or all required channels are tested.</p>

B.2 Conducted Power Measurements

B.2.1 WLAN 2.4GHz (DTS)

Band	Mode	Data Rate	Ch #	Freq [MHz]	Avg Pwr [dBm]		Max output Pwr [dBm]	SAR Test?
					Main	Aux		
2.4GHz (DTS)	802.11b	1Mbps	1	2412	18.98	18.92	19.00	Yes
			6	2437	19.00	18.96	19.00	
			11	2462	18.98	18.93	19.00	
	802.11g	6Mbps	1	2412	NR ^{1,2}	NR ^{1,2}	19.00	No ²
			6	2437			19.00	
			11	2462			19.00	
	802.11n20	HT0	1	2412			19.00	
			6	2437			19.00	
			11	2462			19.00	
	802.11n40		3	2422			19.00	
			6	2437			19.00	
			9	2452			19.00	

Initial test configuration

1. NR: Not Required
2. As per FCC OET KDB 248227 D01, conducted output power and SAR testing are not required for 802.11g/n20/n40 channels when the highest reported SAR for DSSS is adjusted by the ratio of OFDM to DSSS specified maximum output power and the adjusted SAR is ≤ 1.2W/kg.

B.2.2 WLAN 5GHz (UNII)

5.2GHz and 5.3GHz (UNII-1 and UNII-2A)

Band	Mode	Data Rate	Ch #	Freq [MHz]	Main		Aux		SAR Test?
					Avg Pwr [dBm]	Max output Pwr [dBm]	Avg Pwr [dBm]	Max output Pwr [dBm]	
5.2GHz (UNII-1)	802.11a	6Mbps	36	5180	NR ¹	19.00	NR ¹	17.00	No ²
			40	5200		19.00		17.00	
			44	5220		19.00		17.00	
			48	5240		19.00		17.00	
	802.11n20	HT0	36	5180		19.00		17.00	
			40	5200		19.00		17.00	
			44	5220		19.00		17.00	
			48	5240		19.00		17.00	
	802.11n40		38	5190		19.00		17.00	
			46	5230		19.00		17.00	
	802.11ac80	VHT0	42	5210		19.00		17.00	

1. NR: Not Required
2. When the same maximum output power is specified for both bands, begin SAR measurement in U-NII-2A band by applying the OFDM SAR requirements. If the highest reported SAR for a test configuration is ≤ 1.2 W/kg, SAR is not required for U-NII-1 band (see §B.5.2 in this document).

Band	Mode	Data Rate	Ch #	Freq [MHz]	Main		Aux		SAR Test?			
					Avg Pwr [dBm]	Max output Pwr [dBm]	Avg Pwr [dBm]	Max output Pwr [dBm]				
5.3GHz (UNII-2A)	802.11a	6Mbps	52	5260	NR ^{1,2}	19.00	NR ^{1,2}	17.00	No ⁴			
			56	5280		19.00		17.00				
			60	5300		19.00		17.00				
			64	5320		19.00		17.00				
	802.11n20	HT0	52	5260		19.00		17.00				
			56	5280		19.00		17.00				
			60	5300		19.00		17.00				
			64	5320		19.00		17.00				
	802.11n40		54	5270		18.99		19.00		16.94	17.00	Yes
			62	5310		19.00		19.00		17.00	17.00	
	802.11ac80	VHT0	58	5290		18.99		19.00		17.00	17.00	

Initial test configuration

1. NR: Not Required
2. When multiple transmission modes (802.11a/g/n/ac) have the same specified maximum output power, largest channel bandwidth, lowest order modulation and lowest data rate, lowest order 802.11 mode is selected (i.e. a, g, n, then ac)
3. When the specified maximum output power is the same for both UNII-1 and UNII-2A, begin SAR measurement in UNII-2A and if the highest reported SAR for UNII-2A is
 - ≤1.2W/kg, SAR is not required for UNII-1
 - ≥1.2W/kg, both UNII-1 and UNII-2A shall be tested independently for SAR
4. When the reported SAR of the initial test configuration is > 0.8W/kg, SAR measurement is required for the subsequent next highest measured output power channel(s) in the initial test configuration until reported SAR is ≤1.2W/kg or all required channels are tested.

5.6GHz (UNII-2C)

Band	Mode	Data Rate	Ch #	Freq [MHz]	Main		Aux		SAR Test?
					Avg Pwr [dBm]	Max output Pwr [dBm]	Avg Pwr [dBm]	Max output Pwr [dBm]	
5.6GHz (UNII-2C)	802.11a	6Mbps	100	5500	NR ¹	17.00	NR ¹	15.00	No ⁵
			104	5520		17.00		15.00	
			108	5540		17.00		15.00	
			112	5560		17.00		15.00	
			116	5580		17.00		15.00	
			120	5600		17.00		15.00	
			124	5620		17.00		15.00	
			128	5640		17.00		15.00	
	802.11n20	HT0	100	5500	NR ¹	17.00	NR ¹	15.00	
			104	5520		17.00		15.00	
			108	5540		17.00		15.00	
			112	5560		17.00		15.00	
			116	5580		17.00		15.00	
			120	5600		17.00		15.00	
			124	5620		17.00		15.00	
			128	5640		17.00		15.00	
	802.11n40	HT0	102	5510	17.00	17.00	14.96	15.00	
			110	5550	17.00	17.00	15.00	15.00	
			118	5590	16.96	17.00	15.00	15.00	
			126	5630	16.96	17.00	15.00	15.00	
802.11ac80	VHT0	106	5530	16.97	17.00	15.00	15.00	Yes	
		122	5610	16.99	17.00	15.00	15.00		

Initial test configuration

1. NR: Not Required
2. When band gap channels between UNII-2C and UNII-3 band are supported channels in UNII-2C band below 5.65 GHz are considered as one band and channels above 5.65 GHz, together with channels in 5.8 GHz U-NII-3 or §15.247 band, are considered as a separate band
3. Additional conducted power measurement is required when reported SAR is > 1.2W/kg. In case the subsequent test configuration and the channel bandwidth is smaller than the initial test configuration, all channels that overlap with the larger channel bandwidth in the initial configuration should be tested
4. When multiple transmission modes (802.11a/g/n/ac) have the same specified maximum output power, largest channel bandwidth, lowest order modulation and lowest data rate, lowest order 802.11 mode is selected (i.e. a, g, n, then ac)
5. When the reported SAR of the initial test configuration is > 0.8W/kg, SAR measurement is required for the subsequent next highest measured output power channel(s) in the initial test configuration until reported SAR is ≤1.2W/kg or all required channels are tested.

5.8GHz (UNII-3)

Band	Mode	Data Rate	Ch #	Freq [MHz]	Main		Aux		SAR Test?	
					Avg Pwr [dBm]	Max output Pwr [dBm]	Avg Pwr [dBm]	Max output Pwr [dBm]		
5.6-5.8GHz (UNII-3)	802.11a	6Mbps	132	5660	17.00	17.00	NR ³	15.00	Yes	
			136	5680	16.97	17.00		15.00		
			140	5700	17.00	17.00		15.00		
			149	5745	15.97	16.00		14.50		
			153	5765	16.00	16.00		14.50		
			157	5785	15.96	16.00		14.50		
			161	5805	15.92	16.00		14.50		
			165	5825	15.97	16.00		14.50		
	802.11n20	HT0	132	5660	17.00	17.00		15.00		
			136	5680	16.95	17.00		15.00		
			140	5700	17.00	17.00		15.00		
			149	5745	15.99	16.00		14.50		
			153	5765	15.95	16.00		14.50		
			157	5785	15.99	16.00		14.50		
			161	5805	16.00	16.00		14.50		
			165	5825	15.95	16.00		14.50		
	802.11n40		134	5670	16.95	17.00		15.00		15.00
			151	5755	15.96	16.00		14.49		14.50
			159	5795	15.95	16.00		14.49		14.50
	802.11ac80	VHT0	138	5690	16.98	17.00		15.00		15.00
155			5775	16.00	16.00	14.49	14.50			

Initial test configuration

1. NR: Not Required
2. When band gap channels between UNII-2C and UNII-3 band are supported channels in UNII-2C band below 5.65 GHz are considered as one band and channels above 5.65 GHz, together with channels in 5.8 GHz U-NII-3 or §15.247 band, are considered as a separate band
3. Additional conducted power measurement is required when reported SAR is > 1.2W/kg. In case the subsequent test configuration and the channel bandwidth is smaller than the initial test configuration, all channels that overlap with the larger channel bandwidth in the initial configuration should be tested
4. When multiple transmission modes (802.11a/g/n/ac) have the same specified maximum output power, largest channel bandwidth, lowest order modulation and lowest data rate, lowest order 802.11 mode is selected (i.e. a, g, n, then ac)
5. When the reported SAR of the initial test configuration is > 0.8W/kg, SAR measurement is required for the subsequent next highest measured output power channel(s) in the initial test configuration until reported SAR is ≤1.2W/kg or all required channels are tested

B.2.3 Bluetooth

Band	Mode	Data Rate	Channel	Frequency (MHz)	Antenna	Avg Pwr [dBm]	Max output Pwr [dBm]
2.4GHz	Bluetooth v4.2	Basic rate GFSK	0	2402	Main	10.10	12
			39	2441		11.04	12
			78	2480		10.19	12
	Bluetooth v4.2	Basic rate $\pi/4$ DQPSK	0	2402		NR ¹	9
			39	2441			9
			78	2480			9
	Bluetooth v4.2	Basic rate 8-DPSK	0	2402			9
			39	2441			9
			78	2480			9
	Bluetooth v4.2	Low energy GFSK	0	2412			5
			20	2437			5
			39	2480			5

Initial test configuration

1. NR: Not Required

B.3 Tissue Parameters Measurement

Body TSL

Freq. (MHz)	Target Parameters		Measured TSL Parameters		Deviation (%)		Date
	ϵ'	σ	ϵ'	σ	ϵ'	σ	
2450	52.70	1.95	51.57	2.11	-2.15	8.22	2016/10/04
5300	48.88	5.41	46.04	5.63	-5.81	-4.05	2016/10/04
5600	48.47	5.76	45.44	6.06	-6.25	-4.86	2016/10/04
5800	48.20	6.00	45.02	6.35	-6.59	5.90	2016/10/04

See *Annex D* more details.

B.4 System Check Measurements

Body Measurements

Frequency (MHz)	Average	Target SAR (W/g)	Measured SAR (W/g)	Deviation to target (%)	Limit (%)	Date
2450	1g	49.40	54.27	9.87	±10	2016/10/04
	10g	23.40	25.04	7.02		
5300	1g	75.60	82.42	9.03		
	10g	21.20	22.87	7.87		
5600	1g	78.20	85.03	8.73		
	10g	21.70	23.68	9.12		
5800	1g	76.20	75.92	-0.36		
	10g	21.70	20.85	-3.91		

See *Annex C* for more details.

B.5 SAR Test Results

B.5.1 802.11b/g/n – 2.4GHz - DTS

Ant.	Mode Data rate	BW (MHz)	Ch #	Freq (MHz)	Position	Correct. Factor (dB)	SAR 1g (W/kg)	Reported SAR 1g (W/kg)	Plot #
Main	802.11b 1Mbps	20	6	2437	Back Face	0.00	0.60	0.60	1
					Bottom Edge	0.00	0.54	0.45	
Aux			6	2437	Back Face	0.04	0.45	0.45	2
					Bottom Edge	0.04	0.45	0.45	

B.5.2 802.11a/n/ac – 5.3 GHz – UNII-2A

Ant.	Mode Data rate	BW (MHz)	Ch #	Freq (MHz)	Position	Correct. Factor (dB)	SAR 1g (W/kg)	Reported SAR 1g (W/kg)	Plot #
Main	VHT0	80	58	5290	Back Face	0.01	0.90	0.90	3
					Bottom Edge	0.01	1.10	1.10	
	HT0	40	62	5310	Back Face	0.00	0.98	0.98	
					Bottom Edge	0.00	1.09	1.09	
Aux	VHT0	80	58	5290	Back Face	0.00	0.30	0.30	
					Bottom Edge	0.00	0.95	0.95	4
	HT0	40	62	5310	Bottom Edge	0.00	0.79	0.79	

B.5.3 802.11a/n/ac – 5.6 GHz – UNII-2C

Ant.	Mode Data rate	BW (MHz)	Ch #	Freq (MHz)	Position	Correct. Factor (dB)	SAR 1g (W/kg)	Reported SAR 1g (W/kg)	Plot #
Main	VHT0	80	122	5610	Back Face	0.01	0.18	0.18	5
					Bottom Edge	0.01	1.16	1.16	
			106	5530	Bottom Edge	0.03	1.02	1.03	
Aux	VHT0	80	122	5610	Back Face	0.00	0.07	0.07	6
					Bottom Edge	0.00	0.79	0.79	

B.5.4 802.11a/n/ac – 5.8 GHz – UNII-3

Ant	Mode Data rate	BW (MHz)	Ch #	Freq (MHz)	Position	Correct. Factor (dB)	SAR 1g (W/kg)	Reported SAR 1g (W/kg)	Plot #		
Main	VHT0	80	138	5690	Back Face	0.02	0.09	0.09			
					Bottom Edge	0.02	1.47	1.48	7		
	HT0	40	134	5670	Bottom Edge	0.05	1.32	1.34			
					151	5755	Bottom Edge	0.04	1.14	1.15	
	802.11a 6Mbps	20	132	5660	Bottom Edge	0.00	1.37	1.37			
					136	5680	Bottom Edge	0.03	1.37	1.38	
					140	5700	Bottom Edge	0.00	1.38	1.38	
					153	5765	Bottom Edge	0.00	1.19	1.19	
	HT0	20	132	5660	Bottom Edge	0.00	1.13	1.13			
					140	5700	Bottom Edge	0.00	1.18	1.18	
Aux	VHT0	80	138	5690	Back Face	0.00	0.07	0.07			
					Bottom Edge	0.00	1.16	1.16	8		
					155	5775	Bottom Edge	0.01	1.10	1.10	

B.5.5 Bluetooth – 2.4GHz - DSSS

Mode Data rate	BW (MHz)	Ch #	Freq (MHz)	Position	Correct.Factor (dB)	SAR 1g (W/kg)	Reported SAR 1g (W/kg)	Plot #
802.15 DH5	20	39	2441	Back Face	0.96	0.06	0.08	9
				Bottom Edge	0.96	0.06	0.08	

B.6 SAR Measurement Variability

According to FCC OET KDB 865664, SAR Measurement variability is assessed when the maximum initial measured SAR is >0.8 W/kg for a certain band/mode. If the measured SAR value of the initial repeated measurement is <1.45 W/kg with $<20\%$ variation, only one repeated measurement is required to confirm that the results are not expected to have substantial variations.

A second repeated measurement is required only if the measured results for the initial repeated measurement are within 10% of the SAR limit or vary by more than 20%.

Band / Mode	Position	Ch #	Freq. (MHz)	Measured SAR 1g (W/kg)	1 st Repeated SAR 1g (W/Kg)	Highest Ratio
5.3GHz 802.11ac80 VHT0	Bottom Edge	58	5290	1.10	1.03	1.06
5.6GHz 802.11ac80 VHT0	Bottom Edge	138	5690	1.43	1.47	1.02
5.8GHz 802.11a 6Mbps	Bottom Edge	140	5700	1.38	1.29	1.07

B.7 Simultaneous Transmission SAR Evaluation

According to FCC OET KDB 447498 D01, when the sum of 1g SAR for all simultaneously transmitting antennas in an operating mode and exposure condition combination is within the SAR limit, SAR test exclusion applies to that simultaneous transmission configuration.

All the values stated in the table below are the worst case found for standalone measurement with disregard of the transmission mode or channel where the worst case was found

Antenna	Position	Highest Reported SAR (1g)		
		WLAN 2.4GHz	WLAN 5GHz	Bluetooth
Main	Back Face	0.60	0.98	0.08
	Bottom Edge	0.54	1.48	0.08
Aux	Back Face	0.45	0.30	
	Bottom Edge	0.45	1.16	

Position	Simultaneous Tx Antenna Combination		Σ SAR 1g (W/Kg)	Limit (W/kg)
	Aux Antenna	Main Antenna		
Back Face	WLAN 2.4GHz	WLAN 2.4GHz	1.05	1.6
	WLAN 5GHz	WLAN 5GHz	1.28	
	WLAN 5GHz	WLAN 5GHz + BT	1.36	
	WLAN 2.4GHz	BT	0.53	
	WLAN 5GHz	BT	0.38	
Bottom Edge	WLAN 2.4GHz	WLAN 2.4GHz	0.99	
	WLAN 5GHz	WLAN 5GHz	2.64	
	WLAN 5GHz	WLAN 5GHz + BT	2.72	
	WLAN 2.4GHz	BT	0.53	
	WLAN 5GHz	BT	1.24	

In case the sum of SAR is larger than the limit, SAR test exclusion is determined by the SAR to peak location separation ratio according to FCC OET KDB 447498 D01.

Position	Antenna	Reported SAR 1g (W/kg)	Σ SAR 1g (W/Kg)	Peak Location (cm) (x,y,z)	SAR to peak location separation ratio	Limit
Bottom Edge	Main WLAN 5GHz	1.48	2.64	Max. 4 at (0.66, 6.38, -0.40) cm	0.03	0.04
	Aux WLAN 5GHz	1.16		Max. 2 at (0.50, -6.32, -0.39) cm		
Bottom Edge *	Main WLAN 5GHz	1.48	2.72	Max. 4 at (0.66, 6.38, -0.40) cm	0.04	0.04
	Main BT	0.08		Max. 1 at (-1.38, 3.58, -0.43) cm		
	Aux WLAN 5GHz	1.16		Max. 2 at (0.50, -6.32, -0.39) cm		

* For this case, the worst case for simultaneous SAR to peak location separation ratio calculation was made considering the sum of 3 SAR results and the closest maxima distance between main and aux antenna (i.e. the closest distance between the peak location between Main WLAN to Aux WLAN and Main BT to Aux WLAN).

Annex C. Test System Plots

1. DTS - 802.11b, CH6, Main Antenna – Back Face	34
2. DTS - 802.11b, CH6, Aux Antenna – Back Face	35
3. UNII-2A - 802.11ac80, CH58, Main Antenna – Bottom Edge	36
4. UNII-2A - 802.11ac80, CH58, Aux Antenna – Bottom Edge	37
5. UNII-2C - 802.11ac80, CH122, Main Antenna – Bottom Edge	38
6. UNII-2C - 802.11ac80, CH122, Aux Antenna – Bottom Edge	39
7. UNII-3 - 802.11ac80, CH138, Main Antenna – Bottom Edge	40
8. UNII-3 - 802.11ac80, CH138, Aux Antenna – Bottom Edge	41
9. BT - 802.15, CH39, Aux Antenna – Back Face	42
10. System Check Body Liquid 2450MHz	43
11. System Check Body Liquid 5300MHz	44
12. System Check Body Liquid 5600MHz	45
13. System Check Body Liquid 5800MHz	46

1. DTS - 802.11b, CH6, Main Antenna – Back Face

Test Laboratory: Intel WRF Lab; Date/Time: 2016/10/04 5:10:49 PM

DUT: DELL P71G; Type: Convertible PC; Serial: 34.13.E8.59.DA.70

Communication System: UID 0, 802.11 (0); Communication System Band: 2.4GHz; Frequency: 2437 MHz; Communication System PAR: 0 dB
 Medium parameters used (interpolated): $f = 2437$ MHz; $\sigma = 2.098$ S/m; $\epsilon_r = 51.588$; $\rho = 1000$ kg/m³
 Phantom section: Flat Section
 Measurement Standard: DASYS5 (IEEE/IEC/ANSI C63.19-2011)

DASY Configuration:

- Probe: EX3DV4 - SN7325; ConvF(7.41, 7.41, 7.41); Calibrated: 2015/12/11;
 - Modulation Compensation:
- Sensor-Surface: 4mm (Mechanical Surface Detection), Sensor-Surface: 2mm (Mechanical Surface Detection), $z = -39.0, 25.0$
- Electronics: DAE4 Sn1496; Calibrated: 2016/05/17
- Phantom: ELI v5.0 (30deg probe tilt); Type: QDOVA002BA;
- DASYS5 52.8.8(1222);

2.4GHz_Back_Face/DTS_802.11b_CH6-2437MHz_Back-Face_MAIN/Area Scan (51x71x1):

Interpolated grid: $dx=1.200$ mm, $dy=1.200$ mm

Maximum value of SAR (interpolated) = 0.626 W/kg

2.4GHz_Back_Face/DTS_802.11b_CH6-2437MHz_Back-Face_MAIN/Zoom Scan (7x7x7)/Cube 0:

Measurement grid: $dx=5$ mm, $dy=5$ mm, $dz=5$ mm

Reference Value = 17.11 V/m; Power Drift = -0.04 dB

Peak SAR (extrapolated) = 1.25 W/kg

SAR(1 g) = 0.600 W/kg; SAR(10 g) = 0.287 W/kg (SAR corrected for target medium)

Maximum value of SAR (measured) = 0.895 W/kg

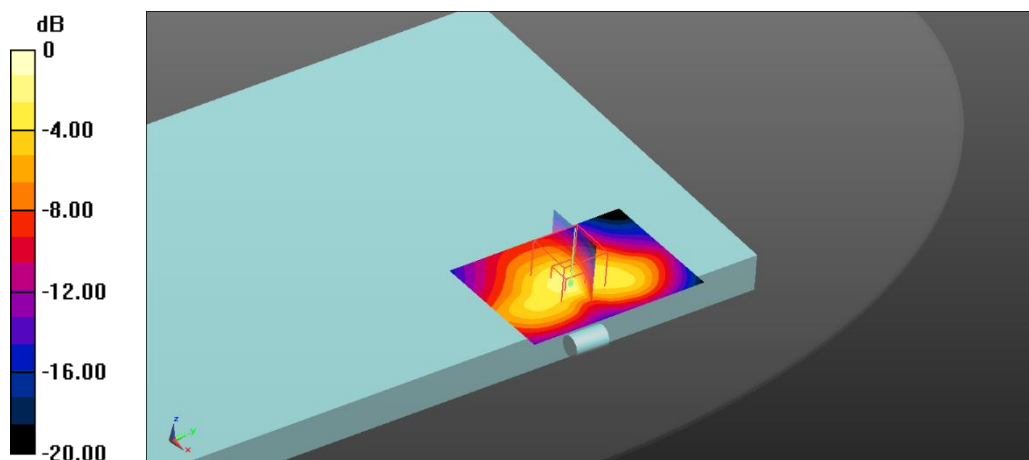

0 dB = 0.895 W/kg = -0.48 dBW/kg

2. DTS - 802.11b, CH6, Aux Antenna – Back Face

Test Laboratory: Intel WRF Lab; Date/Time: 2016/10/04 4:37:27 PM

DUT: DELL P71G; Type: Convertible PC; Serial: 34.13.E8.59.DA.70

Communication System: UID 0, 802.11 (0); Communication System Band: 2.4GHz; Frequency: 2437 MHz; Communication System PAR: 0 dB
 Medium parameters used (interpolated): $f = 2437$ MHz; $\sigma = 2.098$ S/m; $\epsilon_r = 51.588$; $\rho = 1000$ kg/m³
 Phantom section: Flat Section
 Measurement Standard: DASYS5 (IEEE/IEC/ANSI C63.19-2011)

DASY Configuration:

- Probe: EX3DV4 - SN7325; ConvF(7.41, 7.41, 7.41); Calibrated: 2015/12/11;
 - Modulation Compensation:
- Sensor-Surface: 4mm (Mechanical Surface Detection), $z = -25.0$
- Electronics: DAE4 Sn1496; Calibrated: 2016/05/17
- Phantom: ELI v5.0 (30deg probe tilt); Type: QDOVA002BA;
- DASYS5 52.8.8(1222);

2.4GHz Bottom Edge and Back Face/DTS 802.11b CH6-2437MHz Back-Face Aux/Area Scan (51x71x1): Interpolated grid: $dx=1.200$ mm, $dy=1.200$ mm

Maximum value of SAR (interpolated) = 0.473 W/kg

2.4GHz Bottom Edge and Back Face/DTS 802.11b CH6-2437MHz Back-Face Aux/Zoom Scan (7x7x7)/Cube 0: Measurement grid: $dx=5$ mm, $dy=5$ mm, $dz=5$ mm

Reference Value = 14.77 V/m; Power Drift = 0.05 dB

Peak SAR (extrapolated) = 0.902 W/kg

SAR(1 g) = 0.449 W/kg; SAR(10 g) = 0.217 W/kg (SAR corrected for target medium)

Maximum value of SAR (measured) = 0.524 W/kg

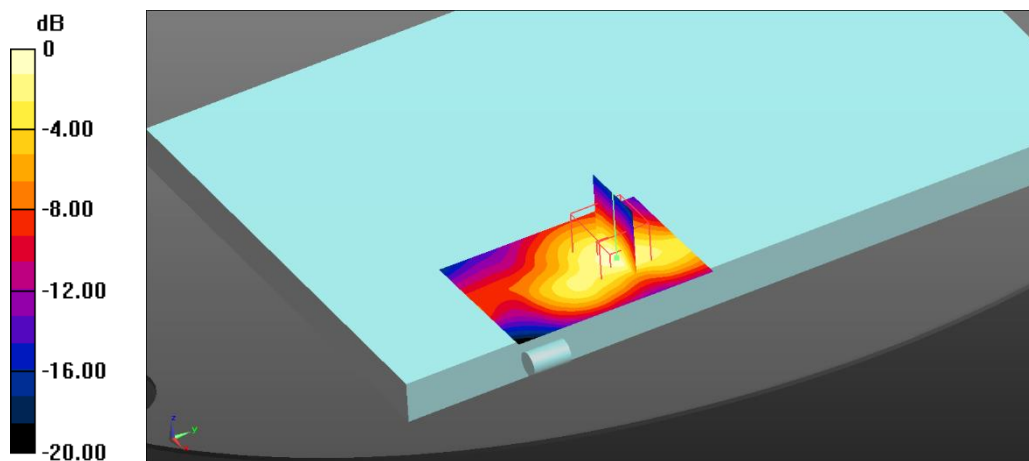

0 dB = 0.524 W/kg = -2.81 dBW/kg

3. UNII-2A - 802.11ac80, CH58, Main Antenna – Bottom Edge

Test Laboratory: Intel WRF Lab; Date/Time: 2016/10/04 12:03:08 PM

DUT: DELL P71G; Type: Convertible PC; Serial: 34.13.E8.59.DA.70

Communication System: UID 0, 802.11 (0); Communication System Band: 5GHz; Frequency: 5290 MHz; Communication System PAR: 0 dB
 Medium parameters used: $f = 5290$ MHz; $\sigma = 5.621$ S/m; $\epsilon_r = 46.058$; $\rho = 1000$ kg/m³
 Phantom section: Flat Section
 Measurement Standard: DASYS (IEEE/IEC/ANSI C63.19-2011)

DASY Configuration:

- Probe: EX3DV4 - SN7325; ConvF(4.21, 4.21, 4.21); Calibrated: 2015/12/11;
 - Modulation Compensation:
- Sensor-Surface: 2mm (Mechanical Surface Detection), $z = -9.0, 25.0$
- Electronics: DAE4 Sn1496; Calibrated: 2016/05/17
- Phantom: ELI v5.0 (30deg probe tilt); Type: QDOVA002BA;
- DASYS 52.8.8(1222);

5.3GHz_Bottom_Edge/UNII-2A_802.11ac80_CH58-5290MHz_Botom-Edge_Main B Tx1 3 2/Area Scan (51x101x1): Interpolated grid: $dx=1.000$ mm, $dy=1.000$ mm
 Maximum value of SAR (interpolated) = 2.11 W/kg

5.3GHz_Bottom_Edge/UNII-2A_802.11ac80_CH58-5290MHz_Botom-Edge_Main B Tx1 3 2/Zoom Scan 2 (7x7x12)/Cube 0: Measurement grid: $dx=4$ mm, $dy=4$ mm, $dz=2$ mm
 Reference Value = 16.57 V/m; Power Drift = 0.22 dB
 Peak SAR (extrapolated) = 4.75 W/kg
SAR(1 g) = 1.1 W/kg; SAR(10 g) = 0.352 W/kg (SAR corrected for target medium)

Maximum value of SAR (measured) = 2.25 W/kg

5.3GHz_Bottom_Edge/UNII-2A_802.11ac80_CH58-5290MHz_Botom-Edge_Main B Tx1 3 2/Zoom Scan 2 (7x7x12)/Cube 1: Measurement grid: $dx=4$ mm, $dy=4$ mm, $dz=2$ mm
 Reference Value = 16.57 V/m; Power Drift = 0.22 dB
 Peak SAR (extrapolated) = 5.42 W/kg
SAR(1 g) = 0.941 W/kg; SAR(10 g) = 0.305 W/kg (SAR corrected for target medium)

Maximum value of SAR (measured) = 2.03 W/kg

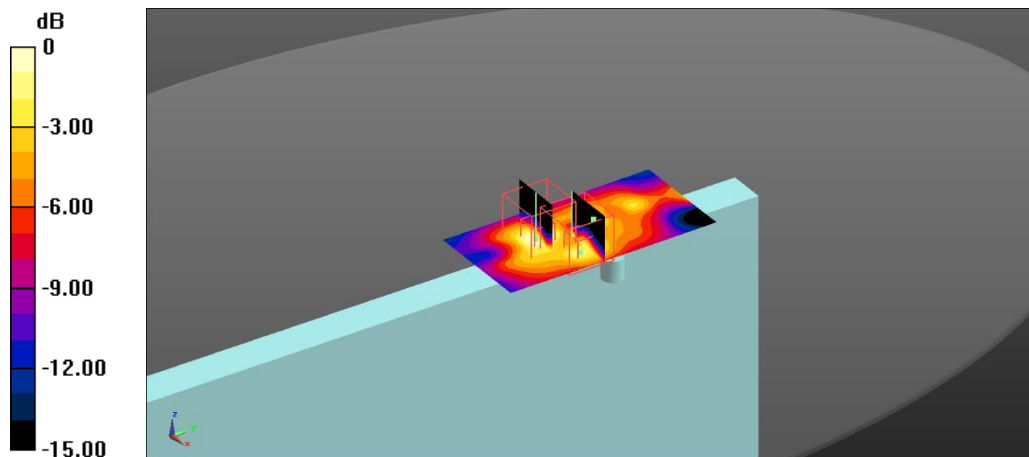

0 dB = 2.03 W/kg = 3.07 dBW/kg

4. UNII-2A - 802.11ac80, CH58, Aux Antenna – Bottom Edge

Test Laboratory: Intel WRF Lab; Date/Time: 2016/10/04 12:40:19 PM

DUT: DELL P71G; Type: Convertible PC; Serial: 34.13.E8.59.DA.70

Communication System: UID 0, 802.11 (0); Communication System Band: 5GHz; Frequency: 5290 MHz; Communication System PAR: 0 dB
 Medium parameters used: $f = 5290$ MHz; $\sigma = 5.621$ S/m; $\epsilon_r = 46.058$; $\rho = 1000$ kg/m³
 Phantom section: Flat Section
 Measurement Standard: DASYS5 (IEEE/IEC/ANSI C63.19-2011)

DASY Configuration:

- Probe: EX3DV4 - SN7325; ConvF(4.21, 4.21, 4.21); Calibrated: 2015/12/11;
 - Modulation Compensation:
- Sensor-Surface: 2mm (Mechanical Surface Detection), $z = -9.0, 25.0$
- Electronics: DAE4 Sn1496; Calibrated: 2016/05/17
- Phantom: ELI v5.0 (30deg probe tilt); Type: QDOVA002BA;
- DASYS5 52.8.8(1222);

5.3GHz Bottom Edge and Back Face/UNII-2A_802.11ac80_CH58-5270MHz_Botom-Edge_Aux A Tx2/Area Scan (41x91x1): Interpolated grid: $dx=1.000$ mm, $dy=1.000$ mm
 Maximum value of SAR (interpolated) = 1.47 W/kg

5.3GHz Bottom Edge and Back Face/UNII-2A_802.11ac80_CH58-5270MHz_Botom-Edge_Aux A Tx2/Zoom Scan 2 (8x8x12): Measurement grid: $dx=4$ mm, $dy=4$ mm, $dz=2$ mm
 Reference Value = 11.88 V/m; Power Drift = 0.08 dB
 Peak SAR (extrapolated) = 4.15 W/kg
SAR(1 g) = 0.946 W/kg; SAR(10 g) = 0.263 W/kg (SAR corrected for target medium)
 Maximum value of SAR (measured) = 2.13 W/kg

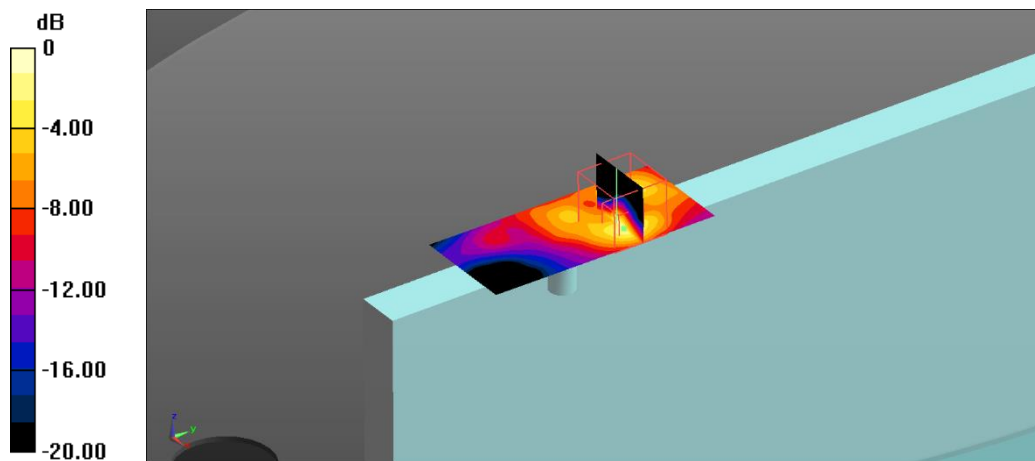

0 dB = 2.13 W/kg = 3.28 dBW/kg

5. UNII-2C - 802.11ac80, CH122, Main Antenna – Bottom Edge

Test Laboratory: Intel WRF Lab; Date/Time: 2016/10/06 10:10:45 AM

DUT: DELL P71G; Type: Type: Convertible PC; Serial: 34.13.E8.59.DA.70

Communication System: UID 0, 802.11 (0); Communication System Band: 5GHz; Frequency: 5610 MHz; Communication System PAR: 0 dB
 Medium parameters used: $f = 5610$ MHz; $\sigma = 6.073$ S/m; $\epsilon_r = 45.418$; $\rho = 1000$ kg/m³
 Phantom section: Flat Section
 Measurement Standard: DASYS5 (IEEE/IEC/ANSI C63.19-2011)

DASY Configuration:

- Probe: EX3DV4 - SN7325; ConvF(3.57, 3.57, 3.57); Calibrated: 2015/12/11;
 - Modulation Compensation:
- Sensor-Surface: 2mm (Mechanical Surface Detection), $z = -9.0, 25.0$
- Electronics: DAE4 Sn1496; Calibrated: 2016/05/17
- Phantom: ELI v5.0 (30deg probe tilt); Type: QDOVA002BA;
- DASYS52 52.8.8(1222);

5.6GHz_Bottom_Edge /UNII-2C_802.11ac80_CH122-5610MHz_Botom-Edge_Main B Tx1 3 2/Area Scan (51x101x1): Interpolated grid: $dx=1.000$ mm, $dy=1.000$ mm
 Maximum value of SAR (interpolated) = 2.23 W/kg

5.6GHz_Bottom_Edge /UNII-2C_802.11ac80_CH122-5610MHz_Botom-Edge_Main B Tx1 3 2/Zoom Scan 2 (7x7x12)/Cube 0: Measurement grid: $dx=4$ mm, $dy=4$ mm, $dz=2$ mm
 Reference Value = 15.65 V/m; Power Drift = -0.41 dB
 Peak SAR (extrapolated) = 5.77 W/kg
SAR(1 g) = 1.16 W/kg; SAR(10 g) = 0.303 W/kg (SAR corrected for target medium)

Maximum value of SAR (measured) = 2.69 W/kg

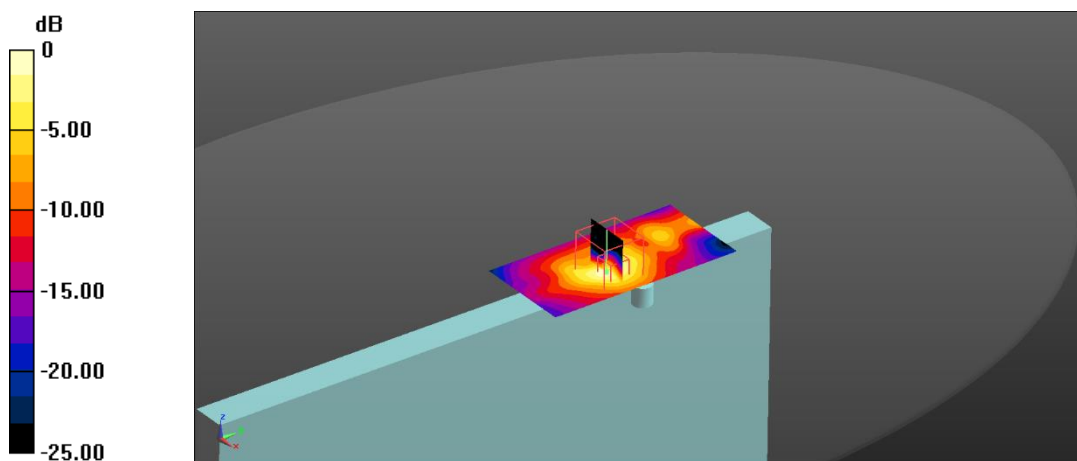

0 dB = 2.69 W/kg = 4.30 dBW/kg

6. UNII-2C - 802.11ac80, CH122, Aux Antenna – Bottom Edge

Test Laboratory: Intel WRF Lab; Date/Time: 2016/10/06 10:45:40 AM

DUT: DELL P71G; Type: Type: Convertible PC; Serial: 34.13.E8.59.DA.70

Communication System: UID 0, 802.11 (0); Communication System Band: 5GHz; Frequency: 5610 MHz; Communication System PAR: 0 dB
 Medium parameters used: $f = 5610$ MHz; $\sigma = 6.073$ S/m; $\epsilon_r = 45.418$; $\rho = 1000$ kg/m³
 Phantom section: Flat Section
 Measurement Standard: DASYS (IEEE/IEC/ANSI C63.19-2011)

DASY Configuration:

- Probe: EX3DV4 - SN7325; ConvF(3.57, 3.57, 3.57); Calibrated: 2015/12/11;
 - Modulation Compensation:
- Sensor-Surface: 2mm (Mechanical Surface Detection (Locations From Previous Scan Used)), Sensor-Surface: 2mm (Mechanical Surface Detection), $z = -9.0, 25.0$
- Electronics: DAE4 Sn1496; Calibrated: 2016/05/17
- Phantom: ELI v5.0 (30deg probe tilt); Type: QDOVA002BA;
- DASYS52 52.8.8(1222);

5.6GHz_Bottom_Edge /UNII-2C_802.11ac80_CH122-5610MHz_Botom-Edge_Aux A Tx2 2/Area Scan (41x91x1): Interpolated grid: $dx=1.000$ mm, $dy=1.000$ mm
 Maximum value of SAR (interpolated) = 1.10 W/kg

5.6GHz_Bottom_Edge /UNII-2C_802.11ac80_CH122-5610MHz_Botom-Edge_Aux A Tx2 2/Zoom Scan 2 (9x9x12)/Cube 0: Measurement grid: $dx=4$ mm, $dy=4$ mm, $dz=2$ mm
 Reference Value = 19.77 V/m; Power Drift = -0.01 dB
 Peak SAR (extrapolated) = 3.94 W/kg
SAR(1 g) = 0.785 W/kg; SAR(10 g) = 0.197 W/kg (SAR corrected for target medium)
 Maximum value of SAR (measured) = 1.82 W/kg

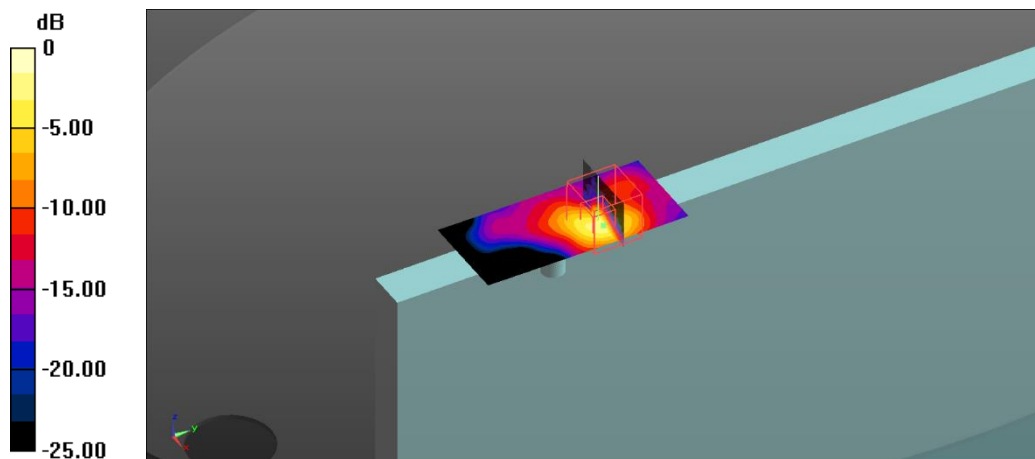

0 dB = 1.82 W/kg = 2.60 dBW/kg

7. UNII-3 - 802.11ac80, CH138, Main Antenna – Bottom Edge

Test Laboratory: Intel WRF Lab; Date/Time: 2016/10/06 11:08:47 AM

DUT: DELL P71G; Type: Type: Convertible PC; Serial: 34.13.E8.59.DA.70

Communication System: UID 0, 802.11 (0); Communication System Band: 5GHz; Frequency: 5690 MHz; Communication System PAR: 0 dB
 Medium parameters used: $f = 5690$ MHz; $\sigma = 6.193$ S/m; $\epsilon_r = 45.257$; $\rho = 1000$ kg/m³
 Phantom section: Flat Section
 Measurement Standard: DASYS5 (IEEE/IEC/ANSI C63.19-2011)

DASY Configuration:

- Probe: EX3DV4 - SN7325; ConvF(3.57, 3.57, 3.57); Calibrated: 2015/12/11;
 - Modulation Compensation:
- Sensor-Surface: 2mm (Mechanical Surface Detection), $z = -9.0, 25.0$
- Electronics: DAE4 Sn1496; Calibrated: 2016/05/17
- Phantom: ELI v5.0 (30deg probe tilt); Type: QDOVA002BA;
- DASYS52 52.8.8(1222);

Variability_Bottom_Edge/UNII-3_802.11ac80_CH138-5690MHz_Botom-Edge_Main B Tx1/Area Scan (51x101x1): Interpolated grid: $dx=1.000$ mm, $dy=1.000$ mm
 Maximum value of SAR (interpolated) = 1.87 W/kg

Variability_Bottom_Edge/UNII-3_802.11ac80_CH138-5690MHz_Botom-Edge_Main B Tx1/Zoom Scan 2 (7x7x12)/Cube 0: Measurement grid: $dx=4$ mm, $dy=4$ mm, $dz=2$ mm
 Reference Value = 26.18 V/m; Power Drift = 0.09 dB
 Peak SAR (extrapolated) = 8.00 W/kg
SAR(1 g) = 1.47 W/kg; SAR(10 g) = 0.380 W/kg (SAR corrected for target medium)

Maximum value of SAR (measured) = 3.45 W/kg

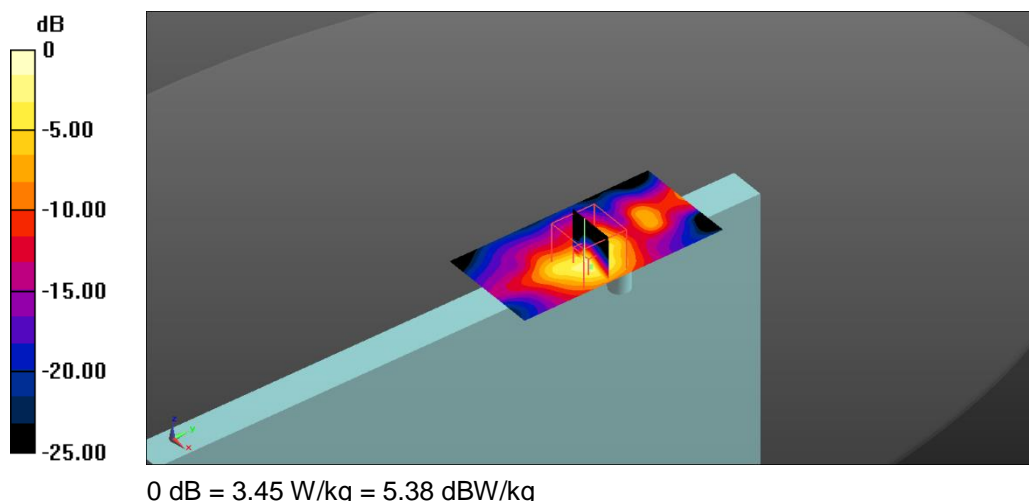

8. UNII-3 - 802.11ac80, CH138, Aux Antenna – Bottom Edge

Test Laboratory: Intel WRF Lab; Date/Time: 2016/10/06 11:25:52 AM

DUT: DELL P71G; Type: Type: Convertible PC; Serial: 34.13.E8.59.DA.70

Communication System: UID 0, 802.11 (0); Communication System Band: 5GHz; Frequency: 5690 MHz; Communication System PAR: 0 dB
 Medium parameters used: $f = 5690$ MHz; $\sigma = 6.193$ S/m; $\epsilon_r = 45.257$; $\rho = 1000$ kg/m³
 Phantom section: Flat Section
 Measurement Standard: DASYS5 (IEEE/IEC/ANSI C63.19-2011)

DASY Configuration:

- Probe: EX3DV4 - SN7325; ConvF(3.57, 3.57, 3.57); Calibrated: 2015/12/11;
 - Modulation Compensation:
- Sensor-Surface: 2mm (Mechanical Surface Detection), $z = -9.0, 25.0$
- Electronics: DAE4 Sn1496; Calibrated: 2016/05/17
- Phantom: ELI v5.0 (30deg probe tilt); Type: QDOVA002BA;
- DASYS5 52.8.8(1222);

5.8GHz_Bottom_Edge /UNII-3_802.11ac80_CH138-5690MHz_Botom-Edge_Aux A Tx2/Area Scan (41x91x1): Interpolated grid: $dx=1.000$ mm, $dy=1.000$ mm
 Maximum value of SAR (interpolated) = 1.62 W/kg

5.8GHz_Bottom_Edge /UNII-3_802.11ac80_CH138-5690MHz_Botom-Edge_Aux A Tx2/Zoom Scan 2 (9x9x12)/Cube 0: Measurement grid: $dx=4$ mm, $dy=4$ mm, $dz=2$ mm
 Reference Value = 12.31 V/m; Power Drift = -0.38 dB
 Peak SAR (extrapolated) = 6.29 W/kg
SAR(1 g) = 1.16 W/kg; SAR(10 g) = 0.273 W/kg (SAR corrected for target medium)
 Maximum value of SAR (measured) = 2.88 W/kg

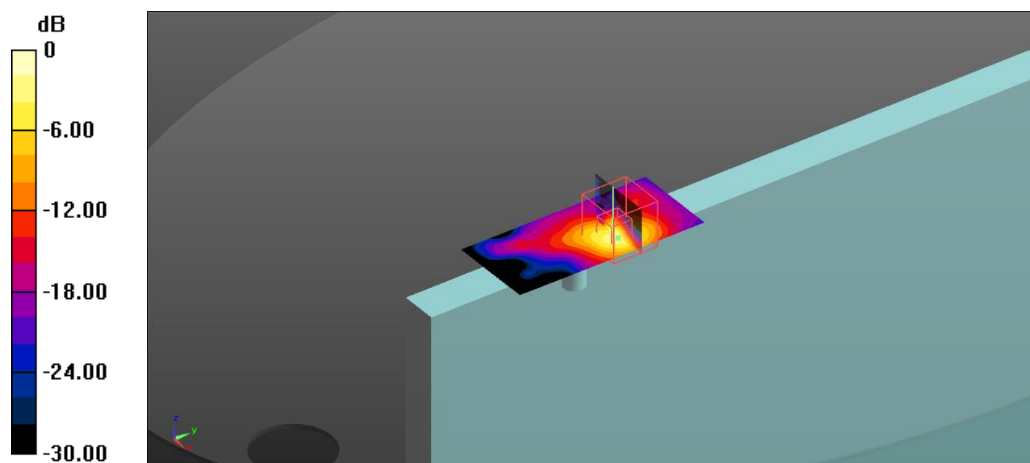

0 dB = 2.88 W/kg = 4.59 dBW/kg

9. BT - 802.15, CH39, Aux Antenna – Back Face

Test Laboratory: Intel WRF Lab; Date/Time: 2016/10/04 1:57:22 PM

DUT: DELL71G; Type: Type: Convertible PC; Serial: 34.13.E8.59.DA.6C

Communication System: UID 0, 802.15 (0); Communication System Band: 2.4GHZ; Frequency: 2441 MHz; Communication System PAR: 1.133 dB
 Medium parameters used (interpolated): $f = 2441$ MHz; $\sigma = 2.102$ S/m; $\epsilon_r = 51.581$; $\rho = 1000$ kg/m³
 Phantom section: Flat Section
 Measurement Standard: DASYS5 (IEEE/IEC/ANSI C63.19-2011)

DASY Configuration:

- Probe: EX3DV4 - SN7325; ConvF(7.41, 7.41, 7.41); Calibrated: 2015/12/11;
 - Modulation Compensation:
- Sensor-Surface: 4mm (Mechanical Surface Detection), $z = -25.0$
- Electronics: DAE4 Sn1496; Calibrated: 2016/05/17
- Phantom: ELI v5.0 (30deg probe tilt); Type: QDOVA002BA;
- DASYS52 52.8.8(1222);

2.4GHz_Back_Face/BT_802.15_CH39-2441MHz_Back-Face_Aux 2/Area Scan 2 2 2 (51x91x1):
 Interpolated grid: $dx=1.200$ mm, $dy=1.200$ mm

Maximum value of SAR (interpolated) = 0.0836 W/kg

2.4GHz_Back_Face/BT_802.15_CH39-2441MHz_Back-Face_Aux 2/Zoom Scan 2 2 (7x7x7)/Cube 0: Measurement grid: $dx=5$ mm, $dy=5$ mm, $dz=5$ mm
 Reference Value = 5.176 V/m; Power Drift = 0.03 dB
 Peak SAR (extrapolated) = 0.156 W/kg
SAR(1 g) = 0.062 W/kg; SAR(10 g) = 0.027 W/kg (SAR corrected for target medium)

Maximum value of SAR (measured) = 0.0855 W/kg

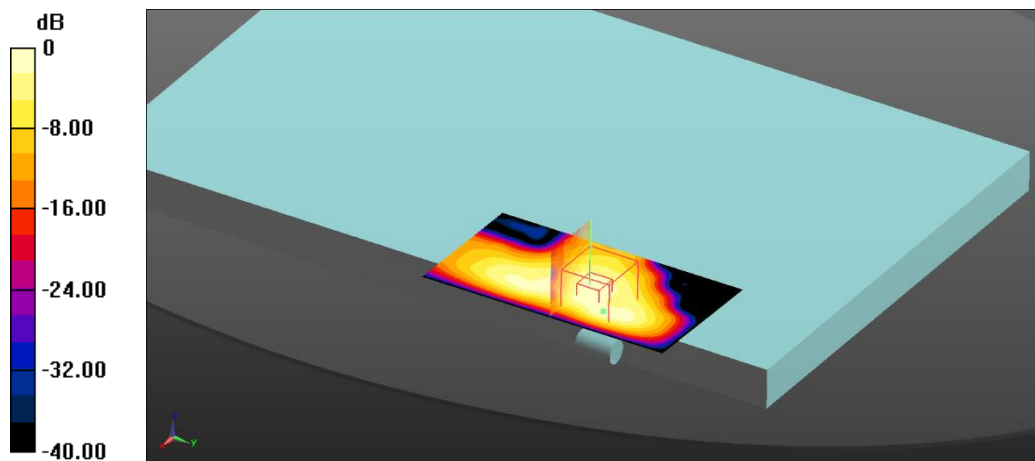

0 dB = 0.0855 W/kg = -10.68 dBW/kg

10. System Check Body Liquid 2450MHz

Test Laboratory: Intel WRF Lab; Date/Time: 2016/10/04 1:32:53 PM

DUT: Dipole 2450 MHz D2450V2; Type: D2450V2; Serial: D2450V2 - SN: 0937

Communication System: UID 0, CW (0); Communication System Band: D2450 (2450.0 MHz);
 Frequency: 2450 MHz; Communication System PAR: 0 dB
 Medium parameters used: $f = 2450$ MHz; $\sigma = 2.11$ S/m; $\epsilon_r = 51.566$; $\rho = 1000$ kg/m³
 Phantom section: Flat Section
 Measurement Standard: DASYS (IEEE/IEC/ANSI C63.19-2011)

DASY Configuration:

- Probe: EX3DV4 - SN7325; ConvF(7.41, 7.41, 7.41); Calibrated: 2015/12/11;
 - Modulation Compensation:
- Sensor-Surface: 4mm (Mechanical Surface Detection), $z = -14.0, 31.0$
- Electronics: DAE4 Sn1496; Calibrated: 2016/05/17
- Phantom: ELI v5.0 (30deg probe tilt); Type: QDOVA002BA;
- DASYS 52.8.8(1222);

WLAN-2.4GHz/System check 2450MHz/Area Scan (81x81x1): Interpolated grid: $dx=1.200$ mm, $dy=1.200$ mm
 Maximum value of SAR (interpolated) = 6.39 W/kg

WLAN-2.4GHz/System check 2450MHz/Zoom Scan (7x7x7)/Cube 0: Measurement grid: $dx=5$ mm, $dy=5$ mm, $dz=5$ mm
 Reference Value = 54.53 V/m; Power Drift = 0.04 dB
 Peak SAR (extrapolated) = 11.1 W/kg
SAR(1 g) = 5.44 W/kg; SAR(10 g) = 2.51 W/kg (SAR corrected for target medium)
 Maximum value of SAR (measured) = 6.24 W/kg

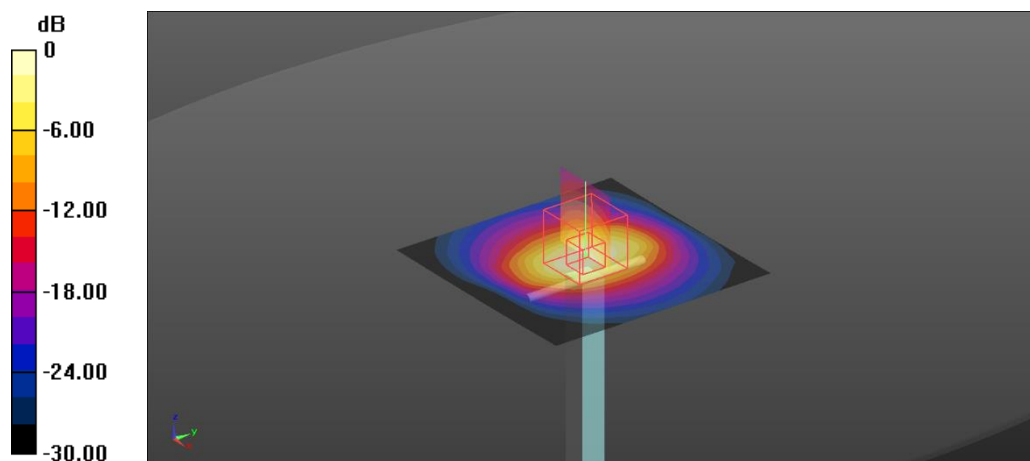

0 dB = 6.24 W/kg = 7.95 dBW/kg

11. System Check Body Liquid 5300MHz

Test Laboratory: Intel WRF Lab; Date/Time: 2016/10/04 5:20:24 PM

DUT: Dipole D5GHzV2; Type: D5GHzV2; Serial: D5GHzV2 - SN: 1164

Communication System: UID 0, CW (0); Communication System Band: D5GHz (5000.0 - 6000.0 MHz); Frequency: 5300 MHz; Communication System PAR: 0 dB
 Medium parameters used: $f = 5300$ MHz; $\sigma = 5.635$ S/m; $\epsilon_r = 46.037$; $\rho = 1000$ kg/m³
 Phantom section: Flat Section
 Measurement Standard: DASYS (IEEE/IEC/ANSI C63.19-2011)

DASY Configuration:

- Probe: EX3DV4 - SN7325; ConvF(4.21, 4.21, 4.21); Calibrated: 2015/12/11;
 - Modulation Compensation:
- Sensor-Surface: 2mm (Mechanical Surface Detection (Locations From Previous Scan Used)), Sensor-Surface: 2mm (Mechanical Surface Detection), $z = 1.0, 23.0$
- Electronics: DAE4 Sn1496; Calibrated: 2016/05/17
- Phantom: ELI v5.0 (30deg probe tilt); Type: QDOVA002BA;
- DASYS52 52.8.8(1222);

WLAN-5GHz/System Check 5300MHz 2/Area Scan (81x81x1): Interpolated grid: $dx=1.000$ mm, $dy=1.000$ mm
 Maximum value of SAR (interpolated) = 16.9 W/kg

WLAN-5GHz/System Check 5300MHz 2/Zoom Scan (9x9x12)/Cube 0: Measurement grid: $dx=4$ mm, $dy=4$ mm, $dz=2$ mm
 Reference Value = 59.34 V/m; Power Drift = -0.18 dB
 Peak SAR (extrapolated) = 35.0 W/kg
SAR(1 g) = 8.29 W/kg; SAR(10 g) = 2.3 W/kg (SAR corrected for target medium)
 Maximum value of SAR (measured) = 17.4 W/kg

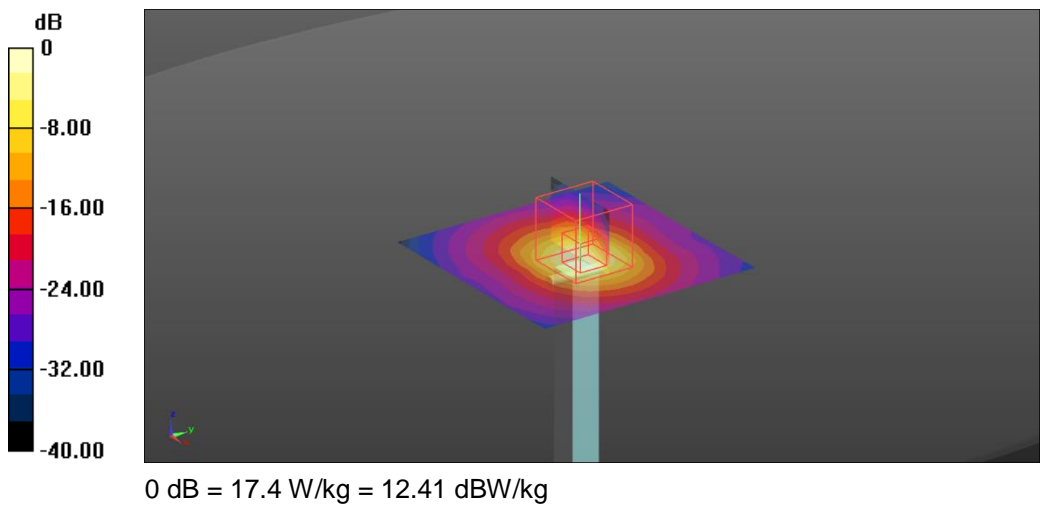

12. System Check Body Liquid 5600MHz

Test Laboratory: Intel WRF Lab; Date/Time: 2016/10/06 9:39:25 AM

DUT: Dipole D5GHzV2; Type: D5GHzV2; Serial: D5GHzV2 - SN: 1164

Communication System: UID 0, CW (0); Communication System Band: D5GHz (5000.0 - 6000.0 MHz); Frequency: 5600 MHz; Communication System PAR: 0 dB
 Medium parameters used: $f = 5600$ MHz; $\sigma = 6.057$ S/m; $\epsilon_r = 45.435$; $\rho = 1000$ kg/m³
 Phantom section: Flat Section
 Measurement Standard: DASy5 (IEEE/IEC/ANSI C63.19-2011)

DASY Configuration:

- Probe: EX3DV4 - SN7325; ConvF(3.57, 3.57, 3.57); Calibrated: 2015/12/11;
 - Modulation Compensation:
- Sensor-Surface: 2mm (Mechanical Surface Detection), $z = 1.0, 23.0$
- Electronics: DAE4 Sn1496; Calibrated: 2016/05/17
- Phantom: ELI v5.0 (30deg probe tilt); Type: QDOVA002AA;
- DASy52 52.8.8(1222);

WLAN-5.6GHz/System check 5600MHz/Area Scan (81x81x1): Interpolated grid: $dx=1.000$ mm, $dy=1.000$ mm
 Maximum value of SAR (interpolated) = 19.1 W/kg

WLAN-5.6GHz/System check 5600MHz/Zoom Scan 2 (7x7x12)/Cube 0: Measurement grid: $dx=4$ mm, $dy=4$ mm, $dz=2$ mm
 Reference Value = 63.26 V/m; Power Drift = 0.09 dB
 Peak SAR (extrapolated) = 35.7 W/kg
SAR(1 g) = 8.51 W/kg; SAR(10 g) = 2.37 W/kg (SAR corrected for target medium)
 Maximum value of SAR (measured) = 18.3 W/kg

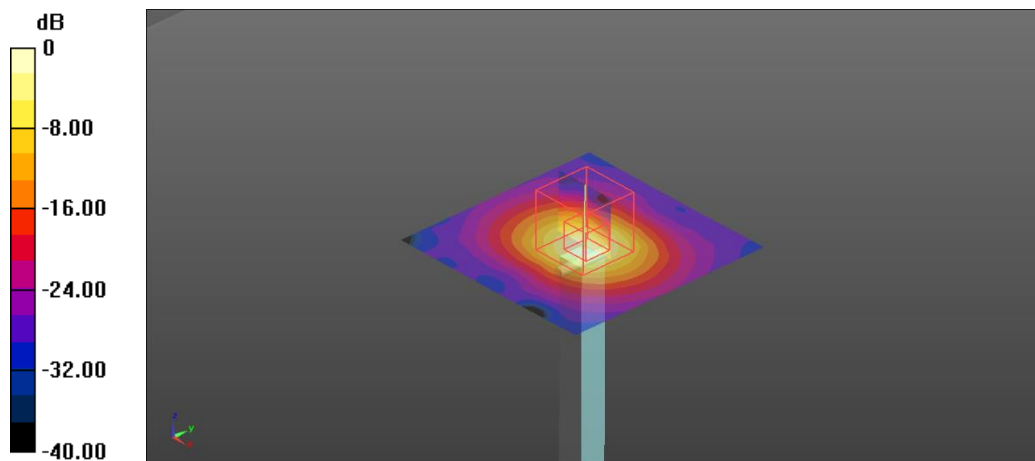

0 dB = 18.3 W/kg = 12.62 dBW/kg

13. System Check Body Liquid 5800MHz

Test Laboratory: Intel WRF Lab; Date/Time: 2016/10/05 18:31:16 PM

DUT: Dipole D5GHzV2; Type: D5GHzV2; Serial: D5GHzV2 - SN: 1164

Communication System: UID 0, CW (0); Communication System Band: D5GHz (5000.0 - 6000.0 MHz); Frequency: 5800 MHz; Communication System PAR: 0 dB
 Medium parameters used: $f = 5800$ MHz; $\sigma = 6.365$ S/m; $\epsilon_r = 45.025$; $\rho = 1000$ kg/m³
 Phantom section: Flat Section
 Measurement Standard: DASYS (IEEE/IEC/ANSI C63.19-2011)

DASY Configuration:

- Probe: EX3DV4 - SN7325; ConvF(3.83, 3.83, 3.83); Calibrated: 2015/12/11;
 - Modulation Compensation:
- Sensor-Surface: 2mm (Mechanical Surface Detection), $z = 1.0, 23.0$
- Electronics: DAE4 Sn1496; Calibrated: 2016/05/17
- Phantom: ELI v5.0 (30deg probe tilt); Type: QDOVA002BA;
- DASYS52 52.8.8(1222);

WLAN-5GHz_10-4-2016/System check 5800MHz/Area Scan (81x81x1): Interpolated grid: $dx=1.000$ mm, $dy=1.000$ mm
 Maximum value of SAR (interpolated) = 16.2 W/kg

WLAN-5GHz_10-4-2016/System check 5800MHz/Zoom Scan (7x7x12)/Cube 0: Measurement grid: $dx=4$ mm, $dy=4$ mm, $dz=2$ mm
 Reference Value = 56.91 V/m; Power Drift = -0.16 dB
 Peak SAR (extrapolated) = 32.8 W/kg
SAR(1 g) = 7.61 W/kg; SAR(10 g) = 2.09 W/kg (SAR corrected for target medium)

Maximum value of SAR (measured) = 15.9 W/kg

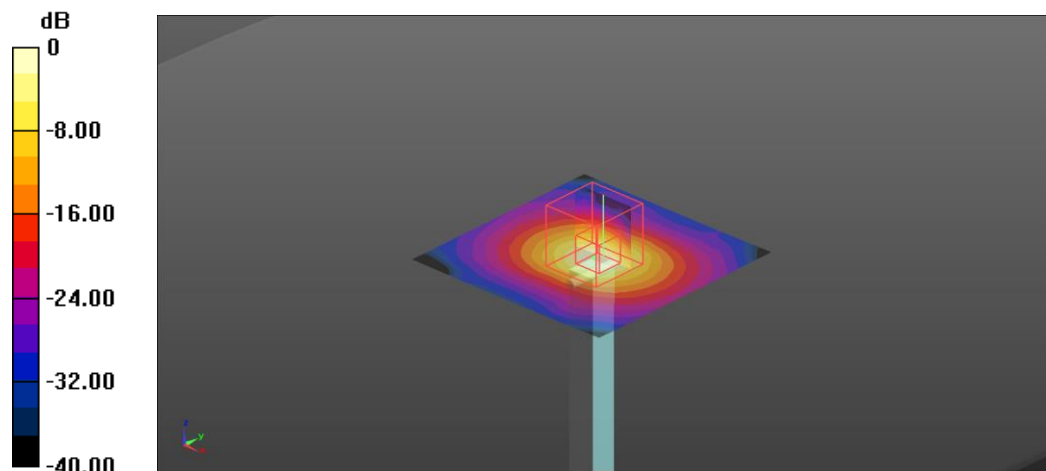

0 dB = 15.9 W/kg = 12.01 dBW/kg

Annex D. TSL Dielectric Parameters

Body DTS 2450MHz

Freq. (MHz)	Target		2016/10/04 Measured	
	ϵ'	σ	ϵ'	σ
	2400	52.77	1.90	51.65
2410	52.75	1.91	51.63	2.07
2420	52.74	1.92	51.62	2.08
2430	52.73	1.93	51.60	2.09
2440	52.71	1.94	51.58	2.10
2450	52.70	1.95	51.57	2.11
2460	52.69	1.96	51.55	2.12
2470	52.67	1.98	51.53	2.13
2480	52.66	1.99	51.52	2.14
2490	52.65	2.01	51.50	2.15
2500	52.64	2.02	51.48	2.16

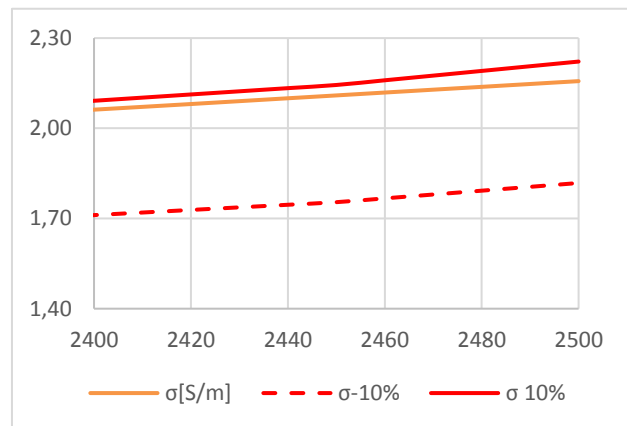
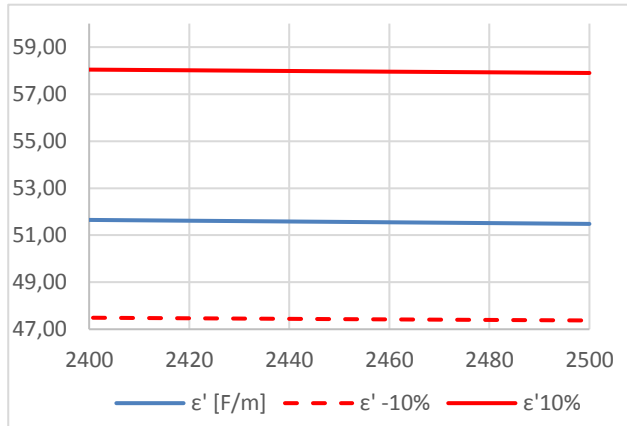

Body UNII-2A 5300MHz

Freq. (MHz)	Target		2016/10/04	
			Measured	
	ϵ'	σ	ϵ'	σ
5000	49.29	5.06	46.63	5.21
5010	49.27	5.08	46.61	5.23
5020	49.26	5.09	46.59	5.24
5030	49.25	5.10	46.57	5.25
5040	49.23	5.11	46.55	5.27
5050	49.22	5.12	46.53	5.28
5060	49.20	5.13	46.51	5.30
5070	49.19	5.15	46.49	5.31
5080	49.18	5.16	46.46	5.32
5090	49.16	5.17	46.44	5.34
5100	49.15	5.18	46.42	5.35
5110	49.14	5.19	46.40	5.36
5120	49.12	5.20	46.38	5.38
5130	49.11	5.22	46.36	5.39
5140	49.10	5.23	46.34	5.41
5150	49.08	5.24	46.32	5.42
5160	49.07	5.25	46.31	5.44
5170	49.06	5.26	46.29	5.45
5180	49.04	5.27	46.27	5.46
5190	49.03	5.29	46.24	5.48
5200	49.01	5.30	46.22	5.49
5210	49.00	5.31	46.20	5.51
5220	48.99	5.32	46.19	5.52
5230	48.97	5.33	46.17	5.53
5240	48.96	5.34	46.15	5.55
5250	48.95	5.36	46.13	5.56
5260	48.93	5.37	46.11	5.58
5270	48.92	5.38	46.09	5.59
5280	48.91	5.39	46.08	5.60
5290	48.89	5.40	46.06	5.62
5300	48.88	5.41	46.04	5.63
5310	48.87	5.43	46.02	5.65
5320	48.85	5.44	46.00	5.66
5330	48.84	5.45	45.98	5.68
5340	48.82	5.46	45.96	5.69
5350	48.81	5.47	45.94	5.70
5360	48.80	5.48	45.92	5.72
5370	48.78	5.50	45.90	5.73
5380	48.77	5.51	45.88	5.75
5390	48.76	5.52	45.86	5.76
5400	48.74	5.53	45.84	5.78

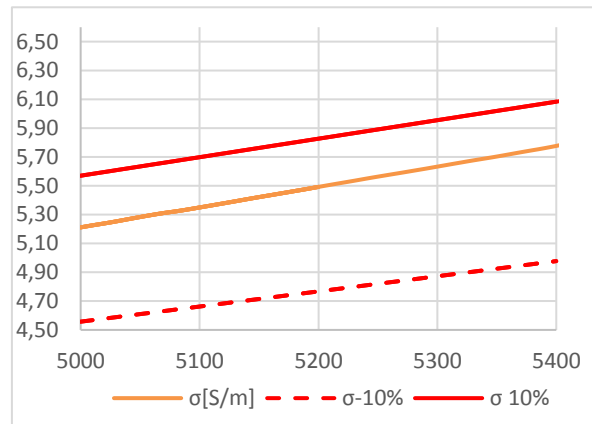
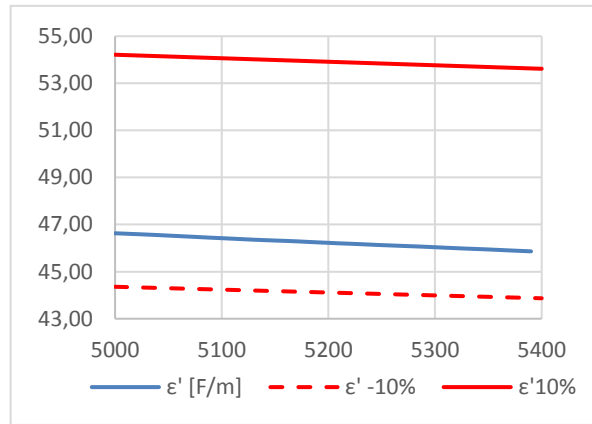

Body UNII-2C 5600MHz

Freq. (MHz)	Target		2016/10/04 Measured	
	ϵ'	σ	ϵ'	σ
	5410	48.73	5.54	45.82
5420	48.72	5.54	45.80	5.80
5430	48.70	5.56	45.79	5.82
5440	48.69	5.57	45.77	5.83
5450	48.68	5.58	45.75	5.84
5460	48.66	5.59	45.73	5.86
5470	48.65	5.60	45.70	5.87
5480	48.63	5.61	45.68	5.89
5490	48.62	5.63	45.65	5.90
5500	48.61	5.64	45.63	5.92
5510	48.59	5.65	45.61	5.93
5520	48.58	5.66	45.59	5.95
5530	48.57	5.67	45.58	5.96
5540	48.55	5.68	45.56	5.98
5550	48.54	5.70	45.53	5.99
5560	48.53	5.71	45.52	6.01
5570	48.51	5.72	45.50	6.02
5580	48.50	5.73	45.48	6.03
5590	48.49	5.74	45.46	6.05
5600	48.47	5.75	45.44	6.06
5610	48.46	5.77	45.42	6.07
5620	48.44	5.78	45.40	6.09
5630	48.43	5.79	45.38	6.11
5640	48.42	5.80	45.36	6.12
5650	48.40	5.81	45.34	6.13
5660	48.39	5.82	45.32	6.14
5670	48.38	5.84	45.30	6.15
5680	48.36	5.85	45.28	6.17
5690	48.35	5.86	45.26	6.19

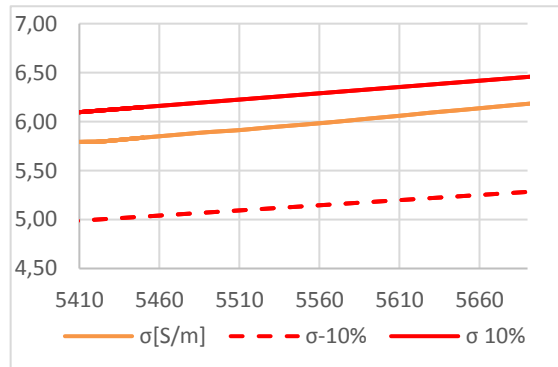
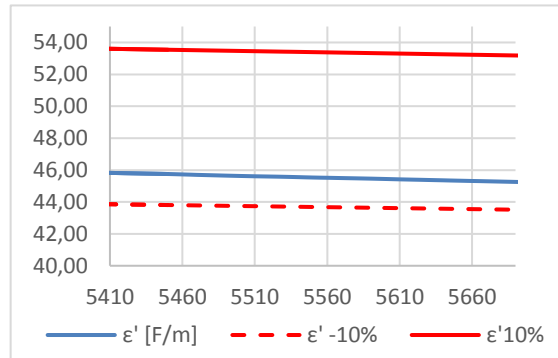

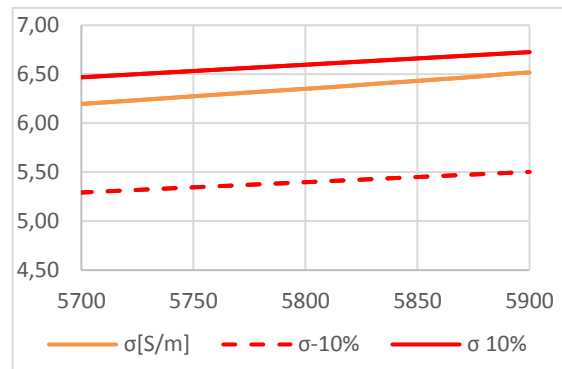
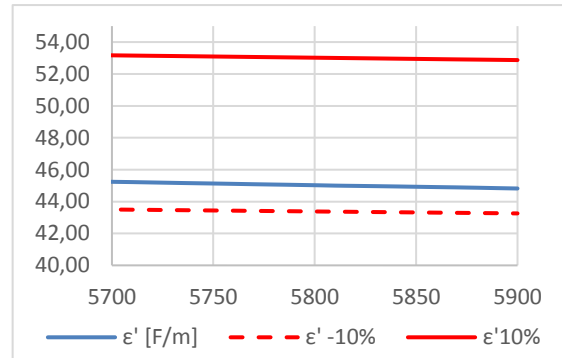

Body UNII-3 5800MHz

Freq. (MHz)	Target		2016/10/04 Measured	
	ϵ'	σ	ϵ'	σ
	5660	48.39	5.82	45.32
5670	48.38	5.84	45.30	6.15
5680	48.36	5.85	45.28	6.17
5690	48.35	5.86	45.26	6.19
5700	48.34	5.87	45.24	6.20
5710	48.32	5.88	45.22	6.21
5720	48.31	5.89	45.20	6.23
5730	48.30	5.91	45.17	6.24
5740	48.28	5.92	45.15	6.26
5750	48.27	5.93	45.13	6.27
5760	48.25	5.94	45.11	6.29
5770	48.24	5.95	45.09	6.31
5780	48.23	5.96	45.07	6.32
5790	48.21	5.98	45.05	6.34
5800	48.20	5.99	45.02	6.35
5810	48.19	6.00	45.00	6.37
5820	48.17	6.01	44.98	6.38
5830	48.16	6.02	44.97	6.40
5840	48.15	6.03	44.95	6.42
5850	48.13	6.05	44.93	6.43
5860	48.12	6.06	44.91	6.45
5870	48.10	6.07	44.89	6.46
5880	48.09	6.08	44.87	6.48
5890	48.08	6.09	44.84	6.50
5900	48.06	6.10	44.82	6.52



Annex E. Calibration Certificates

ID	Device	Type/Model	Serial Number	Manufacturer	Calibration Certificate
0260	Dosimetric E-field Probe	EX3DV4	7325	SPEAG	
0239	2450MHz System Validation Dipole	D2450V2	937	SPEAG	
0124	5GHz System Validation Dipole	D5GHzv2	1164	SPEAG	

Dipole calibration

According to the KDB 865664 D01, a dipole must be calibrated using a fully validated SAR system according to the tissue dielectric parameters and SAR probe calibration frequency required for device testing. However, instead of the typical annual calibration recommended by measurement standards, longer calibration intervals of up to three years may be considered when it is demonstrated that the SAR target, impedance and return loss of a dipole have remain stable according to the following requirements.

1. When the most recent return-loss result, measured at least annually, deviates by more than 20% from the previous measurement (i.e. value in dB \times 0.2) or not meeting the required 20 dB minimum return-loss requirement.
2. When the most recent measurement of the real or imaginary parts of the impedance, measured at least annually, deviates by more than 5 Ω from the previous measurement

The below results show the latest return loss and impedance measurements for each dipole performed by the lab:

Dipole 2450MHz Body TSL			
	Return Loss [dB]	Impedance [Ω]	Date
Last	-26.30	51.1 + 4.8 j	2016-06-22
Dipole 5200MHz Body TSL			
	Return Loss [dB]	Impedance [Ω]	Date
Previous	-21.57	48.59 – 8.14 j	2015-06-18
Last	-21.05	47.30 – 6.14 j	2016-06-16
Difference	-12.72%	1.29 + 2 j	
Dipole 5300MHz Body TSL			
	Return Loss [dB]	Impedance [Ω]	Date
Previous	-24.37	48.26 – 5.69 j	2015-06-18
Last	-25.01	51.32 – 5.38 j	2016-06-16
Difference	13.70%	3.06 + 0.31 j	
Dipole 5500MHz Body TSL			
	Return Loss [dB]	Impedance [Ω]	Date
Previous	-30.27	51.60 – 2.67 j	2015-06-18
Last	-30.29	48.37 – 3.07 j	2016-06-16
Difference	0.45%	-3.23 – 0.4 j	
Dipole 5600MHz Body TSL			
	Return Loss [dB]	Impedance [Ω]	Date
Previous	-26.79	53.32 – 3.37 j	2015-06-18
Last	-26.35	49.61 – 2.33 j	2016-06-16
Difference	-10.66%	3.71 + 1.04 j	
Dipole 5800MHz Body TSL			
	Return Loss [dB]	Impedance [Ω]	Date
Previous	-23.97	55.20 – 4.16 j	2015-06-18
Last	-23.45	52.30 – 2.62 j	2016-06-16
Difference	-12.71%	- 2.9 + 1.54 j	