

Lenovo ideapad MIIX 700-12ISK

User Guide



Read the safety notices and important tips in the included manuals before using your computer.

Lenovo™

Notes

- Before using the product, be sure to read *Lenovo Safety and General Information Guide* first.
- Some instructions in this guide may assume that you are using Windows® 10. If you are using another Windows operating system, some operations may be slightly different. If you are using other operating systems, some operations may not apply to you.
- The features described in this guide are common to most models. Some features may not be available on your computer or your computer may include features that are not described in this user guide.
- The illustrations in this manual may differ from the actual product. The screenshots of operating system are for reference only. Please refer to the actual product.

Regulatory Notice

- For details, refer to **Guides & Manuals** at <http://support.lenovo.com>.

First Edition (August 2015)

© Copyright Lenovo 2015.

LIMITED AND RESTRICTED RIGHTS NOTICE: If data or software is delivered pursuant to a General Services Administration "GSA" contract, use, reproduction, or disclosure is subject to restrictions set forth in Contract No. GS-35F-05925.

Contents

Chapter 1. Getting to know your computer.....	1
Top view.....	1
Left-side view.....	3
Right-side view.....	4
Top View.....	5
Bottom view.....	6
Rear view.....	7
Keyboard dock top view.....	10
Chapter 2. Starting to use Windows 10.....	17
Configuring the operating system for the first time.....	17
Operating system interfaces.....	17
The charms.....	18
Putting the computer to sleep or shutting it down.....	20
Touch screen operation.....	21
Connecting to a wireless network.....	25
Help and support.....	26
Chapter 3. Recovery system	27
Chapter 4. Troubleshooting.....	28
Frequently asked questions.....	28
Troubleshooting.....	29
Trademarks	32

Chapter 1. Getting to know your computer

■ ■ Top view

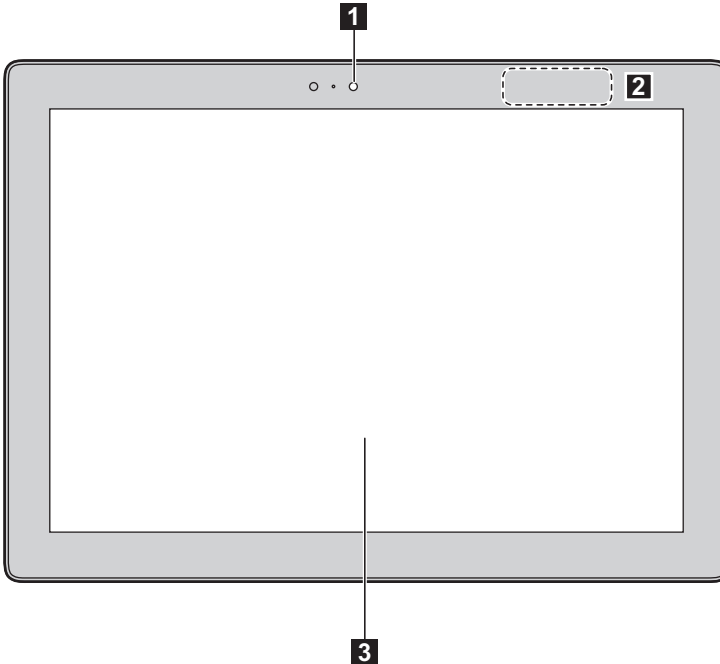

1 Front camera

Use the camera for video communication or taking photos.

2 Wireless LAN antenna

Connects to a wireless LAN adapter to send and receive wireless radio signals.

3 Multi-touch screen

Functions as the visual display as well as touchpad input.

Note: For details, see "Touch screen operation" on page 21.

Chapter 1. Getting to know your computer

■ Screen orientation

You can rotate the display panel to your preferred orientation. The orientation of the display automatically changes (alternating between portrait and landscape modes) depending on how you hold it.

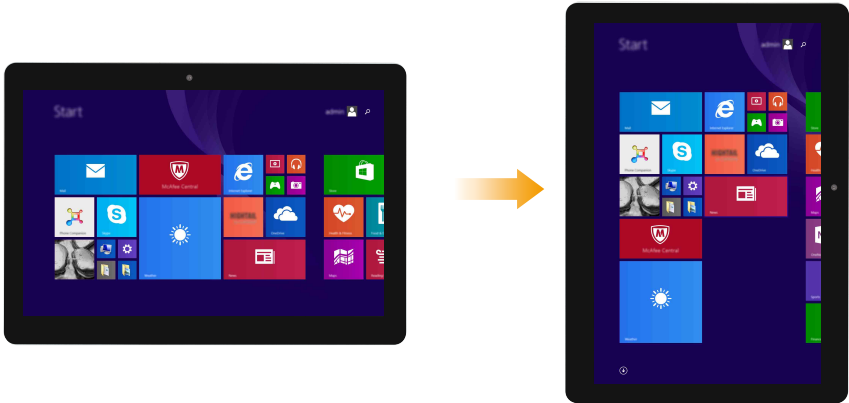

■ ■ Left-side view

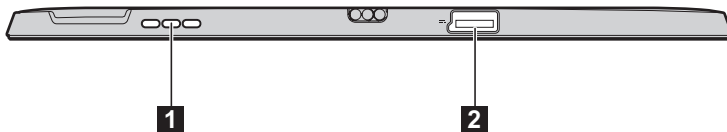

1 Speakers

Provide audio output.

2 AC power adapter jack

Connects to the AC power adapter.

■ ■ Right-side view

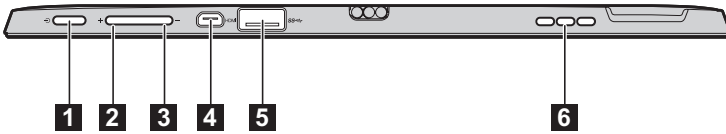

- | | | |
|----------|---------------------------|--|
| 1 | Power button | When the computer is off, press and hold this button to turn on the computer. |
| 2 | Volume up button | Increases the volume level. |
| 3 | Volume down button | Decreases the volume level. |
| 4 | Micro HDMI port | Connects to devices with micro HDMI input such as a TV or an external display. |
| 5 | USB port | Connects to USB devices. |
| 6 | Speakers | Provide audio output. |

■ ■ Top View

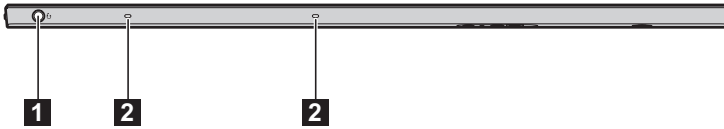

- 1 Combo audio jack** Connects to headsets.

Notes:

- The combo audio jack does not support conventional microphones.
- The recording function might not be supported if third-party headphones or headsets are connected, due to different industry standards.

- 2 Built-in microphone** Captures sound which can be used for video conferencing, voice narration, or audio recording.

■ ■ Bottom view

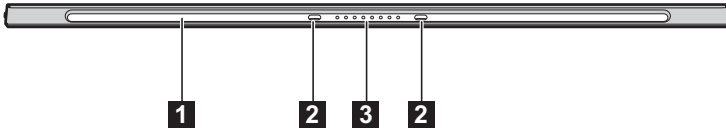

1 Tablet-keyboard dock groove

Note: For details, see “Combination of tablet and keyboard dock” on page 13.

2 Tablet-keyboard dock notch Connect the tablet to the dock and secure it in the installation position.

3 Keyboard dock connector Connects the tablet to the keyboard dock.

■ ■ Rear view

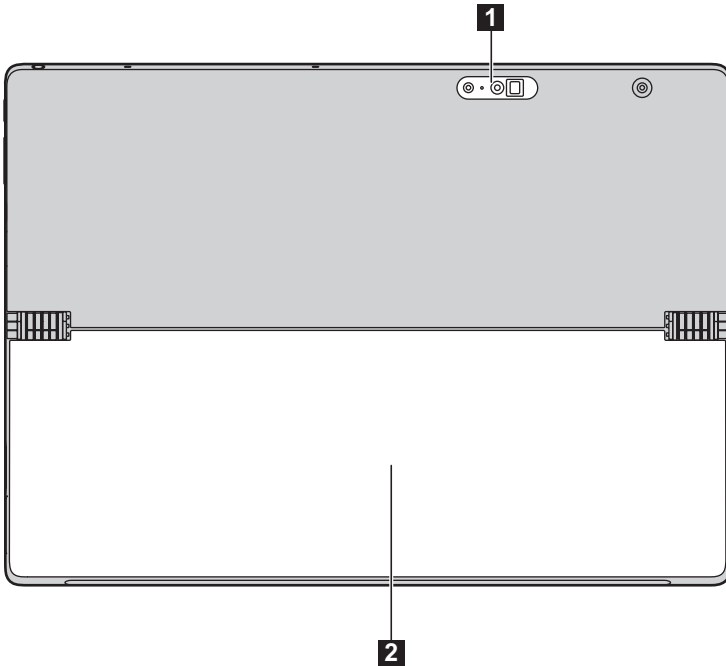

1 Rear camera

Use the camera for video communication or taking photos.

2 Stand cover

This Stand cover can flip as required, allowing the tablet standing at different angles.

Note: Always keep the flip angle less than 150°. Be careful not to leave a pen or any other items between the stand cover and the bottom plate after closing the stand cover. Otherwise, it could be damaged.

Chapter 1. Getting to know your computer

■ To use the stand cover

Lenovo ideapad MIIX 700-12ISK is equipped with a stand cover which can be flipped as preferred, to stand the tablet at different angles.

■ To flip the stand cover

As shown by the arrow, flip the stander gently by the finger recess between the stand cover and the bottom plate to the desired angle.

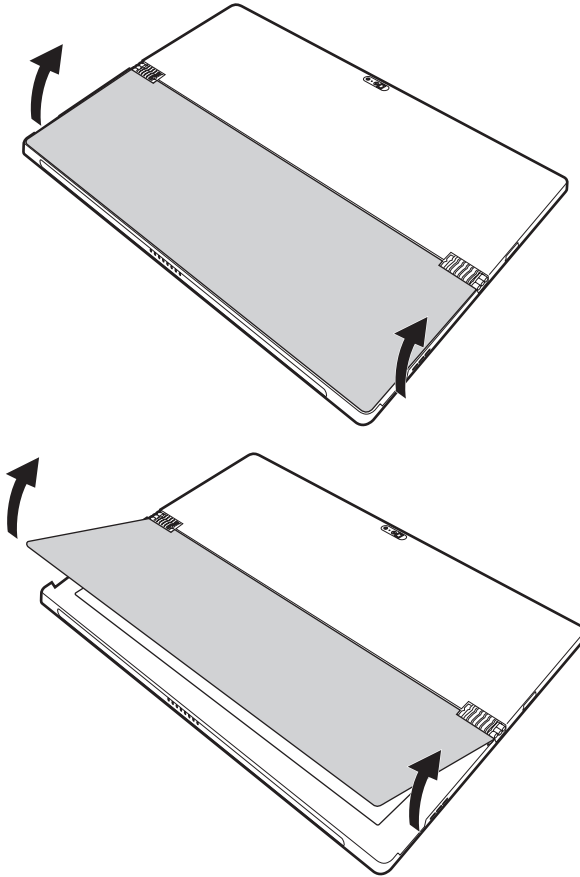

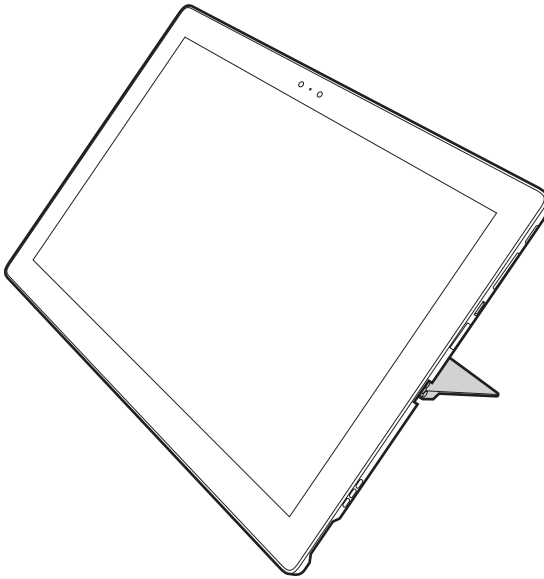

Notes:

- Do not use great force when flipping to avoid damage to the hinge.
- Always keep the flip angle less than 150°. Be careful not to leave a pen or any other items between the stand cover and the bottom plate after closing the stand cover. Otherwise, it could be damaged.

Keyboard dock top view

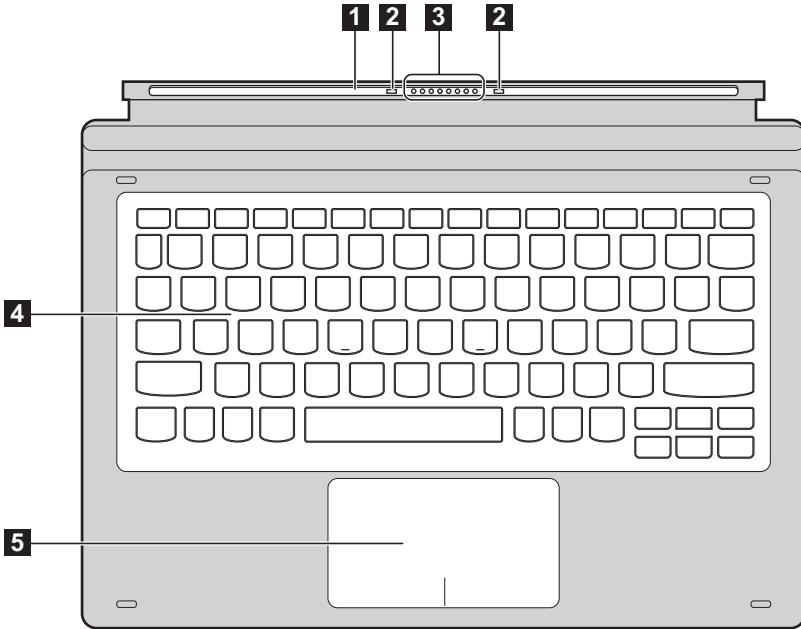

1 Tablet-keyboard dock tongue

Note: For details, see “Combination of tablet and keyboard dock” on page 13.

2 Tablet-keyboard dock Guide Pin Attaches the tablet to the dock keeping the tablet secured in place.

3 Keyboard dock connector Connects the tablet to the keyboard dock.

4 Keyboard









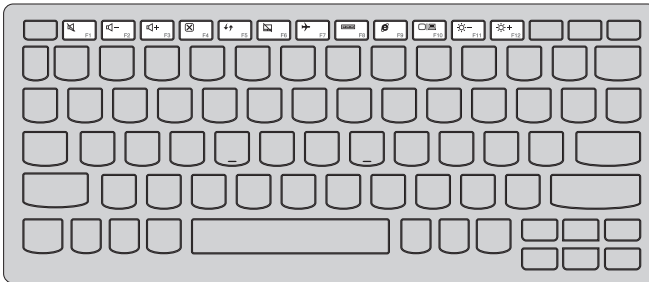



5 Touchpad

■ Using the keyboard

Hotkeys

You can access certain system settings quickly by pressing the appropriate hotkeys.



 : Mutes/unmutes the sound.	 : Enables/disables Airplane mode.
 : Decreases the volume level.	 : Displays all currently active apps.
 : Increases the volume level.	 : Quick access to the network.
 : Closes the currently active window.	 : Toggles the display between the computer and an external device.
 : Refreshes the desktop or the currently active window.	 : Decreases display brightness.
 : Enables/disables the touch pad.	 : Increases display brightness.

Note: If you changed the **Hotkey Mode** from **Enabled** to **Disabled** in the BIOS setup utility, you will need to press the Fn key in combination with the appropriate hotkey.

Chapter 1. Getting to know your computer

■ Function key combinations

Through the use of the function keys, you can change operational features instantly. To use this function, press and hold **Fn** **1**; then press one of the function keys **2**.

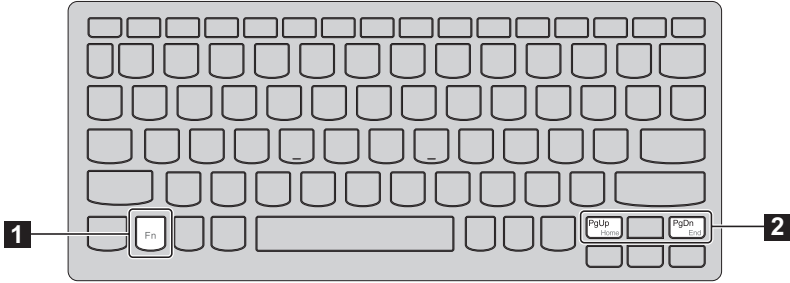

The following describes the features of each function key.

Fn + PgUp:	Activates the Home function.
Fn + PgDn:	Activates the End function.

■ Combination of tablet and keyboard dock

The Lenovo ideapad MIIX 700-12ISK is not only a tablet. It can be combined with a keyboard dock and used as a notebook computer.

Attaching the tablet

Align the connector of the keyboard dock with the tablet and then attach the tablet in the direction shown by the arrow.

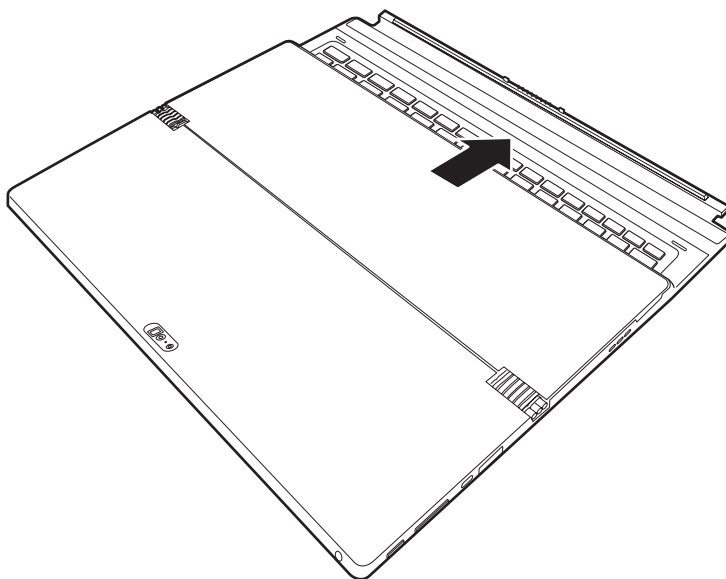

Chapter 1. Getting to know your computer

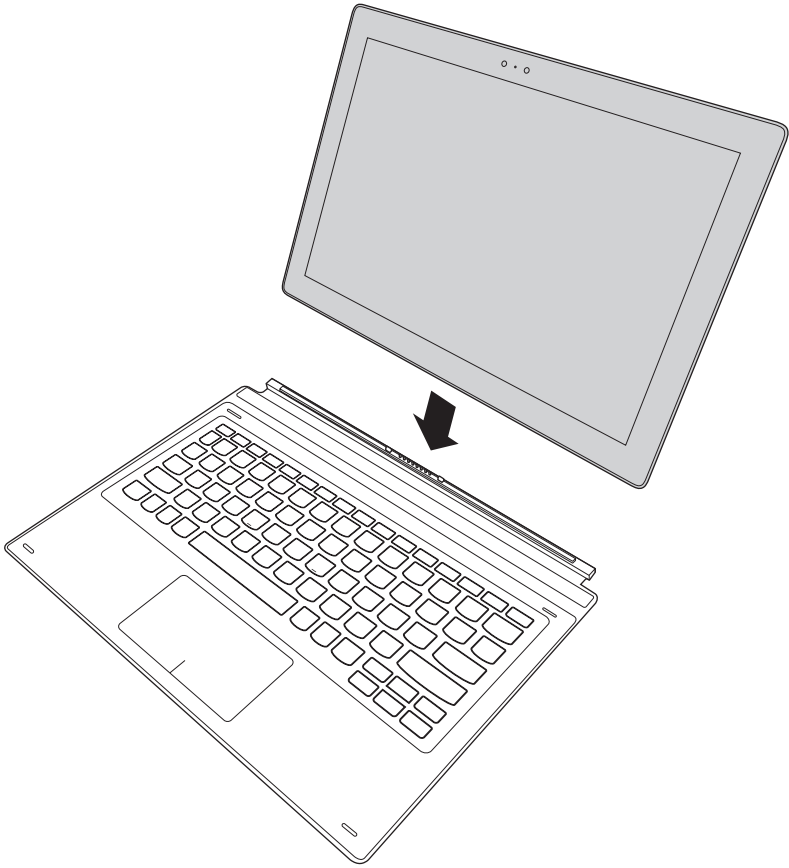

Note: Tablet-keyboard dock tongue has strong magnetic force, so as to easily connect with and secure the tablet.

Detaching the tablet

As shown by the arrow in Fig. 1, push forcefully both ends of the tablet-keyboard dock tongue to detach it from the tablet, while carefully detaching the tablet in the direction shown by the arrow 2.

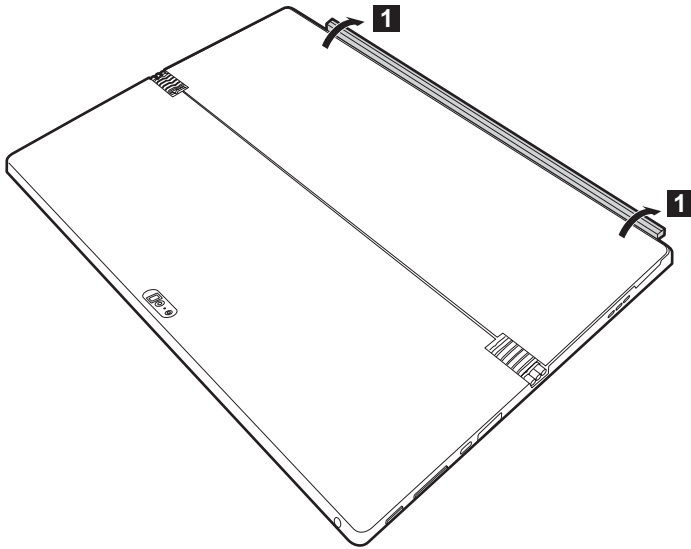

Chapter 1. Getting to know your computer

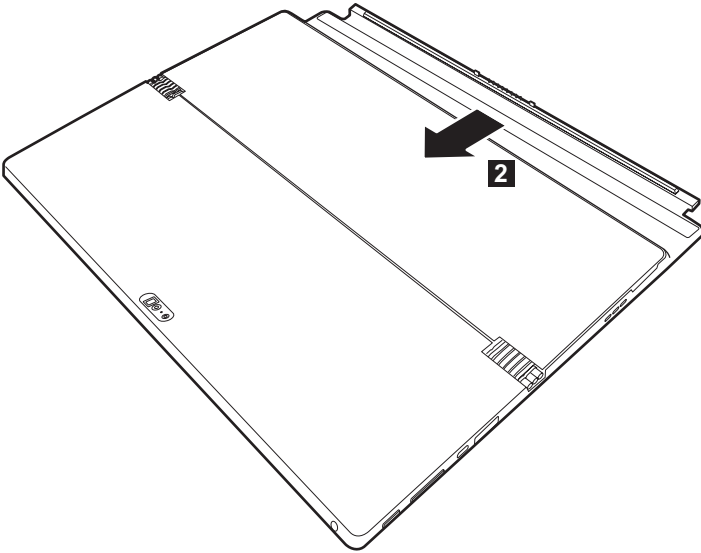

Notes:

- Be careful not to damage the connector when attaching or detaching the tablet.
- The illustrations above are for reference only, please refer to the actual product.

Chapter 2. Starting to use Windows 10

■ ■ Configuring the operating system for the first time

You may need to configure the operating system when it is first used.
The configuration process may include the procedures below:

- Accepting the end user license agreement
- Configuring the Internet connection
- Registering the operating system
- Creating a user account

■ ■ Operating system interfaces

Windows 8.1 comes with two main User Interfaces: the Start screen and the desktop.

To switch from the Start screen to the desktop, do one of the following:

- Select the desktop tile on the Start screen.
- Press the Windows key  + D (located on the keyboard).

To switch from the desktop to the Start screen, do one of the following:

- Select **Start**  from the charms.
- Move the cursor to the lower-left corner, then select the **Start** button.

Start screen

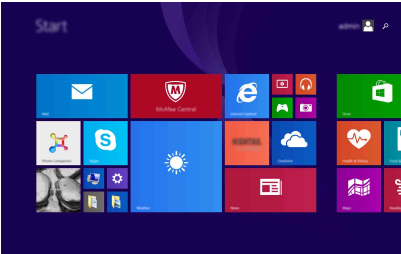

Desktop

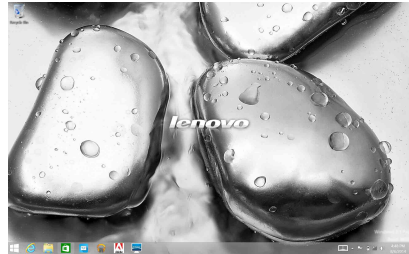

■ ■ The charms

Charms are navigation buttons that let you control your Windows® 8.1 experience.

Charms include: Search, Share, Start, Devices, and Settings. The **Charms Bar** is the menu that contains the charms.

The five charms provide new and faster ways to perform many basic tasks, and are always available regardless of which app you are currently in.

To display the charms, do one of the following:

- Move the pointer to the upper-right or lower-right corner until the charms bar is displayed.
- Use one finger to swipe in from the right edge of the screen until the charms bar is displayed.
- Press the Windows key  + C (located on the keyboard).

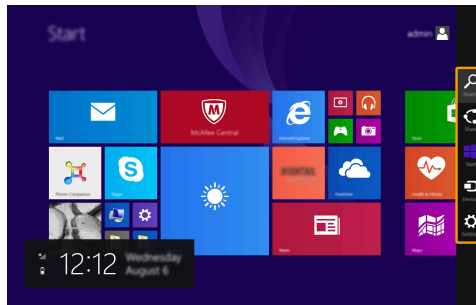

Search charm

The **Search** charm is a powerful new way to find what you are looking for, including settings, files, Web images, Web videos, etc.

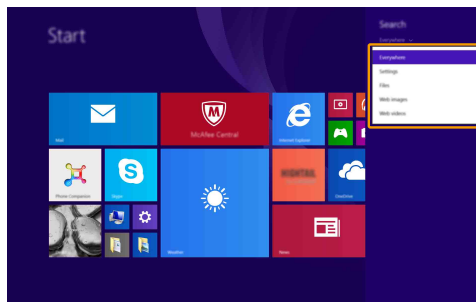

Share charm

The **Share** charm enables you to send links, photos, and more to your friends and social networks without leaving the app you are in.

Start charm

The **Start** charm is a way to go to the Start screen.

Devices charm

The **Devices** charm allows you to connect or send files to connected external devices, including the devices to play, print, and project.

Settings charm

The **Settings** charm enables you to perform basic tasks, such as setting the volume or shutting down the computer. Also, you can get to the Control Panel through the **Settings** charm when using the desktop screen.

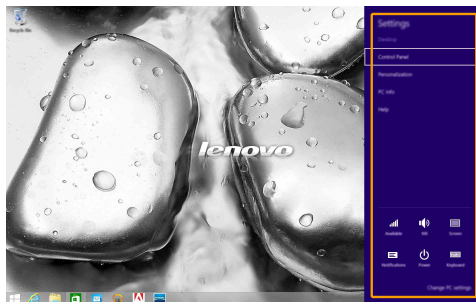

■ ■ Putting the computer to sleep or shutting it down

When you have finished working with your computer, you can put it to sleep or shut it down.

■ Putting your computer to sleep

If you will be away from your computer briefly, put the computer to sleep.

When the computer is in sleep mode, you can quickly wake it to resume use, bypassing the startup process.

To put the computer to sleep, do one of the following:

- Press the Power button.
- Open the charms, and then select **Settings**  → **Power**  → **Sleep**.

To wake the computer, do one of the following:

- Press any key on the keyboard.
- Press the Power button.

■ Shutting down the computer

If you are not going to use your computer for a long time, shut it down.

To shut down the computer, do one of the following:

- Open the charms, and then select **Settings**  → **Power**  → **Shut down**.
- Press and hold or right-click the **Start** button in the lower-left corner and select **Shut down or sign out** → **Shut down**.

■ ■ Touch screen operation

The display panel can accept inputs like a tablet, using the multi-touch screen, or like a traditional notebook computer, using the keyboard and touchpad.

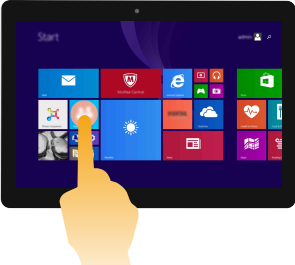
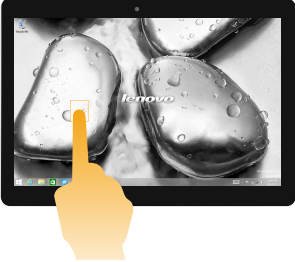

■ Multi-touch gestures

You can touch the screen with one or more fingertips to perform a variety of tasks.

Frequently used gestures	Tasks performed
<p>Tap Tap once on an item.</p> 	<p>Performs an action, such as starting an app, opening a link, or performing a command. Similar to left-clicking with a mouse.</p>
<p>Press and hold Press your finger down and leave it there for a moment.</p> 	<p>Enables you to see detailed information before selecting an action. Can also open a menu with more options. Similar to right-clicking with a mouse.</p>

Chapter 2. Starting to use Windows 10

(continued)

Frequently used gestures	Tasks performed
<p>Zoom Move two fingers together or apart while touching the screen.</p> 	<p>Zooms in and out on visual apps, such as pictures and maps. Can also jump to the beginning or end of a list.</p>
<p>Rotate Place two or more fingers on an item and then turn your hand.</p> 	<p>Rotates an object (Note: Not all items can be rotated, depending upon the app.).</p>
<p>Slide Drag your finger across the screen.</p> 	<p>Pans or scrolls through lists and pages. Can also move an object or be used to draw or write, depending upon the app. Similar to pressing and holding to pan and to scrolling with a mouse.</p>

(continued)

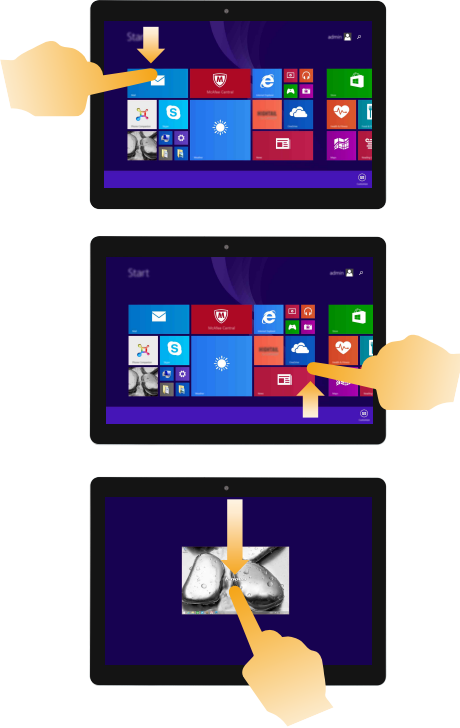
Frequently used gestures	Tasks performed
<p>Swipe Start from any edge of the screen, then swipe inwards toward the center.</p> 	<p>Swiping down from the top edge or up from the bottom edge displays a task bar on the bottom of the screen with app commands, including save, edit, and delete.</p> <p>If you have an app currently open, you can also:</p> <ul style="list-style-type: none"> • Swipe from the top edge to halfway down the screen without lifting your finger to dock that app on the left or right side of the screen. This enables you to keep two apps open simultaneously in a split-screen format. • Swipe from the top edge straight down to the bottom edge of the screen continuously without lifting your finger to close the currently open app.

(continued)

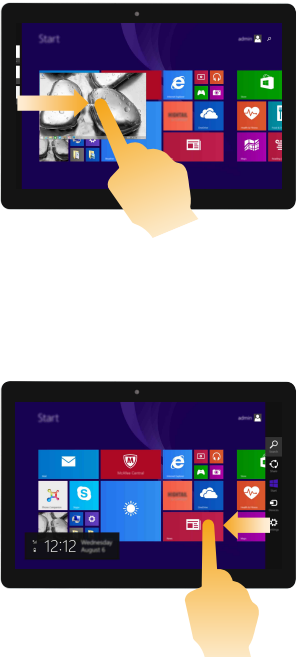
Frequently used gestures	Tasks performed
	<p>Swiping in from the left edge can:</p> <ul style="list-style-type: none">• Bring in and open an app currently running in the background. <p>If there is more than one currently open app, you can:</p> <ul style="list-style-type: none">• Swipe in from the left to bring in an app and, without lifting your finger, push that app quickly back off the left edge of the screen. This displays a list of the apps currently running in the background. <p>Swiping in from the right edge of the screen displays the charms.</p>

■ ■ Connecting to a wireless network



Enabling wireless connection

To confirm that Airplane mode is disabled, go to the desktop and check the notification area.

If you see the  icon displayed on the lower right, then Airplane mode is on. Otherwise, wireless function is enabled.

Note: Airplane mode is disabled by default.

If Airplane mode is on, do one of the following to enable the wireless function:

- Press **Fn + Backspace** to disable Airplane mode (located on the keyboard).
- Open the charms, select **Settings**  →  to open the Network configuration page, and then toggle the Airplane mode switch to **Off**.

Connecting to a wireless network

After wireless has been enabled, the computer will scan for available wireless networks and display them in the wireless network list. To connect to a wireless network, click the network name in the list, and then click **Connect**.

Note: Some networks require a network security key or passphrase for connection. To connect to one of those networks, ask the network administrator or the Internet Service Provider (ISP) for the security key or passphrase.

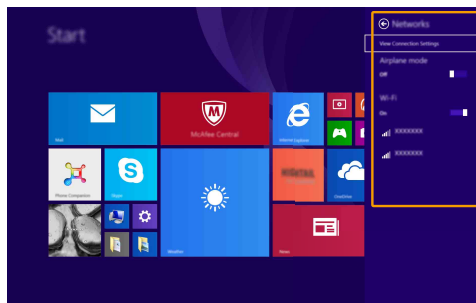

■ ■ Help and support

If you have any problems using the operating system, see the Windows Help and Support file. To open the Windows Help and Support file, do one of the following:

- Select the **Settings** charm. Select **Help**.

You can read the Windows Help and Support file on your computer. You can also get online help and support by clicking the link listed under **More to explore**.

Note: Windows 8.1 also provides an app, **Help+Tips**. You can find it on the Start screen, to learn more about new features of Windows 8.1.

Chapter 3. Recovery system

■ Introduction

Push-button reset is a built-in recovery tool that enables users to restore their operating system to its original state. This preserves their data and important customizations, without the need to back up their data in advance.

The following **Push-button reset** features are available to users from multiple locations within Windows:

Refreshing the computer

Fixes software problems by reinstalling the factory default configuration. This preserves the user's data, important settings, and any Windows Store apps previously purchased from the Windows Store.

Resetting the computer

Prepares the computer for recycling or transfer of ownership. This reinstalls the factory default configuration and returns all user data and applications to the state of their original Out-of-Box Experience (OOBE).

■ Using Push-button reset

Push-button reset can be launched using one of the following methods:

- Power button + Volume up button:
 - Shut down the computer and wait at least five seconds.
 - Press and hold the volume up button and then press the Power button, until the Novo Menu appears on the screen.
- Windows PC settings:
 - Windows PC settings → **Update and recovery** → **Recovery** → **Advanced startup** → select **Restart now**.

For more instructions, see the Windows Help and Support file on your computer.

Chapter 4. Troubleshooting

■ ■ Frequently asked questions

This section lists frequently asked questions by category.

■ Finding information

What safety precautions should I follow when using my computer?

The Lenovo *Safety and General Information Guide* which came with your computer contains safety precautions for using your computer. Read and follow all precautions during use.

Where can I find the hardware specifications for my computer?

You can find hardware specifications for your computer on the printed flyers which came with your computer.

Where can I find warranty information?

For detailed warranty information on this machine, please visit below website to check out: support.lenovo.com/warrantystatus.

■ Drivers

Where can I find drivers for the various hardware devices of my computer?

You can download the latest device drivers from the Lenovo consumer support website.

■ Getting help

How can I contact the customer support center?

See “Chapter 3. Getting help and service” in the Lenovo *Safety and General Information Guide*.

■ ■ Troubleshooting

If you do not find your problem here, see Chapter 1. The following section only describes problems that might negate the need to refer to the more comprehensive information in Chapter 1.

Display problems

When I turn on the computer, nothing appears on the screen.

- If the screen is blank, make sure that:
 - The AC power adapter is connected to the computer and the power cord is plugged into a working electrical outlet.
 - The computer power is on. Press and hold the Power button for about three seconds for confirmation.
 - Press and hold the Power button for about ten seconds to force shut down the computer. Then press the Power button for about three seconds to restart.
- If these items are set correctly and the screen remains blank, have the computer serviced.

The screen goes blank while the computer is on.

- Your power management is enabled. Do one of the following to resume from sleep mode:
 - Press any key on the keyboard.
 - Press the Power button.

Sleep problems

The critical low-battery error message appears, and the computer immediately turns off.

- The battery power is getting low. Connect the AC power adapter to the computer.

The computer enters sleep mode immediately after Power-on.

- Make sure that:
 - The battery is charged.
 - The operating temperature is within the acceptable range. See “Chapter 2. Use and care Information” in the *Lenovo Safety and General Information Guide*.

Note: If the battery is charged and the temperature is within range, do the following:

- 1 Press the Power button for about three seconds to turn on the computer.
- 2 Press and hold the Power button for about ten seconds to force shut down.
- 3 Press the Power button for about three seconds again to restart. Then reset the computer with the **Push-button reset** recovery system.

If the problem persists, have the computer serviced.

Chapter 4. Troubleshooting

The computer does not return from sleep mode and the computer does not work.

- If the computer does not return from sleep mode, it might be because the battery is depleted.
- If your computer is in sleep mode, connect the AC power adapter to the computer. Then press the Power button.
- If your computer is powered-off, connect the AC power adapter to the computer. Then press the Power button to resume operation.

Note: If the system still does not return from sleep mode, your system has stopped responding, and you cannot turn off the computer; force shut down the computer (Unsaved data may be lost). To force shut down the computer, press and hold the Power button for about ten seconds or more. If the computer still does not turn off, remove the AC power adapter.

Display panel problems

The screen is blank.

- Do the following:
 - If you are using the AC power adapter or the battery, press **F12** (located on the keyboard) to make the screen brighter.
 - Press the Power button to confirm if the computer is in sleep mode.
 - If the problem persists, follow the solution in the next problem "The screen is unreadable or distorted."

The screen is unreadable or distorted.

- Make sure that the screen resolution and color quality are correctly set.

Incorrect characters appear on the screen.

- Is the operating system or programs installed correctly? If they are installed and configured correctly, do the following:
 - 1** Press the Power button for about three seconds to turn on the computer.
 - 2** Press and hold the Power button for about ten seconds to force shut down.
 - 3** Press the Power button for about three seconds again to restart. Then reset the computer with the **Push-button reset** recovery system.

If the problem persists, have the computer serviced.

Sound problems

No sound can be heard from the speakers even when the volume is turned up.

- Make sure that:
 - The Mute function is off.
 - The combo audio jack is not being used.
 - Speakers are selected as the playback device.

Battery problems

Your computer shuts down before the battery status icon shows it is empty.

-or-

Your computer operates after the battery status icon shows it is empty.

- Recharge the battery.

A startup problem

The Microsoft® Windows operating system does not start.

- For details, see “Recovery system” on page 27.

Recovery System problems

Failure to restore system partition to factory default.

- The system partition (e.g. the partition size or the drive capacity of C) has been modified.

Other problems

Your computer does not respond.

- To turn off your computer, press and hold the Power button for about ten seconds or more. If the computer still does not respond, remove the AC power adapter.

Trademarks

The following terms are trademarks or registered trademarks of Lenovo in the United States, other countries, or both.

Lenovo
ideapad

Microsoft and Windows are trademarks of Microsoft Corporation in the United States, other countries, or both.

