



M.gear

WHA YU INDUSTRIAL CO., LTD.(HEAD OFFICE)
DONGGUAN AEON TECH CO.,LTD.(CHINA)
SUZHOU AEON TECH CO.,LTD.(CHINA)
AEON TECH (SHANGHAI) CO.,LTD(CHINA)
DONGGUAN PARNER TECH CO.,LTD.(CHINA)

SPECIFICATION FOR APPROVAL

CUSTOMER: 永洋科技股份有限公司



PART NAME: RF Antenna Assembly

PART NO.:

REVISION:

W. Y. P/NO.: C381-510150-A(SSR-91019)

REV.: XI

	MANUFACTURER SIGNATURE	CUSTOMER SIGNATURE
APPROVED BY :	Roma 	
DATE :	4/16/09	

WHA YU GROUP

WHA YU INDUSTRIAL CO., LTD.(HEAD OFFICE)

謙裕實業股份有限公司

Address: No. 326, Sec. 2, Kung Tao 5 Road, Hsin Chu City, Taiwan, R.O.C.

Tel:+886-3-5714225(REP.) Fax:+ 886-3-5713853 · + 886-3-5723600

DONGGUAN AEON TECH CO.,LTD.(CHINA)

東莞台霖電子通訊有限公司

Address:Hupan Industrial District,Tai Ling Shan Town,Dong Guan City,Guangdong,China

Tel:+86-769-85655858 Fax:+86-769-85655258

SUZHOU AEON TECH CO.,LTD(CHINA)

蘇州華廣電通有限公司

Address:Limin North Road, LiLi Town,LiLi Industrial Park,LinHu Economic Zone

Wujiang City,Jiangsu Province,China

Tel:+86-512-63627980 Fax:+86-512-63627981

AEON TECH (SHANGHAI) CO.,LTD(CHINA)

普翔電子貿易(上海)有限公司

Address:Flat 501,5F,Build 27, NO.68,Guiqing Road, Huhui District, Shanghai,China

Tel:+86-21-64959151 Fax:+86-21-64959059

DONGGUAN PARNER TECH CO.,LTD.(CHINA)

東莞倍能電子有限公司

Address:Hupan Industrial District, Shida Road, Tai Ling Shan Town,

Dong Guan City, Guangdong, China

Tel:+86-769-81662366 Fax:+86-769-81602681

RF Antenna Assembly

Specification

1. Electrical Properties :

- 1.1 Frequency Range.....2.4GHz ~ 2.5GHz
- 1.2 Impedance50Ω Nominal
- 1.3 VSWR 1.92 :1Max.
- 1.4 Return Loss..... -10 dB Max.
- 1.5 Radiation Omni-directional
- 1.6 Gain(peak)..... 2dBi
- 1.7 Polarization..... Linear; Vertical
- 1.8 Admitted Power..... 1W
- 1.9 Cable.....RG-178 Cable
- 1.10 Connector.....SMA Straight Plug Reverse

2. Physical Properties :

- 2.1 Antenna Body..... TPE
- 2.2 Antenna Base..... PC
- 2.3 Antenna Base..... PBT
- 2.4 Operating Temp. -10°C ~ +60°C
- 2.5 Storage Temp. -10°C ~ +70°C
- 2.6 Color White

REV	DATE	DESCRIPTION
X1	04/11-2009	New Issue

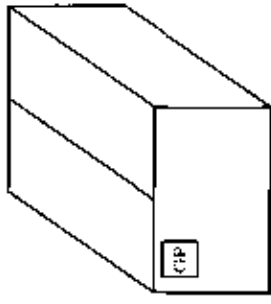
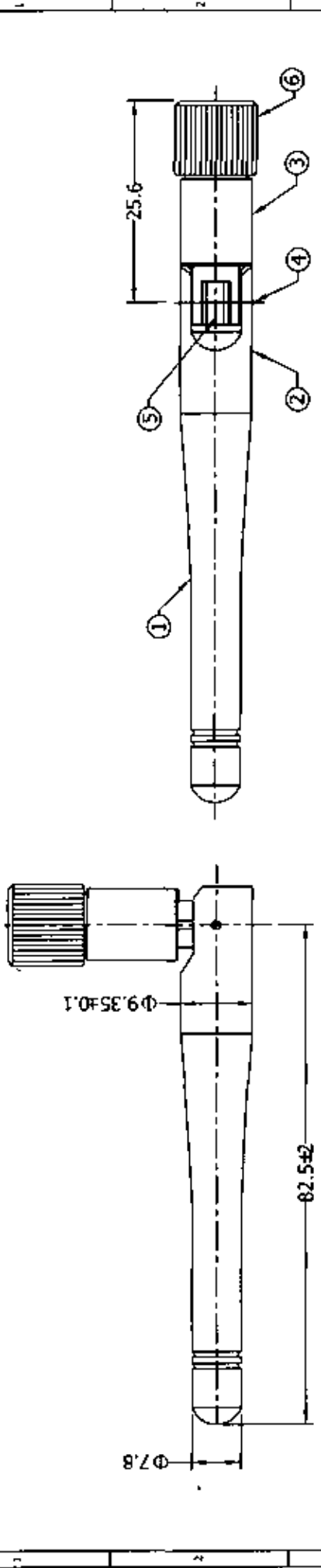

GP標識貼於外箱兩邊側邊左上角

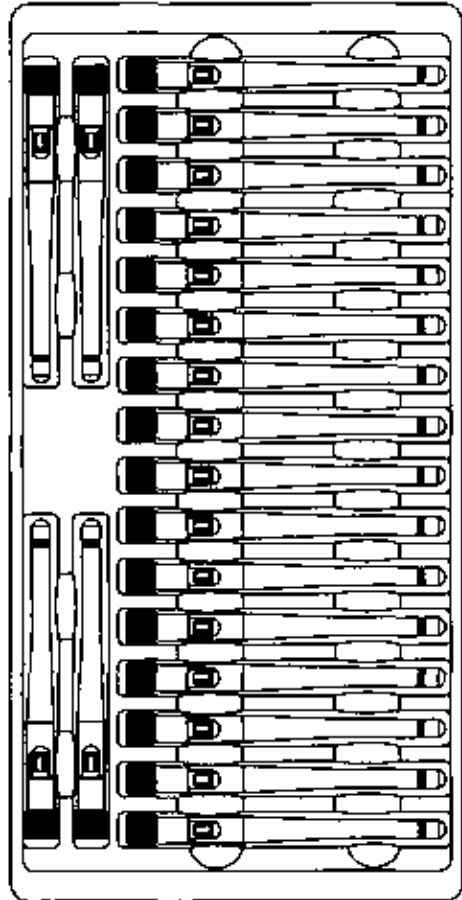

Packing: 每Tray裝裝20PCS成品

NO	DESCRIPTION	QTY	REMARK
6	Connector SMA Straight Plug Reverse	1	
5	Cable RG-178Cable, Transparency Brown,50Ω	1	
4	Rivet POM,Color:White	2	
3	Antenna Base PBT,Color:White,Du Pont LS033(W,Y-024)	1	
2	Antenna Base PC,Color:White,Du Pont LS033(W,Y-D24)	1	
1	Antenna Body TPE,Color:White,Du Pont LS033(W,Y-024)	1	

CUSTOMER: 永 洋		APPROVED: (Signature)	
PART NO :		CHECKED: (Signature)	
PART NAME: RF Antenna Assembly		DRAWING: (Signature)	
W.Y P/NO : C381-510150-A			
REV	UNIT	FILE	
X1	mm	SSR-91019	
SHEET : 1/1		CUSTOMER'S SIGNATURE	



Wha Yu Group

THIS DRAWING, AND IT'S IMPEDANT DESIGN CONCEPTS, ARE THE PROPERTY OF WHA YU AND AS SUCH MAY NOT BE COPIED, REPRODUCED, OR GIVEN TO THIRD PARTIES WITHOUT THE WRITTEN CONSENT OF WHA YU.

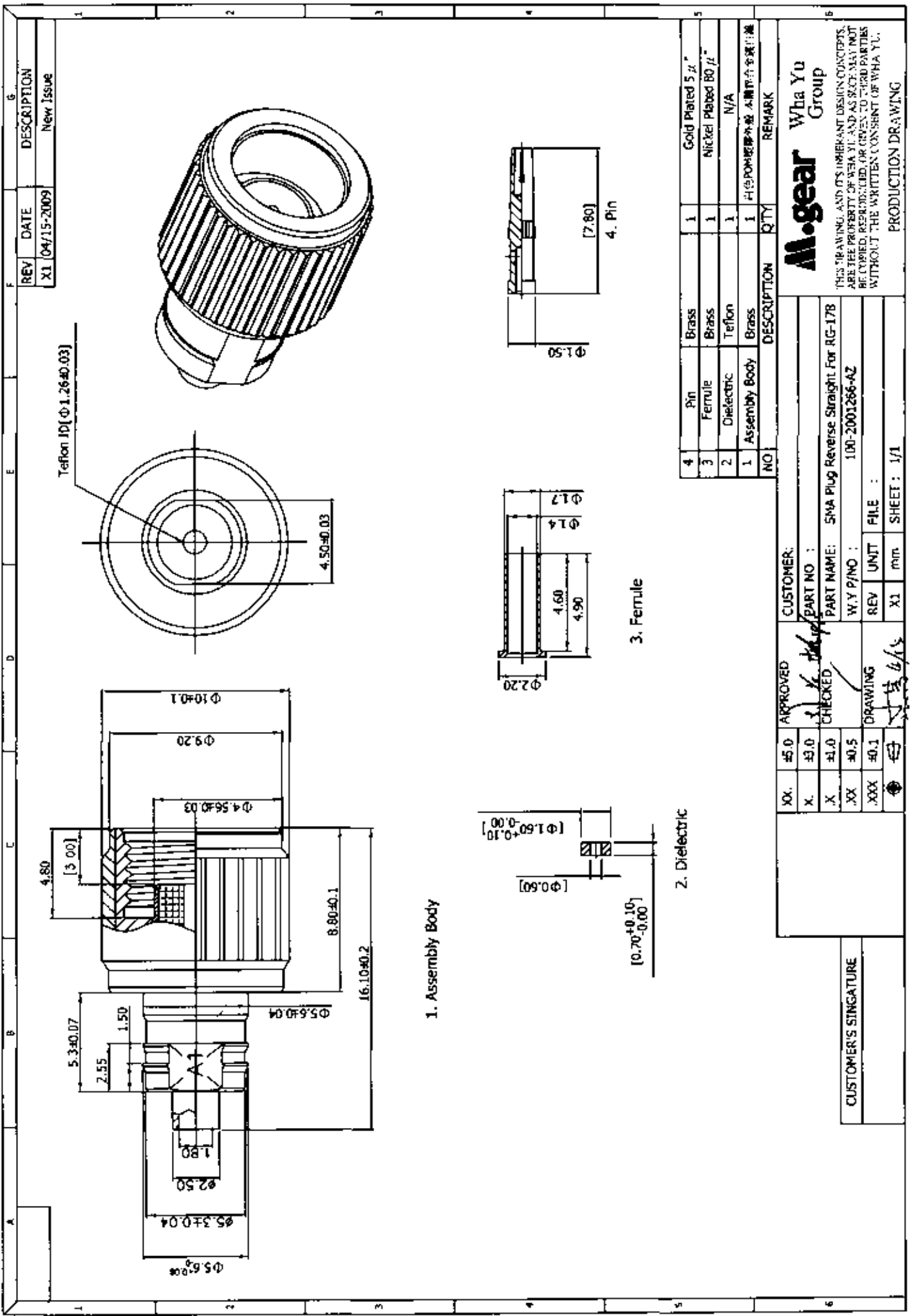

REV	DATE	DESCRIPTION
X1	04/15-2009	New Issue

M-gear Wha Yu Group
 THIS DRAWING AND ITS IMPERANT DESIGN CONCEPTS ARE THE PROPERTY OF WHA YU. AND AS SUCH MAY NOT BE COPIED, REPRODUCED, OR GIVEN TO THIRD PARTIES WITHOUT THE WRITTEN CONSENT OF WHA YU.
 PRODUCTION DRAWING

NO	DESCRIPTION	QTY	REMARK
4	Pin	1	Brass
3	Ferrule	1	Brass
2	Dielectric	1	Teflon
1	Assembly Body	1	Brass

XX	#5.0	APPROVED	CUSTOMER
X	#3.0	CHECKED	PART NO :
X	#1.0		PART NAME: SMA Plug Reverse Straight For RG-178
XX	#0.5		W.Y P/NO : 100-2001266-AZ
XXX	#0.1	DRAWING	REV
			UNIT
			mm
			FILE
			SHEET : 1/1

CUSTOMER'S SIGNATURE

RF Antenna Assembly

P/No.C381-510150-A SSR-91019 Spec:2.4~2.5GHz

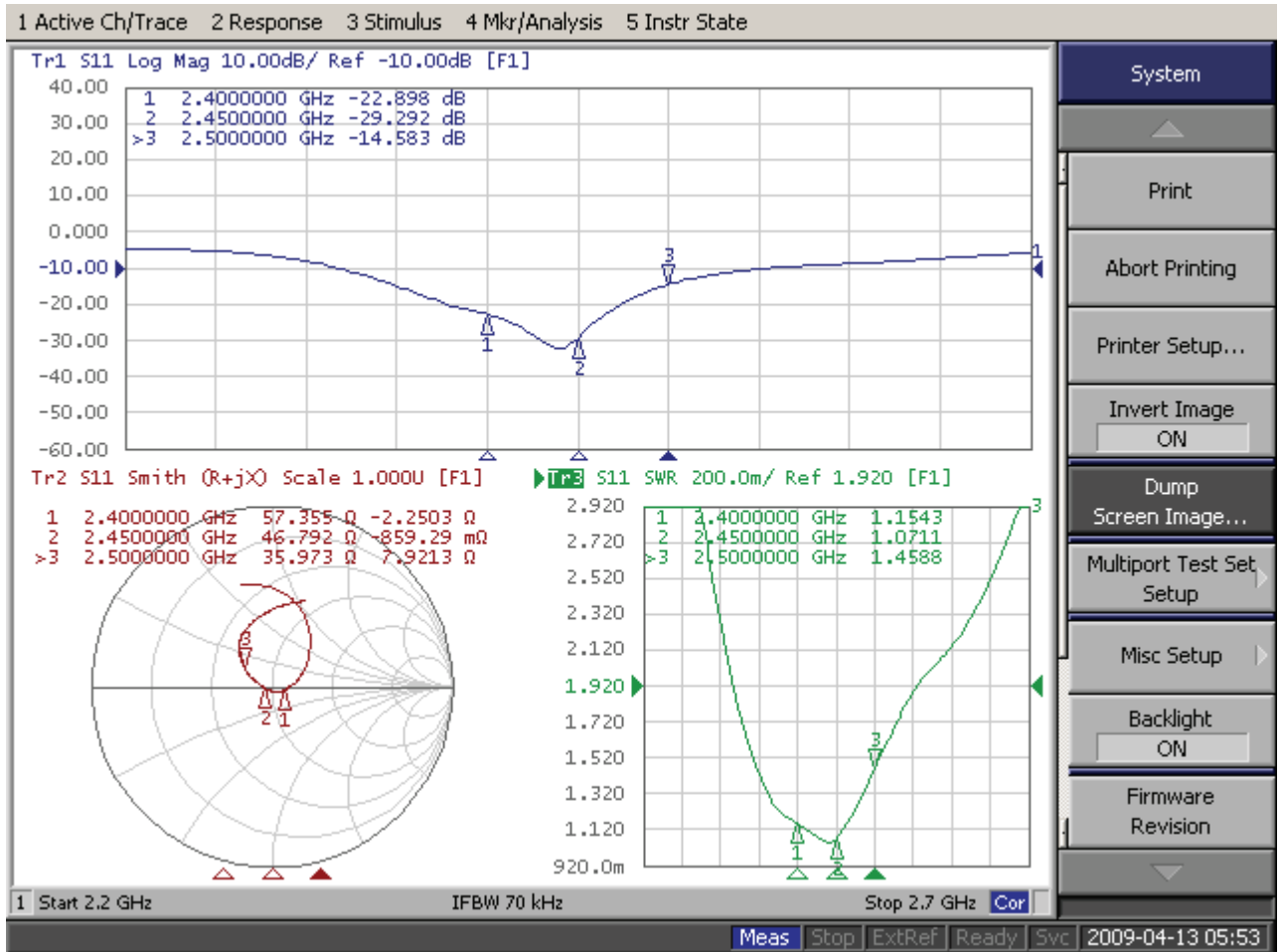

Far-field amplitude of C381-510150-A SSR-91019 E H-PLANE.nsi

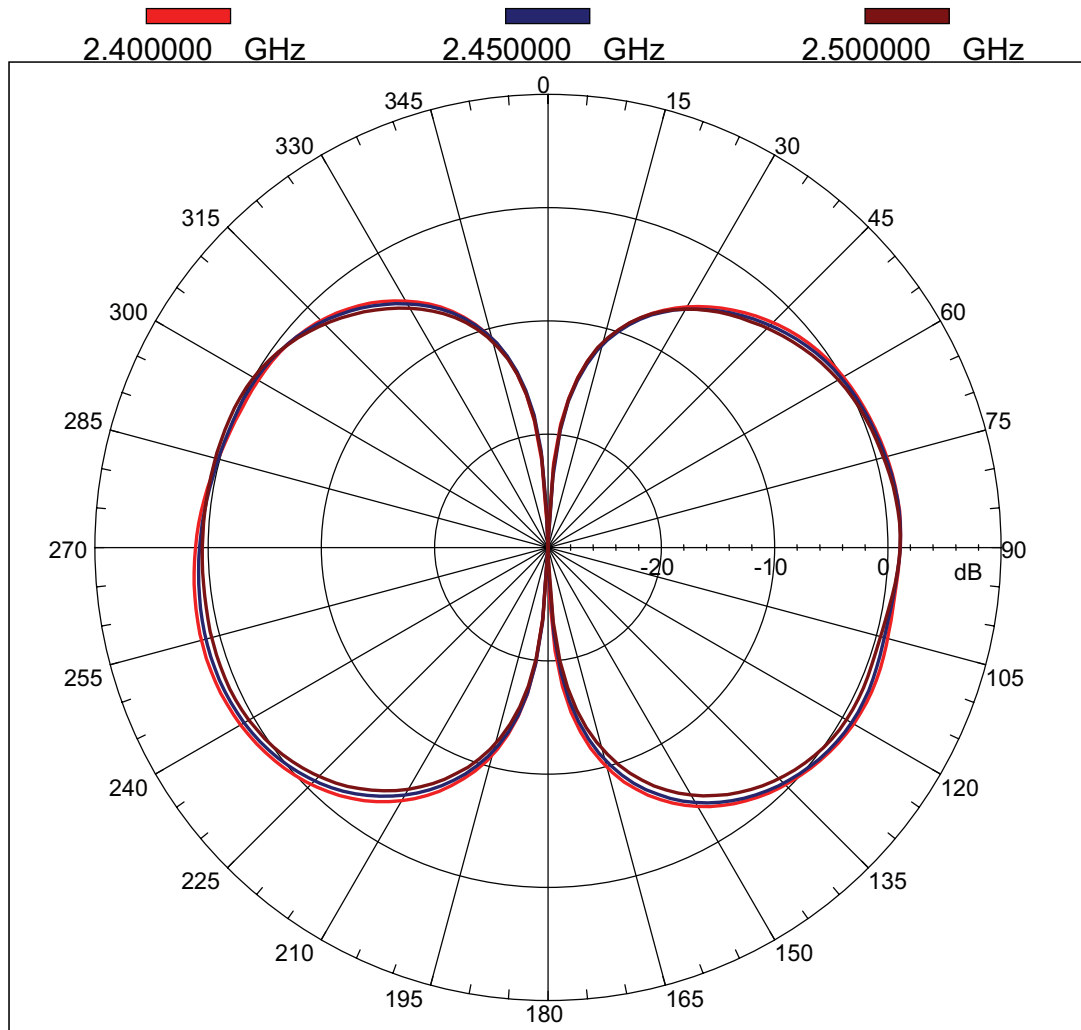

Far-field amplitude of C381-510150-A SSR-91019 V H-PLANE.nsi

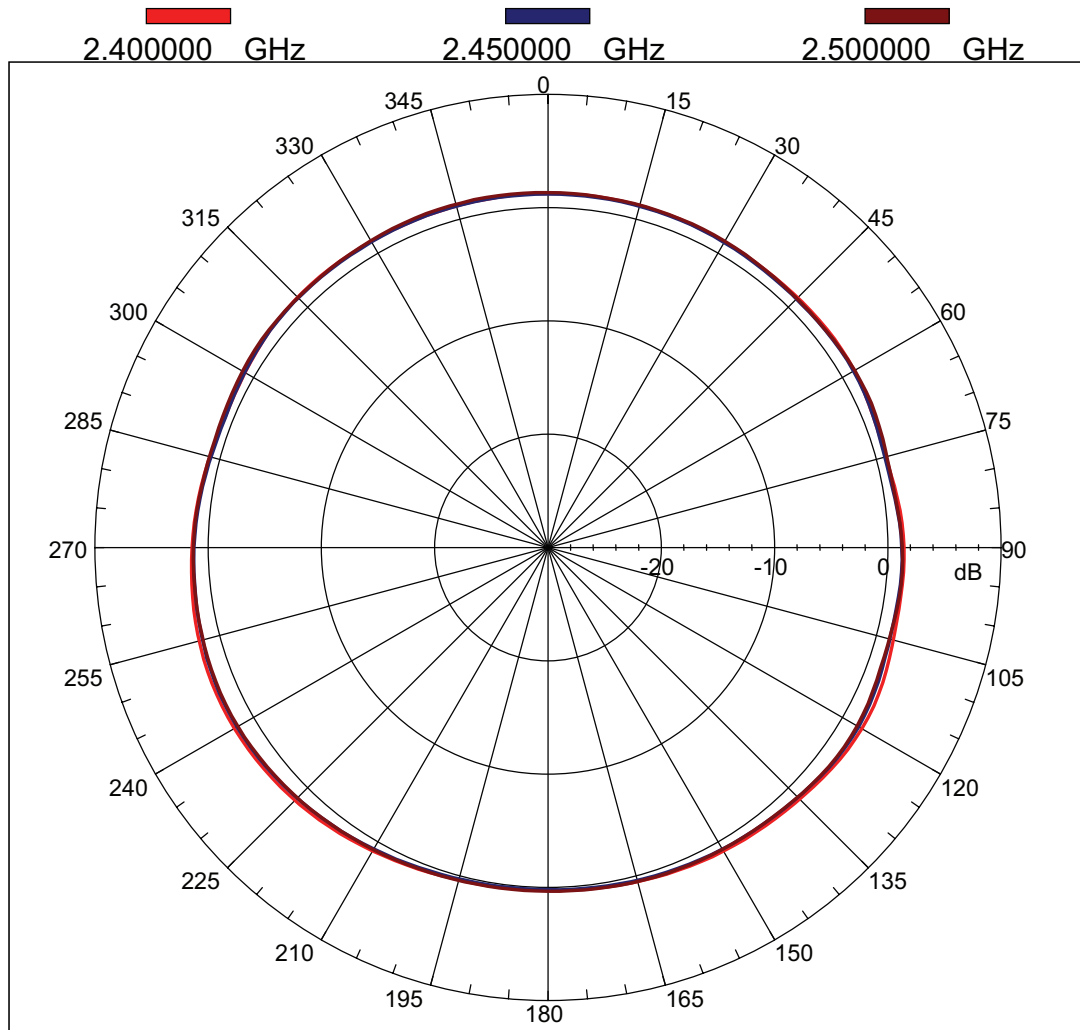

RG 178 B/U	FEP INSULATED HIGH-FREQUENCY COAXIAL CABLE	PAGE	1 / 2
PRODUCT STANDARD		ISSUED	16. Oct. 2003
		REVISED	

I - Scope

This specification presents a FEP insulated high-frequency coaxial cable AWG 30, 1.8 mm O.D. for internal wiring of electronic equipment, such as Computer / Notebook with wireless communication systems.

II - Construction

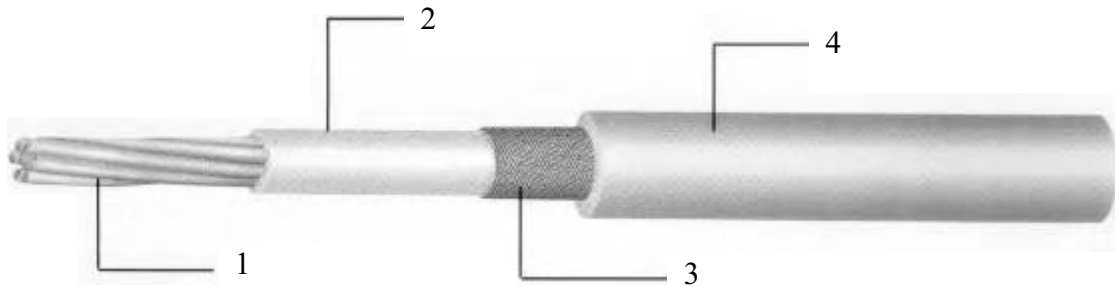

Item		Unit	Details
1. Inner Conductor	Material	—	CP-AG
	Composition	No./mm	AWG 30 or 7 ×0.1
	Dia. (approx.)	mm	0.305
2. Dielectric	Material	—	Extruded FEP
	Nom. O.D.	mm	0.84 ± 0.05
	Color	—	Natural
3. Outer Conductor	Material	—	Silver coated copper
	Composition	—	Braided (16 / 3 / 0.1)
	Dia. (approx)	mm	1.29 ±0.01
4. Jacket	Material	—	Extruded FEP
	Dia.	mm	1.80 ±0.1
	Color	—	Standard color is Light Orange

Note :	MADE BY	
	APPROVALS	

RG 178 B/U	FEP INSULATED HIGH-FREQUENCY COAXIAL CABLE	PAGE	2 / 2
PRODUCT STANDARD		ISSUED	16. Oct. 2003
		REVISED	

III – Characteristics

Item	Unit	Specified Value	Note
Temperature Rating	°C	-55 ~ +200	
Voltage Lasting	V	1000	
Dielectric strength	—	Dielectric core: No breakdown at AC 3 kv for 0.2 sec.	Spark test
		Jacket: No breakdown at AC 3 kv for 0.2 sec.	Spark test
Characteristic Impedance	Ω	50 ± 2	TDR method
Capacitance	pF / m	29.4	at 1 kHz
Attenuation. (Max.)	dB / 30m	52.0	1.0 GHz
		94.0	3.0 GHz
		-	5.0 GHz
		16.0	100.0 GHz
		33.0	400.0 GHz
Approx. Weight	g / m	7.68	

Note :	MADE BY	
	APPROVALS	



譚裕實業股份有限公司

WHA YU INDUSTRIAL CO., LTD

Connector 材質證明書

譚裕料號 Whayu P/N	100-2001266-AZ	產品名稱 Product Name	Big SMA Straight Plug Reverse For RG-178
-------------------	----------------	----------------------	--

結構圖面

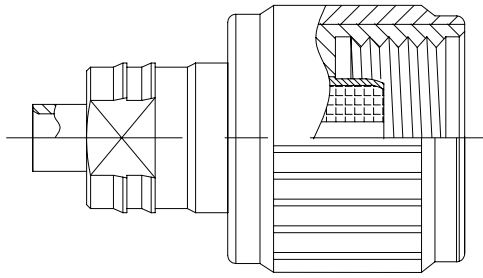

1. Assembly Body

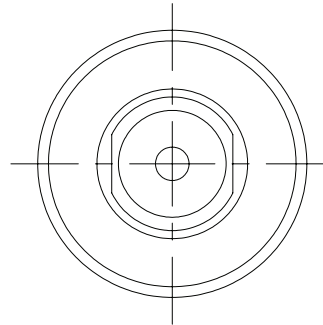

2. Dielectric

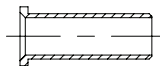

3. Ferrule

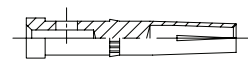

4 Pin

材質成份								表面處理
1	Body	Brass	Cu	Pb	Fe	Fe+Sn	Zn	POM White
2	Dielectric	Teflon	PTFE					N/A
3	Ferrule	Brass	Cu	Pb	Fe	Fe+Sn	Zn	Plated Nickel >80 μ "
4	Pin	Brass	Cu	Pb	Fe	Fe+Sn	Zn	Plated Gold 5 μ "

Remark :

請蓋公司章

