

Nemko Test Report: 3L0345RUS1REV2

Applicant: Enfora Inc.
661 E/ 18th Street
Plano, Texas 75074

**Equipment Under Test:
(E.U.T.)** Aspen – GSM/GPRS Wireless Modem
GSM0107

In Accordance With: **FCC Parts 24, Subpart E**
Broadband PCS Subscriber Station

Tested By: Nemko Dallas Inc.
802 N. Kealy
Lewisville, TX
75057-3136

Authorized By:



Tom Tidwell, Frontline Manager

Date: 28Apr04

Total Number of Pages: 37

EQUIPMENT: GSM0107

Table of Contents

Section 1. Summary of Test Results.....3

Section 2. General Equipment Specification5

Section 3. RF Power Output.....7

Section 4. Occupied Bandwidth8

Section 5. Spurious Emissions at Antenna Terminals.....12

Section 6. Field Strength of Spurious23

Section 7. Frequency Stability.....26

Section 8. Test Equipment List27

ANNEX A - TEST METHODOLOGIES28

ANNEX B - TEST DIAGRAMS34

EQUIPMENT: GSM0107

Section 1. Summary of Test Results

Manufacturer: Enfora Inc.

Model No.: GSM0107

Serial No.: 28

General: **All measurements are traceable to national standards.**

These tests were conducted on a sample of the equipment for the purpose of demonstrating compliance with FCC Part 24, Subpart E.

- New Submission
- Production Unit
- Class II Permissive Change
- Pre-Production Unit

THIS TEST REPORT RELATES ONLY TO THE ITEM(S) TESTED.

THE FOLLOWING DEVIATIONS FROM, ADDITIONS TO, OR EXCLUSIONS FROM THE TEST SPECIFICATIONS HAVE BEEN MADE.
See " Summary of Test Data".

TESTED BY: Eldon Berry DATE: 26 Aug., 2003

Nemko Dallas Inc. authorizes the above named company to reproduce this report provided it is reproduced in its entirety and for use by the company's employees only.

Any use which a third party makes of this report, or any reliance on or decisions to be made based on it, are the responsibility of such third parties. Nemko Dallas Inc. accepts no responsibility for damages, if any, suffered by any third party as a result of decisions made or actions based on this report.

This report applies only to the items tested.

EQUIPMENT: GSM0107**Summary Of Test Data**

NAME OF TEST	PARA. NO.	SPEC.	RESULT
RF Power Output	24.232	2W eirp	Complies
Occupied Bandwidth (TDMA)	24.238	Not Specified	Complies
Spurious Emissions at Antenna Terminals	24.238(a)	-13 dBm	Complies
Field Strength of Spurious Emissions	24.238(a)	-13 dBm E.I.R.P.	Complies
Frequency Stability	24.235	+/- 0.05 ppm	Complies

Footnotes:

EQUIPMENT: GSM0107

Section 2. General Equipment Specification

Supply Voltage Input:	3.3 - 5 Vdc	
Frequency Bands:	<input checked="" type="checkbox"/>	Block A 1850 – 1865 MHz
	<input checked="" type="checkbox"/>	Block D 1865 – 1870 MHz
	<input checked="" type="checkbox"/>	Block B 1870 – 1885 MHz
	<input checked="" type="checkbox"/>	Block E 1885 – 1890 MHz
	<input checked="" type="checkbox"/>	Block F : 1890 – 1895 MHz
	<input checked="" type="checkbox"/>	Block C 1895 – 1910 MHz
Type of Modulation and Designator:	GPRS 292K6G7W <input checked="" type="checkbox"/>	See page 9 for 20dB BW
Output Impedance:	50 ohms	
RF Output (Rated):	1 Watt	

EQUIPMENT: GSM0107

System Description

This device is a wireless GSM/GPRS wireless modem that operates in the PCS band.

System Diagram

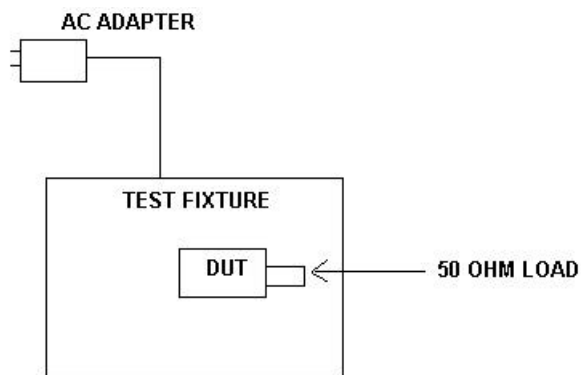

EQUIPMENT: GSM0107

Section 3. RF Power Output

NAME OF TEST: RF Power Output	PARA. NO.: 24.232(b)
TESTED BY: Eldon Berry	DATE: 22Aug03

Test Results: Complies.

Measurement Data:

RF Power Output (Conducted)

Job No.: 3L0345R Date: 8/22/2003
 Specification: CFR 47, Part 24 Temperature(°C): 21
 Tested By: Eldon Berry Humidity(%): 50
 E.U.T.: GSM0107
 Configuration: EUT on test fixture.
 Detector: Average

Test Equipment Used:

Power Meter: E4418B Directional Coupler: _____
 Power Sensor: E9304A Cable #1: 1083
 Load: _____ Cable #2: _____
 Spectrum Analyzer: NA Cable #3: _____
 Attenuator #1: 1604 Cable #4: _____
 Attenuator #2: _____ Cable #5: _____
 Attenuator #3: _____ Cable #6: _____
 Attenuator #4: _____ Power Splitter: _____

Measurement Uncertainty: +/- .7 dB

Frequency MHz	Channel	Modulation Type	Output Power (dBm)	Output Power (mW)
1850.2	512	GPRS	29.8	954.99
1880.2	662	GPRS	29.7	933.25
1909.8	810	GPRS	28.8	758.58

Power meter set for 12.5 % duty cycle.
 Cable and attenuator verified with generator # 1053

EQUIPMENT: GSM0107

Section 4. Occupied Bandwidth

NAME OF TEST: Occupied Bandwidth	PARA. NO.: 24.238
TESTED BY: Dustin Oaks	DATE: April 26, 2004

Test Results: Complies.

Test Data: See attached plots.

Test Equipment Used: 1036, 1973, 1604

EQUIPMENT: GSM0107

Test Plot – Occupied Bandwidth, Low Channel

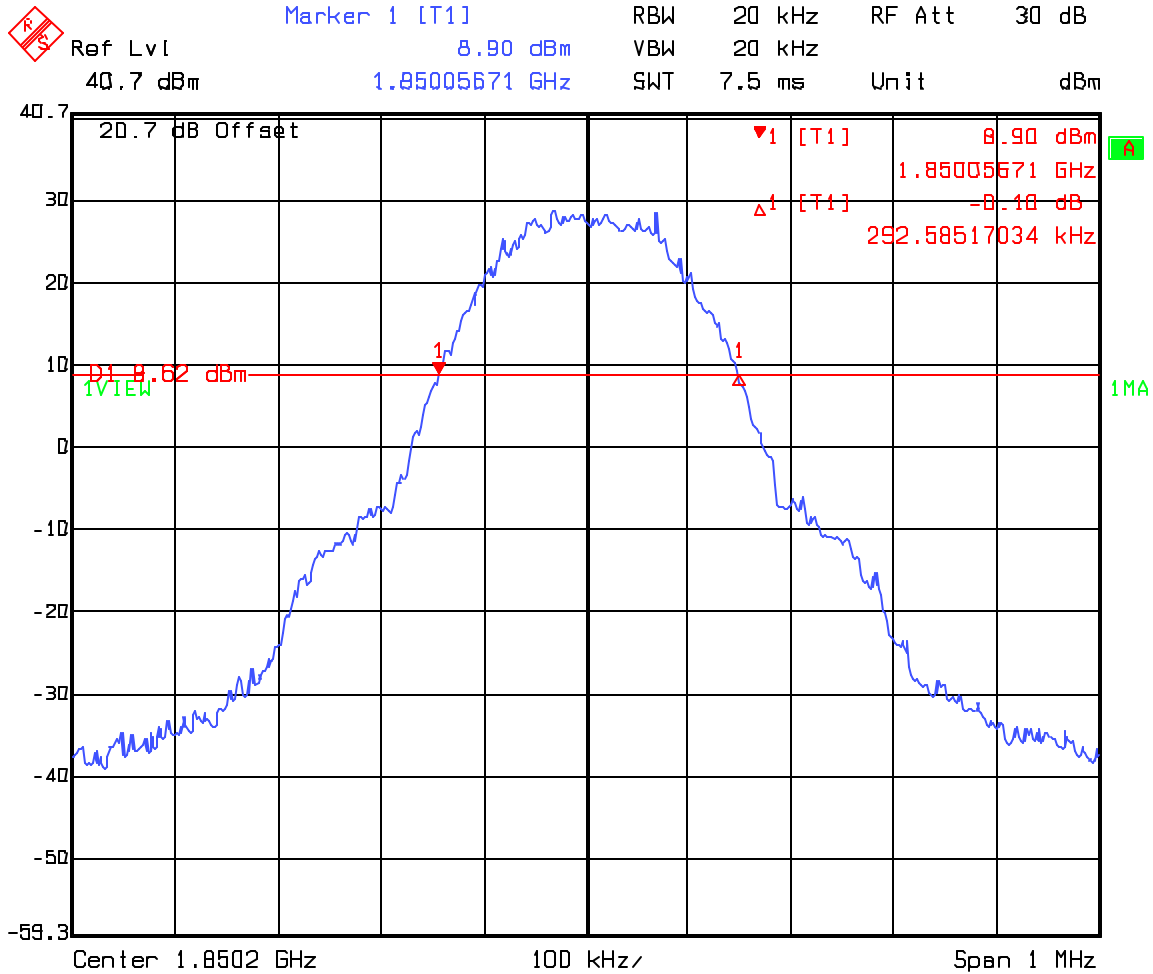

Date: 26.APR.2004 13:26:59

EQUIPMENT: GSM0107

Test Plot – Occupied Bandwidth, Middle Channel

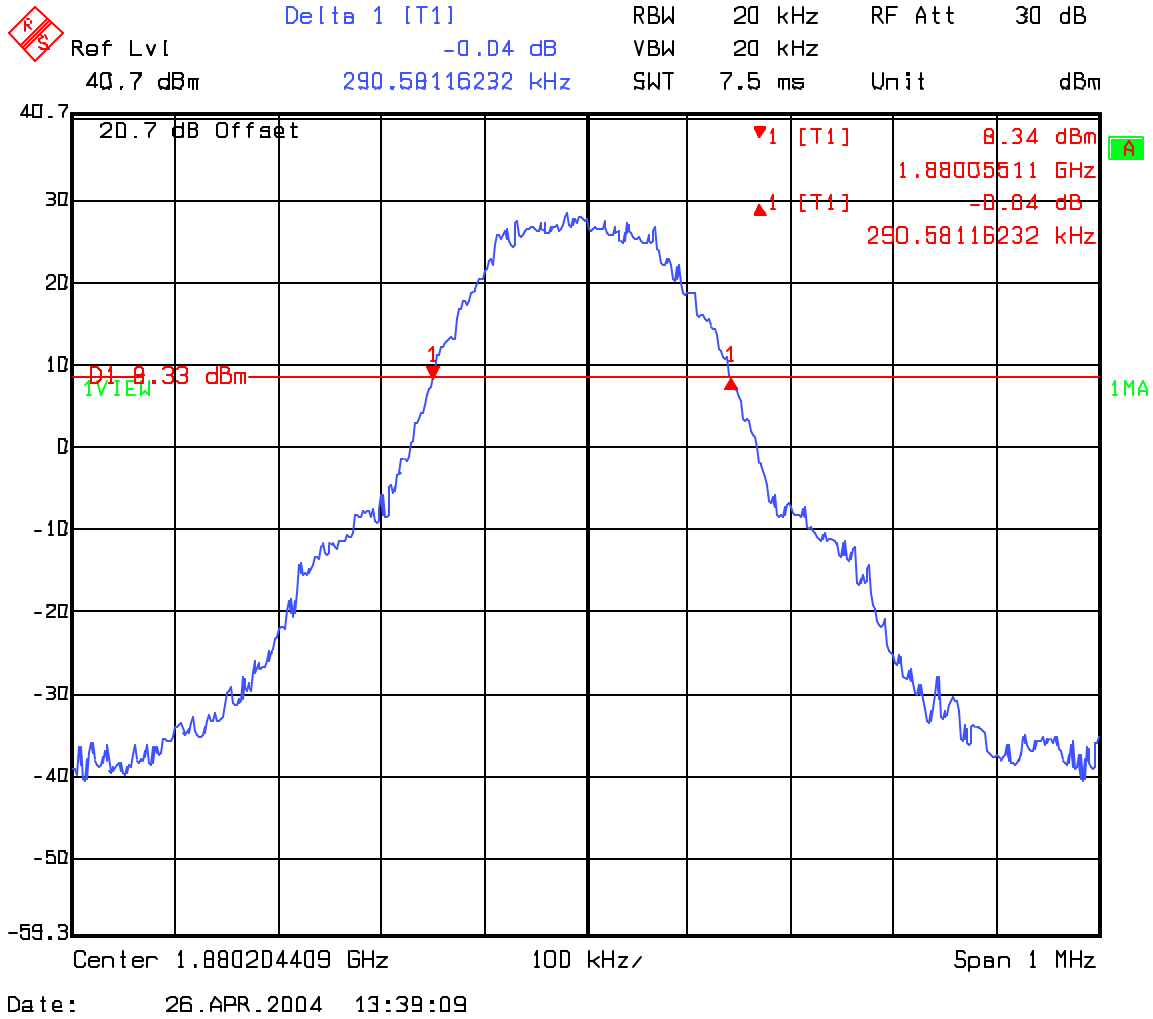

EQUIPMENT: GSM0107

Test Plot – Occupied Bandwidth, High Channel

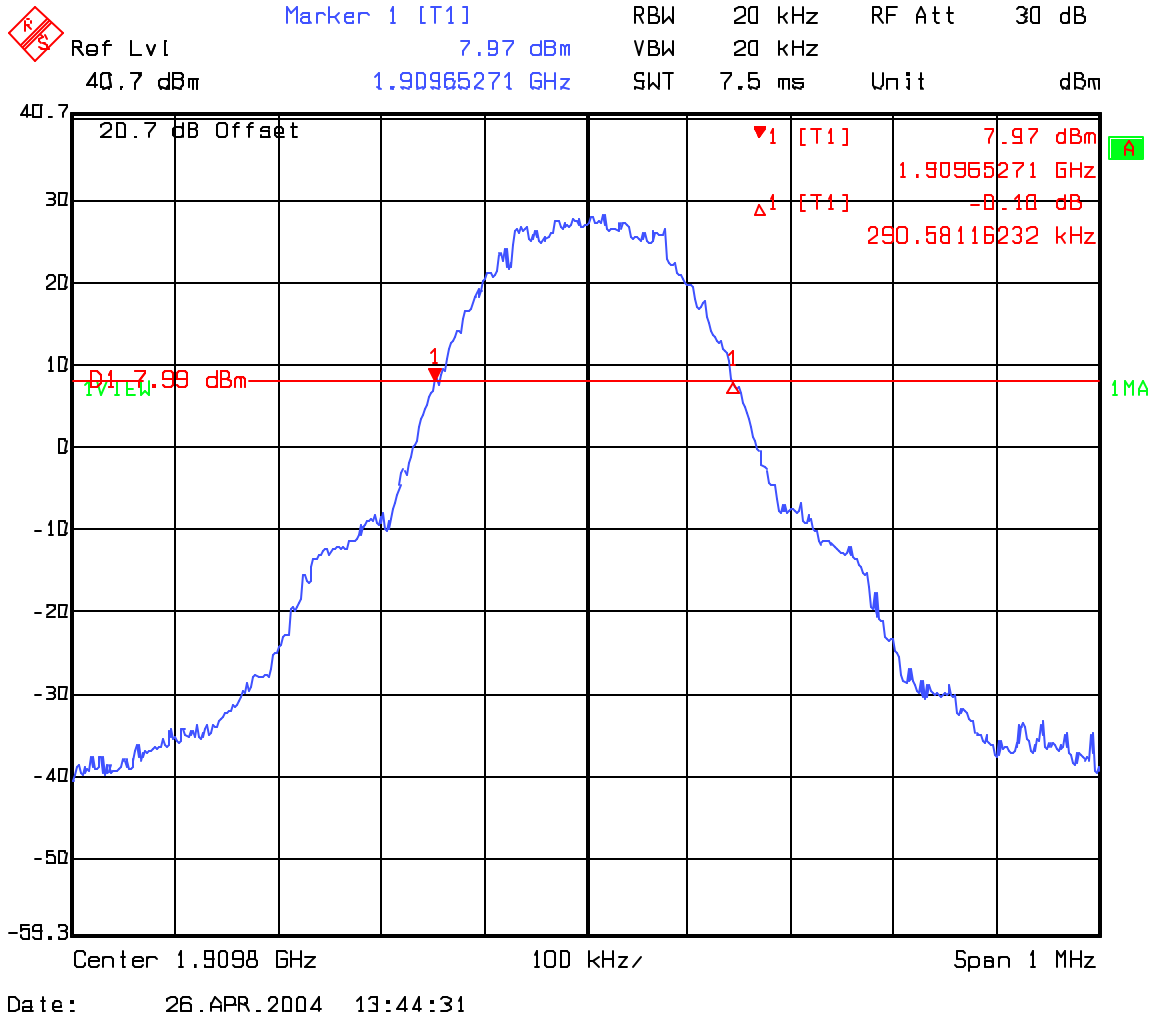

EQUIPMENT: GSM0107

Section 5. Spurious Emissions at Antenna Terminals

NAME OF TEST: Spurious Emissions @ Antenna Terminals	PARA. NO.: 24.238
TESTED BY: Dustin Oaks	DATE: April 26, 2004

Test Results: Complies.

Test Data: See attached plots.

Test Equipment Used: 1036, 1973, 1604

EQUIPMENT: GSM0107

Test Plots – Lower Band Edge

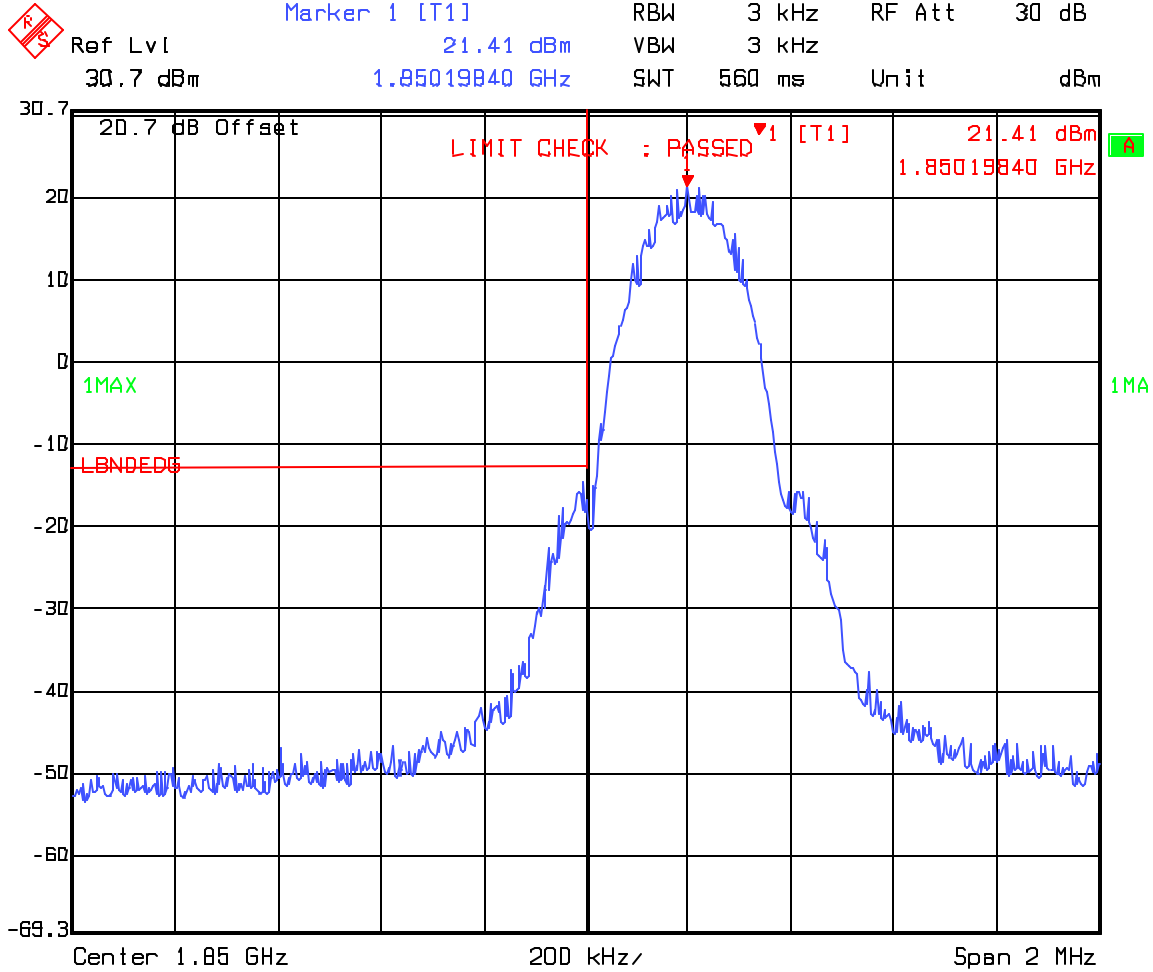

EQUIPMENT: GSM0107

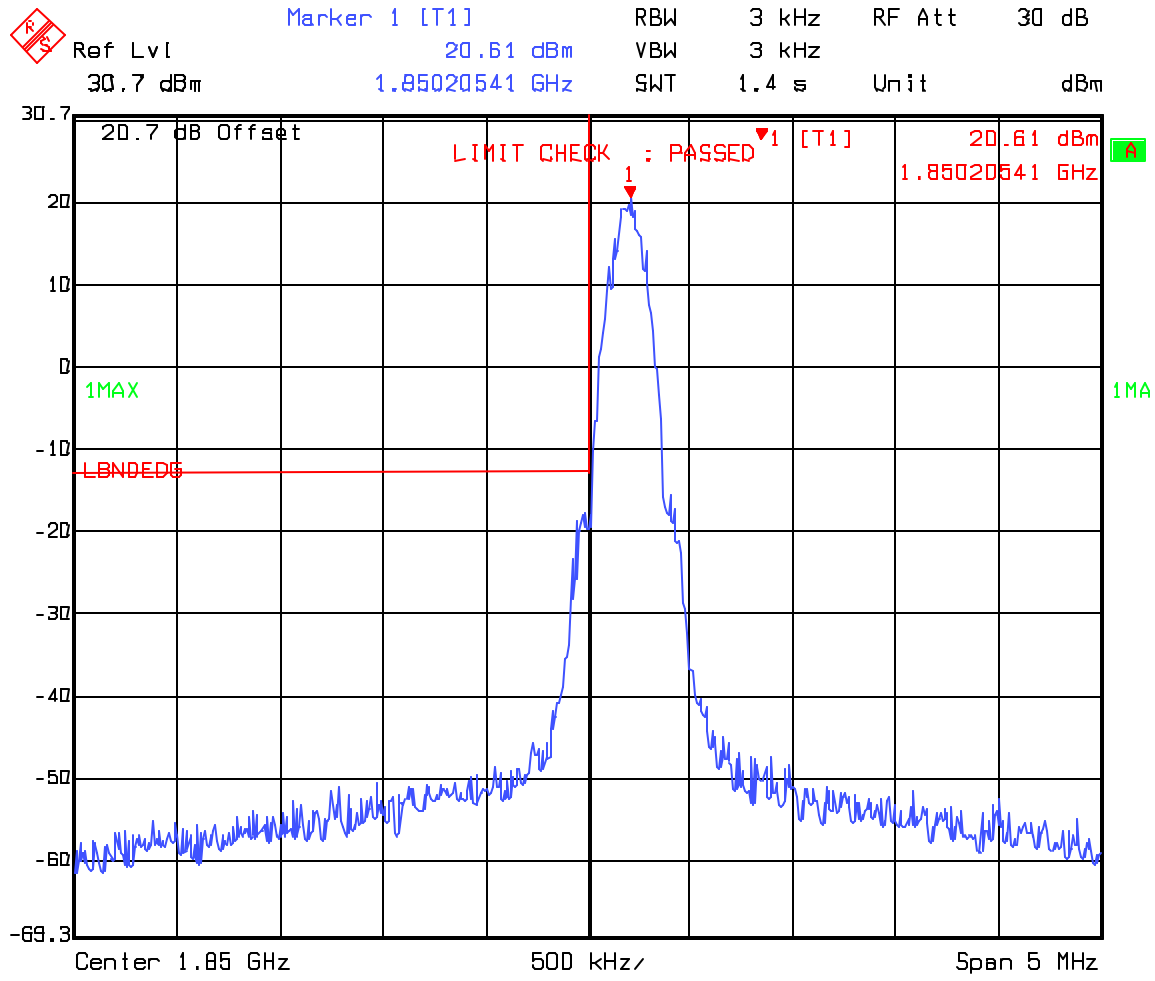

Date: 28.APR.2004 13:29:43

EQUIPMENT: GSM0107

Test Plots – Upper Band Edge

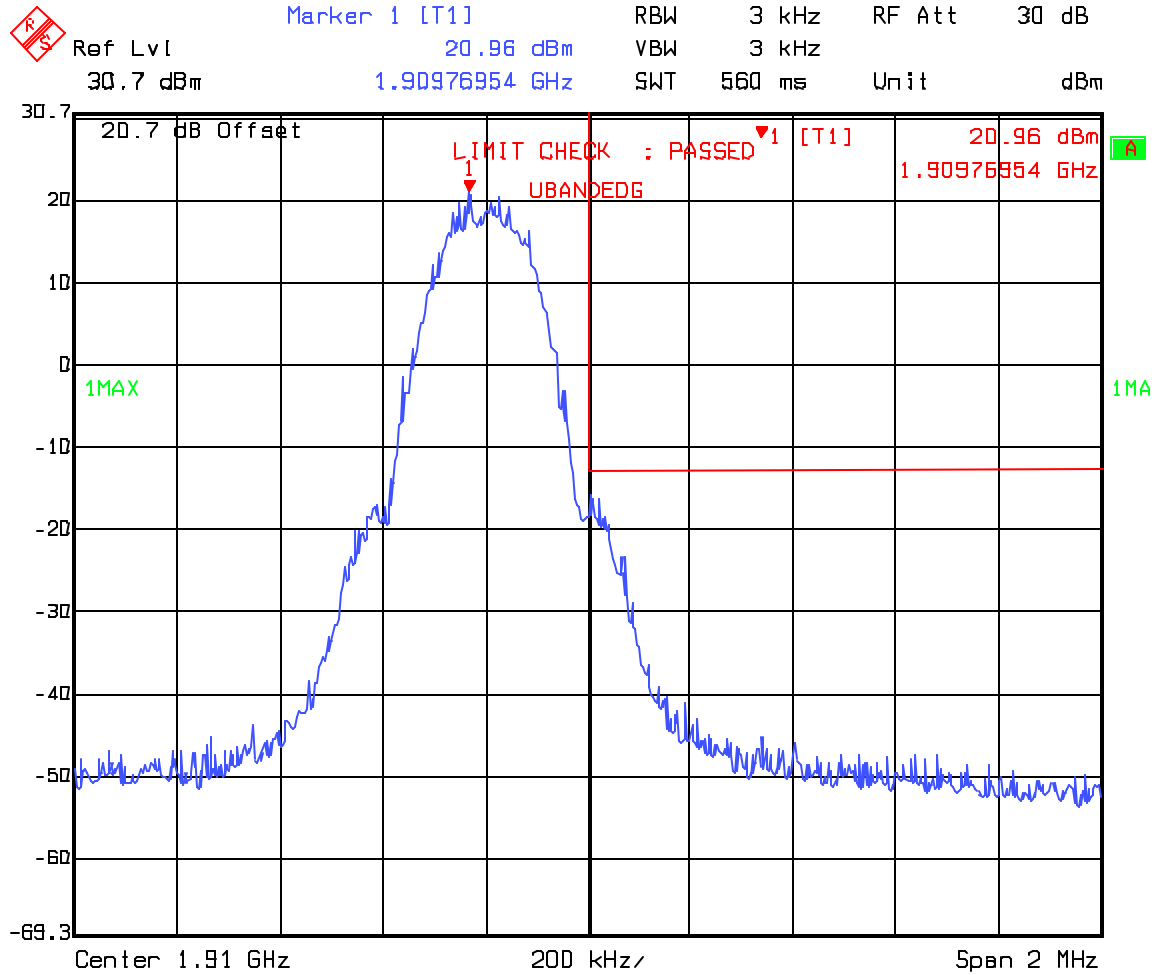

Date: 28.APR.2004 13:32:25

EQUIPMENT: GSM0107

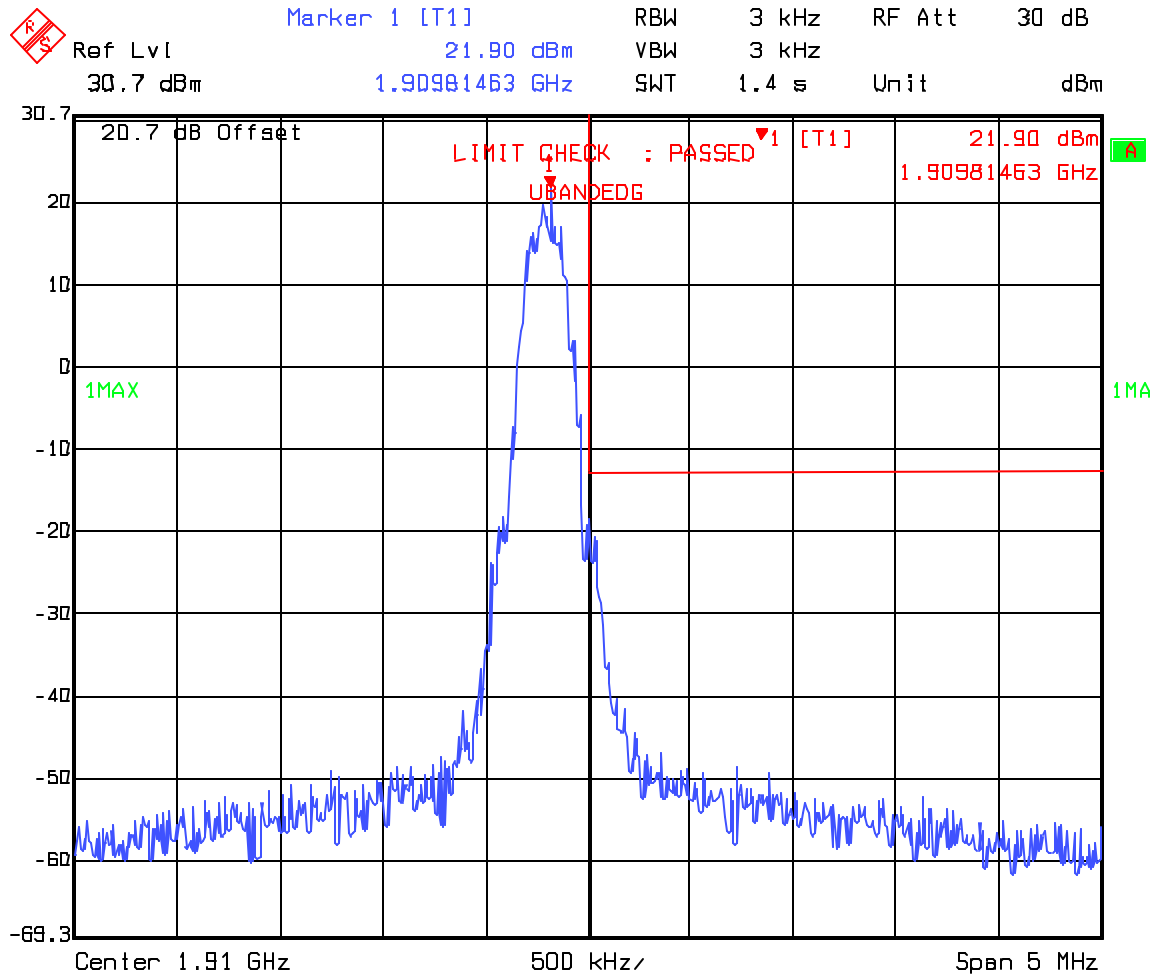

Date: 28.APR.2004 13:32:54

EQUIPMENT: GSM0107

Test Plots – Spurious Emissions at Antenna Terminals - Low Channel

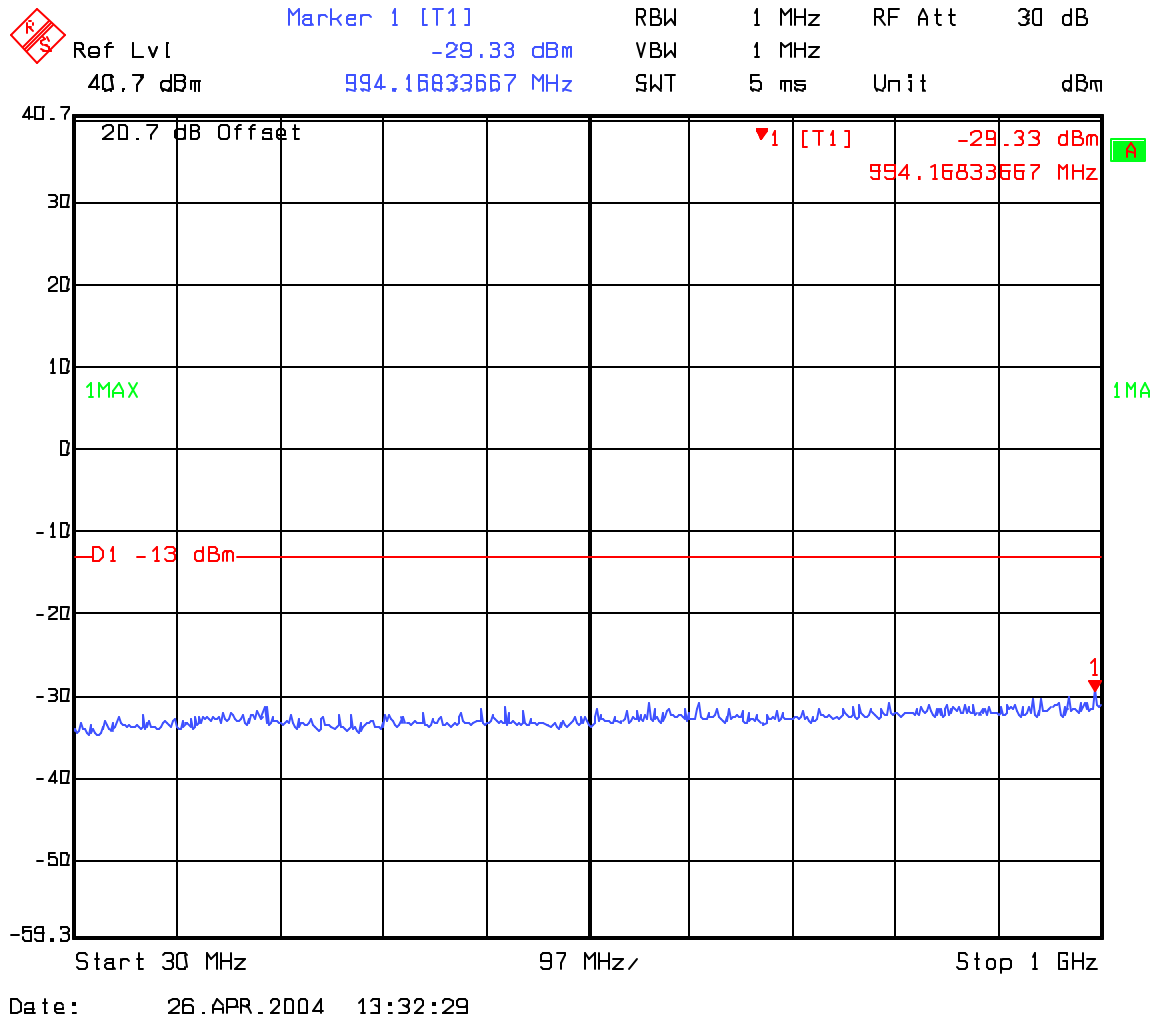

EQUIPMENT: GSM0107

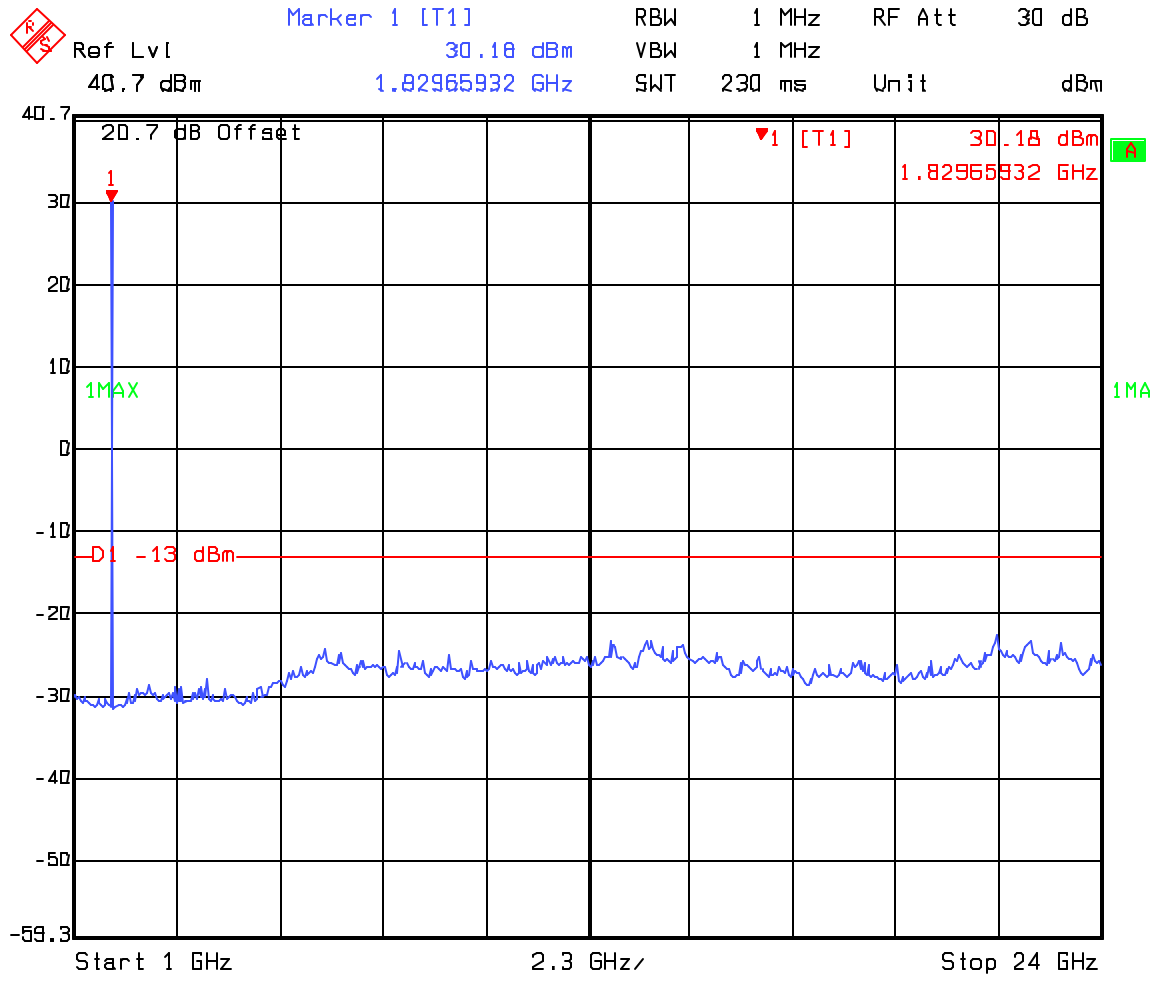

Date: 26.APR.2004 13:33:25

EQUIPMENT: GSM0107

Test Plots – Spurious Emissions at Antenna Terminals - Middle Channel

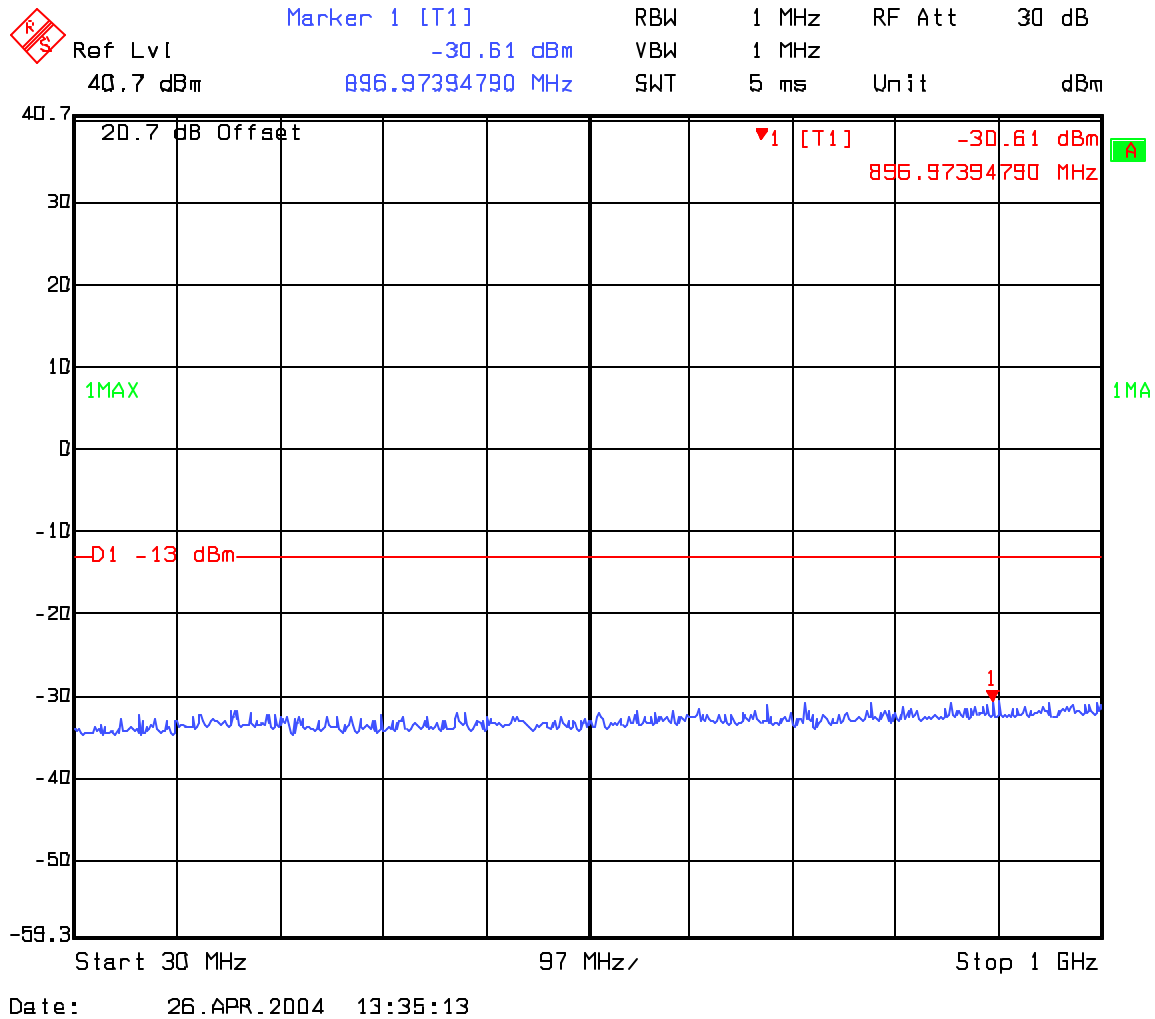

EQUIPMENT: GSM0107

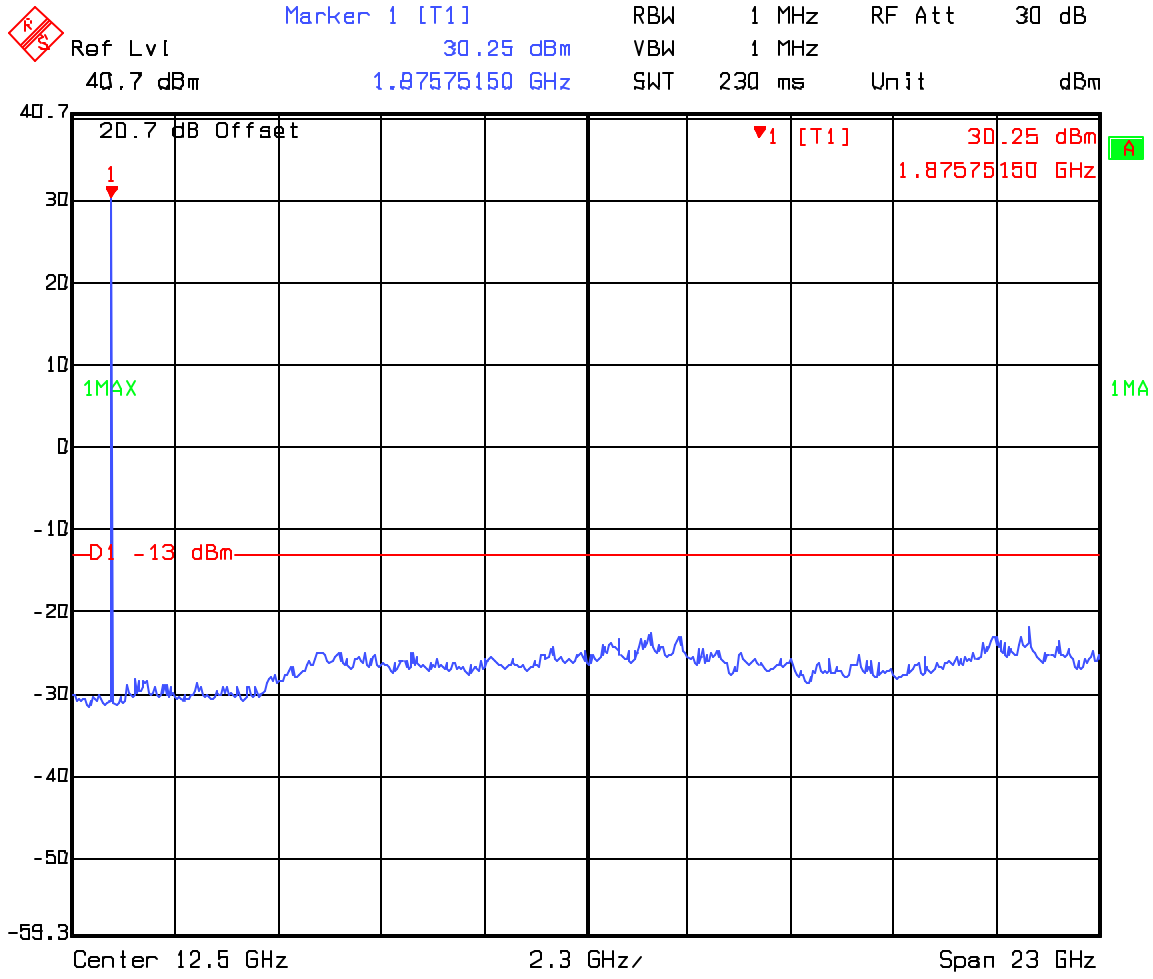

Date: 26.APR.2004 13:37:14

EQUIPMENT: GSM0107

Test Plots – Spurious Emissions at Antenna Terminals - Upper Channel

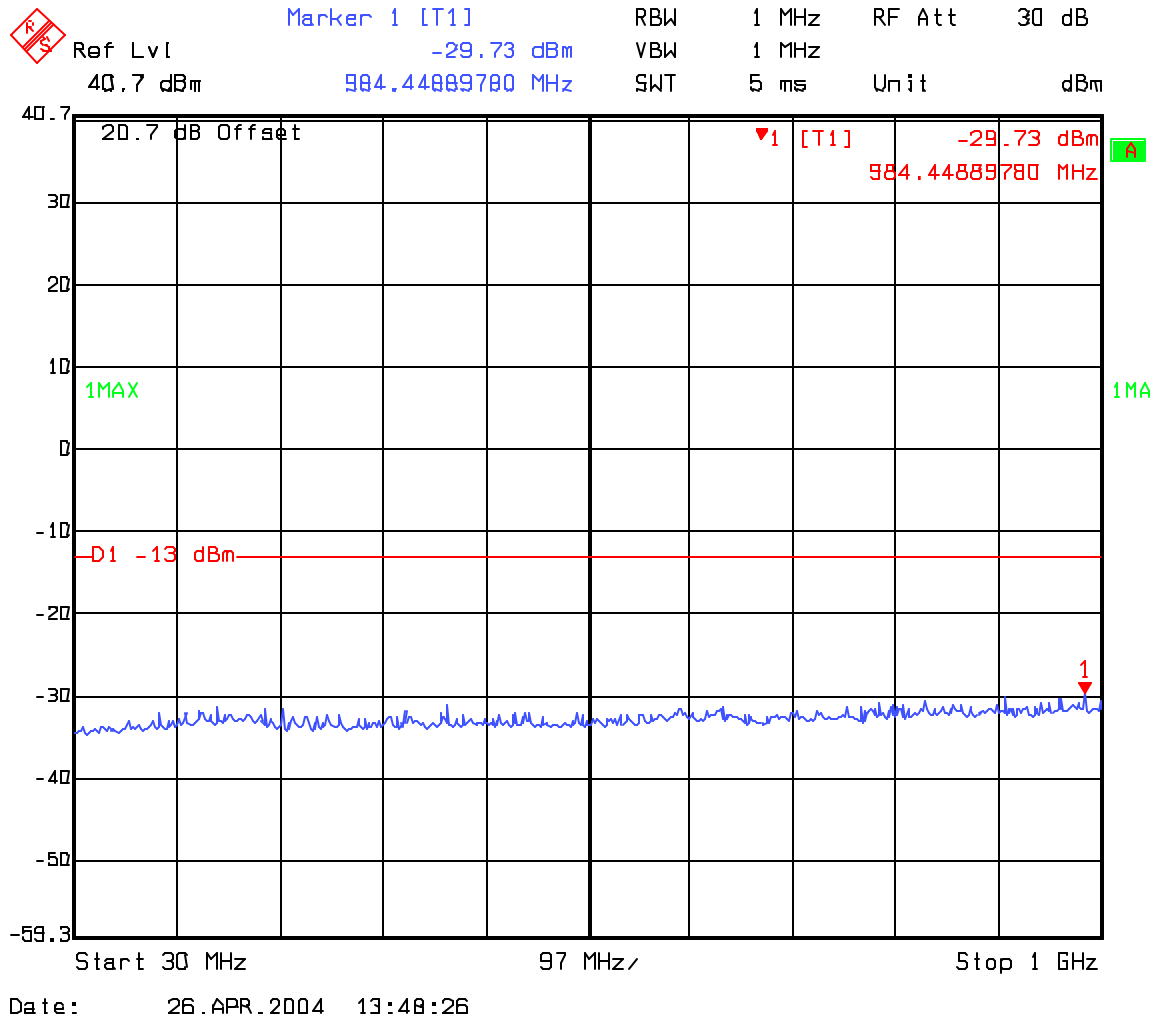

EQUIPMENT: GSM0107

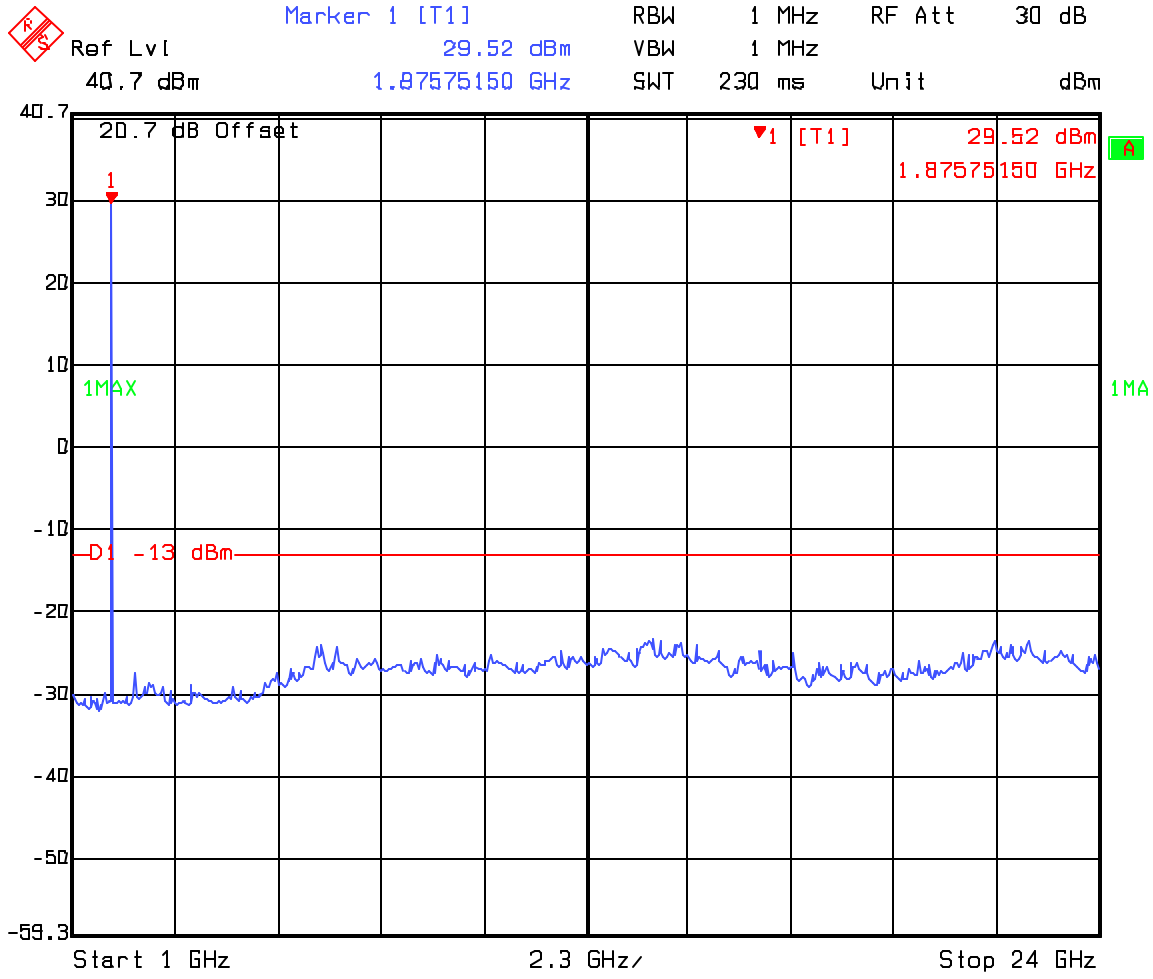

Date: 26.APR.2004 13:49:06

EQUIPMENT: GSM0107

Section 6. Field Strength of Spurious

NAME OF TEST: Field Strength of Spurious	PARA. NO.: 24.238
TESTED BY: Eldon Berry	DATE: 22Aug03

Test Results: Complies.

Test Data: See attached table.

EQUIPMENT: GSM0107

Test Data - Radiated Emissions

EIRP Substitution Method

Page 1 of 1

Job No.: 3L0345R Date: 8/22/03 Complete X
 Specification: PT 24 Temperature(°C): 22 Preliminary _____
 Tested By: Eldon Berry Relative Humidity(%) 50
 E.U.T.: GSM0107
 Configuration: EUT on test fixture.
 Sample No: 1
 Location: AC 3 RBW: 1 MHz Measurement
 Detector Type: Peak VBW: 1 MHz Distance: 3 m

Test Equipment Used

Antenna: 1304 Directional Coupler: _____
 Pre-Amp: 1016 Cable #1: 1484
 Filter: 1482 Cable #2: 1485
 Receiver: 1464 Cable #3: _____
 Attenuator #1: _____ Cable #4: _____
 Attenuator #2: _____ Mixer: _____
 Additional equipment used: _____
 Measurement Uncertainty: +/-1.7 dB

Frequency (MHz)	Meter Reading (dBm)	Correction Factor (dB)	Pre-Amp Gain (dB)	Substitution Antenna Gain (dBi)	EIRP (dBm)	EIRP (mW)	Polarity	Comments
3760.4	-71.3	43.3	0	10.7	-17.3	0.0188	V	Channel 662
5640.6	-61.0	39.8	28.5	11.4	-38.3	0.0001	V	
7520.8	-62.5	41.8	34.1	11.3	-43.5	0.0000	V	
9401	-54.5	41.3	33.4	11.7	-34.9	0.0003	V	
11281.2	-43.2	43.7	34.6	12.5	-21.6	0.0069	V	
13161.4	-60.0	45.8	34.5	11.9	-36.8	0.0002	V	
15041.6	-63.0	45.2	32	12.8	-37.0	0.0002	V	
16921.8	-63.0	46.0	33.3	14.5	-35.8	0.0003	V	
3760.4	-75.0	35.5	0	10.7	-28.8	0.0013	H	
5640.6	-63.8	37.8	28.5	11.4	-43.1	0.0000	H	
7520.8	-62.7	41.5	34.1	11.3	-44.0	0.0000	H	
9401	-57.7	42.3	33.4	11.7	-37.1	0.0002	H	
13161.4	-63.0	47.8	30.3	11.9	-33.6	0.0004	H	

Notes: Searched spectrum to the 10th harmonic of carrier

NOTE: The correction factor in the above table references the pre-calibrated path loss at that frequency and is the difference between the received signal level and the input to the substitution antenna. The same antennas, cables and test range are used for calibration and for measurement.

EQUIPMENT: GSM0107

Photographs of Test Setup

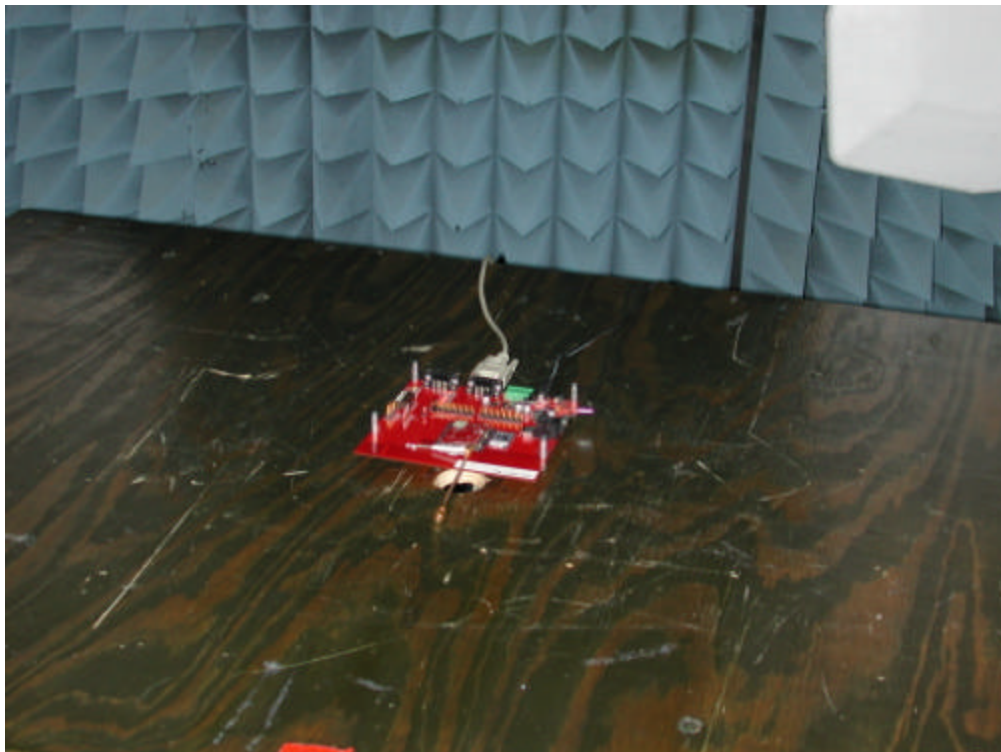
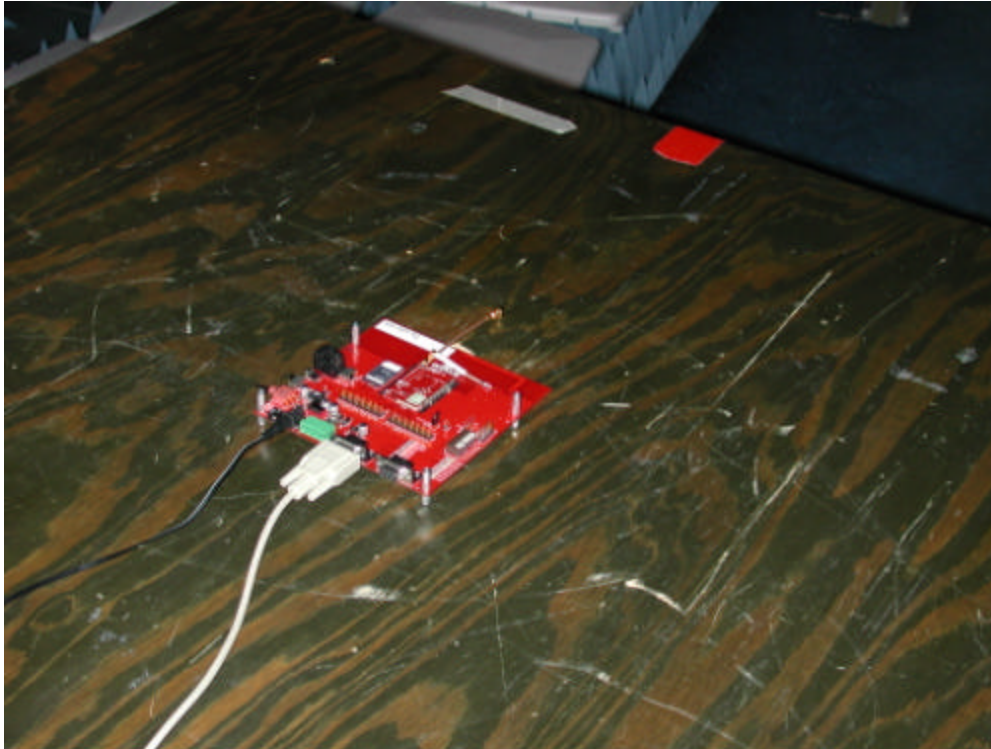

EQUIPMENT: GSM0107

Section 7. Frequency Stability

NAME OF TEST: Frequency Stability	PARA. NO.: 24.235
TESTED BY: David Light	DATE: 24Aug03

Test Results: Complies.

Equipment Used: Wavetek 3600D, Voltmeter # 1558, Thermometer # 619
 Environmental Chamber # 283

Temperature: 23 °C

Relative Humidity: 36 %

Measurement Data:

Band of Operation PCS
 Mode GPRS
 Channel 662
 Standard Test Frequency: 1880.264638 MHz
 Standard Test Voltage: 3.8 Vdc

Test Equipment: 283-1464-425-1031

Temperature	Voltage (Vdc)	Frequency (MHz)	Change (Hz)	Change (PPM)
50	3.8	1880.260830	3808	2.0
40	3.8	1880.262604	2034	1.1
30	3.8	1880.267339	-2701	-1.4
20	3.8	1880.264638	0	0.0
10	3.8	1880.267320	-2682	-1.4
0	3.8	1880.267628	-2990	-1.6
-10	3.8	1880.267898	-3260	-1.7
-20	3.8	1880.267010	-2372	-1.3
-30	3.8	1880.267143	-2505	-1.3
20	4.8	1880.264630	8	0.0
20	3.3	1880.264748	-110	-0.1

EQUIPMENT: GSM0107

Section 8. Test Equipment List

Nemko	Description	Manufacturer Model	Serial	Calibration Date	Calibration Due
1083	Cable 2m	Astrolab 32027-2-29094-72TC	N/A	CBU	N/A
	Power meter	E4418B	GB39401848	12/11/02	12/11/04
	Power sensor	E9304A	MY41494308	9/9/02	9/9/03
1604	ATTENUATOR	NARDA 776B-20	NONE	N/A	N/A
1036	SPECTRUM ANALYZER	ROHDE & FSEK30	830844/006	12/18/01	12/19/03
1304	HORN ANTENNA	ELECTRO METRICS RGA-60	6151	07/30/01	07/31/03
1016	Pre-Amp	HEWLETT PACKARD 8449A	2749A00159	07/24/03	07/24/04
1482	Band Pass	K & L 11SH10-4000/T12000-0/0	2	Cal B4	N/A
1464	Spectrum	Hewlett 8563E	3551A04428	02/11/03	02/11/05
1484	Cable 2.0-18.0 Ghz	Storm PR90-010-072	N/A	07/24/03	07/23/04
1485	Cable 2.0-18.0 Ghz	Storm PR90-010-216	N/A	07/24/03	07/23/04
283	Environmental Chamber with controller #	ENVIROTRONIC SH27 & 2030-22844	129010083	04/22/03	04/21/04
425	DIGITAL MULTIMETER	FLUKE 45-01	5930073	10/03/02	10/03/03
1031	D C power	Hewlett 6002A	2930A-12218	Not	N/A

Nemko ID	Description	Manufacturer Model Number	Serial Number	Calibration Date	Calibration Due
1036	SPECTRUM ANALYZER	ROHDE & SCHWARZ FSEK30	830844/006	12/18/01	12/19/03
1973	CABLE, 1m	KTL 0	N/A	04/14/03	04/30/04
1604	ATTENUATOR	NARDA 776B-20	NONE	N/A	N/A

ANNEX A - TEST METHODOLOGIES

EQUIPMENT: GSM0107**NAME OF TEST:** RF Power Output**PARA. NO.:** 2.1046

Minimum Standard: Para. No.24.232. Mobile/portable stations are limited to 2 watts e.i.r.p. peak power and the equipment must employ means to limit the power to the minimum necessary for successful communications.

Method Of Measurement: CDMA Per ANSI/J-STD-008
TDMA Per ANSI/J-STD-010
PCS 1900 Per ANSI/J-STD-007

Detachable Antenna:

The peak power at antenna terminals is measured using an in-line peak power meter or a spectrum analyzer.

Integral Antenna:

Test Method: TIA/EIA-603-1992, Section 2.2.12

The antenna substitution method was used to determine the equivalent radiated power at spurious frequencies. The spurious emissions were measured at a distance of 3 meters. The EUT was then replaced with a reference substitution antenna with a known gain referenced to a dipole. This antenna was fed with a signal at the spurious frequency. The level of the signal was adjusted to repeat the previously measured level. The resulting erp is the signal level fed to the reference antenna corrected for gain referenced to a dipole.

EQUIPMENT: GSM0107

NAME OF TEST: Occupied Bandwidth

PARA. NO.: 2.1049

Minimum Standard: Para. No. 24.238(b). The emission bandwidth is defined as the width of the signal between two points, one below the carrier center frequency and one above the carrier center frequency, outside of which all emissions are attenuated at least 26 dB.

Method Of Measurement:

CDMA Per ANSI/J-STD-008

Spectrum analyzer settings:

RBW: 30 kHz

VBW: ? RBW

Span: 5 MHz

Sweep: Auto

GSM Per ANSI/J-STD-007

RBW: 3 kHz

VBW: ? RBW

Span: 2 MHz

Sweep: Auto

NADC Per IS-136

RBW: 1 kHz

VBW: ? RBW

Span: 1 MHz

Sweep: Auto

EQUIPMENT: GSM0107

**NAME OF TEST: Spurious Emission at Antenna
 Terminals**

PARA. NO.: 2.1053

Minimum Standard:

Para. No.24.238(a). On any frequency outside a licensee's frequency block, the power of any emission shall be attenuated below the transmitter power by at least $43 + 10 \log (P)$ dB.

Method Of Measurement:

Spectrum analyzer settings:

CDMA Per ANSI/J-STD-008

GSM Per ANSI/J-STD-007

RBW: 1 MHz (> 1 MHz from Band Edge)
 RBW: 20 kHz (< 1MHz from Band Edge)
 VBW: ? RBW
 Sweep: Auto
 Video Avg: 6 Sweeps

RBW: 1 MHz (> 1 MHz from Band Edge)
 RBW: 3 kHz (< 1 MHz from Band Edge)
 VBW: ? RBW
 Sweep: Auto
 Video Avg: Disabled

NADC Per IS-136

RBW: 1 MHz (> 1 MHz from Band Edge)
 RBW: 1 kHz (< 1 MHz from Band Edge)
 VBW: ? RBW
 Sweep: Auto
 Video Avg: Disabled

To demonstrate compliance at band edges the frequency of the input signal is set to the lowest and highest assigned channel and the center frequency of the spectrum analyzer is set to the upper and lower edges of the appropriate frequency block.

EQUIPMENT: GSM0107

NAME OF TEST: Field Strength of Spurious Radiation	PARA. NO.: 2.1053
---	--------------------------

Minimum Standard: Para. No.24.238(a). On any frequency outside a licensee's frequency block, the power of any emission shall be attenuated below the transmitter power by at least $43 + 10 \log (P)$ dB.

Calculation Of Field Strength Limit

Test Method: TIA/EIA-603-1992, Section 2.2.12

The antenna substitution method was used to determine the equivalent radiated power at spurious frequencies. The spurious emissions were measured at a distance of 3 meters. The EUT was then replaced with a reference substitution antenna with a known gain referenced to a dipole. This antenna was fed with a signal at the spurious frequency. The level of the signal was adjusted to repeat the previously measured level. The resulting erp is the signal level fed to the reference antenna corrected for gain referenced to a dipole.

EQUIPMENT: GSM0107

NAME OF TEST: Frequency Stability**PARA. NO.: 2.1055**

Minimum Standard: Para. No. 24.235. The frequency stability shall be sufficient to ensure that the fundamental emission stays within the authorized frequency block.

Method Of Measurement: CDMA Per ANSI/J-STD-008
TDMA Per ANSI/J-STD-007
NADC Per IS-136

Frequency Stability With Voltage Variation

The E.U.T. is placed in an environmental chamber and allowed to stabilize at +20 degrees Celsius for at least 15 minutes. With the voltage input to the E.U.T. set to 85% S.T.V., the frequency is measured in 30 second intervals for a period of 5 minutes. This procedure is repeated at 100% S.T.V. and 115% S.T.V.

Frequency Stability With Temperature Variation

The input voltage to the E.U.T. is set to S.T.V. and the temperature of the environmental chamber is varied in 10 degree steps from -30 degrees C to +50 degrees C. The E.U.T. is allowed to stabilize at each temperature and the frequency is measured in 30 second intervals for a period of 5 minutes.

ANNEX B - TEST DIAGRAMS

EQUIPMENT: GSM0107

Para. No. 2.1046 - R.F. Power Output

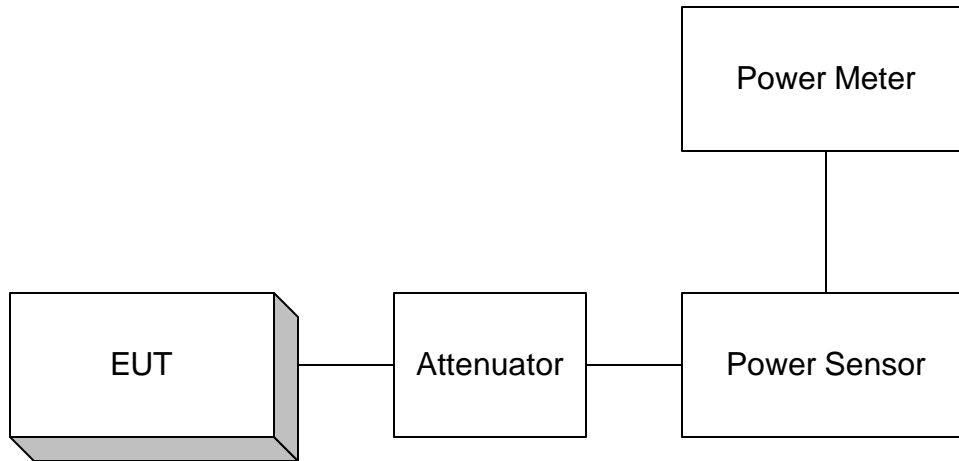

Para. No. 2.1049 - Occupied Bandwidth



EQUIPMENT: GSM0107

Para. No. 2.1053 Spurious Emissions at Antenna Terminals

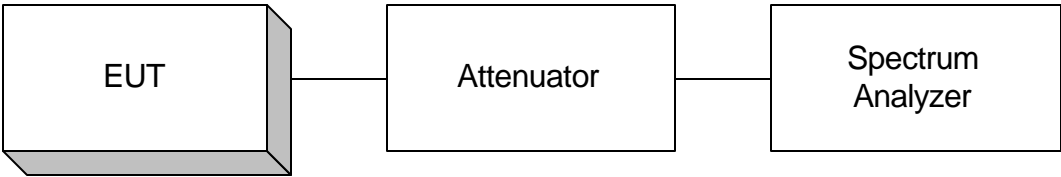

Para. No. 2.1053- Field Strength of Spurious Radiation

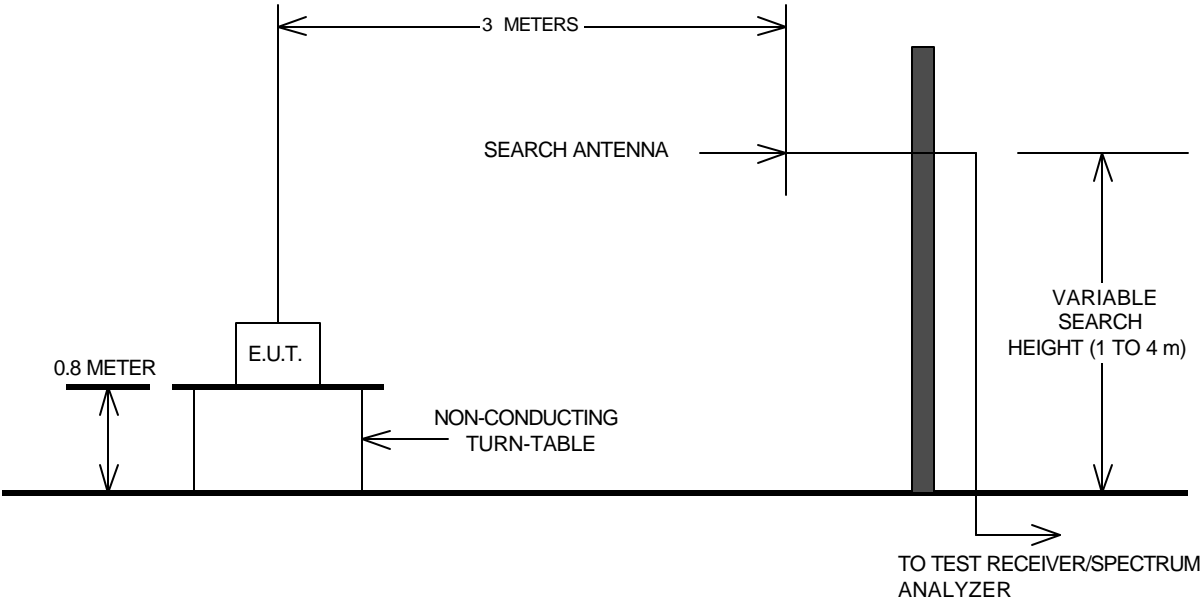

EQUIPMENT: GSM0107

Para. No. 2.1055 - Frequency Stability

