

MiSTATION

D221 User Manual



Revision: R00
(September 2008)

TRADEMARKS

The Bluetooth[®] word mark and logos are registered trademarks owned by Bluetooth SIG, Inc.
All brand and product names are trademarks or registered trademarks of their respective companies.

NOTE

The information in this manual is subject to change without notice.

Table of Contents

Table of Contents	i
Preface	v
Safety Precautions.....	v
About the Battery.....	v
About the AC Adapter.....	vi
Notational Conventions.....	vii
Chapter 1	1-1
Getting Started	1-1
Getting the Computer Running.....	1-2
Unpacking.....	1-2
Connecting to AC Power.....	1-2
Opening the Cover.....	1-3
Turning On and Off the Computer.....	1-4
Taking a Look at the Computer.....	1-6
Right-Side Components.....	1-6
Left-Side Components.....	1-7
Bottom Components.....	1-8
Top-open Components.....	1-9
Where to Go from Here.....	1-11
Chapter 2	2-1
Operating Your Computer	2-1
Starting and Stopping the Computer.....	2-2
Starting the Computer.....	2-2
Stopping the Computer.....	2-2

Using the Keyboard.....	2-4
Hot Keys	2-5
Using the Touchpad	2-7
Configuring the Touchpad	2-8
Using the Video Features	2-9
Configuring the Display Modes	2-9
Using the Audio Features	2-10
Connecting Audio Devices	2-10
Using the Communication Features	2-12
Using the LAN	2-12
Using the WLAN	2-12
Using the Bluetooth Feature.....	2-14
Chapter 3	3-1
Managing Power.....	3-1
AC Adapter	3-2
Battery Pack	3-3
Charging the Battery Pack	3-3
Initializing the Battery Pack.....	3-3
Checking the Battery Level.....	3-4
Replacing the Battery Pack.....	3-4
Battery Low Signals and Actions.....	3-5
Power Management.....	3-7
Hibernation.....	3-8
Power-Saving Tips	3-9
Chapter 4	4-1
Expanding Your Computer.....	4-1
Connecting an External Monitor	4-2
Connecting a USB Device.....	4-3
Using the Card Reader	4-4
Internal Components Upgrade.....	4-5

Chapter 5	5-1
Using BIOS Setup	5-1
When and How to Use BIOS Setup	5-2
When to Use	5-2
Starting BIOS Setup	5-2
Moving Around and Making Selections	5-4
Main Menu	5-5
Advanced Menu	5-6
Boot Menu	5-8
Security Menu	5-9
Exit Menu	5-11
Chapter 6	6-1
Using the Software Drivers	6-1
How to Use the Driver Disc	6-2
Chapter 7	7-1
Caring for the Computer	7-1
Protecting the Computer	7-2
Using the Windows Security Center	7-2
Using the Password	7-3
Using the Cable Lock	7-3
Taking Care of the Computer	7-4
Location Guidelines	7-4
General Guidelines	7-4
Cleaning Guidelines	7-5
Battery Pack Guidelines	7-5
When Traveling	7-6
Chapter 8	8-1
Troubleshooting	8-1
Preliminary Checklist	8-2
Solving Common Problems	8-3

Battery Problems.....	8-3
Bluetooth Problems.....	8-3
Display Problems.....	8-4
Hardware Device Problems.....	8-5
Hard Disk Drive Problems.....	8-5
Keyboard, Mouse and Touchpad Problems.....	8-5
LAN Problems.....	8-6
WLAN Problems.....	8-6
Power Management Problems.....	8-8
Software Problems.....	8-8
Sound Problems.....	8-9
Startup Problems.....	8-9
Other Problems.....	8-10
Resetting the Computer.....	8-11
Recovering Pre-installed Software.....	8-12
Specifications.....	A-1
Regulatory Information.....	B-1
Class B Regulations.....	B-2
USA.....	B-2
Canada.....	B-3
Europe.....	B-4
Index	1

Preface

Safety Precautions

About the Battery

DANISH

ADVARSEL! Lithiumbatteri – Eksplosionsfare ved fejlagtig håndtering. Udskiftning må kun ske med batteri af samme fabrikat og type. Levér det brugte batteri tilbage til leverandøren.

NORWEGIAN

ADVARSEL: Eksplosjonsfare ved feilaktig skifte av batteri. Benytt samme batteritype eller en tilsvarende type anbefalt av apparatfabrikanten. Brukte batterier kasseres i henhold til fabrikantens instruksjoner.

SWEDISH

VARNING: Explosionsfara vid felaktigt batteribyte. Använd samma batterityp eller en ekvivalent typ som rekommenderas av apparattillverkaren. Kassera använt batteri enligt fabrikantens instruktion.

FINNISH

VAROITUS: Paristo voi räjähtää, jos se on virheellisesti asennettu. Vaihda paristo ainoastaan valmistajan suosittelemaan tyyppiin. Hävitä käytetty paristo valmistajan ohjeiden mukaisesti.

ENGLISH

CAUTION: Danger of explosion if battery is incorrectly replaced. Replace only with the same or equivalent type recommended by the equipment manufacturer. Discard used batteries according to manufacturer's instructions.

DEUTSCH

VORSICHT: Explosionsgefahr bei unsachgemäßem Austausch der Batterie. Ersatz nur durch denselben oder einen vom Hersteller empfohlenen gleich-wertigen Typ. Entsorgung gebrauchter Batterien nach Angaben des Herstellers.

FRENCH

ATTENTION: Il y a danger d'explosion s'il y a remplacement incorrect de la batterie. Remplacer uniquement avec une batterie du même type ou d'un type équivalent recommandé par le constructeur. Mettre au rebut les batteries usagées conformément aux instructions du fabricant.

Attention (for USA Users)

The product that you have purchased contains a rechargeable battery. The battery is recyclable. At the end of its useful life, under various state and local laws, it may be illegal to dispose of this battery into the municipal waste stream. Check with your local solid waste officials for details in your area for recycling options or proper disposal.

About the AC Adapter

- Use only the AC adapter supplied with your computer. Use of another type of AC adapter will result in malfunction and/or danger.
- Do not use the adapter in a high moisture environment. Never touch the adapter when your hands or feet are wet.
- Allow adequate ventilation around the adapter when using it to operate the device or charge the battery. Do not cover the AC adapter with paper or other objects that will reduce cooling. Do not use the AC adapter while it is inside a carrying case.
- Connect the adapter to a proper power source. The voltage requirements are found on the product case and/or packaging.
- Do not use the adapter if the cord becomes damaged.
- Do not attempt to service the unit. There are no serviceable parts inside. Replace the unit if it is damaged or exposed to excess moisture.

Notational Conventions

Throughout this manual, the following conventions are used to distinguish elements of text.

NOTE: identifies additional information that requires special attention.

CAUTION: identifies important information that, if not followed, may result in loss of data or damage to the computer.

Keyboard keys are shown in a bold typeset. For example:

Press the **Enter** key to complete.

When keys are joined by a plus sign (+), press the first key, and, while keeping the first key down, press the remaining keys, finally release all the keys. When necessary, keys are also shown in graphics.

A title, command, setup item, or button that you can see on the screen is shown in boldface. A value or an option that you can select for a setup item is shown in italic. For example:

Select **When I press the power button**, set it to *Shut down*, and then click the **Save changes** button.

Getting Started

Congratulations on purchasing this computer.

Your computer incorporates desktop computer capabilities into a compact notebook-sized package. It can greatly enhance your productivity either in the office or at home. And, of course, wherever you need it, the computer is ready and easy “to go.”

This chapter first tells you step by step how to get the computer up and running. You will find instructions for these procedures:

- Unpacking
- Connecting to AC power
- Opening the cover
- Turning on the computer
- Turning off the computer

Then, you will find a section briefly introducing the external components of the computer. And the last section navigates you to the information you may need after the computer is ready for use.

Getting the Computer Running

This section guides you through the procedures for getting the computer ready for operation.

Unpacking

After unpacking the shipping carton, you should find these standard items:

- Notebook computer
- Accessories:
 - AC adapter
 - AC power cord

Inspect all the items. If any item is damaged or missing, notify your dealer immediately.

Keep the shipping carton and packing materials in case you need to ship or store the computer in the future.

Connecting to AC Power

The computer operates either on the external AC power or internal battery power. It is suggested that you use AC power when you start up the computer for the very first time.

CAUTION: Use only the AC adapter included with your computer. Using other AC adapters may damage the computer.

1. Make sure that the computer is turned off.
2. Plug the DC cord of the AC adapter to the power connector of the computer (❶).

3. Plug the female end of the AC power cord to the AC adapter and the male end to an electrical outlet (2).

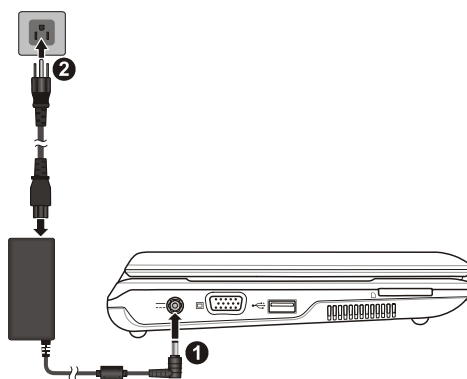

4. When the AC adapter is connected, power is being supplied from the electrical outlet to the AC adapter and onto your computer. Now, you are ready to turn on the computer.

CAUTION:

- When you disconnect the AC adapter, disconnect from the electrical outlet first and then from the computer. A reverse procedure may damage the AC adapter or the computer.
- When unplugging the connector, always hold the plug head. Never pull on the cord.

NOTE: When the AC adapter is connected, it also charges the battery pack. For information on using battery power, see Chapter 3.

Opening the Cover

CAUTION: Be gentle when opening and closing the cover. Opening it vigorously or slamming it shut could damage the computer.

Open the top cover by lifting up the cover. You can tilt the cover forward or backward for optimal viewing clarity.

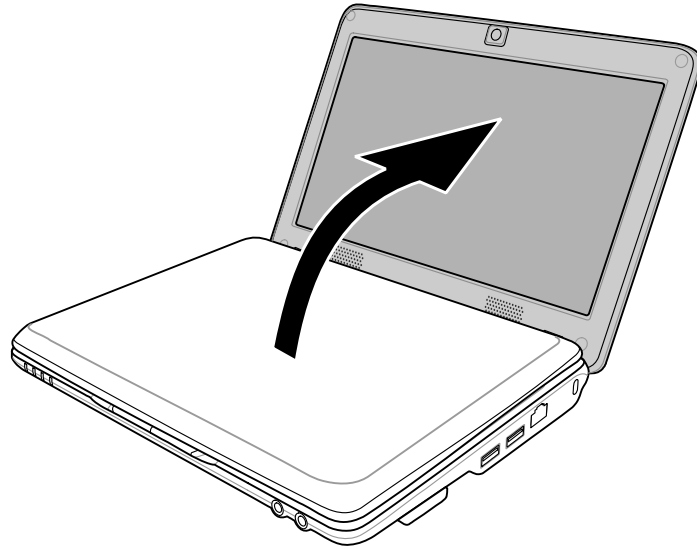

Turning On and Off the Computer

Turning On

NOTE: As a safety feature, you can only turn on the computer when the top cover is open. This prevents an accidental power-on during transport.

1. Make sure that the computer is connected to AC power.
2. Press the power button.

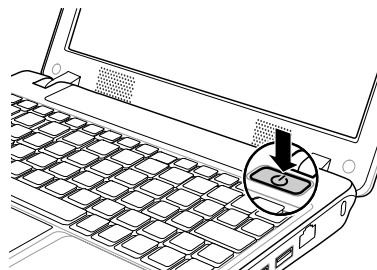

3. Each time the computer is turned on, it performs a Power-On Self Test (POST), and the operating system such as Windows should start.

Turning Off

To turn off the computer power, use the “Shut Down” command of your operating system.

NOTE: There are other ways you can stop the computer so that you will be back to where you left off when you next turn on the computer. (See “Stopping the Computer” in Chapter 2 for information.)

CAUTION: If you have to turn the computer on again immediately after turning it off, wait for at least five seconds. Turning the computer off and on rapidly can damage it.

Taking a Look at the Computer

This section identifies the external components of the computer and briefly describes the function of each component.

NOTE: Depending on the model you purchased, the appearance of your computer may not be exactly the same as those shown in this manual.

Right-Side Components

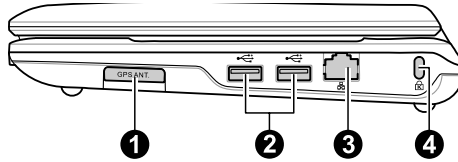

Ref	Component	Description	See Also
❶	GPS Antenna (optional)	Receives signals from the GPS satellites overhead.	
❷	USB Port ⇄	Connects a USB device, such as a flash disk, printer, digital camera, joystick, and more.	P. 4-3
❸	RJ-45 Connector	Connects the LAN cable.	P. 2-12
❹	Kensington Lock	Locks the computer to a stationary object for security.	P. 7-3

Left-Side Components

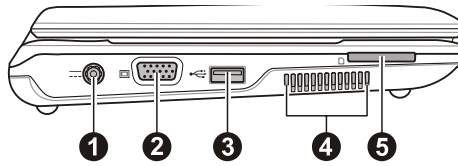

Ref	Component	Description	See Also
❶	Power Connector	Connects the AC adapter	P. 1-2
❷	VGA Connector	Connects an external display	P. 4-2
❸	USB Port 	Connects a USB device, such as a flash disk, printer, digital camera, joystick, and more.	P. 4-3
❹	Ventilation Opening	Enables heat emission.	
❺	Card Reader	Accepts a SD (Secure Digital), SDHC (Secure Digital High Capacity) or MMC (MultiMediaCard) card for removable storage media.	P. 4-4

Bottom Components

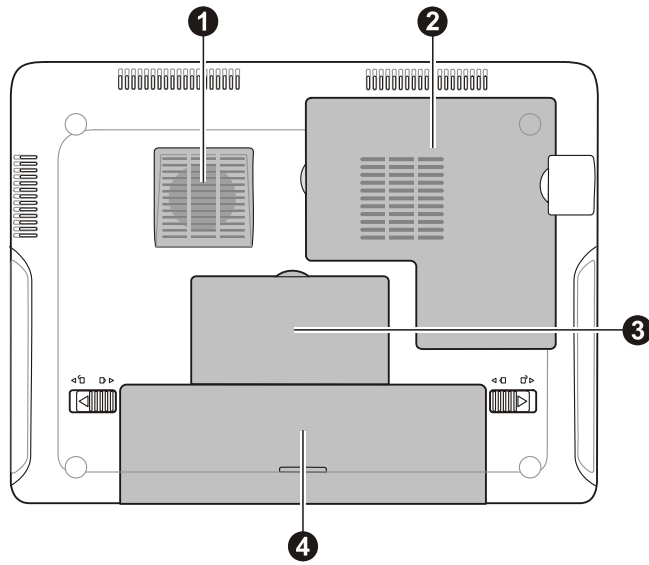





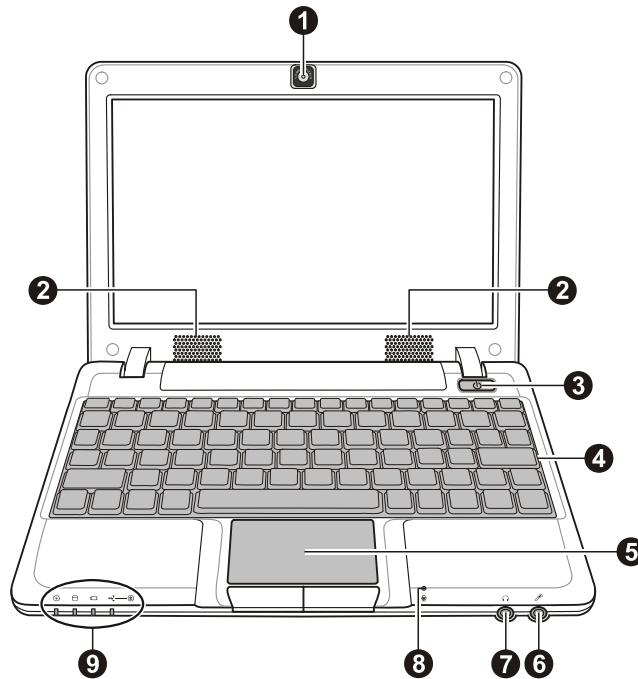

Ref	Component	Description	See Also
①	Ventilation Opening	Enables heat emission.	
②	Hard Disk Drive	Inside is the hard disk drive.	
③	Memory Slot	Inside is the memory slot.	
④	Battery Pack	Supplies power to your computer when external power is not connected.	P. 3-3

Top-open Components



Ref	Component	Description	See Also
①	Camera Lens	Takes still pictures or records videos.	
②	Stereo Speaker	Sends out sound and voice from the computer.	P. 2-10
③	Power Button	Turns the computer power ON and OFF.	P. 1-4
④	Keyboard	Serves as the data input device of the computer.	P. 2-4
⑤	Touchpad	Serves as the pointing device of the computer.	P. 2-7
⑥	Microphone Connector 	Connects an external microphone.	P. 2-10

Ref	Component	Description	See Also
7	Audio Output Connector 	Connects a set of headphones, external speakers with amplifier, or an audio recording device.	P. 2-10
8	Microphone 	Receives sound and voice for the computer.	P. 2-10
9	Indicators	Show the current status of the computer's devices.	
		Power status indicator Glows in green when the computer is turned on. Blinks in green when the computer is in the standby mode.	
		Hard disk drive in-use indicator	
		Battery charge indicator LED-off when the battery is fully charged. Glows in green when the battery capacity is between 90 to 99%. Glows in amber when the battery capacity is between 20 to 90%. Blinks in amber when the battery capacity is less than 20%.	P. 3-3
		WLAN Glows in green when the wireless LAN (WLAN) radio is on.	P. 2-12

Where to Go from Here

As your computer is ready for operation, you may want to do any of the following now:

For this purpose ...	Do this ...
To know more about the computer ...	Go on to the next chapter.
To install the operating system if your dealer has not already done so ...	See the operating system manual.
To know more about the operating system ...	Read the operating system manual.
To install the drivers if your dealer has not already done so ...	See Chapter 6.
To set a power-on password ...	See “Security Menu” in Chapter 5.
To charge the battery pack for the first time ...	See “Charging the Battery Pack” in Chapter 3.

Operating Your Computer

This chapter provides information about the use of the computer.

If you are new to computers, reading this chapter will help you learn the operating basics. If you are already a computer user but are new to notebook computers, you may choose to read only the parts containing information unique to your computer.

Described in this chapter are the operating basics of these components:

- Keyboard
- Touchpad

And these features:

- Starting and stopping the computer
- Video features
- Audio features
- Communication features

Starting and Stopping the Computer

There are a number of ways to start and stop the computer.

Starting the Computer

You always start the computer using the power button.

A computer starts up with an operating system (OS) existing on the storage device such as the hard disk and optical disc. The computer will automatically load the OS after you turn it on. This process is called booting.

NOTE: An operating system is the platform for all your software application programs to run on. Your computer uses the Microsoft Windows operating system.

Stopping the Computer

When you finish a working session, you can stop the computer by turning off the power or leaving the computer in Standby or Hibernation mode:

To stop in this mode ...	Do this ...	To start up or resume again
Off	Follow the shutdown procedure of your operating system. This can prevent loss of unsaved data or damage to your software programs. If the system is locked up because of hardware or software problems, press the power button to turn off the computer.	Press the power button.
Standby	Depending on your settings in Windows, you can place the computer in Standby mode by: <ul style="list-style-type: none">■ Closing the display cover■ Pressing the Fn-F9 hot key■ Pressing the power button	Press any key.

To stop in this mode ...	Do this ...	To start up or resume again
Hibernation	Depending on your settings in Windows, you can place the computer in Hibernation mode by: <ul style="list-style-type: none"> ■ Closing the display cover ■ Pressing the Fn-F9 hot key ■ Pressing the power button 	Press the power button.

See “Power Management” in Chapter 3 for more information on Power Management.

Using the Keyboard

The keyboard can be divided into four major areas plus an Fn key.



Ref	Component	Description
①	Function Keys	Function keys are multi-purpose keys that perform functions defined by individual programs.
②	Cursor-Control Keys	Cursor-control keys are generally used for editing purposes. They are Home, End, Page Up, and Page Down. When used with Fn key, they become Left, Right, Up, and Down arrow keys.
③	Numeric Keypad	When Num Lock is on and first press and hold Fn, then press the numeric keys, the numeric keys embedded in the typewriter keys are activated, which means you can use these keys to enter numerals. When Num Lock is off, they become typewriter keys.
④	Typewriter Keys	Typewriter keys are similar to the keys on a typewriter. Several keys are added, such as the Ctrl, Alt, Esc and lock keys, for special purposes. When the lock keys are pressed, their corresponding indicators light up.

Ref	Component	Description
5	Fn Key	<p>The Fn key, at the lower left corner of the keyboard, is used with another key to perform the alternative function of a key. The letter “Fn” and the alternative functions are identified by the color of blue on the keytop. To perform a desired function, first press and hold Fn, then press the other key.</p> <p>Hot key functions are assigned to F1, F2, F3, F4, F5, F6, F7, F8, and F9 by your computer (see “Hot Keys” for details).</p>

Hot Keys

Hot keys refer to a combination of keys that can be pressed any time to activate special functions of the computer. Most hot keys operate in a cyclic way. Each time a hot key combination is pressed, it shifts the corresponding function to the other or next choice.

You can easily identify the hot keys with the icons imprinted on the keytop. The hot keys are described next.

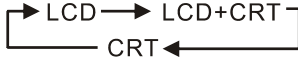
Key	Description
Fn + F1	Switches the wireless LAN radio on and off.
Fn + F2	Switches the system sound output off (mute) and on.
Fn + F3	Decreases the sound volume.
Fn + F4	Increases the sound volume.
Fn + F5	Decreases the LCD brightness.
Fn + F6	Increases the LCD brightness.
Fn + F7	<p>Switches the display output to one of the following when external devices are connected.</p> <p>Upon booting the system with CRT:</p>  <pre> graph LR LCD --> LCD+CRT LCD+CRT --> CRT CRT --> LCD </pre> <p>NOTE: This function only applies to Plug & Play display devices.</p>
Fn + F8	Switches the Bluetooth radio on and off.

Key	Description
Fn + F9	Serves as the standby button that you can define with Windows' Power Options. (See "Power Management" in Chapter 3.)

Windows Keys

The keyboard has two keys that perform Windows-specific functions.

The  Windows Logo key opens the Start menu and performs software-specific functions when used in combination with other keys.

The  Application key usually has the same effect as a right mouse click.

Using the Touchpad

CAUTION: Do not use a sharp object such as a pen on the touchpad. Doing so may damage the touchpad surface.

NOTE: For optimal performance of the touchpad, keep your fingers and the pads clean and dry. When tapping on the pad, tap lightly. Do not use excessive force.

The touchpad is a pointing device that allows you to communicate with the computer by controlling the location of the pointer on the screen and making selection with the buttons.

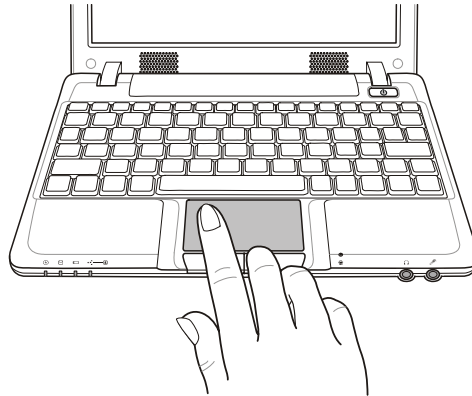

The touchpad consists of a rectangular pad and a left and right buttons. To use the touchpad, place your forefinger or thumb on the pad. The rectangular pad acts like a miniature duplicate of your display. As you slide your fingertip across the pad, the pointer (also called cursor) on the screen moves accordingly. When your finger reaches the edge of the pad, simply relocate yourself by lifting the finger and placing it on the other side of the pad.

Here are some common terms that you should know when using the touchpad:

Term	Action
Point	Move your finger on the pad until the cursor points to the selection on the screen.

Term	Action
Click	Press and release the left button. –or– Tap gently anywhere on the pad.
Double-click	Press and release the left button twice in quick succession. –or– Tap twice on the pad rapidly.
Drag and drop	Press and hold the left button, then move your finger until you reach your destination (drag). Finally, release the button (drop) when you finish dragging your selection to the destination. The object will drop into the new location. –or– Gently tap twice on the pad and on the second tap, keep your finger in contact with the pad. Then, move your finger across the pad to drag the selected object to your destination. When you lift your finger from the pad, the selected object will drop into place.
Scroll	To scroll is to move up and down or left and right in the working area on the screen. This function works only after you install the touchpad driver supplied with the computer and it may not work for all applications.

TABLE NOTE: If you swap the left and right buttons, “tapping” on the touchpad as an alternative method of pressing the left button will no longer be valid.

Configuring the Touchpad

You may want to configure the touchpad to suit your needs. For example, if you are a left-handed user, you can swap the two buttons so that you can use the right button as the left button and vice versa. You can also change the size of the on-screen pointer, the speed of the pointer, and so on.

To configure the touchpad in Windows, go to Settings → Control Panel → Mouse.

Using the Video Features

The video subsystem of your computer features:

- 8.9-inch TFT (Thin-Film Transistor) color LCD display with 1024 × 600 resolution.
- Simultaneous display on LCD and external display, which is useful when you have a presentation as you can control the screen from your computer and face the audience at the same time.
- Multi-display capability, which allows you to expand your desktop on the screen to another display device so that you have more desktop space to work on.
- Power Management

NOTE: Your computer is pre-installed with the video driver that supports the multi-display capability or enhanced video capabilities.

NOTE: The computer enters the Standby or Hibernation mode when the LCD is closed. If you want to use the computer with the LCD closed, set *Do Nothing* to the **When I Close the lid** option in the **Control Panel** → **Power Options** → **Advanced Properties**. Thus the computer does not enter the Standby or Hibernation mode when the LCD is closed.

Configuring the Display Modes

NOTE: When using an external CRT monitor, the resolution depends on the CRT monitor's supported resolution.

Your computer has been set to a default resolution and number of colors before shipment. You can view and change display settings through your operating system. See your operating system documentation or online help for specific information.

For displaying in higher resolutions, you can connect an external monitor that supports higher resolutions. (See “Connecting an External Monitor” in Chapter 4 for more information.)

Using the Audio Features

NOTE: Your computer is pre-installed with the audio driver that supports the enhanced audio capabilities.

NOTE: If you experience interference while recording, try lowering the microphone recording volume.

The audio subsystem of your computer features:

- Built-in sound system for recording and playing sound on your computer
- Set of speakers (❶)
- Built-in microphone (❷) and
- External audio connectors (❸ and ❹)

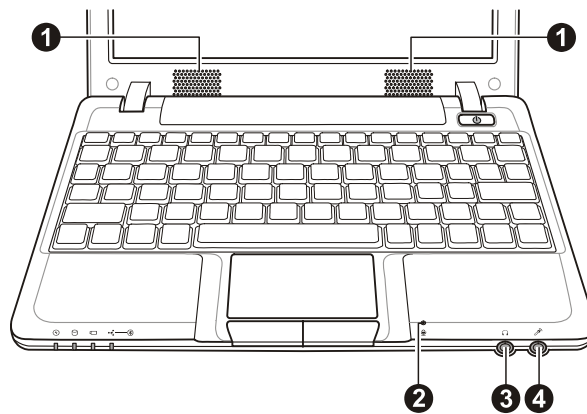

Ways of playing and recording sound vary with the operating system used. See your operating system documentation or online help for specific information.

Connecting Audio Devices

For higher audio quality, you can send or receive sound through external audio devices.

NOTE: After connecting an external audio device, make sure that you specify the use of the correct audio device in Windows.

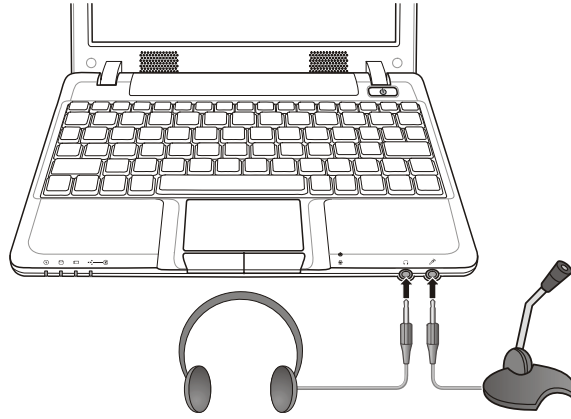

- **Audio Output Connector** (🎧) connects to speakers or headphones.
- **Microphone Connector** (🎤) connects to an external microphone for recording voice or sound.

NOTE: When using the external speakers/headphones or microphone, you cannot use the internal one.

Using the Communication Features

Using the LAN

NOTE: Your computer is pre-installed with the Ethernet driver for you to use the LAN feature.

The internal 10Base-T/100Base-TX LAN (Local Area Network) module allows you to connect your computer to a network. It supports data transfer rate up to 100 Mbps.

To connect the network cable to the LAN module, connect one end of the LAN cable to the RJ-45 connector on the computer and the other end to the network hub.

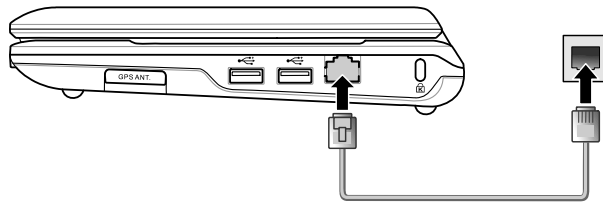

Using the WLAN

NOTE: Your computer is pre-installed with the wireless LAN driver for you to use the WLAN feature.

An internal mini wireless LAN (WLAN) card is pre-installed in your computer. This card allows you to access corporate networks or the Internet in a wireless environment.

The WLAN features include:

- Peer-to-Peer (Ad-Hoc) and Access Point (Infrastructure) modes support
- WEP (Wired Equivalent Privacy) 64/128-bit data encryption
- IEEE 802.11b/g standard compliance

Turning On/Off the WLAN Radio

CAUTION: The FAA (Federal Aviation Agency) has deemed it unsafe to operate wireless devices in aircraft as this may interfere with flight safety. Remember to turn off wireless LAN when using your computer in the airplane.

Your computer has a built-in Fn+F1 WLAN hot key to switch the WLAN radio on/off (see “Hot Keys” in Chapter 2).

It takes approximately 30 seconds for your computer to make a successful WLAN connection and approximately 10 seconds to disconnect.

Connecting to a Wireless Network

To connect to a wireless network:

1. Make sure that the WLAN radio is on (controlled by Fn+F1).
2. Right-click the Wireless Network Connection icon  in the system tray and click **View Available Wireless Networks**.
3. If any wireless network is detected, the following window shows.

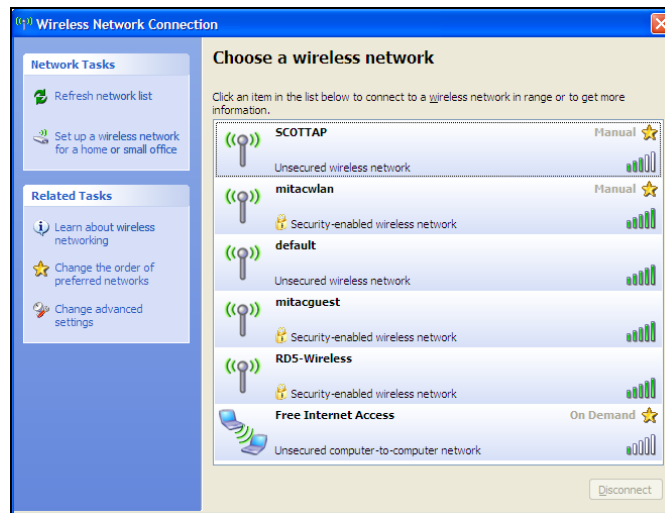

4. Click the desired wireless network and click **Connect**.

- Depending on the settings, you may be asked to enter a WEP key (refer to your Windows online help for more information on setting a wireless network connection).

Using the Bluetooth Feature



NOTE: Your computer is pre-installed with the Bluetooth driver for you to use the Bluetooth feature.

Your computer incorporates the Bluetooth capability for short-range (about 10 meters) wireless communications between devices without requiring a cable connection.

Turning On/Off the Bluetooth Radio



Your computer has a built-in Fn+F8 hot key to switch the Bluetooth radio on/off (see “Hot Keys” in Chapter 2).

The status of the Bluetooth connection is indicated by the Bluetooth icon located in the system tray.

Status	Icon
Off	 (blue with red logo)
On	 (blue with white logo).
Connected	 (blue with green logo)

You can use the Bluetooth Utility to configure Bluetooth connection settings and transfer files.

Connecting to Another Bluetooth Device

- Make sure that the target Bluetooth device is turned on, discoverable and within close range. (See the documentation that came with the Bluetooth device.)
- Double-click the  icon, and then click **Add a Bluetooth Device**.
Or right-click the  icon, and then click **Add a Bluetooth Device**.



3. The Bluetooth Setup Wizard shows. Click **Next**.

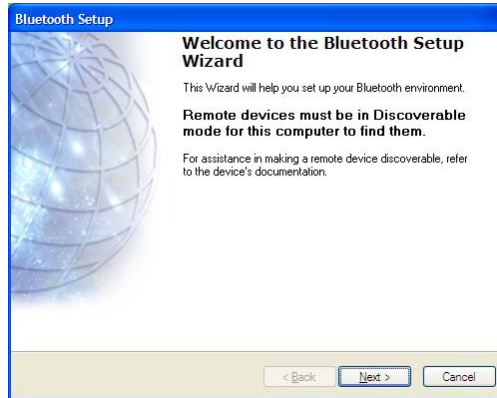

4. Select the device to connect to and click **Next**.



5. Depending on the type of Bluetooth device that you want to connect to, you will need to enter the pertinent information.

Sending a File

1. Browse for the file to transfer on your computer.
2. Right-click on the file and select **Send To** then **Bluetooth**.
3. Click the target device and **OK**. The transfer will start.

Managing Power

Your computer operates either on external AC power or on internal battery power.

This chapter tells you how you can effectively manage power. To maintain optimal battery performance, it is important that you use the battery in the proper way.

The topics in this chapter include:

- What is an AC adapter
- How to charge the battery pack
- When and how to initialize the battery pack
- How to check the battery level
- How to replace the battery pack
- What happens when the battery is low and what actions to take
- What is Power Management
- How to save power

AC Adapter

CAUTION:

- The AC adapter is designed for use with your computer only. Connecting the AC adapter to another device can damage the adapter.
 - The AC power cord supplied with your computer is for use in the country where you purchased your computer. If you plan to go overseas with the computer, consult your dealer for the appropriate power cord.
 - When you disconnect the AC adapter, disconnect from the electrical outlet first and then from the computer. A reverse procedure may damage the AC adapter or computer.
 - When unplugging the connector, always hold the plug head. Never pull on the cord.
-

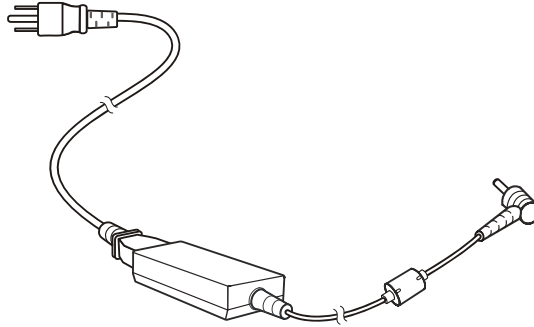

The AC adapter serves as a converter from AC (Alternating Current) to DC (Direct Current) power because your computer runs on DC power, but an electrical outlet usually provides AC power. It also charges the battery pack when connected to AC power.

The adapter operates on any voltage in the range of 100~240 V AC.

Battery Pack

The battery pack is the internal power source for the computer. It is rechargeable using the AC adapter.

The operating time of a fully charged battery pack depends on how you are using the computer. When your applications often access peripherals, you will experience a shorter operating time.

NOTE: Care and maintenance information for the battery is provided in the "Battery Pack Guidelines" section in Chapter 7.

Charging the Battery Pack

NOTE: Charging will not start if the battery's temperature is below 0 °C (32 °F) or above 40 °C (104 °F).

NOTE: The charging process will stop and the Battery Charge Indicator flashes red when the battery's temperature gets above 60 °C (140 °F). If this happens, the battery pack may be damaged. Please contact your dealer.

NOTE: During charging, do not disconnect the AC adapter before the battery has been fully charged; otherwise you will get a prematurely charged battery.

To charge the battery pack, connect the AC adapter to the computer and an electrical outlet. The Battery Charge Indicator (☐) on the computer glows in amber to indicate that charging is in progress. You are advised to keep the computer power off while the battery is being charged. When the battery is fully charged, the Battery Charge Indicator glows in green.

CAUTION: After the computer has been fully recharged, do not immediately disconnect and reconnect the AC adapter to charge it again. Doing so may damage the battery.

NOTE: The battery level may automatically lessen due to the self-discharge process (0.21 % per day), even when the battery pack is fully charged (100 %). This happens no matter if the battery pack is installed in the computer.

Initializing the Battery Pack



You need to initialize a new battery pack before using it for the first time or when the actual operating time of a battery pack is much less than expected.

Initializing is the process of fully charging, discharging, and then charging. It can take several hours.

1. Make sure that the computer power is turned off. Connect the AC adapter to fully charge the battery pack.
2. After the battery pack is fully charged, turn on the computer. Press the Del key when the BIOS logo screen shows during the system startup to display the BIOS Setup main screen.
3. Disconnect the AC adapter and leave the computer on until the battery is fully discharged. The computer will shut down automatically.
4. Connect the AC adapter to fully charge the battery pack.

Checking the Battery Level

NOTE: Any battery level indication is an estimated result. The actual operating time can be different from the estimated time, depending on how you are using the computer.

You can check the approximate battery level using the battery meter function of the operating system. To read the battery level in Windows, click the  icon on the system tray. (Click the  icon if the computer is using AC power.)

Replacing the Battery Pack

CAUTION:

- There is danger of explosion if the battery is incorrectly replaced. Replace the battery only with the computer manufacturer's optional battery packs. Discard used batteries according to the dealer's instructions.
- Do not attempt to disassemble the battery pack.

If you often rely on battery power for a long period of time while traveling, you may consider the purchase of an additional battery pack from your dealer and keep it with you in a fully charged state as a backup.

To replace the battery pack:

1. Make sure that computer is not turned on or connected to AC power.
2. Place the computer upside down.

- Slide the battery security lock outward to the unlock (🔓) position (❶).
- Slide the battery release lever outward to the unlock (🔓) position (❷) and, while holding it in the unlock position, remove the battery pack off the computer (❸).

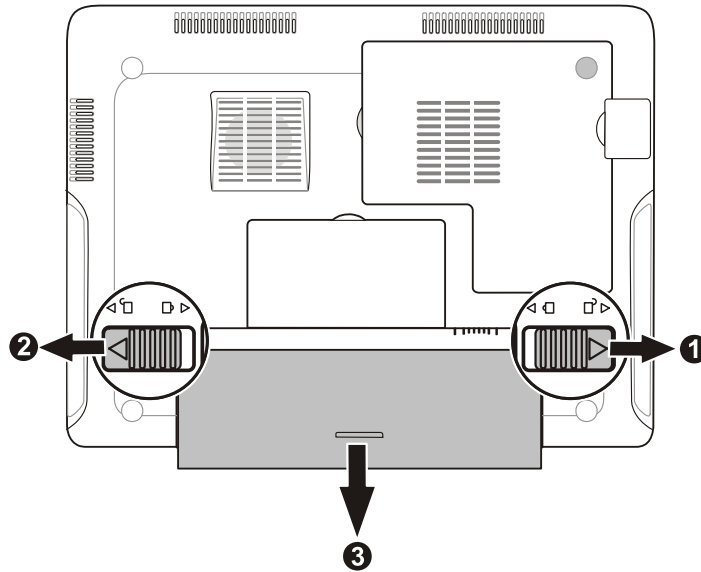

- Fit another battery pack into place and slide the battery security lock to the lock (🔒) position.

Battery Low Signals and Actions

The battery icon 🖱️ changes appearance to display the current state of the battery so that you can see how much charge remains (Windows default setting). When the battery charge is above 25 % the battery icon is green. When the battery charge reaches 25 % a yellow triangle with an exclamation point (!) appears above the green battery icon. When the charge reaches the low battery level a red circle with a white “X” appears above the green icon.

The computer’s Battery Charge Indicator (🔋) blinks to alert you to take actions.

Immediately save your data upon Battery Low. The remaining operating time depends on how you are using the computer. If you are using the audio subsystem, hard or USB flash disk, the battery might run out of charge very quickly.

Always respond to Battery Low by placing your computer in Hibernation mode, turning off the computer, or connecting the AC adapter.

CAUTION: If you fail to save your data when the battery completely runs out of charge, then you lose your data.

Power Management

Your computer supports ACPI (Advanced Configuration and Power Interface) for power management. The power management feature allows you to reduce the power consumption for energy saving.

With an ACPI-compliant operating system such as Windows XP, power supply to different computer components is controlled on an as-needed basis. This allows maximum power conservation and performance at the same time.

In general, Windows' power management works in this way:

What ...	When ...
Power to the hard disk is turned off	When the hard disk has been idle for a set period.
Power to the display is turned off	When the display has been idle for a set period.
The computer enters the Standby mode. The hard disk and display are turned off and the entire system consumes less power.	When the entire system has been idle for a set period.
	When you press the Fn+F9 hot key. *
	When you close the cover. *
The computer enters the Hibernation mode. (See the next subsection for more information.)	When you press the power button. *
	When the entire system has been idle for a set period.
	When you close the cover. *
	When you press the power button. *

* Depends on your settings in Windows.

For detailed information on power management, see Windows' Help.

Hibernation

NOTE: When using Windows, make sure that the hibernation feature is enabled in the “When I press the power button,” “When I press the sleep button,” and “When I close the lid” of the **Power Options** → **Advanced Properties** from the **Control Panel**.

Hibernation is a very useful feature. People frequently open many applications when they use computers. It takes some time to get all these applications open and running, and normally they all have to be closed before the computer can be turned off.

When you use the hibernation feature, you do not have to close the applications. The computer stores the state of your computer to a file on the hard disk and then shuts down. The next time you turn on your computer, you return to exactly where you left off.

Power-Saving Tips

Aside from enabling your computer's power saving mode (see previous section), you can do your part to maximize the battery's operating time by following these suggestions.

- Do not disable Power Management. Choose a power plan that saves power when using Windows. A power plan is a collection of hardware and system settings that control how your computer manages power.
- Decrease the LCD brightness to the lowest comfortable level.
- Shorten the length of time before Windows turns off the display.
- Many USB devices use power just by being connected. If you use a USB mouse, you can save power by disconnecting the mouse and using the touchpad. If you use a USB flash disk, unplug it when you are not using it.
- Turn off the WLAN feature if you are not using it. (See Chapter 2.)
- Turn off the Bluetooth feature if you are not using it. (See Chapter 2.)
- Turn off the computer when you are not using it.

Expanding Your Computer

You can expand the capabilities of your computer by connecting other peripheral devices. When using a device, be sure to read the instructions accompanying the device together with the relevant section in this chapter.

This chapter gives guidelines on installing and using these devices:

- External monitor
- USB device
- Storage card

Connecting an External Monitor

NOTE: Your computer is pre-installed with the video driver that supports the multi-display capability or enhanced video capabilities.

If you want the benefits of a larger display screen with higher resolution, you can connect an external CRT monitor or LCD monitor to your computer. Follow this procedure to connect an external monitor:

1. Make sure that the computer is not turned on.
2. Plug the monitor's signal connector to the computer's VGA connector.

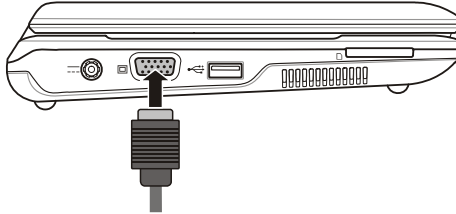

3. Plug one end of the monitor's power cord into the power socket on the monitor and the other end to an electrical outlet.
4. To use the monitor, turn on the monitor before turning on the computer.
5. The monitor should respond by default. If not, you can switch the display to the monitor or to both (simultaneous display), or to multi-display through the Display Settings Properties in Windows (see your operating system documentation or online help for specific information).

CAUTION: Do not disconnect the external monitor while the computer is in Standby or Hibernation mode. If no external monitor is connected when the computer resumes, the LCD might not display properly.

Connecting a USB Device

Your computer has three USB ports for connecting USB 2.0 devices.

To connect a USB device, simply plug the device cable to one of the USB ports.

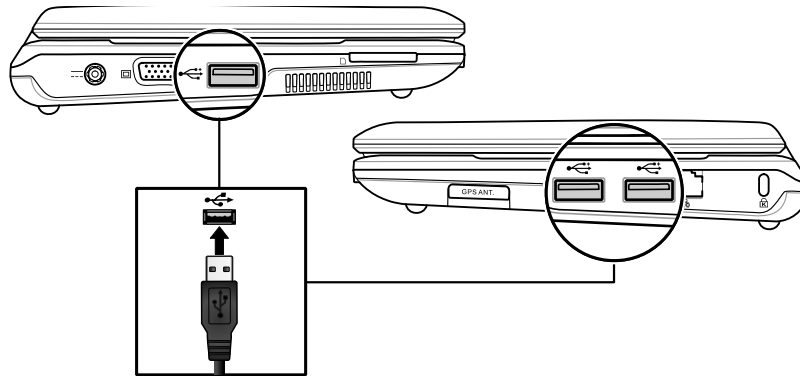

Using the Card Reader

NOTE: Your computer is pre-installed with the Card Reader driver for you to use the Card Reader.

NOTE: If your hard disk is divided into several drives, make sure that all drives have been formatted before using the Card Reader. Otherwise, you may encounter problems when using the Card Reader.

NOTE: You can use only storage cards. Your Card Reader does not support cards with I/O (input/output) functions such as a wireless network card or Bluetooth card.

Your computer has a Card Reader for accessing removable storage cards (or called memory cards). The Card Reader supports the Secure Digital (SD), Secure Digital High Capacity (SDHC) and MultiMediaCard (MMC) cards.

To insert a storage card:

1. Locate the Card Reader slot on the left side of the computer.
2. Align the card with its connector pointing to the slot and its label facing up. Slide the card into the slot until it reaches the end.

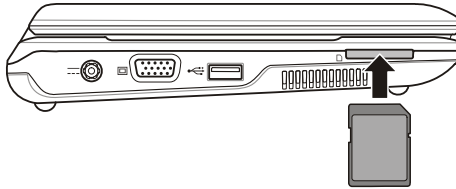

3. Windows will detect the card and assign it a drive name (typically E).

To remove a storage card:

1. Right-click the  icon in the system tray and click **Safely Remove Hardware**.
2. Click **Stop**.
3. Select the item you want to disable and click **OK**.
4. Push the card slightly to release the card, and then pull the card out of the slot.

Internal Components Upgrade

You can upgrade your computer by changing some components such as the hard disk. However, to avoid damage during the installation procedure, please ask your dealer for help. Do not install an internal component by yourself.

Using BIOS Setup

BIOS Setup Utility is a program for configuring the BIOS (Basic Input/ Output System) settings of the computer.

BIOS is a layer of software, called firmware, that translates instructions from other layers of software into instructions that the computer hardware can understand. The BIOS settings are needed by your computer to identify the types of installed devices and establish special features.

This chapter tells you how to use the BIOS Setup program.

When and How to Use BIOS Setup

When to Use

You need to run BIOS Setup Utility when:

- You see an error message on the screen requesting you to run BIOS Setup Utility.
- You want to restore the factory default settings.
- You want to modify some specific settings according to the hardware.
- You want to modify some specific settings to optimize the system performance.

Starting BIOS Setup

NOTE: The BIOS Setup Utility screens in this chapter are for your reference only. The actual items or settings on your computer may differ.

NOTE: The BIOS Setup Utility program may have been updated after the publication of this manual.

NOTE: The settings you select in your operating system might override similar settings in BIOS Setup Utility.

To run BIOS Setup Utility, press the Del key when the BIOS logo (MiSTATION) screen shows during the system startup. The BIOS logo screen shows up on the screen for only a few seconds. You must press the Del key quickly. The BIOS Setup Utility main screen appears as shown next.

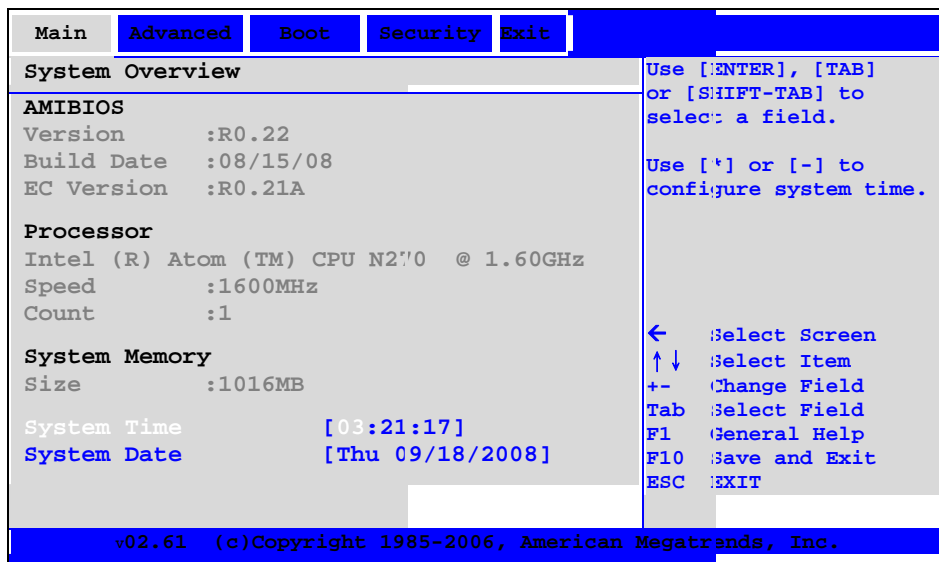

The BIOS Setup Utility screen can be divided into four areas:

- On the top is the menu bar containing the titles of the available menus. Each menu title brings a specific menu.
- The left column of the menu displays the menu items.
- The top-right of the menu provides more detailed information when a menu item is highlighted.
- The right column of the menu provides keyboard instructions for moving around and making selections. When a menu item is highlighted.

Moving Around and Making Selections

You must go through two or three levels to complete the setting for an item. In most cases, there are three levels: menu title, pull-down menu, and submenu.

Use the keyboard to move around and make selections. Keyboard information can be found at the bottom of the screen. A brief description of keyboard usage is listed next:

Key	Function
← , →	Selects a menu title.
↑ , ↓	Selects an item or option.
Enter	1) Brings up the sub-menu when available. 2) Opens or closes the option window when an item is selected.
Esc	1) Exits BIOS Setup Utility. 2) Closes the option window if one is open.
F1	General help.
F9	Loads setup defaults.
F10	Saves and exit the BIOS Setup Utility.

Main Menu

The Main menu contains the system date and time settings as well as shows the basic configuration of the system.

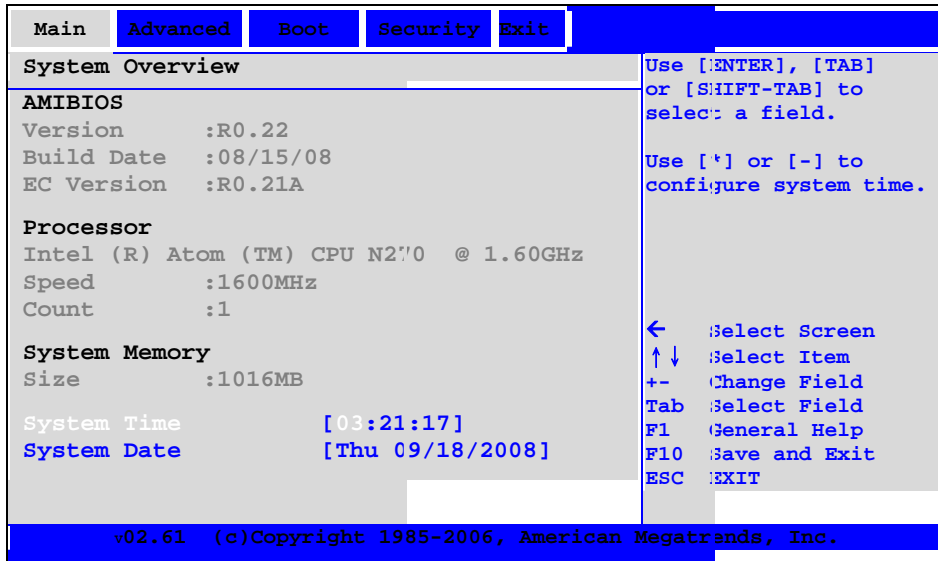

System Time sets the system time.

System Date sets the system date.

Advanced Menu

The Advanced menu contains various system settings.

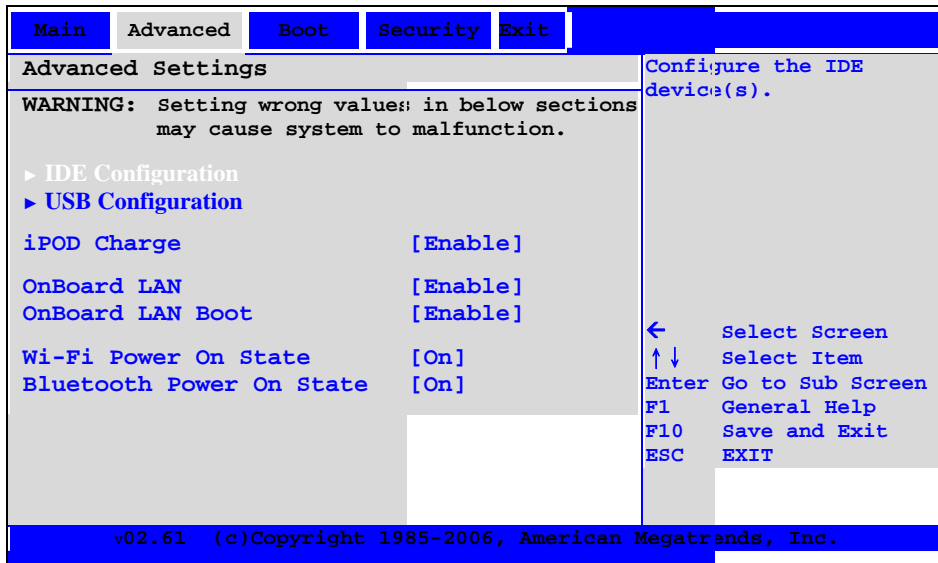

IDE Configuration sets the auto detection of the hard disk drive in your system.

Primary IDE Master/Primary IDE Slave sets the type of the hard disk drive.

IDE Detect Time Out (Sec) sets the time for the system to stop detecting the hard disk drive.

USB Configuration enables or disables the system's support for the USB port in DOS mode.

Legacy USB Support enables (default) or disables the USB port in DOS mode.

iPOD Charge enables or disables (default) charging via the USB port when the system is in Standby or Hibernation mode.

OnBoard LAN enables (default) or disables the system's LAN feature.

OnBoard LAN Boot enables or disables (default) system startup from a remote device in a LAN network.

Wi-Fi Power On State turns on (default) or off the system notification of the WLAN radio status.

Bluetooth Power On State turns on (default) or off the system notification of the Bluetooth radio status.

Boot Menu

The Boot menu sets the sequence of the devices to be searched for the operating system. The bootable devices will be automatically detected during POST and shown here.

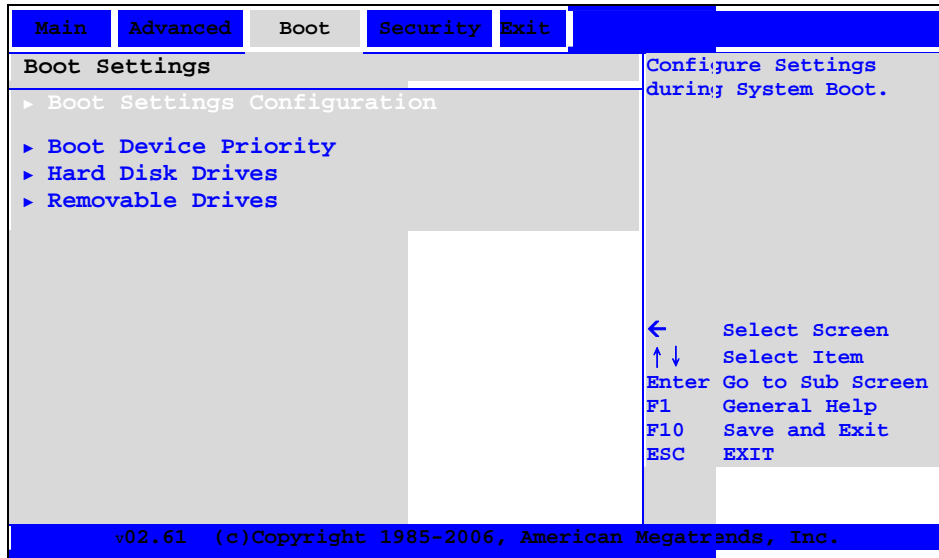

Boot Settings Configuration configures settings during system boot.

Quick Boot enables (default) or disables the system to skip certain tests at boot-up. This will decrease the time needed to boot the system.

Quiet Boot enables (default) or disables the system to hide the POST screen and show the logo screen instead. This will decrease the time needed to boot the system.

Bootup Num-Lock turns on or off (default) the numeric input mode at boot-up.

Boot Device Priority sets the sequence of booting. The devices include the hard disk drive, USB flash disk and network server.

Hard Disk Drives specifies the available hard disk drive for booting.

Removable Drives specifies the available USB flash disk for booting.

Security Menu

The Security menu contains the security settings, which safeguard your system against unauthorized use.

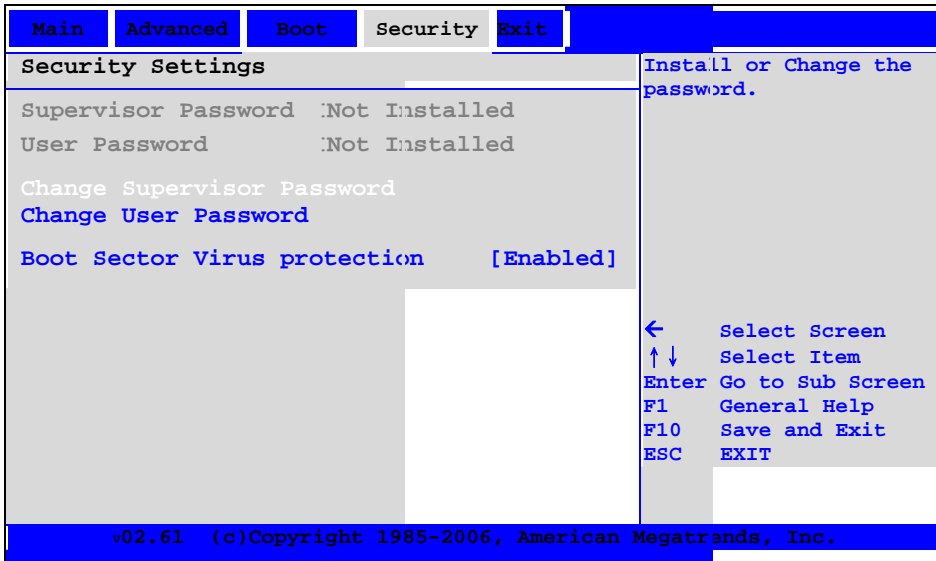

Supervisor/User Password shows whether you have set the supervisor/user password for the system.

Change Supervisor/User Password creates or changes the supervisor/user password. When typing the password, first make sure that Num Lock is off, and then type the password in the entry fields and press Enter. Confirm your password by typing it again and pressing Enter. You can set the supervisor/user password to be required for starting up the system and/or entering BIOS Setup.

NOTE: You can set the user password only when the supervisor password has been set.

NOTE: If both the supervisor and user passwords are set, you can enter any of them for starting up the system and/or entering BIOS Setup. However, the user password only allows you to view/change the settings of certain items.

Boot Sector Virus Protection helps prevent computer viruses by protecting the hard disk boot sector (partition table) from any change if enabled. Default is disabled.

CAUTION: Disable this item before installing an operating system, running Fdisk or Format program. Otherwise, the intended action will fail.

Exit Menu

The Exit menu displays ways of exiting BIOS Setup Utility. After finishing with your settings, you must save and exit so that the changes can take effect.

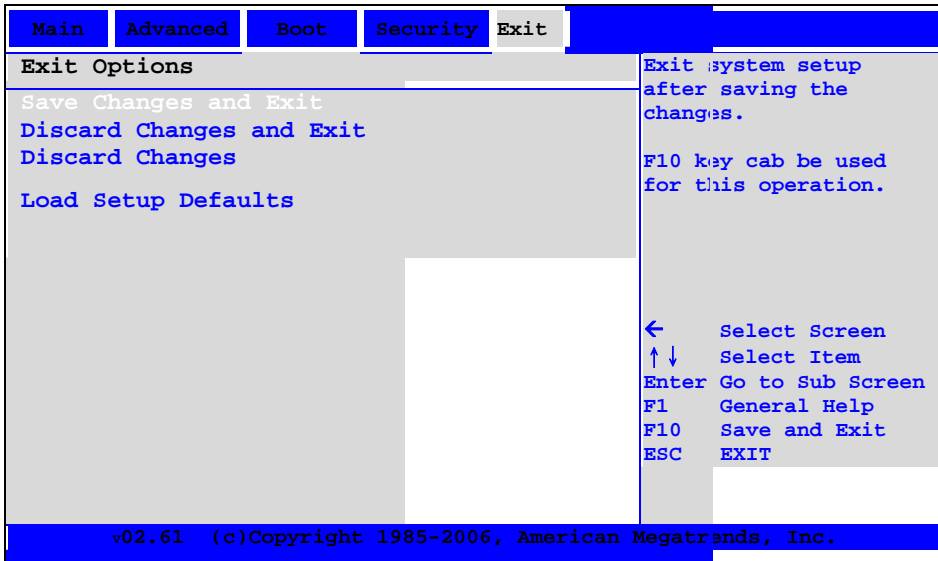

Save Changes and Exit exits BIOS Setup after saving the changes.

Discard Changes and Exit exits BIOS Setup without saving any changes.

Discard Changes discards changes done so far to any of the setup items.

Load Setup Defaults loads setup default values for all the setup items.

Using the Software Drivers

To take full advantage of the unique features of your computer, some operating systems require custom software, known as drivers, to be installed.

Your dealer may have already installed the drivers. If not, you need to install the drivers using the disc supplied with your computer.

This chapter describes the features of the drivers and tells you how to restore the system to its factory state.

How to Use the Driver Disc

NOTE: The drivers may have been updated after this manual was published. For driver upgrade, please contact your dealer.

NOTE: The driver disc supports Windows XP.

NOTE: The available items may differ according to your computer model.

The drivers may have been installed by your dealer. If you need to install the driver by yourself, follow the procedure:

1. Insert the supplied driver disc in the external optical drive.

NOTE: You can also copy the contents of the driver disc to a USB flash disk for the driver installation.

2. The autorun program automatically starts if Autorun is enabled in your computer.

NOTE: If you need to start the autorun program manually, browse for and run the Setup.exe program from the driver disc.

3. The main screen shows.

To install the intended driver, click on the particular item and installation will start.

Name	Description
Chipset	Ensures the full function of the following drivers. Install this driver before installing the other device drivers.
Video	Installs the video driver that allows you to select high-resolution displays with richer colors.
Audio	Installs the audio driver that allows you to take full advantage of the audio subsystem.
Card Reader	Installs the driver that allows the Card Reader to access MultiMediaCard (MMC) and Secure Digital (SD) card for removable storage media.
Ethernet	Installs the LAN driver that allows you to use the network function of the computer.
Pointing Device	Installs the touchpad driver that allows you to take full advantage of the touchpad features.

Name	Description
Camera	Installs the web camera driver that allows you to use the computer's built-in camera function.
Bluetooth	Installs the Bluetooth driver and application program that allows you to use the Bluetooth feature.
Wireless LAN	Installs the WLAN driver and application program that allows you to use the computer's internal mini PCI-E WLAN card's network function. NOTE: The Windows Plug-and-Play capability may automatically detect the new device (mini PCI-E WLAN card) and display the wizard requesting for drivers. Click Cancel to bypass the wizard screen(s).
Acrobat	Installs the Adobe Acrobat Reader program if you do not have it in your computer. You need Adobe Acrobat Reader to open the manual file supplied on this driver disc.
User's Manual	Allows you to view the User's Manual.
Exit	Allows you to exit driver installation (located on the right upper portion).

Caring for the Computer

Taking good care of your computer will ensure a trouble-free operation and reduce the risk of damage to your computer.

This chapter gives you guidelines covering these areas of maintenance:

- How to protect the computer
- What to note when using and storing the computer
- How to clean the computer
- What to note when using the battery pack
- What to note when traveling with the computer

Protecting the Computer

To safeguard the integrity of your computer data as well as the computer itself, you can protect the computer in several ways as described in this section.

Using the Windows Security Center

Windows Security Center protects your computer against intrusion.



Windows Security Center alerts you to take actions on the following security essentials:

- Firewalls
- Windows updates
- Virus protection

For detailed information on Windows Security Center, see Windows Help.

Using the Password

The power-on password protects your computer against unauthorized use. If the password is set, the prompt requesting for the password appears on the screen whenever the computer is turned on.

The password is set via the BIOS Setup program. See “Security Menu” in Chapter 5 for instructions.

Using the Cable Lock

You can use a Kensington-type cable lock to protect your computer against theft. The cable lock is available in most computer stores.

To use the lock, loop the lock cable around a stationary object such as a table. Insert the lock to the Kensington lock hole and turn the key to secure the lock. Store the key in a safe place.

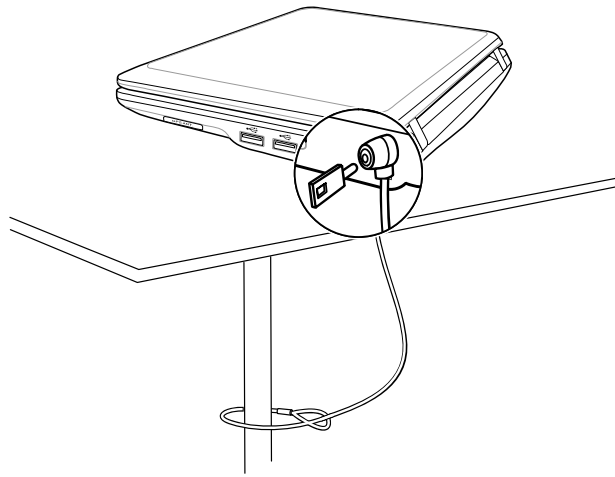

Taking Care of the Computer

Location Guidelines

- Use the computer where the temperature is between 10 °C (50 °F) and 40 °C (104 °F).
- Avoid placing the computer in a location subject to high humidity, extreme temperatures, mechanical vibration, direct sunlight, or heavy dust.
- Do not cover or block any ventilation openings on the computer. For example, do not place the computer on a bed, sofa, rug, or other similar surface. Otherwise, overheating may occur that results in damage to the computer.
- Keep the computer at least 13 cm (5 inches) away from electrical appliances that can generate a strong magnetic field such as a TV, refrigerator, motor, or a large audio speaker.
- Do not move the computer abruptly from a cold to a warm place. A temperature difference of more than 10 °C (18 °F) will cause condensation inside the unit, which may damage the storage media.
- Do not place the computer on an unsteady surface.

General Guidelines

- Do not place heavy objects on top of the computer when it is closed as this may damage the display.
- The screen surface is easily scratched. Do not use paper towels to clean the display. Avoid touching it with your fingers, pen, or pencil.
- To maximize the life of the backlight in the display, allow the backlight to automatically turn off as a result of power management. Avoid using a screen saver or other software that prevents the power management from working.

Cleaning Guidelines

- Never clean the computer with its power on.
- Use a soft cloth moistened with water or a non-alkaline detergent to wipe the exterior of the computer.
- Gently wipe the display with a soft, lint-free cloth. Do not use alcohol or detergent on the display.
- Dust or grease on the touchpad can affect its sensitivity. Clean the pad by using adhesive tape to remove the dust and grease on its surface.

Battery Pack Guidelines

- Recharge the battery pack when it is nearly discharged. When recharging, make sure that the battery pack is fully charged. Doing so may avoid harm to the battery pack.
- Operate the computer with the battery pack installed even when using external power. This ensures that the battery is fully charged.
- If you will not be using the computer for a long period of time (more than two weeks), remove the battery pack from the computer.
- If you remove the battery pack, make sure that the battery terminals do not contact any conductors such as metal objects or water. Otherwise, the battery may become unusable as a result of a short circuit.
- If you need to store the battery pack, store it in a cool, dry place. Never allow the temperature to exceed 60 °C (140 °F).
- Do not leave the battery pack in storage for more than 6 months without recharging it.

When Traveling

- Before traveling with your computer, make a backup of your hard disk data into flash disks or other storage devices. As an added precaution, bring along an extra copy of your important data.
- Make sure that the battery pack is fully charged.
- Make sure that the computer is turned off and the top cover is securely closed.
- Do not leave objects in between the keyboard and closed display.
- Disconnect the AC adapter from the computer and take it with you. Use the AC adapter as the power source and as a battery-charger.
- Hand-carry the computer. Do not check it in as luggage.
- If you need to leave the computer in the car, put it in the trunk of the car to avoid exposing the computer to excessive heat.
- When going through airport security, it is recommended that you send the computer and flash disks through the X-ray machine (the device you set your bags on). Avoid the magnetic detector (the device you walk through) or the magnetic wand (the handheld device used by security personnel).
- If you plan to travel abroad with your computer, consult your dealer for the appropriate AC power cord for use in your country of destination.

Troubleshooting

Computer problems can be caused by hardware, software, or both. When you encounter any problem, it might be a typical problem that can easily be solved.

This chapter tells you what actions to take when solving common computer problems. It is divided into three sections:

- Preliminary checklist
- Solving common problems
- Resetting the computer

Preliminary Checklist

Here are helpful hints to follow before you take further actions when you encounter any problem:

- Try to isolate which part of the computer is causing the problem.
- Make sure that you turn on all peripheral devices before turning on the computer.
- If an external device has a problem, make sure that the cable connections are correct and secure.
- Make sure that the configuration information is properly set in the BIOS Setup program.
- Make sure that all the device drivers are correctly installed.
- Make notes of your observations. Are there any messages on the screen? Do any indicators light? Do you hear any beeps? Detailed descriptions are useful to the service personnel when you need to consult one for assistance.

If any problem persists after you follow the instructions in this chapter, contact an authorized dealer for help.

Solving Common Problems

Battery Problems

The battery does not charge (Battery Charge indicator does not light).

- Make sure that the AC adapter is properly connected.
- Make sure that the battery is not too hot or cold. Allow time for the battery pack to return to room temperature.
- Make sure that the battery pack is installed correctly.
- Make sure that the battery terminals are clean.

The operating time of a fully charged battery becomes shorter.

- If you often partially recharge and discharge, the battery might not be charged to its full potential. Initialize the battery to solve the problem. (See “Initializing the Battery Pack” in Chapter 3 for instructions.)

The battery operating time indicated by the battery meter does not match the actual operating time.

- The actual operating time can be different from the estimated time, depending on how you are using the computer. If the actual operating time is much less than the estimated time, initialize the battery. (See “Initializing the Battery Pack” in Chapter 3 for instructions.)

Bluetooth Problems

I cannot connect to another Bluetooth-enabled device.

- Make sure that the Bluetooth card is correctly installed.
- Make sure that the Bluetooth driver is correctly installed.
- Make sure that both devices have activated Bluetooth.
- Make sure that the distance between the two devices are not over 10 meters or that there are no walls or other obstructions between the devices.

- Make sure that the other device is not in “Hidden” mode.
- Make sure that both devices are compatible.

Display Problems

Nothing appears on the screen.

- During operation, the screen may automatically turn off as a result of power management. Press any key to see if the screen comes back.
- The brightness level might be too low. Increase brightness by pressing the Fn+F6 hot key.
- The display output might be set to an external device. To switch the display back to the LCD, press the Fn+F7 hot key or change the display through the Display Settings Properties of Windows.

The characters on the screen are dim.

- Adjust the brightness and/or contrast.

Bad dots appear on the display at all times.

- A small number of missing, discolored, or bright dots on the screen are an intrinsic characteristic of TFT LCD technology. It is not regarded as a LCD defect.

The external monitor displays nothing.

- Make sure that the monitor is turned on.
- Make sure that the monitor’s signal cable is properly connected.
- Switch the display to the monitor by pressing the Fn+F7 hot key or change the display through the Display Settings Properties of Windows.

Simultaneous display/multi-display does not work.

- Make sure that you turn on the external monitor before turning on the computer.
- Press the Fn+F7 hot key to toggle through the display options or change the Display Settings Properties of Windows.

Hardware Device Problems

The computer does not recognize a newly installed device.

- The device may not be correctly configured in the BIOS Setup program. Run the BIOS Setup program to identify the new type.
- Make sure if any device driver needs to be installed. (Refer to the documentation that came with the device.)
- Make sure if the device needs any jumper or switch settings. (Refer to the documentation that came with the device.)
- Check the cables or power cords for correct connections.
- For an external device that has its own power switch, make sure that the power is turned on.

Hard Disk Drive Problems

The hard disk drive error message appears on the screen.

- The hard disk drive has defects. Ask your dealer for help.

The hard disk drive operations seem slow.

- The data files stored on the hard disk drive may be fragmented. Use a tool such as Window's Disk Defragmenter to defragment the files.

The hard disk drive in-use indicator glows without blinking.

- The data files stored on the hard disk drive may be fragmented. Use a tool such as Window's Disk Defragmenter to defragment the files.

Keyboard, Mouse and Touchpad Problems

The keyboard does not respond.

- Try connecting an external keyboard. If it works, contact an authorized dealer, as the internal keyboard cable might be loose.

The numeric keypad is disabled.

- Make sure that Num Lock is switched on. (Check if the Num Lock Message prompts or not.)

The external keyboard does not work.

- Make sure that the keyboard cable is properly connected.

The USB mouse does not work.

- Make sure that the mouse cable is properly connected.

The touchpad does not work, or the pointer is difficult to control with the touchpad.

- Make sure that the pointing device driver is correctly installed.
- Make sure that the touchpad is clean.

LAN Problems

I cannot access the network.

- Make sure that the Ethernet driver is correctly installed.
- Make sure that the LAN cable is properly connected to the RJ-45 connector and the network hub.
- Make sure that the network configuration is appropriate.
- Make sure that the user name or password is correct.

WLAN Problems

I cannot use the WLAN feature.

- Make sure that the WLAN card is correctly installed.
- Make sure that the necessary driver(s) is correctly installed.
- Make sure that the WLAN radio is turned on.

Transmission quality is poor.

- Your computer may be in an out-of-range situation. Move your computer closer to the Access Point or another WLAN device it is associated with.
- Check if there is high interference around the environment and solve the problem as described next.

Radio interference exists.

- Move your computer away from the device causing the radio interference such as microwave oven and large metal objects.
- Plug your computer into an outlet on a different branch circuit from that used by the affecting device.
- Consult your dealer or an experienced radio technician for help.

I cannot connect to another WLAN device.

- Make sure that the WLAN radio is turned on.
- Make sure that the SSID setting is the same for every WLAN device in the network.
- Your computer is not recognizing changes. Restart the computer.
- Make sure that the IP address or subnet mask setting is correct.

I cannot communicate with the computer in the network when Infrastructure mode is configured.

- Make sure that the Access Point your computer is associated with is powered on and all the LEDs are working properly.
- If the operating radio channel is in poor quality, change the Access Point and all the wireless station(s) within the BSSID to another radio channel.
- Your computer may be in an out-of-range situation. Move your computer closer to the Access Point it is associated with.
- Make sure that your computer is configured with the same security option (encryption) to the Access Point.
- Use the Web Manager/Telnet of the Access Point to check whether it is connected to the network.
- Reconfigure and reset the Access Point.

I cannot access the network.

- Make sure that the necessary driver(s) is correctly installed.
- Make sure that the network configuration is appropriate.
- Make sure that the user name or password is correct.
- You have moved out of range of the network.
- Turn off power management.

Power Management Problems

The computer does not enter Standby or Hibernation mode automatically.

- If you have a connection to another computer, the computer does not enter Standby or Hibernation mode if the connection is actively in use.
- Make sure that the Standby or Hibernation time-out is enabled.

The computer does not enter Standby or Hibernation mode immediately.

- If the computer is performing an operation, it normally waits for the operation to finish.

The computer does not resume from Standby or Hibernation mode.

- The computer automatically enters Standby or Hibernation mode when the battery pack is empty. Do any one of the following:
 - Connect the AC adapter to the computer.
 - Replace the empty battery pack with a fully charged one.

Software Problems

An application program does not work correctly.

- Make sure that the software is correctly installed.
- If an error message appears on the screen, consult the software program's documentation for further information.
- If you are sure the operation has stop, reset the computer. (See "Resetting the Computer" later in this chapter.)

Sound Problems

No sound is produced.

- Make sure that the volume control is not set too low.
- Make sure that the audio driver is correctly installed.
- Make sure that the computer is not in Standby mode.
- If using an external speaker, make sure that the speaker is properly connected.

Distorted sound is produced.

- Make sure that the volume control is not set too high or too low. In most cases, a high setting can cause the audio electronics to distort the sound.

The sound system does not record.

- Adjust the playback or recording sound levels.

The external microphone or audio device does not work.

- Make sure that the microphone is connected to the proper connector on the computer.
- Make sure that your computer is equipped with the driver needed.
- Click the speaker symbol on the taskbar and check the Windows volume control.
- Check the volume control of your computer.

Startup Problems

When you turn on the computer, it does not respond and the Power Indicator does not light.

- If you are using an external AC power, make sure that the AC adapter is correctly and securely connected. If so, make sure that the electrical outlet works properly.
- If you are using the battery power, make sure that the battery is not discharged.

When you turn on the computer, it stops after POST.

- Restart your computer.

Other Problems

The date/time is incorrect.

- Correct the date and time via the operating system or BIOS Setup program.
- After you have performed everything as described above and still have the incorrect date and time every time you turn on the computer, the RTC (Real-Time Clock) battery is at the end of its life. Call an authorized dealer to replace the RTC battery.

Resetting the Computer

You may have to reset (reboot) your computer on some occasions when an error occurs and the program you are using hangs up.

If the computer operation seems to hang up, first wait. It is possible that the computer is processing data. Periodically check the hard disk drive in-use indicator, if it flashes irregularly, the program may be accessing data and preventing you from using the keyboard. If you are sure the operation has stopped and you cannot use the “restart” function of the operating system, reset the computer.

Reset the computer by any one of these methods:

- Press Ctrl+Alt+Del.
- If the above action does not work, turn off the computer. Wait for at least five seconds and turn it on again.

CAUTION: Resetting will cause any unsaved data to be lost.

Recovering Pre-installed Software

CAUTION: All files on the primary hard disk partition (usually drive C) will be lost in the software recovery process. Make sure you have a backup of the files stored in the partition before you start the process.

Your computer has a hidden and protected area in the hard disk drive where a backup of the hard disk drive in its factory state is stored.

To recover the hard disk drive to its factory state:

1. Press the power button to turn on your computer.
2. Press the F10 key when the BIOS logo (MiSTATION) screen shows during the system startup.
3. Select **Restore system to initial**. The recovery procedure starts.

NOTE: If you wish to skip the recovery procedure, select **Reboot my computer**.

Specifications

NOTE: Specifications are subject to change without any prior notice.

Parts		Specifications
Operating System		Microsoft Windows® XP
CPU		Intel® Diamondville-SC Processor; 533MHz FSB support
ROM BIOS		1MB ROM BIOS
RAM	System	512MB, one 200-pin DDRII 400/533MHz SO-DIMM socket
Display	Panel	8.9-inch TFT LCD, resolution 1024 × 600
	Video controller	Intel 945GSE
	Video port	VGA port
Audio	Audio controller	Realtek ALC662-GR
	Audio port	Two audio ports for Audio out / Mic-in
	Speakers	1 watt × 2
Keyboard		Standard keys, 12 function keys, a special Fn (Function) key
Pointing device		PS/2-compatible touchpad with 2 buttons
Storage device		Hard disk drive (1.8-inch, 60GB) – or – S.S.D. Storage (Solid-State Drive, 2GB/4GB)
Card Reader		SD/SDHC/MMC
I/O ports		3 × USB 2.0 ports
LAN		10/100 Mbps
Wireless LAN		One mini PCI-E slot for wireless LAN card, compliant with IEEE 802.11b/g
Bluetooth (option)		Bluetooth 2.1 + EDR support
Camera		1.3M pixel webcam
Power	AC adapter	Universal AC adapter 36 Watt; input: 100~240 Volt, output: 12 Volt
	Battery	4-/6-cell Li-ion battery

Parts		Specifications
Dimension (W×D×H)		250×170×22~36 mm
Weight		1.05 kg
Environment	Temperature	Operating: 0 °C (32 °F) to 40 °C (104 °F) Storage: -20 °C (-4 °F) to 60 °C (140 °F)
	Humidity	Operating: 5 % to 95 % non-condensing Storage: 5 % to 95 % non-condensing

Regulatory Information

NOTE: Marking labels located on the exterior of your computer indicate the regulations that your model complies with. Please check the marking labels and refer to the corresponding statements in this appendix. Some notices apply to specific models only.

Class B Regulations

USA

Federal Communications Commission Radio Frequency Interference Statement

NOTE:

This equipment has been tested and found to comply with the limits for a Class B digital device pursuant to Part 15 of the FCC Rules. These limits are designed to provide reasonable protection against harmful interference in a residential installation. This equipment generates, uses, and can radiate radio frequency energy and, if not installed and used in accordance with the instructions, may cause harmful interference to radio communications. However, there is no guarantee that interference will not occur in a particular installation. If this equipment does cause harmful interference to radio or television reception, which can be determined by turning the equipment off and on, the user is encouraged to try to correct the interference by one or more of the following measures:

- Reorient or relocate the receiving antenna.
- Increase the separation between the equipment and receiver.
- Connect the equipment into an outlet on a circuit different from that to which the receiver is connected.
- Consult the dealer or an experienced radio/TV technician for help.

Any changes or modifications not expressly approved by the manufacturer could void the user's authority to operate the equipment.

This device complies with Part 15 of the FCC Rules. Operation is subject to the following two conditions: (1) This device may not cause harmful interference, and (2) this device must accept any interference received, including interference that may cause undesired operation.

For product available in the USA/Canada market, only channel 1~11 can be operated. Selection of other channels is not possible.

This device and its antenna(s) must not be co-located or operation in conjunction with any other antenna or transmitter.

Federal Communication Commission (FCC) Radiation Exposure Statement

This EUT is compliance with SAR for general population/uncontrolled exposure limits in ANSI/IEEE C95.1-1999 and had been tested in accordance with the measurement methods and procedures specified in OET Bulletin 65 Supplement C.

End Product Labeling

This transmitter module is authorized only for use in device where the antenna may be installed such that 20 cm may be maintained between the antenna and users. The final end product must be labeled in a visible area with the following: “Contains TX FCC ID: **TLZ-BT253**”.

Canada

This Class B digital apparatus complies with Canadian ICES-003.

Operation is subject to the following two conditions: (1) this device may not cause interference, and (2) this device must accept any interference, including interference that may cause undesired operation of the device.

Cet appareil numérique de la classe B conforme à la norme NMB-003 du Canada.

IC Radiation Exposure Statement

This EUT is compliance with SAR for general population/uncontrolled exposure limits in IC RSS-102 and had been tested in accordance with the measurement methods and procedures specified in IEEE 1528.

Europe

Statements of Compliance

English

This product follows the provisions of the European Directive 1999/5/EC.

Danish

Dette produkt er i overensstemmelse med det europæiske direktiv 1999/5/EC.

Dutch

Dit product is in navolging van de bepalingen van Europees Directief 1999/5/EC.

Finnish

Tämä tuote noudattaa EU-direktiivin 1999/5/EC määräyksiä.

French

Ce produit est conforme aux exigences de la Directive Européenne 1999/5/EC.

German

Dieses Produkt entspricht den Bestimmungen der Europäischen Richtlinie 1999/5/EC.

Greek

Το προϊόν αυτό πληροί τις προβλέψεις της Ευρωπαϊκής Οδηγίας 1999/5/EC.

Icelandic

Þessi vara stenst reglugerð Evrópska Efnahags Bandalagsins númer 1999/5/EC.

Italian

Questo prodotto è conforme alla Direttiva Europea 1999/5/EC.

Norwegian

Dette produktet er i henhold til bestemmelsene i det europeiske direktivet 1999/5/EC.

Portuguese

Este produto cumpre com as normas da Diretiva Europeia 1999/5/EC.

Spanish

Este producto cumple con las normas del Directivo Europeo 1999/5/EC.

Swedish

Denna produkt har tillverkats i enlighet med EG-direktiv 1999/5/EC.

Local Restrictions of 802.11a/g/n Radio Usage

802.11a wireless LAN devices: For operation within 5.15 ~ 5.25 GHz frequency range, it is restricted to indoor usage environments, and the antenna of this device must be integral.

CAUTION: Due to the fact that the frequencies used by 802.11a/g/n wireless LAN devices may not yet be harmonized in all countries, 802.11a/g/n products are designed for use only in specific countries or regions, and is not allowed to be operated in countries or regions other than those of designated use. As a user of these products, you are responsible for ensuring that the products are used only in the countries or regions for which they were intended and for verifying that they are configured with the correct selection of frequency and channel for the country or region of use. Any deviation from permissible settings and restrictions in the country or region of use could be an infringement of local law and may be punished as such.

The European variant is intended for use throughout the European Economic Area. However, authorization for use is further restricted in particular countries or regions within countries, as follows:

General

European standards dictate maximum radiated transmit power of 100 mW Effective Isotropic Radiated Power (EIRP) and the frequency range 2400 – 2483.5 MHz.

Belgium and the Netherlands

In Belgium and the Netherlands, the product may not be used outdoors. See the instructions next under the heading “Turning Off the Wireless LAN Radio.”

France

Departments in Which the Wireless LAN Module Can Be Used (Indoors Only)

The wireless LAN module can currently be used indoors only in the following 38 departments of mainland France. Please turn off your wireless LAN radio when operating the device in areas/places other than the 38 departments listed:

01	Ain Orientales	36	Indre	66	Pyrénées
02	Aisne	37	Indre et Loire	67	Bas Rhin
03	Allier	41	Loir et Cher	68	Haut Rhin
05	Hautes Alpes	42	Loire	70	Haute Saône
08	Ardennes	45	Loiret	71	Saône et Loire
09	Ariège	50	Manche	75	Paris
11	Aude	55	Meuse	82	Tarn et Garonne
12	Aveyron	58	Nièvre	84	Vaucluse
16	Charente	59	Nord	88	Vosges
24	Dordogne	60	Oise	89	Yonne
25	Doubs	61	Orne	90	Territoire de Belfort
26	Drôme	63	Puy du Dôme	94	Val de Marne
32	Gers	64	Pyrénées Atlantique		

Departments in Which the Wireless LAN Module's Maximum EIRP Not Shown in the Previous Table

Frequency Ranges (MHz)	Indoors	Outdoors
2400 – 2446.5	10 mW	Not permitted
2446.5 – 2483.5	100 mW	100 mW on private property with Ministry of Defense approval

Turning Off the Wireless LAN Radio

NOTE: Turning the wireless LAN radio off is not the same as disabling the wireless LAN card. It is not necessary to disable the card to meet the regulatory requirements.

While operating the computer in those French departments that do not allow use of the wireless LAN equipment, the user of the equipment must turn off the wireless LAN radio in order to comply with local regulations (see Chapter 2 for more information).

Index

A

- AC adapter, 3-2, A-1
 - Connecting, 1-2
- AC power, 3-2
- AC Power
 - Connecting, 1-2
- ACPI, 3-7
- Adobe Acrobat Reader, 6-3
- Antenna warning, B-5
- Audio driver, 6-2
- Audio output connector, 1-10, 2-12
- Audio subsystem
 - Connect external audio device, 2-11
 - Driver installation, 6-2
 - Feature, 2-11
 - Troubleshooting, 8-9

B

- Battery
 - Indicator, 3-3
- Battery charge
 - Indicator, 1-10
- Battery low, 3-6
- Battery pack, 1-8, 3-3, A-1
 - Battery low, 3-6
 - Charging, 3-3
 - Checking battery level, 3-4
 - Initializing, 3-4
 - Replacing, 3-4
 - Safety notices, v

- Taking care, 3-3, 7-5
- Troubleshooting, 8-3
- BIOS Setup, 5-1
 - Advanced menu, 5-6
 - Boot menu, 5-8
 - Exiting, 5-10
 - Main menu, 5-5
 - Security menu, 5-9
 - Starting, 5-2
- Bluetooth
 - Driver installation, 6-3
 - Hot key, 2-5
- Bluetooth & Wireless
 - Indicator, 1-10
- Bluetooth wireless feature
 - Connect to Bluetooth device, 2-15
 - Sending file, 2-17
 - Troubleshooting, 8-3
 - Turning off, 2-15
 - Turning on, 2-15
- Booting, 2-2
- Brightness
 - Hot key, 2-5

C

- Camera, 1-9
 - Driver installation, 6-3
- Canada
 - Class B compliance notice, B-3
 - RF interference requirements, B-6
- Card reader, 1-7
- Card Reader, 4-4
 - Driver installation, 6-2

- Inserting a card, 4-4
- Removing a card, 4-4
- Charging, 3-3
- Chipset driver, 6-2
- Cleaning the computer, 7-5
- Click, 2-8
- Connecting external device
 - Monitor, 4-2
 - USB device, 4-3
- Connector
 - Audio output, 2-12
 - Headphone, 1-10
 - LAN, 1-6
 - Microphone, 1-10, 2-12
 - Power, 1-7
 - VGA, 1-7
- Cover
 - Opening, 1-3
- CPU, A-1
- Cursor control keys, 2-4

D

- Date
 - BIOS Setup, 5-5
 - Troubleshooting, 8-10
- DC power, 3-2
- Dimension of computer, A-2
- Display
 - Troubleshooting, 8-4
- Display mode, 2-10
- Display output, 2-5
- Double-click, 2-8
- Drag and drop, 2-8
- Drive E, 4-4
- Driver disc OS support, 6-2
- Driver installation, 6-1

E

- EMC requirements, B-5
- Environmental specifications, A-2
- EU
 - CE marking and compliance notices, B-7

- External monitor
 - Connecting, 4-2

F

- FCC
 - Class B regulations, B-2
- Fn key, 2-4
- Function keys, 2-4

H

- Hard disk drive
 - Troubleshooting, 8-5
- Hard drive
 - Indicator, 1-10
- HDMI connector, 4-2
- Hibernation, 2-3, 3-7, 3-8
 - Troubleshooting, 8-8
- Hot key
 - Bluetooth, 2-5
 - Brightness, 2-5
 - Display output, 2-5
 - Mute, 2-5
 - Standby, 2-5
 - Volume, 2-5
 - WLAN, 2-5
- Humidity, A-2

I

- Indicator
 - Battery charge, 3-3
 - Bluetooth & Wireless, 1-10
 - Hard drive, 1-10
 - Power status, 1-10

K

- Kensington lock, 1-6, 7-3
- Keyboard, 1-9, 2-4
 - Troubleshooting, 8-5

L

LAN, 2-13
 Connector, 1-6
 Driver installation, 6-3
 Troubleshooting, 8-6
LCD, 2-10
Location of the computer, 7-4
Low battery. *See* Battery low

M

Microphone, 1-10, 2-11
Microphone connector, 1-9, 2-12
Mouse
 Troubleshooting, 8-5
MultiMediaCard. *See* Storage card
Mute
 Hot key, 2-5

N

Network. *See* LAN
Num lock, 2-5
Numeric keys, 2-5

O

Operating system, 1-5, 2-2

P

Point, 2-7
Port
 USB, 1-6, 1-7
POST, 1-5
Power, A-1
Power button, 1-9, 2-2
Power connector, 1-7
Power Management, 3-7
 Troubleshooting, 8-8
Power status

Indicator, 1-10
Power-On Self Test. *See* POST
Power-Saving, 3-9

R

RAM, A-1
Rebooting, 8-11
Resetting, 8-11
Restarting, 8-11
RF device
 Safety Requirements and Notices, B-4
RJ-11, 1-6
RJ-45, 1-6, 2-13
ROM BIOS, A-1

S

Scroll, 2-8
Secure Digital. *See* Storage card
Security
 Protecting the computer with lock, 7-3
 Protecting the computer with password,
 7-3
Security Center
 Protecting the computer, 7-2
Shutting down, 1-5, 2-2
Simultaneous display, 2-10
Sleep, 3-7
 Troubleshooting, 8-8
Software
 Troubleshooting, 8-8
Software driver, 6-1
Speaker, 1-9, 2-11
 Connecting external speakers, 2-12
Specifications, A-1
Standby, 2-2, 3-7
 Troubleshooting, 8-8
Standby button, 2-5
Start up, 2-2
Startup
 Troubleshooting, 8-9
Storage card, 4-4
 Inserting, 4-4
 Removing, 4-4

System Recovery, 8-12

T

Temperature, A-2

TFT, 2-10

Time

 BIOS Setup, 5-5

Touchpad, 1-9, 2-7

 Configuring, 2-9

 Driver installation, 6-3

 Troubleshooting, 8-5

Traveling with the computer, 7-6

Troubleshooting, 8-1

 Battery problem, 8-3

 Bluetooth wireless feature problem, 8-3

 Date problem, 8-10

 Display problem, 8-4

 Hard disk drive problem, 8-5

 Hardware problem, 8-5

 Keyboard problem, 8-5

 LAN problem, 8-6

 Mouse problem, 8-5

 Other problem, 8-10

 Power Management problem, 8-8

 Software problem, 8-8

 Sound problem, 8-9

 Startup problem, 8-9

 Time problem, 8-10

 Touchpad problem, 8-5

 WLAN problem, 8-6

Turning off, 1-5, 2-2

Turning on, 1-4

Typewriter keys. *See* Keyboard

U

Upgrading the computer, 4-5

USB device

 Connecting, 4-3

USB port, 1-6, 1-7, 4-3

V

VGA connector, 1-7

VGA port, 4-2

Video driver, 6-2

Video subsystem

 Configuring, 2-10

 Driver installation, 6-2

 Feature, 2-10

 Video controller, A-1

Volume

 Hot key, 2-5

W

Weight of computer, A-2

Windows, 1-5

WLAN

 Driver installation, 6-3

 France restrictions, B-8

 Hot key, 2-5

 Local restrictions, B-8

 Troubleshooting, 8-6

 Turning off, 2-14

 Turning on, 2-14

 Using, 2-13