



# FCC RADIO TEST REPORT

**FCC ID** : P4Q-N650RN  
**Equipment** : Tablet  
**Brand Name** : MiTAC, Mio, NAVMAN, MAGELLAN  
**Model Name** : N650  
**Applicant** : MiTAC Digital Technology Corporation  
4F., No. 1, R&D Road 2, Hsinchu Science Park,  
Hsinchu 30076, Taiwan (R.O.C.)  
**Manufacturer** : MITAC Computer (Kunshan) Co., Ltd.  
No. 269, 2nd Avenue, District A, Comprehensive  
Free Trade Zone, 300 Kunshan, China  
**Standard** : FCC Part 15 Subpart E §15.407

The product was received on Jul. 09, 2021 and testing was started from Jul. 22, 2021 and completed on Aug. 02, 2021. We, Sporton International Inc. Wensan Laboratory, would like to declare that the tested sample has been evaluated in accordance with the test procedures and has been in compliance with the applicable technical standards.

The test results in this variant report apply exclusively to the tested model / sample. Without written approval of Sporton International Inc. Wensan Laboratory, the test report shall not be reproduced except in full.

*Louis Wu*

Approved by: Louis Wu

**Sporton International Inc. Wensan Laboratory**

No.58, Aly. 75, Ln. 564, Wenhua 3rd, Rd., Guishan Dist., Taoyuan City 333010, Taiwan (R.O.C.)



# Table of Contents

**History of this test report..... 3**

**Summary of Test Result..... 4**

**1 General Description ..... 5**

    1.1 Product Feature of Equipment Under Test..... 5

    1.2 Modification of EUT ..... 5

    1.3 Testing Location ..... 5

    1.4 Applicable Standards..... 5

**2 Test Configuration of Equipment Under Test ..... 6**

    2.1 Carrier Frequency and Channel ..... 6

    2.2 Test Mode ..... 7

    2.3 Connection Diagram of Test System..... 8

    2.4 EUT Operation Test Setup ..... 8

**3 Test Result ..... 9**

    3.1 Maximum Conducted Output Power Measurement ..... 9

    3.2 Unwanted Emissions Measurement ..... 11

    3.3 Antenna Requirements..... 16

**4 List of Measuring Equipment..... 17**

**5 Uncertainty of Evaluation ..... 18**

**Appendix A. Conducted Test Results**

**Appendix B. Radiated Spurious Emission**

**Appendix C. Radiated Spurious Emission Plots**

**Appendix D. Duty Cycle Plots**

**Appendix E. Setup Photographs**



### History of this test report

Report No.	Version	Description	Issued Date
FR970921-08D	01	Initial issue of report	Aug. 13, 2021



### Summary of Test Result

Report Clause	Ref Std. Clause	Test Items	Result (PASS/FAIL)	Remark
-	15.403(i)	26dB Bandwidth	Not Required	-
-	2.1049	99% Occupied Bandwidth	Not Required	-
3.1	15.407(a)	Maximum Conducted Output Power	Pass	-
-	15.407(a)	Power Spectral Density	Not Required	-
3.2	15.407(b)	Unwanted Emissions	Pass	Under limit 5.31 dB at 5149.240 MHz
-	15.207	AC Conducted Emission	Not Required	-
3.3	15.203 15.407(a)	Antenna Requirement	Pass	-

**Note:**

- 1. Not required means after assessing, test items are not necessary to carry out.
- 2. This is a variant report by disable NFC function via hardware. All the test cases were performed on original report which can be referred to Sporton Report Number FR970921-04E. Based on the original report, the test cases were verified.

<b>Declaration of Conformity:</b> The test results with all measurement uncertainty excluded are presented in accordance with the regulation limits or requirements declared by manufacturers.
<b>Comments and Explanations:</b> The declared of product specification for EUT presented in the report are provided by the manufacturer, and the manufacturer takes all the responsibilities for the accuracy of product specification.

**Reviewed by: Yun Huang**  
**Report Producer: Celery Wei**



# 1 General Description

## 1.1 Product Feature of Equipment Under Test

Bluetooth, Wi-Fi 2.4GHz 802.11b/g/n, Wi-Fi 5GHz 802.11a/n and GNSS.

Product Specification subjective to this standard	
Antenna Type	WLAN: PIFA Antenna Bluetooth: PIFA Antenna GPS / Glonass: PATCH Antenna

Antenna information		
5150 MHz ~ 5250 MHz	Peak Gain (dBi)	1.85
5250 MHz ~ 5350 MHz	Peak Gain (dBi)	1.63
5470 MHz ~ 5725 MHz	Peak Gain (dBi)	1.46

**Remark:** The above EUT's information was declared by manufacturer. Please refer to Comments and Explanations in report summary.

## 1.2 Modification of EUT

No modifications are made to the EUT during all test items.

## 1.3 Testing Location

Test Site	Sporton International Inc. Wensan Laboratory
Test Site Location	No.58, Aly. 75, Ln. 564, Wenhua 3rd, Rd., Guishan Dist., Taoyuan City 333010, Taiwan (R.O.C.) TEL: +886-3-327-0868 FAX: +886-3-327-0855
Test Site No.	<b>Sporton Site No.</b> TH05-HY; 03CH16-HY

**Note:** The test site complies with ANSI C63.4 2014 requirement.

FCC designation No.: TW3786

## 1.4 Applicable Standards

According to the specifications of the manufacturer, the EUT must comply with the requirements of the following standards:

- ♦ FCC Part 15 Subpart E
- ♦ FCC KDB 789033 D02 General UNII Test Procedures New Rules v02r01.
- ♦ FCC KDB 414788 D01 Radiated Test Site v01r01.
- ♦ ANSI C63.10-2013

**Remark:**

1. All test items were verified and recorded according to the standards and without any deviation during the test.
2. The TAF code is not including all the FCC KDB listed without accreditation.



## 2 Test Configuration of Equipment Under Test

The EUT has been associated with peripherals and configuration operated in a manner tended to maximize its emission characteristics in a typical application. Frequency range investigated: radiation emission (9 kHz to the 10th harmonic of the highest fundamental frequency or to 40 GHz, whichever is lower). The measured emission level of the EUT was maximized by rotating the EUT on a turntable, adjusting the orientation of the EUT and EUT antenna in three orthogonal axis (X: flat, Y: portrait, Z: landscape), and adjusting the measurement antenna orientation, following C63.10 exploratory test procedures and find X plane as worst plane.

### 2.1 Carrier Frequency and Channel

Frequency Band	Channel	Freq. (MHz)	Channel	Freq. (MHz)
5150-5250 MHz Band 1 (U-NII-1)	36	5180	44	5220
	38*	5190	46*	5230
	40	5200	48	5240
	-	-		

Frequency Band	Channel	Freq. (MHz)	Channel	Freq. (MHz)
5250-5350 MHz Band 2 (U-NII-2A)	52	5260	60	5300
	54*	5270	62*	5310
	56	5280	64	5320
	-	-		

Frequency Band	Channel	Freq. (MHz)	Channel	Freq. (MHz)
5470-5725 MHz Band 3 (U-NII-2C)	100	5500	112	5560
	102*	5510	116	5580
	104	5520	132	5660
	-	-	134*	5670
	108	5540	136	5680
	110*	5550	140	5700



Frequency Band	Channel	Freq. (MHz)	Channel	Freq. (MHz)
TDWR Channel	118*	5590	124	5620
	120	5600	126*	5630
	-	-	128	5640

Frequency Band	Channel	Freq. (MHz)	Channel	Freq. (MHz)
Straddle Channel	-	-	144	5720
	142*	5710		

Note: The above Frequency and Channel in "\*" were 802.11n HT40.

## 2.2 Test Mode

Final test modes are considering the modulation and worse data rates as below table.

Modulation	Data Rate
802.11a	6 Mbps
802.11n HT20	MCS0
802.11n HT40	MCS0

Ch. #		Band I : 5150-5250 MHz
		802.11n HT40
L	Low	38
M	Middle	-
H	High	-

**Remark:**

1. For radiation spurious emission, the final modulation and the worst data rate was reference the max RF conducted power.
2. For Radiated Test Cases, the tests were performed with Battery 2.

## 2.3 Connection Diagram of Test System

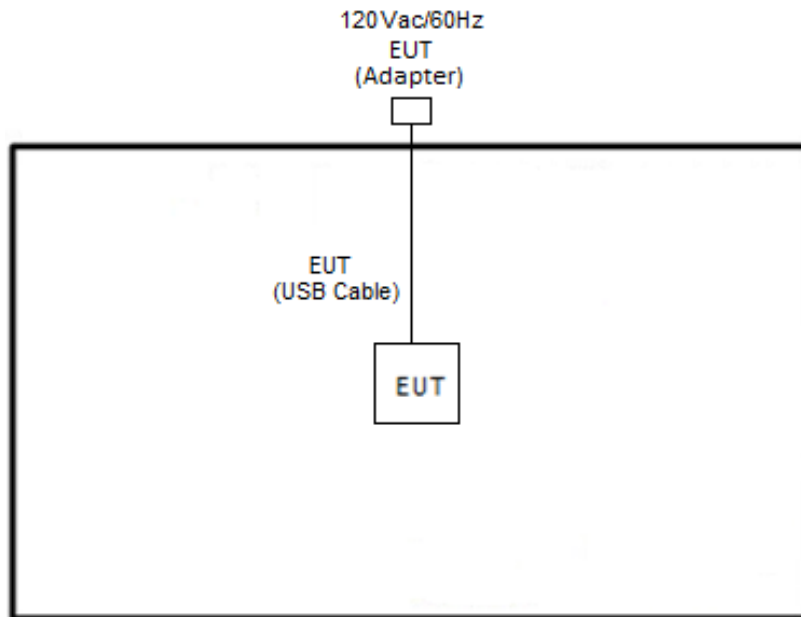

## 2.4 EUT Operation Test Setup

The RF test items, utility “QRCT V3.0.303.0” was installed in Notebook which was programmed in order to make the EUT get into the engineering modes to provide channel selection, power level, data rate and the application type and for continuous transmitting signals.





### 3 Test Result

#### 3.1 Maximum Conducted Output Power Measurement

##### 3.1.1 Limit of Maximum Conducted Output Power

<FCC 14-30 CFR 15.407>

**For the 5.15–5.25 GHz bands:**

■ For mobile and portable client devices in the 5.15–5.25 GHz band, the maximum conducted output power over the frequency band of operation shall not exceed 250 mW. For an indoor access point operating in the band 5.15-5.25 GHz, the maximum conducted output power over the frequency band of operation shall not exceed 1 W.

**For the 5.25–5.725 GHz bands:**

■ The maximum conducted output power over the frequency bands of operation shall not exceed the lesser of 250 mW or 11 dBm 10 log B, where B is the 26 dB emission bandwidth in megahertz.

For Straddle Channel, according to KDB 789033 D02 General UNII Test Procedures New Rules v02r01, if the power and PSD of the devices are uniform and comply with the lower limits specified for the U-NII-2 bands, a single measurement over the entire emission bandwidth can be performed to show compliance.

If transmitting antennas of directional gain greater than 6 dBi are used, the peak output power shall be reduced by the amount in dB that the directional gain of the antenna exceeds 6 dBi.

Note that U-NII-2 band, devices with a maximum e.i.r.p. greater than 500 mW shall implement TPC in order to have the capability to operate at least 6 dB below the maximum permitted e.i.r.p. of 1 W.

##### 3.1.2 Measuring Instruments

See list of measuring equipment of this test report.

### 3.1.3 Test Procedures

The testing follows Method PM-G of FCC KDB 789033 D02 General UNII Test Procedures New Rules v02r01.

Method PM-G (Measurement using a gated RF average power meter):

1. Measurement is performed using a wideband RF power meter.
2. The EUT is configured to transmit at its maximum power control level.
3. Measure the average power of the transmitter.
4. Since the measurement is made only during the ON time of the transmitter, no duty cycle correction factor is required.

For Straddle Channel, according to KDB 789033 D02 General UNII Test Procedures New Rules v02r01, if the power and PSD of the devices are uniform and comply with the lower limits specified for the U-NII-2 bands, a single measurement over the entire emission bandwidth can be performed to show compliance.

### 3.1.4 Test Setup

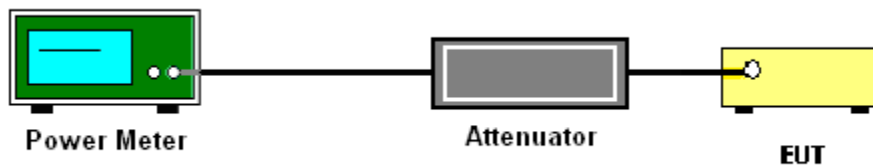

### 3.1.5 Test Result of Maximum Conducted Output Power

Please refer to Appendix A.



### 3.2 Unwanted Emissions Measurement

This section is to measure unwanted emissions through radiated measurement for band edge spurious emissions and out of band emissions measurement.

#### 3.2.1 Limit of Unwanted Emissions

(1) For transmitters operating in the 5150-5250 MHz band: all emissions outside of the 5150-5350 MHz band shall not exceed an EIRP of -27dBm/MHz.

For transmitters operating in the 5250-5350 MHz band: all emissions outside of the 5150-5350 MHz band shall not exceed an EIRP of -27 dBm/MHz. Devices operating in the 5250-5350 MHz band that generate emissions in the 5150-5250 MHz band must meet all applicable technical requirements for operation in the 5150-5250 MHz band (including indoor use) or alternatively meet an out-of-band emission EIRP limit of -27 dBm/MHz in the 5150-5250 MHz band.

For transmitters operating in the 5470-5600 MHz and 5650-5725MHz band: all emissions outside of the 5470-5600 MHz and 5650-5725MHz band shall not exceed an EIRP of -27 dBm/MHz.

(2) Unwanted spurious emissions fallen in restricted bands shall comply with the general field strength limits as below table:

Frequency (MHz)	Field Strength (microvolts/meter)	Measurement Distance (meters)
0.009 – 0.490	2400/F(kHz)	300
0.490 – 1.705	24000/F(kHz)	30
1.705 – 30.0	30	30
30 – 88	100	3
88 – 216	150	3
216 - 960	200	3
Above 960	500	3

**Note:** The following formula is used to convert the EIRP to field strength.

$$E = \frac{1000000\sqrt{30P}}{3} \mu\text{V/m, where P is the eirp (Watts)}$$



EIRP (dBm)	Field Strength at 3m (dBμV/m)
- 27	68.3

(3) KDB789033 D02 v02r01 G)2)c)

(i) Sections 15.407(b)(1-3) specifies the unwanted emissions limit for the U-NII-1 and U-NII-2 bands. As specified, emissions above 1000 MHz that are outside of the restricted bands are subject to a peak emission limit of -27 dBm/MHz.

(ii) Section 15.407(b)(4) specifies the unwanted emissions limit for the U-NII-3 band. A band emissions mask is specified in Section 15.407(b)(4)(i). The emission limits are based on the use of a peak detector.

### 3.2.2 Measuring Instruments

See list of measuring equipment of this test report.

### 3.2.3 Test Procedures

1. The testing follows FCC KDB 789033 D02 General UNII Test Procedures New Rules v02r01. Section G) Unwanted emissions measurement.

(1) Procedure for Unwanted Emissions Measurements Below 1000 MHz

- RBW = 120 kHz
- VBW = 300 kHz
- Detector = Peak
- Trace mode = max hold

(2) Procedure for Peak Unwanted Emissions Measurements Above 1000 MHz

- RBW = 1 MHz
- VBW ≥ 3 MHz
- Detector = Peak
- Sweep time = auto
- Trace mode = max hold

(3) Procedures for Average Unwanted Emissions Measurements Above 1000 MHz

- RBW = 1 MHz
- VBW = 10 Hz, when duty cycle is no less than 98 percent.
- VBW ≥ 1/T, when duty cycle is less than 98 percent where T is the minimum transmission duration over which the transmitter is on and is transmitting at its maximum power control level for the tested mode of operation.

2. The EUT was placed on a turntable with 0.8 meter for frequency below 1 GHz and 1.5 meter for frequency above 1 GHz respectively above ground.
3. The EUT was set 3 meters from the interference receiving antenna which was mounted on the top of a variable height antenna tower.
4. The antenna is a broadband antenna and its height is adjusted between one meter and four meters above ground to find the maximum value of the field strength for both horizontal polarization and vertical polarization of the antenna.
5. For each suspected emission, the EUT was arranged to its worst case and then adjust the antenna tower (from 1 m to 4 m) and turntable (from 0 degree to 360 degrees) to find the maximum reading.
6. For testing below 1 GHz, if the emission level of the EUT in peak mode was 3 dB lower than the limit specified, then peak values of EUT will be reported, otherwise, the emissions will be repeated one by one using the CISPR quasi-peak method and reported.
7. For testing above 1 GHz, the emission level of the EUT in peak mode was 20 dB lower than average limit (that means the emission level in average mode also complies with the limit in average mode), then peak values of EUT will be reported, otherwise, the emissions will be measured in average mode again and reported.

### 3.2.4 Test Setup

For radiated emissions below 30MHz

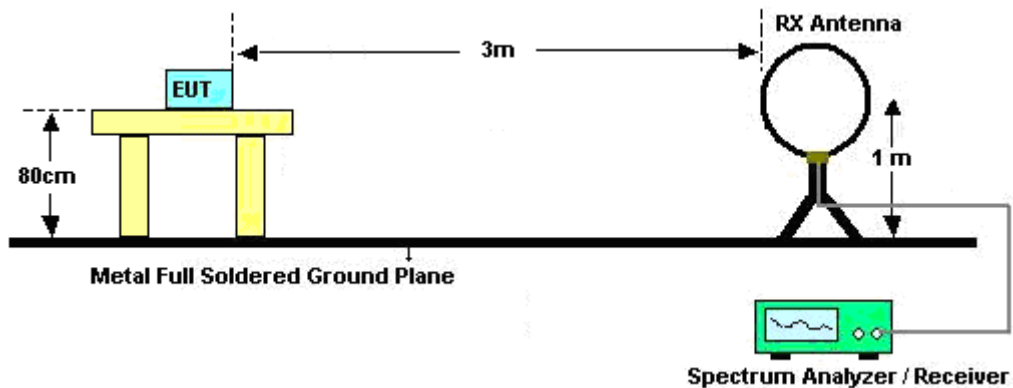

For radiated emissions from 30MHz to 1GHz

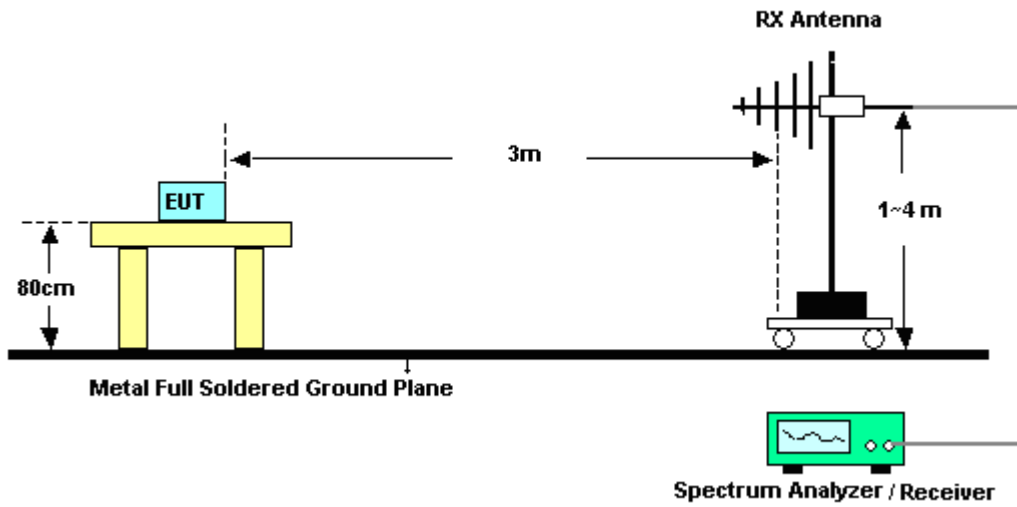

For radiated test from 1GHz to 18GHz

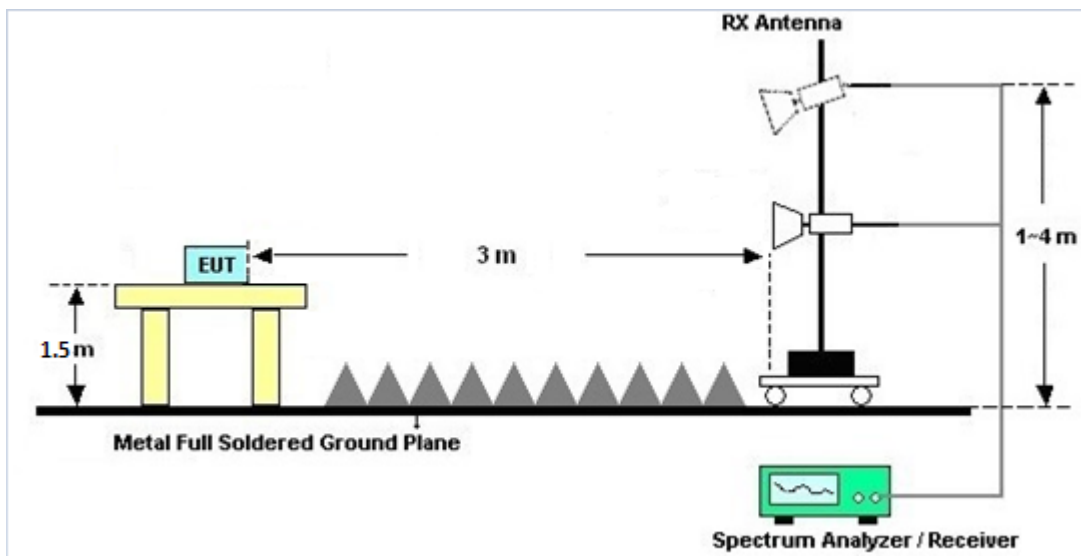

For radiated test above 18GHz

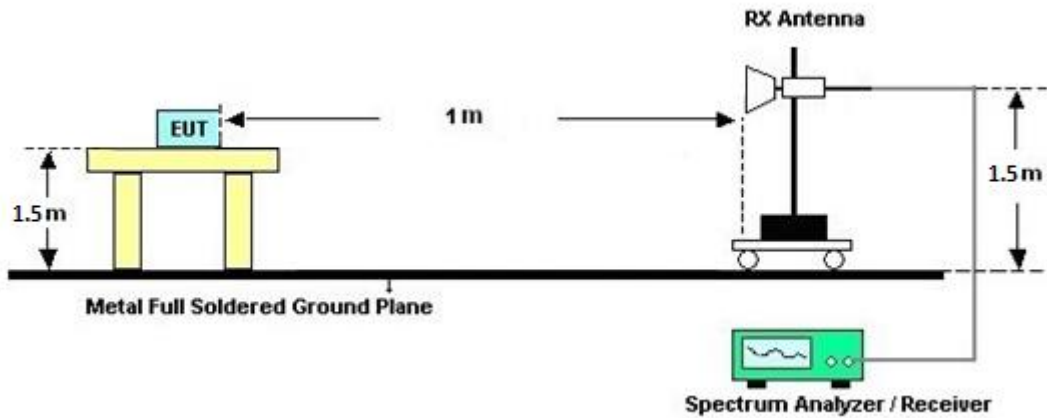

### 3.2.5 Test Results of Radiated Spurious Emissions (9 kHz ~ 30 MHz)

The low frequency, which started from 9 kHz to 30MHz, was pre-scanned and the result which was 20dB lower than the limit line was not reported.

There is adequate comparison measurement of both open-field test site and alternative test site - semi-Anechoic chamber according to 414788 D01 Radiated Test Site v01r01, and the result came out very similar.

### 3.2.6 Test Result of Radiated Spurious at Band Edges

Please refer to Appendix B and C.

### 3.2.7 Duty Cycle

Please refer to Appendix D.

### 3.2.8 Test Result of Radiated Spurious Emissions (30MHz ~ 10th Harmonic)

Please refer to Appendix B and C.



### **3.3 Antenna Requirements**

#### **3.3.1 Standard Applicable**

If transmitting antenna directional gain is greater than 6 dBi, both the peak transmit power and the peak power spectral density shall be reduced by the amount in dB that the directional gain of the antenna exceeds 6 dBi.

#### **3.3.2 Antenna Anti-Replacement Construction**

An embedded-in antenna design is used.

#### **3.3.3 Antenna Gain**

The antenna peak gain of EUT is less than 6 dBi. Therefore, it is not necessary to reduce maximum peak output power limit.





## 4 List of Measuring Equipment

Instrument	Brand Name	Model No.	Serial No.	Characteristics	Calibration Date	Test Date	Due Date	Remark
Hygrometer	Testo	608-H1	34893241	N/A	Mar. 03, 2021	Jul. 22, 2021	Mar. 02, 2022	Conducted (TH05-HY)
Power Sensor	DARE	RPR3006W	16I00054S NO10	10MHz~6GHz	Dec. 16, 2020	Jul. 22, 2021	Dec. 15, 2021	Conducted (TH05-HY)
Spectrum Analyzer	Rohde & Schwarz	FSP40	100055	9kHz-40GHz	Jan. 21, 2021	Jul. 22, 2021	Jan. 20, 2022	Conducted (TH05-HY)
Switch Box & RF Cable	EM Electronics	EMSW18SE	SW200302	N/A	Mar. 17, 2021	Jul. 22, 2021	Mar. 16, 2022	Conducted (TH05-HY)
Loop Antenna	Rohde & Schwarz	HFH2-Z2	100315	9 kHz~30 MHz	Jan. 04, 2021	Jul. 29, 2021~ Aug. 02, 2021	Jan. 03, 2022	Radiation (03CH16-HY)
Bilog Antenna	TESEQ	CBL 6111D & 00802N1D01 N-06	47020 & 06	30MHz to 1GHz	Oct. 11, 2020	Jul. 29, 2021~ Aug. 02, 2021	Oct. 10, 2021	Radiation (03CH16-HY)
Horn Antenna	SCHWARZBECK	BBHA 9120 D	9120D-152 2	1G~18GHz	Sep. 29, 2020	Jul. 29, 2021~ Aug. 02, 2021	Sep. 28, 2021	Radiation (03CH16-HY)
SHF-EHF Horn Antenna	SCHWARZBECK	BBHA 9170	00993	18GHz ~40GHz	Nov. 19, 2020	Jul. 29, 2021~ Aug. 02, 2021	Nov. 18, 2021	Radiation (03CH16-HY)
Amplifier	SONOMA	310N	371607	9kHz~1G	Jul. 05, 2021	Jul. 29, 2021~ Aug. 02, 2021	Jul. 04, 2022	Radiation (03CH16-HY)
Amplifier	Jet-Power	JPA0118-55-3 03	171000180 0054001	1-18GHz	Jun. 16, 2021	Jul. 29, 2021~ Aug. 02, 2021	Jun. 15, 2022	Radiation (03CH16-HY)
Preamplifier	EMEC	EM18G40G	060715	18GHz~40GHz	Dec. 11, 2020	Jul. 29, 2021~ Aug. 02, 2021	Dec. 10, 2021	Radiation (03CH16-HY)
Preamplifier	Keysight	83017A	MY532702 64	1GHz~26.5GHz	Dec. 10, 2020	Jul. 29, 2021~ Aug. 02, 2021	Dec. 09, 2021	Radiation (03CH16-HY)
EMI Test Receiver	Keysight	N9038A	MY590530 12	3Hz~26.5GHz	Nov. 18, 2020	Jul. 29, 2021~ Aug. 02, 2021	Nov. 17, 2021	Radiation (03CH16-HY)
RF Cable	HUBER + SUHNER	SUCOFLEX 104	MY11680/ 4PE	NA	Aug. 29, 2020	Jul. 29, 2021~ Aug. 02, 2021	Aug. 28, 2021	Radiation (03CH16-HY)
RF Cable	HUBER + SUHNER	SUCOFLEX 104	MY11688/ 4PE	NA	Aug. 29, 2020	Jul. 29, 2021~ Aug. 02, 2021	Aug. 28, 2021	Radiation (03CH16-HY)
RF Cable	HUBER + SUHNER	SUCOFLEX 102	EC-A5-300 -5757	NA	Aug. 29, 2020	Jul. 29, 2021~ Aug. 02, 2021	Aug. 28, 2021	Radiation (03CH16-HY)
Software	Audix	E3 6.2009-8-24	RK-001136	N/A	N/A	Jul. 29, 2021~ Aug. 02, 2021	N/A	Radiation (03CH16-HY)
Controller	ChainTek	3000-1	N/A	Control Turn table & Ant Mast	N/A	Jul. 29, 2021~ Aug. 02, 2021	N/A	Radiation (03CH16-HY)
Antenna Mast	ChainTek	MBS-520-1	N/A	1m~4m	N/A	Jul. 29, 2021~ Aug. 02, 2021	N/A	Radiation (03CH16-HY)
Turn Table	ChainTek	T-200-S-1	N/A	0~360 Degree	N/A	Jul. 29, 2021~ Aug. 02, 2021	N/A	Radiation (03CH16-HY)



## 5 Uncertainty of Evaluation

### Uncertainty of Radiated Emission Measurement (30 MHz ~ 1000 MHz)

Measuring Uncertainty for a Level of Confidence of 95% ( $U = 2Uc(y)$ )	5.1 dB
---	--------

### Uncertainty of Radiated Emission Measurement (1000 MHz ~ 18000 MHz)

Measuring Uncertainty for a Level of Confidence of 95% ( $U = 2Uc(y)$ )	6.8 dB
---	--------

### Uncertainty of Radiated Emission Measurement (18000 MHz ~ 40000 MHz)

Measuring Uncertainty for a Level of Confidence of 95% ( $U = 2Uc(y)$ )	4.6 dB
---	--------

**Appendix A. Test Result of Conducted Test Items**

Test Engineer:	Mina Liu	Temperature:	21~25	°C
Test Date:	2021/7/22	Relative Humidity:	51~54	%

**TEST RESULTS DATA**  
**Average Power Table**

FCC Band I single antenna												
Mod.	Data Rate	NTX	CH.	Freq. (MHz)	Average Conducted Power (dBm)			FCC Conducted Power Limit (dBm)		DG (dBi)		Pass/Fail
					Ant 1	Ant 2	SUM	Ant 1	Ant 2	Ant 1	Ant 2	
11a	6Mbps	1	36	5180	14.20	-		24.00	-	1.85	-	Pass
11a	6Mbps	1	44	5220	14.60	-		24.00	-	1.85	-	Pass
11a	6Mbps	1	48	5240	14.10	-		24.00	-	1.85	-	Pass
HT20	MCS0	1	36	5180	14.70	-		24.00	-	1.85	-	Pass
HT20	MCS0	1	44	5220	14.50	-		24.00	-	1.85	-	Pass
HT20	MCS0	1	48	5240	14.60	-		24.00	-	1.85	-	Pass
HT40	MCS0	1	38	5190	13.40	-		24.00	-	1.85	-	Pass
HT40	MCS0	1	46	5230	14.50	-		24.00	-	1.85	-	Pass

**TEST RESULTS DATA**  
**Average Power Table**

FCC Band II single antenna													
Mod.	Data Rate	NTX	CH.	Freq. (MHz)	Average Conducted Power (dBm)			FCC Conducted Power Limit (dBm)		DG (dBi)		EIRP Power Limit (dBm)	Pass/Fail
					Ant 1	Ant 2	SUM	Ant 1	Ant 2	Ant 1	Ant 2		
11a	6Mbps	1	52	5260	14.30	-		23.98	-	1.63	-	26.99	Pass
11a	6Mbps	1	60	5300	14.00	-		23.98	-	1.63	-	26.99	Pass
11a	6Mbps	1	64	5320	14.20	-		23.98	-	1.63	-	26.99	Pass
HT20	MCS0	1	52	5260	14.60	-		23.98	-	1.63	-	26.99	Pass
HT20	MCS0	1	60	5300	14.10	-		23.98	-	1.63	-	26.99	Pass
HT20	MCS0	1	64	5320	14.10	-		23.98	-	1.63	-	26.99	Pass
HT40	MCS0	1	54	5270	14.30	-		23.98	-	1.63	-	26.99	Pass
HT40	MCS0	1	62	5310	14.20	-		23.98	-	1.63	-	26.99	Pass

**TEST RESULTS DATA**  
**Average Power Table**

FCC Band III single antenna													
Mod.	Data Rate	NTX	CH.	Freq. (MHz)	Average Conducted Power (dBm)			FCC Conducted Power Limit (dBm)		DG (dBi)		EIRP Power Limit (dBm)	Pass/Fail
					Ant 1	Ant 2	SUM	Ant 1	Ant 2	Ant 1	Ant 2		
11a	6Mbps	1	100	5500	12.60	-		23.98	-	1.46	-	26.99	Pass
11a	6Mbps	1	116	5580	12.20	-		23.98	-	1.46	-	26.99	Pass
11a	6Mbps	1	140	5700	11.80	-		23.98	-	1.46	-	26.99	Pass
HT20	MCS0	1	100	5500	12.80	-		23.98	-	1.46	-	26.99	Pass
HT20	MCS0	1	116	5580	12.40	-		23.98	-	1.46	-	26.99	Pass
HT20	MCS0	1	140	5700	11.90	-		23.98	-	1.46	-	26.99	Pass
HT40	MCS0	1	102	5510	13.00	-		23.98	-	1.46	-	26.99	Pass
HT40	MCS0	1	110	5550	12.80	-		23.98	-	1.46	-	26.99	Pass
HT40	MCS0	1	134	5670	12.20	-		23.98	-	1.46	-	26.99	Pass

FCC Band III straddle channel single antenna													
Mod.	Data Rate	NTX	CH.	Freq. (MHz)	Average Conducted Power (dBm)			FCC Conducted Power Limit (dBm)		DG (dBi)		EIRP Power Limit (dBm)	Pass/Fail
					Ant 1	Ant 2	SUM	Ant 1	Ant 2	Ant 1	Ant 2		
11a	6Mbps	1	144	5720	11.90	-		23.98	-	1.46	-	26.99	Pass
HT20	MCS0	1	144	5720	11.90	-		23.98	-	1.46	-	26.99	Pass
HT40	MCS0	1	142	5710	12.10	-		23.98	-	1.46	-	26.99	Pass



## Appendix B. Radiated Spurious Emission

Test Engineer :	Karl Hou and Andy Yang	Temperature :	20~25°C
		Relative Humidity :	50~60%

### Band 1 - 5150~5250MHz

#### WIFI 802.11n HT40 (Band Edge @ 3m)

WIFI Ant.	Note	Frequency ( MHz )	Level ( dBμV/m )	Over Limit ( dB )	Limit Line ( dBμV/m )	Read Level ( dBμV )	Antenna Factor ( dB/m )	Path Loss ( dB )	Preamp Factor ( dB )	Ant Pos ( cm )	Table Pos ( deg )	Peak Avg. ( P/A )	Pol. ( H/V )
802.11n HT40 CH 38 5190MHz		5147.42	56.98	-17.02	74	41.81	31.8	13.04	29.67	100	153	P	H
		5149.24	48.69	-5.31	54	33.51	31.8	13.05	29.67	100	153	A	H
	*	5190	105.17	-	-	90.11	31.64	13.1	29.68	100	153	P	H
	*	5190	97.63	-	-	82.57	31.64	13.1	29.68	100	153	A	H
		5414.36	53.53	-20.47	74	38.38	31.39	13.48	29.72	100	153	P	H
		5440.68	44.38	-9.62	54	29.06	31.54	13.5	29.72	100	153	A	H
		5148.46	54.83	-19.17	74	39.65	31.8	13.05	29.67	319	286	P	V
		5150	46.03	-7.97	54	30.85	31.8	13.05	29.67	319	286	A	V
	*	5190	101.42	-	-	86.36	31.64	13.1	29.68	319	286	P	V
	*	5190	93.38	-	-	78.32	31.64	13.1	29.68	319	286	A	V
		5403.16	53.09	-20.91	74	38.01	31.32	13.47	29.71	319	286	P	V
	5396.44	43.66	-10.34	54	28.62	31.29	13.46	29.71	319	286	A	V	
Remark	1. No other spurious found. 2. All results are PASS against Peak and Average limit line.												



Band 1 5150~5250MHz
WIFI 802.11n HT40 (Harmonic @ 3m)

Table with 14 columns: WIFI Ant. 1, Note, Frequency (MHz), Level (dBµV/m), Over Limit (dB), Limit Line (dBµV/m), Read Level (dBµV), Antenna Factor (dB/m), Path Loss (dB), Preamp Factor (dB), Ant Pos (cm), Table Pos (deg), Peak Avg. (P/A), Pol. (H/V). Rows include data for 802.11n HT40 CH 38 at 10380 and 15570 MHz, and a Remark section.





Emission below 1GHz  
WIFI 802.11n HT40 (LF @ 3m)

WIFI	Note	Frequency	Level	Over	Limit	Read	Antenna	Path	Preamp	Ant	Table	Peak	Pol.	
Ant.				Limit	Line	Level	Factor	Loss	Factor	Pos	Pos	Avg.		
1		( MHz )	( dBμV/m )	( dB )	( dBμV/m )	(dBμV)	( dB/m )	( dB )	( dB )	( cm )	( deg )	(P/A)	(H/V)	
802.11n HT40 LF		103.72	26.87	-16.63	43.5	41.03	16.55	1.58	32.29	-	-	P	H	
		200.72	30.43	-13.07	43.5	45.23	15.13	2.33	32.26	-	-	P	H	
		407.33	27.78	-18.22	46	34.4	22.36	3.42	32.4	-	-	P	H	
		498.51	29.89	-16.11	46	34.33	24.14	3.77	32.35	-	-	P	H	
		732.28	32.78	-13.22	46	32.64	27.85	4.65	32.36	-	-	P	H	
		935.98	34.05	-11.95	46	29.75	30.2	5.4	31.3	100	0	P	H	
													H	
													H	
													H	
													H	
													H	
													H	
			37.76	29.16	-10.84	40	40.02	20.64	0.8	32.3	100	0	P	V
			98.87	28.99	-14.51	43.5	43.79	15.96	1.54	32.3	-	-	P	V
			201.69	27.06	-16.44	43.5	41.83	15.15	2.34	32.26	-	-	P	V
			399.57	25.72	-20.28	46	32.64	22.08	3.39	32.39	-	-	P	V
			569.32	28.12	-17.88	46	30.39	26.12	4.08	32.47	-	-	P	V
			933.07	34.22	-11.78	46	30.06	30.09	5.39	31.32	-	-	P	V
														V
														V
													V	
													V	
													V	
													V	
Remark	1. No other spurious found. 2. All results are PASS against limit line.													



**Note symbol**

*	<b>Fundamental Frequency</b> which can be ignored. However, the level of any unwanted emissions shall not exceed the level of the fundamental frequency.
!	Test result is <b>over limit</b> line.
P/A	<b>Peak</b> or <b>Average</b>
H/V	<b>Horizontal</b> or <b>Vertical</b>



A calculation example for radiated spurious emission is shown as below:

WIFI	Note	Frequency	Level	Over	Limit	Read	Antenna	Path	Preamp	Ant	Table	Peak	Pol.
Ant.				Limit	Line	Level	Factor	Loss	Factor	Pos	Pos	Avg.	
1		( MHz )	( dBμV/m )	( dB )	( dBμV/m )	( dBμV )	( dB/m )	( dB )	( dB )	( cm )	( deg )	( P/A )	( H/V )
802.11b		2390	55.45	-18.55	74	54.51	32.22	4.58	35.86	103	308	P	H
CH 01													
2412MHz		2390	43.54	-10.46	54	42.6	32.22	4.58	35.86	103	308	A	H

1. Path Loss(dB) = Cable loss(dB) + Filter loss(dB) + Attenuator loss(dB)
2. Level(dBμV/m) = Antenna Factor(dB/m) + Path Loss(dB) + Read Level(dBμV) - Preamp Factor(dB)
3. Over Limit(dB) = Level(dBμV/m) – Limit Line(dBμV/m)

**For Peak Limit @ 2390MHz:**

1. Level(dBμV/m)  
= Antenna Factor(dB/m) + Path Loss(dB) + Read Level(dBμV) - Preamp Factor(dB)  
= 32.22(dB/m) + 4.58(dB) + 54.51(dBμV) – 35.86 (dB)  
= 55.45 (dBμV/m)
2. Over Limit(dB)  
= Level(dBμV/m) – Limit Line(dBμV/m)  
= 55.45(dBμV/m) – 74(dBμV/m)  
= -18.55(dB)

**For Average Limit @ 2390MHz:**

1. Level(dBμV/m)  
= Antenna Factor(dB/m) + Path Loss(dB) + Read Level(dBμV) - Preamp Factor(dB)  
= 32.22(dB/m) + 4.58(dB) + 42.6(dBμV) – 35.86 (dB)  
= 43.54 (dBμV/m)
2. Over Limit(dB) = Level(dBμV/m) – Limit Line(dBμV/m)  
= 43.54(dBμV/m) – 54(dBμV/m)  
= -10.46(dB)

**Both peak and average measured complies with the limit line, so test result is “PASS”.**



### Appendix C. Radiated Spurious Emission Plots

Test Engineer :	Karl Hou and Andy Yang	Temperature :	20~25°C
		Relative Humidity :	50~60%

Note symbol

-L	Low channel location
-R	High channel location



**Band 1 - 5150~5250MHz**  
**WIFI 802.11n HT40 (Band Edge @ 3m)**

WIFI	Band 1 5150~5250MHz Band Edge @ 3m	
ANT	802.11n HT40 CH38 5190MHz - L	
1	Horizontal	Fundamental
<b>Peak</b>	<p>Site : 03CH16-HY            Condition : PEAK_BE_74 3m 91200_1522 HORIZONTAL            RBW:1000.000KHz VBW:3000.000KHz SWT:Auto            Detector : Peak            Project : 970921-08</p>	<p>Site : 03CH16-HY            Condition : PEAK(LINE) 3m 91200_1522 HORIZONTAL            RBW:1000.000KHz VBW:3000.000KHz SWT:Auto            Detector : Peak            Project : 970921-08</p>
<b>Avg.</b>	<p>Site : 03CH16-HY            Condition : AV6_BE_54 3m 91200_1522 HORIZONTAL            RBW:1000.000KHz VBW:3.000KHz SWT:Auto            Detector : Peak            Project : 970921-08</p>	<b>Left blank</b>



WIFI	Band 1 5150~5250MHz Band Edge @ 3m	
ANT	802.11n HT40 CH38 5190MHz - R	
1	Horizontal	Fundamental
Peak	<p>Site : 03CH16-HY Condition : PEAK_BE_74 3m 91200_1522 HORIZONTAL RBW:1000.000kHz, VBW:3000.000kHz, SWT:Auto Detector : Peak Project : 970921-08</p>	Left blank
Avg.	<p>Site : 03CH16-HY Condition : AVG_BE_54 3m 91200_1522 HORIZONTAL RBW:1000.000kHz, VBW:3.000kHz, SWT:Auto Detector : Peak Project : 970921-08</p>	Left blank



WIFI	Band 1 5150~5250MHz Band Edge @ 3m	
ANT	802.11n HT40 CH38 5190MHz - L	
1	Vertical	Fundamental
Peak	<p>Site : 03CH16-HY            Condition : PEAK_BE_74 3m 91200_1522 VERTICAL            Detector : RBW:1000.000KHz VBW:3000.000KHz SWT:Auto            Detector : Peak            Project : 970921-08</p>	<p>Site : 03CH16-HY            Condition : PEAK(UNII) 3m 91200_1522 VERTICAL            Detector : RBW:1000.000KHz VBW:3000.000KHz SWT:Auto            Detector : Peak            Project : 970921-08</p>
Avg.	<p>Site : 03CH16-HY            Condition : AVG_BE_54 3m 91200_1522 VERTICAL            Detector : RBW:1000.000KHz VBW:3.000KHz SWT:Auto            Detector : Peak            Project : 970921-08</p>	Left blank

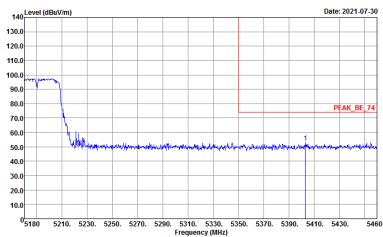
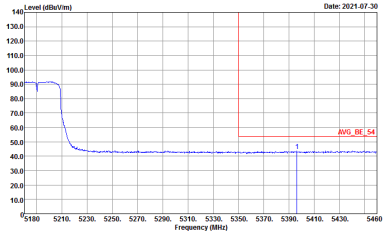

WIFI	Band 1 5150~5250MHz Band Edge @ 3m	
ANT	802.11n HT40 CH38 5190MHz - R	
1	Vertical	Fundamental
Peak	 <p>Site : 03CH16-HY            Condition : PEAK_BE_74 3m 91200_1522 VERTICAL            Detector : Peak            Project : 970921-08</p>	Left blank
Avg.	 <p>Site : 03CH16-HY            Condition : AVG_BE_54 3m 91200_1522 VERTICAL            Detector : Peak            Project : 970921-08</p>	Left blank





**Band 1 - 5150~5250MHz**  
**WIFI 802.11n HT40 (Harmonic @ 3m)**

<b>WIFI</b>	<b>Band 1 5150~5250MHz Harmonic @ 3m</b>	
<b>ANT</b>	<b>802.11n HT40 CH38 5190MHz</b>	
<b>1</b>	<b>Horizontal</b>	<b>Vertical</b>
<b>Peak</b> <b>Avg.</b>	<p>Site : 03CH16-HY          Condition : PEAR(LINE1) 3m 91200_1522 HORIZONTAL          Detector : Peak          Project : 970921-08</p>	<p>Site : 03CH16-HY          Condition : PEAR(LINE1) 3m 91200_1522 VERTICAL          Detector : Peak          Project : 970921-08</p>



Emission below 1GHz  
5GHz WIFI 802.11n HT40 (LF)

WIFI	5GHz WIFI	
ANT	802.11n HT40 LF	
1	Horizontal	Vertical
QP / Peak	<p>Site : 03CH16-HY Condition : QP 3m BIL06_47020406 HORIZONTAL Detector : Peak Project : 970921-08</p>	<p>Site : 03CH16-HY Condition : QP 3m BIL06_47020406 VERTICAL Detector : Peak Project : 970921-08</p>



### Appendix D. Duty Cycle Plots

Band	Duty Cycle(%)	T(us)	1/T(kHz)	VBW Setting
5GHz 802.11n HT40	75.90	633	1.58	3kHz

