



## TEST REPORT

Test report no.: 1-1581/20-01-09

BNetzA-CAB-02/21-102

### Testing laboratory

**CTC advanced GmbH**  
Untertuerkheimer Strasse 6 – 10  
66117 Saarbruecken / Germany  
Phone: + 49 681 5 98 - 0  
Fax: + 49 681 5 98 - 9075  
Internet: <https://www.ctcadvanced.com>  
e-mail: [mail@ctcadvanced.com](mailto:mail@ctcadvanced.com)

#### Accredited Testing Laboratory:

The testing laboratory (area of testing) is accredited according to DIN EN ISO/IEC 17025 (2018-03) by the Deutsche Akkreditierungsstelle GmbH (DAkkS). The accreditation is valid for the scope of testing procedures as stated in the accreditation certificate starting with the registration number: D-PL-12076-01.

### Applicant

**beyerdynamic GmbH & Co. KG**  
Theresienstraße 8  
74072 Heilbronn / GERMANY  
Phone: +49 7131 617-0  
Contact: Ulrich Roth  
e-mail: [roth@beyerdynamic.de](mailto:roth@beyerdynamic.de)

### Manufacturer

**SHENZHEN 3NOD ACOUSTICLINK CO., LTD**  
26F 3NOD Smart Building, No.3388,  
Binhai Avenue, Nanshan District  
518000 Shenzhen / CHINA

### Test standard/s

FCC - Title 47 CFR Part 15    FCC - Title 47 of the Code of Federal Regulations; Chapter I; Part 15 - Radio frequency devices  
RSS - 247 Issue 2            Digital Transmission Systems (DTSS), Frequency Hopping Systems (FHSs) and Licence - Exempt Local Area Network (LE-LAN) Devices

For further applied test standards please refer to section 3 of this test report.

### Test Item

**Kind of test item:**            **Bluetooth Speakerphone**  
**Model name:**                **beyerdynamic SPACE**  
**FCC ID:**                        **OSDSpace**  
**IC:**                                **3628C-SPACE**  
**Frequency:**                    2400 MHz to 2483.5 MHz  
**Technology tested:**        Bluetooth® + EDR  
**Antenna:**                        Integrated antenna  
**Power supply:**                3.7 V DC by battery  
**Temperature range:**        -10°C to +55°C

This test report is electronically signed and valid without handwritten signature. For verification of the electronic signatures, the public keys can be requested at the testing laboratory.

### Test report authorized:

David Lang  
Lab Manager  
Radio Communications

### Test performed:

Michael Dorongovski  
Lab Manager  
Radio Communications

## 1 Table of contents

1	Table of contents .....	2
2	General information .....	4
2.1	Notes and disclaimer .....	4
2.2	Application details .....	4
2.3	Test laboratories sub-contracted .....	4
3	Test standard/s, references and accreditations .....	5
4	Reporting statements of conformity – decision rule .....	6
5	Test environment .....	7
6	Test item .....	7
6.1	General description .....	7
6.2	Additional information .....	7
7	Sequence of testing .....	8
7.1	Sequence of testing radiated spurious 9 kHz to 30 MHz .....	8
7.2	Sequence of testing radiated spurious 30 MHz to 1 GHz .....	9
7.3	Sequence of testing radiated spurious 1 GHz to 18 GHz .....	10
7.4	Sequence of testing radiated spurious above 18 GHz .....	11
8	Description of the test setup.....	12
8.1	Shielded semi anechoic chamber .....	13
8.2	Shielded fully anechoic chamber .....	14
8.3	Radiated measurements > 18 GHz.....	15
8.4	Conducted measurements Bluetooth system .....	16
8.5	AC conducted .....	17
9	Measurement uncertainty .....	18
10	Summary of measurement results .....	19
11	Additional comments .....	20
12	Measurement results .....	21
12.1	Antenna gain.....	21
12.2	Carrier frequency separation .....	22
12.3	Number of hopping channels .....	23
12.4	Time of occupancy (dwell time) .....	24
12.5	Spectrum bandwidth of a FHSS system .....	26
12.6	Maximum output power.....	28
12.7	Band edge compliance radiated .....	29
12.8	Spurious emissions conducted .....	33
12.9	Spurious emissions radiated below 30 MHz.....	36
12.10	Spurious emissions radiated 30 MHz to 1 GHz .....	39
12.11	Spurious emissions radiated above 1 GHz .....	43
12.12	Spurious emissions conducted below 30 MHz (AC conducted).....	48
13	Glossary .....	51
14	Document history.....	52

15	Accreditation Certificate – D-PL-12076-01-04 .....	52
16	Accreditation Certificate – D-PL-12076-01-05 .....	53

## 2 General information

### 2.1 Notes and disclaimer

The test results of this test report relate exclusively to the test item specified in this test report. CTC advanced GmbH does not assume responsibility for any conclusions and generalizations drawn from the test results with regard to other specimens or samples of the type of the equipment represented by the test item.

The test report may only be reproduced or published in full. Reproduction or publication of extracts from the report requires the prior written approval of CTC advanced GmbH.

The testing service provided by CTC advanced GmbH has been rendered under the current "General Terms and Conditions for CTC advanced GmbH".

CTC advanced GmbH will not be liable for any loss or damage resulting from false, inaccurate, inappropriate or incomplete product information provided by the customer.

Under no circumstances does the CTC advanced GmbH test report include any endorsement or warranty regarding the functionality, quality or performance of any other product or service provided.

Under no circumstances does the CTC advanced GmbH test report include or imply any product or service warranties from CTC advanced GmbH, including, without limitation, any implied warranties of merchantability, fitness for purpose, or non-infringement, all of which are expressly disclaimed by CTC advanced GmbH.

All rights and remedies regarding vendor's products and services for which CTC advanced GmbH has prepared this test report shall be provided by the party offering such products or services and not by CTC advanced GmbH. In no case this test report can be considered as a Letter of Approval.

This test report is electronically signed and valid without handwritten signature. For verification of the electronic signatures, the public keys can be requested at the testing laboratory.

### 2.2 Application details

Date of receipt of order:	2021-08-16
Date of receipt of test item:	2021-08-16
Start of test:*	2021-08-16
End of test:*	2021-10-11
Person(s) present during the test:	Mr. Oliver Spychala

\*Date of each measurement, if not shown in the plot, can be requested. Dates are stored in the measurement software.



### 2.3 Test laboratories sub-contracted

None

### 3 Test standard/s, references and accreditations

Test standard	Date	Description
FCC - Title 47 CFR Part 15		FCC - Title 47 of the Code of Federal Regulations; Chapter I; Part 15 - Radio frequency devices
RSS - 247 Issue 2	February 2017	Digital Transmission Systems (DTSs), Frequency Hopping Systems (FHSs) and Licence - Exempt Local Area Network (LE-LAN) Devices
RSS - Gen Issue 5 incl. Amendment 1 & 2	February 2021	Spectrum Management and Telecommunications Radio Standards Specification - General Requirements for Compliance of Radio Apparatus

Guidance	Version	Description
KDB 558074 D01	v05r02	GUIDANCE FOR COMPLIANCE MEASUREMENTS ON DIGITAL TRANSMISSION SYSTEM, FREQUENCY HOPPING SPREAD SPECTRUM SYSTEM, AND HYBRID SYSTEM DEVICES OPERATING UNDER SECTION 15.247 OF THE FCC RULES
ANSI C63.4-2014	-/-	American National Standard for Methods of Measurement of Radio-Noise Emissions from Low-Voltage Electrical and Electronic Equipment in the Range of 9 kHz to 40 GHz
ANSI C63.10-2013	-/-	American National Standard of Procedures for Compliance Testing of Unlicensed Wireless Devices

Accreditation	Description	
D-PL-12076-01-04	Telecommunication and EMC Canada <a href="https://www.dakks.de/as/ast/d/D-PL-12076-01-04e.pdf">https://www.dakks.de/as/ast/d/D-PL-12076-01-04e.pdf</a>	  <small>Deutsche Akkreditierungsstelle D-PL-12076-01-04</small>
D-PL-12076-01-05	Telecommunication FCC requirements <a href="https://www.dakks.de/as/ast/d/D-PL-12076-01-05e.pdf">https://www.dakks.de/as/ast/d/D-PL-12076-01-05e.pdf</a>	  <small>Deutsche Akkreditierungsstelle D-PL-12076-01-05</small>

ISED Testing Laboratory Recognized Listing Number: DE0001  
FCC designation number: DE0002

#### 4 Reporting statements of conformity – decision rule

Only the measured values related to their corresponding limits will be used to decide whether the equipment under test meets the requirements of the test standards listed in chapter 3.

The measurement uncertainty is mentioned in this test report, see chapter 9 but is not taken into account - neither to the limits nor to the measurement results. Measurement results with a smaller margin to the corresponding limits than the measurement uncertainty have a potential risk of more than 5% that the decision might be wrong."

measured value, measurement uncertainty, verdict

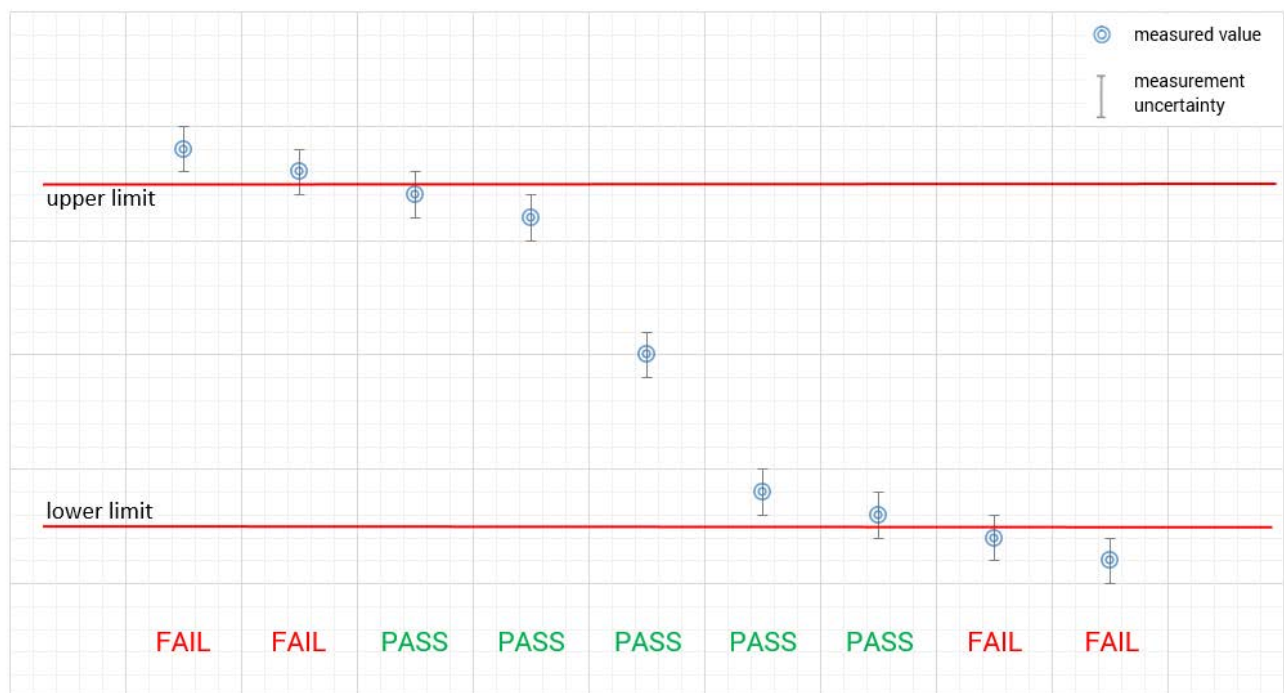

## 5 Test environment

Temperature	:	$T_{nom}$ $T_{max}$ $T_{min}$	+22 °C during room temperature tests No tests under extreme environmental conditions required. No tests under extreme environmental conditions required.
Relative humidity content	:		55 %
Barometric pressure	:		1021 hpa
Power supply	:	$V_{nom}$ $V_{max}$ $V_{min}$	3.7 V DC by battery No tests under extreme environmental conditions required. No tests under extreme environmental conditions required.

## 6 Test item

### 6.1 General description

Kind of test item	:	Bluetooth Speakerphone
Model name	:	beyerdynamic SPACE
HMN	:	N/A
PMN	:	beyerdynamic SPACE
HVIN	:	beyerdynamic SPACE
FVIN	:	N/A
S/N serial number	:	Rad. 728632001011 Cond. F44EFC807901
Hardware status	:	M-1164-MB-V4.0 (DV1)
Software status	:	N/A
Firmware status	:	SPACE_DV1_210812_BQB / SPACE_DV1_210812_FCC / SPACE_DV1_210812_V0.2.1
Frequency band	:	2400 MHz to 2483.5 MHz
Type of radio transmission	:	FHSS
Use of frequency spectrum	:	
Type of modulation	:	GFSK, Pi/4-DQPSK, 8DPSK
Number of channels	:	79
Antenna	:	Integrated antenna
Power supply	:	3.7 V DC by battery
Temperature range	:	-10°C to +55°C

### 6.2 Additional information

The content of the following annexes is defined in the QA. It may be that not all of the listed annexes are necessary for this report, thus some values in between may be missing.

Test setup and EUT photos are included in test report:

- 1-1581/20-01-01\_AnnexA
- 1-1581/20-01-01\_AnnexB
- 1-1581/20-01-01\_AnnexD

## 7 Sequence of testing

### 7.1 Sequence of testing radiated spurious 9 kHz to 30 MHz

#### Setup

- The equipment is set up to simulate normal operation mode as described in the user manual or defined by the manufacturer.
- If the EUT is a tabletop system, it is placed on a table with 0.8 m height.
- If the EUT is a floor standing device, it is placed directly on the turn table.
- Auxiliary equipment and cables are positioned to simulate normal operation conditions as described in ANSI C 63.4.
- The AC power port of the EUT (if available) is connected to a power outlet below the turntable.
- Measurement distance is 3 m (see ANSI C 63.4) – see test details.
- EUT is set into operation.

#### Premeasurement\*

- The turntable rotates from 0° to 315° using 45° steps.
- The antenna height is 1 m.
- At each turntable position the analyzer sweeps with positive-peak detector to find the maximum of all emissions.

#### Final measurement

- Identified emissions during the pre-measurement are maximized by the software by rotating the turntable from 0° to 360°.
- Loop antenna is rotated about its vertical axis for maximum response at each azimuth about the EUT. (For certain applications, the loop antenna plane may also need to be positioned horizontally at the specified distance from the EUT)
- The final measurement is done in the position (turntable and elevation) causing the highest emissions with quasi-peak (as described in ANSI C 63.4).
- Final levels, frequency, measuring time, bandwidth, turntable position, correction factor, margin to the limit and limit will be recorded. A plot with the graph of the premeasurement and the limit is stored.

\*Note: The sequence will be repeated three times with different EUT orientations.



## 7.2 Sequence of testing radiated spurious 30 MHz to 1 GHz

### Setup

- The equipment is set up to simulate normal operation mode as described in the user manual or defined by the manufacturer.
- If the EUT is a tabletop system, a table with 0.8 m height is used, which is placed on the ground plane.
- If the EUT is a floor standing device, it is placed on the ground plane with insulation between both.
- Auxiliary equipment and cables are positioned to simulate normal operation conditions as described in ANSI C 63.4.
- The AC power port of the EUT (if available) is connected to a power outlet below the turntable.
- Measurement distance is 10 m or 3 m (see ANSI C 63.4) – see test details.
- EUT is set into operation.

### Premeasurement

- The turntable rotates from 0° to 315° using 45° steps.
- The antenna is polarized vertical and horizontal.
- The antenna height changes from 1 m to 3 m.
- At each turntable position, antenna polarization and height the analyzer sweeps three times in peak to find the maximum of all emissions.

### Final measurement

- The final measurement is performed for at least six highest peaks according to the requirements of the ANSI C63.4.
- Based on antenna and turntable positions at which the peak values are measured the software maximize the peaks by changing turntable position  $\pm 45^\circ$  and antenna height between 1 and 4 m.
- The final measurement is done with quasi-peak detector (as described in ANSI C 63.4).
- Final levels, frequency, measuring time, bandwidth, antenna height, antenna polarization, turntable angle, correction factor, margin to the limit and limit are recorded. A plot with the graph of the premeasurement with marked maximum final results and the limit is stored.

### 7.3 Sequence of testing radiated spurious 1 GHz to 18 GHz

#### Setup

- The equipment is set up to simulate normal operation mode as described in the user manual or defined by the manufacturer.
- If the EUT is a tabletop system, a 2-axis positioner with 1.5 m height is used.
- If the EUT is a floor standing device, it is placed directly on the turn table.
- Auxiliary equipment and cables are positioned to simulate normal operation conditions as described in ANSI C 63.4.
- The AC power port of the EUT (if available) is connected to a power outlet below the turntable.
- Measurement distance is 3 m (see ANSI C 63.4) – see test details.
- EUT is set into operation.

#### Premeasurement

- The turntable rotates from 0° to 315° using 45° steps.
- The antenna is polarized vertical and horizontal.
- The antenna height is 1.5 m.
- At each turntable position and antenna polarization the analyzer sweeps with positive peak detector to find the maximum of all emissions.

#### Final measurement

- The final measurement is performed for at least six highest peaks according to the requirements of the ANSI C63.4.
- Based on antenna and turntable positions at which the peak values are measured the software maximizes the peaks by rotating the turntable from 0° to 360°. This measurement is repeated for different EUT-table positions (0° to 150° in 30°-steps) and for both antenna polarizations.
- The final measurement is done in the position (turntable, EUT-table and antenna polarization) causing the highest emissions with Peak and RMS detector (as described in ANSI C 63.4).
- Final levels, frequency, measuring time, bandwidth, turntable position, EUT-table position, antenna polarization, correction factor, margin to the limit and limit are recorded. A plot with the graph of the premeasurement with marked maximum final results and the limit is stored.

## 7.4 Sequence of testing radiated spurious above 18 GHz

### Setup

- The equipment is set up to simulate normal operation mode as described in the user manual or defined by the manufacturer.
- Auxiliary equipment and cables are positioned to simulate normal operation conditions as described in ANSI C 63.4.
- The AC power port of the EUT (if available) is connected to a power outlet.
- The measurement distance is as appropriate (e.g. 0.5 m).
- The EUT is set into operation.

### Premeasurement

- The test antenna is handheld and moved carefully over the EUT to cover the EUT's whole sphere and different polarizations of the antenna.

### Final measurement

- The final measurement is performed at the position and antenna orientation causing the highest emissions with Peak and RMS detector (as described in ANSI C 63.4).
- Final levels, frequency, measuring time, bandwidth, correction factor, margin to the limit and limit are recorded. A plot with the graph of the premeasurement and the limit is stored.

## 8 Description of the test setup

Typically, the calibrations of the test apparatus are commissioned to and performed by an accredited calibration laboratory. The calibration intervals are determined in accordance with the DIN EN ISO/IEC 17025. In addition to the external calibrations, the laboratory executes comparison measurements with other calibrated test systems or effective verifications. Weekly chamber inspections and range calibrations are performed. Where possible, RF generating and signaling equipment as well as measuring receivers and analyzers are connected to an external high-precision 10 MHz reference (GPS-based or rubidium frequency standard).

In order to simplify the identification of the equipment used at some special tests, some items of test equipment and ancillaries can be provided with an identifier or number in the equipment list below (Lab/Item).

Each block diagram listed can contain several test setup configurations. All devices belonging to a test setup are identified with the same letter syntax. For example: Column Setup and all devices with an A.

### **Agenda:** Kind of Calibration

k	calibration / calibrated	EK	limited calibration
ne	not required (k, ev, izw, zw not required)	zw	cyclical maintenance (external cyclical maintenance)
ev	periodic self verification	izw	internal cyclical maintenance
Ve	long-term stability recognized	g	blocked for accredited testing
vlk!	Attention: extended calibration interval		
NK!	Attention: not calibrated	*)	next calibration ordered / currently in progress

## 8.1 Shielded semi anechoic chamber

The radiated measurements are performed in vertical and horizontal plane in the frequency range from 30 MHz to 1 GHz in semi-anechoic chambers. The EUT is positioned on a non-conductive support with a height of 0.80 m above a conductive ground plane that covers the whole chamber. The receiving antennas are conform to specifications ANSI C63. These antennas can be moved over the height range between 1.0 m and 4.0 m in order to search for maximum field strength emitted from EUT. The measurement distances between EUT and receiving antennas are indicated in the test setups for the various frequency ranges. For each measurement, the EUT is rotated in all three axes until the maximum field strength is received. The wanted and unwanted emissions are received by spectrum analyzers where the detector modes and resolution bandwidths over various frequency ranges are set according to requirement ANSI C63.

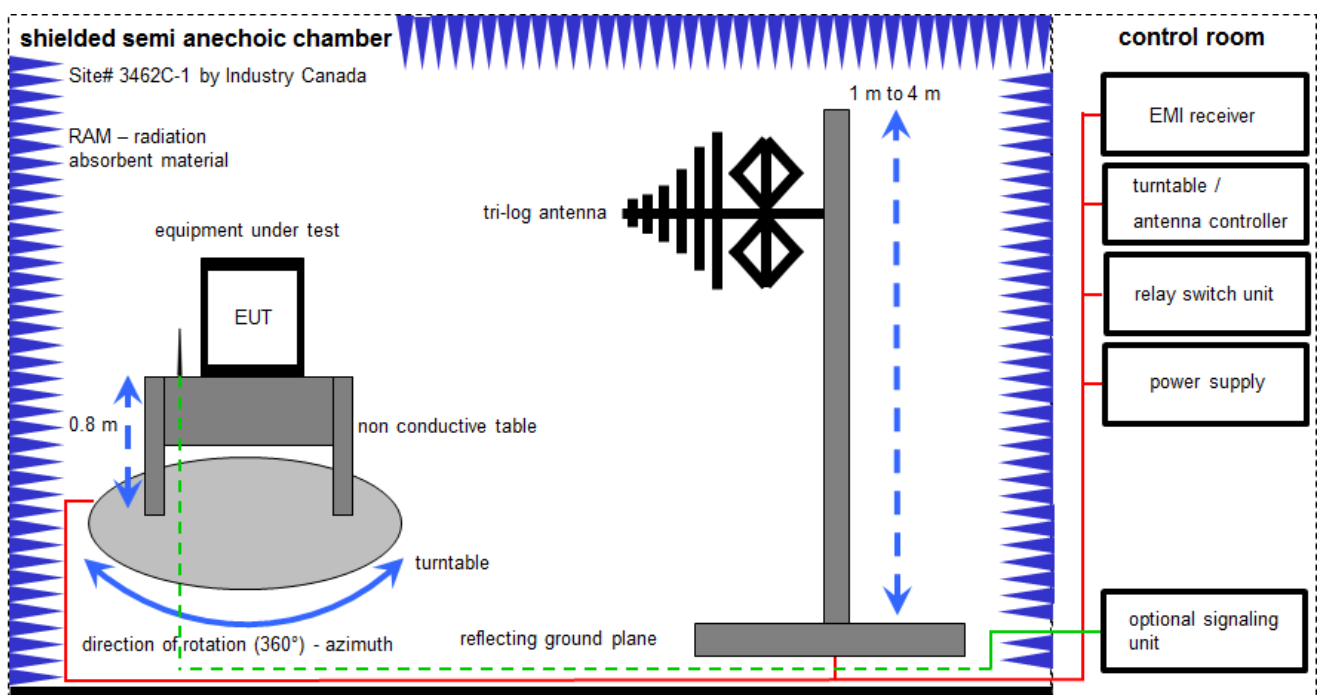

Measurement distance: tri-log antenna 10 meter; EMC32 software version: 10.59.00

FS = UR + CL + AF

(FS-field strength; UR-voltage at the receiver; CL-loss of the cable; AF-antenna factor)

Example calculation:

FS [dB $\mu$ V/m] = 12.35 [dB $\mu$ V/m] + 1.90 [dB] + 16.80 [dB/m] = 31.05 [dB $\mu$ V/m] (35.69  $\mu$ V/m)

**Equipment table:**

No.	Setup	Equipment	Type	Manufact.	Serial No.	INV. No Cetecom	Kind of Calibration	Last Calibration	Next Calibration
1	A	Switch-Unit	3488A	HP	2719A14505	300000368	ev	-/-	-/-
2	A	Meßkabine 1	HF-Absorberhalle	MWB AG 300023	-/-	300000551	ne	-/-	-/-
3	A	Antenna Tower	Model 2175	ETS-Lindgren	64762	300003745	izw	-/-	-/-
4	A	Positioning Controller	Model 2090	ETS-Lindgren	64672	300003746	izw	-/-	-/-
5	A	Turntable Interface- Box	Model 105637	ETS-Lindgren	44583	300003747	izw	-/-	-/-
6	A	TRILOG Broadband Test-Antenna 30 MHz - 3 GHz	VULB9163	Schwarzbeck Mess - Elektronik	318	300003696	vKI!	04.09.2019	03.09.2021
7	A	TRILOG Broadband Test-Antenna 30 MHz - 3 GHz	VULB9163	Schwarzbeck Mess - Elektronik	295	300003787	vKI!	21.04.2021	20.04.2023
8	A	EMI Test Receiver	ESR3	Rohde & Schwarz	102587	300005771	k	10.12.2020	09.06.2022

## 8.2 Shielded fully anechoic chamber

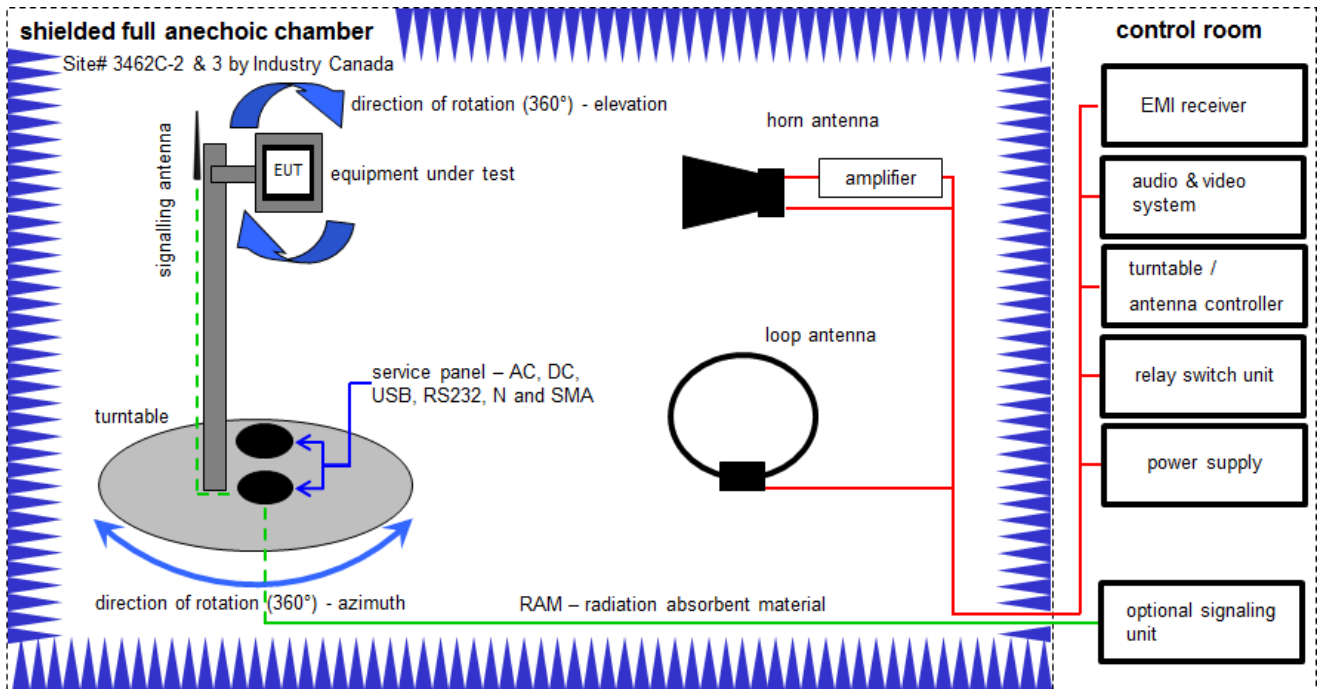

Measurement distance: horn antenna 3 meter; loop antenna 3 meter / 1 meter

FS = UR + CA + AF

(FS-field strength; UR-voltage at the receiver; CA-loss of the signal path; AF-antenna factor)

Example calculation:

FS [dB $\mu$ V/m] = 40.0 [dB $\mu$ V/m] + (-35.8) [dB] + 32.9 [dB/m] = 37.1 [dB $\mu$ V/m] (71.61  $\mu$ V/m)

### Equipment table:

No.	Setup	Equipment	Type	Manufact.	Serial No.	INV. No Cetecom	Kind of Calibration	Last Calibration	Next Calibration
1	A, B, C	Anechoic chamber	FAC 3/5m	MWB / TDK	87400/02	300000996	ev	-/-	-/-
2	A, C	Double-Ridged Waveguide Horn Antenna 1-18.0GHZ	3115	EMCO	8812-3089	300000307	vKI!	28.08.2019	27.08.2021
3	A, C	Double-Ridged Waveguide Horn Antenna 1-18.0GHZ	3115	EMCO	9107-3697	300001605	vKI!	12.03.2021	11.03.2023
4	B	Active Loop Antenna 9 kHz to 30 MHz	6502	EMCO	2210	300001015	vKI!	13.06.2019	12.06.2022
5	A, B, C	Switch / Control Unit	3488A	HP	*	300000199	ne	-/-	-/-
6	A, B, C	EMI Test Receiver 9kHz-26,5GHZ	ESR26	Rohde & Schwarz	101376	300005063	k	09.12.2020	08.12.2021
7	A, C	Highpass Filter	WHK1.1/15G-10SS	Wainwright	3	300003255	ev	-/-	-/-
8	A, C	Highpass Filter	WHKX7.0/18G-8SS	Wainwright	19	300003790	ne	-/-	-/-
9	A, C	Broadband Amplifier 0.5-18 GHz	CBLU5184540	CERNEX	22049	300004481	ev	-/-	-/-
10	A, B, C	4U RF Switch Platform	L4491A	Agilent Technologies	MY50000037	300004509	ne	-/-	-/-
11	A, B, C	NEXIO EMV-Software	BAT EMC V3.19.1.21	EMCO		300004682	ne	-/-	-/-
12	A, C	RF-Amplifier	AMF-6F06001800-30-10P-R	NARDA-MITEQ Inc	2011572	300005241	ev	-/-	-/-
13	C	Band Reject filter	WRCG2400/2483-2375/2505-50/10SS	Wainwright	11	300003351	ev	-/-	-/-

### 8.3 Radiated measurements > 18 GHz

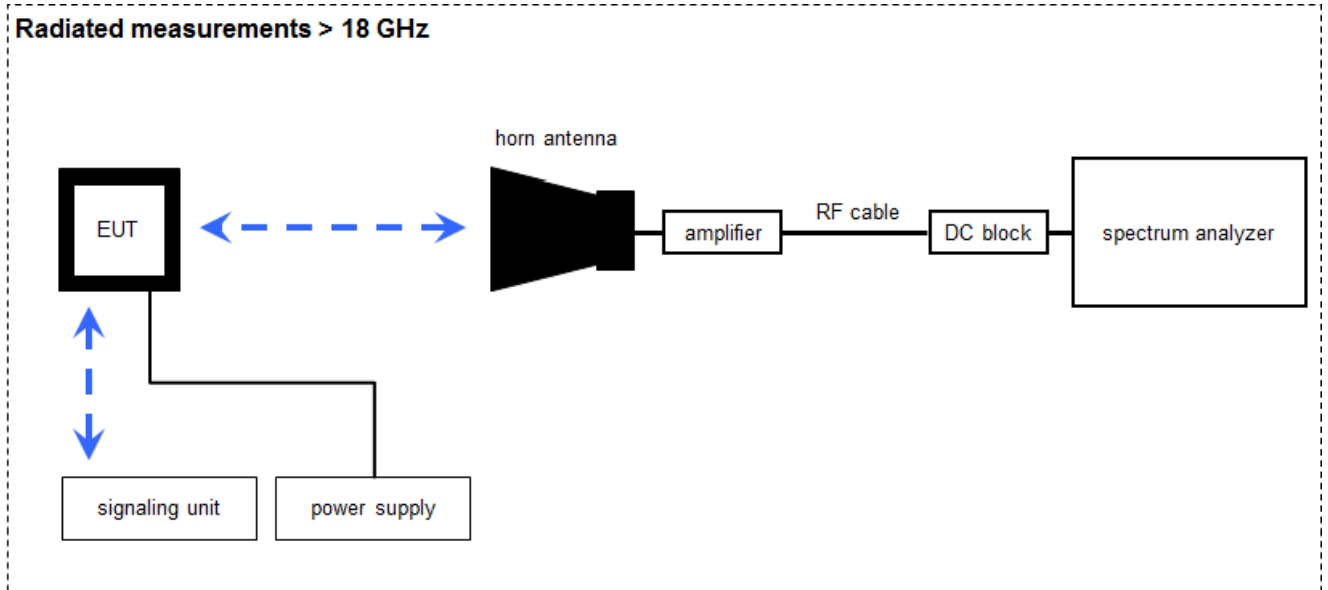

Measurement distance: horn antenna 50 cm

$$FS = UR + CA + AF$$

(FS-field strength; UR-voltage at the receiver; CA-loss signal path & distance correction; AF-antenna factor)

Example calculation:

$$FS [dB\mu V/m] = 40.0 [dB\mu V/m] + (-60.1) [dB] + 36.74 [dB/m] = 16.64 [dB\mu V/m] (6.79 \mu V/m)$$

#### Equipment table:

No.	Setup	Equipment	Type	Manufact.	Serial No.	INV. No Cetecom	Kind of Calibration	Last Calibration	Next Calibration
1	A	Microwave System Amplifier, 0.5-26.5 GHz	83017A	HP	00419	300002268	ev	-/-	-/-
2	A	Std. Gain Horn Antenna 18.0-26.5 GHz	638	Narda	01096	300000486	vIKI!	-/-	-/-
3	A	Signal Analyzer 40 GHz	FSV40	R&S	101042	300004517	k	07.12.2020	06.12.2021
4	A	RF-Cable	ST18/SMAM/SMAM /48	Huber & Suhner	Batch no. 600918	400001182	ev	-/-	-/-
5	A	RF-Cable	ST18/SMAM/SMAM /48	Huber & Suhner	Batch no. 127377	400001183	ev	-/-	-/-
6	A	DC-Blocker 0.1-40 GHz	8141A	Inmet	-/-	400001185	ev	-/-	-/-

## 8.4 Conducted measurements Bluetooth system

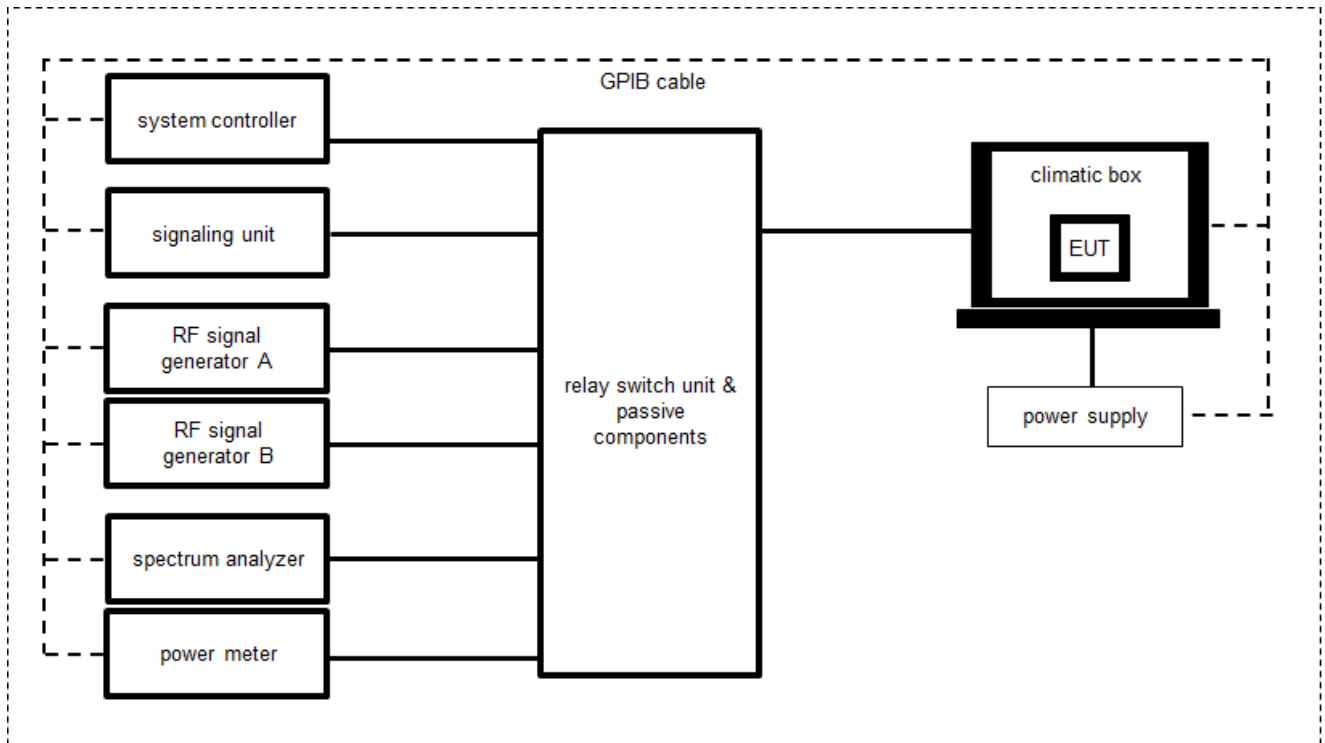

OP = AV + CA  
(OP-output power; AV-analyzer value; CA-loss signal path)

Example calculation:

OP [dBm] = 6.0 [dBm] + 11.7 [dB] = 17.7 [dBm] (58.88 mW)

**Equipment table:**

No.	Setup	Equipment	Type	Manufacturer	Serial No.	INV. No.	Kind of Calibration	Last Calibration	Next Calibration
1	A	Hygro-Thermometer	-/, 5-45C, 20-100rF	Thies Clima	-/-	400000080	ev	13.08.2020	12.08.2022
2	A	PC Laboratory 19"	Exone i3	Fröhlich + Walter	35230157A0370	300004646	ne	-/-	-/-
3	A	Signal analyzer	FSV30	Rohde&Schwarz	1321.3008K30/103809	300005359	vIKI!	08.12.2020	07.12.2022
4	A	USB-GPIB-Interface	82357B	Agilent Technologies	MY54323070	300004852	ne	-/-	-/-
6	A	Tester Software C.BER	Version 5.0	CTC advanced GmbH	0001	400001379	ne	-/-	-/-



## 8.5 AC conducted

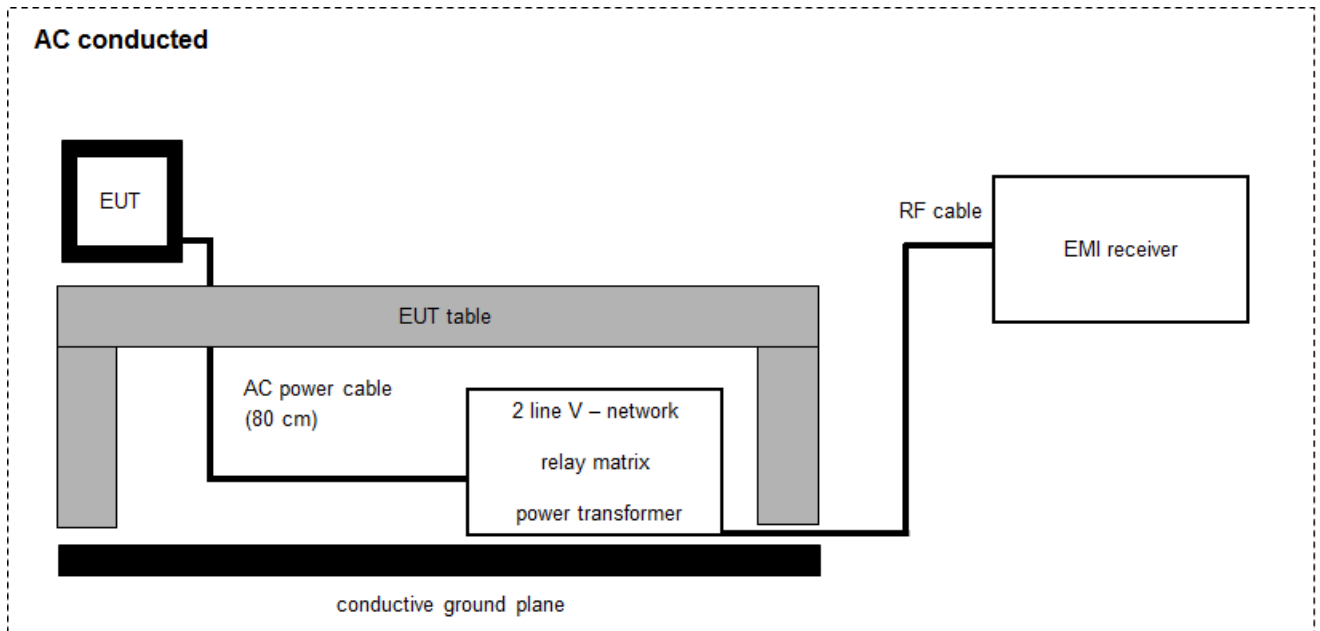

$$FS = UR + CF + VC$$

(FS-field strength; UR-voltage at the receiver; CR-loss of the cable and filter; VC-correction factor of the ISN)

Example calculation:

$$FS [dB\mu V/m] = 37.62 [dB\mu V/m] + 9.90 [dB] + 0.23 [dB] = 47.75 [dB\mu V/m] (244.06 \mu V/m)$$

**Equipment table:**

No.	Setup	Equipment	Type	Manufacturer	Serial No.	INV. No.	Kind of Calibration	Last Calibration	Next Calibration
1	A	Two-line V-Network (LISN) 9 kHz to 30 MHz	ESH3-Z5	Rohde & Schwarz	892475/017	300002209	vIKI!	11.12.2019	10.12.2021
2	A	RF-Filter-section	85420E	HP	3427A00162	300002214	NK!	-/-	-/-
3	A	EMI Test Receiver	ESCI 3	R&S	100083	300003312	k	09.12.2020	08.12.2021
4	A	Hochpass 150 kHz	EZ-25	R&S	100010	300003798	ev	-/-	-/-
5	A	PC	Tecline	F+W	-/-	300003532	ne	-/-	-/-

## 9 Measurement uncertainty

Measurement uncertainty	
Test case	Uncertainty
Antenna gain	± 3 dB
Carrier frequency separation	± 21.5 kHz
Number of hopping channels	-/-
Time of occupancy	According BT Core specification
Spectrum bandwidth	± 21.5 kHz absolute; ± 15.0 kHz relative
Maximum output power	± 1 dB
Detailed conducted spurious emissions @ the band edge	± 1 dB
Band edge compliance radiated	± 3 dB
Spurious emissions conducted	± 3 dB
Spurious emissions radiated below 30 MHz	± 3 dB
Spurious emissions radiated 30 MHz to 1 GHz	± 3 dB
Spurious emissions radiated 1 GHz to 12.75 GHz	± 3.7 dB
Spurious emissions radiated above 12.75 GHz	± 4.5 dB
Spurious emissions conducted below 30 MHz (AC conducted)	± 2.6 dB

## 10 Summary of measurement results

<input checked="" type="checkbox"/>	No deviations from the technical specifications were ascertained
<input type="checkbox"/>	There were deviations from the technical specifications ascertained
<input type="checkbox"/>	This test report is only a partial test report. The content and verdict of the performed test cases are listed below.

TC Identifier	Description			Verdict		Date				Remark
RF-Testing	CFR Part 15 RSS - 247, Issue 2			See table!		2021-10-28				-/-
Test specification clause	Test case	Temperature conditions	Power source voltages	Mode	C	NC	NA	NP	Remark	
§15.247(b)(4) RSS - 247 / 5.4.(f)(ii)	Antenna gain	Nominal	Nominal	GFSK	<input checked="" type="checkbox"/>	<input type="checkbox"/>	<input type="checkbox"/>	<input type="checkbox"/>	-/-	
§15.247(a)(1) RSS - 247 / 5.1.(b)	Carrier frequency separation	Nominal	Nominal	GFSK	<input checked="" type="checkbox"/>	<input type="checkbox"/>	<input type="checkbox"/>	<input type="checkbox"/>	-/-	
§15.247(a)(1) RSS - 247 / 5.1 (d)	Number of hopping channels	Nominal	Nominal	GFSK	<input checked="" type="checkbox"/>	<input type="checkbox"/>	<input type="checkbox"/>	<input type="checkbox"/>	-/-	
§15.247(a)(1) (iii) RSS - 247 / 5.1 (c)	Time of occupancy (dwell time)	Nominal	Nominal	GFSK Pi/4 DQPSK 8 DPSK	<input checked="" type="checkbox"/>	<input type="checkbox"/>	<input type="checkbox"/>	<input type="checkbox"/>	-/-	
§15.247(a)(1) RSS - 247 / 5.1 (a)	Spectrum bandwidth of a FHSS system bandwidth	Nominal	Nominal	GFSK Pi/4 DQPSK 8 DPSK	<input checked="" type="checkbox"/> <input checked="" type="checkbox"/> <input checked="" type="checkbox"/>	<input type="checkbox"/> <input type="checkbox"/> <input type="checkbox"/>	<input type="checkbox"/> <input type="checkbox"/> <input type="checkbox"/>	<input type="checkbox"/> <input type="checkbox"/> <input type="checkbox"/>	-/-	
§15.247(b)(1) RSS - 247 / 5.4 (b)	Maximum output power	Nominal	Nominal	GFSK Pi/4 DQPSK 8 DPSK	<input checked="" type="checkbox"/> <input checked="" type="checkbox"/> <input checked="" type="checkbox"/>	<input type="checkbox"/> <input type="checkbox"/> <input type="checkbox"/>	<input type="checkbox"/> <input type="checkbox"/> <input type="checkbox"/>	<input type="checkbox"/> <input type="checkbox"/> <input type="checkbox"/>	-/-	
§15.205 RSS - 247 / 5.5 RSS - Gen	Band edge compliance radiated	Nominal	Nominal	GFSK Pi/4 DQPSK 8 DPSK	<input checked="" type="checkbox"/> <input checked="" type="checkbox"/> <input checked="" type="checkbox"/>	<input type="checkbox"/> <input type="checkbox"/> <input type="checkbox"/>	<input type="checkbox"/> <input type="checkbox"/> <input type="checkbox"/>	<input type="checkbox"/> <input type="checkbox"/> <input type="checkbox"/>	-/-	
§15.247(d) RSS - 247 / 5.5	Spurious emissions conducted	Nominal	Nominal	GFSK Pi/4 DQPSK 8 DPSK	<input checked="" type="checkbox"/> <input checked="" type="checkbox"/> <input checked="" type="checkbox"/>	<input type="checkbox"/> <input type="checkbox"/> <input type="checkbox"/>	<input type="checkbox"/> <input type="checkbox"/> <input type="checkbox"/>	<input type="checkbox"/> <input type="checkbox"/> <input type="checkbox"/>	-/-	
§15.209(a) RSS - Gen	Spurious emissions radiated below 30 MHz	Nominal	Nominal	GFSK	<input checked="" type="checkbox"/>	<input type="checkbox"/>	<input type="checkbox"/>	<input type="checkbox"/>	-/-	
§15.247(d) RSS - 247 / 5.5 §15.109 RSS - Gen	Spurious emissions radiated 30 MHz to 1 GHz	Nominal	Nominal	GFSK	<input checked="" type="checkbox"/>	<input type="checkbox"/>	<input type="checkbox"/>	<input type="checkbox"/>	-/-	
§15.247(d) RSS - 247 / 5.5 §15.109 RSS - Gen	Spurious emissions radiated above 1 GHz	Nominal	Nominal	GFSK	<input checked="" type="checkbox"/>	<input type="checkbox"/>	<input type="checkbox"/>	<input type="checkbox"/>	-/-	
§15.107(a) §15.207	Conducted emissions below 30 MHz (AC conducted)	Nominal	Nominal	GFSK	<input checked="" type="checkbox"/>	<input type="checkbox"/>	<input type="checkbox"/>	<input type="checkbox"/>	-/-	

**Notes:**

<b>C</b>	Compliant	<b>NC</b>	Not compliant	<b>NA</b>	Not applicable	<b>NP</b>	Not performed
----------	-----------	-----------	---------------	-----------	----------------	-----------	---------------

**11 Additional comments**

*The Bluetooth® word mark and logos are owned by the Bluetooth SIG Inc. and any use of such marks by CTC advanced GmbH is under license.*

Reference documents: 1-1581\_20-01-09\_log1\_conducted.pdf  
Customer Questionnaire Speakerphone\_20210809(2).docx  
Foundation\_rf\_test\_certification\_note.pdf  
Test report 1-1581\_20-01-04

Special test descriptions: Power setting 2 was used for the tests.

Configuration descriptions: TX tests: were performed with x-DH5 packets and static PRBS pattern payload.  
RX/Standby tests: BT test mode enabled, scan enabled, TX Idle

Test mode:  Bluetooth Test mode loop back enabled (conducted)  
(EUT is controlled over CBT/CMU/CMW)  
  
 Special software is used. (radiated)  
EUT is transmitting pseudo random data by itself

Antennas and transmit operating modes:  Operating mode 1 (single antenna)  
- Equipment with 1 antenna,  
- Equipment with 2 diversity antennas operating in switched diversity mode by which at any moment in time only 1 antenna is used,  
- Smart antenna system with 2 or more transmit/receive chains, but operating in a mode where only 1 transmit/receive chain is used)

## 12 Measurement results

### 12.1 Antenna gain

**Limits:**

FCC	ISED
6 dBi / > 6 dBi output power and power density reduction required	

**Results:**

T <sub>nom</sub>	V <sub>nom</sub>	lowest channel 2402 MHz	middle channel 2441 MHz	highest channel 2480 MHz
Gain [dBi] Calculated		3.4	2.6	1.3

Extracted from test report 1-1581\_20-01-04.

## 12.2 Carrier frequency separation

**Description:**

Measurement of the carrier frequency separation of a hopping system. The carrier frequency separation is constant for all modulation-modes. We use GFSK-modulation to show compliance. EUT in hopping mode.

Measurement parameters	
External result file	1-1581_20-01-09_log1_conducted.pdf FCC Part 15.247 Carrier Frequency Separation FHSS
Test setup	See sub clause 8.4 A
Measurement uncertainty	See sub clause 9

**Limits:**

FCC	ISED
Carrier frequency separation	
Minimum 25 kHz or two-thirds of the 20 dB bandwidth of the hopping system whichever is greater.	

**Result:**

Carrier frequency separation	~ 1 MHz
------------------------------	---------

### 12.3 Number of hopping channels

**Description:**

Measurement of the total number of used hopping channels. The number of hopping channels is constant for all modulation-modes. We use GFSK-modulation to show compliance. EUT in hopping mode.

Measurement parameters	
External result file	1-1581_20-01-09_log1_conducted.pdf FCC Part 15.247 Number Of Hopping Channels FHSS
Test setup	See sub clause 8.4 A
Measurement uncertainty	See sub clause 9

**Limits:**

FCC	ISED
Number of hopping channels	
At least 15 non overlapping hopping channels	

**Result:**

Number of hopping channels	79
----------------------------	----

## 12.4 Time of occupancy (dwell time)

### Measurement:

For Bluetooth® devices no measurements mandatory depending on the fixed requirements according to the Bluetooth® Core Specifications!

### For Bluetooth® devices:

The channel staying time of 0.4 s within a 31.6 second period in data mode is constant for Bluetooth® devices and independent from the packet type (packet length). The calculation for a 31.6 second period is as follows:

Channel staying time = time slot length \* hop rate / number of hopping channels \* 31.6 s

Example for a DH1 packet (with a maximum length of one time slot)

Channel staying time =  $625 \mu\text{s} * 1600 * 1/\text{s} / 79 * 31.6 \text{ s} = 0.4 \text{ s}$  (in a 31.6 s period)

For multi-slot packets the hopping is reduced according to the length of the packet.

Example for a DH3 packet (with a maximum length of three time slots)

Channel staying time =  $3 * 625 \mu\text{s} * 1600/3 * 1/\text{s} / 79 * 31.6 \text{ s} = 0.4 \text{ s}$  (in a 31.6 s period)

Example for a DH5 packet (with a maximum length of five time slots)

Channel staying time =  $5 * 625 \mu\text{s} * 1600/5 * 1/\text{s} / 79 * 31.6 \text{ s} = 0.4 \text{ s}$  (in a 31.6 s period)

This is according to the Bluetooth® Core Specification 5.0 (and lower) for all Bluetooth® devices and all modulations.

### The following table shows the relations:

Packet Size	Pulse Width [ms] *	Max. number of transmissions per channel in 31.6 sec
DH1	0.366	640
DH3	1.622	214
DH5	2.870	128

\* according Bluetooth® specification

### Results:

Packet Size	Pulse Width [ms]*	Max. number of transmissions in 31.6 sec	Time of occupancy (dwell time) [Pulse width * Number of transmissions]
DH1	0.366	640	234.2 ms
DH3	1.622	214	347.1 ms
DH5	2.870	128	367.4 ms



**Limits:**

FCC	ISED
Time of occupancy (dwell time)	
The frequency hopping operation shall have an average time of occupancy on any frequency not exceeding 0.4 seconds within a duration in seconds equal to the number of hopping frequencies multiplied by 0.4.	

## 12.5 Spectrum bandwidth of a FHSS system

**Description:**

Measurement of the 20dB bandwidth and 99% bandwidth of the modulated signal. EUT in single channel mode.

Measurement parameters	
External result file	1-1581_20-01-09_log1_conducted.pdf FCC Part 15.247 Bandwidth 99PCT
Test setup	See sub clause 8.4 A
Measurement uncertainty	See sub clause 9

**Limits:**

FCC	ISED
Spectrum bandwidth within the band.	

**Results:**

Modulation	20 dB bandwidth [kHz]		
	2402 MHz	2441 MHz	2480 MHz
GFSK	882	881	882
Pi/4 DQPSK	1273	1274	1273
8DPSK	1240	1239	1238

**Results:**

Modulation	99 % bandwidth [kHz]		
	2402 MHz	2441 MHz	2480 MHz
GFSK	857	857	856
Pi/4 DQPSK	1174	1174	1174
8DPSK	1166	1163	1166

## 12.6 Maximum output power

### Description:

Measurement of the maximum output power conducted and radiated. EUT in single channel mode. The measurement is performed according to the ANSI C63.10.

Measurement parameters	
External result file	1-1581_20-01-09_log1_conducted.pdf FCC Part 15.247 Maximum Peak Conducted Output Power FHSS
Test setup	See sub clause 8.4 A
Measurement uncertainty	See sub clause 9

### Limits:

FCC	ISED
Maximum output power	
[Conducted: 0.125 W – antenna gain max. 6 dBi] Systems using more than 75 hopping channels: Conducted: 1.0 W – antenna gain max. 6 dBi	

### Results:

Modulation	Maximum output power conducted [dBm]		
	2402 MHz	2441 MHz	2480 MHz
Frequency			
GFSK	-0.9	-1.1	-1.2
Pi/4 DQPSK	-1.0	-1.2	-1.3
8 DPSK	-1.0	-1.1	-1.2

## 12.7 Band edge compliance radiated

### Description:

Measurement of the radiated band edge compliance. The EUT is turned in the position that results in the maximum level at the band edge. Then a sweep over the corresponding restricted band is performed. The EUT is set to single channel mode and the transmit channel is channel 00 for the lower restricted band and channel 78 for the upper restricted band. The measurement is repeated for all modulations. Measurement distance is 3m.

Measurement parameters	
Detector	Peak / RMS
Sweep time	Auto
Resolution bandwidth	1 MHz
Video bandwidth	3 MHz
Span	Lower Band: 2370 – 2400 MHz Upper Band: 2480 – 2500 MHz
Trace mode	Max hold
Test setup	See sub clause 8.2 A
Measurement uncertainty	See sub clause 9

### Limits:

FCC	ISED
Band edge compliance radiated	
In any 100 kHz bandwidth outside the frequency band in which the spread spectrum or digitally modulated intentional radiator is operating, the radio frequency power that is produced by the intentional radiator shall be at least 20 dB below that in the 100 kHz bandwidth within the band that contains the highest level of the desired power, based on either an RF conducted or a radiated measurement. Attenuation below the general limits specified in Section 15.209(a) is not required. In addition, radiated emissions which fall in the restricted bands, as defined in Section 15.205(a), must also comply with the radiated emission limits specified in Section 15.209(a) (see Section 5.205(c)).	
54 dB $\mu$ V/m AVG 74 dB $\mu$ V/m Peak	

### Results:

Scenario	Band edge compliance radiated [dB $\mu$ V/m]		
	GFSK	Pi/4 DQPSK	8DPSK
Lower restricted band	36.0 dB $\mu$ V/m AVG 47.5 dB $\mu$ V/m Peak	35.5 dB $\mu$ V/m AVG 47.6 dB $\mu$ V/m Peak	35.6 dB $\mu$ V/m AVG 47.5 dB $\mu$ V/m Peak
Upper restricted band	47.6 dB $\mu$ V/m AVG 52.4 dB $\mu$ V/m Peak	46.2 dB $\mu$ V/m AVG 52.6 dB $\mu$ V/m Peak	46.4 dB $\mu$ V/m AVG 52.5 dB $\mu$ V/m Peak

**Plots:**

**Plot 1:** Lower band edge, GFSK modulation, vertical & horizontal polarization

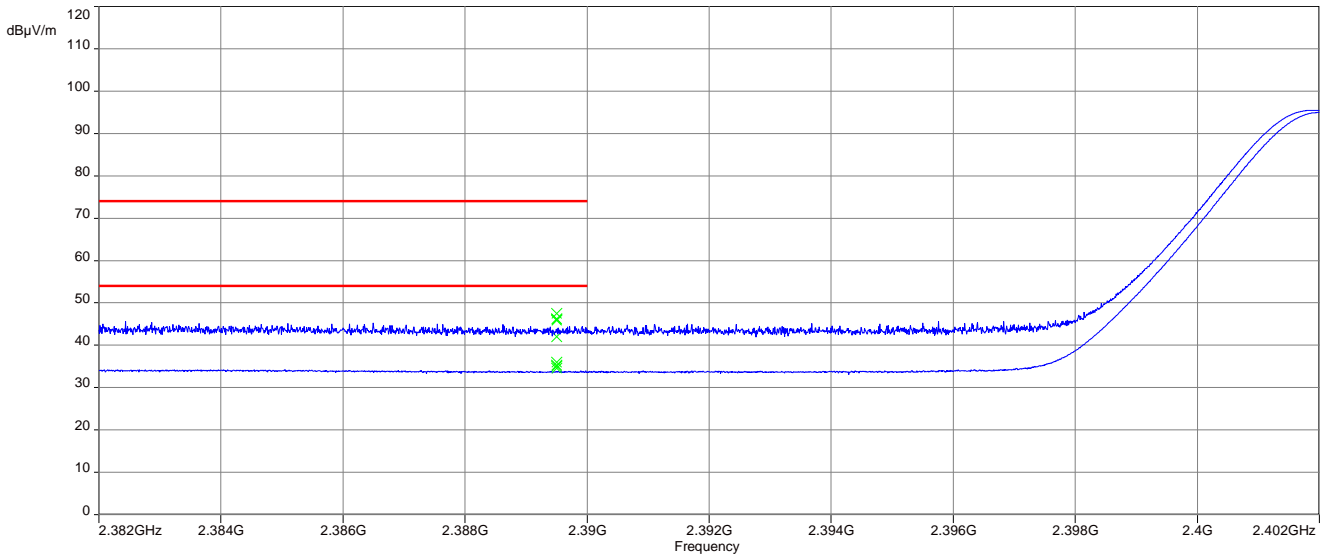

**Plot 2:** Upper band edge, GFSK modulation, vertical & horizontal polarization

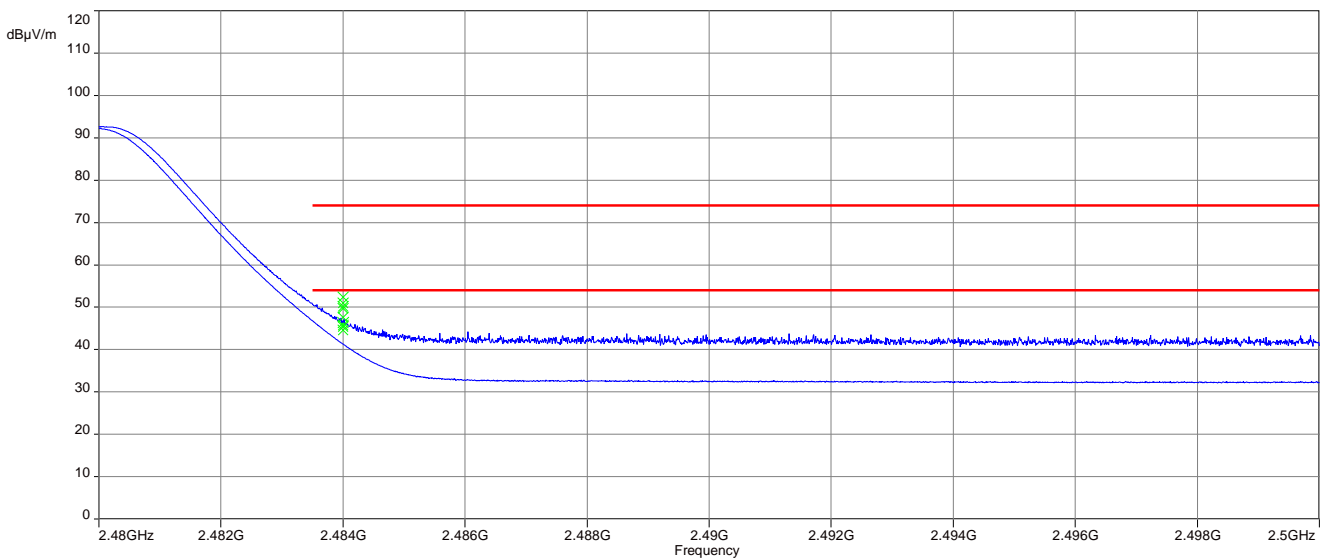

**Plot 3:** Lower band edge, Pi/4 DQPSK modulation, vertical & horizontal polarization

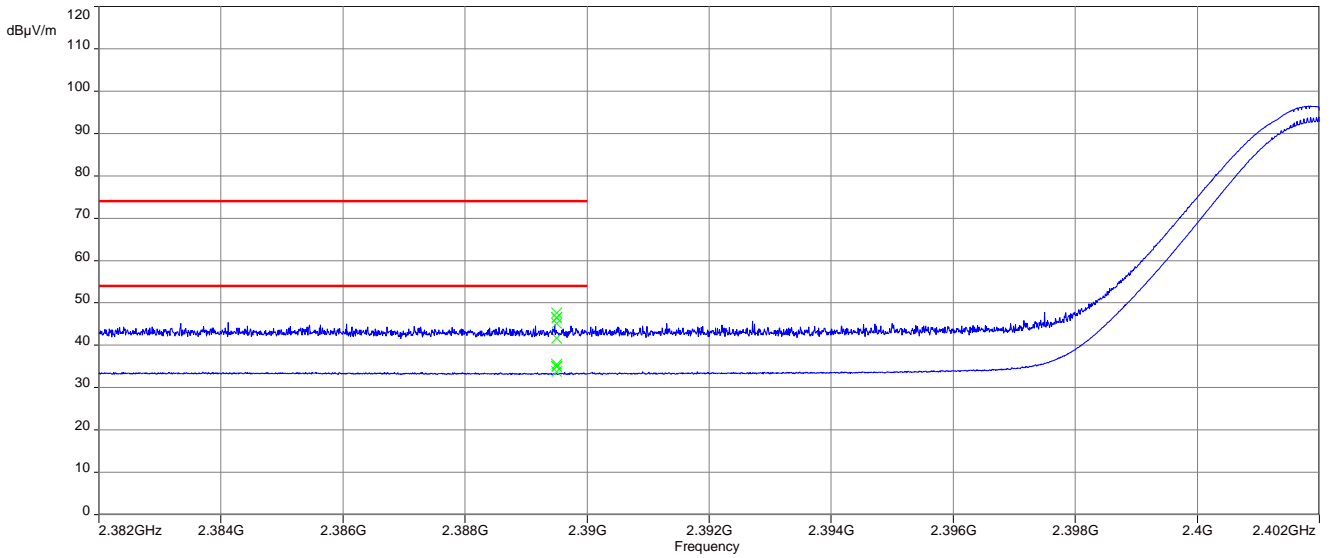

**Plot 4:** Upper band edge, Pi/4 DQPSK modulation, vertical & horizontal polarization

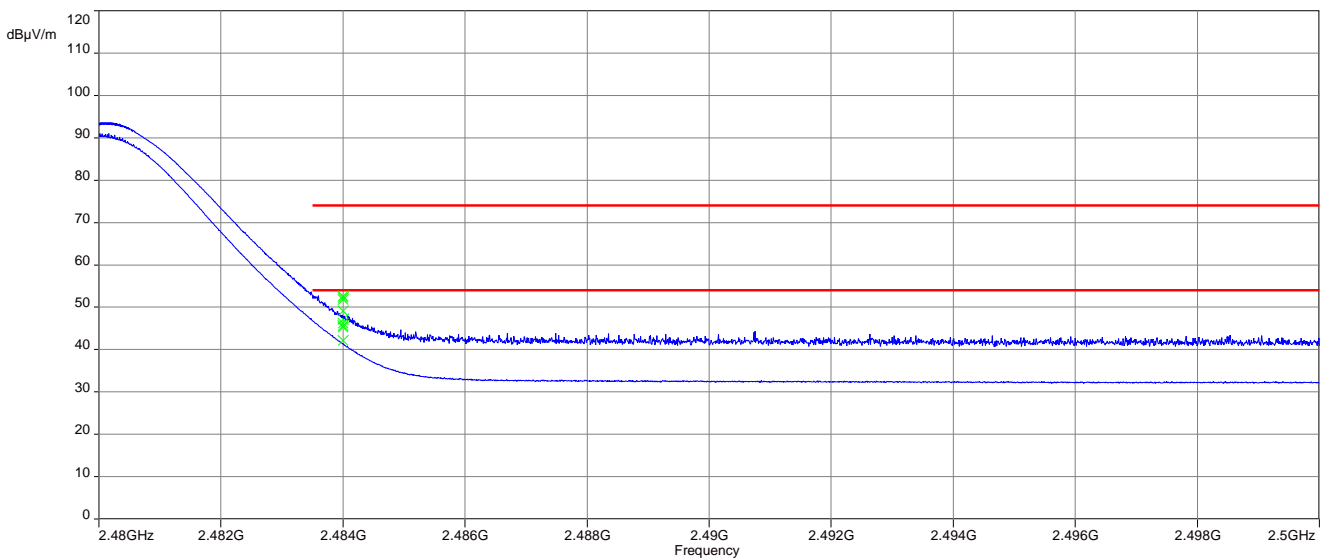

**Plot 5:** Lower band edge, 8DPSK modulation, vertical & horizontal polarization

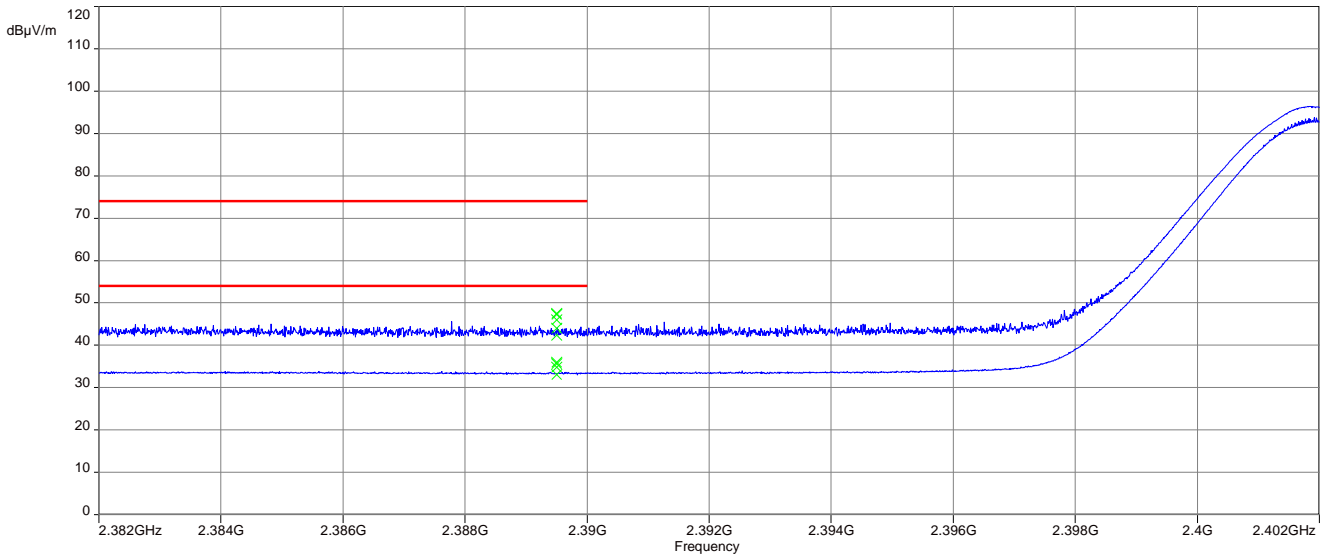

**Plot 6:** Upper band edge, 8DPSK modulation, vertical & horizontal polarization

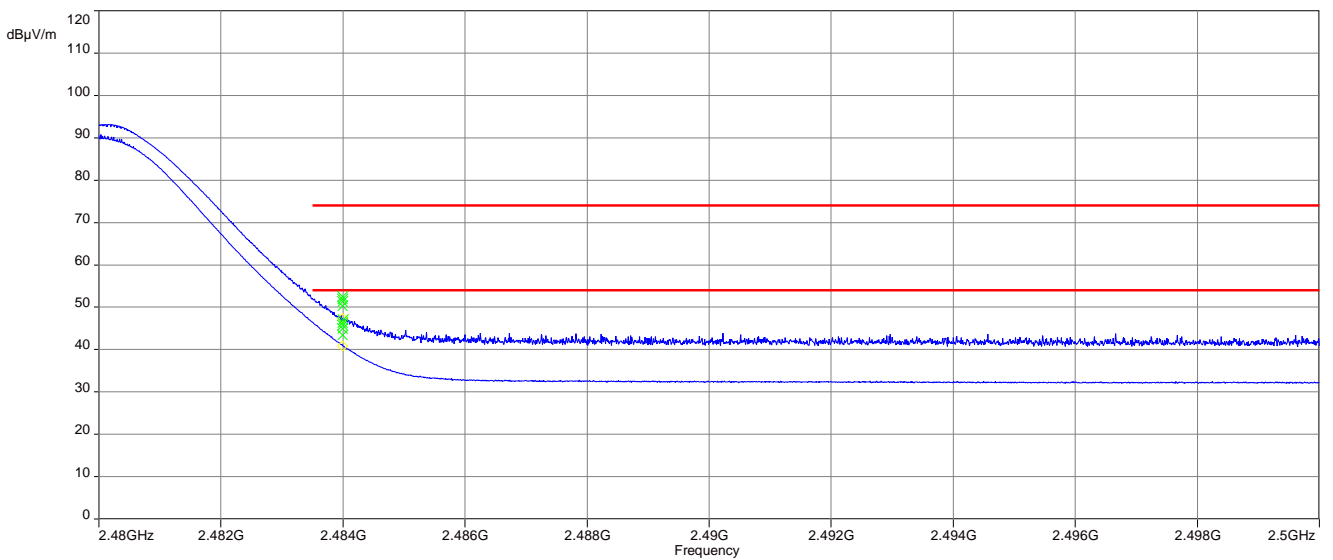



## 12.8 Spurious emissions conducted

### Description:

Measurement of the conducted spurious emissions in transmit mode. The EUT is set to single channel mode and the transmit channel is channel 00, channel 39 and channel 78. The measurement is repeated for all modulations.

Measurement parameters	
External result file	1-1581_20-01-09_log1_conducted.pdf FCC Part 15.247 TX Spurious Conducted
Test setup	See sub clause 8.4 A
Measurement uncertainty	See sub clause 9

### Limits:

FCC	ISED
TX spurious emissions conducted	
<p>In any 100 kHz bandwidth outside the frequency band in which the spread spectrum or digitally modulated intentional radiator is operating, the radio frequency power that is produced by the intentional radiator shall be at least 20 dB below that in the 100 kHz bandwidth within the band that contains the highest level of the desired power, based on either an RF conducted or a radiated measurement. Attenuation below the general limits specified in Section 15.209(a) is not required</p>	

**Results:**

TX spurious emissions conducted					
GFSK - mode					
f [MHz]		amplitude of emission [dBm]	limit max. allowed emission power	actual attenuation below frequency of operation [dB]	results
2402		-2.1	30 dBm		Operating frequency
All detected emissions are below the -20 dBc criteria. Please take a look at the plot!			-20 dBc		compliant
2441		-2.0	30 dBm		Operating frequency
All detected emissions are below the -20 dBc criteria. Please take a look at the plot!			-20 dBc		compliant
2480		-1.8	30 dBm		Operating frequency
All detected emissions are below the -20 dBc criteria. Please take a look at the plot!			-20 dBc		compliant

**Results:**

TX spurious emissions conducted					
Pi/4-DQPSK - mode					
f [MHz]		amplitude of emission [dBm]	limit max. allowed emission power	actual attenuation below frequency of operation [dB]	results
2402		-1.7	30 dBm		Operating frequency
All detected emissions are below the -20 dBc criteria. Please take a look at the plot!			-20 dBc		compliant
2441		-6.2	30 dBm		Operating frequency
All detected emissions are below the -20 dBc criteria. Please take a look at the plot!			-20 dBc		compliant
2480		-6.1	30 dBm		Operating frequency
All detected emissions are below the -20 dBc criteria. Please take a look at the plot!			-20 dBc		compliant

**Results:**

TX spurious emissions conducted					
8DPSK - mode					
f [MHz]		amplitude of emission [dBm]	limit max. allowed emission power	actual attenuation below frequency of operation [dB]	results
2402		-5.3	30 dBm		Operating frequency
All detected emissions are below the -20 dBc criteria. Please take a look at the plot!			-20 dBc		compliant
2441		-5.1	30 dBm		Operating frequency
All detected emissions are below the -20 dBc criteria. Please take a look at the plot!			-20 dBc		compliant
2480		-1.8	30 dBm		Operating frequency
All detected emissions are below the -20 dBc criteria. Please take a look at the plot!			-20 dBc		compliant

## 12.9 Spurious emissions radiated below 30 MHz

### Description:

Measurement of the radiated spurious emissions in transmit mode below 30 MHz. The EUT is set to single channel mode and the transmit channels are 00; 39 and 78. The measurement is performed in the mode with the highest output power. The limits are recalculated to a measurement distance of 3 m according the ANSI C63.10.

Measurement parameters	
Detector	Peak / Quasi peak
Sweep time	Auto
Resolution bandwidth	F < 150 kHz: 200 Hz F > 150 kHz: 9 kHz
Video bandwidth	F < 150 kHz: 1 kHz F > 150 kHz: 100 kHz
Span	9 kHz to 30 MHz
Trace mode	Max hold
Test setup	See sub clause 8.2 B
Measurement uncertainty	See sub clause 9

### Limits:

FCC		ISED	
TX spurious emissions radiated below 30 MHz			
Frequency (MHz)	Field strength (dB $\mu$ V/m)	Measurement distance	
0.009 – 0.490	2400/F(kHz)	300	
0.490 – 1.705	24000/F(kHz)	30	
1.705 – 30.0	30	30	

### Results:

TX spurious emissions radiated below 30 MHz [dB $\mu$ V/m]		
F [MHz]	Detector	Level [dB $\mu$ V/m]
All detected emissions are more than 20 dB below the limit.		

**Plots:**

**Plot 1:** 9 kHz to 30 MHz, channel 00, transmit mode

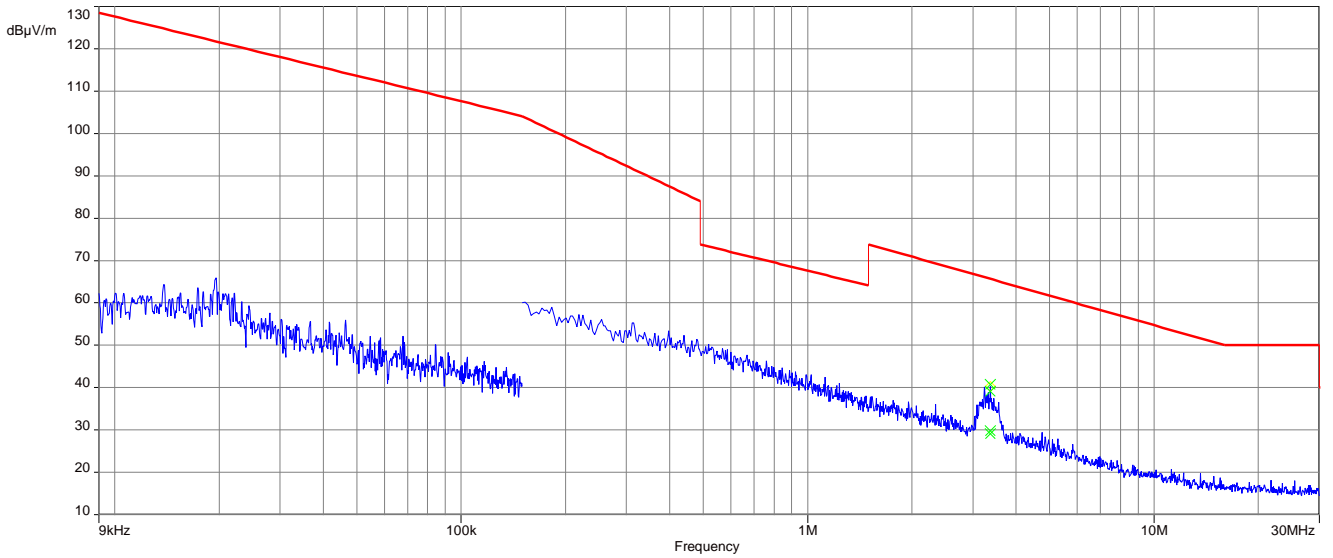

**Plot 2:** 9 kHz to 30 MHz, channel 39, transmit mode

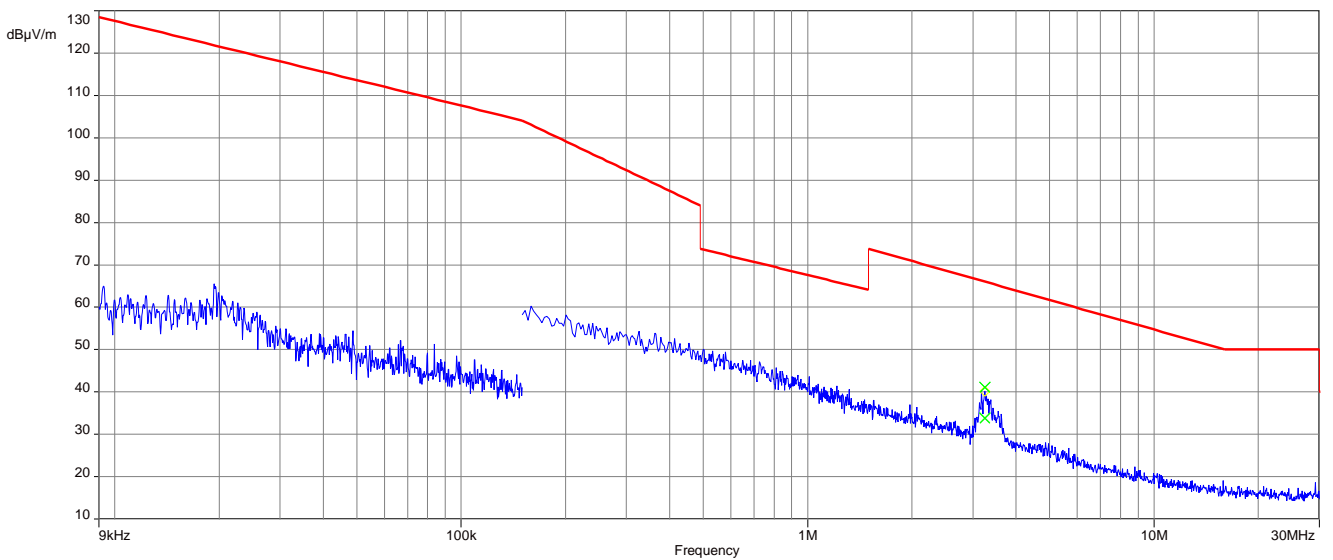

**Plot 3:** 9 kHz to 30 MHz, channel 78, transmit mode

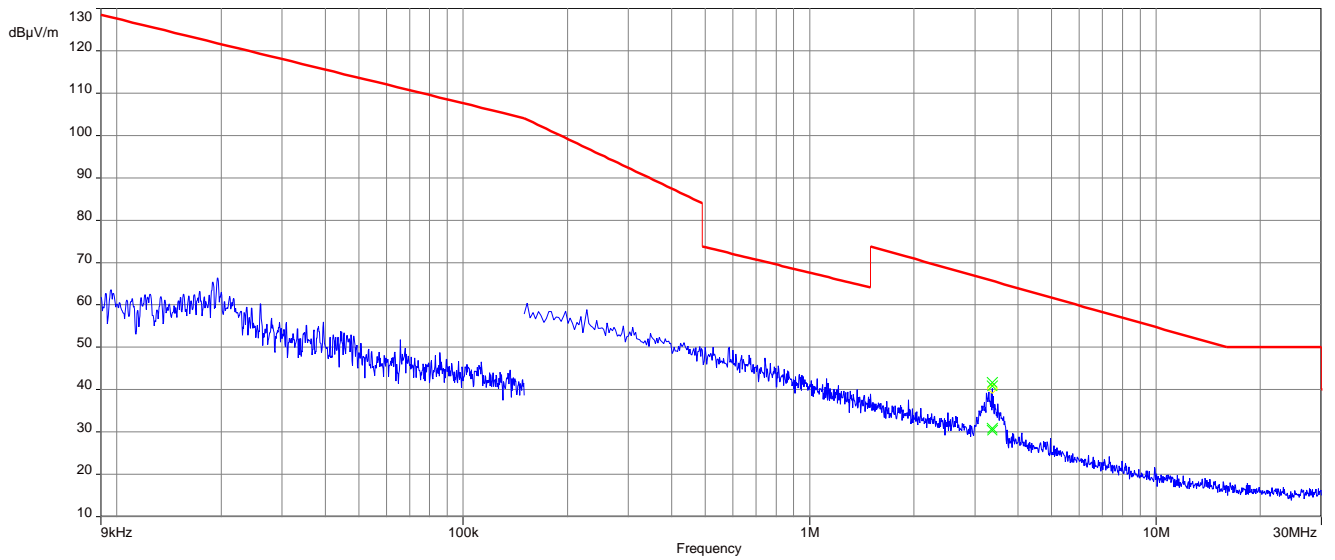

## 12.10 Spurious emissions radiated 30 MHz to 1 GHz

### Description:

Measurement of the radiated spurious emissions in transmit mode. The EUT is set to single channel mode and the transmit channel is channel 00, channel 39 and channel 78. The measurement is performed in the mode with the highest output power.

Measurement parameters	
Detector	Peak / Quasi Peak
Sweep time	Auto
Resolution bandwidth	120 kHz
Video bandwidth	3 x RBW
Span	30 MHz to 1 GHz
Trace mode	Max hold
Measured modulation	<input type="checkbox"/> GFSK <input type="checkbox"/> Pi/4 DQPSK <input checked="" type="checkbox"/> 8DPSK
Test setup	See sub clause 8.1 A
Measurement uncertainty	See sub clause 9

The modulation with the highest output power was used to perform the transmitter spurious emissions. If spurious were detected a re-measurement was performed on the detected frequency with each modulation.

### Limits:

FCC		ISED	
TX spurious emissions radiated			
In any 100 kHz bandwidth outside the frequency band in which the spread spectrum or digitally modulated intentional radiator is operating, the radio frequency power that is produced by the intentional radiator shall be at least 20 dB below that in the 100 kHz bandwidth within the band that contains the highest level of the desired power, based on either an RF conducted or a radiated measurement. Attenuation below the general limits specified in Section 15.209(a) is not required. In addition, radiated emissions which fall in the restricted bands, as defined in §15.205(a), must also comply with the radiated emission limits specified in §15.209(a) (see §15.205(c)).			
§15.209			
Frequency (MHz)	Field strength (dB $\mu$ V/m)	Measurement distance	
30 - 88	30.0	10	
88 - 216	33.5	10	
216 - 960	36.0	10	
Above 960	54.0	3	

**Plots:** Transmit mode

**Plot 1:** 30 MHz to 1 GHz, TX mode, channel 00, vertical & horizontal polarization

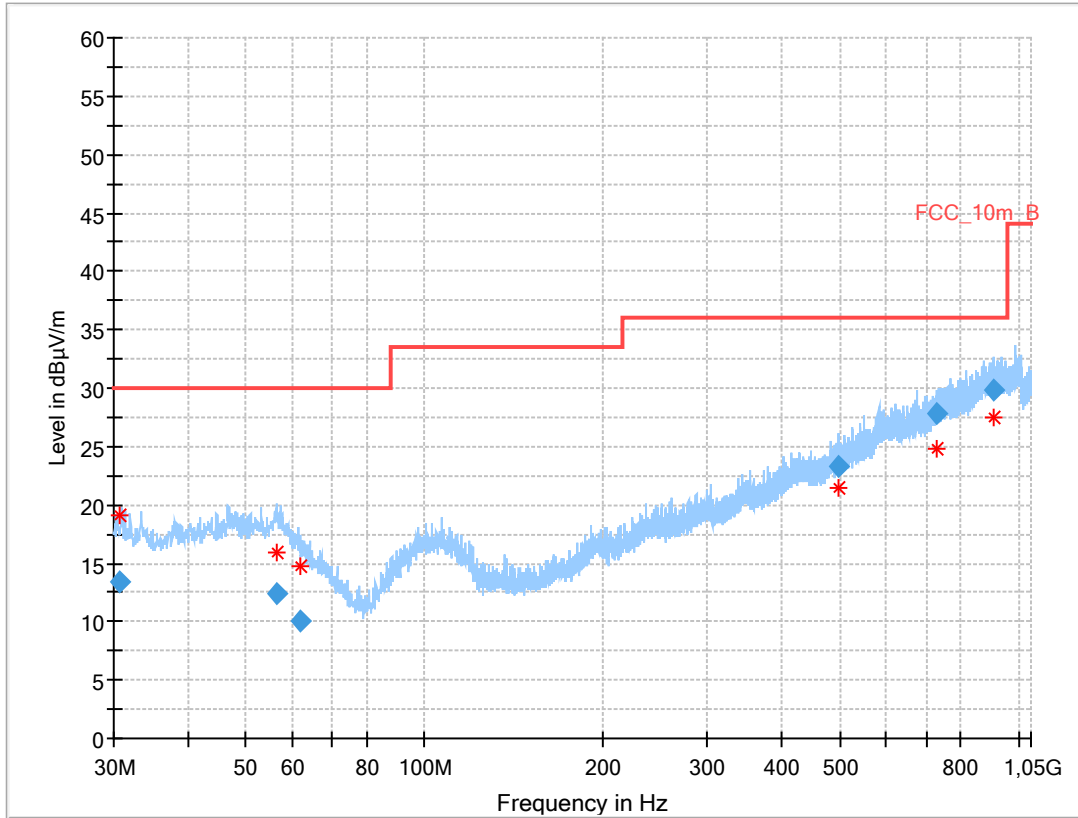

**Final results:**

Frequency (MHz)	QuasiPeak (dBµV/m)	Limit (dBµV/m)	Margin (dB)	Meas. Time (ms)	Bandwidth (kHz)	Height (cm)	Pol	Azimuth (deg)	Corr. (dB)
30.625	13.45	30.0	16.6	1000	120.0	102.0	V	157	13
56.257	12.40	30.0	17.6	1000	120.0	170.0	V	157	16
61.663	9.98	30.0	20.0	1000	120.0	170.0	V	247	13
499.811	23.37	36.0	12.6	1000	120.0	170.0	H	-20	20
729.192	27.82	36.0	8.2	1000	120.0	127.0	V	-22	23
909.342	29.77	36.0	6.2	1000	120.0	170.0	V	159	26



**Plot 2:** 30 MHz to 1 GHz, TX mode, channel 39, vertical & horizontal polarization

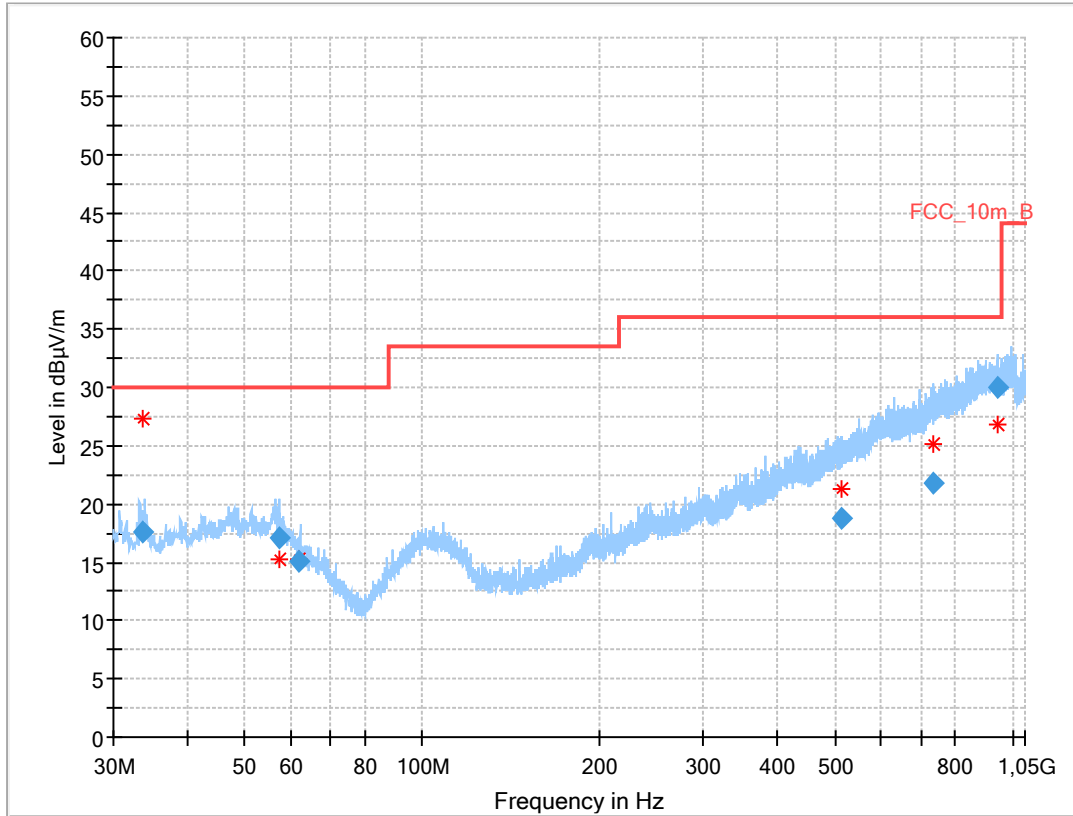

**Final results:**

Frequency (MHz)	QuasiPeak (dBµV/m)	Limit (dBµV/m)	Margin (dB)	Meas. Time (ms)	Bandwidth (kHz)	Height (cm)	Pol	Azimuth (deg)	Corr. (dB)
33.633	17.62	30.0	12.4	1000	120.0	170.0	V	101	13
57.177	17.05	30.0	13.0	1000	120.0	170.0	H	75	16
62.005	15.03	30.0	15.0	1000	120.0	170.0	V	67	13
513.927	18.70	36.0	17.3	1000	120.0	170.0	H	-8	20
734.460	21.79	36.0	14.2	1000	120.0	170.0	V	-22	23
944.912	30.00	36.0	6.0	1000	120.0	170.0	H	15	25

**Plot 3:** 30 MHz to 1 GHz, TX mode, channel 78, vertical & horizontal polarization

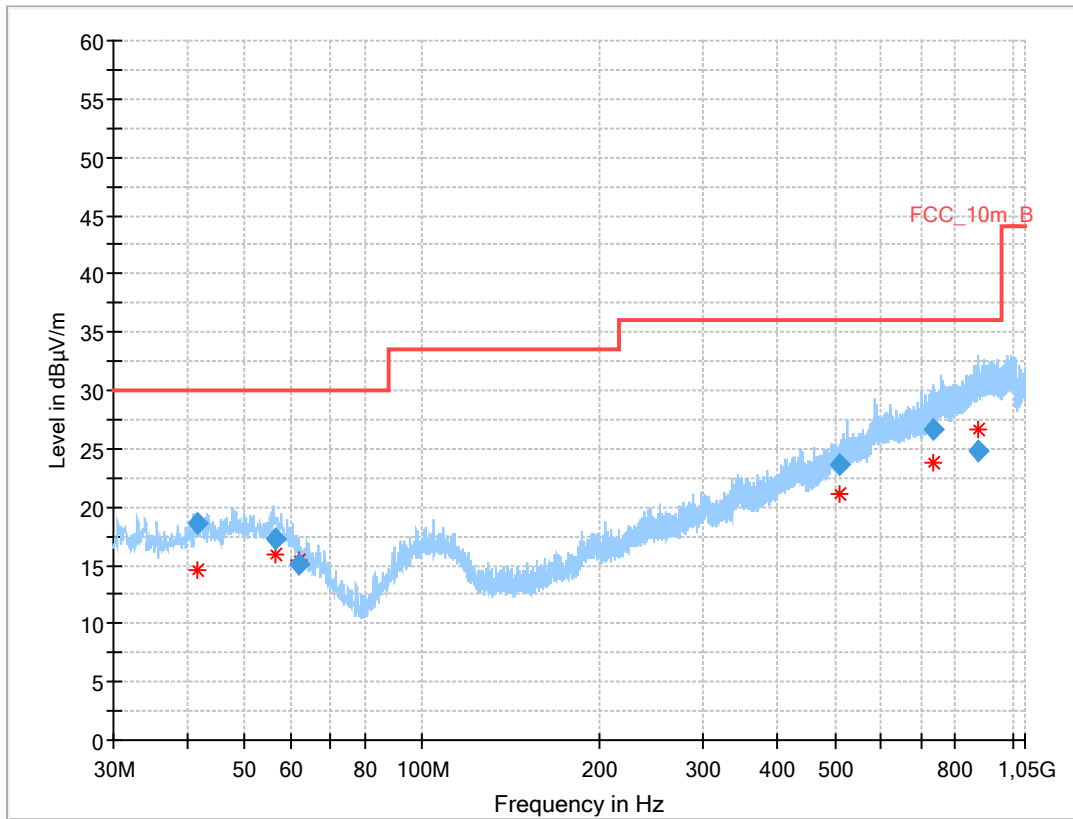

**Final results:**

Frequency (MHz)	QuasiPeak (dBµV/m)	Limit (dBµV/m)	Margin (dB)	Meas. Time (ms)	Bandwidth (kHz)	Height (cm)	Pol	Azimuth (deg)	Corr. (dB)
41.621	18.65	30.0	11.4	1000	120.0	170.0	V	22	15
56.551	17.27	30.0	12.7	1000	120.0	142.0	V	67	16
61.966	15.04	30.0	15.0	1000	120.0	170.0	V	157	13
511.371	23.64	36.0	12.4	1000	120.0	170.0	V	-22	20
732.251	26.57	36.0	9.4	1000	120.0	170.0	V	247	23
876.667	24.73	36.0	11.3	1000	120.0	170.0	V	247	25

## 12.11 Spurious emissions radiated above 1 GHz

### Description:

Measurement of the radiated spurious emissions in transmit mode. The EUT is set to single channel mode and the transmit channel is channel 00, channel 39 and channel 78. The measurement is performed in the mode with the highest output power.

Measurement parameters	
Detector	Peak / RMS
Sweep time	Auto
Resolution bandwidth	1 MHz
Video bandwidth	3 x RBW
Span	1 GHz to 26 GHz
Trace mode	Max hold
Measured modulation	<input type="checkbox"/> GFSK <input type="checkbox"/> Pi/4 DQPSK <input checked="" type="checkbox"/> 8DPSK
Test setup	See sub clause 8.2 C (1 GHz - 18 GHz) See sub clause 8.3 A (18 GHz - 26 GHz)
Measurement uncertainty	See sub clause 9

The modulation with the highest output power was used to perform the transmitter spurious emissions. If spurious were detected a re-measurement was performed on the detected frequency with each modulation.

### Limits:

FCC		ISED	
TX spurious emissions radiated			
In any 100 kHz bandwidth outside the frequency band in which the spread spectrum or digitally modulated intentional radiator is operating, the radio frequency power that is produced by the intentional radiator shall be at least 20 dB below that in the 100 kHz bandwidth within the band that contains the highest level of the desired power, based on either an RF conducted or a radiated measurement. Attenuation below the general limits specified in Section 15.209(a) is not required. In addition, radiated emissions which fall in the restricted bands, as defined in §15.205(a), must also comply with the radiated emission limits specified in §15.209(a) (see §15.205(c)).			
§15.209			
Frequency (MHz)	Field strength (dBµV/m)	Measurement distance	
Above 960	54.0	3	

**Results:** Transmitter mode

TX spurious emissions radiated [dBµV/m]								
2402 MHz			2441 MHz			2480 MHz		
F [MHz]	Detector	Level [dBµV/m]	F [MHz]	Detector	Level [dBµV/m]	F [MHz]	Detector	Level [dBµV/m]
4804	Peak	56.6	4882	Peak	58.1	4960	Peak	59.7
	AVG	26.5*		AVG	28.0*		AVG	29.6*
-/-	Peak	-/-	7322	Peak	61.7	7440	Peak	60.7
	AVG	-/-		AVG	31.6*		AVG	30.6*
-/-	Peak	-/-	-/-	Peak	-/-	-/-	Peak	-/-
	AVG	-/-		AVG	-/-		AVG	-/-

\*) Average emission adjusting factor:

$$F = 20 * \log (\text{dwell time} / 100 \text{ ms})$$

The dwell time of the longest possible Bluetooth transmission (DH5-packet) is 3.125 ms.

In a period of 100 ms, we have a maximum of 1 transmission and that implies a correction factor for spurious measurement emissions:

$$F = 20 * \log (1 * 3.125 / 100) = -30.1 \text{ dB}$$

**Plots:** Transmitter mode

**Plot 1:** 1 GHz to 18 GHz, TX mode, channel 00, vertical & horizontal polarization

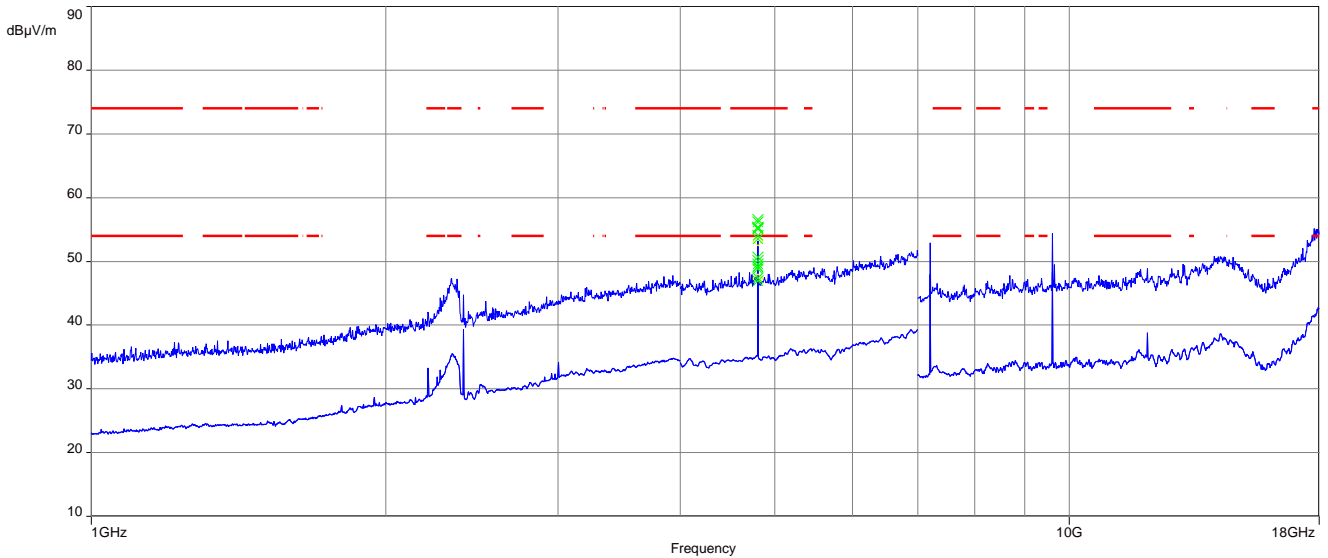

The carrier signal is notched with a 2.4 GHz band rejection filter.

**Plot 2:** 18 GHz to 26 GHz, TX mode, channel 00, vertical & horizontal polarization

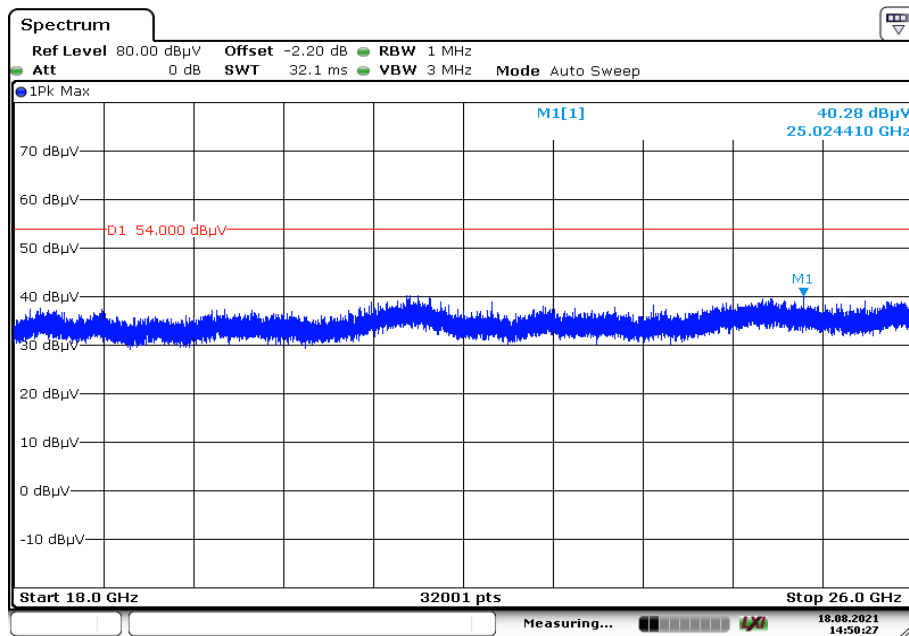

Date: 18 AUG 2021 14:50:27

**Plot 3:** 1 GHz to 18 GHz, TX mode, channel 39, vertical & horizontal polarization

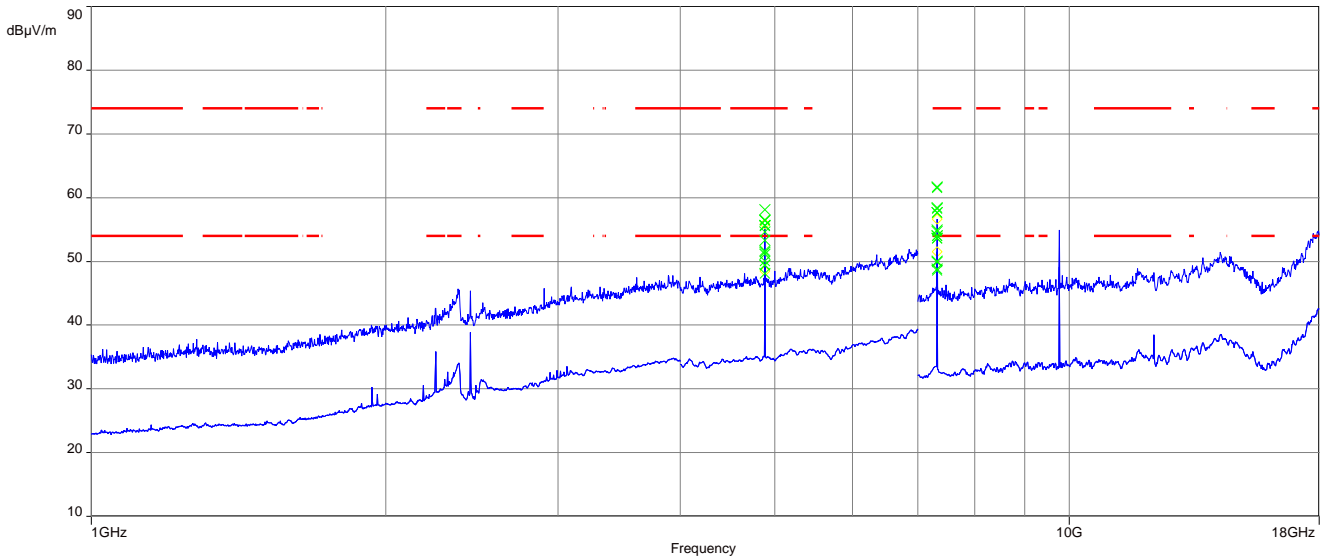

The carrier signal is notched with a 2.4 GHz band rejection filter.

**Plot 4:** 18 GHz to 26 GHz, TX mode, channel 39, vertical & horizontal polarization

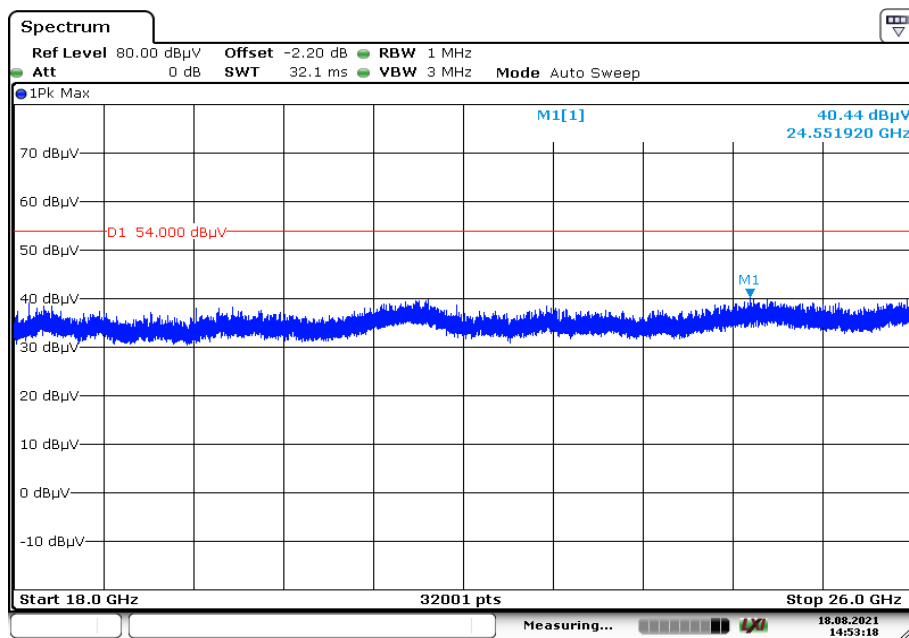

Date: 18 AUG 2021 14:53:19

**Plot 5:** 1 GHz to 18 GHz, TX mode, channel 78, vertical & horizontal polarization

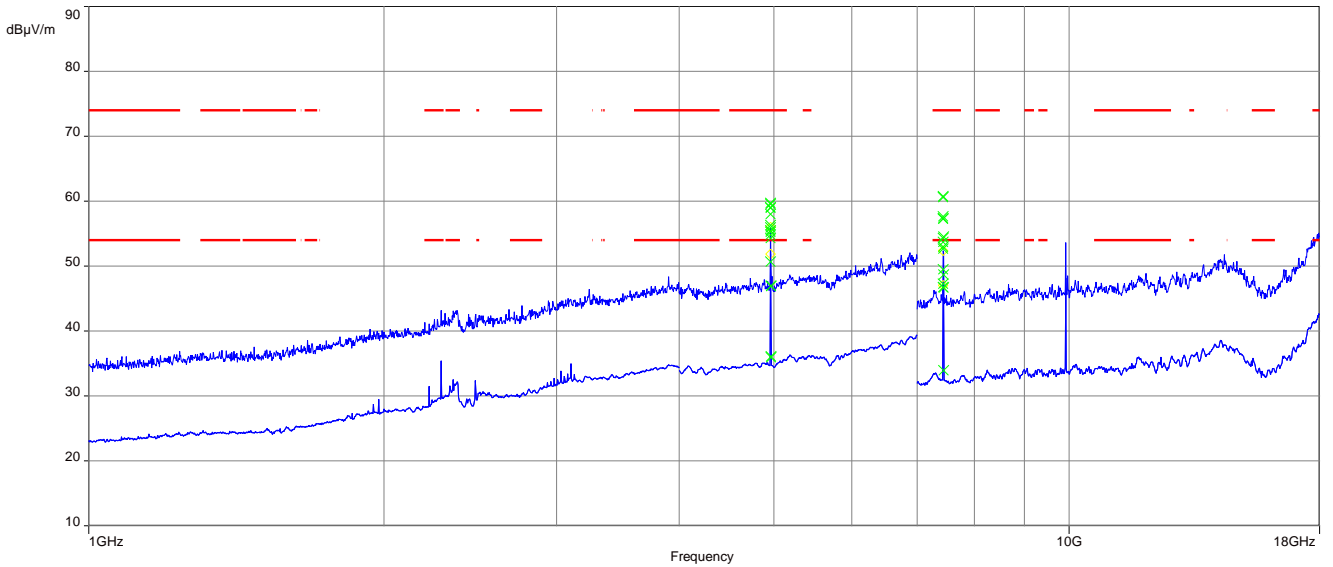

The carrier signal is notched with a 2.4 GHz band rejection filter.

**Plot 6:** 18 GHz to 26 GHz, TX mode, channel 78, vertical & horizontal polarization

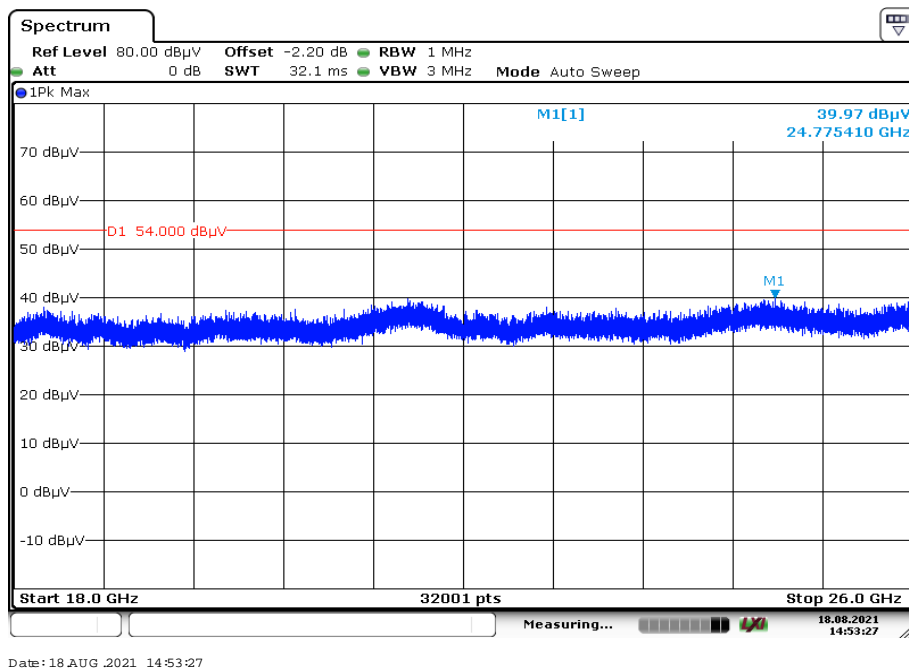

## 12.12 Spurious emissions conducted below 30 MHz (AC conducted)

### Description:

Measurement of the conducted spurious emissions in transmit mode below 30 MHz. The EUT is set to single channel mode and the transmit channel is channel 39. This measurement is representative for all channels and modes. If critical peaks are found channel 00 and channel 78 will be measured too. The measurement is performed in the mode with the highest output power. Both power lines, phase and neutral line, are measured. Found peaks are remeasured with average and quasi peak detection to show compliance to the limits.

Measurement parameters	
Detector	Peak - Quasi peak / average
Sweep time	Auto
Resolution bandwidth	F < 150 kHz: 200 Hz F > 150 kHz: 9 kHz
Video bandwidth	F < 150 kHz: 1 kHz F > 150 kHz: 100 kHz
Span	9 kHz to 30 MHz
Trace mode	Max hold
Test setup	See sub clause 8.5. A
Measurement uncertainty	See sub clause 9

### Limits:

FCC		ISED	
TX spurious emissions conducted < 30 MHz			
Frequency (MHz)	Quasi-peak (dBµV/m)	Average (dBµV/m)	
0.15 – 0.5	66 to 56*	56 to 46*	
0.5 – 5	56	46	
5 – 30.0	60	50	

\*Decreases with the logarithm of the frequency

### Results:

Spurious emissions conducted < 30 MHz [dBµV/m]		
F [MHz]	Detector	Level [dBµV/m]
Result table below plots.		



**Plots:**

**Plot 1:** 150 kHz to 30 MHz, phase line

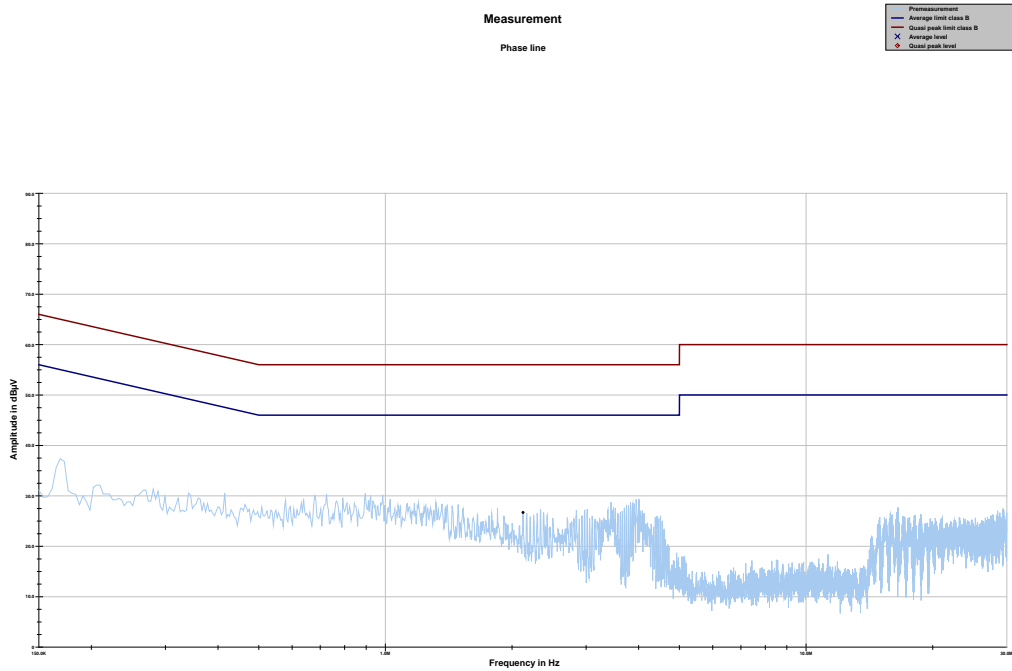

Project ID: 1-1581/20-01-09

**Final results:**

Frequency	Quasi peak level	Margin quasi peak	Limit QP	Average level	Margin average	Limit AV
MHz	dBµV	dB	dBµV	dBµV	dB	dBµV
-/-	-/-	-/-	-/-	-/-	-/-	-/-

**Plot 2:** 150 kHz to 30 MHz, neutral line

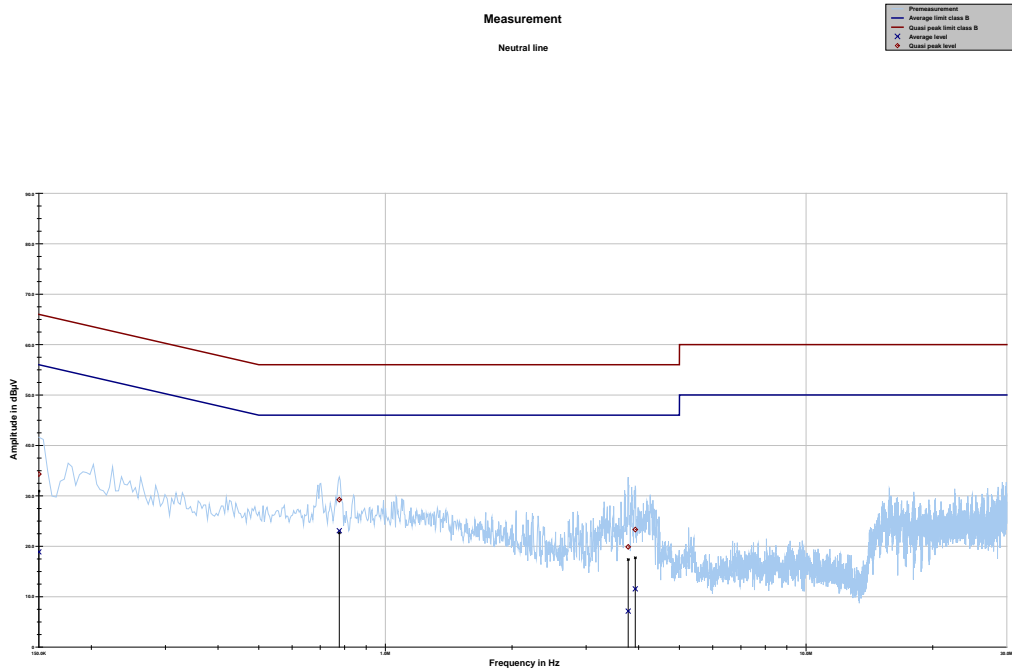

Project ID: 1-1581/20-01-09

**Final results:**

Frequency	Quasi peak level	Margin quasi peak	Limit QP	Average level	Margin average	Limit AV
MHz	dBµV	dB	dBµV	dBµV	dB	dBµV
0.150000	34.31	31.69	66.000	18.88	37.12	56.000
0.776850	29.23	26.77	56.000	23.09	22.91	46.000
3.776775	19.88	36.12	56.000	7.14	38.86	46.000
3.926025	23.30	32.70	56.000	11.54	34.46	46.000

## 13 Glossary

<b>EUT</b>	Equipment under test
<b>DUT</b>	Device under test
<b>UUT</b>	Unit under test
<b>GUE</b>	GNSS User Equipment
<b>ETSI</b>	European Telecommunications Standards Institute
<b>EN</b>	European Standard
<b>FCC</b>	Federal Communications Commission
<b>FCC ID</b>	Company Identifier at FCC
<b>IC</b>	Industry Canada
<b>PMN</b>	Product marketing name
<b>HMN</b>	Host marketing name
<b>HVIN</b>	Hardware version identification number
<b>FVIN</b>	Firmware version identification number
<b>EMC</b>	Electromagnetic Compatibility
<b>HW</b>	Hardware
<b>SW</b>	Software
<b>Inv. No.</b>	Inventory number
<b>S/N or SN</b>	Serial number
<b>C</b>	Compliant
<b>NC</b>	Not compliant
<b>NA</b>	Not applicable
<b>NP</b>	Not performed
<b>PP</b>	Positive peak
<b>QP</b>	Quasi peak
<b>AVG</b>	Average
<b>OC</b>	Operating channel
<b>OCW</b>	Operating channel bandwidth
<b>OBW</b>	Occupied bandwidth
<b>OOB</b>	Out of band
<b>DFS</b>	Dynamic frequency selection
<b>CAC</b>	Channel availability check
<b>OP</b>	Occupancy period
<b>NOP</b>	Non occupancy period
<b>DC</b>	Duty cycle
<b>PER</b>	Packet error rate
<b>CW</b>	Clean wave
<b>MC</b>	Modulated carrier
<b>WLAN</b>	Wireless local area network
<b>RLAN</b>	Radio local area network
<b>DSSS</b>	Dynamic sequence spread spectrum
<b>OFDM</b>	Orthogonal frequency division multiplexing
<b>FHSS</b>	Frequency hopping spread spectrum
<b>GNSS</b>	Global Navigation Satellite System
<b>C/N<sub>0</sub></b>	Carrier to noise-density ratio, expressed in dB-Hz

## 14 Document history

Version	Applied changes	Date of release
-/-	Initial release	2021-10-28

## 15 Accreditation Certificate – D-PL-12076-01-04

first page	last page
 <p>Deutsche Akkreditierungsstelle GmbH</p> <p>Entrusted according to Section 8 subsection 1 AkkStelleG in connection with Section 1 subsection 1 AkkStelleGBV Signatory to the Multilateral Agreements of EA, ILAC and IAF for Mutual Recognition</p> <p><b>Accreditation</b></p> <p>The Deutsche Akkreditierungsstelle GmbH attests that the testing laboratory <b>CTC advanced GmbH</b> Untertürkheimer Straße 6-10, 66117 Saarbrücken</p> <p>is competent under the terms of DIN EN ISO/IEC 17025:2018 to carry out tests in the following fields: <b>Telecommunication (TC) and Electromagnetic Compatibility (EMC) for Canadian Standards</b></p> <p>The accreditation certificate shall only apply in connection with the notice of accreditation of 09.06.2020 with the accreditation number D-PL-12076-01. It comprises the cover sheet, the reverse side of the cover sheet and the following annex with a total of 07 pages.</p> <p>Registration number of the certificate: <b>D-PL-12076-01-04</b></p> <p>Frankfurt am Main, 09.06.2020 by order and in the presence of <b>Frank Egnor</b> Head of Division</p> <p>The certificate together with its annex reflects the status at the time of the date of issue. The current status of the scope of accreditation can be found in the database of accredited bodies of Deutsche Akkreditierungsstelle GmbH. <a href="https://www.dakks.de/en/content/accredited-bodies-dakks">https://www.dakks.de/en/content/accredited-bodies-dakks</a> <small>See notes on next page.</small></p>	 <p>Deutsche Akkreditierungsstelle GmbH</p> <p>Office Berlin Spittelmarkt 10 10117 Berlin</p> <p>Office Frankfurt am Main Europa-Allee 52 60327 Frankfurt am Main</p> <p>Office Braunschweig Bundesaallee 100 38116 Braunschweig</p> <p>The publication of extracts of the accreditation certificate is subject to the prior written approval by Deutsche Akkreditierungsstelle GmbH (DAKKS). Exempted is the unchanged form of separate disseminations of the cover sheet by the conformity assessment body mentioned overleaf.</p> <p>No impression shall be made that the accreditation also extends to fields beyond the scope of accreditation attested by DAKKS.</p> <p>The accreditation was granted pursuant to the Act on the Accreditation Body (AkkStelleG) of 31 July 2009 (Federal Law Gazette I p. 2625) and the Regulation (EC) No 765/2008 of the European Parliament and of the Council of 9 July 2008 setting out the requirements for accreditation and market surveillance relating to the marketing of products (Official Journal of the European Union L 218 of 9 July 2008, p. 30). DAKKS is a signatory to the Multilateral Agreements for Mutual Recognition of the European co-operation for Accreditation (EA), International Accreditation Forum (IAF) and International Laboratory Accreditation Cooperation (ILAC). The signatories to these agreements recognise each other's accreditations.</p> <p>The up-to-date state of membership can be retrieved from the following websites: EA: <a href="http://www.european-accreditation.org">www.european-accreditation.org</a> ILAC: <a href="http://www.ilac.org">www.ilac.org</a> IAF: <a href="http://www.iaf.nu">www.iaf.nu</a></p>

**Note: The current certificate annex is published on the websites (link see below).**

<https://www.dakks.de/files/data/as/pdf/D-PL-12076-01-04.pdf>

OR

[https://ctcadvanced.com/app/uploads/2020/06/D-PL-12076-01-04\\_Canada\\_TCEMC.pdf](https://ctcadvanced.com/app/uploads/2020/06/D-PL-12076-01-04_Canada_TCEMC.pdf)

**16 Accreditation Certificate – D-PL-12076-01-05**

first page	last page
 <p>Deutsche Akkreditierungsstelle GmbH</p> <p>Entrusted according to Section 8 subsection 1 AkkStelleG in connection with Section 1 subsection 1 AkkStelleGBV Signatory to the Multilateral Agreements of EA, ILAC and IAF for Mutual Recognition</p> <p><b>Accreditation</b> </p> <p>The Deutsche Akkreditierungsstelle GmbH attests that the testing laboratory <b>CTC advanced GmbH</b> Untertürkheimer Straße 6-10, 66117 Saarbrücken is competent under the terms of DIN EN ISO/IEC 17025:2018 to carry out tests in the following fields: <b>Telecommunication (FCC Requirements)</b></p> <p>The accreditation certificate shall only apply in connection with the notice of accreditation of 09.06.2020 with the accreditation number D-PL-12076-01. It comprises the cover sheet, the reverse side of the cover sheet and the following annex with a total of 05 pages. Registration number of the certificate: <b>D-PL-12076-01-05</b></p> <p>Frankfurt am Main, 09.06.2020 by  Dipl.-Ing. (FH) M. Egner Head of Division</p> <p><small>The certificate together with its annex reflects the status at the time of the date of issue. The current status of the scope of accreditation can be found in the database of accredited bodies of Deutsche Akkreditierungsstelle GmbH. <a href="https://www.dakks.de/en/content/accredited-bodies-dakks">https://www.dakks.de/en/content/accredited-bodies-dakks</a> In valid until:</small></p>	<p>Deutsche Akkreditierungsstelle GmbH</p> <p>Office Berlin Spittelmarkt 10 10117 Berlin</p> <p>Office Frankfurt am Main Europa-Allee 52 60327 Frankfurt am Main</p> <p>Office Braunschweig Bundesallee 100 38116 Braunschweig</p> <p>The publication of extracts of the accreditation certificate is subject to the prior written approval by Deutsche Akkreditierungsstelle GmbH (DAKkS). Exempted is the unchanged form of separate disseminations of the cover sheet by the conformity assessment body mentioned overleaf.</p> <p>No impression shall be made that the accreditation also extends to fields beyond the scope of accreditation attested by DAKkS.</p> <p>The accreditation was granted pursuant to the Act on the Accreditation Body (AkkStelleG) of 31 July 2009 (Federal Law Gazette I p. 2625) and the Regulation (EC) No 765/2008 of the European Parliament and of the Council of 9 July 2008 setting out the requirements for accreditation and market surveillance relating to the marketing of products (Official Journal of the European Union L 218 of 9 July 2008, p. 30). DAKkS is a signatory to the Multilateral Agreements for Mutual Recognition of the European co-operation for Accreditation (EA), International Accreditation Forum (IAF) and International Laboratory Accreditation Cooperation (ILAC). The signatories to these agreements recognise each other's accreditations.</p> <p>The up-to-date state of membership can be retrieved from the following websites: EA: <a href="http://www.european-accreditation.org">www.european-accreditation.org</a> ILAC: <a href="http://www.ilac.org">www.ilac.org</a> IAF: <a href="http://www.iaf.nu">www.iaf.nu</a></p>

**Note: The current certificate annex is published on the websites (link see below).**

<https://www.dakks.de/files/data/as/pdf/D-PL-12076-01-05.pdf>

OR

[https://ctcadvanced.com/app/uploads/2020/06/D-PL-12076-01-05\\_TCB\\_USA.pdf](https://ctcadvanced.com/app/uploads/2020/06/D-PL-12076-01-05_TCB_USA.pdf)

##### END OF TEST REPORT #####