



**DATE: 21 March 2021**

**I.T.L. (PRODUCT TESTING) LTD.  
FCC Radio Test Report**

**For**

**Corning Optical Communication Wireless**

**Equipment under test:**

**ONE - Optical Network Evolution Wireless  
Platform**

**RAU-5 Remote Antenna Unit**

**(LTE Section)**

Tested by:

  
\_\_\_\_\_  
M. Zohar

Approved by:

  
\_\_\_\_\_  
D. Shidlowsky

This report must not be reproduced, except in full, without the written permission of I.T.L. (Product Testing) Ltd.

This report relates only to items tested.



**Measurement/Technical Report for  
Corning Optical Communication Wireless  
ONE - Optical Network Evolution Wireless  
Platform  
RAU-5 Remote Antenna Unit**

**FCC ID: OJF1RAU5**

This report concerns: Original Grant:  
Class II change: X  
Class I change:

Equipment type: B21 - Part 20 Industrial Booster (CMRS)

Limits used: 47CFR Parts 2; 27

Measurement procedure used is KDB 935210 D05 v01r03 April 2019,  
KDB 971168 D03 v01 and ANSI IEEE C63.26-2015

Substitution Method used as in ANSI TIA-603-E-2016

Application for Certification  
prepared by:  
D. Shidlowsky  
ITL (Product Testing) Ltd.  
1 Bat Sheva St.  
Lod 7120101  
Israel  
e-mail [davids@iltglobal.org](mailto:davids@iltglobal.org)

Applicant for this device:  
(different from "prepared by")  
Isaac Nissan  
Corning Optical Communication Wireless  
8253 1<sup>st</sup> Street  
Vienna, VA 22812  
U.S.A.  
Tel: +1-703 855-1773  
E-mail: [NissanI@corning.com](mailto:NissanI@corning.com)



# TABLE OF CONTENTS

<b>1</b>	<b>GENERAL INFORMATION -----</b>	<b>4</b>
1.1	Administrative Information .....	4
1.2	List of Accreditations .....	5
1.3	Product Description .....	6
1.4	Test Methodology .....	6
1.5	Test Facility .....	6
1.6	Measurement Uncertainty .....	7
<b>2</b>	<b>SYSTEM TEST CONFIGURATION -----</b>	<b>8</b>
2.1	Justification .....	8
2.2	EUT Exercise Software .....	8
2.3	Special Accessories .....	8
2.4	Equipment Modifications .....	8
2.5	Configuration of Tested System .....	9
<b>3</b>	<b>TEST SET-UP PHOTOS -----</b>	<b>10</b>
<b>4</b>	<b>RF POWER OUTPUT -----</b>	<b>13</b>
4.1	Test Specification .....	13
4.2	Test Procedure .....	13
4.3	Test Limit .....	13
4.4	Test Results .....	13
4.5	Test Equipment Used; RF Power Output .....	42
<b>5</b>	<b>OCCUPIED BANDWIDTH -----</b>	<b>43</b>
5.1	Test Specification .....	43
5.2	Test Procedure .....	43
5.3	Test Limit .....	43
5.4	Test Results .....	43
5.5	Test Equipment Used; Occupied Bandwidth .....	100
<b>6</b>	<b>SPURIOUS EMISSIONS AT ANTENNA TERMINALS -----</b>	<b>101</b>
6.1	Test Specification .....	101
6.2	Test Procedure .....	101
6.3	Test Limit .....	101
6.4	Test Results .....	101
6.5	Test Equipment Used; Spurious Emissions at Antenna Terminals .....	146
<b>7</b>	<b>SPURIOUS RADIATED EMISSION -----</b>	<b>147</b>
7.1	Test Specification .....	147
7.2	Test Procedure .....	147
7.3	Test Limit .....	148
7.4	Test Results .....	148
7.5	Test Instrumentation Used; Radiated Measurements .....	149
<b>8</b>	<b>APPENDIX A - CORRECTION FACTORS -----</b>	<b>150</b>
8.1	Correction factors for RF OATS Cable 35m .....	150
8.2	Correction factors for RF OATS Cable 10m .....	151
8.3	Correction factors for Horn Antenna .....	152
8.4	Correction factors for Horn Antenna .....	153
8.5	Correction factors for Log Periodic Antenna .....	154
8.6	Correction factors for Biconical Antenna .....	155
8.7	Correction factors for ACTIVE LOOP ANTENNA .....	156



# 1 General Information

## 1.1 Administrative Information

Manufacturer:	Corning Optical Communication Wireless
Manufacturer's Address:	8253 1st Street Vienna, VA 22812 U.S.A. Tel: +1-703 855-1773
Manufacturer's Representative:	Isaac Nissan
Equipment Under Test (E.U.T):	ONE - Optical Network Evolution Wireless Platform
Equipment Model No.:	RAU-5 Remote Antenna Unit
Equipment Serial No.:	Not Designated
Date of Receipt of E.U.T:	September 01, 2020
Start of Test:	September 01, 2020
End of Test:	November 12, 2020
Test Laboratory Location:	I.T.L (Product Testing) Ltd. 1 Batsheva St, Lod, Israel 7116002
Test Specifications:	FCC Parts 2; 27



## **1.2 List of Accreditations**

The EMC laboratory of I.T.L. is accredited by/registered with the following bodies:

1. The American Association for Laboratory Accreditation (A2LA) (U.S.A.), Certificate No. 1152.01.
2. The Federal Communications Commission (FCC) (U.S.A.), FCC Designation Number is IL1005.
3. The Israel Ministry of the Environment (Israel), Registration No. 1104/01.
4. The Voluntary Control Council for Interference by Information Technology Equipment (VCCI) (Japan), Registration Numbers: C-20025, R-2729, T-20028, G-20068.
5. Department of Innovation, Science and Economic Development (ISED) Canada, CAB identifier: IL1002.

I.T.L. Product Testing Ltd. is accredited by the American Association for Laboratory Accreditation (A2LA) and the results shown in this test report have been determined in accordance with I.T.L.'s terms of accreditation unless stated otherwise in the report.



### **1.3 Product Description**

Modular 7 band Enabled Mid Power Neutral Host Solution –

Supported modular frequency bands

700, ESMR+CELL, PCS, AWS, WCS

Integrated 2.5 GHz expansion ready

Composite Output Power

AWS: 34dBm

PCS, WCS: 33dBm

700, ESMR & CELL: 30dBm

Specifications

100% Modularity

NEBS Class 2 Compliant

Small Footprint – 6 Rack Units

Highlights:

Extended ONE platform design Diversity

100% modular component design

Composite output power: 2W

Small Compact Form Factor (6U)

Non-Service Impacting Upgrades

Lower initial deployment costs

### **1.4 Test Methodology**

Both conducted and radiated testing were performed according to the procedures in KDB 935210 D05 v01r03 April 2019, KDB 971168 D03 v01 and ANSI/TIA-603-E-2016. Radiated testing was performed at an antenna to EUT distance of 3 meters.

### **1.5 Test Facility**

Both conducted and radiated emissions tests were performed at I.T.L.'s testing facility in Lod, Israel. I.T.L.'s EMC Laboratory is accredited by A2LA, certificate No. 1152.01 and its FCC Designation Number is IL1005.



## **1.6 Measurement Uncertainty**

### **Conducted Emission**

Conducted Emission (CISPR 11, EN 55011, CISPR 32, EN 55032, ANSI C63.4)

0.15 – 30 MHz:

Expanded Uncertainty (95% Confidence, K=2):

± 3.44 dB

### **Radiated Emission**

Radiated Emission (CISPR 11, EN 55011, CISPR 22, EN 55022, ANSI C63.4)

for open site:

30-1000MHz:

Expanded Uncertainty (95% Confidence, K=2):

± 4.96 dB

1 GHz to 6 GHz

Expanded Uncertainty (95% Confidence, K=2):

±5.19 dB

>6 GHz

Expanded Uncertainty (95% Confidence, K=2):

±5.51 dB

## 2 System Test Configuration

### 2.1 *Justification*

1. The E.U.T was originally FCC certified on 12/26/2014 under FCC ID: OJF1RAU5. It originally supported cellular 3G & 4G technology.
2. A C2PC Grant was issued on 01/05/2017 allowing E.U.T. to operate as part of a booster system with the RXU2325 certified under FCC ID: OJF1RXUN.
3. Currently the manufacturer has made the following C2PC changes:  
Enabling the use of 5G technology via software changes only with the same operation bands. No changes have been made to the hardware.
4. The following tests were performed: RF Output Power, Occupied Bandwidth and Spurious Emissions.
5. The EUT meets the requirements of a C2PC.

### 2.2 *EUT Exercise Software*

The Element Management System SW Version 3.7 build 50 used for commands delivery. These SW are used to enable/disable the EUT transmission.

### 2.3 *Special Accessories*

No special accessories were needed in order to achieve compliance.

### 2.4 *Equipment Modifications*

No modifications were necessary in order to achieve compliance.



## 2.5 Configuration of Tested System

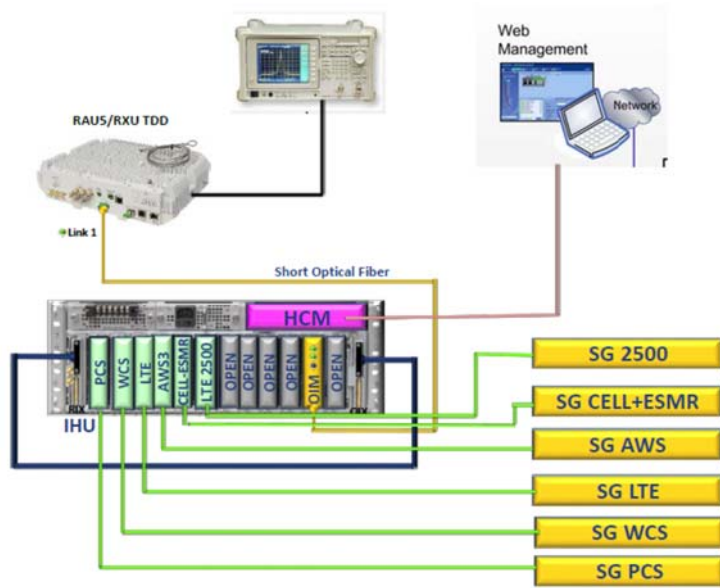

Figure 1. Conducted Test Set-Up

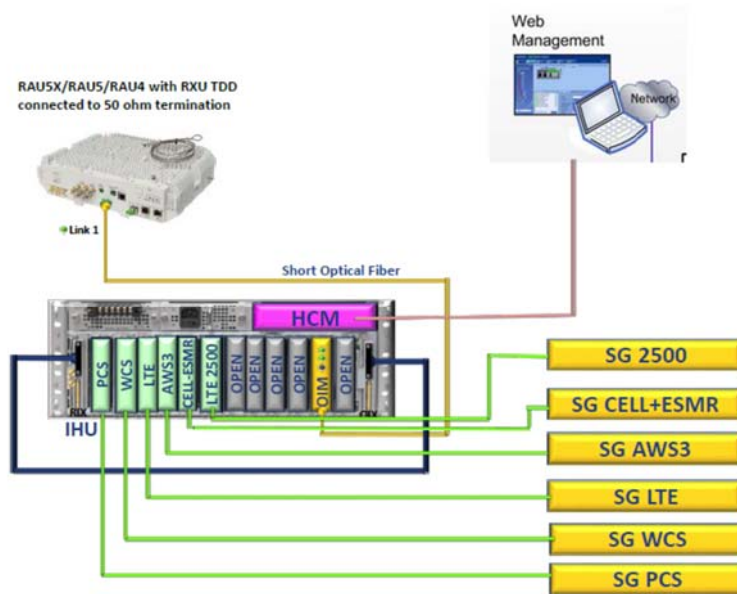

Figure 2. Radiated Test Set-Up

### 3 Test Set-Up Photos

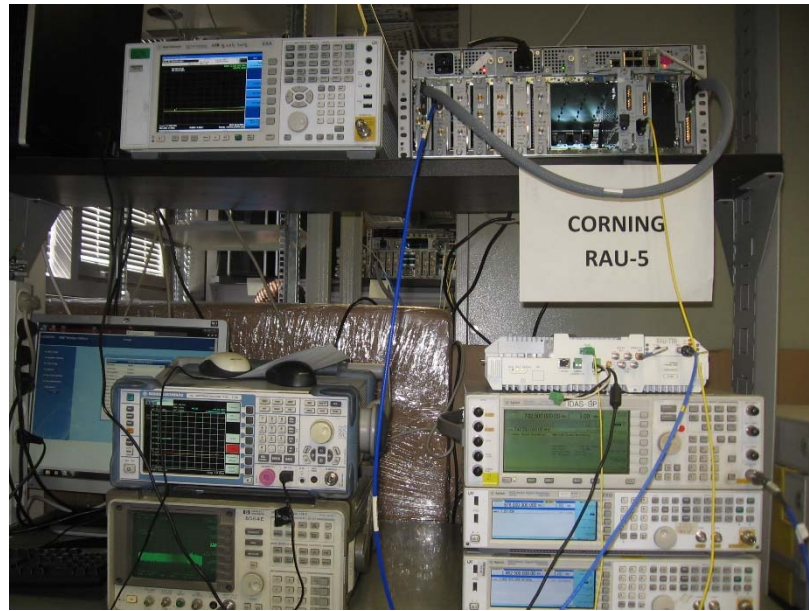

Figure 3. Conducted Emission From Antenna Port Tests

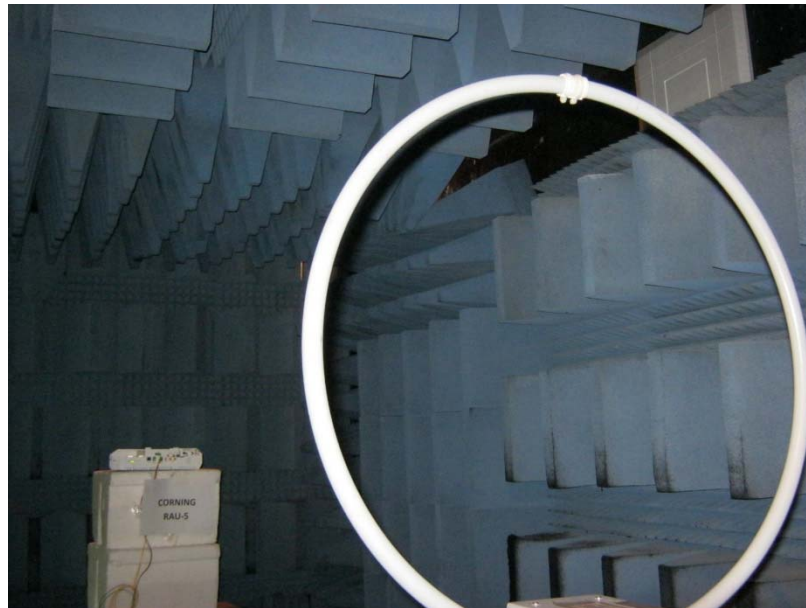

Figure 4. Radiated Emission Test 0.009MHz-30MHz



**Figure 5. Radiated Emission Test 30 - 200 MHz**



**Figure 6. Radiated Emission Test 200 - 1000MHz**



**Figure 7. Radiated Emission Test 1-18GHz**

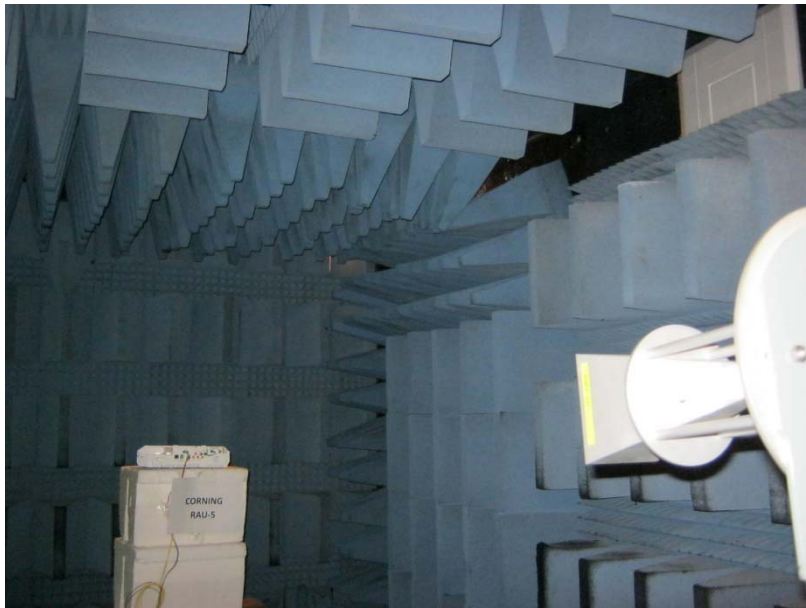

**Figure 8. Radiated Emission Test 18-26.5GHz**

## 4 RF Power Output

### 4.1 Test Specification

Part 27, Subpart C, Section 27.50

### 4.2 Test Procedure

(Temperature (22°C)/ Humidity (60%RH))

The E.U.T. antenna terminal was connected to the Spectrum Analyzer through an external attenuator and an appropriate coaxial cable (41.0 dB). Special attention was taken to prevent Spectrum Analyzer RF input overload.

### 4.3 Test Limit

Peak Power Output must not exceed 1000W (60 dBm).

### 4.4 Test Results

JUDGEMENT: Passed

See additional information in *Table 1* to *Table 4* and *Figure 9* to *Figure 140*.

Modulation	Bandwidth (MHz)	Sub Carrier (kHz)	Operation Frequency (MHz)	Reading (dBm)	
16QAM	5	15	730.5	15.11	
		30	730.5	15.31	
		15	743.0	15.56	
		30	743.0	15.80	
		15	755.5	15.01	
		30	755.5	15.13	
	10	10	15	733.0	15.19
			30	733.0	16.17
			60	733.0	16.83
			15	743.0	15.30
			30	743.0	16.32
			60	743.0	16.92
			15	753.0	15.23
			30	753.0	15.49
			60	753.0	15.89
	15	15	15	735.5	16.64
			30	735.5	16.60
			60	735.5	16.58
			15	743.0	16.66
			30	743.0	16.61
			60	743.0	16.64
			15	750.5	15.89
			30	750.5	15.82
			60	750.5	16.06
	20	20	15	738.0	16.24
			30	738.0	16.57
			60	738.0	16.51
			15	743.0	16.32
			30	743.0	16.47
			60	743.0	16.51
			15	748.0	15.95
			30	748.0	16.09
			60	748.0	16.14

**Table 1 RF Power Output 16QAM**

Modulation	Bandwidth (MHz)	Sub Carrier (kHz)	Operation Frequency (MHz)	Reading (dBm)	
64QAM	5	15	730.5	16.32	
		30	730.5	15.29	
		15	743.0	15.75	
		30	743.0	15.79	
		15	755.5	15.24	
		30	755.5	15.14	
	10	10	15	733.0	15.78
			30	733.0	15.86
			60	733.0	15.84
			15	743.0	15.86
			30	743.0	15.87
			60	743.0	15.85
			15	753.0	14.89
			30	753.0	15.86
			60	753.0	15.94
	15	15	15	735.5	15.96
			30	735.5	15.93
			60	735.5	15.99
			15	743.0	15.86
			30	743.0	15.87
			60	743.0	15.85
			15	750.5	15.16
			30	750.5	15.21
			60	750.5	15.26
	20	20	15	738.0	16.89
			30	738.0	15.89
			60	738.0	15.94
			15	743.0	15.96
			30	743.0	15.87
			60	743.0	15.90
			15	748.0	15.45
			30	748.0	15.51
			60	748.0	15.41

**Table 2 RF Power Output 64QAM**

<b>Modulation</b>	<b>Bandwidth (MHz)</b>	<b>Sub Carrier (kHz)</b>	<b>Operation Frequency (MHz)</b>	<b>Reading (dBm)</b>	
256QAM	5	15	730.5	15.11	
		30	730.5	15.34	
		15	743.0	15.95	
		30	743.0	15.86	
		15	755.5	15.30	
		30	755.5	15.16	
	10	10	15	733.0	15.81
			30	733.0	15.91
			60	733.0	15.86
			15	743.0	15.96
			30	743.0	15.97
			60	743.0	15.88
			15	753.0	15.84
			30	753.0	15.00
			60	753.0	15.97
	15	15	15	735.5	15.98
			30	735.5	16.04
			60	735.5	16.03
			15	743.0	15.97
			30	743.0	15.95
			60	743.0	16.05
			15	750.5	15.18
			30	750.5	15.24
			60	750.5	15.30
	20	20	15	738.0	15.92
			30	738.0	15.98
			60	738.0	16.01
			15	743.0	15.96
			30	743.0	16.00
			60	743.0	15.99
			15	748.0	15.53
			30	748.0	15.50
			60	748.0	15.55

**Table 3 RF Power Output 256QAM**



<b>Modulation</b>	<b>Bandwidth (MHz)</b>	<b>Sub Carrier (kHz)</b>	<b>Operation Frequency (MHz)</b>	<b>Reading (dBm)</b>	
QPSK	5	15	730.5	15.10	
		30	730.5	15.05	
		15	743.0	15.61	
		30	743.0	15.62	
		15	755.5	15.12	
		30	755.5	15.07	
	10	10	15	733.0	15.60
			30	733.0	15.64
			60	733.0	15.62
			15	743.0	15.72
			30	743.0	15.69
			60	743.0	15.68
			15	753.0	15.72
			30	753.0	15.82
			60	753.0	15.68
	15	15	15	735.5	15.83
			30	735.5	15.90
			60	735.5	15.86
			15	743.0	15.84
			30	743.0	15.81
			60	743.0	15.81
			15	750.5	15.01
			30	750.5	15.12
			60	750.5	15.13
	20	20	15	738.0	15.80
			30	738.0	15.85
			60	738.0	15.70
			15	743.0	15.89
			30	743.0	15.81
			60	743.0	15.62
			15	748.0	15.38
			30	748.0	15.28
			60	748.0	15.29

**Table 4 RF Power Output QPSK**

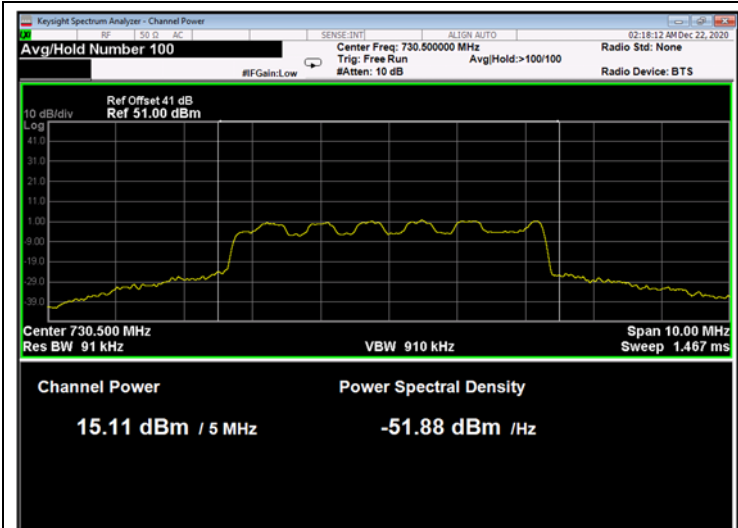

Figure 9: 16QAM 5MHz B.W.; 730.5MHz, 15kHz

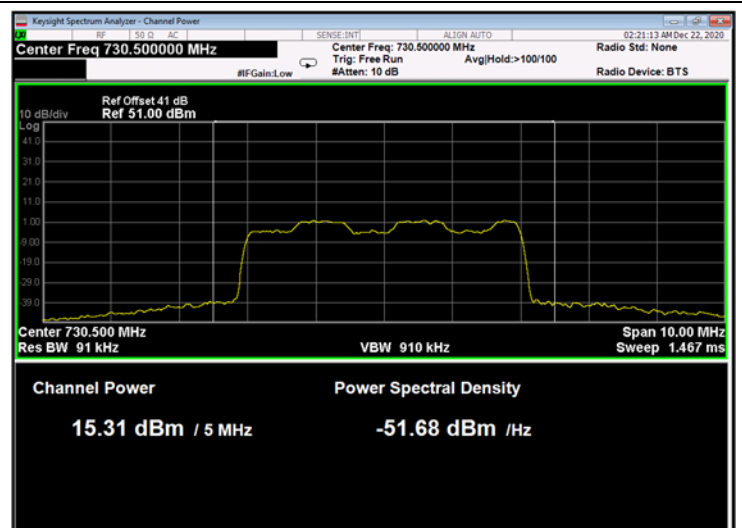

Figure 10: 16QAM 5MHz B.W.; 730.5MHz, 30kHz

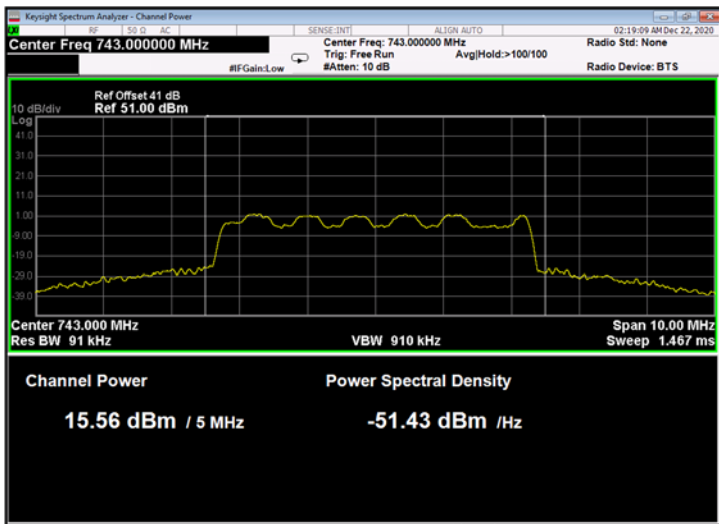

Figure 11: 16QAM 5MHz B.W.; 743.0MHz, 15kHz

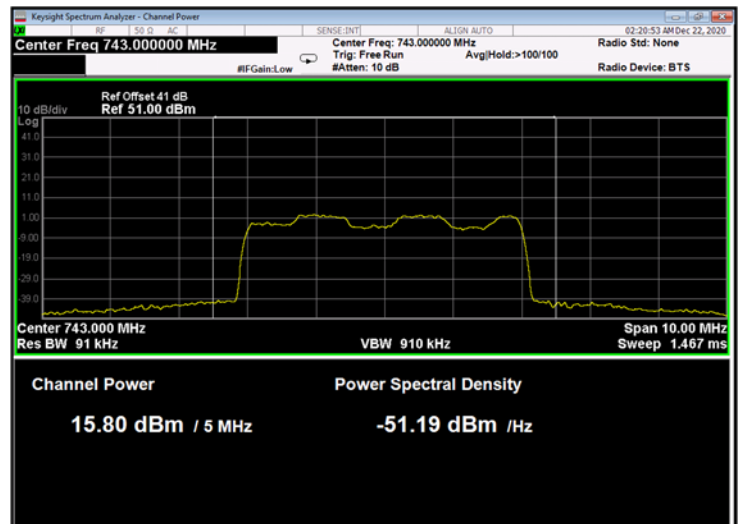

Figure 12: 16QAM 5MHz B.W.; 743.0MHz, 30kHz

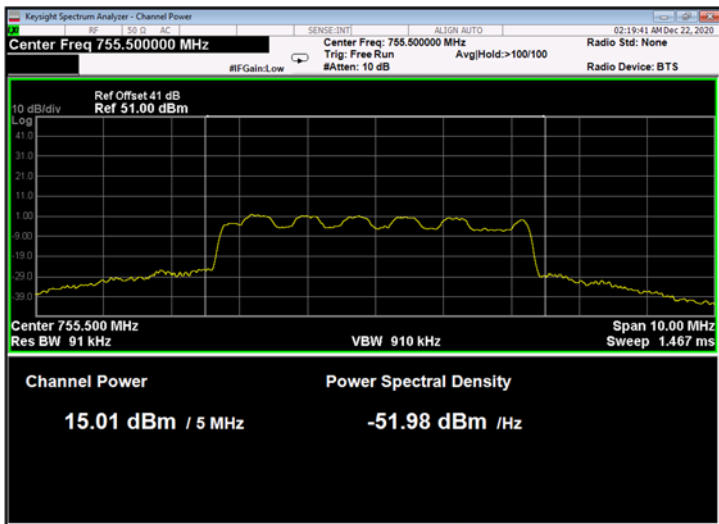

Figure 13: 16QAM 5MHz B.W.; 755.5MHz, 15kHz

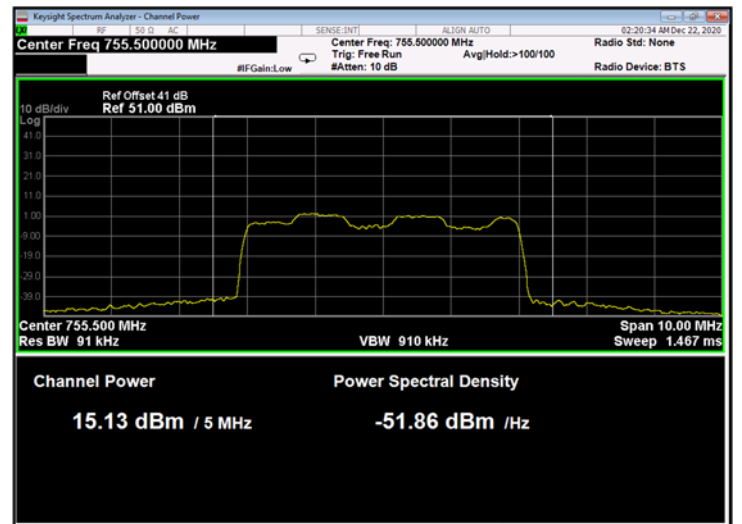

Figure 14: 16QAM 5MHz; 755.5MHz, 30kHz

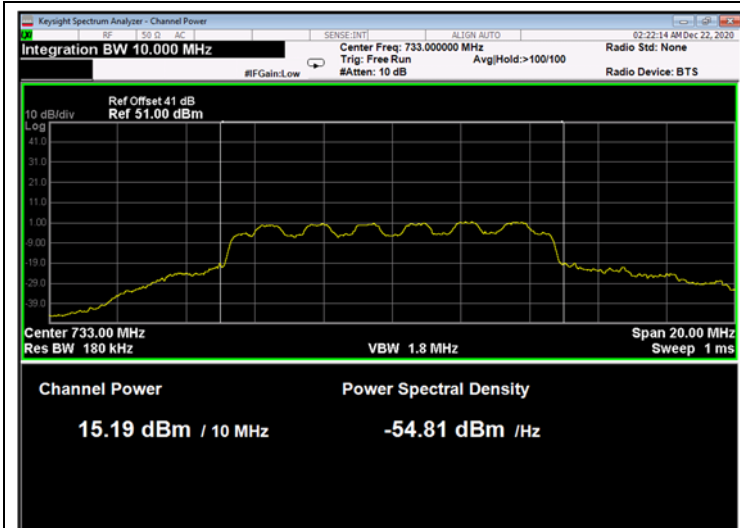

Figure 15: 16QAM 10MHz B.W.; 733.0MHz, 15kHz

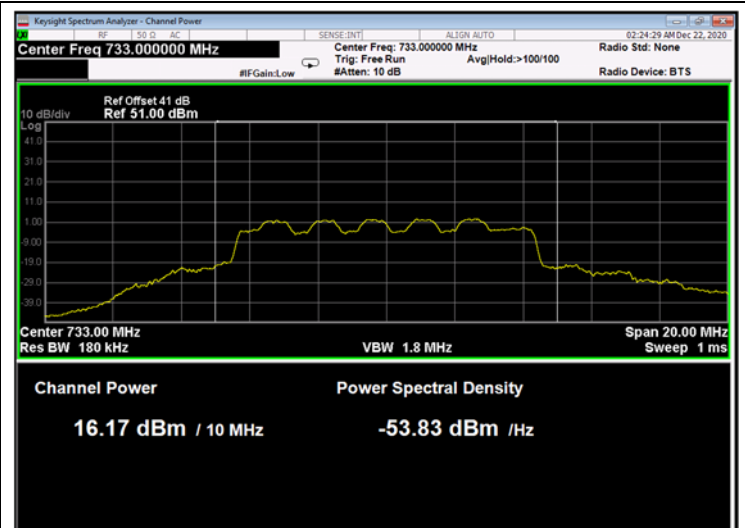

Figure 16: 16QAM 10MHz B.W.; 733.0MHz, 30kHz

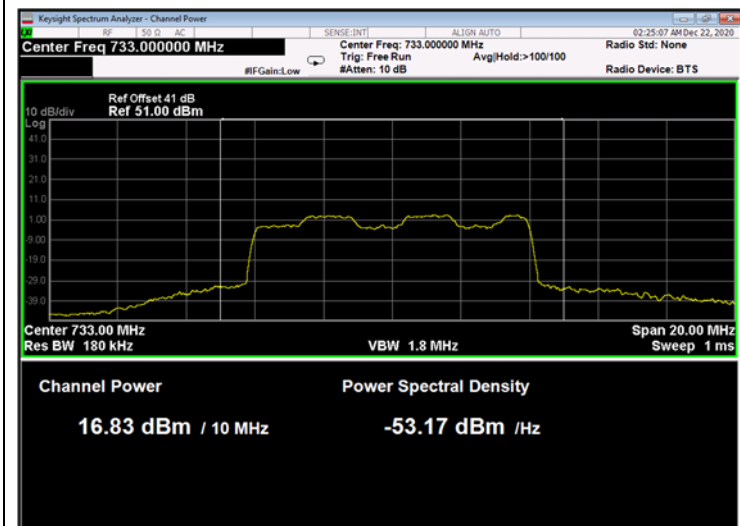

Figure 17: 16QAM 10MHz B.W.; 733.0MHz, 60kHz

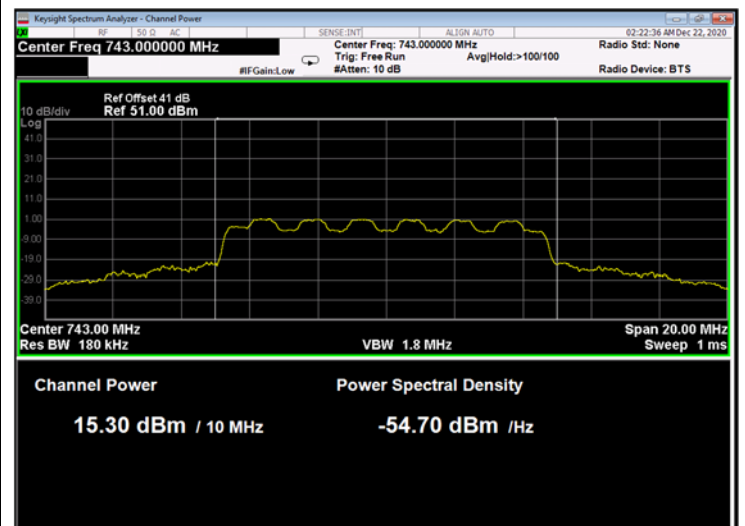

Figure 18: 16QAM 10MHz B.W.; 743.0MHz, 15kHz

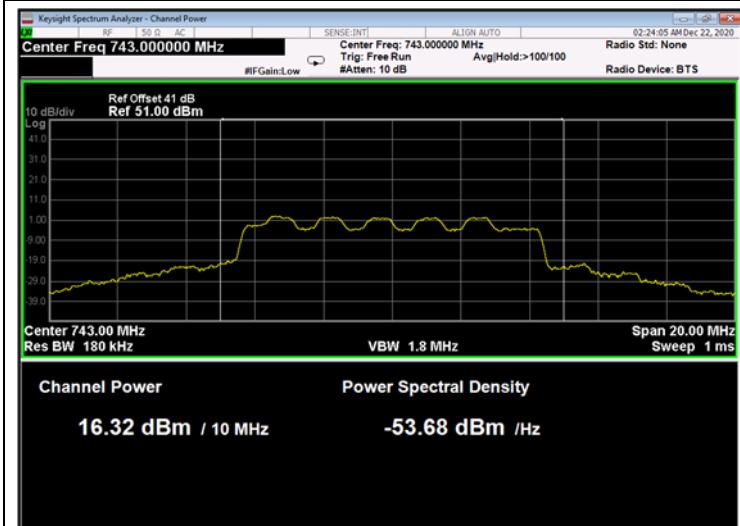

Figure 19: 16QAM 10MHz B.W.; 743.0MHz, 30kHz

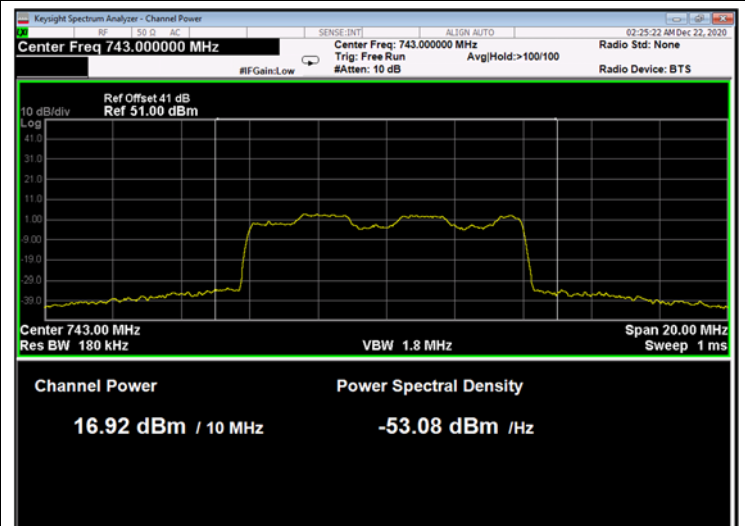

Figure 20: 16QAM 10MHz B.W.; 743.0MHz, 60kHz

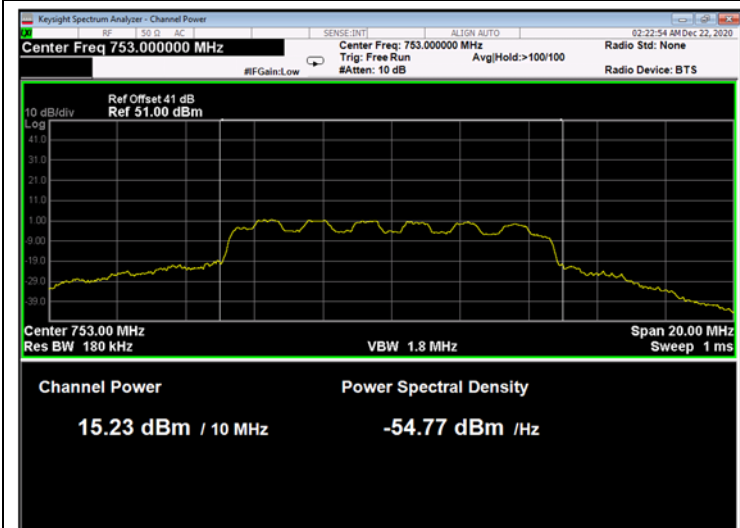

Figure 21: 16QAM 10MHz B.W.; 753.0MHz, 15kHz

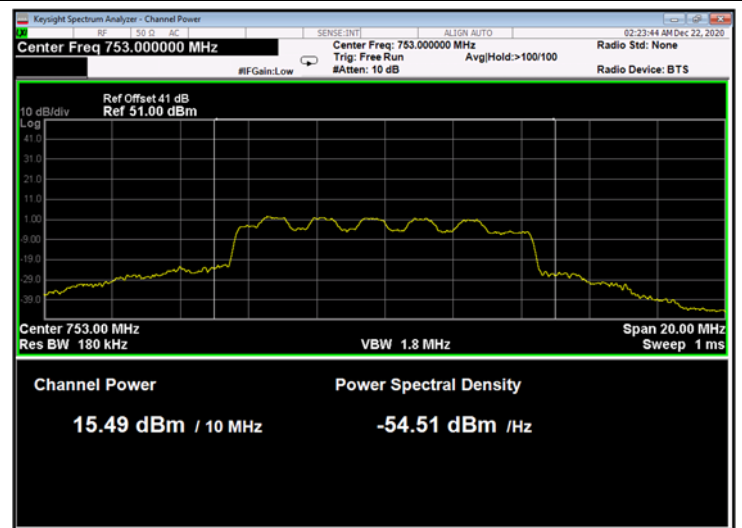

Figure 22: 16QAM 10MHz B.W.; 753.0MHz, 30kHz

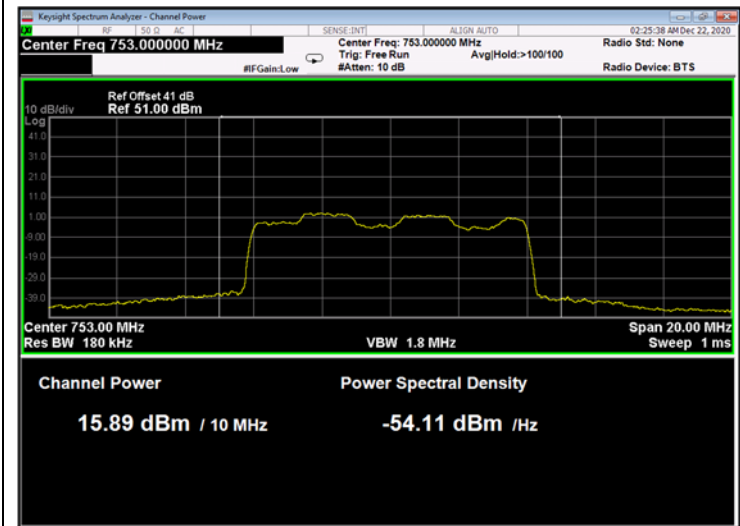

Figure 23: 16QAM 10MHz B.W.; 753.0MHz, 60kHz

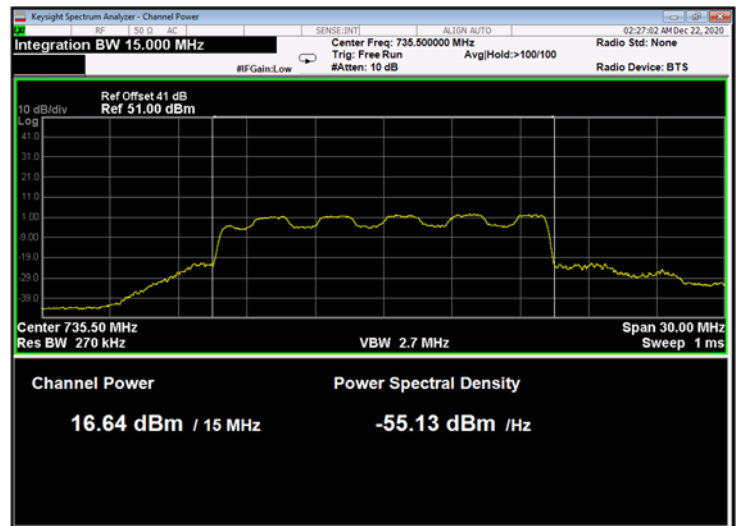

Figure 24: 16QAM 15MHz B.W.; 735.5MHz, 15kHz

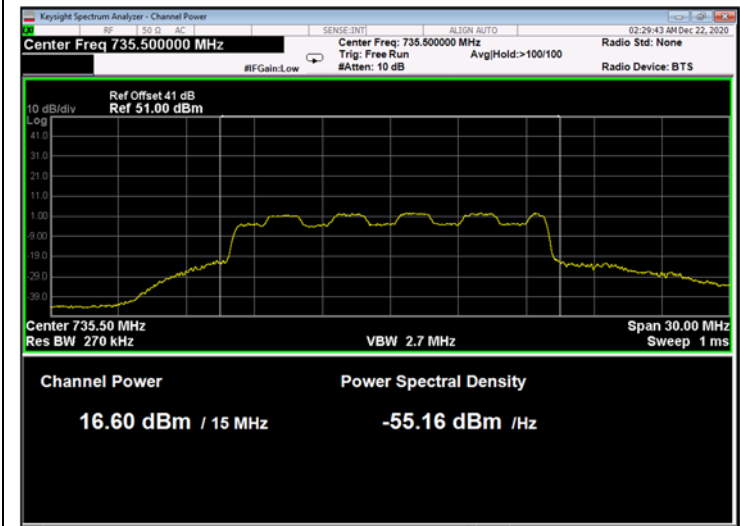

Figure 25: 16QAM 15MHz B.W.; 735.5MHz, 30kHz

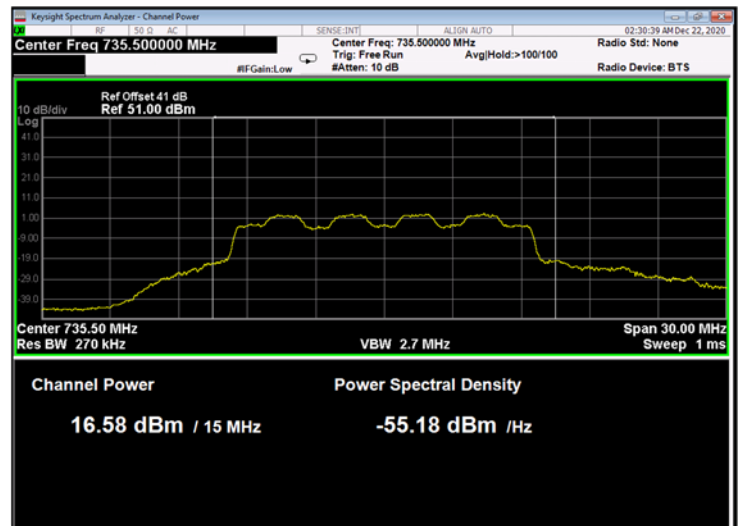

Figure 26: 16QAM 10MHz B.W.; 735.5MHz, 60kHz

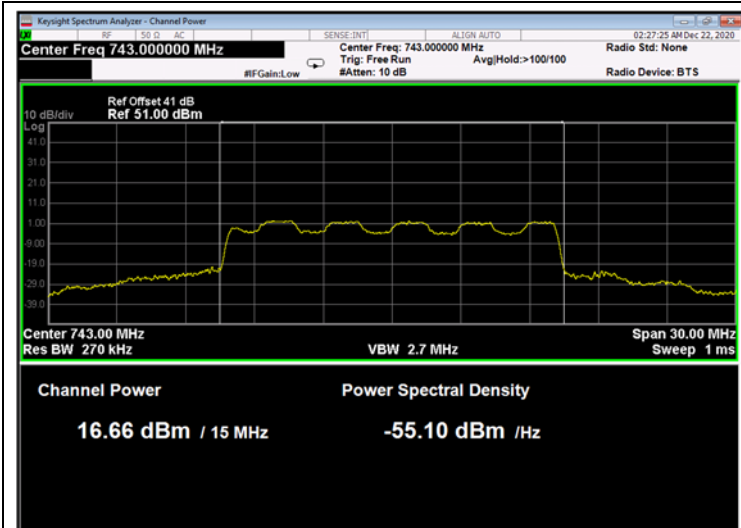

Figure 27: 16QAM 15MHz B.W.; 743.0MHz, 15kHz

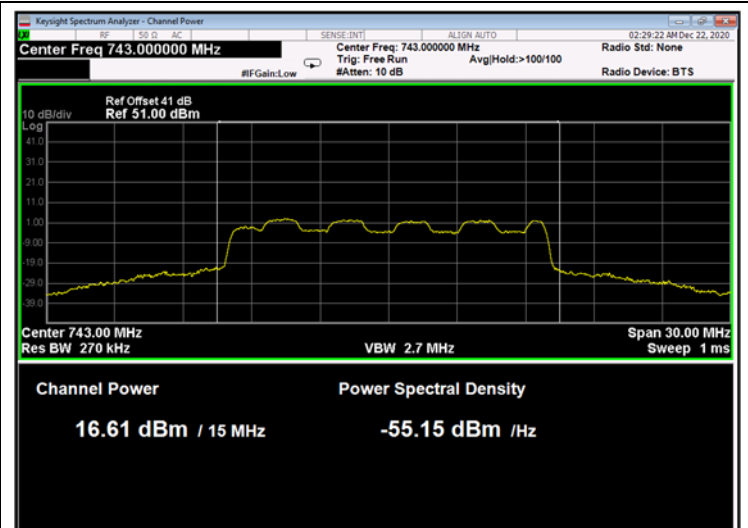

Figure 28: 16QAM 15MHz B.W.; 743.0MHz, 30kHz

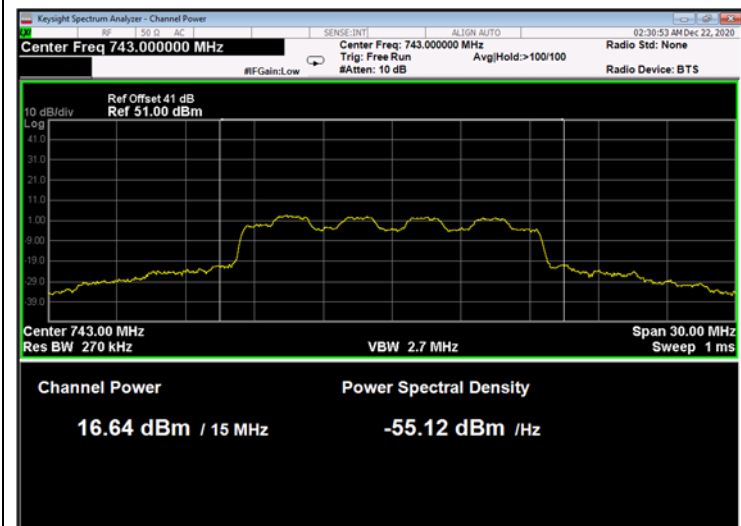

Figure 29: 16QAM 15MHz B.W.; 743.0MHz, 60kHz

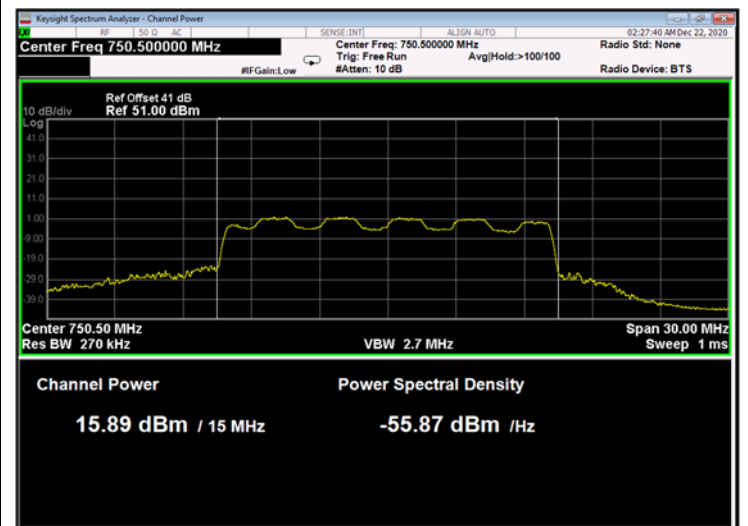

Figure 30: 16QAM 15MHz B.W.; 750.5MHz, 15kHz

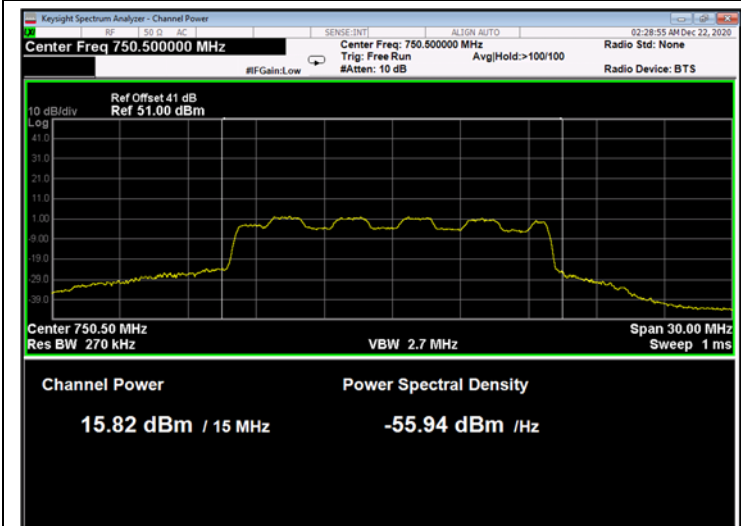

Figure 31: 16QAM 15MHz B.W.; 750.5MHz, 30kHz

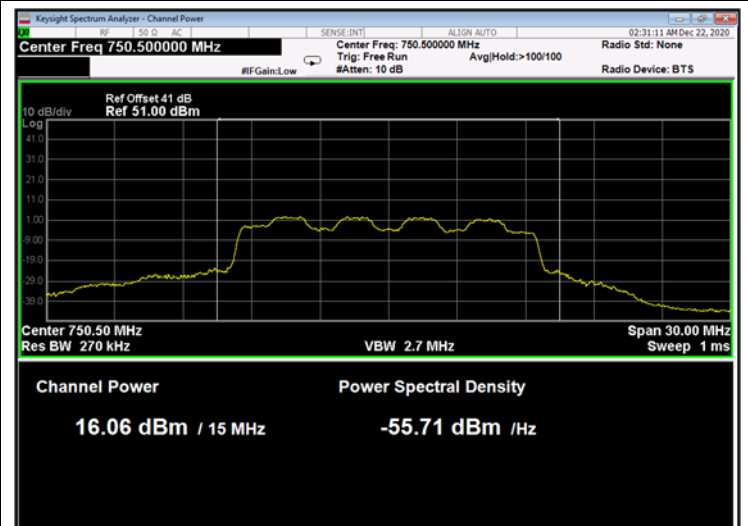

Figure 32: 16QAM 15MHz B.W.; 750.5MHz, 60kHz

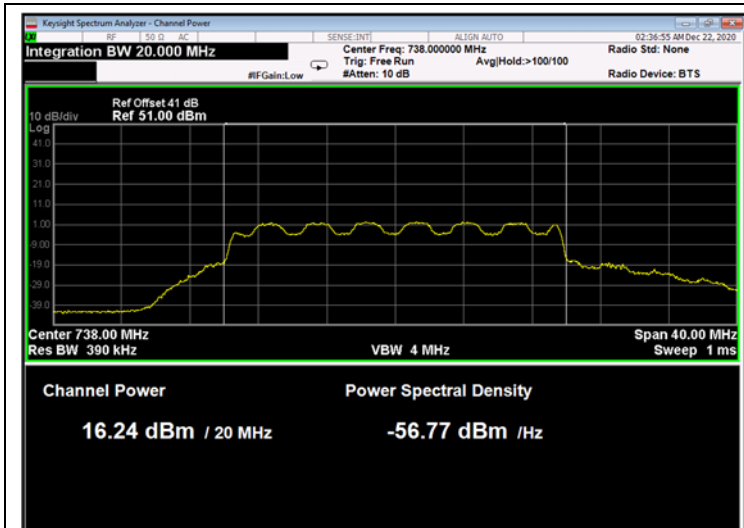

Figure 33: 16QAM 20MHz B.W.; 738.0MHz, 15kHz

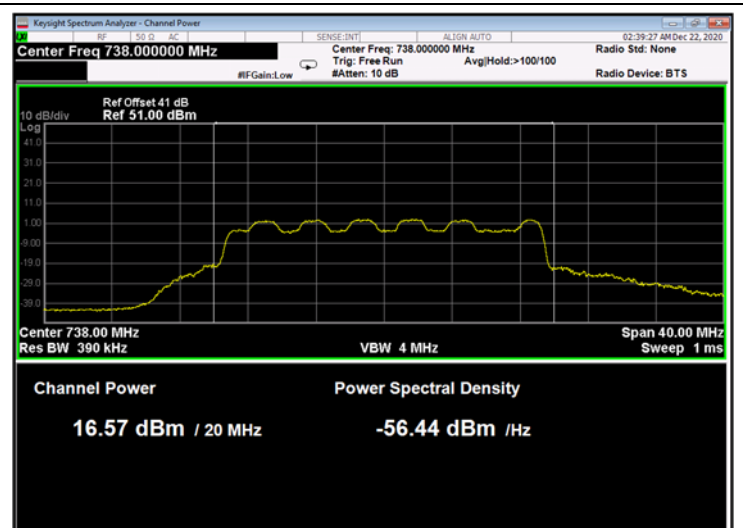

Figure 34: 16QAM 20MHz B.W.; 738.0MHz, 30kHz

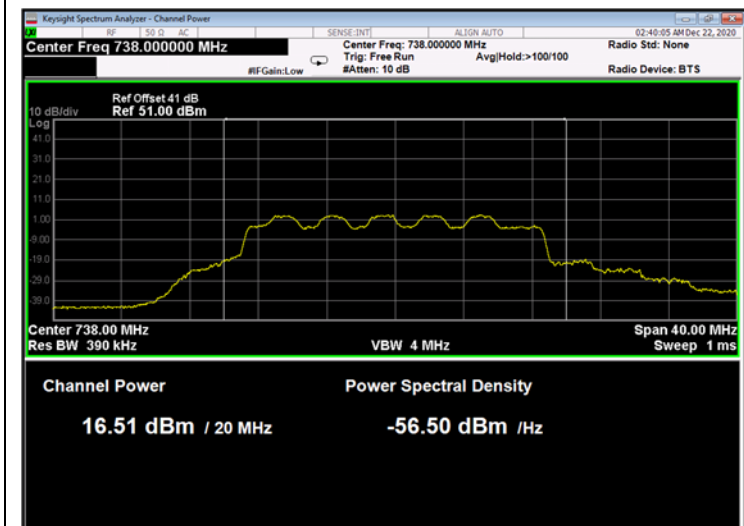

Figure 35: 16QAM 20MHz B.W.; 738.0MHz, 60kHz

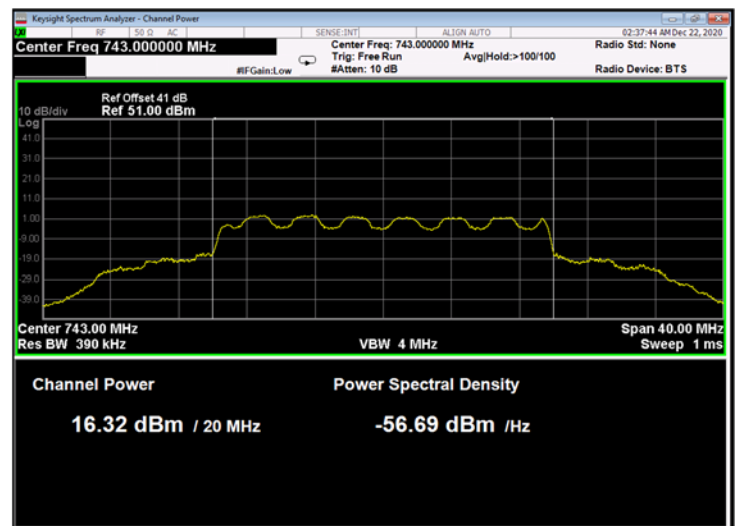

Figure 36: 16QAM 20MHz B.W.; 743.0MHz, 15kHz

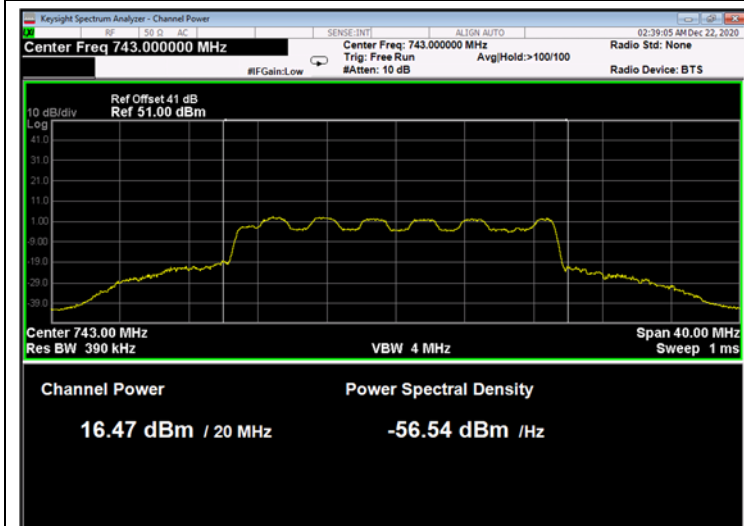

Figure 37: 16QAM 20MHz B.W.; 743.0MHz, 30kHz

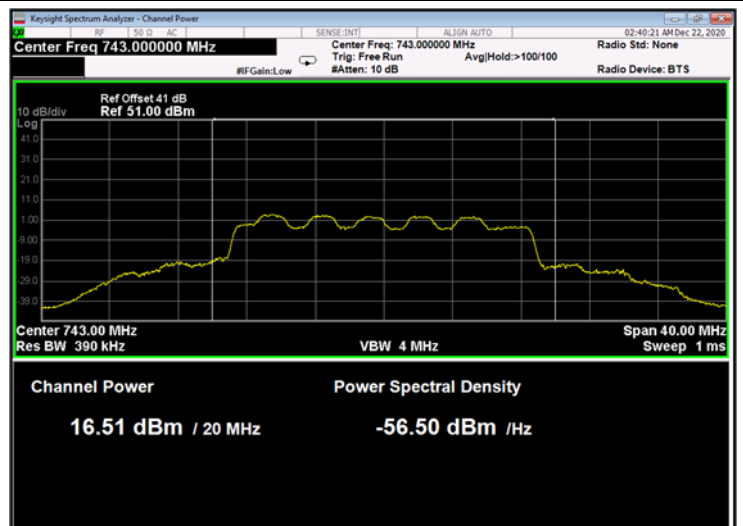

Figure 38: 16QAM 20MHz B.W.; 743.0MHz, 60kHz

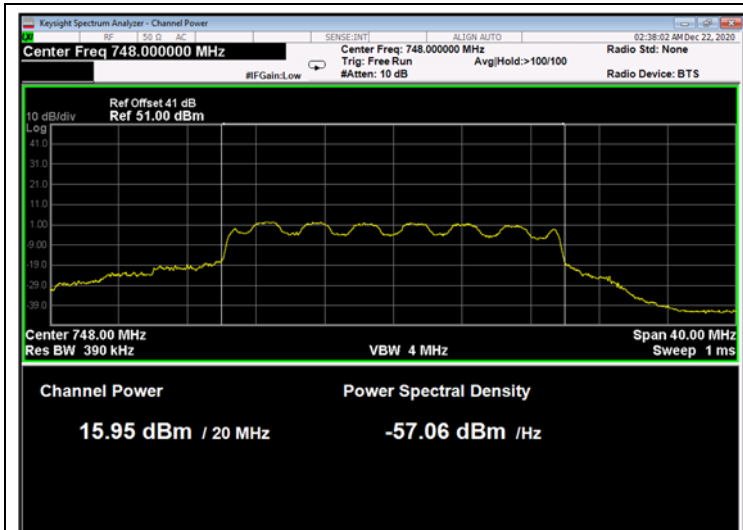

Figure 39: 16QAM 20MHz B.W.; 748.0MHz, 15kHz

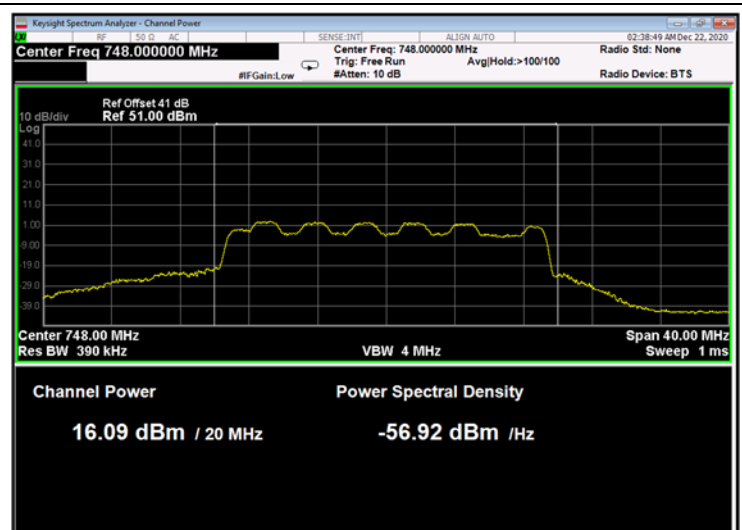

Figure 40: 16QAM 20MHz B.W.; 748.0MHz, 30kHz

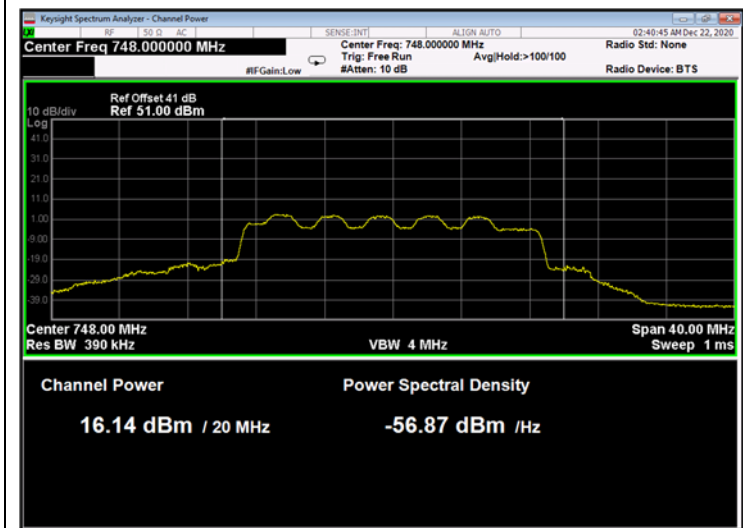

Figure 41: 16QAM 20MHz B.W.; 748.0MHz, 60kHz

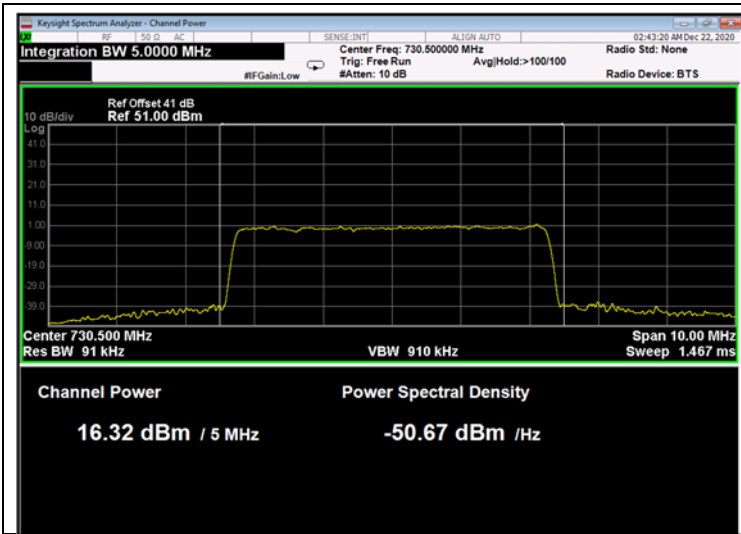

Figure 42: 64QAM 5MHz B.W.; 730.5MHz, 15kHz

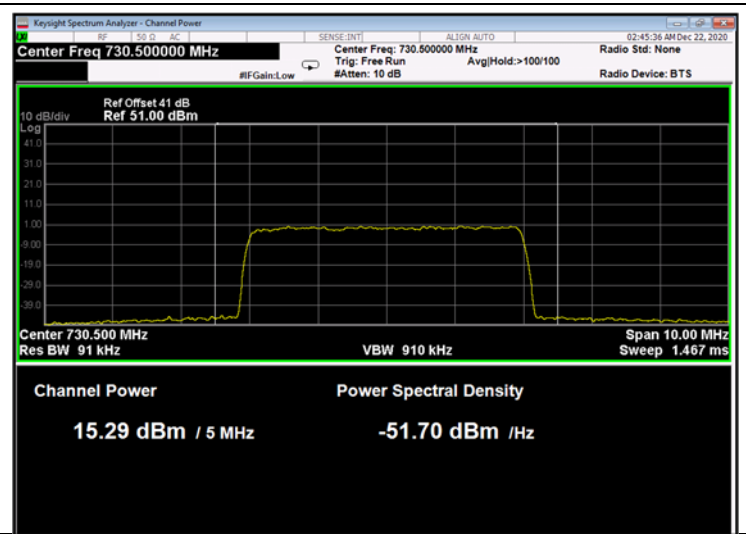

Figure 43: 64QAM 5MHz B.W.; 730.5MHz, 30kHz

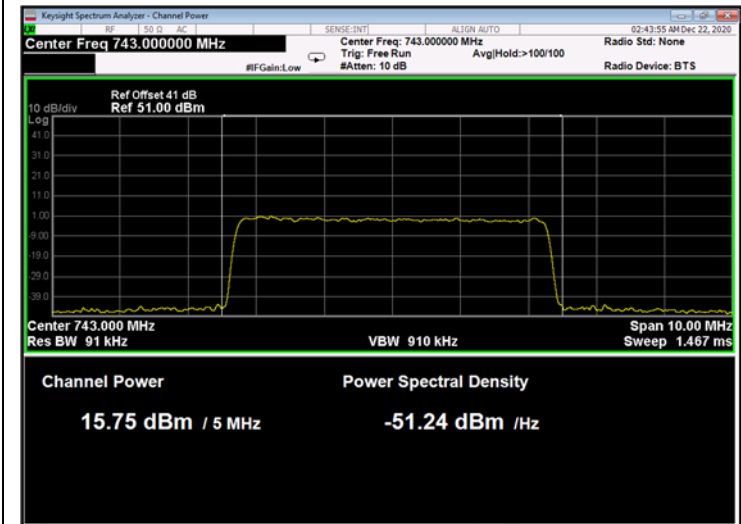

Figure 44: 64QAM 5MHz B.W.; 743.0MHz, 15kHz

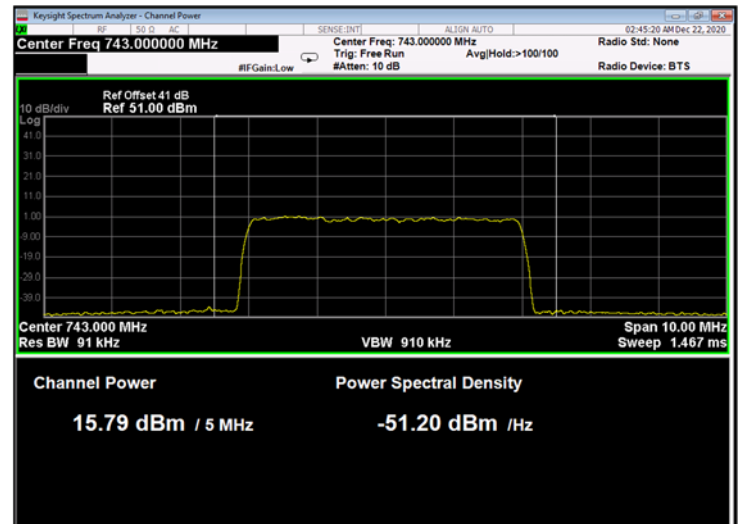

Figure 45: 64QAM 5MHz B.W.; 743.0MHz, 30kHz

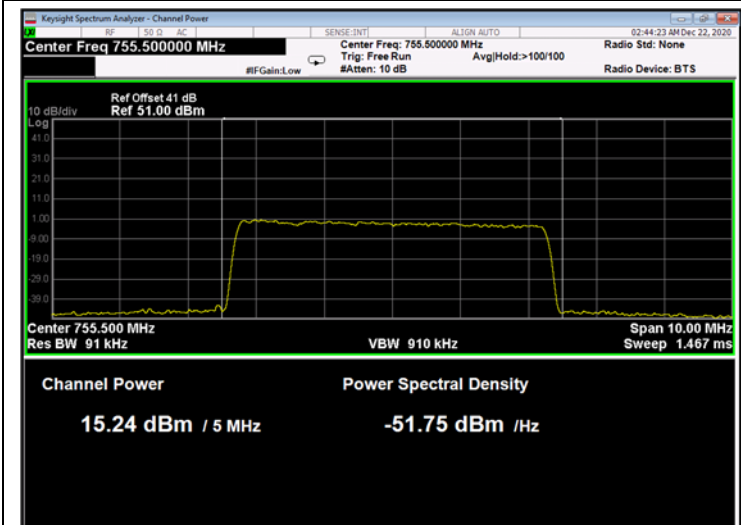

Figure 46: 64QAM 5MHz B.W.; 755.5MHz, 15kHz

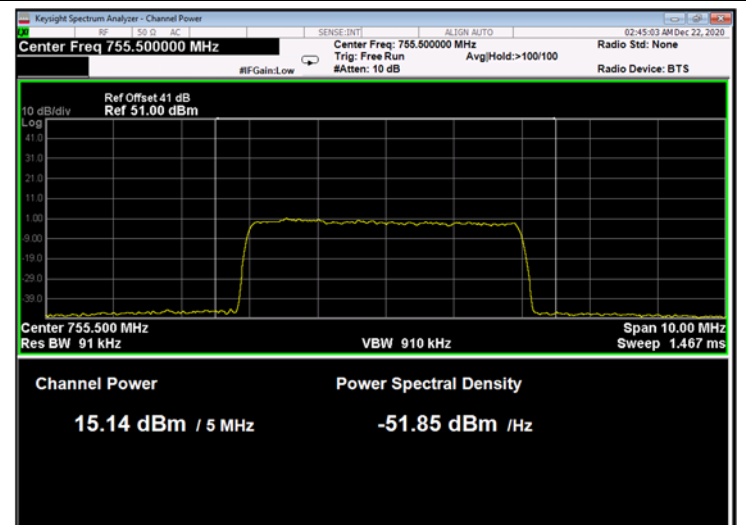

Figure 47: 64QAM 5MHz B.W.; 755.5MHz, 30kHz



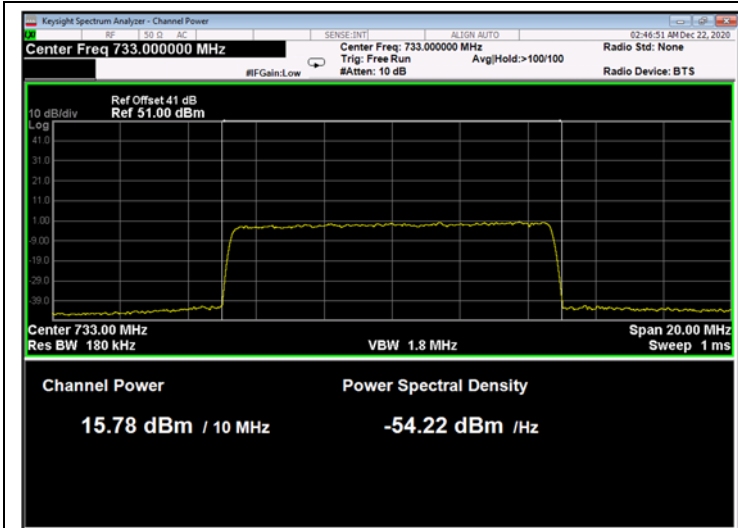

Figure 48: 64QAM 10MHz B.W.; 733.0MHz, 15kHz

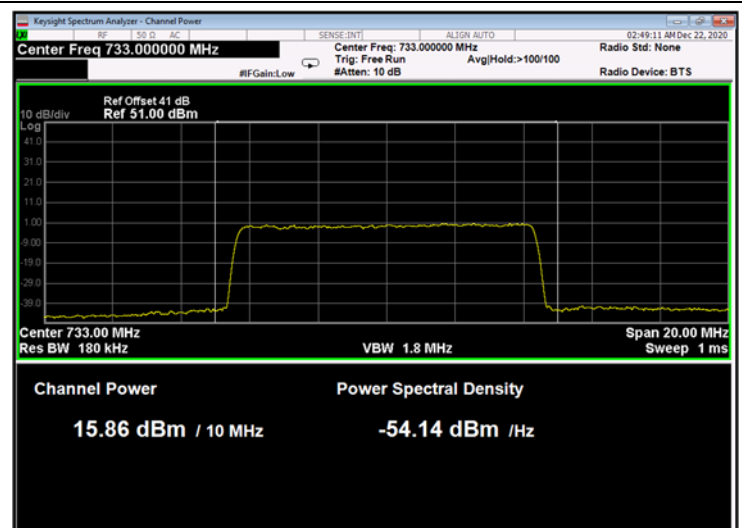

Figure 49: 64QAM 10MHz B.W.; 733.0MHz, 30kHz

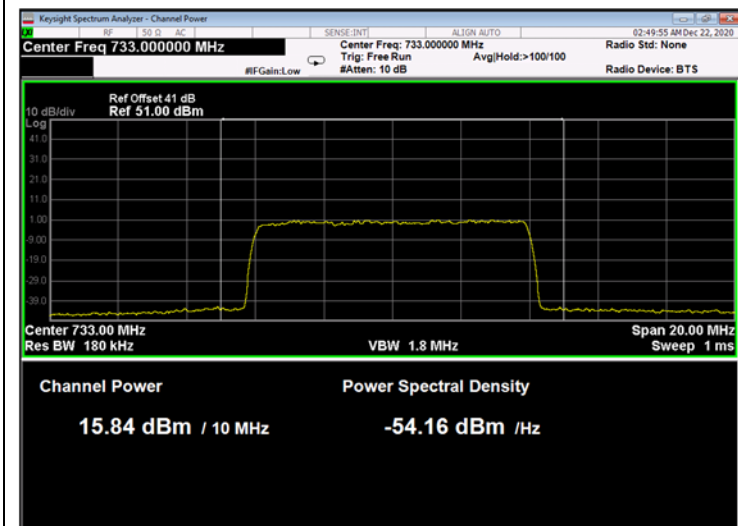

Figure 50: 64QAM 10MHz B.W.; 733.0MHz, 60kHz

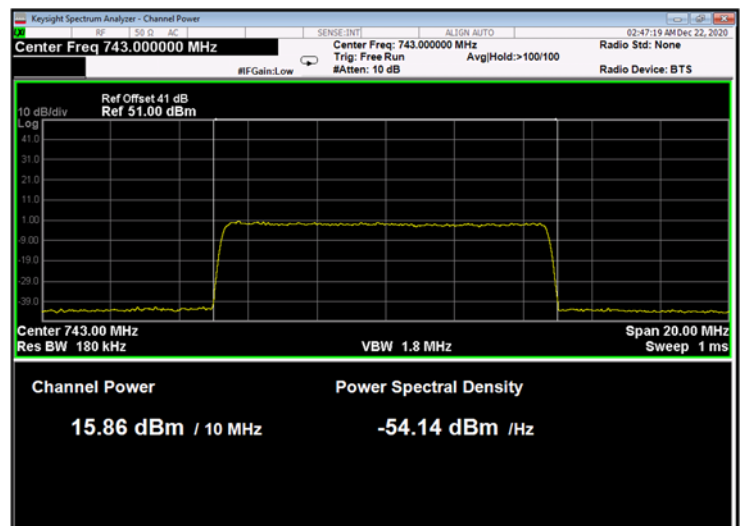

Figure 51: 64QAM 10MHz B.W.; 743.0MHz, 15kHz

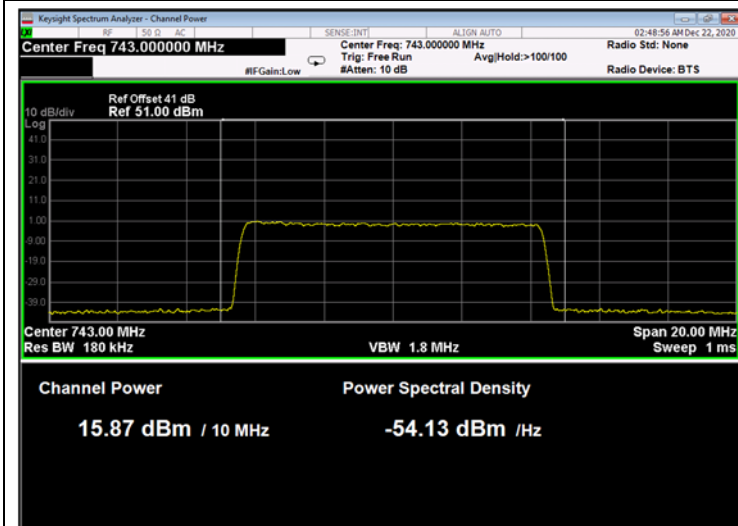

Figure 52: 64QAM 10MHz B.W.; 743.0MHz, 30kHz

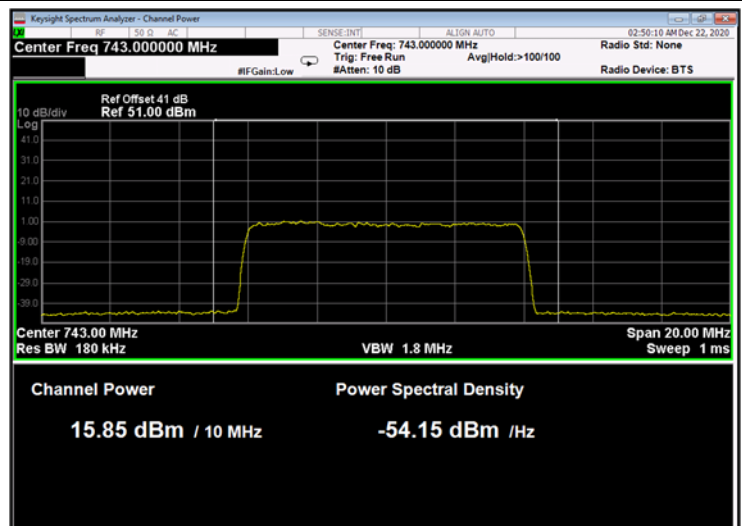

Figure 53: 64QAM 5MHz B.W.; 743.0MHz, 60kHz

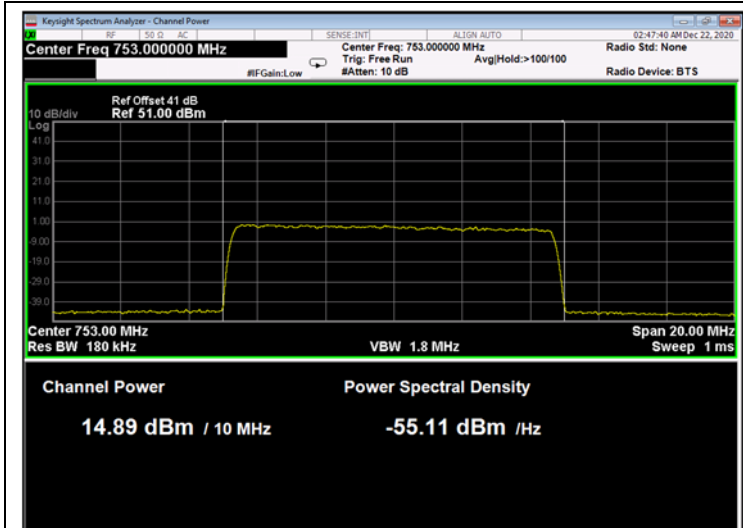

Figure 54: 64QAM 10MHz B.W.; 753.0MHz, 15kHz

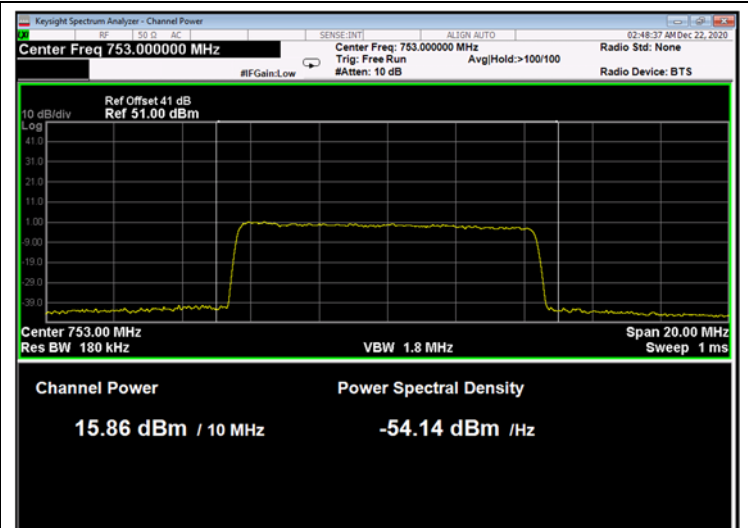

Figure 55: 64QAM 10MHz B.W.; 753.0MHz, 30kHz

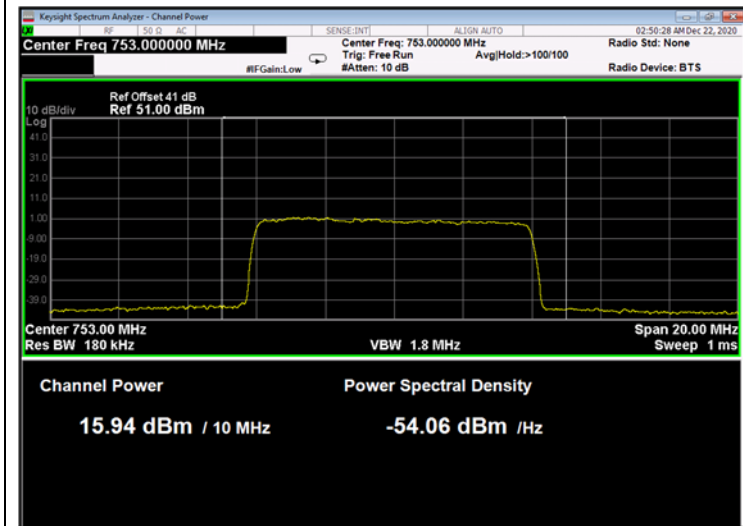

Figure 56: 64QAM 10MHz B.W.; 753.0MHz, 60kHz

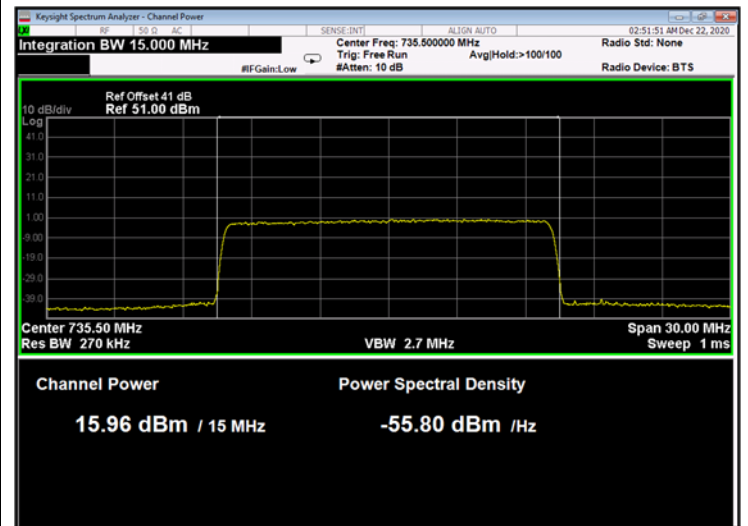

Figure 57: 64QAM 15MHz B.W.; 735.5MHz, 15kHz

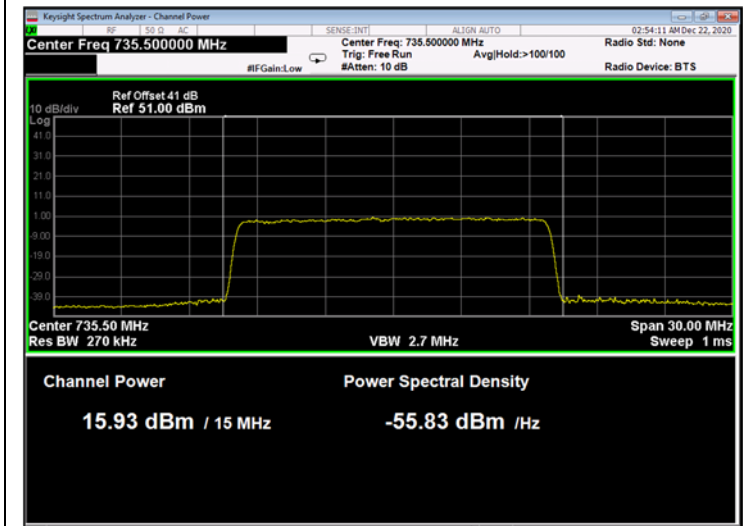

Figure 58: 64QAM 15MHz B.W.; 735.5MHz, 30kHz

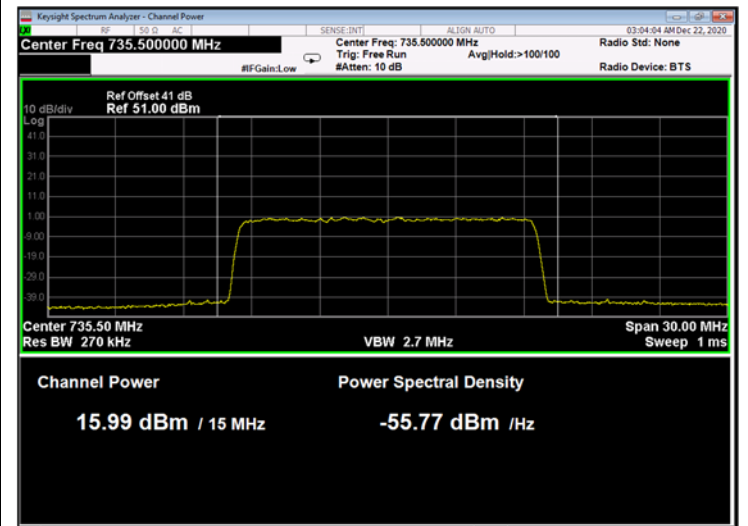

Figure 59: 64QAM 15MHz B.W.; 735.5MHz, 60kHz

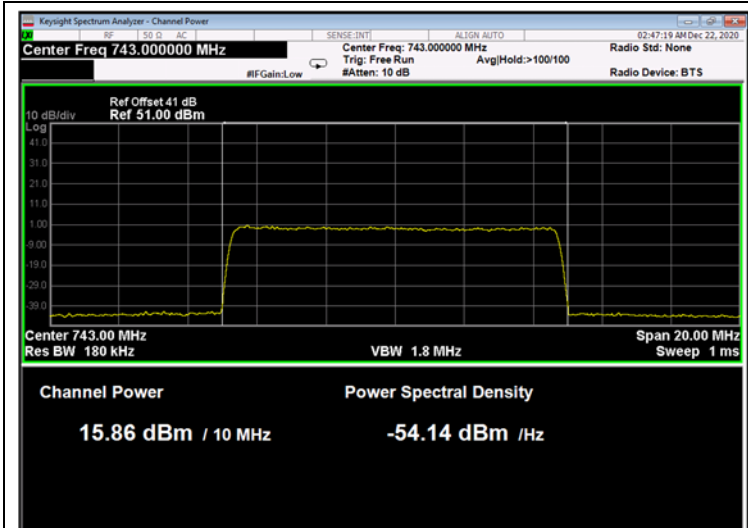

Figure 60: 64QAM 15MHz B.W.; 743.0MHz, 15kHz

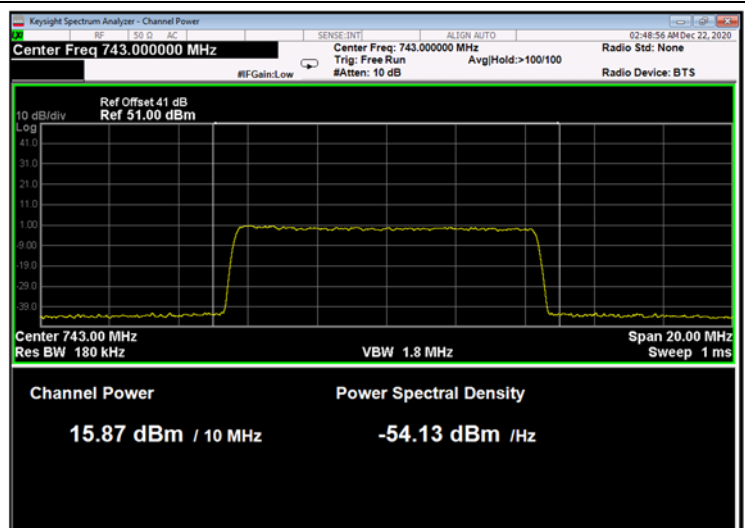

Figure 61: 64QAM 15MHz B.W.; 743.0MHz, 30kHz

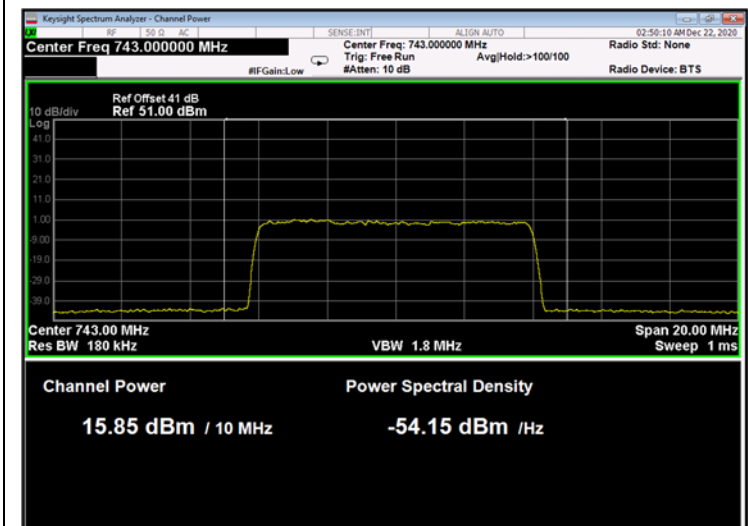

Figure 62: 64QAM 15MHz B.W.; 743.0MHz, 60kHz

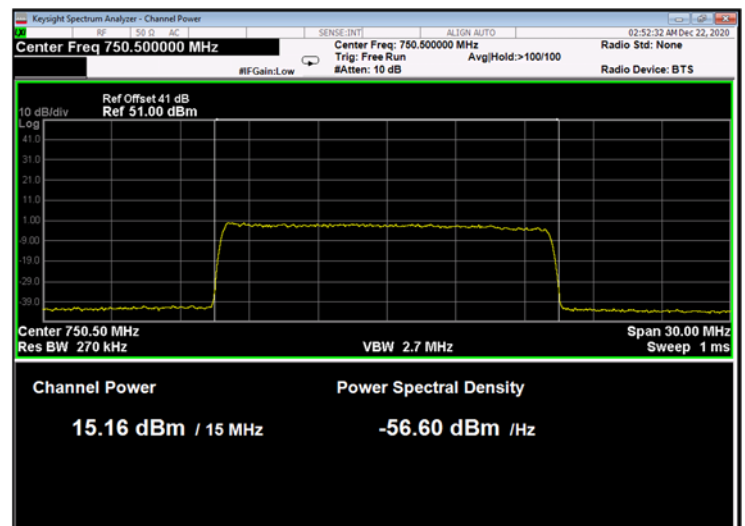

Figure 63: 64QAM 15MHz B.W.; 750.5MHz, 15kHz

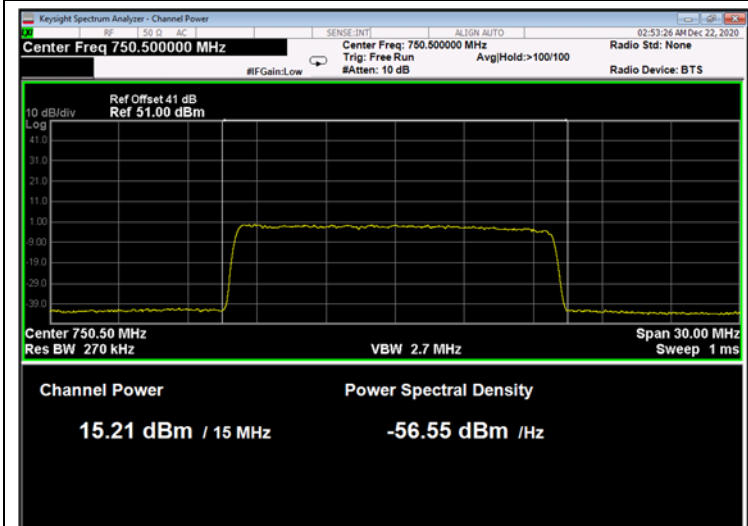

Figure 64: 64QAM 15MHz B.W.; 750.5MHz, 30kHz

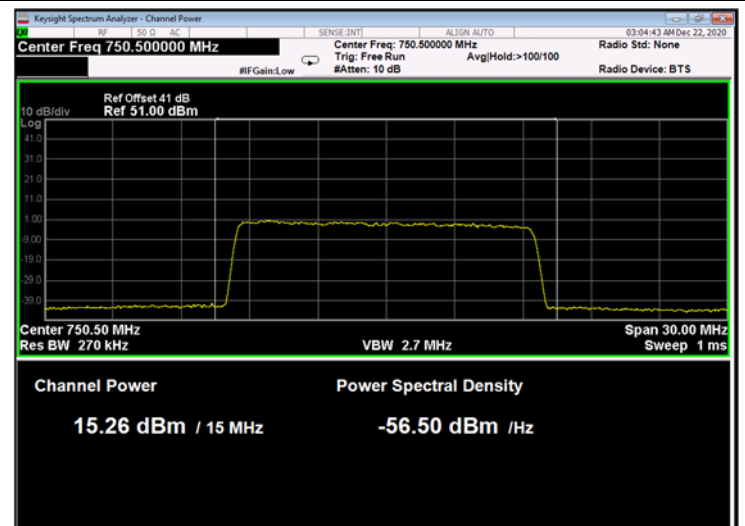

Figure 65: 64QAM 15MHz B.W.; 750.5MHz, 60kHz

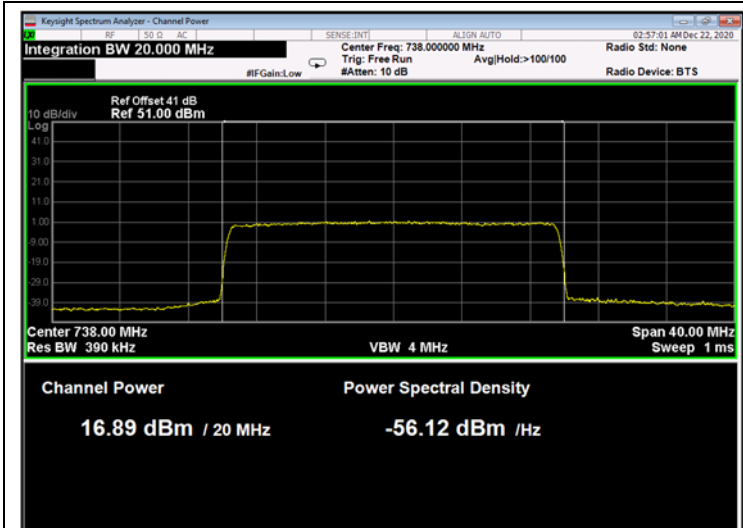

Figure 66: 64QAM 20MHz B.W.; 738.0MHz, 15kHz

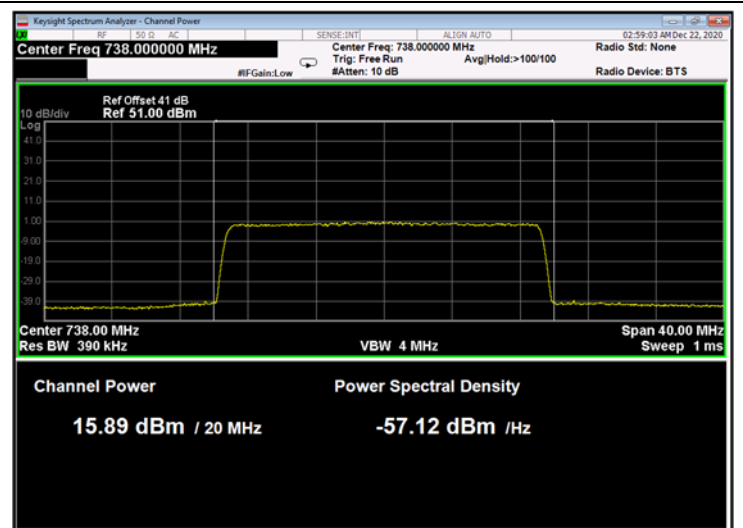

Figure 67: 64QAM 20MHz B.W.; 738.0MHz, 30kHz

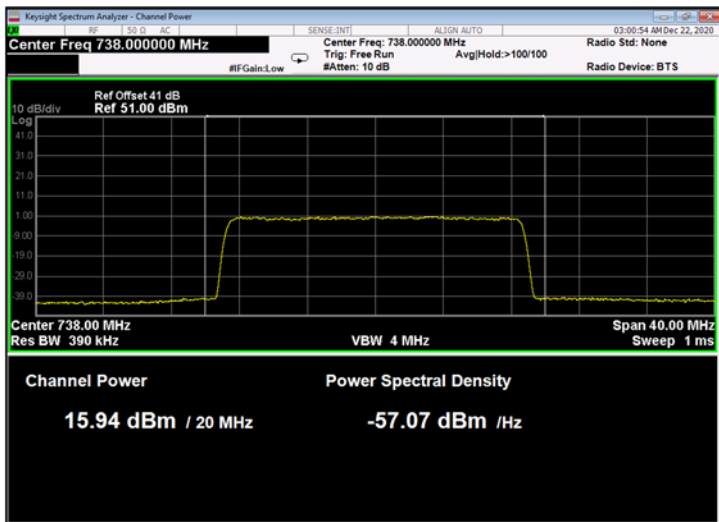

Figure 68: 64QAM 20MHz B.W.; 738.0MHz, 60kHz

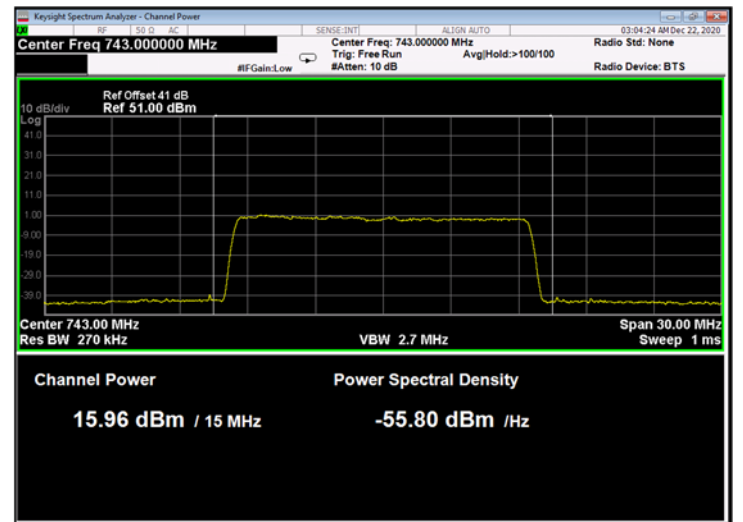

Figure 69: 64QAM 20MHz B.W.; 743.0MHz, 15kHz

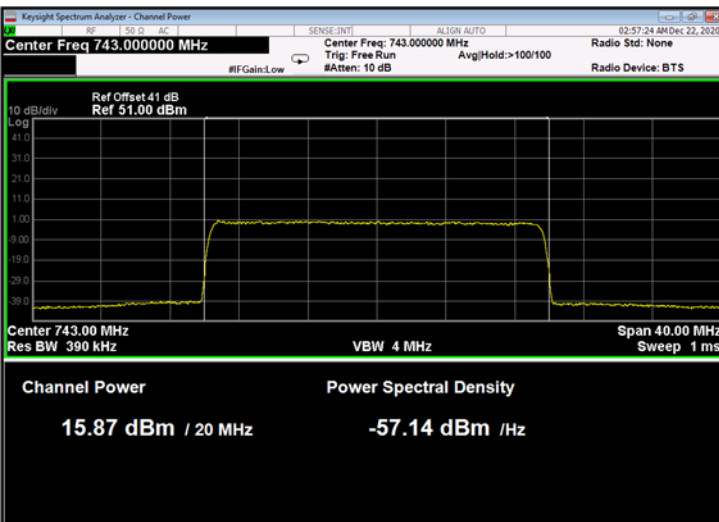

Figure 70: 64QAM 20MHz B.W.; 743.0MHz, 30kHz

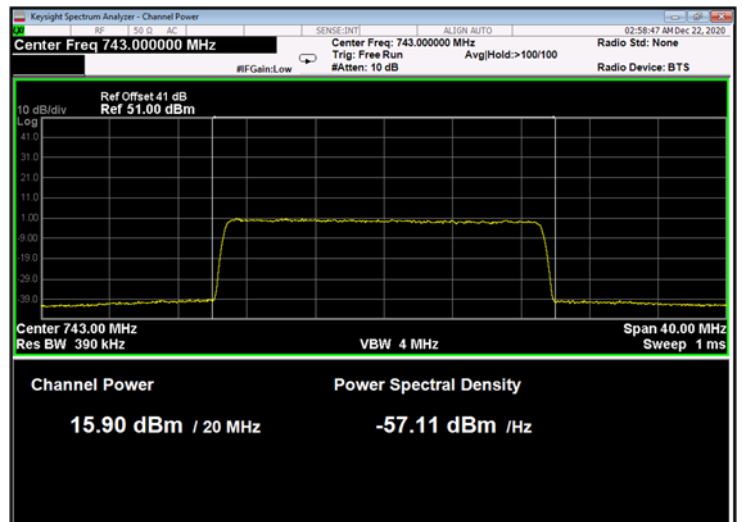

Figure 71: 64QAM 20MHz B.W.; 743.0MHz, 60kHz

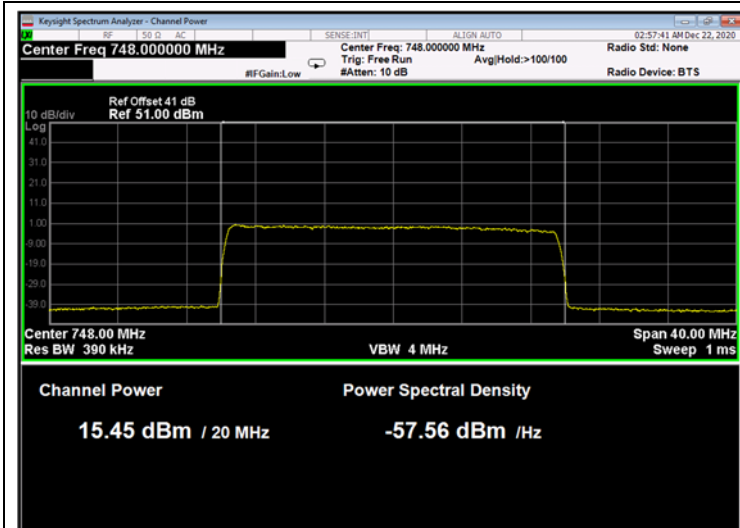

Figure 72: 64QAM 20MHz B.W.; 748.0MHz, 15kHz

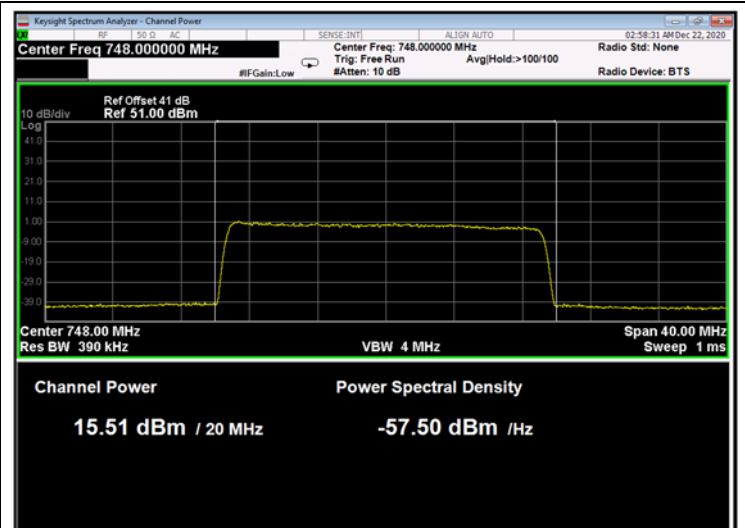

Figure 73: 64QAM 20MHz B.W.; 748.0MHz, 30kHz

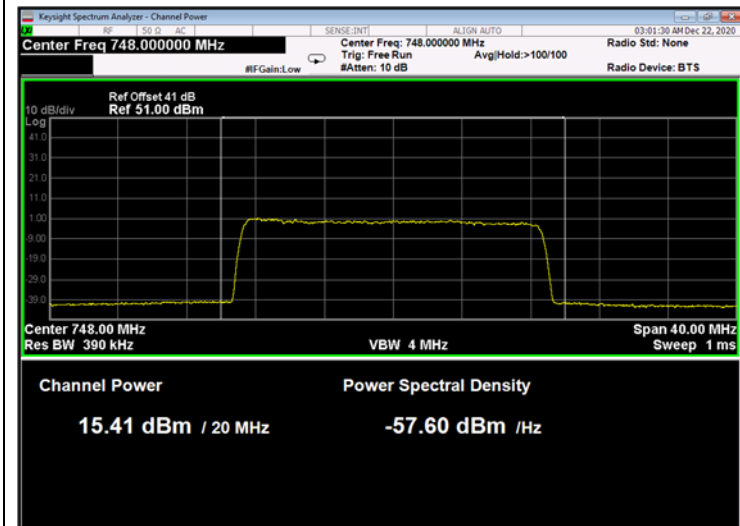

Figure 74: 64QAM 20MHz B.W.; 748.0MHz, 60kHz

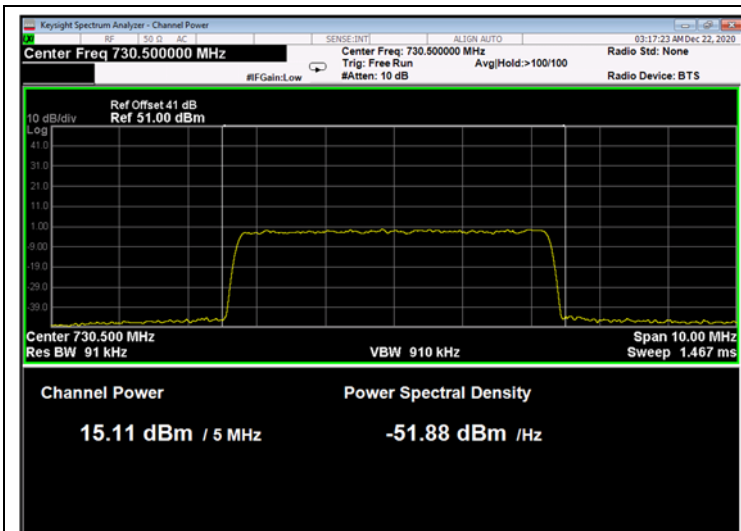

Figure 75: 256QAM 5MHz B.W.; 730.5MHz, 15kHz

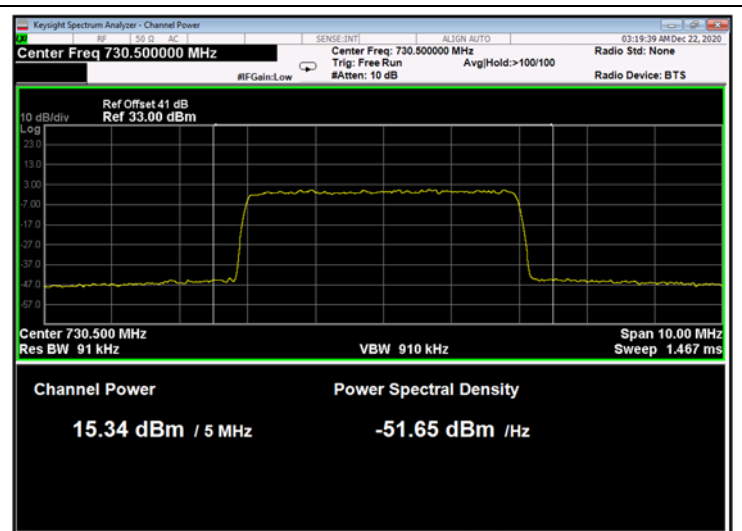

Figure 76: 256QAM 5MHz B.W.; 730.5MHz, 30kHz

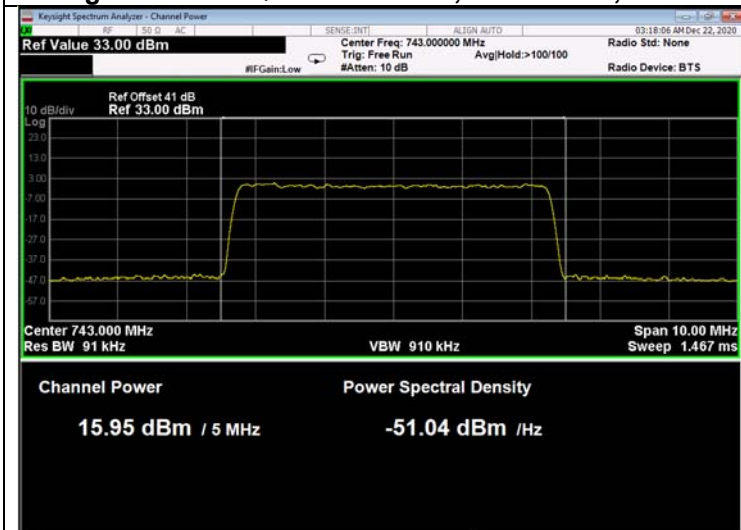

Figure 77: 256QAM 5MHz B.W.; 743.0MHz, 15kHz

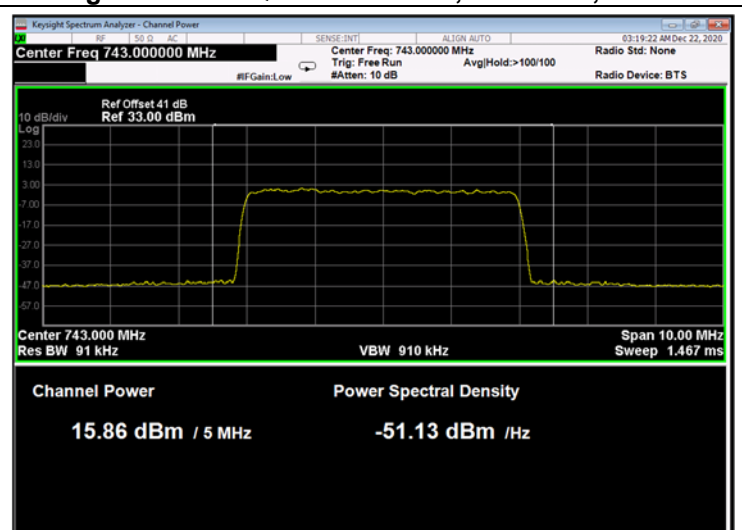

Figure 78: 256QAM 5MHz B.W.; 743.0MHz, 30kHz

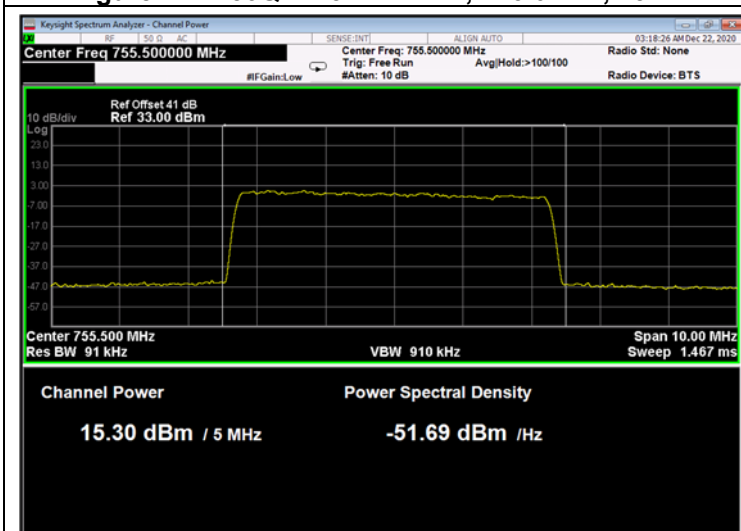

Figure 79: 256QAM 5MHz B.W.; 755.5MHz, 15kHz

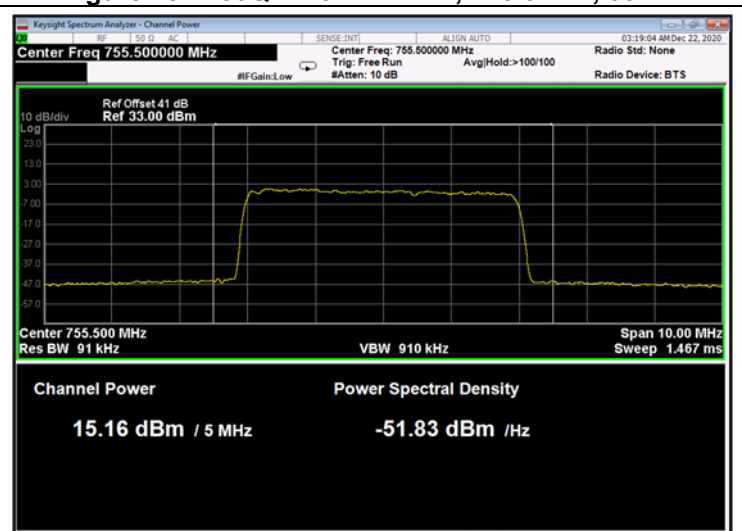

Figure 80: 256QAM 5MHz B.W.; 755.5MHz, 30kHz