

Nemko Korea Co., Ltd.

(Designation Number : KR0026)

155 & 159, Osan-Ro, Mohyeon-Eup, Cheoin-Gu, Yongin-Si, Gyeonggi-Do 16885 KOREA, REPUBLIC OF
TEL : + 82 31 330 1700 FAX : + 82 31 322 2332

FCC EVALUATION REPORT FOR VERIFICATION

Applicant :i-SENS, Inc
43, Banpo-daero 28-gil, Seocho-gu,
Seoul 06646, Korea, republic of
Attn : Ms. Dayun LeeDates of Issue : March 15, 2018
Test Report No. : NK-17-E-0848
Test Site : Nemko Korea Co., Ltd.
EMC site, Korea**Model****P/N 200107****Contact Person**43, Banpo-daero 28-gil, Seocho-gu,
Seoul 06646, Korea, republic of
Ms. Dayun Lee
Telephone No. : + 82 2 910 0630Applied Standard : FCC Part 15 Subpart B & Part 2
Classification : FCC Class B Device
EUT Type : Prothrombin Time/INR Monitoring System

The device bearing the brand name and model specified above has been shown to comply with the applicable technical standards as indicated in the measurement report and was tested in accordance with the measurement procedures specified in ANSI C63.4-2014.

I attest to the accuracy of data and all measurements reported herein were performed by me or were made under my supervision and are correct to the best of my knowledge and belief. I assume full responsibility for the completeness of these measurements and vouch for the qualifications of all persons taking them.

 Mar 15, 2018Tested By : Kyoungsoon Lee
Engineer Mar. 15, 2018Reviewed By : Changsoo Choi
Technical Manager

TABLE OF CONTENTS

SCOPE	3
INTRODUCTION (Site Description)	4
TEST CONDITIONS & EUT INFORMATION	5
SUMMARY OF TEST RESULTS	8
RECOMMENDATION / CONCLUSION	8
SAMPLE CALCULATION	8
DESCRIPTION OF TESTS (Conducted Emissions)	9
DESCRIPTION OF TESTS (Radiated Emissions)	10
TEST DATA (Conducted Emissions)	11
TEST DATA (Radiated Emissions)	22
ACCURACY OF MEASUREMENT	60
LIST OF TEST EQUIPMENT	63
APPENDIX A - SAMPLE LABEL	64
APPENDIX B - PHOTOGRAPHS OF TEST SET-UP	65
APPENDIX C - EUT PHOTOGRAPHS	73
APPENDIX D - BLOCK DIAGRAM	82
APPENDIX E - USER'S MANUAL	83
APPENDIX F - SCHEMATIC DIAGRAM	84

SCOPE

Measurement and determination of electromagnetic emissions (EME) of radio frequency devices including intentional and/or unintentional radiators for compliance with the technical rules and regulations of the Federal Communications Commission under FCC part 15.

Responsible Party :	i-SENS, Inc
Contact Person :	Ms. Dayun Lee Tel No.: + 82 2 910 0630
Manufacturer :	i-SENS, Inc 43, Banpo-daero 28-gil, Seocho-gu, Seoul 06646, Korea, republic of

- Model: P/N 200107
- EUT Type: Prothrombin Time/INR Monitoring System
- Electric Rating: Rechargeable Lithium polymer battery (3.7 V, 2350mAh)
Switching Power Adaptor: Input a.c. (100-240) V, 50 Hz and 60 Hz, 0.5 A
Output d.c. 5 V, 2.0 A Max.
- Test Voltage: ① a.c. 120 V, 60 Hz ② d.c. 3.7 V
- I/O Port: USB(2 EA), Ethernet(1 EA)
- Clock: 528 MHz
- Classification: FCC Class B Device
- Applied Standard: FCC Part 15 Subpart B & Part 2
- Test Procedure(s): ANSI C63.4 (2014)
- Dates of Test: December 06, 2017 to February 12, 2018
- Place of Tests: Nemko Korea Co., Ltd. EMC Site
- Test Report No.: NK-17-E-0848

INTRODUCTION

The measurement procedure described in American National Standard for Methods of Measurement of Radio-Noise Emissions from Low-Voltage Electrical and Electronic Equipment in the Range of 9 kHz to 40 GHz (ANSI C63.4-2014) was used in determining radiated and conducted emissions emanating from **I-SENS, Inc**

MODEL : **P/N 200107, Prothrombin Time/INR Monitoring System.**

These measurement tests were conducted at **Nemko Korea Co., Ltd. EMC Laboratory.**

The site address is 155 & 159, Osan-Ro, Mohyeon-Eup, Cheoin-Gu, Yongin-Si, Gyeonggi-Do 16885 KOREA, REPUBLIC OF

The area of Nemko Korea Corporation Ltd. EMC Test Site is located in a mountain area at 80 kilometers (48 miles) southeast and Incheon International Airport (Incheon Airport), 30 kilometers (18 miles) south-southeast from central Seoul.

The Nemko Korea Co., Ltd. has been accredited as a Conformity Assessment Body (CAB).



Nemko Korea Co., Ltd.
155 & 159, Osan-Ro, Mohyeon-Eup,
Cheoin-Gu, Yongin-Si, Gyeonggi-Do
16885 KOREA, REPUBLIC OF
Tel) + 82 31 330 1700
Fax) + 82 31 322 2332

Fig. 1. The map above shows the Seoul in Korea vicinity area.

The map also shows Nemko Korea Corporation Ltd. EMC Lab and Incheon Airport.

TEST CONDITIONS & EUT INFORMATION

Operating During Test

- ① WiFi 2.4 GHz mode
- ② WiFi 5 GHz mode
- ③ BLE mode
- ④ NFC mode
- ⑤ Charge mode

Support Equipment

Prothrombin Time/INR Monitoring System (EUT)	i-SENS, Inc Model : P/N 200107 Direct USB 1.1 m shielded USB cable 3.0 m unshielded Ethernet cable	FCC Verification S/N : N/A
Switching Power Adaptor	DONGGUAN SHILONG FUHUA ELECTRONICS CO., LTD Model : UES12LCP-050200SPA 1.8 m unshielded Power cable	S/N : UE180111HKYC1-R
Laptop Computer	Samsung Electronics Co., Ltd. Model : NT500R5W	S/N : N/A
AC ADAPTER	Chicony Power Technology(SUZHOU) co., Ltd Model : A13-040N2A	S/N : N/A
USB Flash Drive	Gigastone	S/N : N/A
Access Point	ipTIME Model : A104R	S/N : N/A
Adapter	Zioncom Electronics (Shenzhen) Ltd. Model : DCP005C09080K	S/N : N/A

Component List

Item	Model	Manufacturer	Serial Number
Main Board	Coag-Sense PT2 0-V1 0 5	i-SENS, Inc. / Korea	N/A
Battery	JHY854360G	Shen Zhen Science & Technology Co., LTD. / China	N/A
NFC Antenna	N/A	SKYWORKS / Korea	N/A
WiFi BLE Module	Sterling-LWB-5	Laird Technologies / USA	N/A

Setup Drawing

[Configuration 1 (WiFi 2.4 GHz mode, WiFi 5 GHz mode, BLE mode, NFC mode)]

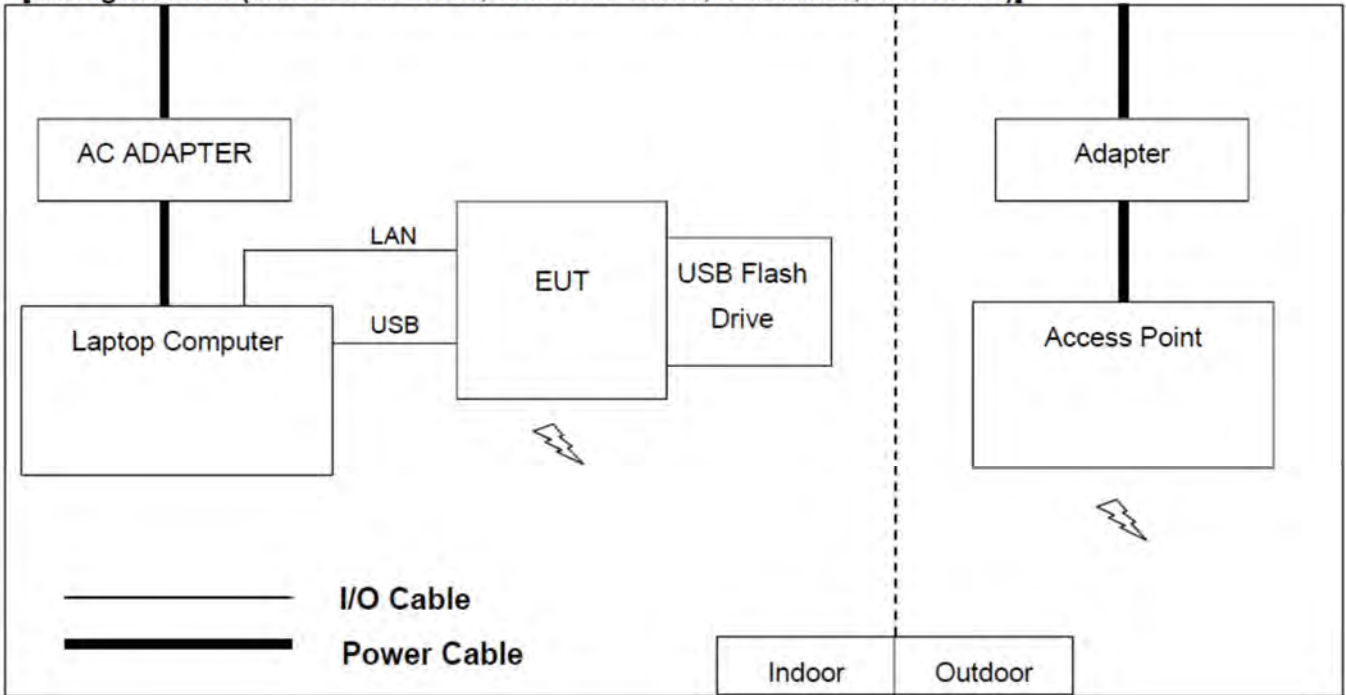

[Configuration 2 (Charge mode)]

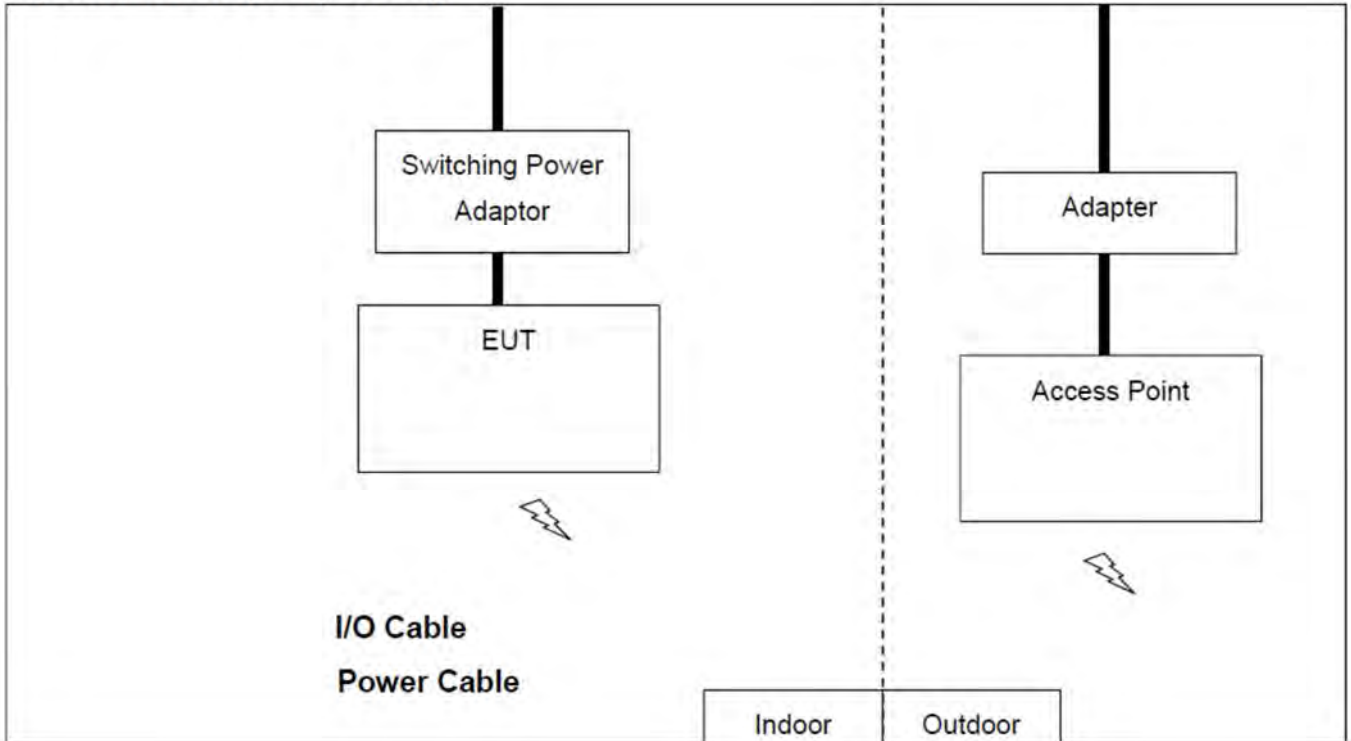

[Configuration 3 (Measurement mode (without I/O port))]

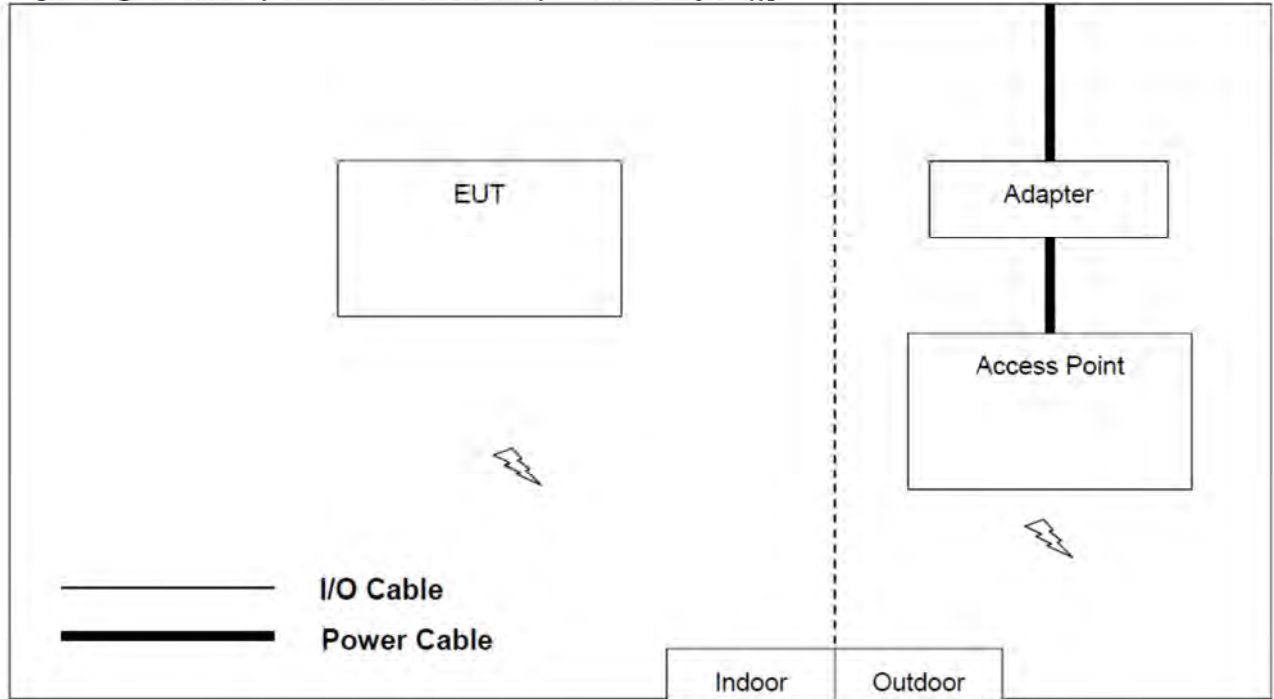

SUMMARY OF TEST RESULTS

The EUT has been tested according to the following specification:

Name of Test	Paragraph No.	Result	Remark
Conducted Emission	15.107(a)	Complies	
Radiated Emission	15.109(g)	Complies	Below 1 GHz
Radiated Emission	15.109(a)	Complies	Above 1 GHz

RECOMMENDATION/CONCLUSION

The data collected shows that the **I-SENS, Inc**

MODEL : P/N 200107, Prothrombin Time/INR Monitoring System

The highest emission observed was at **0.15 MHz** for conducted emissions with a QP margin of **10.7 dB**, at **219.37 MHz** for radiated emissions with a QP margin of **4.11 dB**.

SAMPLE CALCULATION

$$\text{dB } \mu\text{V} = 20 \log_{10} (\mu\text{V}/\text{m})$$

$$\mu\text{V} = 10^{(\text{dB } \mu\text{V}/20)}$$

EX. 1.

@165.0 MHz

Class B limit = 30.0 dB $\mu\text{V}/\text{m}$

Reading = 38.2 dB μV (calibrated level)

Antenna factor + Cable Loss + Amplifier Gain = -12.9 dB

Total = 25.30 dB $\mu\text{V}/\text{m}$

Margin = 30.0 – 25.30 = 4.70

4.70 dB below the limit

DESCRIPTION OF TESTS

Conducted Emissions

The Line conducted emission test facility is located inside a 4 x 7 x 2.5 m shielded enclosure.

It is manufactured by EM engineering. The shielding effectiveness of the shielded room is in accordance with MIL-STD-285 or NSA 65-6.

A 1 m x 1.5 m wooden table 0.8 m height is placed 0.4 m away from the vertical wall and 0.5 m away from the side of wall of the shielded room Rohde & Schwarz (ENV216) of the 50 ohm / 50 uH Line Impedance Stabilization Network(LISN) are bonded to the shielded room. The EUT is powered from the Rohde & Schwarz (ENV216) LISN.

Power to the LISN s are filtered by high-current high insertion loss power line filters.

The purpose of filter is to attenuate ambient signal interference and this filter is also bonded to shielded enclosure. All electrical cables are shielded by tinned copper zipper tubing with inner diameter of 1/2 ”.

If d.c. power device, power will be derived from the source power supply it normally will be powered from and this supply lines will be connected to the LISNs,

All interconnecting cables more than 1 m were shortened by non-inductive bundling (serpentine fashion) to a 1 m length.

Sufficient time for EUT, support equipment, and test equipment was allowed in order for them to warm up to their normal operating condition. The RF output of the LISN was connected to the spectrum analyzer to determine the frequency producing the maximum EME from the EUT. The spectrum was scanned from 150 kHz to 30 MHz with 200 ms sweep time.

The frequency producing the maximum level was re-examined using the EMI test receiver. (Rohde & Schwarz ESCI).

The detector functions were set to quasi-peak mode & CISPR average mode.

The bandwidth of receiver was set to 9 kHz. The EUT, support equipment, and interconnecting cables were arranged and manipulated to maximize each EME emission.

Each emission was maximized by; switching power lines; varying the mode of operation or resolution; clock or data exchange speed; scrolling H pattern to the EUT and of support equipment, and powering the monitor from the floor mounted outlet box and computer aux a.c. outlet, if applicable; whichever determined the worst case emission.

Each EME reported was calibrated using the R&S signal generator.

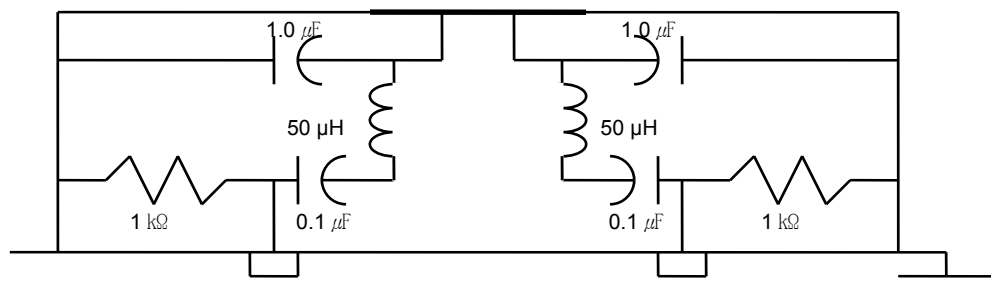

Fig. 2. LISN Schematic Diagram

DESCRIPTION OF TESTS

Radiated Emissions

Measurement were made indoors at 10 m & 3 m using antenna, signal conditioning unit and EMI test receiver to determine the frequency producing the maximum EME.

Appropriate precaution was taken to ensure that all EME from the EUT were maximized and investigated. The Technology configuration, clock speed, mode of operation or video resolution, turntable azimuth with respect to the antenna was note for each frequency found.

The test receiver was scanned from 30 MHz to 1 000 MHz using TRILOG Broadband Test Antenna (Schwarzbeck, VULB 9163). Above 1 GHz, Double Ridged Broadband Horn Antenna (Schwarzbeck, HF907) was used.

The test equipment was placed on a wooden table.

Sufficient time for the EUT, support equipment, and test equipment was allowed in order for them to warm up to their normal operating condition.

Each frequency found during scan measurements was reexamined and investigated using EMI test receiver (ESW 8 (Below 1 GHz), ESU 40(Above 1 GHz)).

The detector function were set to Quasi-peak and peak, CISPR average mode and the bandwidth of the receiver were set to 120 kHz and 1 MHz depending on the frequency or type of signal.

The EUT support equipment and interconnecting cables were re configured to the setup producing the maximum emission for the frequency and were placed on top of a 0.8 m high non- metallic 1.0 m x 1.5 m table.

The EUT, support equipment and interconnecting cables were re-arranged and manipulated to maximize each EME emission.

The turn table containing the Technology was rotated; the antenna height was varied 1 to 4 meter and stopped at the azimuth or height producing the maximum emission. Each emission was maximized by : switching power lines; varying the mode of operation or resolution; clock or data exchange speed; scrolling H pattern to the EUT and of support equipment, and powering the monitor from the floor mounted outlet box and computer aux a.c. outlet, if applicable; whichever determined the worst case emission.

Each EME reported was calibrated using the R/S signal generator.

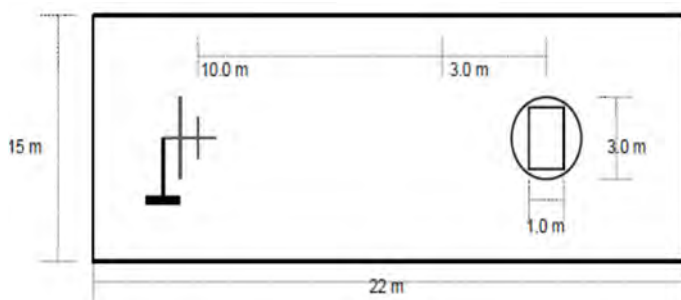

Fig. 3. Dimensions of 10 semi anechoic chamber

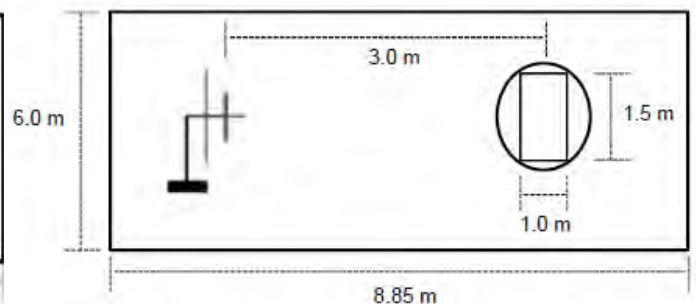
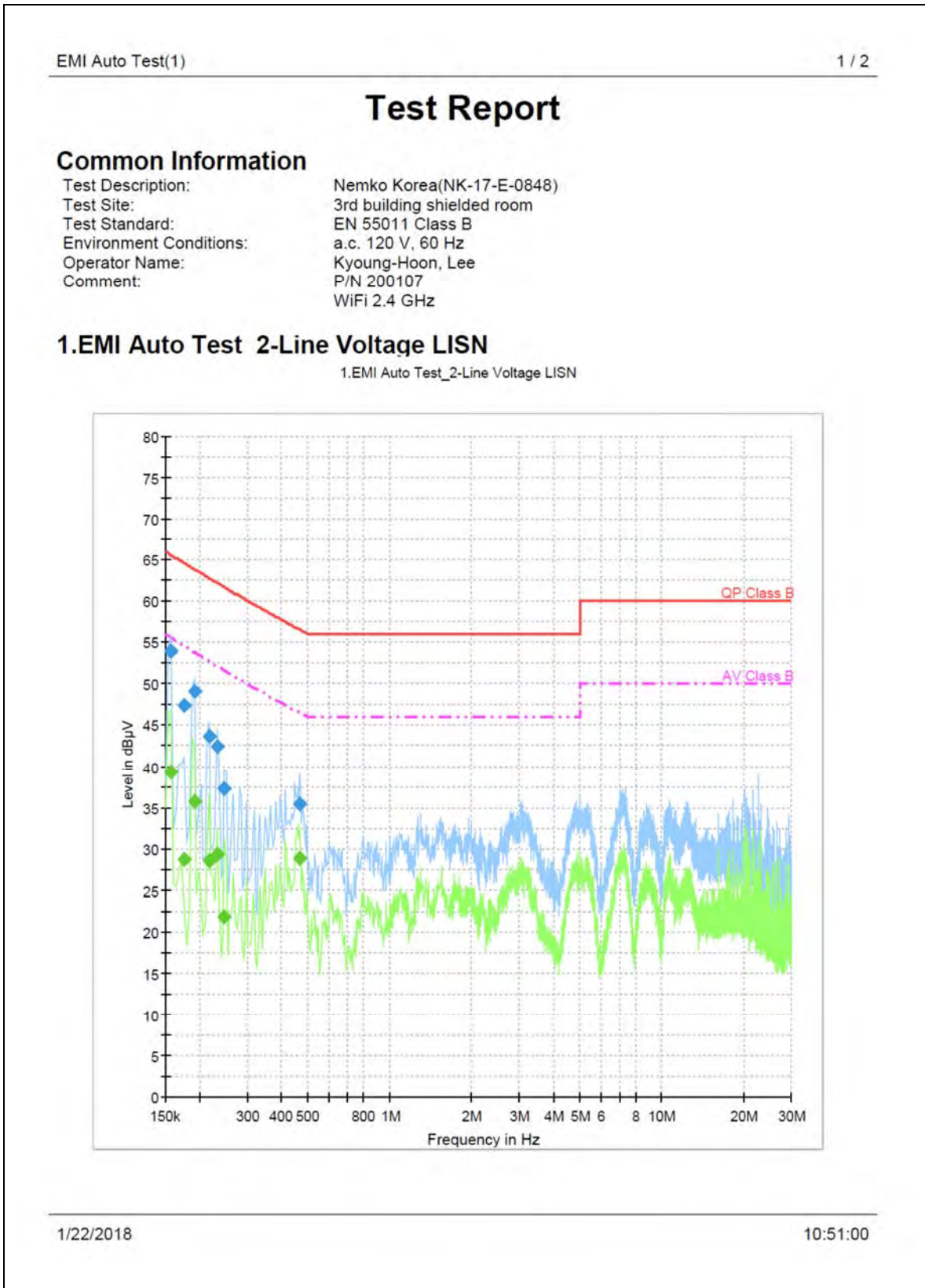

Fig. 4. Dimensions of 3 m full anechoic chamber

TEST DATA

Conducted Emissions

► WiFi 2.4 GHz mode



EMI Auto Test(1)

2 / 2

Final Result 1

Frequency (MHz)	QuasiPeak (dBµV)	Meas. Time (ms)	Bandwidth (kHz)	Filter	Line	Corr. (dB)	Margin (dB)	Limit (dBµV)	Comment
0.157462	54.0	15000.0	9.000	On	L1	9.9	11.6	65.6	
0.176119	47.3	15000.0	9.000	On	L1	10.0	17.2	64.6	
0.191044	49.1	15000.0	9.000	On	L1	10.0	14.8	63.9	
0.217162	43.7	15000.0	9.000	On	L1	9.8	19.0	62.8	
0.232088	42.4	15000.0	9.000	On	N	9.8	19.7	62.2	
0.247012	37.3	15000.0	9.000	On	N	9.7	24.4	61.7	
0.467156	35.4	15000.0	9.000	On	N	10.0	21.2	56.5	

Final Result 2

Frequency (MHz)	CAverage (dBµV)	Meas. Time (ms)	Bandwidth (kHz)	Filter	Line	Corr. (dB)	Margin (dB)	Limit (dBµV)	Comment
0.157462	39.2	15000.0	9.000	On	L1	9.9	16.3	55.6	
0.176119	28.7	15000.0	9.000	On	L1	10.0	25.8	54.6	
0.191044	35.7	15000.0	9.000	On	L1	10.0	18.1	53.8	
0.217162	28.5	15000.0	9.000	On	L1	9.8	24.2	52.7	
0.232088	29.3	15000.0	9.000	On	N	9.8	22.9	52.1	
0.247012	21.9	15000.0	9.000	On	N	9.7	29.7	51.6	
0.467156	28.9	15000.0	9.000	On	N	10.0	17.6	46.5	

1/22/2018

10:51:00

Table 1. Line Conducted Emissions Tabulated Data

► WiFi 5 GHz mode

EMI Auto Test(1)

1 / 2

Test Report

Common Information

Test Description:	Nemko Korea(NK-17-E-0848)
Test Site:	3rd building shielded room
Test Standard:	FCC Part 15 Subpart B Class B
Environment Conditions:	a.c. 120 V, 60 Hz
Operator Name:	Kyoung-Hoon, Lee
Comment:	P/N 200107 WiFi 5.0 GHz

1.EMI Auto Test 2-Line Voltage LISN

1.EMI Auto Test_2-Line Voltage LISN

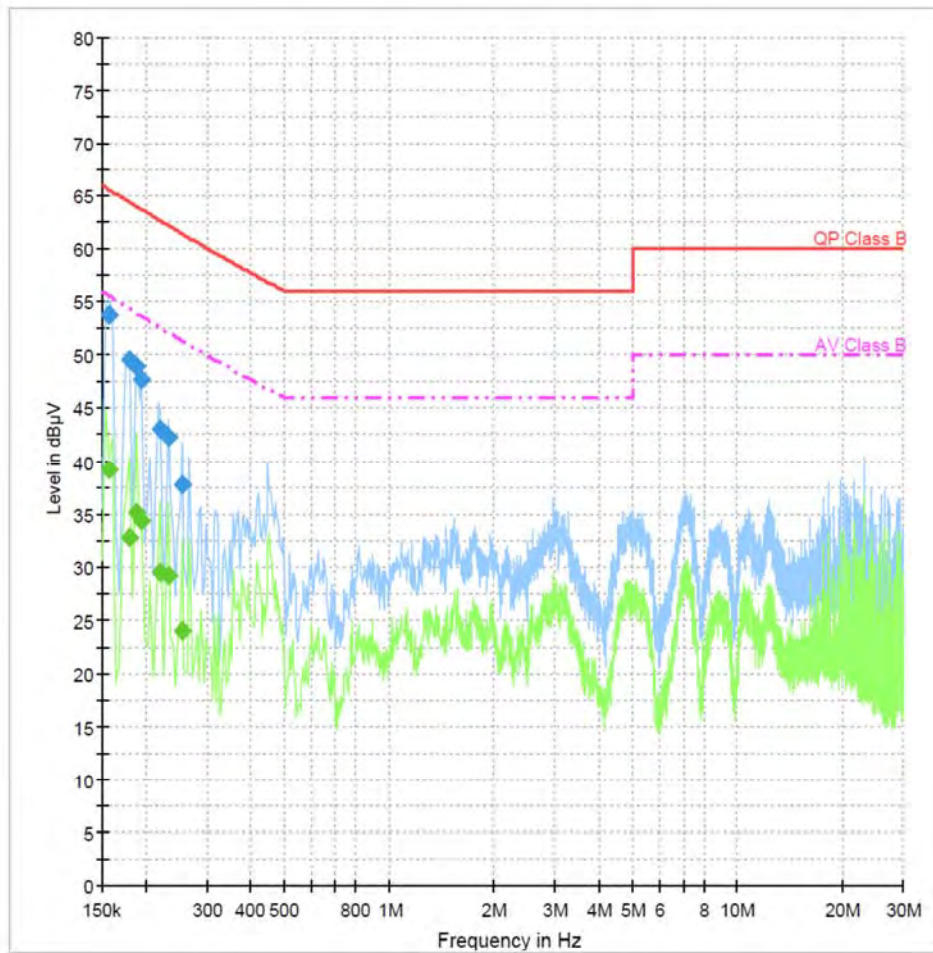

1/22/2018

10:41:23

EMI Auto Test(1)

2 / 2

Final Result 1

Frequency (MHz)	QuasiPeak (dBµV)	Meas. Time (ms)	Bandwidth (kHz)	Filter	Line	Corr. (dB)	Margin (dB)	Limit (dBµV)	Comment
0.157462	53.9	15000.0	9.000	On	N	9.9	11.7	65.6	
0.179850	49.6	15000.0	9.000	On	L1	10.0	14.8	64.4	
0.187312	48.9	15000.0	9.000	On	N	10.0	15.1	64.0	
0.194775	47.7	15000.0	9.000	On	L1	9.9	16.0	63.7	
0.220894	43.0	15000.0	9.000	On	N	9.8	19.6	62.6	
0.232088	42.3	15000.0	9.000	On	N	9.8	19.9	62.2	
0.254475	37.8	15000.0	9.000	On	L1	9.7	23.6	61.4	

Final Result 2

Frequency (MHz)	CAverage (dBµV)	Meas. Time (ms)	Bandwidth (kHz)	Filter	Line	Corr. (dB)	Margin (dB)	Limit (dBµV)	Comment
0.157462	39.2	15000.0	9.000	On	N	9.9	16.4	55.6	
0.179850	32.8	15000.0	9.000	On	L1	10.0	21.6	54.4	
0.187312	35.1	15000.0	9.000	On	N	10.0	18.9	54.0	
0.194775	34.4	15000.0	9.000	On	L1	9.9	19.3	53.7	
0.220894	29.5	15000.0	9.000	On	N	9.8	23.1	52.6	
0.232088	29.2	15000.0	9.000	On	N	9.8	23.0	52.1	
0.254475	23.9	15000.0	9.000	On	L1	9.7	27.4	51.4	

1/22/2018

10:41:23

Table 2. Line Conducted Emissions Tabulated Data

► BLE mode

EMI Auto Test(1)

1 / 2

Test Report

Common Information

Test Description:	Nemko Korea(NK-17-E-0848)
Test Site:	3rd building shielded room
Test Standard:	FCC Part 15 Subpart B Class B
Environment Conditions:	a.c. 120 V, 60 Hz
Operator Name:	Kyoung-Hoon, Lee
Comment:	P/N 200107 BLE Mode

1.EMI Auto Test 2-Line Voltage LISN

1.EMI Auto Test_2-Line Voltage LISN

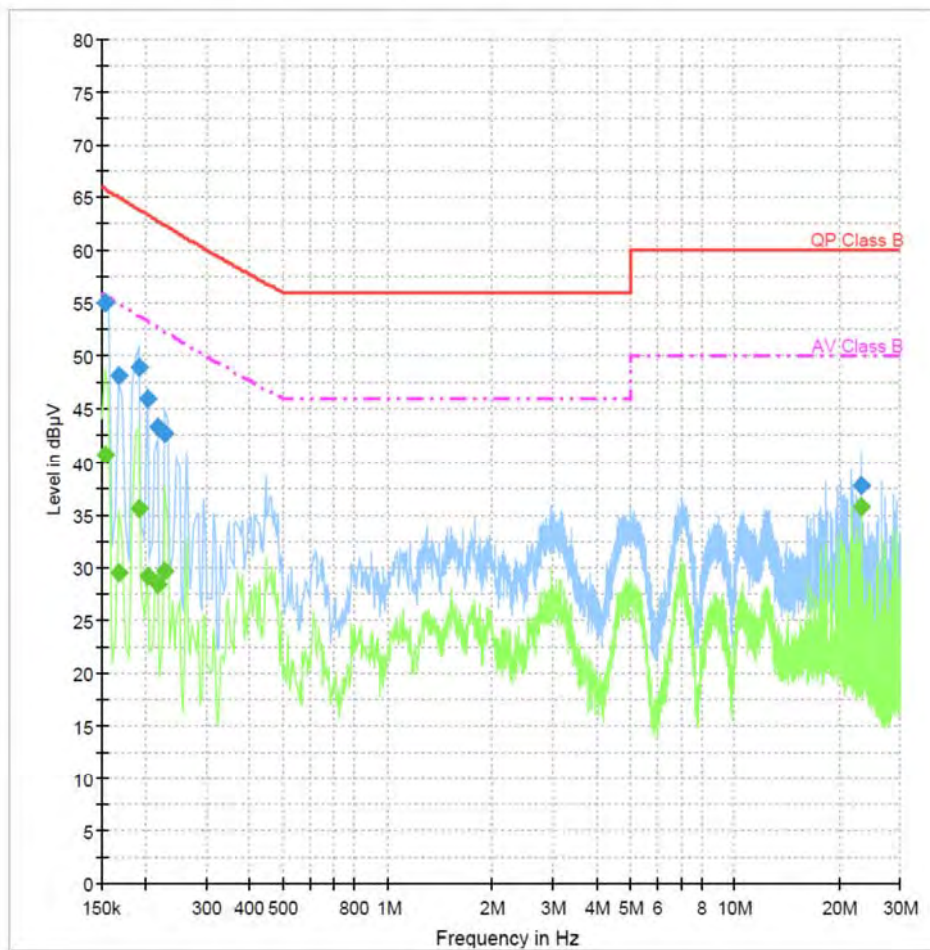

1/22/2018

10:31:06

EMI Auto Test(1)

2 / 2

Final Result 1

Frequency (MHz)	QuasiPeak (dBµV)	Meas. Time (ms)	Bandwidth (kHz)	Filter	Line	Corr. (dB)	Margin (dB)	Limit (dBµV)	Comment
0.153731	55.1	15000.0	9.000	On	L1	9.8	10.7	65.8	
0.168656	48.2	15000.0	9.000	On	L1	10.1	16.8	65.0	
0.191044	49.0	15000.0	9.000	On	N	10.0	14.9	63.9	
0.202238	46.0	15000.0	9.000	On	L1	9.9	17.4	63.4	
0.217162	43.4	15000.0	9.000	On	L1	9.8	19.4	62.8	
0.228356	42.8	15000.0	9.000	On	L1	9.8	19.5	62.3	
23.130769	37.8	15000.0	9.000	On	L1	10.3	22.2	60.0	

Final Result 2

Frequency (MHz)	CAverage (dBµV)	Meas. Time (ms)	Bandwidth (kHz)	Filter	Line	Corr. (dB)	Margin (dB)	Limit (dBµV)	Comment
0.153731	40.6	15000.0	9.000	On	L1	9.8	15.1	55.8	
0.168656	29.5	15000.0	9.000	On	L1	10.1	25.5	54.9	
0.191044	35.6	15000.0	9.000	On	N	10.0	18.2	53.8	
0.202238	29.1	15000.0	9.000	On	L1	9.9	24.2	53.3	
0.217162	28.4	15000.0	9.000	On	L1	9.8	24.3	52.7	
0.228356	29.7	15000.0	9.000	On	L1	9.8	22.6	52.3	
23.130769	35.7	15000.0	9.000	On	L1	10.3	14.3	50.0	

1/22/2018

10:31:06

Table 3. Line Conducted Emissions Tabulated Data

► NFC mode

EMI Auto Test(1)

1 / 2

Test Report

Common Information

Test Description:	Nemko Korea(NK-17-E-0848)
Test Site:	3rd building shielded room
Test Standard:	FCC Part 15 Subpart B Class B
Environment Conditions:	a.c. 120 V, 60 Hz
Operator Name:	Kyoung-Hoon, Lee
Comment:	P/N 200107 NFC Mode

1.EMI Auto Test 2-Line Voltage LISN

1.EMI Auto Test_2-Line Voltage LISN

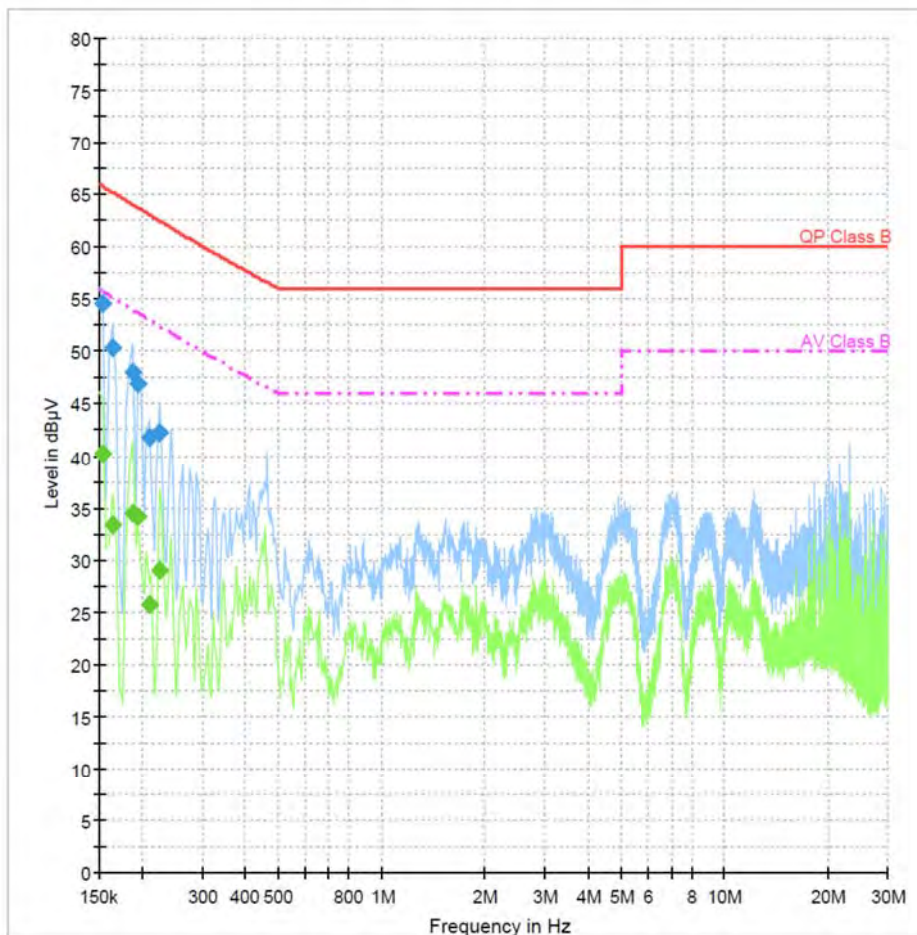

1/22/2018

10:19:05

EMI Auto Test(1)

2 / 2

Final Result 1

Frequency (MHz)	QuasiPeak (dBµV)	Meas. Time (ms)	Bandwidth (kHz)	Filter	Line	Corr. (dB)	Margin (dB)	Limit (dBµV)	Comment
0.153731	54.6	15000.0	9.000	On	L1	9.8	11.2	65.8	
0.164925	50.3	15000.0	9.000	On	L1	10.0	14.9	65.2	
0.187312	48.0	15000.0	9.000	On	L1	10.0	16.0	64.0	
0.194775	47.0	15000.0	9.000	On	L1	9.9	16.7	63.7	
0.209700	41.8	15000.0	9.000	On	N	9.9	21.2	63.1	
0.224625	42.2	15000.0	9.000	On	L1	9.8	20.2	62.5	

Final Result 2

Frequency (MHz)	CAverage (dBµV)	Meas. Time (ms)	Bandwidth (kHz)	Filter	Line	Corr. (dB)	Margin (dB)	Limit (dBµV)	Comment
0.153731	40.2	15000.0	9.000	On	L1	9.8	15.6	55.8	
0.164925	33.4	15000.0	9.000	On	L1	10.0	21.8	55.1	
0.187312	34.5	15000.0	9.000	On	L1	10.0	19.5	54.0	
0.194775	34.2	15000.0	9.000	On	L1	9.9	19.5	53.7	
0.209700	25.7	15000.0	9.000	On	N	9.9	27.3	53.0	
0.224625	28.9	15000.0	9.000	On	L1	9.8	23.5	52.4	

1/22/2018

10:19:05

Table 4. Line Conducted Emissions Tabulated Data

► Charge mode

EMI Auto Test(3)

1 / 2

Test Report

Common Information

Test Description:	Conducted emission (NK-17-E-0848)
Test Site:	3rd building shielded room
Test Standard:	FCC Part 15 Subpart B Class B
Environment Conditions:	a.c. 120 V, 60 Hz
Operator Name:	Kyoung-Hoon, Lee
Comment:	P/N 200107 Charge Mode

1.EMI Auto Test 2-Line Voltage LISN

1.EMI Auto Test_2-Line Voltage LISN

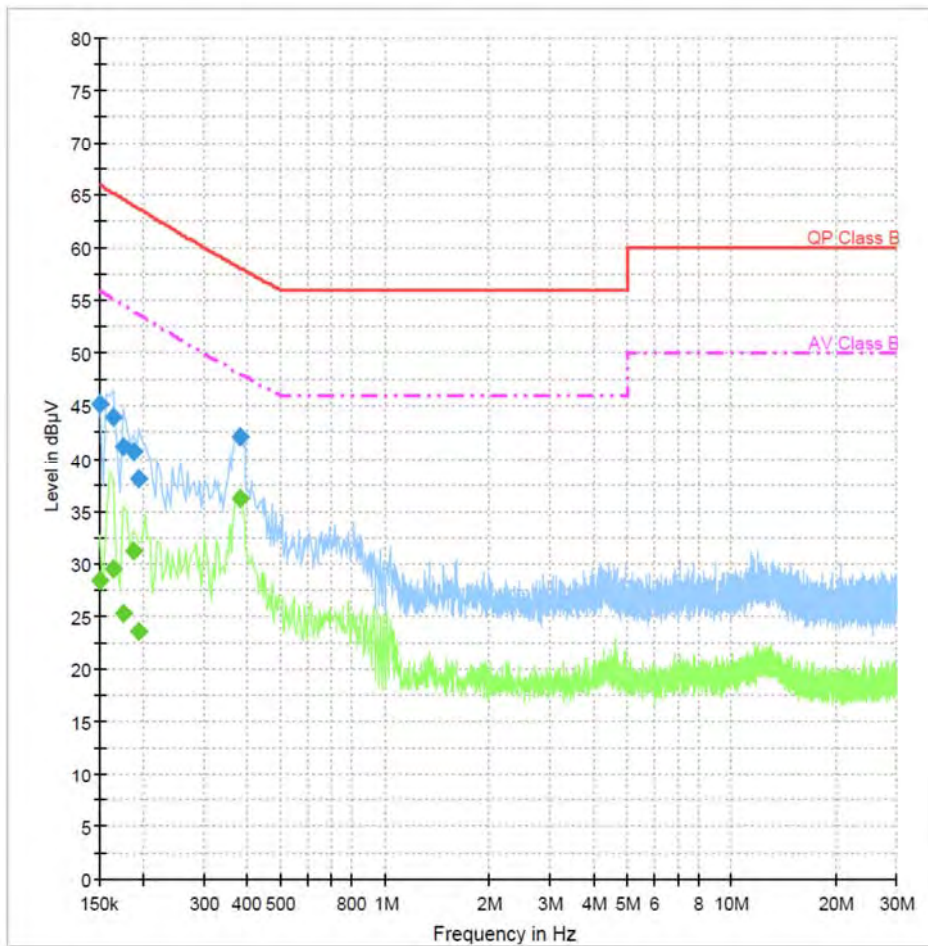

2/7/2018

1:16:43

EMI Auto Test(3)

2 / 2

Final Result 1

Frequency (MHz)	QuasiPeak (dBµV)	Meas. Time (ms)	Bandwidth (kHz)	Filter	Line	Corr. (dB)	Margin (dB)	Limit (dBµV)	Comment
0.150000	45.2	15000.0	9.000	On	L1	9.8	20.8	66.0	
0.164925	44.1	15000.0	9.000	On	L1	10.0	21.1	65.2	
0.176119	41.2	15000.0	9.000	On	L1	10.0	23.3	64.6	
0.187312	40.7	15000.0	9.000	On	N	10.0	23.4	64.0	
0.194775	38.0	15000.0	9.000	On	L1	9.9	25.7	63.7	
0.381338	42.1	15000.0	9.000	On	N	9.9	16.0	58.1	

Final Result 2

Frequency (MHz)	CAverage (dBµV)	Meas. Time (ms)	Bandwidth (kHz)	Filter	Line	Corr. (dB)	Margin (dB)	Limit (dBµV)	Comment
0.150000	28.4	15000.0	9.000	On	L1	9.8	27.6	56.0	
0.164925	29.5	15000.0	9.000	On	L1	10.0	25.6	55.1	
0.176119	25.2	15000.0	9.000	On	L1	10.0	29.4	54.6	
0.187312	31.2	15000.0	9.000	On	N	10.0	22.8	54.0	
0.194775	23.6	15000.0	9.000	On	L1	9.9	30.1	53.7	
0.381338	36.1	15000.0	9.000	On	N	9.9	11.9	48.1	

2/7/2018

1:16:43

Table 5. Line Conducted Emissions Tabulated Data

NOTES:

- 1. Measurements using CISPR quasi-peak mode & average mode.**
- 2. All modes of operation were investigated and the worst -case emission are reported.
See attached Plots.**
- 3. LINE : L1 = Line , N = Neutral**
- 4. The limit for Class B device is on the FCC Part section 15.107(a).**



Tested by: Kyoungsoon Lee

TEST DATA

Radiated Emissions (Below 1 GHz)

► WiFi 2.4 GHz mode

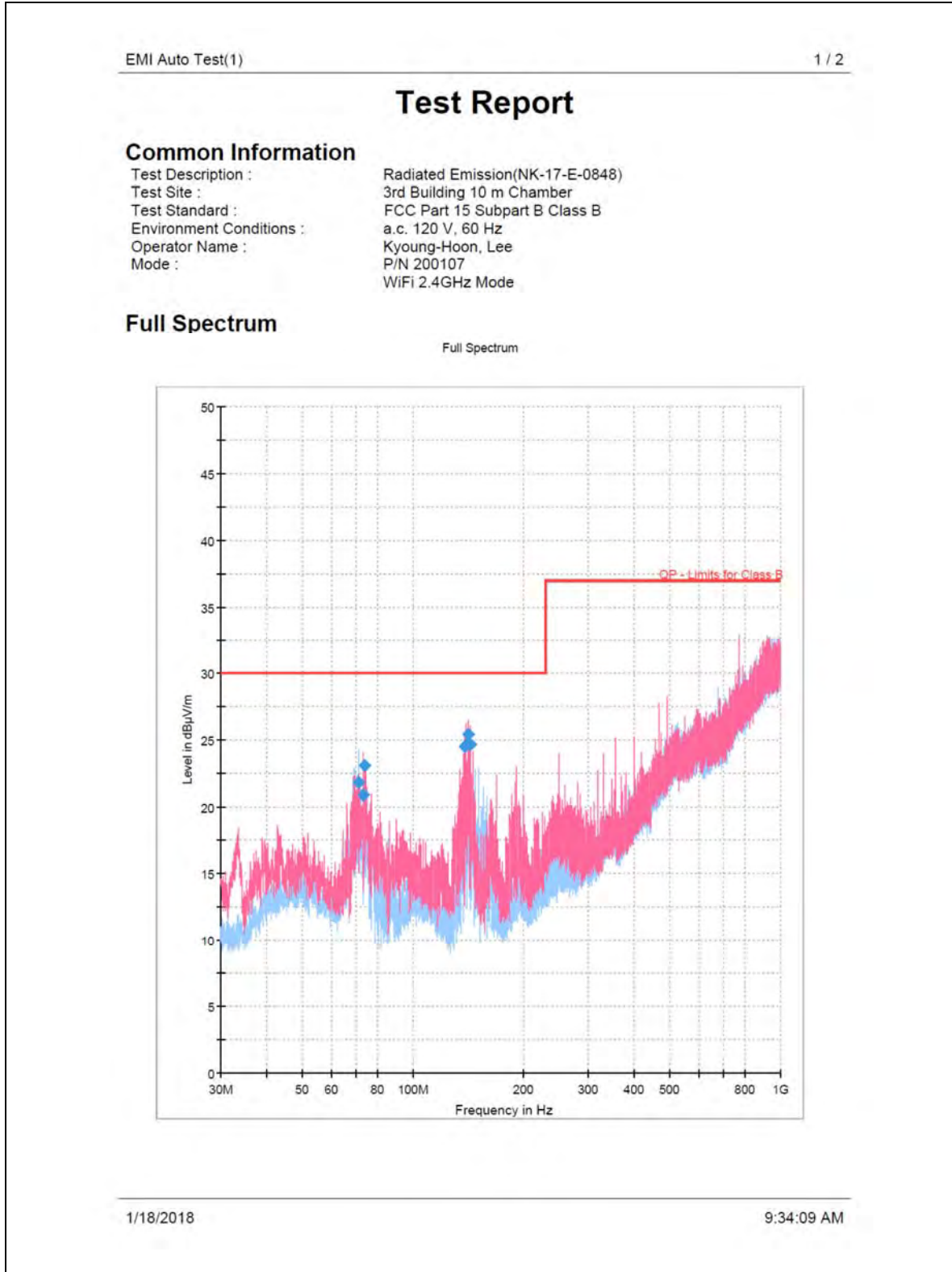

EMI Auto Test(1)

2 / 2

Final Result

Frequency (MHz)	QuasiPeak (dBµV/m)	Limit (dBµV/m)	Margin (dB)	Meas. Time (ms)	Bandwidth (kHz)	Height (cm)	Pol	Azimuth (deg)	Corr. (dB)
71.128000	21.79	30.00	8.21	15000.0	120.000	377.0	H	146.0	-25.6
73.132667	20.86	30.00	9.14	15000.0	120.000	202.0	V	268.0	-26.2
73.714667	23.07	30.00	6.93	15000.0	120.000	202.0	V	279.0	-26.4
138.381333	24.52	30.00	5.48	15000.0	120.000	107.0	V	224.0	-25.7
139.189667	24.54	30.00	5.46	15000.0	120.000	130.0	V	-10.0	-25.8
141.194333	25.45	30.00	4.55	15000.0	120.000	130.0	V	236.0	-25.8
143.296000	24.67	30.00	5.33	15000.0	120.000	107.0	V	237.0	-25.7

(continuation of the "Final_Result" table from column 16 ...)

Frequency (MHz)	Comment
71.128000	
73.132667	
73.714667	
138.381333	
139.189667	
141.194333	
143.296000	

1/18/2018

9:34:09 AM

Table 6. Radiated Measurements at 10 meters

► WiFi 5 GHz mode

EMI Auto Test(1)

1 / 2

Test Report

Common Information

Test Description :	Radiated Emission(NK-17-E-0848)
Test Site :	3rd Building 10 m Chamber
Test Standard :	FCC Part 15 Subpart B Class B
Environment Conditions :	a.c. 120 V, 60 Hz
Operator Name :	Kyoung-Hoon, Lee
Mode :	P/N 200107
	WiFi 5.0 GHz Mode

Full Spectrum

Full Spectrum

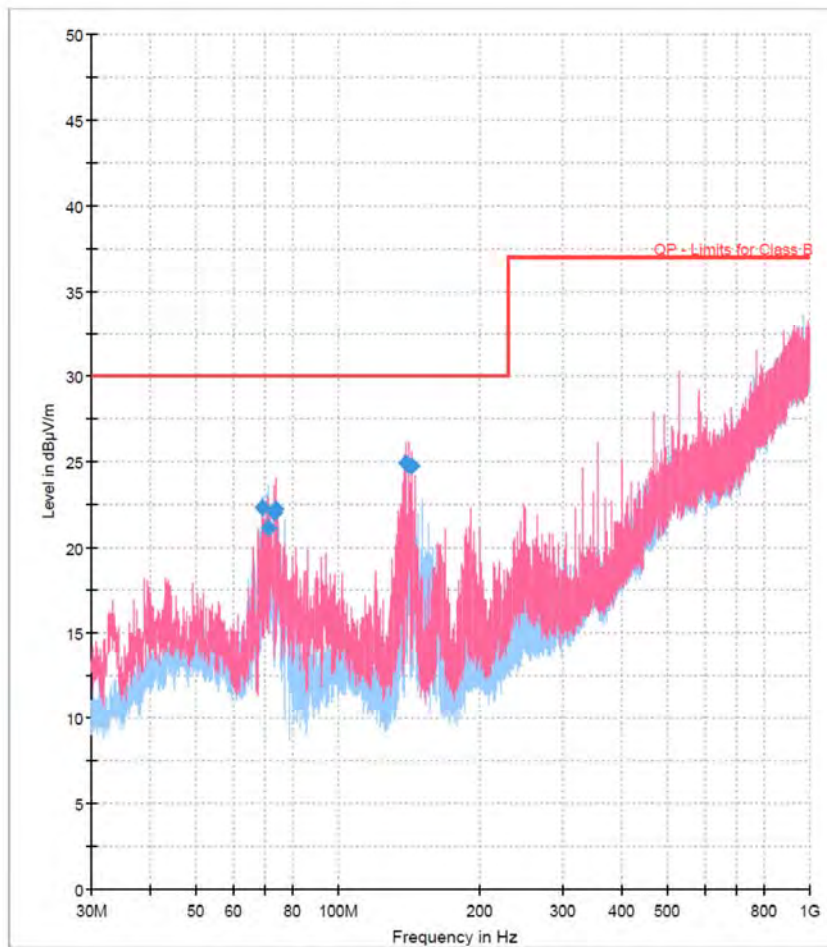

1/18/2018

10:03:11 AM

EMI Auto Test(1)

2 / 2

Final Result

Frequency (MHz)	QuasiPeak (dBµV/m)	Limit (dBµV/m)	Margin (dB)	Meas. Time (ms)	Bandwidth (kHz)	Height (cm)	Pol	Azimuth (deg)	Corr. (dB)
68.994000	22.28	30.00	7.72	15000.0	120.000	400.0	H	146.0	-25.0
71.095667	21.11	30.00	8.89	15000.0	120.000	377.0	H	128.0	-25.6
73.165000	22.01	30.00	7.99	15000.0	120.000	201.0	V	294.0	-26.2
73.714667	22.21	30.00	7.79	15000.0	120.000	177.0	V	263.0	-26.4
139.189667	24.89	30.00	5.11	15000.0	120.000	130.0	V	226.0	-25.8
141.194333	24.73	30.00	5.27	15000.0	120.000	130.0	V	46.0	-25.8
143.296000	24.71	30.00	5.29	15000.0	120.000	130.0	V	239.0	-25.7

(continuation of the "Final_Result" table from column 16 ...)

Frequency (MHz)	Comment
68.994000	
71.095667	
73.165000	
73.714667	
139.189667	
141.194333	
143.296000	

1/18/2018

10:03:11 AM

Table 7. Radiated Measurements at 10 meters

► BLE mode

EMI Auto Test(1)

1 / 2

Test Report

Common Information

Test Description :	Radiated Emission(NK-17-E-0848)
Test Site :	3rd Building 10 m Chamber
Test Standard :	FCC Part 15 Subpart B Class B
Environment Conditions :	a.c. 120 V, 60 Hz
Operator Name :	Kyoung-Hoon, Lee
Mode :	P/N 200107 BLE Mode

Full Spectrum

Full Spectrum

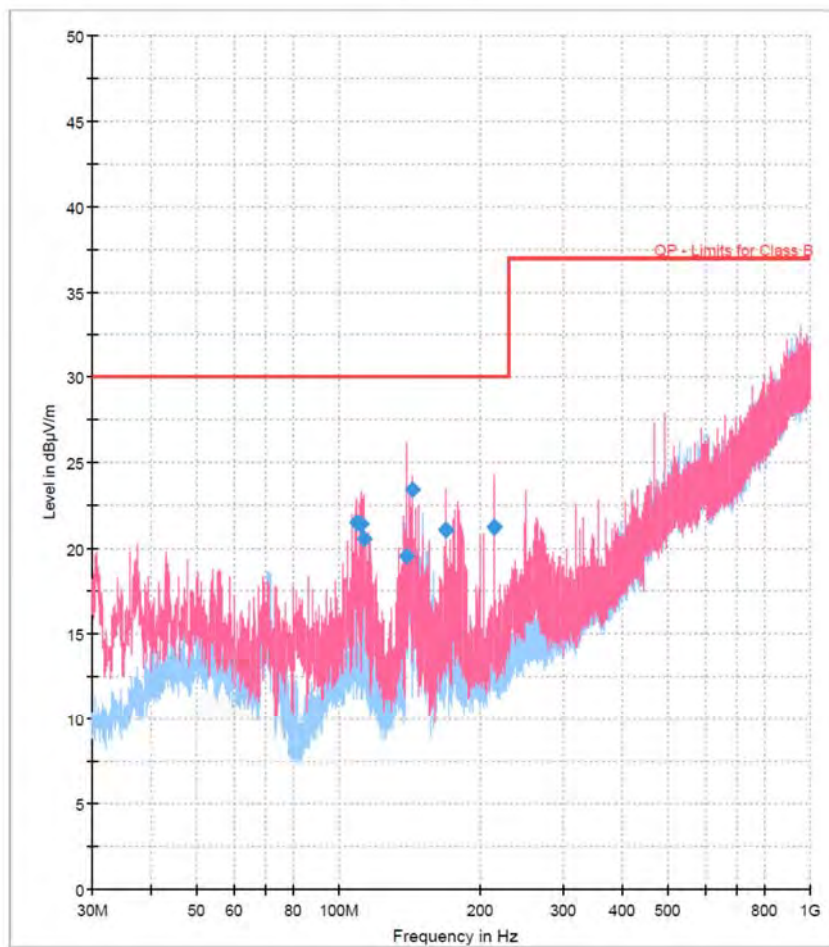

1/18/2018

9:35:34 AM

EMI Auto Test(1)

2 / 2

Final Result

Frequency (MHz)	QuasiPeak (dBµV/m)	Limit (dBµV/m)	Margin (dB)	Meas. Time (ms)	Bandwidth (kHz)	Height (cm)	Pol	Azimuth (deg)	Corr. (dB)
108.796333	21.49	30.00	8.51	15000.0	120.000	170.0	V	22.0	-22.4
111.544667	21.35	30.00	8.65	15000.0	120.000	170.0	V	26.0	-22.6
113.096667	20.59	30.00	9.41	15000.0	120.000	100.0	V	332.0	-22.8
139.189667	19.57	30.00	10.43	15000.0	120.000	176.0	V	24.0	-25.8
143.296000	23.43	30.00	6.57	15000.0	120.000	107.0	V	233.0	-25.7
168.774667	21.07	30.00	8.93	15000.0	120.000	107.0	V	322.0	-24.3
213.685667	21.25	30.00	8.75	15000.0	120.000	100.0	V	294.0	-21.8

(continuation of the "Final_Result" table from column 16 ...)

Frequency (MHz)	Comment
108.796333	
111.544667	
113.096667	
139.189667	
143.296000	
168.774667	
213.685667	

1/18/2018

9:35:34 AM

Table 8. Radiated Measurements at 10 meters

► NFC mode

EMI Auto Test(1)

1 / 2

Test Report

Common Information

Test Description :	Radiated Emission(NK-17-E-0848)
Test Site :	3rd Building 10 m Chamber
Test Standard :	FCC Part 15 Subpart B Class B
Environment Conditions :	a.c. 120 V, 60 Hz
Operator Name :	Kyoung-Hoon, Lee
Mode :	P/N 200107
	NFC Mode

Full Spectrum

Full Spectrum

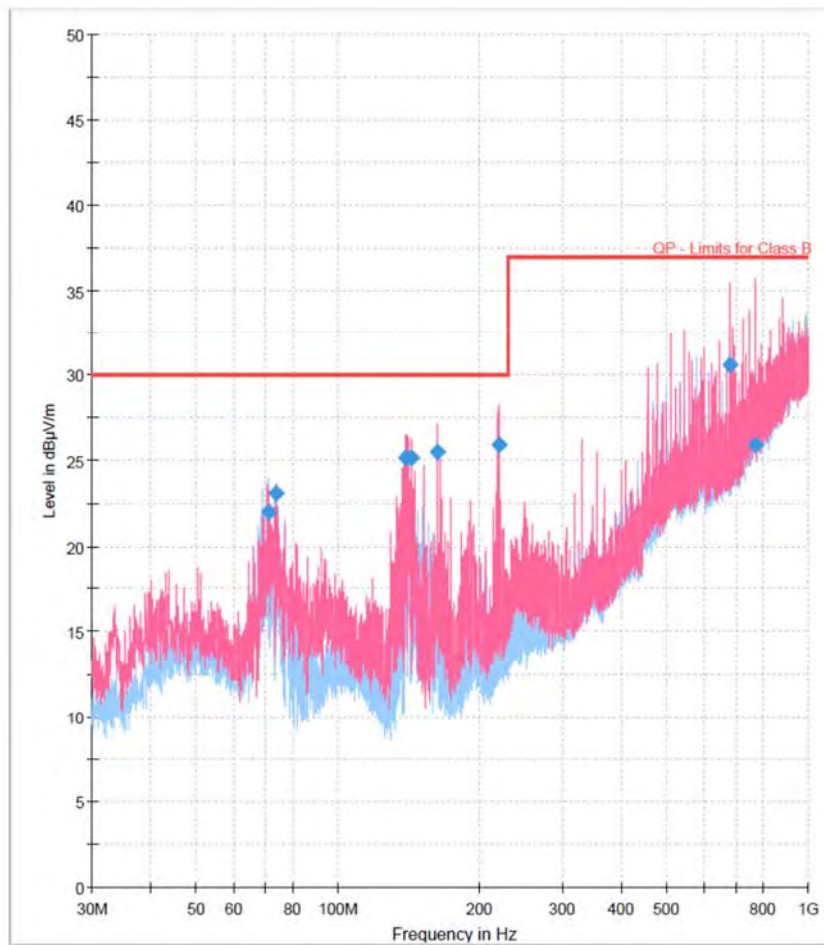

1/18/2018

10:37:38 AM

EMI Auto Test(1)

2 / 2

Final Result

Frequency (MHz)	QuasiPeak (dBµV/m)	Limit (dBµV/m)	Margin (dB)	Meas. Time (ms)	Bandwidth (kHz)	Height (cm)	Pol	Azimuth (deg)	Corr. (dB)
71.095667	22.01	30.00	7.99	15000.0	120.000	400.0	H	146.0	-25.6
73.714667	23.05	30.00	6.95	15000.0	120.000	202.0	V	288.0	-26.4
139.222000	25.15	30.00	4.85	15000.0	120.000	130.0	V	224.0	-25.8
143.296000	25.13	30.00	4.87	15000.0	120.000	107.0	V	251.0	-25.7
163.116333	25.54	30.00	4.46	15000.0	120.000	177.0	V	319.0	-24.6
219.376333	25.89	30.00	4.11	15000.0	120.000	130.0	V	-23.0	-21.4
680.611333	30.60	37.00	6.40	15000.0	120.000	276.0	V	9.0	-8.1
770.659667	25.90	37.00	11.10	15000.0	120.000	270.0	V	-11.0	-6.0

(continuation of the "Final_Result" table from column 16 ...)

Frequency (MHz)	Comment
71.095667	
73.714667	
139.222000	
143.296000	
163.116333	
219.376333	
680.611333	
770.659667	

1/18/2018

10:37:38 AM

Table 9. Radiated Measurements at 10 meters

► Charge mode

EMI Auto Test(1)

1 / 2

Test Report

Common Information

Test Description :	Radiated Emission(NK-17-E-0848)
Test Site :	3rd Building 10 m Chamber
Test Standard :	FCC Part 15 Subpart B Class B
Environment Conditions :	a.c. 120 V, 60 Hz
Operator Name :	Kyoung-Hoon, Lee
Model :	P/N 200107
Mode :	Charge Mode

Full Spectrum

Full Spectrum

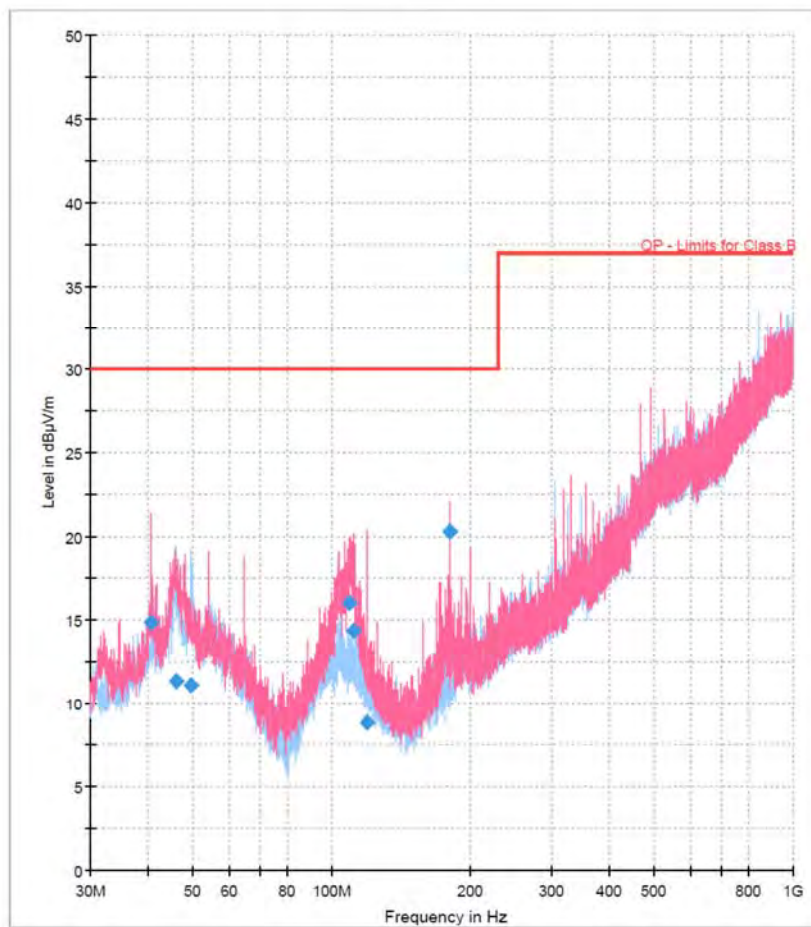

2/8/2018

EMI Auto Test(1)

2 / 2

Final Result

Frequency (MHz)	QuasiPeak (dBµV/m)	Limit (dBµV/m)	Margin (dB)	Meas. Time (ms)	Bandwidth (kHz)	Height (cm)	Pol	Azimuth (deg)	Corr. (dB)
40.670000	14.88	30.00	15.12	15000.0	120.000	230.0	V	288.0	-21.9
45.875667	11.33	30.00	18.67	15000.0	120.000	107.0	H	242.0	-20.9
49.594000	11.04	30.00	18.96	15000.0	120.000	130.0	H	204.0	-20.7
109.055000	16.02	30.00	13.98	15000.0	120.000	107.0	V	311.0	-22.4
111.932667	14.39	30.00	15.61	15000.0	120.000	100.0	V	32.0	-22.6
119.466333	8.81	30.00	21.19	15000.0	120.000	322.0	V	26.0	-23.7
179.994333	20.29	30.00	9.71	15000.0	120.000	107.0	V	75.0	-23.6

2/8/2018

Table 10. Radiated Measurements at 10 meters

► WiFi 2.4 GHz mode (without I/O port)

EMI Auto Test(1)

1 / 2

Test Report

Common Information

Test Description :	Radiated Emission(NK-17-E-0848)
Test Site :	3rd Building 10 m Chamber
Test Standard :	FCC Part 15 Subpart B Class B
Environment Conditions :	d.c. 3.7 V
Operator Name :	Kyoung-Hoon, Lee
Mode :	P/N 200107 WiFi 2.4 GHz Mode

Full Spectrum

Full Spectrum

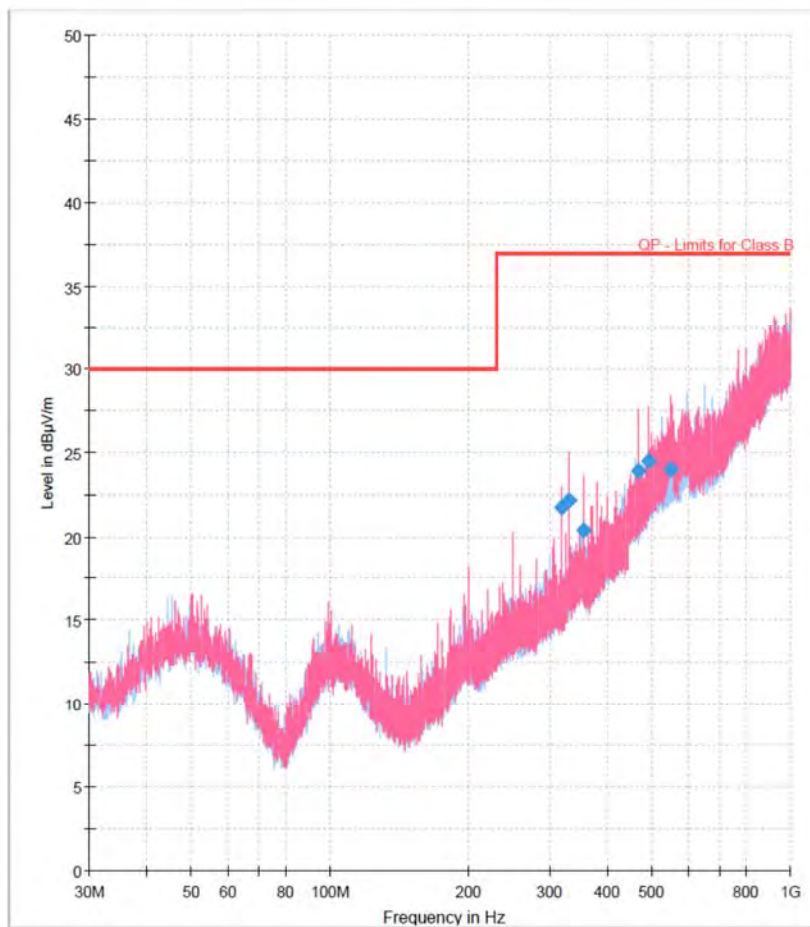

1/17/2018

5:05:25 PM

EMI Auto Test(1)

2 / 2

Final Result

Frequency (MHz)	QuasiPeak (dBμV/m)	Limit (dBμV/m)	Margin (dB)	Meas. Time (ms)	Bandwidth (kHz)	Height (cm)	Pol	Azimuth (deg)	Corr. (dB)
319.092333	21.75	37.00	15.25	15000.0	120.000	400.0	V	220.0	-17.7
331.346667	22.14	37.00	14.86	15000.0	120.000	400.0	V	286.0	-16.8
355.855333	20.36	37.00	16.64	15000.0	120.000	400.0	V	142.0	-16.0
466.370667	23.90	37.00	13.10	15000.0	120.000	400.0	V	116.0	-12.8
490.911667	24.53	37.00	12.47	15000.0	120.000	100.0	V	92.0	-11.9
550.017000	23.95	37.00	13.05	15000.0	120.000	107.0	V	237.0	-10.5

(continuation of the "Final_Result" table from column 16 ...)

Frequency (MHz)	Comment
319.092333	
331.346667	
355.855333	
466.370667	
490.911667	
550.017000	

1/17/2018

5:05:25 PM

Table 11. Radiated Measurements at 10 meters

► WiFi 5 GHz mode (without I/O port)

EMI Auto Test(1)

1 / 2

Test Report

Common Information

Test Description :	Radiated Emission(NK-17-E-0848)
Test Site :	3rd Building 10 m Chamber
Test Standard :	FCC Part 15 Subpart B Class B
Environment Conditions :	d.c. 3.7 V
Operator Name :	Kyoung-Hoon, Lee
Mode :	P/N 200107 WiFi 5.0 GHz Mode

Full Spectrum

Full Spectrum

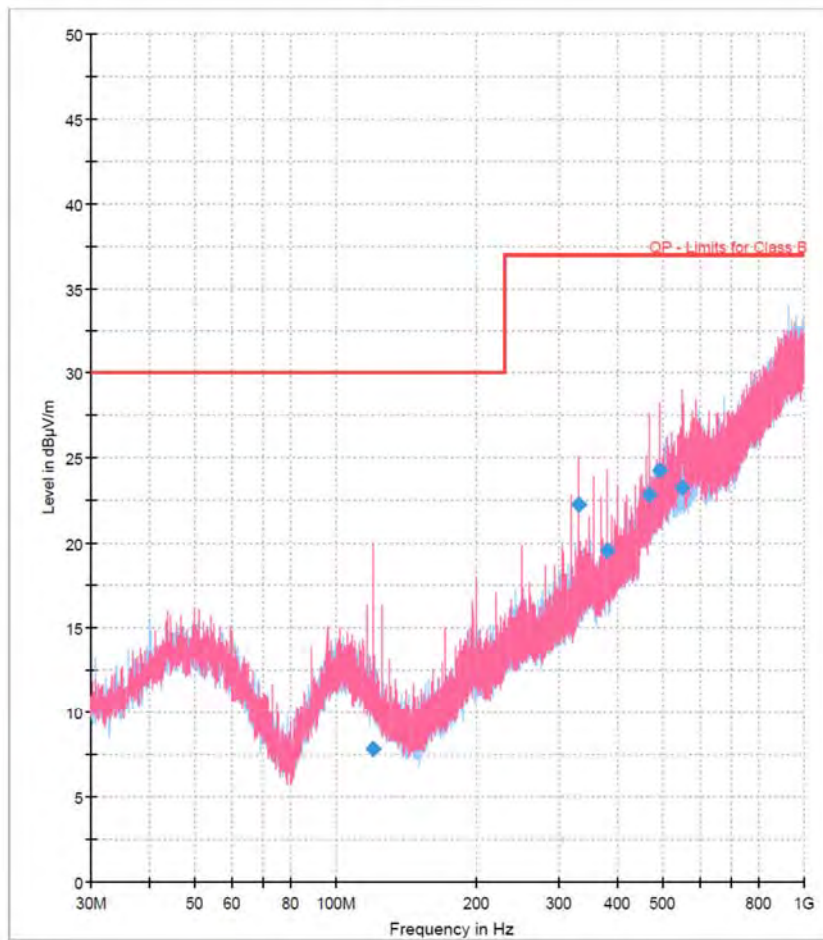

1/17/2018

5:33:02 PM

EMI Auto Test(1)

2 / 2

Final Result

Frequency (MHz)	QuasiPeak (dBµV/m)	Limit (dBµV/m)	Margin (dB)	Meas. Time (ms)	Bandwidth (kHz)	Height (cm)	Pol	Azimuth (deg)	Corr. (dB)
120.404000	7.83	30.00	22.17	15000.0	120.000	230.0	V	26.0	-23.9
331.346667	22.26	37.00	14.74	15000.0	120.000	400.0	V	57.0	-16.8
380.428667	19.52	37.00	17.48	15000.0	120.000	100.0	V	349.0	-15.3
466.338333	22.83	37.00	14.17	15000.0	120.000	377.0	V	265.0	-12.8
490.879333	24.25	37.00	12.75	15000.0	120.000	100.0	V	0.0	-11.9
549.758333	23.24	37.00	13.76	15000.0	120.000	100.0	V	242.0	-10.5

(continuation of the "Final_Result" table from column 16 ...)

Frequency (MHz)	Comment
120.404000	
331.346667	
380.428667	
466.338333	
490.879333	
549.758333	

1/17/2018

5:33:02 PM

Table 12. Radiated Measurements at 10 meters

► BLE mode (without I/O port)

EMI Auto Test(1)

1 / 2

Test Report

Common Information

Test Description :	Radiated Emission(NK-17-E-0848)
Test Site :	3rd Building 10 m Chamber
Test Standard :	FCC Part 15 Subpart B Class B
Environment Conditions :	d.c. 3.7 V
Operator Name :	Kyoung-Hoon, Lee
Mode :	P/N 200107 BLE Mode

Full Spectrum

Full Spectrum

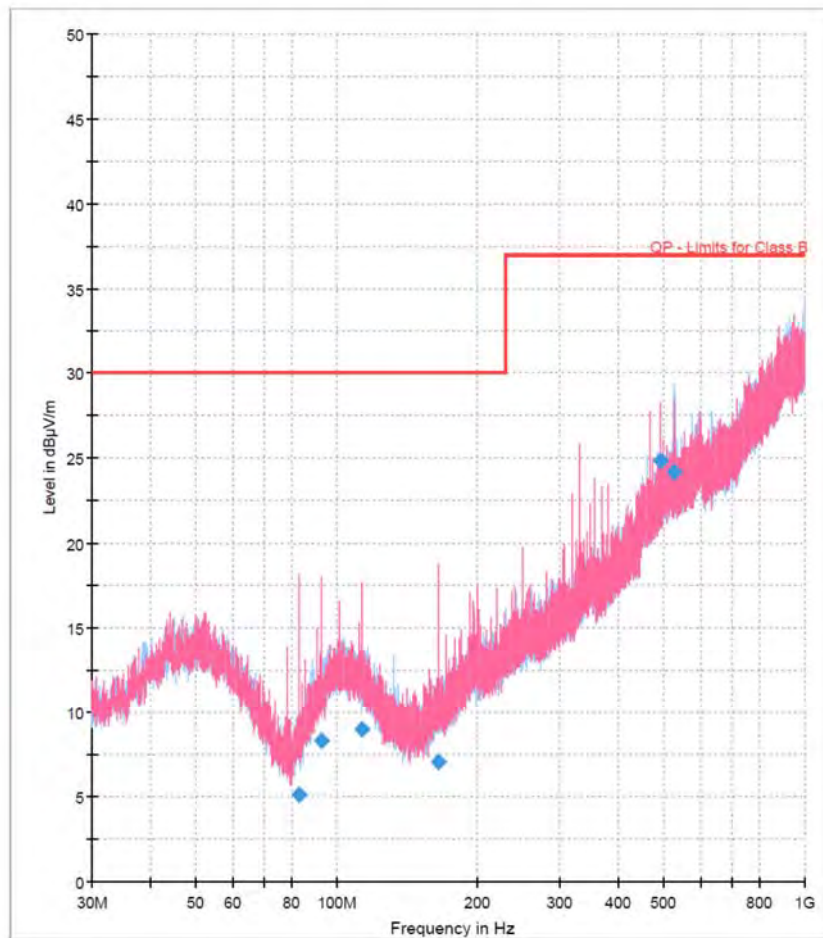

1/17/2018

4:34:59 PM

EMI Auto Test(1)

2 / 2

Final Result

Frequency (MHz)	QuasiPeak (dBµV/m)	Limit (dBµV/m)	Margin (dB)	Meas. Time (ms)	Bandwidth (kHz)	Height (cm)	Pol	Azimuth (deg)	Corr. (dB)
83.059000	5.14	30.00	24.86	15000.0	120.000	107.0	V	27.0	-26.4
92.888333	8.27	30.00	21.73	15000.0	120.000	130.0	V	28.0	-23.5
113.355333	8.94	30.00	21.06	15000.0	120.000	176.0	V	24.0	-22.8
164.797667	7.05	30.00	22.95	15000.0	120.000	100.0	V	204.0	-24.5
490.911667	24.87	37.00	12.13	15000.0	120.000	370.0	V	189.0	-11.9
527.998000	24.18	37.00	12.82	15000.0	120.000	230.0	H	97.0	-10.9

(continuation of the "Final_Result" table from column 16 ...)

Frequency (MHz)	Comment
83.059000	
92.888333	
113.355333	
164.797667	
490.911667	
527.998000	

1/17/2018

4:34:59 PM

Table 13. Radiated Measurements at 10 meters

► NFC mode (without I/O port)

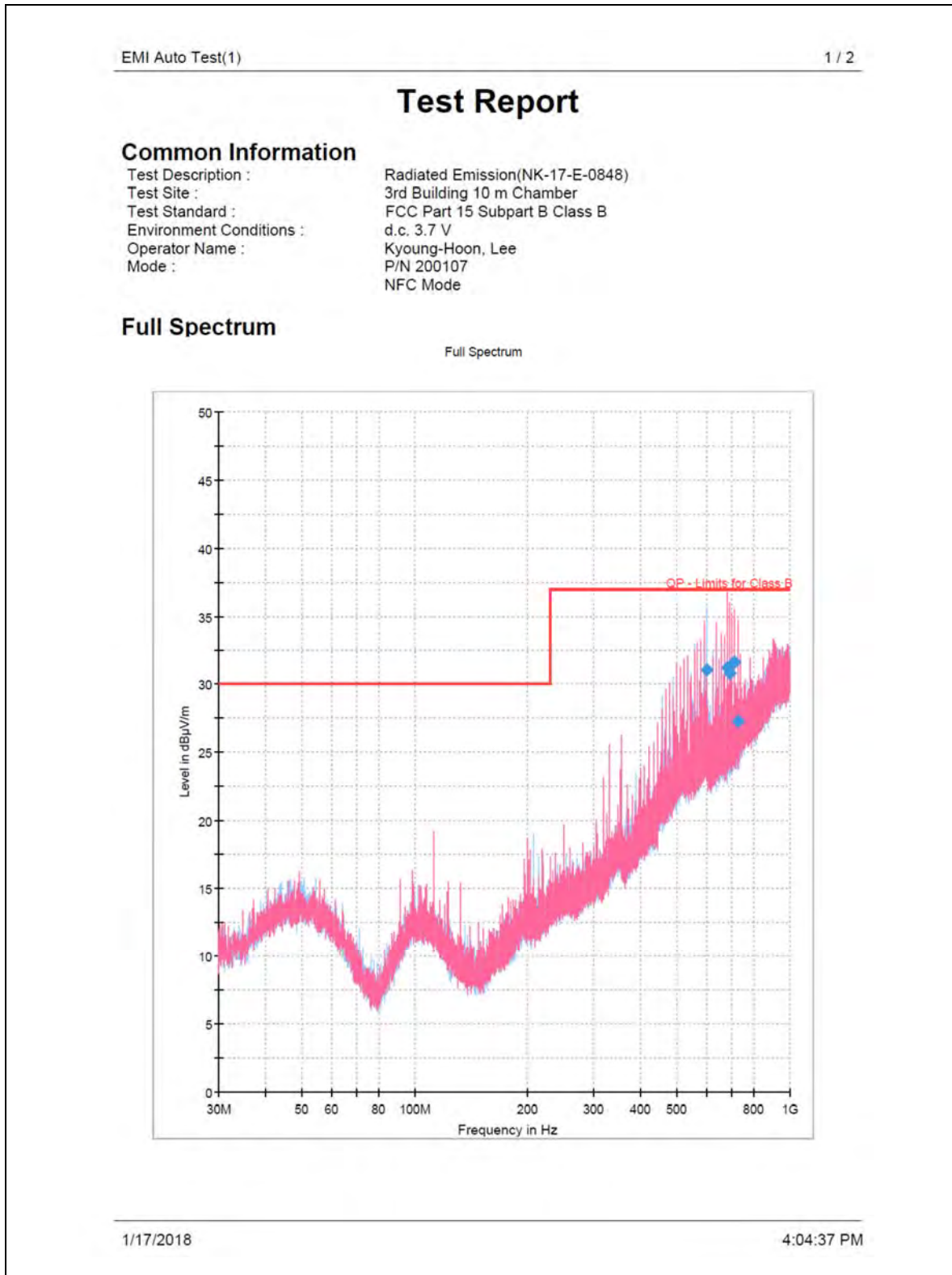

EMI Auto Test(1)

2 / 2

Final Result

Frequency (MHz)	QuasiPeak (dBµV/m)	Limit (dBµV/m)	Margin (dB)	Meas. Time (ms)	Bandwidth (kHz)	Height (cm)	Pol	Azimuth (deg)	Corr. (dB)
601.847333	31.08	37.00	5.92	15000.0	120.000	130.0	H	269.0	-8.6
680.579000	31.23	37.00	5.77	15000.0	120.000	302.0	V	164.0	-8.1
691.863333	30.80	37.00	6.20	15000.0	120.000	270.0	V	114.0	-8.0
703.115333	31.50	37.00	5.50	15000.0	120.000	230.0	V	117.0	-7.7
714.367333	31.62	37.00	5.38	15000.0	120.000	202.0	V	187.0	-7.6
725.619333	27.23	37.00	9.77	15000.0	120.000	270.0	V	273.0	-7.1

(continuation of the "Final_Result" table from column 16 ...)

Frequency (MHz)	Comment
601.847333	
680.579000	
691.863333	
703.115333	
714.367333	
725.619333	

1/17/2018

4:04:37 PM

Table 14. Radiated Measurements at 10 meters

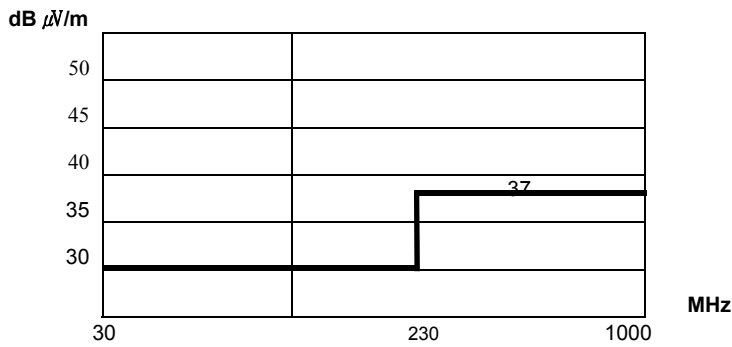

Fig. 5. Limits at 10 meters

NOTES:

1. All modes were measured and the worst-case emission was reported.
2. Below 1 GHz, the radiated limits are shown on Figure 5.

NOTES: 1. Polarization : H = Horizontal, V = Vertical

2. Corr. = Antenna Factor + Cable Loss + Amplifier

3. Measurements using quasi-peak mode below 1 GHz.

4. The limit for Class B device is on the FCC Part section 15.109(g).



Tested by: Kyoungsoon Lee

TEST DATA

Radiated Emissions (Above 1 GHz)

► WiFi 2.4 GHz mode

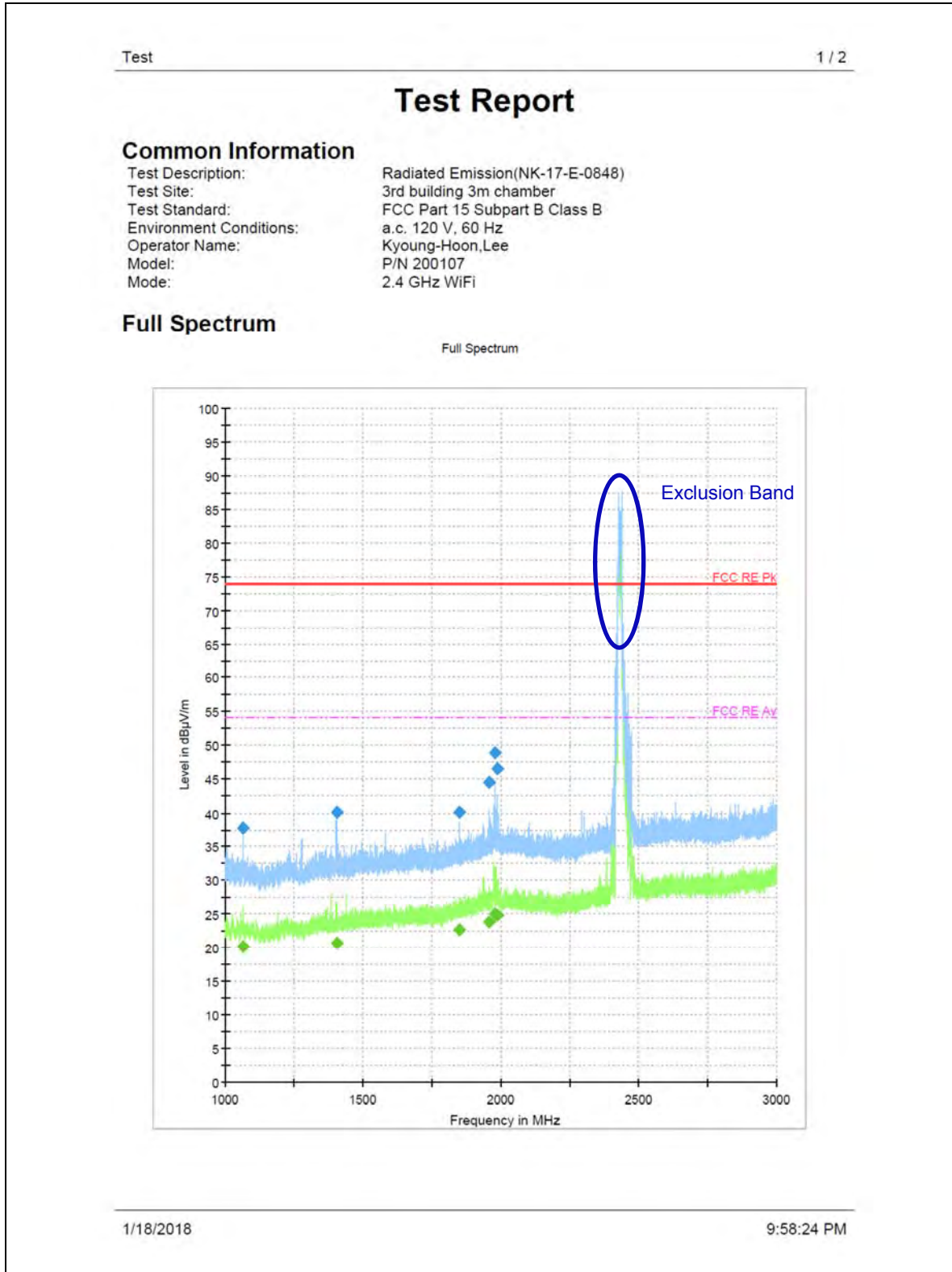

Test

2 / 2

Final Result

Frequency (MHz)	MaxPeak (dBµV/m)	CAverage (dBµV/m)	Limit (dBµV/m)	Margin (dB)	Meas. Time (ms)	Bandwidth (kHz)	Height (cm)	Pol
1066.133333	37.68	---	74.00	36.32	15000.0	1000.000	104.3	V
1066.133333	---	20.19	54.00	33.81	15000.0	1000.000	104.3	V
1403.266667	---	20.57	54.00	33.43	15000.0	1000.000	100.0	V
1403.266667	40.16	---	74.00	33.84	15000.0	1000.000	100.0	V
1850.733333	---	22.69	54.00	31.31	15000.0	1000.000	117.7	H
1850.733333	40.17	---	74.00	33.83	15000.0	1000.000	117.7	H
1958.866667	---	23.76	54.00	30.24	15000.0	1000.000	403.6	H
1958.866667	44.49	---	74.00	29.51	15000.0	1000.000	403.6	H
1980.066667	---	24.93	54.00	29.07	15000.0	1000.000	100.0	H
1980.066667	48.77	---	74.00	25.23	15000.0	1000.000	100.0	H
1984.933333	46.43	---	74.00	27.57	15000.0	1000.000	103.9	H
1984.933333	---	24.90	54.00	29.10	15000.0	1000.000	103.9	H

(continuation of the "Final_Result" table from column 14 ...)

Frequency (MHz)	Azimuth (deg)	Corr. (dB)	Comment
1066.133333	178.0	-19.0	
1066.133333	178.0	-19.0	
1403.266667	214.0	-17.4	
1403.266667	214.0	-17.4	
1850.733333	313.0	-14.9	
1850.733333	313.0	-14.9	
1958.866667	324.0	-13.5	
1958.866667	324.0	-13.5	
1980.066667	345.0	-13.4	
1980.066667	345.0	-13.4	
1984.933333	320.0	-13.5	
1984.933333	320.0	-13.5	

1/18/2018

9:58:24 PM

Table 15. Radiated Measurements at 3 meters

► WiFi 5 GHz mode

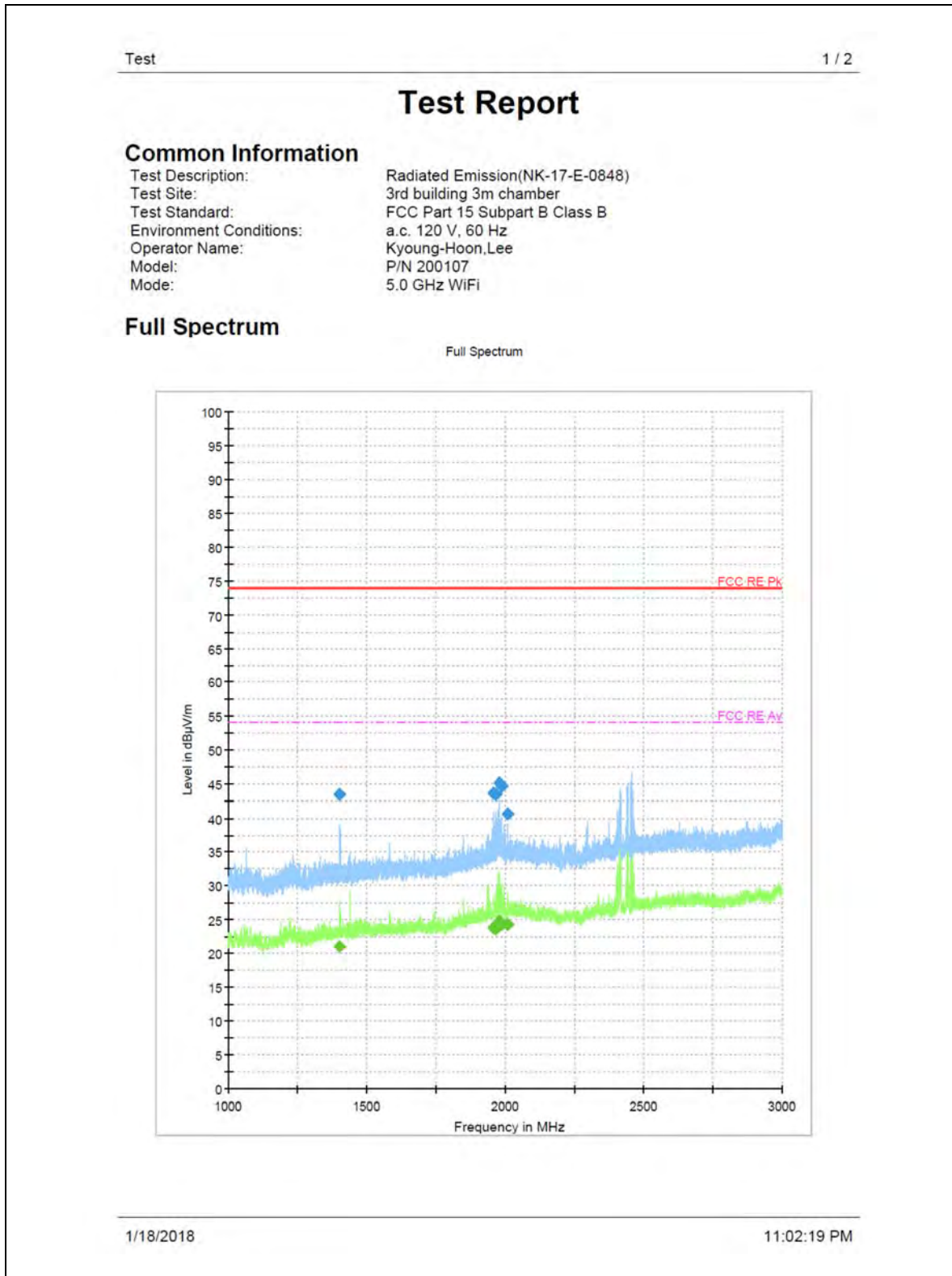

Test

2 / 2

Final Result

Frequency (MHz)	MaxPeak (dBµV/m)	CAverage (dBµV/m)	Limit (dBµV/m)	Margin (dB)	Meas. Time (ms)	Bandwidth (kHz)	Height (cm)	Pol
1399.533333	---	21.02	54.00	32.98	15000.0	1000.000	202.3	V
1399.533333	43.46	---	74.00	30.54	15000.0	1000.000	202.3	V
1957.066667	43.64	---	74.00	30.36	15000.0	1000.000	103.1	V
1957.066667	---	23.77	54.00	30.23	15000.0	1000.000	103.1	V
1963.400000	43.41	---	74.00	30.59	15000.0	1000.000	99.9	V
1963.400000	---	23.74	54.00	30.26	15000.0	1000.000	99.9	V
1976.933333	45.22	---	74.00	28.78	15000.0	1000.000	104.1	H
1976.933333	---	24.80	54.00	29.20	15000.0	1000.000	104.1	H
1987.800000	---	24.39	54.00	29.61	15000.0	1000.000	129.7	H
1987.800000	44.56	---	74.00	29.44	15000.0	1000.000	129.7	H
2009.600000	40.65	---	74.00	33.35	15000.0	1000.000	99.9	H
2009.600000	---	24.40	54.00	29.60	15000.0	1000.000	99.9	H

(continuation of the "Final_Result" table from column 14 ...)

Frequency (MHz)	Azimuth (deg)	Corr. (dB)	Comment
1399.533333	58.0	-17.4	
1399.533333	58.0	-17.4	
1957.066667	86.0	-13.6	
1957.066667	86.0	-13.6	
1963.400000	76.0	-13.5	
1963.400000	76.0	-13.5	
1976.933333	180.0	-13.4	
1976.933333	180.0	-13.4	
1987.800000	6.0	-13.5	
1987.800000	6.0	-13.5	
2009.600000	318.0	-13.3	
2009.600000	318.0	-13.3	

1/18/2018

11:02:19 PM

Table 16. Radiated Measurements at 3 meters

► BLE mode

Test

1 / 2

Test Report

Common Information

Test Description:	Radiated Emission(NK-17-E-0848)
Test Site:	Nemko 3m Chamber
Test Standard:	FCC Part 15 Subpart B Class B
Environment Conditions:	a.c. 120 V, 60 Hz
Operator Name:	Kyoung-Hoon, Lee
Model:	P/N 200107
Mode:	BLE Mode

Full Spectrum

Full Spectrum

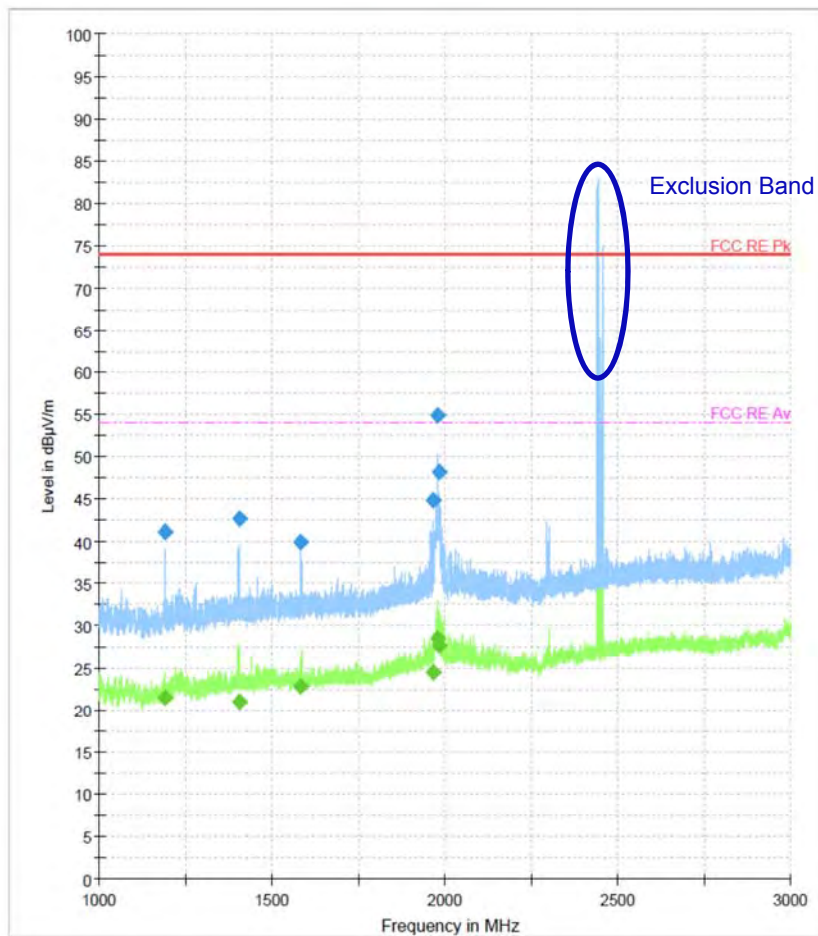

1/18/2018

6:49:54 PM

Test

2 / 2

Final Result

Frequency (MHz)	MaxPeak (dBµV/m)	CAverage (dBµV/m)	Limit (dBµV/m)	Margin (dB)	Meas. Time (ms)	Bandwidth (kHz)	Height (cm)	Pol
1187.666667	41.16	---	74.00	32.84	15000.0	1000.000	314.9	H
1187.666667	---	21.51	54.00	32.49	15000.0	1000.000	314.9	H
1403.400000	---	20.99	54.00	33.01	15000.0	1000.000	192.5	V
1403.400000	42.54	---	74.00	31.46	15000.0	1000.000	192.5	V
1583.866667	---	22.74	54.00	31.26	15000.0	1000.000	120.6	H
1583.866667	39.94	---	74.00	34.06	15000.0	1000.000	120.6	H
1964.133333	---	24.51	54.00	29.49	15000.0	1000.000	394.6	H
1964.133333	44.73	---	74.00	29.27	15000.0	1000.000	394.6	H
1980.000000	54.91	---	74.00	19.09	15000.0	1000.000	225.8	V
1980.000000	---	28.59	54.00	25.41	15000.0	1000.000	225.8	V
1982.800000	---	27.70	54.00	26.30	15000.0	1000.000	99.9	V
1982.800000	48.11	---	74.00	26.89	15000.0	1000.000	99.9	V

(continuation of the "Final_Result" table from column 14 ...)

Frequency (MHz)	Azimuth (deg)	Corr. (dB)	Comment
1187.666667	215.0	-18.9	
1187.666667	215.0	-18.9	
1403.400000	50.0	-17.4	
1403.400000	50.0	-17.4	
1583.866667	3.0	-16.3	
1583.866667	3.0	-16.3	
1964.133333	313.0	-13.5	
1964.133333	313.0	-13.5	
1980.000000	30.0	-13.4	
1980.000000	30.0	-13.4	
1982.800000	140.0	-13.4	
1982.800000	140.0	-13.4	

1/18/2018

6:49:54 PM

Table 17. Radiated Measurements at 3 meters

► NFC mode

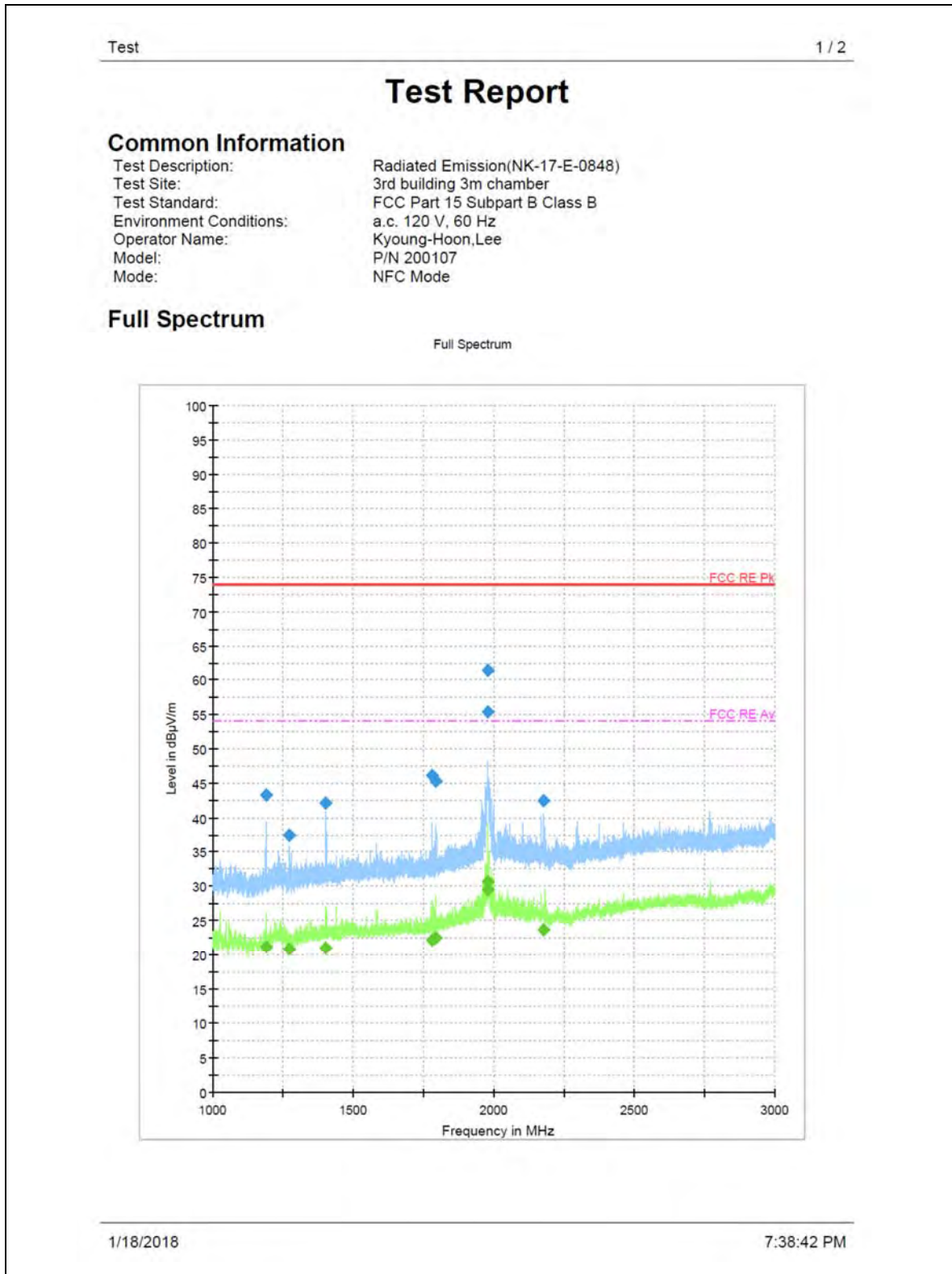

Test

2 / 2

Final Result

Frequency (MHz)	MaxPeak (dBµV/m)	CAverage (dBµV/m)	Limit (dBµV/m)	Margin (dB)	Meas. Time (ms)	Bandwidth (kHz)	Height (cm)	Pol
1188.066667	43.24	---	74.00	30.76	15000.0	1000.000	374.3	H
1188.066667	---	21.19	54.00	32.81	15000.0	1000.000	374.3	H
1273.666667	---	20.74	54.00	33.26	15000.0	1000.000	312.8	V
1273.666667	37.49	---	74.00	36.51	15000.0	1000.000	312.8	V
1402.133333	42.14	---	74.00	31.86	15000.0	1000.000	208.8	V
1402.133333	---	20.97	54.00	33.03	15000.0	1000.000	208.8	V
1778.866667	---	22.22	54.00	31.78	15000.0	1000.000	403.5	H
1778.866667	46.09	---	74.00	27.91	15000.0	1000.000	403.5	H
1792.733333	45.29	---	74.00	28.71	15000.0	1000.000	397.4	H
1792.733333	---	22.40	54.00	31.60	15000.0	1000.000	397.4	H
1980.000000	---	30.76	54.00	23.24	15000.0	1000.000	104.7	H
1980.000000	61.46	---	74.00	12.54	15000.0	1000.000	104.7	H
1980.266667	55.30	---	74.00	18.70	15000.0	1000.000	104.2	H
1980.266667	---	29.49	54.00	24.51	15000.0	1000.000	104.2	H
2175.600000	---	23.71	54.00	30.29	15000.0	1000.000	116.9	H
2175.600000	42.52	---	74.00	31.48	15000.0	1000.000	116.9	H

(continuation of the "Final_Result" table from column 14 ...)

Frequency (MHz)	Azimuth (deg)	Corr. (dB)	Comment
1188.066667	201.0	-18.9	
1188.066667	201.0	-18.9	
1273.666667	100.0	-18.6	
1273.666667	100.0	-18.6	
1402.133333	49.0	-17.4	
1402.133333	49.0	-17.4	
1778.866667	287.0	-15.6	
1778.866667	287.0	-15.6	
1792.733333	82.0	-15.3	
1792.733333	82.0	-15.3	
1980.000000	2.0	-13.4	
1980.000000	2.0	-13.4	
1980.266667	45.0	-13.4	
1980.266667	45.0	-13.4	
2175.600000	28.0	-13.7	
2175.600000	28.0	-13.7	

1/18/2018

7:38:42 PM

Table 18. Radiated Measurements at 3 meters

► Charge mode

Test

1 / 2

Test Report

Common Information

Test Description:	Radiated Emission(NK-17-E-0848)
Test Site:	3rd building 3m chamber
Test Standard:	FCC Part 15 Subpart B Class B
Environment Conditions:	a.c. 120 V, 60 Hz
Operator Name:	Kyoung-Hoon, Lee
Model:	P/N 200107
Mode:	Charge Mode

Full Spectrum

Full Spectrum

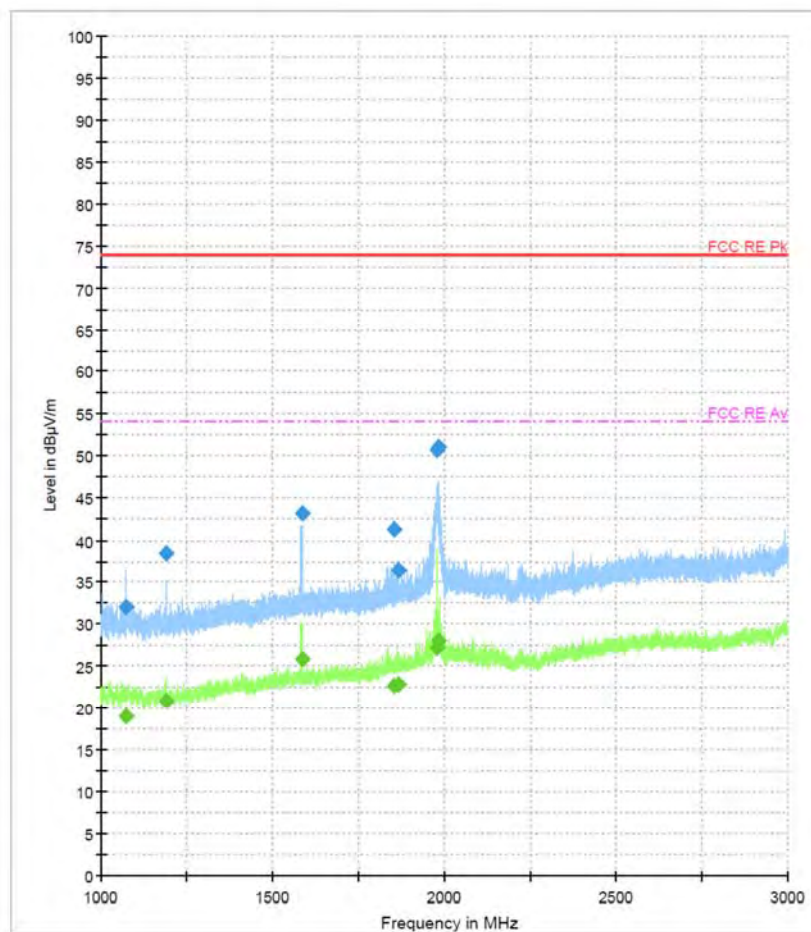

2/12/2018

Test

2 / 2

Final Result

Frequency (MHz)	MaxPeak (dBµV/m)	CAverage (dBµV/m)	Limit (dBµV/m)	Margin (dB)	Meas. Time (ms)	Bandwidth (kHz)	Height (cm)	Pol
1073.266667	---	18.89	54.00	35.11	15000.0	1000.000	300.1	H
1073.266667	32.00	---	74.00	42.00	15000.0	1000.000	300.1	H
1187.933333	---	20.79	54.00	33.21	15000.0	1000.000	300.1	H
1187.933333	38.46	---	74.00	35.54	15000.0	1000.000	300.1	H
1584.133333	---	25.91	54.00	28.09	15000.0	1000.000	300.0	V
1584.133333	43.15	---	74.00	30.85	15000.0	1000.000	300.0	V
1854.400000	---	22.68	54.00	31.32	15000.0	1000.000	394.5	V
1854.400000	41.19	---	74.00	32.81	15000.0	1000.000	394.5	V
1864.400000	---	22.76	54.00	31.24	15000.0	1000.000	99.8	V
1864.400000	36.46	---	74.00	37.54	15000.0	1000.000	99.8	V
1979.800000	---	27.20	54.00	26.80	15000.0	1000.000	394.4	H
1979.800000	50.64	---	74.00	23.36	15000.0	1000.000	394.4	H
1982.533333	---	27.98	54.00	26.02	15000.0	1000.000	99.8	V
1982.533333	51.03	---	74.00	22.97	15000.0	1000.000	99.8	V

(continuation of the "Final_Result" table from column 14 ...)

Frequency (MHz)	Azimuth (deg)	Corr. (dB)	Comment
1073.266667	146.0	-18.9	
1073.266667	146.0	-18.9	
1187.933333	121.0	-18.9	
1187.933333	121.0	-18.9	
1584.133333	317.0	-16.3	
1584.133333	317.0	-16.3	
1854.400000	324.0	-14.8	
1854.400000	324.0	-14.8	
1864.400000	345.0	-14.7	
1864.400000	345.0	-14.7	
1979.800000	-3.0	-13.4	
1979.800000	-3.0	-13.4	
1982.533333	320.0	-13.4	
1982.533333	320.0	-13.4	

2/12/2018

Table 19. Radiated Measurements at 3 meters

► WiFi 2.4 GHz mode (without I/O port)

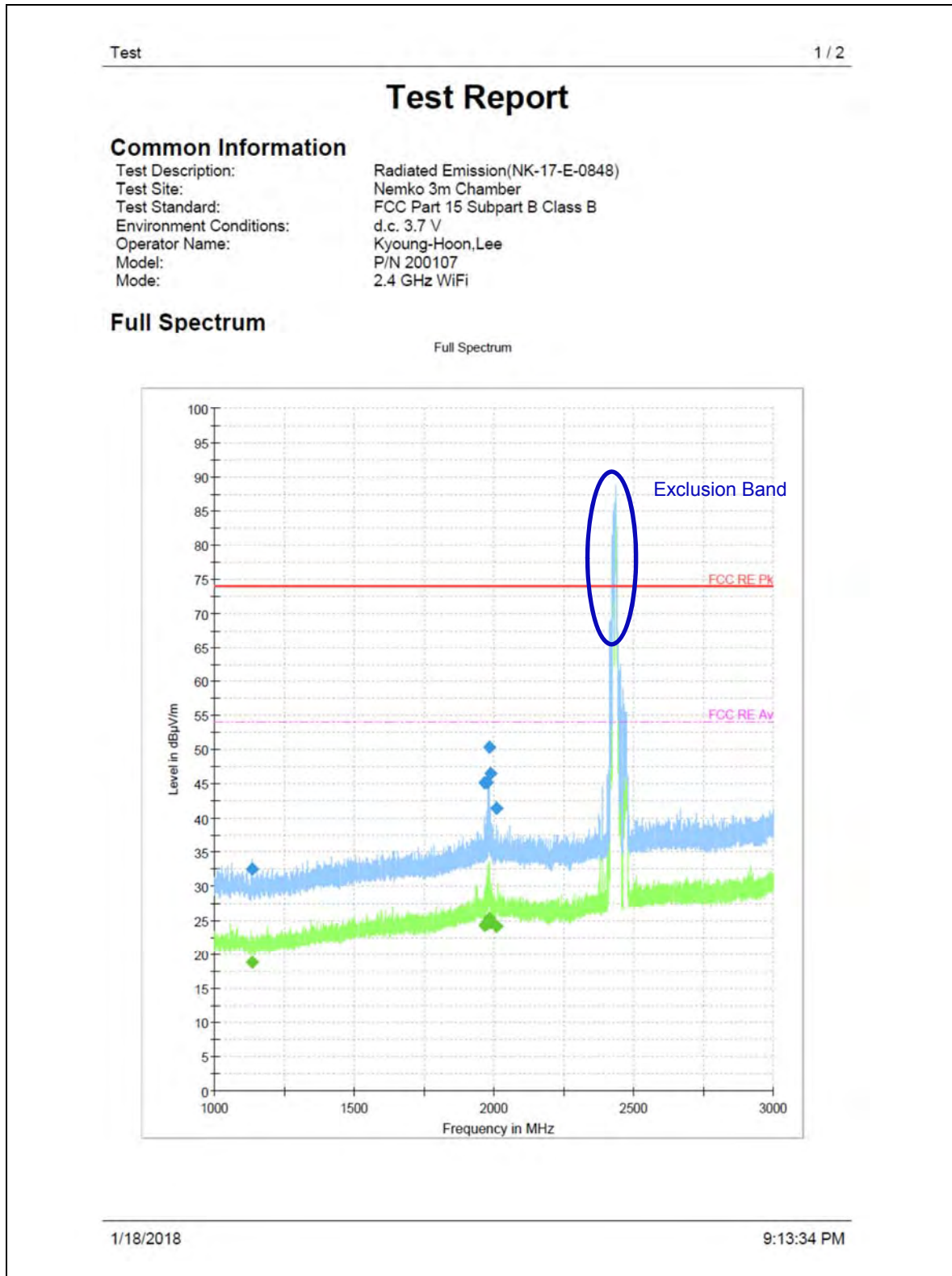

Test

2 / 2

Final Result

Frequency (MHz)	MaxPeak (dBµV/m)	CAverage (dBµV/m)	Limit (dBµV/m)	Margin (dB)	Meas. Time (ms)	Bandwidth (kHz)	Height (cm)	Pol
1134.533333	32.53	---	74.00	41.47	15000.0	1000.000	330.1	H
1134.533333	---	18.72	54.00	35.28	15000.0	1000.000	330.1	H
1965.800000	45.10	---	74.00	28.90	15000.0	1000.000	104.4	H
1965.800000	---	24.25	54.00	29.75	15000.0	1000.000	104.4	H
1973.800000	45.21	---	74.00	28.79	15000.0	1000.000	291.8	V
1973.800000	---	24.53	54.00	29.47	15000.0	1000.000	291.8	V
1980.933333	---	25.37	54.00	28.63	15000.0	1000.000	99.9	H
1980.933333	50.32	---	74.00	23.68	15000.0	1000.000	99.9	H
1987.400000	46.45	---	74.00	27.55	15000.0	1000.000	122.8	H
1987.400000	---	24.74	54.00	29.26	15000.0	1000.000	122.8	H
2008.533333	---	24.14	54.00	29.86	15000.0	1000.000	119.2	H
2008.533333	41.37	---	74.00	32.63	15000.0	1000.000	119.2	H

(continuation of the "Final_Result" table from column 14...)

Frequency (MHz)	Azimuth (deg)	Corr. (dB)	Comment
1134.533333	245.0	-19.1	
1134.533333	245.0	-19.1	
1965.800000	310.0	-13.5	
1965.800000	310.0	-13.5	
1973.800000	4.0	-13.4	
1973.800000	4.0	-13.4	
1980.933333	316.0	-13.4	
1980.933333	316.0	-13.4	
1987.400000	35.0	-13.5	
1987.400000	35.0	-13.5	
2008.533333	29.0	-13.3	
2008.533333	29.0	-13.3	

1/18/2018

9:13:34 PM

Table 20. Radiated Measurements at 3 meters

► WiFi 5 GHz mode (without I/O port)

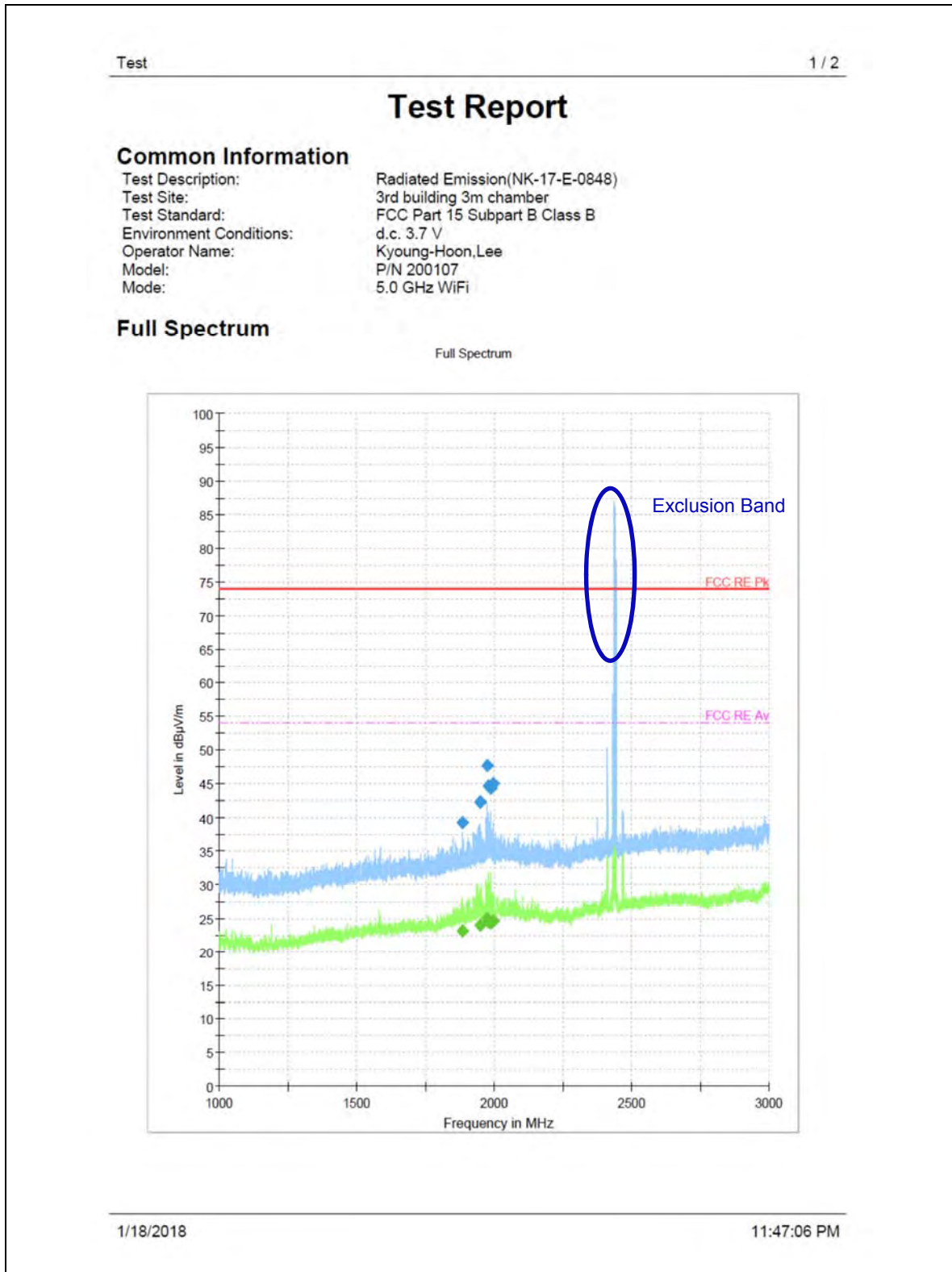

Test

2 / 2

Final Result

Frequency (MHz)	MaxPeak (dBµV/m)	CAverage (dBµV/m)	Limit (dBµV/m)	Margin (dB)	Meas. Time (ms)	Bandwidth (kHz)	Height (cm)	Pol
1885.000000	39.31	---	74.00	34.69	15000.0	1000.000	123.3	H
1885.000000	---	23.08	54.00	30.92	15000.0	1000.000	123.3	H
1946.200000	---	24.05	54.00	29.95	15000.0	1000.000	104.5	H
1946.200000	42.32	---	74.00	31.68	15000.0	1000.000	104.5	H
1972.400000	47.71	---	74.00	26.29	15000.0	1000.000	104.8	H
1972.400000	---	25.06	54.00	28.94	15000.0	1000.000	104.8	H
1980.200000	44.68	---	74.00	29.32	15000.0	1000.000	205.5	V
1980.200000	---	24.43	54.00	29.57	15000.0	1000.000	205.5	V
1987.200000	---	24.25	54.00	29.75	15000.0	1000.000	104.4	V
1987.200000	44.22	---	74.00	29.78	15000.0	1000.000	104.4	V
1995.066667	44.90	---	74.00	29.10	15000.0	1000.000	104.2	H
1995.066667	---	24.64	54.00	29.36	15000.0	1000.000	104.2	H

(continuation of the "Final_Result" table from column 14 ...)

Frequency (MHz)	Azimuth (deg)	Corr. (dB)	Comment
1885.000000	329.0	-14.5	
1885.000000	329.0	-14.5	
1946.200000	315.0	-13.6	
1946.200000	315.0	-13.6	
1972.400000	32.0	-13.4	
1972.400000	32.0	-13.4	
1980.200000	30.0	-13.4	
1980.200000	30.0	-13.4	
1987.200000	141.0	-13.5	
1987.200000	141.0	-13.5	
1995.066667	311.0	-13.5	
1995.066667	311.0	-13.5	

1/18/2018

11:47:06 PM

Table 21. Radiated Measurements at 3 meters

► BLE mode (without I/O port)

Test

1 / 2

Test Report

Common Information

Test Description:	Radiated Emission(NK-17-E-0848)
Test Site:	3rd building 3m chamber
Test Standard:	FCC Part 15 Subpart B Class B
Environment Conditions:	d.c. 3.7 V
Operator Name:	Kyoung-Hoon, Lee
Model:	P/N 200107
Mode:	BLE Mode

Full Spectrum

Full Spectrum

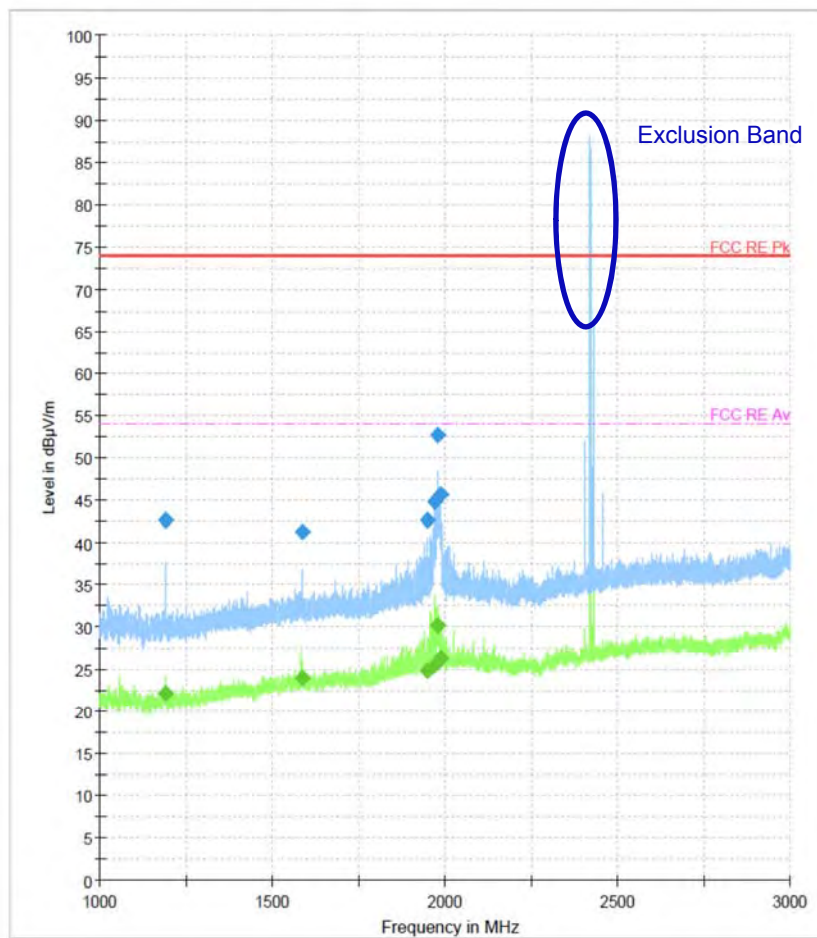

1/18/2018

5:39:57 PM

Test

2 / 2

Final Result

Frequency (MHz)	MaxPeak (dBµV/m)	CAverage (dBµV/m)	Limit (dBµV/m)	Margin (dB)	Meas. Time (ms)	Bandwidth (kHz)	Height (cm)	Pol
1188.066667	42.59	---	74.00	31.41	15000.0	1000.000	230.1	H
1188.066667	---	22.20	54.00	31.80	15000.0	1000.000	230.1	H
1584.266667	41.27	---	74.00	32.73	15000.0	1000.000	117.4	H
1584.266667	---	23.96	54.00	30.04	15000.0	1000.000	117.4	H
1948.400000	42.65	---	74.00	31.35	15000.0	1000.000	99.8	H
1948.400000	---	24.86	54.00	29.14	15000.0	1000.000	99.8	H
1969.400000	---	25.49	54.00	28.51	15000.0	1000.000	104.5	H
1969.400000	44.88	---	74.00	29.12	15000.0	1000.000	104.5	H
1980.266667	52.71	---	74.00	21.29	15000.0	1000.000	117.4	H
1980.266667	---	30.14	54.00	23.86	15000.0	1000.000	117.4	H
1987.000000	---	26.34	54.00	27.66	15000.0	1000.000	288.4	V
1987.000000	45.69	---	74.00	28.31	15000.0	1000.000	288.4	V

(continuation of the "Final_Result" table from column 14 ...)

Frequency (MHz)	Azimuth (deg)	Corr. (dB)	Comment
1188.066667	195.0	-18.9	
1188.066667	195.0	-18.9	
1584.266667	310.0	-16.3	
1584.266667	310.0	-16.3	
1948.400000	318.0	-13.6	
1948.400000	318.0	-13.6	
1969.400000	63.0	-13.4	
1969.400000	63.0	-13.4	
1980.266667	30.0	-13.4	
1980.266667	30.0	-13.4	
1987.000000	-2.0	-13.5	
1987.000000	-2.0	-13.5	

1/18/2018

5:39:57 PM

Table 22. Radiated Measurements at 3 meters

► NFC mode (without I/O port)

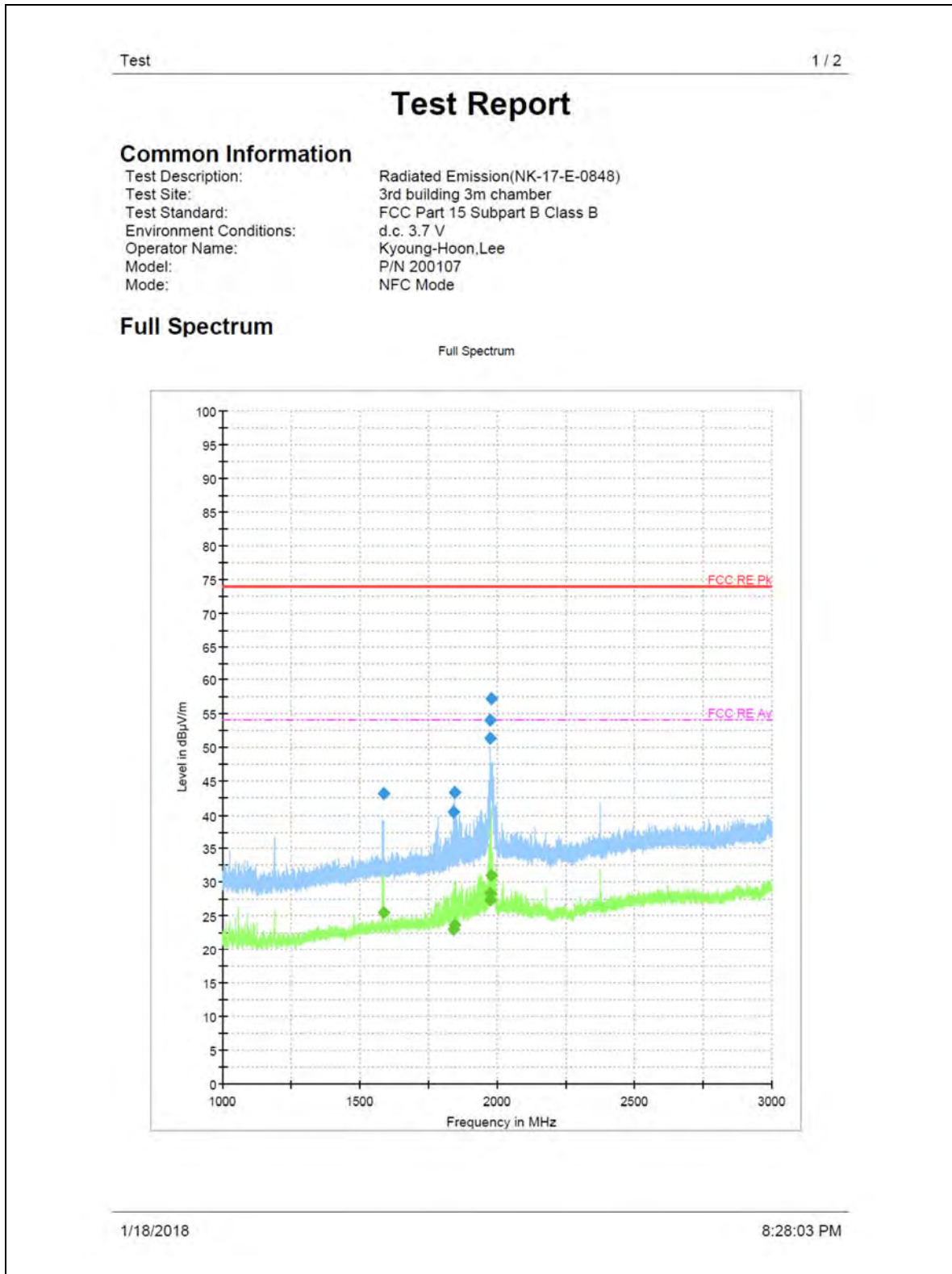

Test

2 / 2

Final Result

Frequency (MHz)	MaxPeak (dBµV/m)	CAverage (dBµV/m)	Limit (dBµV/m)	Margin (dB)	Meas. Time (ms)	Bandwidth (kHz)	Height (cm)	Pol
1584.266667	43.14	---	74.00	30.86	15000.0	1000.000	289.1	H
1584.266667	---	25.44	54.00	28.56	15000.0	1000.000	289.1	H
1839.266667	40.41	---	74.00	33.60	15000.0	1000.000	104.5	H
1839.266667	---	23.01	54.00	30.99	15000.0	1000.000	104.5	H
1846.933333	43.24	---	74.00	30.76	15000.0	1000.000	122.1	H
1846.933333	---	23.73	54.00	30.27	15000.0	1000.000	122.1	H
1972.666667	51.34	---	74.00	22.66	15000.0	1000.000	123.0	H
1972.666667	---	27.34	54.00	26.66	15000.0	1000.000	123.0	H
1974.466667	54.08	---	74.00	19.92	15000.0	1000.000	99.9	H
1974.466667	---	28.41	54.00	25.59	15000.0	1000.000	99.9	H
1979.733333	57.19	---	74.00	16.81	15000.0	1000.000	99.9	H
1979.733333	---	31.01	54.00	22.99	15000.0	1000.000	99.9	H

(continuation of the "Final_Result" table from column 14 ...)

Frequency (MHz)	Azimuth (deg)	Corr. (dB)	Comment
1584.266667	315.0	-16.3	
1584.266667	315.0	-16.3	
1839.266667	54.0	-15.0	
1839.266667	54.0	-15.0	
1846.933333	320.0	-14.9	
1846.933333	320.0	-14.9	
1972.666667	309.0	-13.4	
1972.666667	309.0	-13.4	
1974.466667	307.0	-13.4	
1974.466667	307.0	-13.4	
1979.733333	307.0	-13.4	
1979.733333	307.0	-13.4	

1/18/2018

8:28:03 PM

Table 23. Radiated Measurements at 3 meters

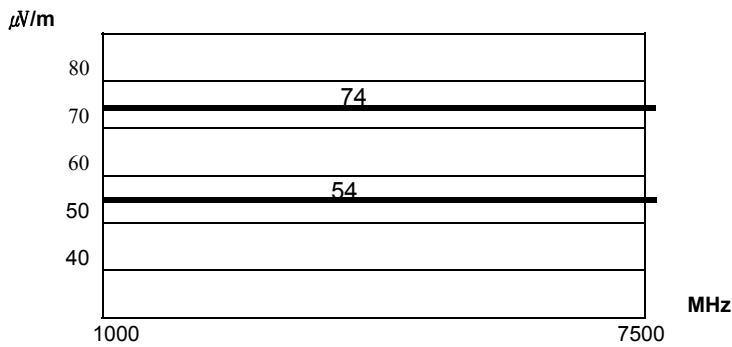

Fig. 6. Limits at 3 meters

NOTES:

1. All modes were measured and the worst-case emission was reported.
2. Above 1 GHz, the radiated limits are shown on Figure 6.

NOTES : 1. Polarization : H = Horizontal, V = Vertical

2. Corr. = Antenna Factor + Cable Loss + Amplifier.

3. The limit for Class B device is on the FCC Part section 15.109(a).

4. Above 1 GHz, peak detector function mode is used using a resolution bandwidth of 1 MHz and a video bandwidth of 1 MHz, average detector function mode is used using a resolution bandwidth of 1 MHz and a video bandwidth of 1 MHz.

Peak mode is used with linearly polarized horn antenna and low-loss microwave cable.



Tested by: Kyoungsoon Lee

ACCURACY OF MEASUREMENT

The Measurement Uncertainties stated were calculated in accordance with the requirements of measurement uncertainty contained in CISPR 16-4-2 with the confidence level of 95 %

1. Conducted Uncertainty Calculation

Source of Uncertainty	X_i	Uncertainty of X_i		Coverage factor k	$u(X_i)$ (dB)	C_i	$C_i u(X_i)$ (dB)
		Value (dB)	Probability Distribution				
Measurement System Repeatability	RS	0.24	normal 1	1.00	0.24	1	0.24
Receiver reading	Ri	± 0.02	normal 2	2.00	0.01	1	0.01
Attenuation AMN-Receiver	LC	± 0.10	rectangular	$\sqrt{3}$	0.06	1	0.06
AMN Voltage division factor	LAMN	± 0.09	normal 2	2.00	0.05	1	0.05
Sine wave voltage	dVSW	± 0.17	normal 2	2.00	0.09	1	0.09
Pulse amplitude response	dVPA	± 0.92	normal 2	2.00	0.50	1	0.50
Pulse repetition rate response	dVPR	± 0.35	normal 2	2.00	0.18	1	0.18
Noise floor proximity	dVNF	± 0.00	rectangular	$\sqrt{3}$	0.00	1	0.00
AMN Impedance	dZ	± 2.00	normal 2	2.00	1.00	1	1.00
Mismatch : AMN-Receiver	M	+ 0.81 - 0.89	U-Shaped	$\sqrt{2}$	0.60	1	0.60
Remark	Using 50 Ω / 50 μ H AMN						
Combined Standard Uncertainty	Normal			$u_c = 1.30$ dB			
Expanded Uncertainty U	Normal ($k = 2$)			$U = 2.6$ dB (CL is 95 %)			

2. Radiation Uncertainty Calculation (Below 1 GHz)

Source of Uncertainty	X_i	Uncertainty of X_i		Coverage factor k	$u(X_i)$ (dB)	C_i	$C_i u(X_i)$ (dB)
		Value (dB)	Probability Distribution				
Measurement System Repeatability	RS	0.15	normal 1	1.00	0.15	1	0.15
Receiver reading	Ri	± 0.02	normal 2	2.00	0.01	1	0.01
Sine wave voltage	dVsw	± 0.17	normal 2	2.00	0.09	1	0.09
Pulse amplitude response	dVpa	± 0.92	normal 2	2.00	0.46	1	0.46
Pulse repetition rate response	dVpr	± 0.35	normal 2	2.00	0.18	1	0.18
Noise floor proximity	dVnf	± 0.50	normal 2	2.00	0.25	1	0.25
Antenna Factor Calibration	AF	± 1.50	rectangular	$\sqrt{3}$	0.87	1	0.87
Cable Loss	CL	± 1.00	normal 2	2.00	0.50	1	0.50
Antenna Directivity	AD	± 0.00	rectangular	$\sqrt{3}$	0.00	1	0.00
Antenna Factor Height Dependence	AH	± 2.00	rectangular	$\sqrt{3}$	1.15	1	1.15
Antenna Phase Centre Variation	AP	± 0.20	rectangular	$\sqrt{3}$	0.12	1	0.12
Antenna Factor Frequency Interpolation	Ai	± 0.25	rectangular	$\sqrt{3}$	0.14	1	0.14
Site Imperfections	Si	± 4.00	triangular	$\sqrt{6}$	1.63	1	1.63
Measurement Distance Variation	DV	± 0.60	rectangular	$\sqrt{3}$	0.35	1	0.35
Antenna Balance	Dbal	± 0.90	rectangular	$\sqrt{3}$	0.52	1	0.52
Cross Polarisation	DCross	± 0.00	rectangular	$\sqrt{3}$	0.00	1	0.00
Mismatch	M	+ 0.98 - 1.11	U-Shaped	$\sqrt{2}$	0.74	1	0.74
EUT Volume Diameter	Vd	0.33	normal 1	1.00	0.33	1	0.11
Combined Standard Uncertainty	Normal			$u_c = 2.53$ dB			
Expanded Uncertainty U	Normal ($k = 2$)			5.1 dB (CL is 95 %)			

3. Radiation Uncertainty Calculation (Above 1 GHz)

Source of Uncertainty	X_i	Uncertainty of X_i		Coverage factor k	$u(X_i)$ (dB)	C_i	$C_i u(X_i)$ (dB)
		Value (dB)	Probability Distribution				
Measurement System Repeatability 1)	RS	0.25	normal 1	1.00	0.25	1	0.25
Receiver Reading 2)	R_i	± 0.27	normal 2	2	0.14	1	0.14
Attenuation (antenna-receiver) 3)	a_c	± 0.30	normal 2	2	0.15	1	0.15
Preamplifier gain 4)	G_p	± 0.23	normal 2	2	0.12	1	0.12
Receiver Sine Wave 5)	dV_{sw}	± 0.17	normal 2	2	0.08	1	0.08
Instability of preamp gain 6)	dG_p	± 1.2	rectangular	$\sqrt{3}$	0.70	1	0.70
Noise Floor Proximity 7)	dV_{nf}	± 0.70	rectangular	$\sqrt{3}$	0.40	1	0.40
Antenna Factor Calibration 8)	AF	± 2.0	normal 2	2	1.00	1	1.00
Directivity difference 9)	DF_{dir}	± 1.00	rectangular	$\sqrt{3}$	0.58	1	0.58
Phase Centre location 10)	AP	± 0.30	rectangular	$\sqrt{3}$	0.17	1	0.17
Antenna Factor Frequency Interpolation 11)	A_i	± 0.30	rectangular	$\sqrt{3}$	0.17	1	0.17
Site Imperfections 12)	S_i	± 3.00	triangular	$\sqrt{6}$	1.22	1	1.22
Effect of setup table material 13)	$dANT$	± 1.50	rectangular	$\sqrt{3}$	0.87	1	0.87
Separation distance 14)	dD	± 0.30	rectangular	$\sqrt{3}$	0.17	1	0.17
Cross Polarization 15)	DC_{cross}	± 0.00	rectangular	$\sqrt{3}$	0.00	1	0.00
Table height 16)	dh	± 0.00	normal 2	2	0.00	1	0.00
Mismatch (antenna-Preamplifier) 17)	M	+ 1.30 - 1.50	U-Shaped	$\sqrt{2}$	1.00	1	1.00
Mismatch (preamplifier-receiver) 18)	M	+ 1.20 - 1.40	U-Shaped	$\sqrt{2}$	0.92	1	0.92
Combined Standard Uncertainty	Normal			$u_c = 2.51$ dB			
Expanded Uncertainty U	Normal ($k = 2$)			$U = 5.0$ dB (CL is 95 %)			

LIST OF TEST EQUIPMENT

No.	Instrument	Manufacturer	Model	Serial No.	Due to Calibration	Calibration Interval
1	EMI Test Receiver	R&S	ESCI	101041	Apr. 03 2018	1 year
2	Software	R&S	EMC32	Version 8.53.0	-	-
3	TWO-LINE V-NETWORK	R&S	ENV216	101156	Apr. 04 2018	1 year
4	EMI Test Receiver	R&S	ESW8	100994	Apr. 03 2018	1 year
5	Software	R&S	EMC32	Version 10.10.01	-	-
6	TRILOG Broadband Test Antenna	SCHWARZBECK	VULB 9163	9163-01027	Apr. 18 2019	2 year
7	ATTENUATOR	FAIRVIEW	SA3N5W-06	N/A	Apr. 03 2018	1 year
8	Controller	innco systems GmbH	CO2000-G	CO2000/562/23890210/L	N/A	N/A
9	Open Switch and Control Unit	R&S	OSP-120	100015	N/A	N/A
10	Antenna Mast (Left)	innco systems GmbH	MA4000-EP	N/A	N/A	N/A
11	Turn Table	innco systems GmbH	DT3000-3T	N/A	N/A	N/A
12	Signal Conditioning Unit	R&S	SCU 01	10030	Apr. 03 2018	1 year
13	EMI Test Receiver	R&S	ESU 40	100202	Apr. 04 2018	1 year
14	DOUBLE RIDGED HORN ANTENNA	SCHWARZBECK	HF907	102585	Apr. 18 2019	2 year
15	CONTROLLER	innco systems GmbH	CO3000	CO3000/937/38330516/L	N/A	N/A
16	TILT ANTENNA MAST	innco systems GmbH	MA4640-XP-EP	N/A	N/A	N/A
17	SWITCH AND POWER DETECTOR UNIT	R&S	OSP120	101766	N/A	N/A
18	WiFi Filter Bank	R&S	U082	N/A	N/A	N/A
19	Turntable	innco systems GmbH	DT2000-2t	N/A	N/A	N/A
20	Signal Conditioning Unit	Rohde & Schwarz	SCU 18	10065	May. 29 2018	1 year

APPENDIX A – SAMPLE LABEL

Labeling Requirements

The sample label shown shall be *permanently affixed* at a conspicuous location on the device and be readily visible to the user at the time of purchase.

- **Label Location of EUT**



APPENDIX B – PHOTOGRAPHS OF TEST SET-UP

The **Conducted Test Picture** and **Radiated Test Picture** and show the worst-case configuration and cable placement.

- **Conducted Test Picture(Front_Configuration 1)**



- **Conducted Test Picture(Side_Configuration 1)**



- **Conducted Test Picture(Front_Configuration 2)**



- **Conducted Test Picture(Side_Configuration 2)**

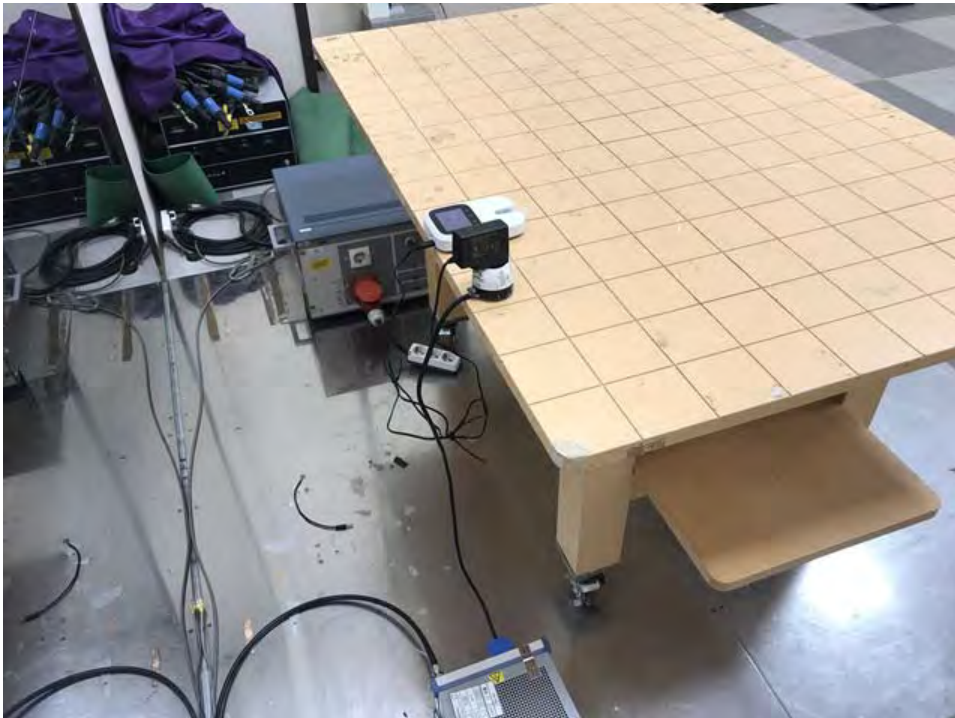

- Radiated Test Picture(Below 1 GHz_Front_Configuration 1)



- Radiated Test Picture(Below 1 GHz_Rear_Configuration 1)



- Radiated Test Picture(Below 1 GHz_Front_Configuration 2)



- Radiated Test Picture(Below 1 GHz_Rear_Configuration 2)



- Radiated Test Picture(Below 1 GHz_Front_Configuration 3)



- Radiated Test Picture(Below 1 GHz_Rear_Configuration 3)



- Radiated Test Picture(Above 1 GHz_Front_Configuration 1)



- Radiated Test Picture(Above 1 GHz_Rear_Configuration 1)

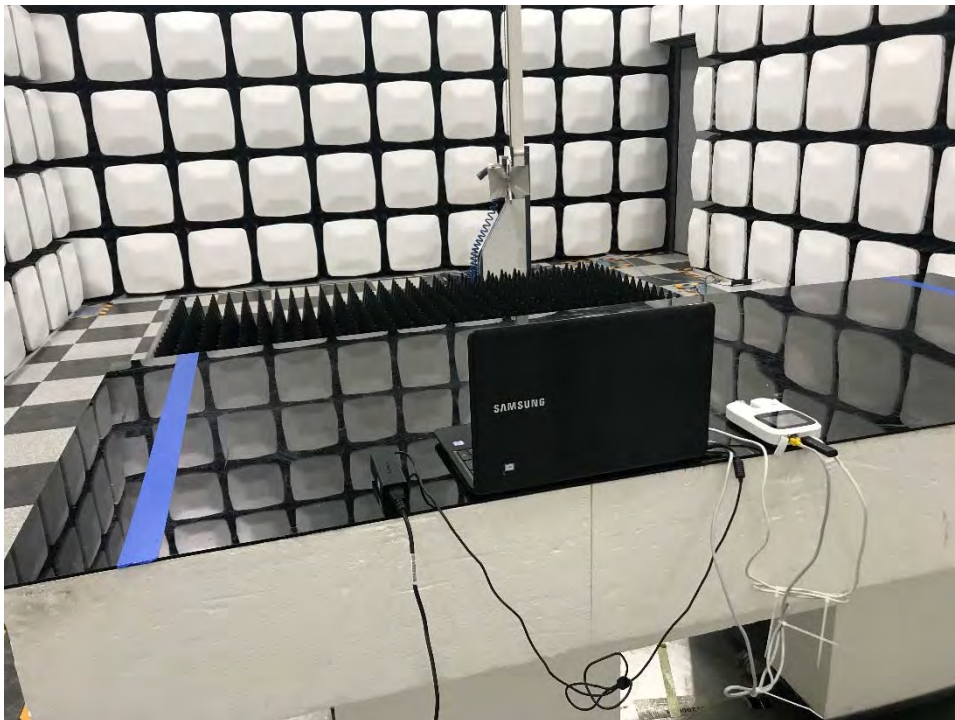

- Radiated Test Picture(Above 1 GHz_Front_Configuration 2)

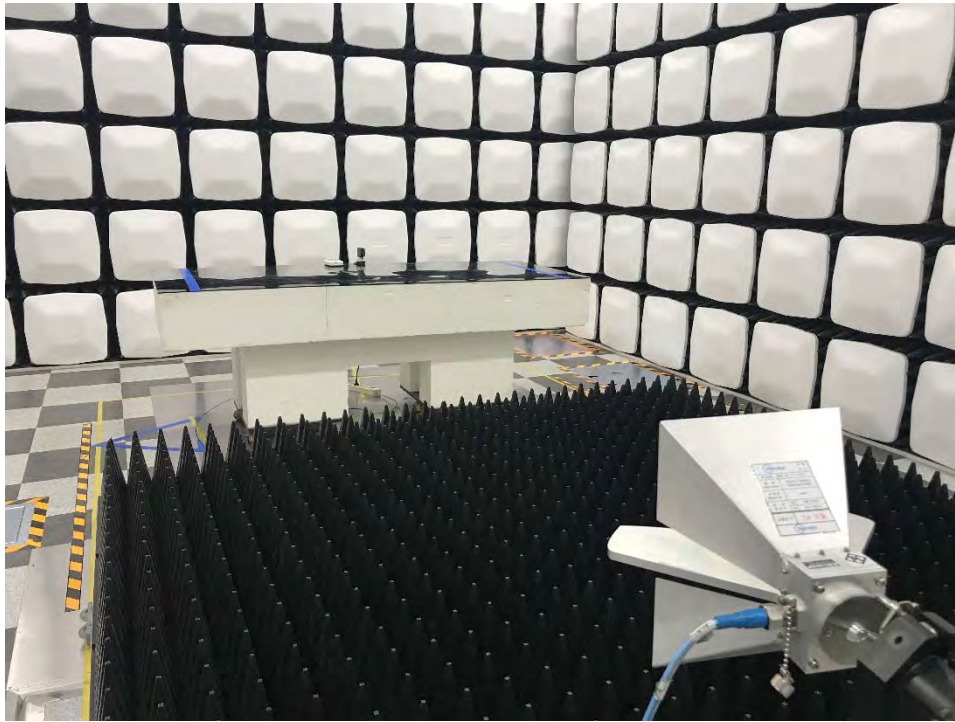

- Radiated Test Picture(Above 1 GHz_Rear_Configuration 2)

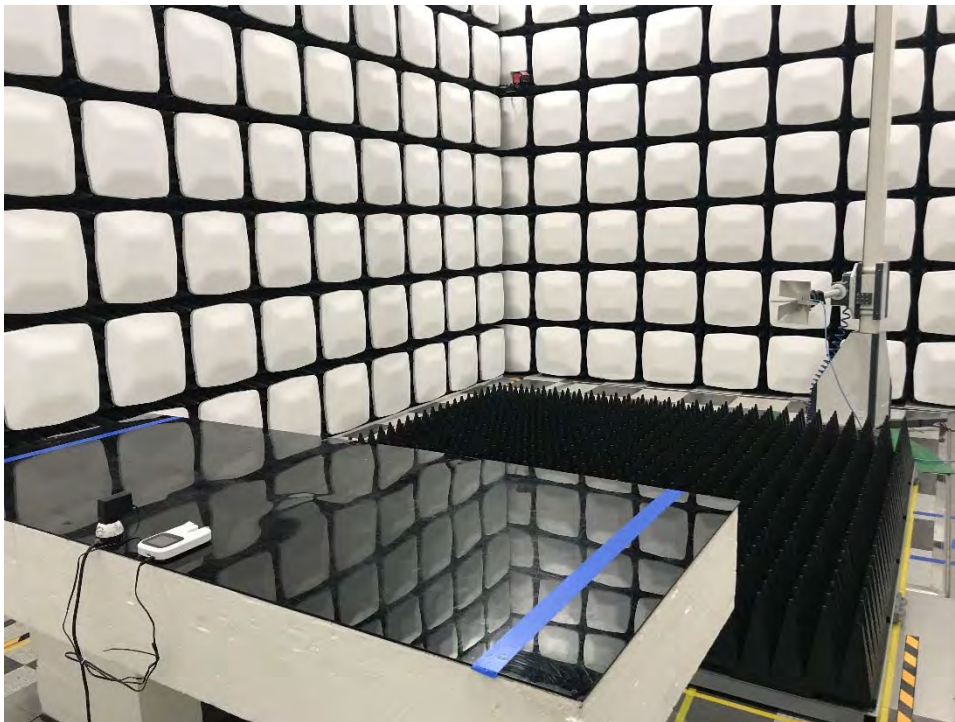

- Radiated Test Picture(Above 1 GHz_Front_Configuration 3)



- Radiated Test Picture(Above 1 GHz_Rear_Configuration 3)



APPENDIX C – EUT PHOTOGRAPHS

Front View of EUT



Rear View of EUT



Inside View of EUT



Front View of Main Board



Rear View of Battery



Front View of Battery



Rear View of NFC Antenna



Front View of WiFi BLE Module



Rear View of WiFi BLE Module



APPENDIX D – BLOCK DIAGRAM

APPENDIX E – USER'S MANUAL

APPENDIX F – SCHEMATIC DIAGRAM
