

HD



bebcare
THERE BEYOND TOUCH



BEBCARE iQ

HD Smart and safe Baby Monitor



INDEX

Features of Bebcare iQ.....	3
Warning.....	4
Control Layout and Icons.....	4
Icon Screen.....	5
Power Supply.....	6
Pairing the camera to parent unit and movement sensor mat.....	8
Operation	
Camera.....	10
Parent unit.....	12
Movement sensor mat.....	18
Changing the operation mode of camera.....	21
Precautions.....	23
Standard accessories included in packaging.....	24
Trouble Shooting guide.....	25
Declaration of Conformity.....	27
Specification.....	28
FCC Warning.....	29

Thank you for purchasing our Bebcare iQ digital WiFi baby monitor. Your unit has been manufactured and checked under the strictest possible quality control to ensure that each monitor leaves the factory in perfect condition. In the unlikely event you find any defects or have any problem, please contact our dealer or service center.

Please read this manual carefully to obtain maximum performance and extended service life from the unit.

Features

- 1080p high definition true colour video
- Night vision with IR LED
- Lens with 100° field of view
- Ultra green clean wireless transmission
- Horizontal 330° Vertical 110° lens movement by motorized mount
- IEEE802.11 b/g/n WiFi specifications
- Capable to view baby anywhere through smart phone or tablet PC
- Ultra compact parent unit
- Immediate baby sound alert without latency
- Baby's room temperature indication with Hi/Lo alarm
- Night light and lullaby function
- Talk back function
- Possible to set to zero radiation under standby mode
- Expandable up to two cameras
- Optional movement sensor mat to monitor baby's breathing

WARNING

The Bebcare iQ should not be regarded as a medical device. Premature babies or those considered to be at risk should be under the supervision of your doctor or health personnel.

Direct supervision of your baby at a regular interval by a responsible adult is strongly recommended in addition to using this baby monitor.

CONTROL LAYOUT and ICONS

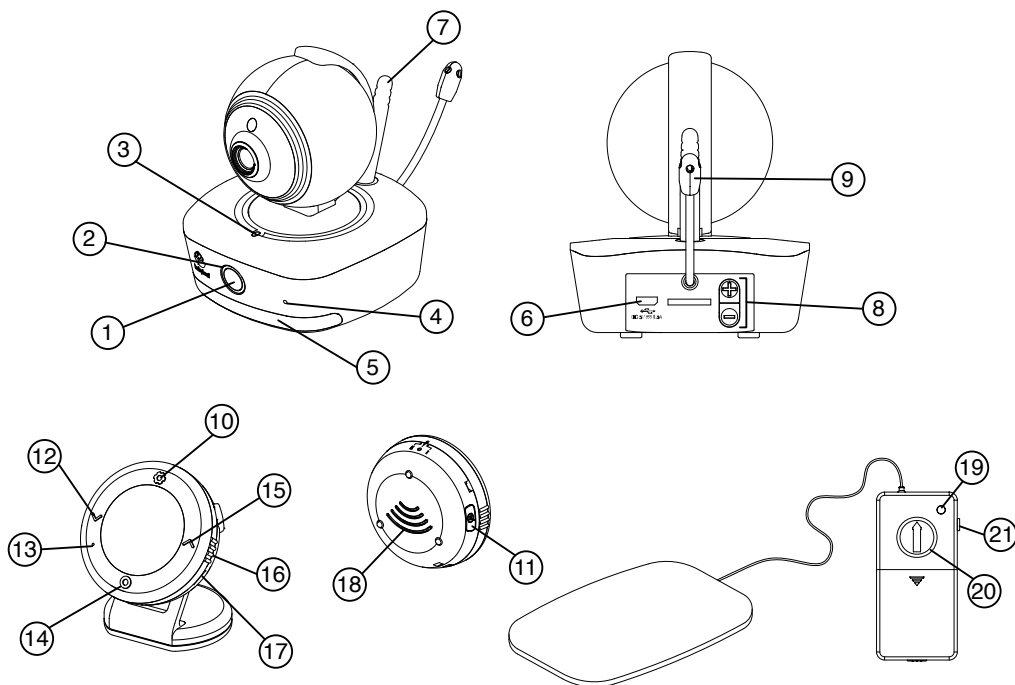

- | | | | |
|---|--|--|--|
| 1. Power button | 7. Antenna | 11. Talk button | 16. Side ring to turn on/off/vibration |
| 2. Power indicator
Green - On
Pulsating green
-Ultra safe mode | 8. Volume up/
down button | 12. Volume down
[Normal mode]
To select
[Setting mode] | 17. USB port |
| 3. Wifi indicator
Blue - WiFi on
Flashing Red
- Connecting to router | 9. Temperature sensor | 13. Mic | 18. Speaker |
| 4. Mic | 10. Setting button
Long press to enter
setting mode /Short
press to show settings
[Normal mode]
To confirm
[Setting mode] | 14. Wifi on/off or
Ultra-green mode selection | 19. Movement indicator |
| 5. Night light | | 15. Volume up [Normal mode]
To Select [Setting mode] | 20. Movement sensitivity Knob |
| 6. USB port | | | 21. Alarm hold button |

ICON SCREEN

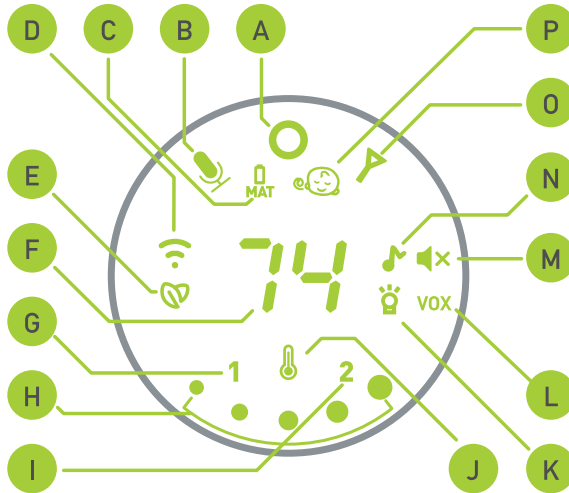

A Power Indicator

Green - On

Flashing Green - Battery low

Red - Under Charging

B Mic sensitivity

I Camera 2

C Movement sensor mat battery low

J Temperature alarm on

D WiFi on

K Night light on

E Ultra safe mode on

L Night light VOX

F Baby's room temperature

M Speaker mute

G Camera 1

N Lullaby on

H Sound level meter

O Out-of-range/Talk back

P Baby breathing alert

(O+P) Movement sensor mat out of range

POWER SUPPLY

(A) Camera

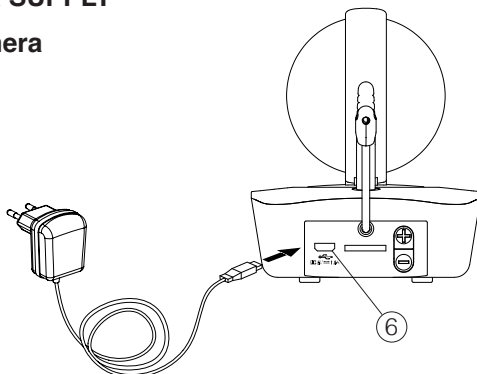



Insert the output plug of supplied 5V 1.5A AC adapter to USB port ⑥ .

(B) Parent Unit (PU)

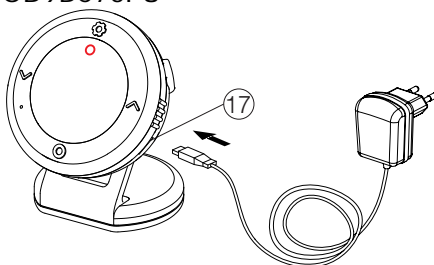
Parent Unit FCC ID:OD9BC70PU



A Li polymer battery is already incorporated in the unit. To charge up the battery, connect the output plug of supplied 5V 600mA AC adapter to USB port ⑰ . With the unit being switched off, the power indicator icon  (A) will light up red and  will show up on icon screen for 5 sec. Once the battery is fully charged up (normally it takes around 4 hours), the power indicator icon  (A) will go off or turn steady green (if unit is switched on). Now the unit is ready for operation. Either you can disconnect the AC adapter or keep connecting will cause no damage to the battery. In the latter case, when the battery is being consumed and voltage falls to a certain level, the AC adapter will automatically start charging up the battery again.

(C) Movement Sensor Mat (optionally purchased)

FCC ID:OD9BSM1

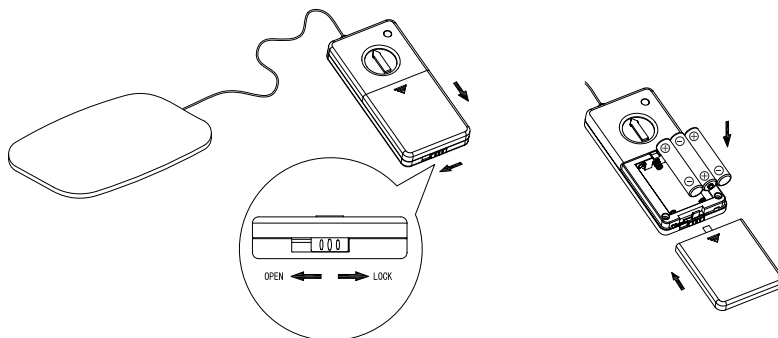



Set the lock lever to open position, slide open the battery door in direction as shown. Install 3 pcs AA (UM-2) alkaline batteries, observe correct polarities. Slide back battery door and set the lever back to lock position. The battery life can last for around 60 days when using battery such as Duracell.



PAIRING

This process is to match the PU with camera and movement sensor mat so that they can communicate with each other while no other devices (even baby monitor of identical model) can interfere with you or receiving your signal.

The PU and camera are already paired when they are shipped out from factory. However, it is necessary to perform pairing again when an extra camera is added to work with PU.

1. Press and hold the  button ⑩ of PU.
2. Rotate the side ring ⑩ to switch on unit, then release  button ⑩ after hearing a beep. The icon screen will show a “1” and a “P” flashing.
3. Press and hold the volume down  button ⑧ on one of the camera while switching on the unit by long press of power button ① until the night light ⑤ starts flashing. This indicates the camera has entered pairing mode.

N.B. Be sure not to set two cameras into pairing mode at the same time.



4. Short press  button ⑩ on PU, two beep sound will be heard which indicates pairing become successful. The night light ⑤ will go off while the “P” will stop flashing. This camera is assigned as camera no.1.
5. Now repeat step 3 on the other camera after switch off camera 1.
6. Short press  button ⑮ on PU and the icon screen will show a “2” and a “P” flashing.
7. Short press  button ⑩, two beep sound will be heard. The night light ⑤ on this camera will go off while the “P” will stop flashing. This camera is assigned as camera no. 2.

8. Switch off all units and switch on again, the baby monitor is ready for operation.
9. The pairing between camera and movement sensor mat should be performed after the successful pairing between camera and PU or otherwise the system will not operate properly.
10. Press and hold the volume up (+) button (8) on camera while switching on the unit by long press of power button (1) until the power indicator (2) starts flashing.
11. While holding down the alarm hold button (21), switch on the movement sensor mat by turning the knob (20) clockwise, two beep sound will be heard in camera, indicating pairing is successful.
12. The mat is now ready for operation, probably you will hear the breathing alarm in PU (if the baby breathing alert function is set to ON) after 20 sec in case nothing is placed on the mat. Slight tap the mat few times and the alarm will stop, this show the system is working properly.

N.B. When it is no longer necessary to monitor the baby's breathing as he grows older, the movement sensor mat is required to unpair from camera to avoid unnecessary alarms. To achieve this perform pairing process between camera and PU by repeating above steps 1- 8 but leave out steps 10 -11.

OPERATION

Camera

1. Follow the quick start guide to download the Bebcare iQ app and connect the camera to your home router.
2. Make sure to switch on the WiFi of camera using the  button ⑭ on PU with  ⑮ being shown on icon screen (camera WiFi is default to be ON when shipped out from factory). Follow the steps as shown in the app.
3. Use the app to view the image as captured by camera lens.
4. Place the camera onto a stable location out of reach of baby (preferably 1m away). When baby is newly born, you may secure the camera onto the crib handrail using the optional crib mount as shown. Make sure the AC adapter cord is fastened firmly to avoid strangulation accident.

 **WARNING: When baby grows older and able to move around in the crib, it is strongly recommended ot remove camera from the crib handrail to avoid risk of cord strangulation. Place the camera further away beyond the reach of baby.**

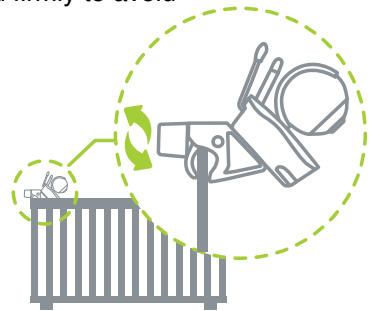

5. Adjust the microphone sensitivity (set on PU side) such that the camera will be triggered to transmit baby's voice whenever the microphone ④ picks up a sound at your desirable loudness level. Note this sensitivity is independent from the sound alert sensitivity set in the app that will activate a push notification.
6. Once the camera is switched on, the power indicator ② will light up green. When it is set to ultra safe mode from PU side, the indicator ② will show pulsating green.
7. The night light ⑤ can be set to OFF, ON or VOX (on when detecting sound) using the PU or app.

8. This camera is incorporated with lullaby function which can be remotely turned on or off using PU or app. Parents can select from 6 different factory preset song/sound. The volume of music can be adjusted using the up/down button ⑧ which also control the parents' talk back volume.
9. When there is sufficient light intensity, the app will show a colourful image. Once the environment getting dark, the IR LED in camera will automatically turn on to illuminate the surroundings and the app will show a black white image.
10. When parents prefer not to view baby on app, they can switch off the WiFi connection using the mode button ○ ⑭ on PU or further set it to Ultra safe mode 🍷. Under such circumstances, there is zero radiation under standby mode and besides, the camera cannot be hacked by other people.
11. The WiFi indicator ③ function as follow:
Steady blue – WiFi is ON
Flashing red – Camera is under connection to home router
Off – WiFi is OFF

Parent unit

1. Rotate the side ring (16) clockwise or anti-clockwise to switch on the unit (Clockwise – unit on with vibration/Anti-clockwise – unit on only).
2. The icon screen will show up for around 20 sec and if there is no sound from baby, the icons (except the power indicator icon (O)) will go off to save battery power.
3. Normally, the power indicator icon (O) (A) will show green and when battery becomes low, it will start flashing green. Once the unit is under charge, this indicator will show red.
4. To enter setting mode, long press the (gear) button (10) for 2 sec. The icon screen will show either following :

(a) When the PU is paired to two cameras

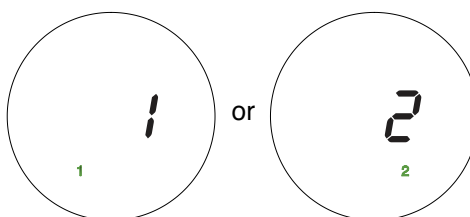

Use the (up/down) buttons (12)(15) to select between the camera to be set, press (gear) button (10) to confirm.

(b) When the PU is paired to only one camera

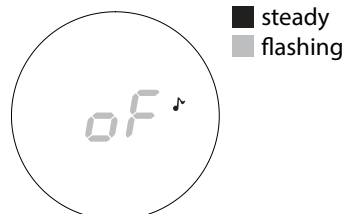



♪ Lullaby playing

Use the (up/down) buttons (12)(15) to select between ON/OFF, press (gear) button (10) to confirm. Once ON is selected, the song number will show flashing on icon screen, use (up/down) buttons (12)(15) to select the preferred music, press (gear) button (10) to confirm.



Night light

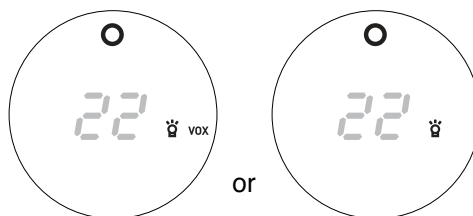

Use the  buttons (12)(15) to select between OFF, ON or VOX (on when detecting a sound). Press  button (10) to confirm.

Once ON or VOX is selected. The screen will show following:



N.B. The lullaby playing and night light status in PU and app will synchronize with each other when the setting is changed in either side.

Temperature alarm

Use the  buttons (12)(15) to select between ON/OFF, press  button (10) to confirm.



ON - PU will provide an alarm once the baby's foam temperature exceed the high and low limit as specified in the app, at the same time, the temperature reading will flash in icon screen.

OFF - no alarm will be provided

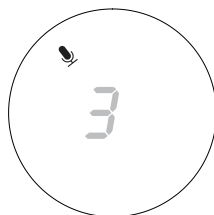







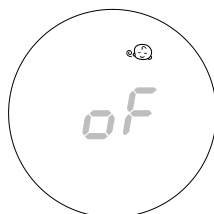



Camera microphone sensitivity

Use the  buttons (12)(15) to select between level 1 to 5, press  button (10) to confirm. Higher level means the microphone is more sensitive to baby's voice.



Breathing alert



This feature is useful when the camera is paired to a movement sensor mat. Use the  buttons (12)(15) to select between ON or OFF, press  button (10) to confirm.

ON – The PU will monitor the breathing movement of baby and  (P) will show up on icon screen. In case there is no movement for over 20 sec, it will provide an alarm and  (P) starts flashing to alert parents. Moreover, the PU will provide an alarm in case sensor mat battery is low (  show flashing on icon screen) or sensor mat is out of range from camera ( (P) and   show flashing on icon screen).



OFF – The PU will stop monitoring the movement of baby ( (P) will not show up on icon screen). Under such mode, the PU also will not provide an alarm in case the sensor mat battery level is low or the sensor mat is out of range from camera.

5. Place the PU at a reasonable distance away from camera to avoid feedback. Too close a distance will create a screeching sound at the speaker (18).
6. Once the PU receives a signal, the icon screen will light up and depending the signal is coming from which camera, the corresponding camera no. will show up together with other information (room temperature, WiFi mode or ultra safe mode, etc.) of that camera.

N.B. In case the PU is paired to only one camera, the icon screen will not show the camera no.





7. The speaker (18) volume can be adjusted using the  buttons (12)(15). The temperature reading also change correspondingly during adjustment to show the level (1 to 5) being selected. When the level is set to minimum and the  (M) show up on icon screen, the speaker (18) is totally muted. Under such circumstances, parent can still monitor the activity of baby by looking at the sound level meter. • • • • •









N.B. When the camera is under pan / tilt movement, the speaker volume will be automatically turned down to minimize the humming noise created by electric motor.

8. If the PU is paired to work with two cameras, camera 1 always has top priority. This means while the unit is listening to signal from camera 2, in case camera 1 starts transmitting, PU will immediately switch listening to camera 1 until it stops to transmit, then PU will switch back to listen to camera 2 .
9. To avoid parent missing the attendance to camera 2, while PU is listening to signal from camera 1, in case camera 2 starts to transmit, “2” will show flashing on icon screen to alert parent. If parent prefers to listen to camera 2, he can short press  button (10) and PU switches listening to camera 2 while “1” go flashing (if camera 1 still transmitting). Further press of  button (10) will switch back to camera 1 again. Under such arrangement, the parent is able to monitor both babies.
10. Under standby mode, the PU will alternately scan between the two cameras for activities. When either one of the camera starts to transmit, the PU will immediately listen to that camera and the icon screen will only show information from it until the signal goes off.
11. When the PU is set to ON with vibration, whenever a baby’s voice is detected, the vibrator starts functioning. This feature is useful when the parent is working under noisy environment (eg. vacuum cleaning). To save battery power, it is recommended not to use the vibrating alert frequently.
12. Once the PU is beyond the communication range of camera for over 30 sec, an out of range alarm will be heard together with  (10) flashing on icon screen. Besides, the temperature reading will show - - . The alarm will only go off when the PU falls back within the communication range of camera.

N.B. This alarm will also be heard in case the camera is switched off, or its power is cut off.

 **WARNING** : no out of range alarm will be provided in case the camera is set to operate with Ultra safe mode  .

13. In case the temperature alarm is set to ON, whenever the baby's room temperature falls outside the range as prescribed by the high and low temperature limits set in the app, an alarm will be heard and temperature reading starts flashing on icon screen.
14. It is possible for parent to talk back to baby to soothe his emotion. Press and hold the  button (11),   show up on icon screen. Speak towards the microphone (13). Release  button (11) after finish speaking. It is worth noted that the parent can talk back anytime they prefer, but it would not be able to hear the baby's voice during talk back.
15. The various alarm is designed to have following priority :
 Out of range alarm > Breathing alert > Temperature alarm > Battery low alarm

 Only one kind of alarm can be heard at any time to avoid confusion. An alarm can be muted by short press of anyone of     button (10) (11) (12) (15) but NOT button  (14). However, the alarm icon will keep showing on icon screen until the condition is rectified.
16. Each time any of the     button (10) (12) (14) (15) is pressed, a beep tone will be heard to validate your entry.

Movement Sensor Mat

1. Place the movement sensor mat underneath the mattress, lengthwise direction and directly under where your baby sleeps. For optimum performance, there should be no bedclothes tucked between the sensor mat and the mattress. Besides, if the mattress support is too soft (such as box spring or underpadding), a hard board is required to be placed underneath the mat to provide a firm surface for it. The size of the board should be larger than the sensor mat.

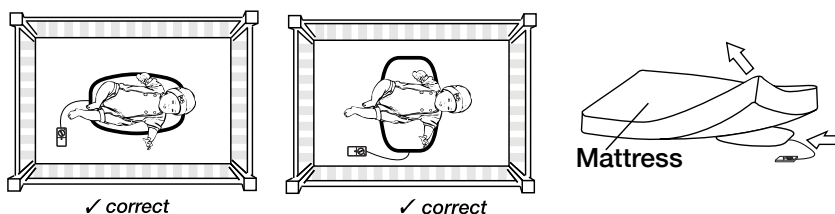

2. With the baby placed in crib, switch on sensor mat by turning the movement sensitivity knob (20) in clockwise direction. Adjust the position of knob (20) such that the movement indicator (19) will blink in pace with the breathing movement of baby.

Slip the control box underneath the mattress to keep out of reach of baby and place it as far away from the sensor mat as possible.

According to the change in weight as baby grows, it may be necessary to adjust the sensitivity setting of knob (20) again. In case the sensitivity setting is not appropriate, the movement indicator (19) will always stay ON or OFF and false alarm may occur.

N.B. Before attempting to adjust the knob (20), wait for at least 15 -20 min until the baby has settled down or fallen asleep.

3. For environment with continuous vibration from the floor, the sensor mat may have false detection and delay or prevent the alarm from sounding. Under such circumstance, move the crib to the corner of the room or near a solid supporting wall. Moreover, keep the crib away from strong draft and air current.
4. Ensure the camera and sensor mat is within the same room or apart from each other not more than a distance of 10m, otherwise they may lose connection with each other and breathing movement of baby cannot be monitored.
5. When baby needs to be taken out from crib for feeding or other purpose, to avoid false alarm on PU, short press the alarm hold button (21). This button can be pressed before or after taking out the baby, but such action must be performed within 20 sec, or otherwise the alarm would still sound. To stop alarm in PU, short press alarm hold button (21) again. Upon placing back the baby into crib, the sensor mat will automatically resume to monitor the movement of baby after 20 sec.
6. When the baby's movement increases as he grows older, he may move away from the sensor mat and cause false alarm. Additional movement sensor mat can be connected to increase the coverage.

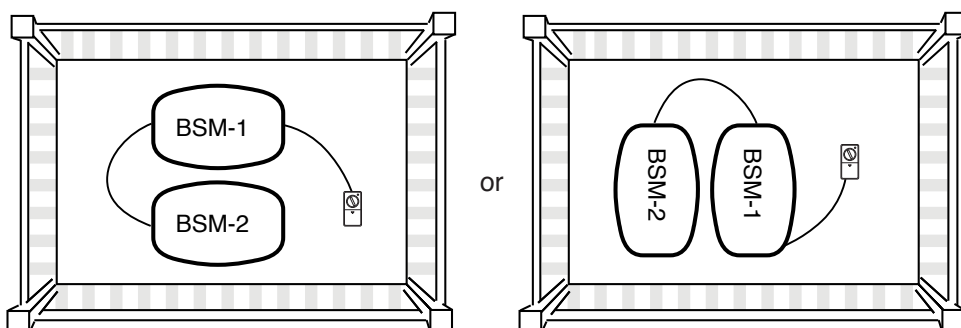

N.B. In case there are two cameras operating in the system, besure each camera and its corresponding sensor mat are far away from each other and placed in separate rooms to avoid interfering each other and creating false alarm.

CHANGING THE OPERATION MODE OF CAMERA

Use the  button (14) on PU to change the different operation mode of camera :

WiFi ON mode – the WiFi circuitry is switched on and parent can see baby's image in app.  (D) is shown in icon screen of PU.

WiFi OFF mode – the WiFi circuitry is switched off and parent unable to see baby in app.



Under such mode, there is less radiation from camera and no risk of being hacked.  (D) goes off in icon screen of PU.

Ultra Safe mode – not only WiFi is switched off, there is completely zero radiation from camera under standby.  (E) is shown in icon screen of PU.

⚠ WARNING : Parents need to be sure they are located at a position that can well receive the audio signal from camera before changing to Ultra Safe mode, since there will not be any out of range alarm under such mode to alert parent they are outside the operating range of camera.

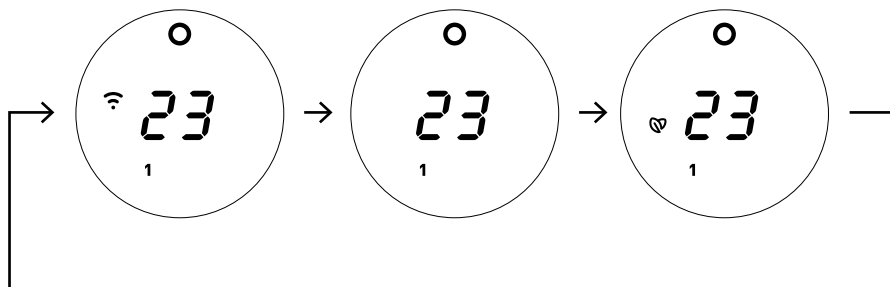
Each short press of  button (14) will change the mode in following manner :



N.B. When changing from WiFi OFF to WiFi ON mode, the WiFi indicator ③ on camera as well as  ④ on PU icon screen will show flashing. It will take around 20 - 30 sec for camera to be successfully connected to your home router. Once the WiFi indicator ③ and  ④ light up steady, the connection is done and parents are able to view baby in app.

PRECAUTIONS

- Use only the supplied AC adapters, use of other adapters may cause damage to the baby monitor.
- When not using the monitor for a long period of time, remove all batteries from movement sensor mat to avoid damage due to battery leakage.
- Disconnect the AC adapter from the wall outlet when the monitor is not to be operated.
- Do not open the cabinet, no serviceable parts inside.
- The Bebcare iQ should not be exposed to dripping, splashing and that no objects filled with liquids, such as vases shall be placed on it.
- Batteries (battery pack or batteries installed) shall not be exposed to excessive heat such as sunshine, fire or the like.

STANDARD ACCESSORIES

- a. Camera
- b. Parent unit with belt clip
- c. Stand for PU
- d. Instruction manual
- e. 3.7V Li polymer rechargeable battery pack (installed in PU)
- f. 5V AC adapters x 2
- g. Lanyard x 1

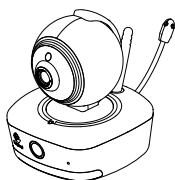

a.



b.



c.

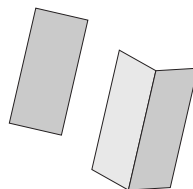

d.



e.

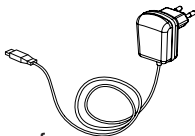



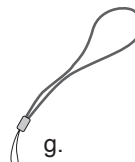

f.



g.

TROUBLE SHOOTING GUIDE

Problem	Possible Causes	Solution
Unable to see baby's image in app	<ul style="list-style-type: none"> - Camera WiFi is off - Password is incorrect - Home router is down - Camera is not connected to router - Your home internet has network bandwidth of less than 8 Mbps - Camera operating system is crashed - Your phone is connected to a router probably with firewall 	<ul style="list-style-type: none"> - Switch on WiFi using  button (14) on PU - Input correct password in app - Switch off home router and reboot after 1 min - Perform set up process again "start with pairing to add camera" - Change to another ISP that has bandwidth over 20 Mbps - Switch off and then switch on camera again - Change connecting to another router or use 4G cellular network to view baby
Image of baby is not smooth but always freezed	<ul style="list-style-type: none"> - Too many devices using same router as your camera - Your internet bandwidth is not enough to support HD image 	<ul style="list-style-type: none"> - Disconnect some other devices from your router - Change to view baby with lower resolution(e.g. instead of 1080p HD smooth, SD or 720p)
Parent unit unable to receive audio from camera	<ul style="list-style-type: none"> - Mic sensitivity is too low - Distance between camera & PU exceeds the operationing range and ultra safe mode is ON 	<ul style="list-style-type: none"> - Adjust mic sensitivity higher using PU - Move the camera and PU closer together
Audio always transmitting	<ul style="list-style-type: none"> - Mic sensitivity is too high 	<ul style="list-style-type: none"> - Adjust mic sensitivity lower using PU
Out-of-range alarm always on	<ul style="list-style-type: none"> - Pairing is not successful - Camera power is cut off - Distance between camera & PU exceeds the operationing range 	<ul style="list-style-type: none"> - Perform pairing again - Check if camera is switched on - Move the camera and PU closer together
Temperature alarm always on	<ul style="list-style-type: none"> - The high and low temperature-limit is set too close to the current reading in app 	<ul style="list-style-type: none"> - Set the high and low emperature limit around 5°C difference from current reading
 Icon always show flashing and alarm heard	<ul style="list-style-type: none"> - Baby is not in the crib - Sensitivity of sensor mat is not properly set - Baby's breathing is abnormal 	<ul style="list-style-type: none"> - Short press hold buttom  on sensor mat control box - Adjust sensitivity using movement sensitivity knob  such that the movement indicator  blink in pace with baby's breathing - Take immediate care of baby and consult doctor

TROUBLE SHOOTING GUIDE

Problem	Possible Causes	Solution
□ <small>MAT</small> and ∇ always show flashing	<ul style="list-style-type: none"> - Sensor mat is off - Battery of sensor mat is running down - Distance between BU and mat exceed 10m 	<ul style="list-style-type: none"> - Switch on sensor mat using movement sensitivity knob ②① - Replace with new battery - Move BU closer to sensor mat
PU always showing low battery alert	<ul style="list-style-type: none"> - Battery has run down - Battery pack is damaged 	<ul style="list-style-type: none"> - Recharge battery using AC adapter - Consult your dealer to change new battery
Battery life is short	<ul style="list-style-type: none"> - Vibration alert is switched on 	<ul style="list-style-type: none"> - Switch off vibration alert(PU)
Too short communication range	<ul style="list-style-type: none"> - Many steel structures between Camera and PU 	<ul style="list-style-type: none"> - Re-locate camera or PU
Camera & PU cannot communication with each other	<ul style="list-style-type: none"> - Pairing is lost 	<ul style="list-style-type: none"> - Perform pairing process again

DECLARATION OF CONFORMITY

SPECIFICATION

Camera

1080P High Definition Full HD true colour video

IEEE 802.11 b/g/n WiFi specifications

Lens with 100° view angle

330° pan and 110° tilt movement angle

5V 1.5A DC power supply

Parent unit

30 hours of battery standby time (fully charged condition)

3.7V 800mAh Li battery installed

5V 600mA DC power supply

This equipment complies with FCC radiation exposure limits set forth for an uncontrolled environment. This equipment should be installed and operated with minimum distance 20cm between the radiator & your body.
This transmitter must not be co-located or operating in conjunction with any other antenna or transmitter.

FCC Warning:

Any Changes or modifications not expressly approved by the party responsible for compliance could void the user's authority to operate the equipment.

This device complies with part 15 of the FCC Rules. Operation is subject to the following two conditions: (1) This device may not cause harmful interference, and (2) this device must accept any interference received, including interference that may cause undesired operation.

FCC Radiation Exposure Statement:

This equipment complies with FCC radiation exposure limits set forth for an uncontrolled environment. This equipment should be installed and operated with minimum distance 20cm between the radiator& your body.

This transmitter must not be co-located or operating in conjunction with any other antenna or transmitter.

Note: This equipment has been tested and found to comply with the limits for a Class B digital device, pursuant to part 15 of the FCC Rules. These limits are designed to provide reasonable protection against harmful interference in a residential installation. This equipment generates uses and can radiate radio frequency energy and, if not installed and used in accordance with the instructions, may cause harmful interference to radio communications. However, there is no guarantee that interference will not occur in a particular installation. If this equipment does cause harmful interference to radio or television reception, which can be determined by turning the equipment off and on, the user is encouraged to try to correct the interference by one or more of the following measures:

- Reorient or relocate the receiving antenna.
- Increase the separation between the equipment and receiver.
- Connect the equipment into an outlet on a circuit different from that to which the receiver is connected.
- Consult the dealer or an experienced radio/TV technician for help.