



TEST REPORT

Test report no.: 1-0948/20-01-13

BNetzA-CAB-02/21-102

Testing laboratory

CTC advanced GmbH

Untertuerkheimer Strasse 6 – 10

66117 Saarbruecken / Germany

Phone: + 49 681 5 98 - 0

Fax: + 49 681 5 98 - 9075

Internet: <https://www.ctcadvanced.com>

e-mail: mail@ctcadvanced.com

Accredited Testing Laboratory:

The testing laboratory (area of testing) is accredited according to DIN EN ISO/IEC 17025 (2018-03) by the Deutsche Akkreditierungsstelle GmbH (DAkkS)

The accreditation is valid for the scope of testing procedures as stated in the accreditation certificate starting with the registration number: D-PL-12076-01.

Applicant

VEGA Grieshaber KG

Am Hohenstein 113

77761 Schiltach / GERMANY

Phone: +49 783 650-0

Contact: Klaus Mayer

e-mail: k.mayer@vega.com

Manufacturer

VEGA Grieshaber KG

Am Hohenstein 113

77761 Schiltach / GERMANY

Test standard/s

FCC - Title 47 CFR Part 22 FCC - Title 47 of the Code of Federal Regulations; Chapter I; Part 22 - Public mobile services

FCC - Title 47 CFR Part 24 FCC - Title 47 of the Code of Federal Regulations; Chapter I; Part 24 - Personal communications services

For further applied test standards please refer to section 3 of this test report.

Test Item

Kind of test item: **External radio communication unit for level sensors and point level detection sensors**

Model name: **PLICSMOBILE**

FCC ID: **O6QPMT8X4G**

IC: **3892A-PMT8X4G**

Frequency: GSM850; PCS1900; WCDMA bands 2/4/5; LTE bands 2/4/5/7/17

Technology tested: GSM, UMTS, LTE

Antenna: Integrated antenna (BMLPVMBLTENGP)

Power supply: 9.6 V DC to 32 V DC by external power supply

Temperature range: -25°C to +60°C

This test report is electronically signed and valid without handwritten signature. For verification of the electronic signatures, the public keys can be requested at the testing laboratory.

Test report authorized:

Andreas Luckenbill
Head of Department
Radio Communications

Test performed:

Marco Bertolino
Lab Manager
Radio Communications

1 Table of contents

1	Table of contents	2
2	General information	5
2.1	Notes and disclaimer	5
2.2	Application details	5
2.3	Test laboratories sub-contracted	5
3	Test standard/s, references and accreditations	6
4	Reporting statements of conformity – decision rule	7
5	Test environment	8
6	Test item	8
6.1	General description	8
6.2	Additional information	9
7	Description of the test setup	9
7.1	Shielded semi anechoic chamber	10
7.2	Shielded fully anechoic chamber	11
7.3	Radiated measurements > 18 GHz	12
7.4	Conducted measurements	13
8	Sequence of testing	14
8.1	Sequence of testing radiated spurious 9 kHz to 30 MHz	14
8.2	Sequence of testing radiated spurious 30 MHz to 1 GHz	15
8.3	Sequence of testing radiated spurious 1 GHz to 18 GHz	16
8.4	Sequence of testing radiated spurious above 18 GHz	17
9	Measurement uncertainty	18
10	Summary of measurement results GSM / WCDMA	19
10.1	GSM 850	19
10.2	PCS 1900	19
10.3	UMTS band II	20
10.4	UMTS band IV	20
10.5	UMTS band V	21
11	Results GSM 850	22
11.1	RF output power	22
11.2	Spurious emissions radiated	28
12	Results PCS 1900	34
12.1	RF output power	34
12.2	Spurious emissions radiated	40
13	Results UMTS band II	46
13.1	RF output power	46
13.2	Spurious emissions radiated	50
14	Results UMTS band IV	54
14.1	RF output power	54

14.2	Spurious emissions radiated	58
15	Results UMTS band V	62
15.1	RF output power	62
15.2	Spurious emissions radiated	66
16	Summary of measurement results LTE band 2	70
16.1	LTE – Band 2	70
17	RF measurements LTE band 2	71
17.1	Description of test setup.....	71
17.2	Results	71
17.2.1	RF output power	71
17.2.2	Spurious emissions radiated.....	75
18	Summary of measurement results LTE band 5	81
18.1	LTE – Band 5	81
19	RF measurements LTE band 5	82
19.1	Description of test setup.....	82
19.2	Results	82
19.2.1	RF output power	82
19.2.2	Spurious emissions radiated.....	85
20	Summary of measurement results LTE band 4	91
20.1	LTE – Band 4	91
21	RF measurements LTE band 4	92
21.1	Description of test setup.....	92
21.2	Results LTE	92
21.2.1	RF output power	92
21.2.2	Spurious emissions radiated.....	96
22	Summary of measurement results LTE band 7	102
22.1	LTE – Band 7	102
23	RF measurements LTE band 7	103
23.1	Description of test setup.....	103
23.2	Results LTE – Band 7	103
23.2.1	RF output power	103
23.2.2	Spurious emissions radiated.....	106
24	Summary of measurement results LTE band 17	112
24.1	LTE – Band 17	112
25	RF measurements LTE 17	113
25.1	Description of test setup.....	113
25.2	Results LTE – Band 17	113
25.2.1	RF output power	113
25.2.2	Spurious emissions radiated.....	116
26	Observations.....	121
27	Glossary.....	122

28	Document history.....	123
29	Accreditation Certificate – D-PL-12076-01-04	123
30	Accreditation Certificate – D-PL-12076-01-05	124

2 General information

2.1 Notes and disclaimer

The test results of this test report relate exclusively to the test item specified in this test report. CTC advanced GmbH does not assume responsibility for any conclusions and generalizations drawn from the test results with regard to other specimens or samples of the type of the equipment represented by the test item.

The test report may only be reproduced or published in full. Reproduction or publication of extracts from the report requires the prior written approval of CTC advanced GmbH.

The testing service provided by CTC advanced GmbH has been rendered under the current "General Terms and Conditions for CTC advanced GmbH".

CTC advanced GmbH will not be liable for any loss or damage resulting from false, inaccurate, inappropriate or incomplete product information provided by the customer.

Under no circumstances does the CTC advanced GmbH test report include any endorsement or warranty regarding the functionality, quality or performance of any other product or service provided.

Under no circumstances does the CTC advanced GmbH test report include or imply any product or service warranties from CTC advanced GmbH, including, without limitation, any implied warranties of merchantability, fitness for purpose, or non-infringement, all of which are expressly disclaimed by CTC advanced GmbH.

All rights and remedies regarding vendor's products and services for which CTC advanced GmbH has prepared this test report shall be provided by the party offering such products or services and not by CTC advanced GmbH.

In no case this test report can be considered as a Letter of Approval.

This test report is electronically signed and valid without handwritten signature. For verification of the electronic signatures, the public keys can be requested at the testing laboratory.

2.2 Application details

Date of receipt of order:	2021-03-24
Date of receipt of test item:	2021-05-03
Start of test:*	2021-05-07
End of test:*	2021-05-28
Person(s) present during the test:	-/-

*Date of each measurement, if not shown in the plot, can be requested. Dates are stored in the measurement software.





2.3 Test laboratories sub-contracted

None

3 Test standard/s, references and accreditations

Test standard	Date	Description
FCC - Title 47 CFR Part 22	-/-	FCC - Title 47 of the Code of Federal Regulations; Chapter I; Part 22 - Public mobile services
FCC - Title 47 CFR Part 24	-/-	FCC - Title 47 of the Code of Federal Regulations; Chapter I; Part 24 - Personal communications services
FCC - Title 47 CFR Part 27	-/-	FCC - Title 47 of the Code of Federal Regulations; Chapter I; Part 27 - Miscellaneous wireless communications services
RSS - 132 Issue 3	January 2013	Spectrum Management and Telecommunications Radio Standards Specification - Cellular Telephone Systems Operating in the Bands 824-849 MHz and 869-894 MHz
RSS - 133 Issue 6	January 2018	Spectrum Management and Telecommunications Policy - Radio Standards Specifications, 2 GHz Personal Communication Services
RSS - 139 Issue 3	July 2015	Spectrum Management and Telecommunications Radio Standards Specification - Advanced Wireless Services (AWS) Equipment Operating in the Bands 1710-1755 MHz and 2110-2180 MHz

Guidance	Version	Description
ANSI C63.4-2014	-/-	American National Standard for Methods of Measurement of Radio-Noise Emissions from Low-Voltage Electrical and Electronic Equipment in the Range of 9 kHz to 40 GHz
ANSI C63.26-2015	-/-	American National Standard for Compliance Testing of Transmitters Used in Licensed Radio Services
Power Meas License Systems: KDB 971168 D01	v03r01	Measurement Guidance for Certification of Licensed Digital Transmitters

Accreditation	Description	
D-PL-12076-01-04	Telecommunication and EMC Canada https://www.dakks.de/as/ast/d/D-PL-12076-01-04e.pdf	 
D-PL-12076-01-05	Telecommunication FCC requirements https://www.dakks.de/as/ast/d/D-PL-12076-01-05e.pdf	 

4 Reporting statements of conformity – decision rule

Only the measured values related to their corresponding limits will be used to decide whether the equipment under test meets the requirements of the test standards listed in chapter 3. The measurement uncertainty is mentioned in this test report, see chapter 9, but is not taken into account - neither to the limits nor to the measurement results. Measurement results with a smaller margin to the corresponding limits than the measurement uncertainty have a potential risk of more than 5% that the decision might be wrong."

measured value, measurement uncertainty, verdict

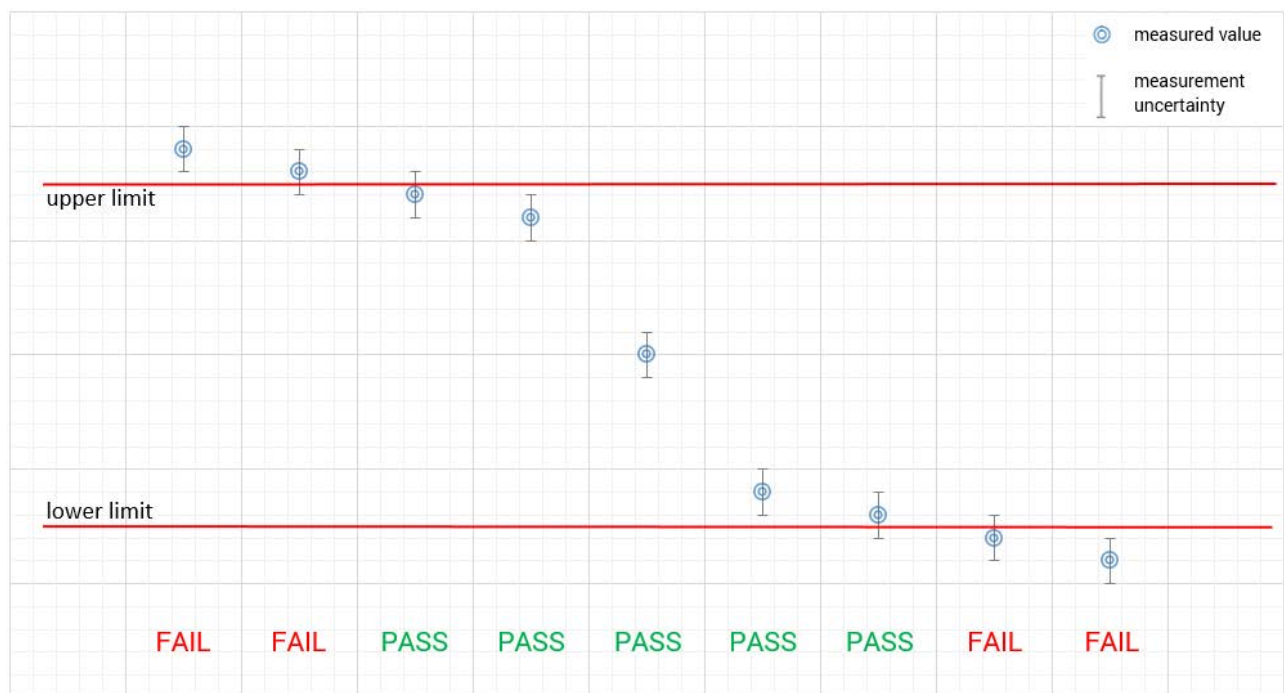

5 Test environment

Temperature	:	T_{nom} +22 °C during room temperature tests T_{max} No test under extreme temperature conditions performed. T_{min} No test under extreme temperature conditions performed.
Relative humidity content	:	42 %
Barometric pressure	:	1021 hpa
Power supply	:	V_{nom} 24 V DC by external power supply V_{max} No test under extreme voltage conditions performed. V_{min} No test under extreme voltage conditions performed.

6 Test item

6.1 General description

Kind of test item	:	External radio communication unit for level sensors and point level detection sensors
Model name	:	PLICSMOBILE
HMN	:	-/-
PMN	:	PLICSMOBILE T81
HVIN	:	PMT8X4G
FVIN	:	-/-
S/N serial number	:	IMEI GSM/PCS: 356912101976237 WCDM/LTE: -/-
Hardware status	:	2.0
Software status	:	2.0
Firmware status	:	2.0
Frequency band	:	GSM850; PCS1900; WCDMA bands 2/4/5; LTE bands 2/4/5/7/17
Type of radio transmission	:	modulated carrier
Use of frequency spectrum	:	
Type of modulation	:	GMSK; QPSK; 16-QAM
Antenna	:	Integrated antenna (BMLPVMBLTENGP)
Power supply	:	9.6 V DC to 32 V DC by external power supply
Temperature range	:	-25°C to +60°C

The plastic housing variant was tested in this test report. For the metal housing systems, see report 1-0948/20-01-14.

6.2 Additional information

The content of the following annexes is defined in the QA. It may be that not all of the listed annexes are necessary for this report, thus some values in between may be missing.

Test setup and EUT photos are included in test report:

- 1-0948/20-01-01_AnnexA
- 1-0948/20-01-01_AnnexB
- 1-0948/20-01-01_AnnexD

7 Description of the test setup

Typically, the calibrations of the test apparatus are commissioned to and performed by an accredited calibration laboratory. The calibration intervals are determined in accordance with the DIN EN ISO/IEC 17025. In addition to the external calibrations, the laboratory executes comparison measurements with other calibrated test systems or effective verifications. Weekly chamber inspections and range calibrations are performed. Where possible, RF generating and signaling equipment as well as measuring receivers and analyzers are connected to an external high-precision 10 MHz reference (GPS-based or rubidium frequency standard).

In order to simplify the identification of the equipment used at some special tests, some items of test equipment and ancillaries can be provided with an identifier or number in the equipment list below (Lab/Item).

Each block diagram listed can contain several test setup configurations. All devices belonging to a test setup are identified with the same letter syntax. For example: Column Setup and all devices with an A.

Agenda: Kind of Calibration

k	calibration / calibrated	EK	limited calibration
ne	not required (k, ev, izw, zw not required)	zw	cyclical maintenance (external cyclical maintenance)
ev	periodic self verification	izw	internal cyclical maintenance
Ve	long-term stability recognized	g	blocked for accredited testing
vkl!	Attention: extended calibration interval		
NK!	Attention: not calibrated	*)	next calibration ordered / currently in progress

7.1 Shielded semi anechoic chamber

The radiated measurements are performed in vertical and horizontal plane in the frequency range from 30 MHz to 1 GHz in semi-anechoic chambers. The EUT is positioned on a non-conductive support with a height of 0.80 m above a conductive ground plane that covers the whole chamber. The receiving antennas are conform to specifications ANSI C63. These antennas can be moved over the height range between 1.0 m and 4.0 m in order to search for maximum field strength emitted from EUT. The measurement distances between EUT and receiving antennas are indicated in the test setups for the various frequency ranges. For each measurement, the EUT is rotated in all three axes until the maximum field strength is received. The wanted and unwanted emissions are received by spectrum analyzers where the detector modes and resolution bandwidths over various frequency ranges are set according to requirement ANSI C63.

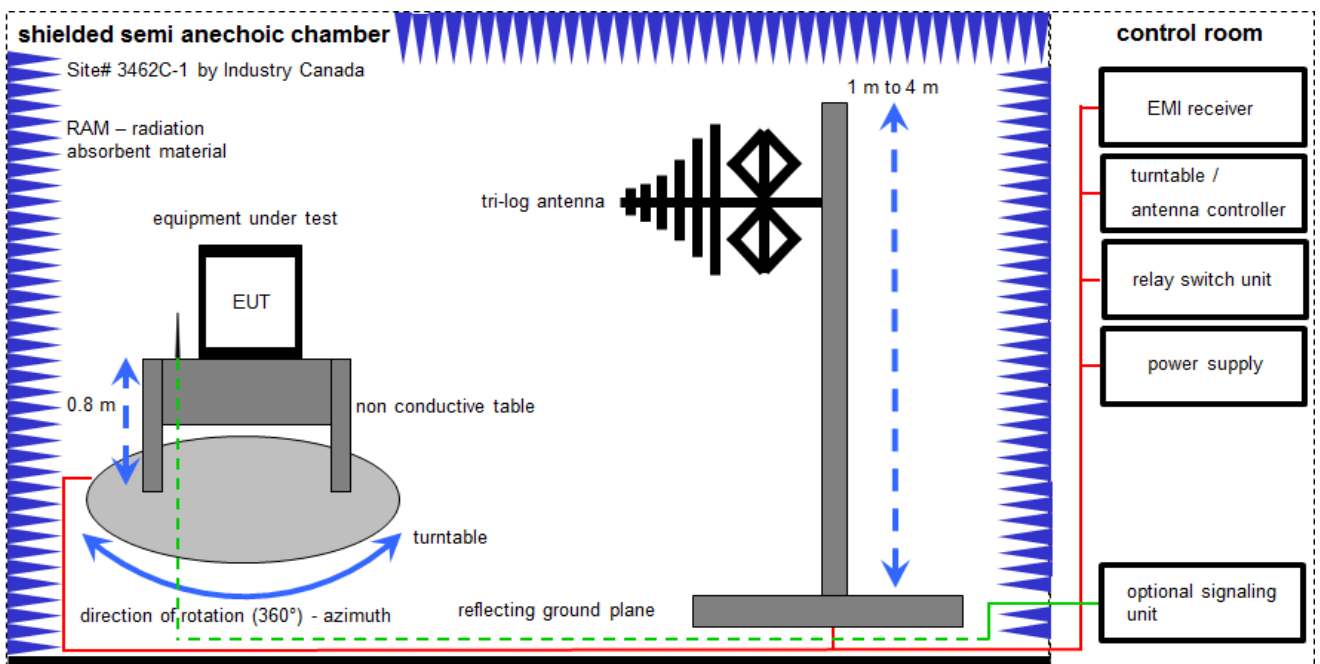

Measurement distance: tri-log antenna 10 meter; EMC32 software version: 10.59.00

Equipment table:

No.	Lab / Item	Equipment	Type	Manufacturer	Serial No.	INV. No.	Kind of Calibration	Last Calibration	Next Calibration
1	A, B	Switch-Unit	3488A	HP	2719A14505	300000368	ev	-/-	-/-
2	A, B	Semi anechoic chamber	3000023	MWB AG	-/-	300000551	ne	-/-	-/-
3	A, B	Antenna Tower	Model 2175	ETS-Lindgren	64762	300003745	izw	-/-	-/-
4	A, B	Positioning Controller	Model 2090	ETS-Lindgren	64672	300003746	izw	-/-	-/-
5	A, B	Turntable Interface-Box	Model 105637	ETS-Lindgren	44583	300003747	izw	-/-	-/-
6	A, B	TRILOG Broadband Test-Antenna 30 MHz - 3 GHz	VULB9163	Schwarzbeck Mess-Elektronik	318	300003696	vKI!	04.09.2019	03.09.2021
7	A, B	Turntable	2089-4.0	EMCO	-/-	300004394	ne	-/-	-/-
8	A, B	PC	TecLine	F+W	-/-	300004388	ne	-/-	-/-
9	A, B	EMI Test Receiver	ESR3	Rohde & Schwarz	102587	300005771	k	10.12.2020	09.06.2022
10	B	Wideband Radio Communication Tester	CMW500	R&S	116854	300004625	k	09.12.2020	08.12.2022
11	A	Universal Radio Communication Tester	CMU200	R&S	103992	300003231	vKI!	10.12.2020	09.12.2022

7.2 Shielded fully anechoic chamber

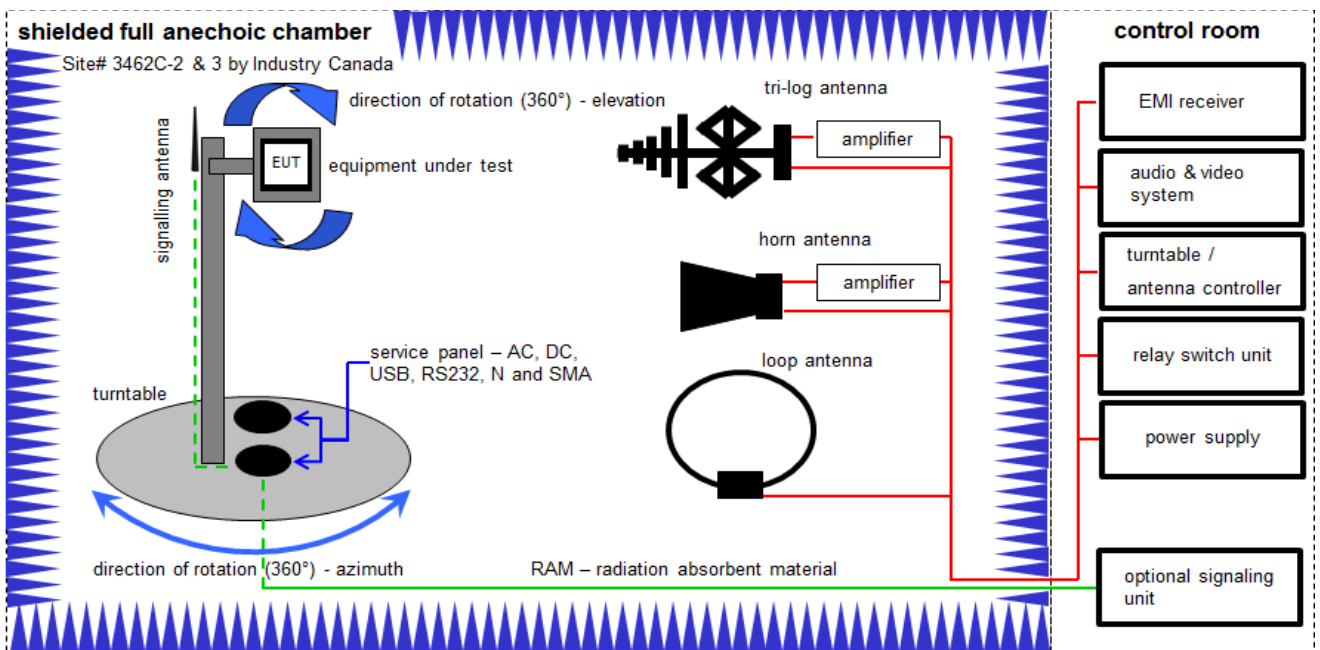

Measurement distance: tri-log antenna and horn antenna 3 meter; loop antenna 3 meter / 1 meter

$$OP = AV + D - G + CA$$

(OP-radiated output power; AV-analyzer value; D-free field attenuation of measurement distance; G-antenna gain+amplifier gain; CA-loss signal path)

Example calculation:

$$OP [dBm] = -65.0 [dBm] + 50 [dB] - 20 [dBi] + 5 [dB] = -30 [dBm] (1 \mu W)$$

Equipment table:

No.	Lab / Item	Equipment	Type	Manufacturer	Serial No.	INV. No.	Kind of Calibration	Last Calibration	Next Calibration
1	A	Active Loop Antenna 9 kHz to 30 MHz	6502	EMCO	2210	300001015	vKI!	13.06.2019	12.06.2021
2	B	Highpass Filter	WHK1.1/15G-10SS	Wainwright	37	400000148	ne	-/-	-/-
3	B	Band Reject Filter	WRCG1850/1910-1835/1925-40/8SS	Wainwright	23	400000149	ne	-/-	-/-
4	B	Highpass Filter	WHKX7.0/18G-8SS	Wainwright	18	300003789	ne	-/-	-/-
5	B	Band Reject Filter	WRCG824/849-810/863-60/9SS	Wainwright	6	300003791	ne	-/-	-/-
6	B	Band Reject Filter	WRCG1710/1755-1690/1775-90/14SS	Wainwright	7	300003793	ne	-/-	-/-
7	B	Broadband Amplifier 0.5-18 GHz	CBLU5184540	CERNEX	22051	300004483	ev	-/-	-/-
8	A, B	4U RF Switch Platform	L4491A	Agilent Technologies	MY50000032	300004510	ne	-/-	-/-
9	A, B	Computer	Intel Core i3 3220/3,3 GHz, Prozessor	-/-	2V2403033A 5421	300004591	ne	-/-	-/-
10	B	Highpass Filter	WHKX2.6/18G-10SS	Wainwright	12	300004651	ne	-/-	-/-
11	A, B	NEXIO EMV-Software	BAT EMC V3.20.0.17	EMCO	-/-	300004682	ne	-/-	-/-
12	A, B	Anechoic chamber	-/-	TDK	-/-	300003726	ne	-/-	-/-
13	A, B	EMI Test Receiver 9kHz-26,5GHz	ESR26	Rohde & Schwarz	101376	300005063	k	09.12.2020	08.12.2021
14	A, B	Double-Ridged Waveguide Horn Antenna 1-18.0GHz	3115	EMCO	8812-3089	300000307	vKI!	28.08.2019	27.08.2021
15	A, B	Wideband Radio Communication Tester	CMW500	R&S	116854	300004625	k	09.12.2020	08.12.2022
16	A, B	Universal Radio Communication Tester	CMU200	R&S	103992	300003231	vKI!	10.12.2020	09.12.2022

7.3 Radiated measurements > 18 GHz

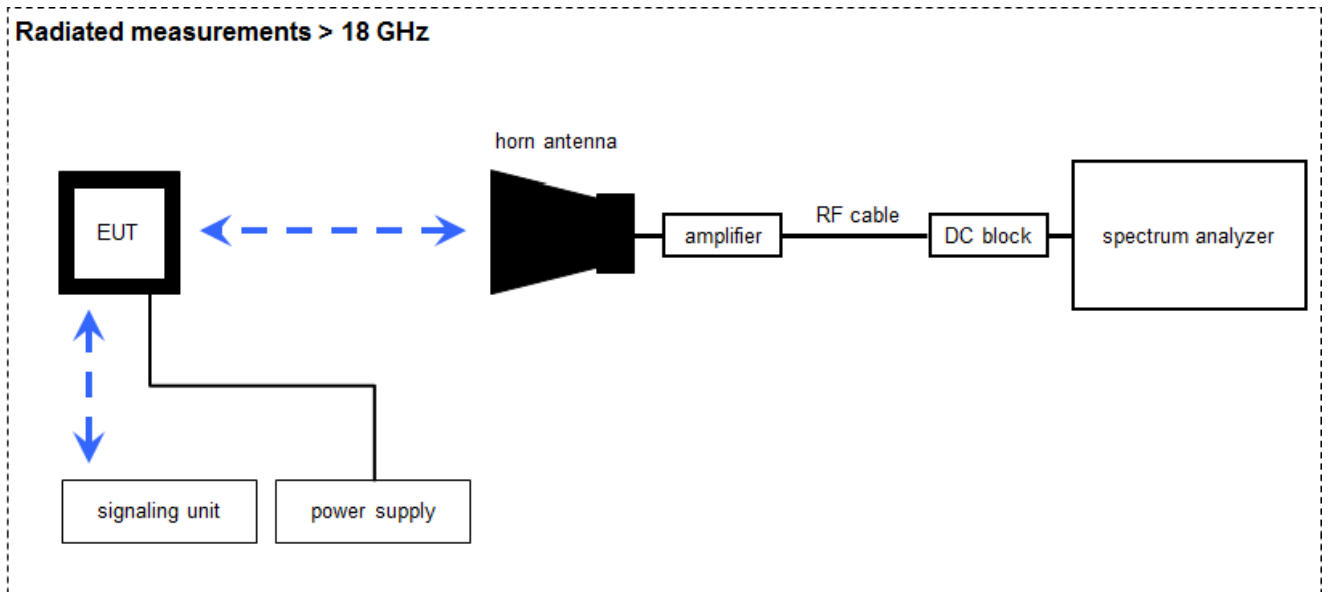

Measurement distance: horn antenna 50 cm

$$OP = AV + D - G + CA$$

(OP-radiated output power; AV-analyzer value; D-free field attenuation of measurement distance; G-antenna gain+amplifier gain; CA-loss signal path)

Example calculation:

$$OP \text{ [dBm]} = -59.0 \text{ [dBm]} + 44.0 \text{ [dB]} - 20.0 \text{ [dBi]} + 5.0 \text{ [dB]} = -30 \text{ [dBm]} \text{ (1 } \mu\text{W)}$$

Equipment table:

No.	Lab / Item	Equipment	Type	Manufacturer	Serial No.	INV. No.	Kind of Calibration	Last Calibration	Next Calibration
1	A	Wideband Radio Communication Tester	CMW500	R&S	116854	300004625	k	09.12.2020	08.12.2022
2	A, B	Microwave System Amplifier, 0.5-26.5 GHz	83017A	HP	00419	300002268	ev	-/-	-/-
3	A, B	Std. Gain Horn Antenna 18.0-26.5 GHz	638	Narda	01096	300000486	vKI!	21.01.2020	20.01.2022
4	A, B	Signal Analyzer 40 GHz	FSV40	Rohde & Schwarz	101042	300004517	k	07.12.2020	06.12.2021
5	A, B	RF-Cable	ST18/SMAM/SMAM /48	Huber & Suhner	Batch no. 600918	400001182	ev	-/-	-/-
6	A, B	DC-Blocker 0.1-40 GHz	8141A	Inmet	-/-	400001185	ev	-/-	-/-
7	B	Universal Radio Communication Tester	CMU200	R&S	103992	300003231	vKI!	10.12.2020	09.12.2022

7.4 Conducted measurements

Conducted measurements normal conditions

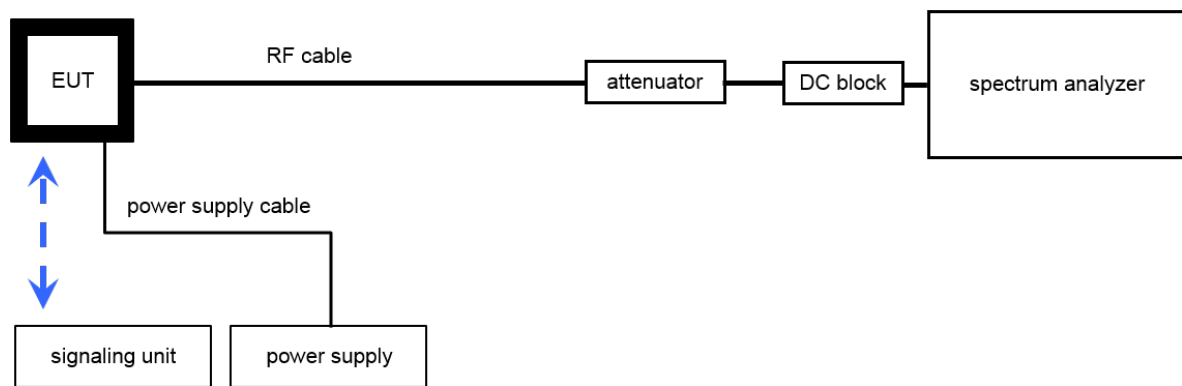

OP = AV + CA
(OP-output power; AV-analyzer value; CA-loss signal path)

Example calculation:

OP [dBm] = 6.0 [dBm] + 11.7 [dB] = 17.7 [dBm] (58.88 mW)

Equipment table:

No.	Lab / Item	Equipment	Type	Manufacturer	Serial No.	INV. No.	Kind of Calibration	Last Calibration	Next Calibration
1	B	Wideband Radio Communication Tester	CMW500	R&S	116854	300004625	k	09.12.2020	08.12.2022
2	A	Universal Radio Communication Tester	CMU200	R&S	103992	300003231	vKI!	10.12.2020	09.12.2022
3	A, B	Signal Analyzer 40 GHz	FSV40	Rohde & Schwarz	101042	300004517	k	07.12.2020	06.12.2021
4	A, B	Isolating Transformer	RT5A	Grundig	12780	300001166	ev	-/-	-/-
5	A, B	Hygro-Thermometer	-/, 5-45°C, 20-100%rF	Thies Clima	-/-	400000108	ev	13.08.2020	12.08.2022
6	A, B	PC Tester R005	Intel Core i3 3220/3,3 GHz, Prozessor	-/-	2V2403033A4523	300004589	ne	-/-	-/-
7	A, B	Teststand	Teststand Custom Sequence Editor	National Instruments GmbH	-/-	300004590	ne	-/-	-/-
8	A, B	PowerSplitter/Combiner 150-6000MHz N-Type	ZB3PD-63-N+	Mini-Circuits	-/-	400000451	ev	-/-	-/-
9	A, B	RF-Cable	ST18/SMAm/SMAm /48	Huber & Suhner	Batch no. 127377	400001183	ev	-/-	-/-
10	A, B	RF-Cable	ST18/SMAm/SMAm /72	Huber & Suhner	Batch no. 699714	400001184	ev	-/-	-/-
11	A, B	Synchron Power Meter	SPM-4	CTC	1	300005580	ev	-/-	-/-

8 Sequence of testing

8.1 Sequence of testing radiated spurious 9 kHz to 30 MHz

Setup

- The equipment is set up to simulate normal operation mode as described in the user manual or defined by the manufacturer.
- If the EUT is a tabletop system, it is placed on a table with 0.8 m height.
- If the EUT is a floor standing device, it is placed directly on the turn table.
- Auxiliary equipment and cables are positioned to simulate normal operation conditions as described in ANSI C 63.4.
- The AC power port of the EUT (if available) is connected to a power outlet below the turntable.
- Measurement distance is 3 m (see ANSI C 63.4) – see test details.
- EUT is set into operation.

Premeasurement*

- The turntable rotates from 0° to 315° using 45° steps.
- The antenna height is 1 m.
- At each turntable position the analyzer sweeps with positive-peak detector to find the maximum of all emissions.

Final measurement

- Identified emissions during the pre-measurement are maximized by the software by rotating the turntable from 0° to 360°.
- Loop antenna is rotated about its vertical axis for maximum response at each azimuth about the EUT. (For certain applications, the loop antenna plane may also need to be positioned horizontally at the specified distance from the EUT)
- The final measurement is done in the position (turntable and elevation) causing the highest emissions with quasi-peak (as described in ANSI C 63.4).
- Final levels, frequency, measuring time, bandwidth, turntable position, correction factor, margin to the limit and limit will be recorded. A plot with the graph of the premeasurement and the limit is stored.

*Note: The sequence will be repeated three times with different EUT orientations.

8.2 Sequence of testing radiated spurious 30 MHz to 1 GHz

Setup

- The equipment is set up to simulate normal operation mode as described in the user manual or defined by the manufacturer.
- If the EUT is a tabletop system, a table with 0.8 m height is used, which is placed on the ground plane.
- If the EUT is a floor standing device, it is placed on the ground plane with insulation between both.
- Auxiliary equipment and cables are positioned to simulate normal operation conditions as described in ANSI C 63.4.
- The AC power port of the EUT (if available) is connected to a power outlet below the turntable.
- Measurement distance is 10 m or 3 m (see ANSI C 63.4) – see test details.
- EUT is set into operation.

Premeasurement

- The turntable rotates from 0° to 315° using 45° steps.
- The antenna is polarized vertical and horizontal.
- The antenna height changes from 1 m to 3 m.
- At each turntable position, antenna polarization and height the analyzer sweeps three times in peak to find the maximum of all emissions.

Final measurement

- The final measurement is performed for at least six highest peaks according to the requirements of the ANSI C63.4.
- Based on antenna and turntable positions at which the peak values are measured the software maximize the peaks by changing turntable position $\pm 45^\circ$ and antenna height between 1 and 4 m.
- The final measurement is done with quasi-peak detector (as described in ANSI C 63.4).
- Final levels, frequency, measuring time, bandwidth, antenna height, antenna polarization, turntable angle, correction factor, margin to the limit and limit are recorded. A plot with the graph of the premeasurement with marked maximum final results and the limit is stored.

8.3 Sequence of testing radiated spurious 1 GHz to 18 GHz

Setup

- The equipment is set up to simulate normal operation mode as described in the user manual or defined by the manufacturer.
- If the EUT is a tabletop system, a 2-axis positioner with 1.5 m height is used.
- If the EUT is a floor standing device, it is placed directly on the turn table.
- Auxiliary equipment and cables are positioned to simulate normal operation conditions as described in ANSI C 63.4.
- The AC power port of the EUT (if available) is connected to a power outlet below the turntable.
- Measurement distance is 3 m (see ANSI C 63.4) – see test details.
- EUT is set into operation.

Premeasurement

- The turntable rotates from 0° to 315° using 45° steps.
- The antenna is polarized vertical and horizontal.
- The antenna height is 1.5 m.
- At each turntable position and antenna polarization the analyzer sweeps with positive peak detector to find the maximum of all emissions.

Final measurement

- The final measurement is performed for at least six highest peaks according to the requirements of the ANSI C63.4.
- Based on antenna and turntable positions at which the peak values are measured the software maximizes the peaks by rotating the turntable from 0° to 360°. This measurement is repeated for different EUT-table positions (0° to 150° in 30°-steps) and for both antenna polarizations.
- The final measurement is done in the position (turntable, EUT-table and antenna polarization) causing the highest emissions with Peak and RMS detector (as described in ANSI C 63.4).
- Final levels, frequency, measuring time, bandwidth, turntable position, EUT-table position, antenna polarization, correction factor, margin to the limit and limit are recorded. A plot with the graph of the premeasurement with marked maximum final results and the limit is stored.

8.4 Sequence of testing radiated spurious above 18 GHz

Setup

- The equipment is set up to simulate normal operation mode as described in the user manual or defined by the manufacturer.
- Auxiliary equipment and cables are positioned to simulate normal operation conditions as described in ANSI C 63.4.
- The AC power port of the EUT (if available) is connected to a power outlet.
- The measurement distance is as appropriate (e.g. 0.5 m).
- The EUT is set into operation.

Premeasurement

- The test antenna is handheld and moved carefully over the EUT to cover the EUT's whole sphere and different polarizations of the antenna.

Final measurement

- The final measurement is performed at the position and antenna orientation causing the highest emissions with Peak and RMS detector (as described in ANSI C 63.4).
- Final levels, frequency, measuring time, bandwidth, correction factor, margin to the limit and limit are recorded. A plot with the graph of the premeasurement and the limit is stored.

9 Measurement uncertainty

Measurement uncertainty	
Test case	Uncertainty
RF output power conducted	± 1 dB
RF output power radiated	± 3 dB
Frequency stability	± 20 Hz
Spurious emissions radiated below 30 MHz	± 3 dB
Spurious emissions radiated 30 MHz to 1 GHz	± 3 dB
Spurious emissions radiated 1 GHz to 12.75 GHz	± 3.7 dB
Spurious emissions radiated above 12.75 GHz	± 4.5 dB
Spurious emissions conducted	± 3 dB
Block edge compliance	± 3 dB
Occupied bandwidth	± RBW

10 Summary of measurement results GSM / WCDMA

<input type="checkbox"/>	No deviations from the technical specifications were ascertained
<input type="checkbox"/>	There were deviations from the technical specifications ascertained
<input checked="" type="checkbox"/>	This test report is only a partial test report. The content and verdict of the performed test cases are listed below.

TC identifier	Description	verdict	date	Remark
RF-Testing	CFR Part 22, 24, 27 RSS 132, 133, 139	See table!	2021-06-08	Output power + radiated spurious only

10.1 GSM 850

Test Case	temperature conditions	power source voltages	C	NC	NA	NP	Remark
RF Output Power	Nominal	Nominal	<input checked="" type="checkbox"/>	<input type="checkbox"/>	<input type="checkbox"/>	<input type="checkbox"/>	-/-
Frequency Stability	Nominal	Nominal	<input type="checkbox"/>	<input type="checkbox"/>	<input type="checkbox"/>	<input checked="" type="checkbox"/>	-/-
Spurious Emissions Radiated	Nominal	Nominal	<input checked="" type="checkbox"/>	<input type="checkbox"/>	<input type="checkbox"/>	<input type="checkbox"/>	-/-
Spurious Emissions Conducted	Nominal	Nominal	<input type="checkbox"/>	<input type="checkbox"/>	<input type="checkbox"/>	<input checked="" type="checkbox"/>	-/-
Block Edge Compliance	Nominal	Nominal	<input type="checkbox"/>	<input type="checkbox"/>	<input type="checkbox"/>	<input checked="" type="checkbox"/>	-/-
Occupied Bandwidth	Nominal	Nominal	<input type="checkbox"/>	<input type="checkbox"/>	<input type="checkbox"/>	<input checked="" type="checkbox"/>	-/-

Note: C = Compliant; NC = Not compliant; NA = Not applicable; NP = Not performed

10.2 PCS 1900

Test Case	temperature conditions	power source voltages	C	NC	NA	NP	Remark
RF Output Power	Nominal	Nominal	<input checked="" type="checkbox"/>	<input type="checkbox"/>	<input type="checkbox"/>	<input type="checkbox"/>	-/-
Frequency Stability	Nominal	Nominal	<input type="checkbox"/>	<input type="checkbox"/>	<input type="checkbox"/>	<input checked="" type="checkbox"/>	-/-
Spurious Emissions Radiated	Nominal	Nominal	<input checked="" type="checkbox"/>	<input type="checkbox"/>	<input type="checkbox"/>	<input type="checkbox"/>	-/-
Spurious Emissions Conducted	Nominal	Nominal	<input type="checkbox"/>	<input type="checkbox"/>	<input type="checkbox"/>	<input checked="" type="checkbox"/>	-/-
Block Edge Compliance	Nominal	Nominal	<input type="checkbox"/>	<input type="checkbox"/>	<input type="checkbox"/>	<input checked="" type="checkbox"/>	-/-
Occupied Bandwidth	Nominal	Nominal	<input type="checkbox"/>	<input type="checkbox"/>	<input type="checkbox"/>	<input checked="" type="checkbox"/>	-/-

Note: C = Compliant; NC = Not compliant; NA = Not applicable; NP = Not performed

10.3 UMTS band II

Test Case	temperature conditions	power source voltages	C	NC	NA	NP	Remark
RF Output Power	Nominal	Nominal	<input checked="" type="checkbox"/>	<input type="checkbox"/>	<input type="checkbox"/>	<input type="checkbox"/>	-/-
Frequency Stability	Nominal	Nominal	<input type="checkbox"/>	<input type="checkbox"/>	<input type="checkbox"/>	<input checked="" type="checkbox"/>	-/-
Spurious Emissions Radiated	Nominal	Nominal	<input checked="" type="checkbox"/>	<input type="checkbox"/>	<input type="checkbox"/>	<input type="checkbox"/>	-/-
Spurious Emissions Conducted	Nominal	Nominal	<input type="checkbox"/>	<input type="checkbox"/>	<input type="checkbox"/>	<input checked="" type="checkbox"/>	-/-
Block Edge Compliance	Nominal	Nominal	<input type="checkbox"/>	<input type="checkbox"/>	<input type="checkbox"/>	<input checked="" type="checkbox"/>	-/-
Occupied Bandwidth	Nominal	Nominal	<input type="checkbox"/>	<input type="checkbox"/>	<input type="checkbox"/>	<input checked="" type="checkbox"/>	-/-

Note: C = Compliant; NC = Not compliant; NA = Not applicable; NP = Not performed

10.4 UMTS band IV

Test Case	temperature conditions	power source voltages	C	NC	NA	NP	Remark
RF Output Power	Nominal	Nominal	<input checked="" type="checkbox"/>	<input type="checkbox"/>	<input type="checkbox"/>	<input type="checkbox"/>	-/-
Frequency Stability	Nominal	Nominal	<input type="checkbox"/>	<input type="checkbox"/>	<input type="checkbox"/>	<input checked="" type="checkbox"/>	-/-
Spurious Emissions Radiated	Nominal	Nominal	<input checked="" type="checkbox"/>	<input type="checkbox"/>	<input type="checkbox"/>	<input type="checkbox"/>	-/-
Spurious Emissions Conducted	Nominal	Nominal	<input type="checkbox"/>	<input type="checkbox"/>	<input type="checkbox"/>	<input checked="" type="checkbox"/>	-/-
Block Edge Compliance	Nominal	Nominal	<input type="checkbox"/>	<input type="checkbox"/>	<input type="checkbox"/>	<input checked="" type="checkbox"/>	-/-
Occupied Bandwidth	Nominal	Nominal	<input type="checkbox"/>	<input type="checkbox"/>	<input type="checkbox"/>	<input checked="" type="checkbox"/>	-/-

Note: C = Compliant; NC = Not compliant; NA = Not applicable; NP = Not performed

10.5 UMTS band V

Test Case	temperature conditions	power source voltages	C	NC	NA	NP	Remark
RF Output Power	Nominal	Nominal	<input checked="" type="checkbox"/>	<input type="checkbox"/>	<input type="checkbox"/>	<input type="checkbox"/>	-/-
Frequency Stability	Nominal	Nominal	<input type="checkbox"/>	<input type="checkbox"/>	<input type="checkbox"/>	<input checked="" type="checkbox"/>	-/-
Spurious Emissions Radiated	Nominal	Nominal	<input checked="" type="checkbox"/>	<input type="checkbox"/>	<input type="checkbox"/>	<input type="checkbox"/>	-/-
Spurious Emissions Conducted	Nominal	Nominal	<input type="checkbox"/>	<input type="checkbox"/>	<input type="checkbox"/>	<input checked="" type="checkbox"/>	-/-
Block Edge Compliance	Nominal	Nominal	<input type="checkbox"/>	<input type="checkbox"/>	<input type="checkbox"/>	<input checked="" type="checkbox"/>	-/-
Occupied Bandwidth	Nominal	Nominal	<input type="checkbox"/>	<input type="checkbox"/>	<input type="checkbox"/>	<input checked="" type="checkbox"/>	-/-

Note: C = Compliant; NC = Not compliant; NA = Not applicable; NP = Not performed

11 Results GSM 850

11.1 RF output power

Description:

This paragraph contains average power, peak output power, PAPR and ERP measurements for the mobile station.

The plots in this test report represents only an example of the measurements. All plots of this chapter are available on request.

The red line in the measurements indicates the ideal Gaussian distribution for the measured amplitude range.

Measurement:

The mobile was set up for the maximum output power with pseudo random data modulation.

To determine the Peak-To-Average Power Ratio (PAPR) the measurement was performed with the Power Complementary Cumulative Distribution Function (CCDF).

Measurement parameters	
Detector:	Sample
AQT:	See plot
Resolution bandwidth:	1 MHz
Used equipment:	See chapter 7.1 – setup A (radiated) See chapter 7.4 – setup A (conducted)
Measurement uncertainty:	see chapter 9

Limits:

FCC	IC
+38.45 dBm In measuring transmissions in this band using an average power technique, the peak-to-average ratio (PAR) of the transmission may not exceed 13 dB.	

Results:

Output Power (conducted) GMSK mode			
Frequency (MHz)	Peak Output Power (dBm)	Average Output Power (dBm)	Peak to Average Ratio (dB) CCDF
824.2	28.5	28.3	0.1
836.4	28.5	28.4	0.2
848.8	28.4	28.3	0.1

Output Power (conducted) 8-PSK mode			
Frequency (MHz)	Peak Output Power (dBm)	Average Output Power (dBm)	Peak to Average Ratio (dB) CCDF
824.2	26.1	22.8	3.1
836.4	26.3	22.3	3.9
848.8	26.2	22.1	3.9

Output Power (radiated) GMSK mode	
Frequency (MHz)	Average Output Power (dBm) - ERP
824.2	25.7
836.4	26.1
848.8	25.8

Output Power (radiated) 8-PSK mode	
Frequency (MHz)	Average Output Power (dBm) - ERP
824.2	20.2
836.4	20.0
848.8	19.6

Plots: GMSK

Plot 1: CCDF, channel 128

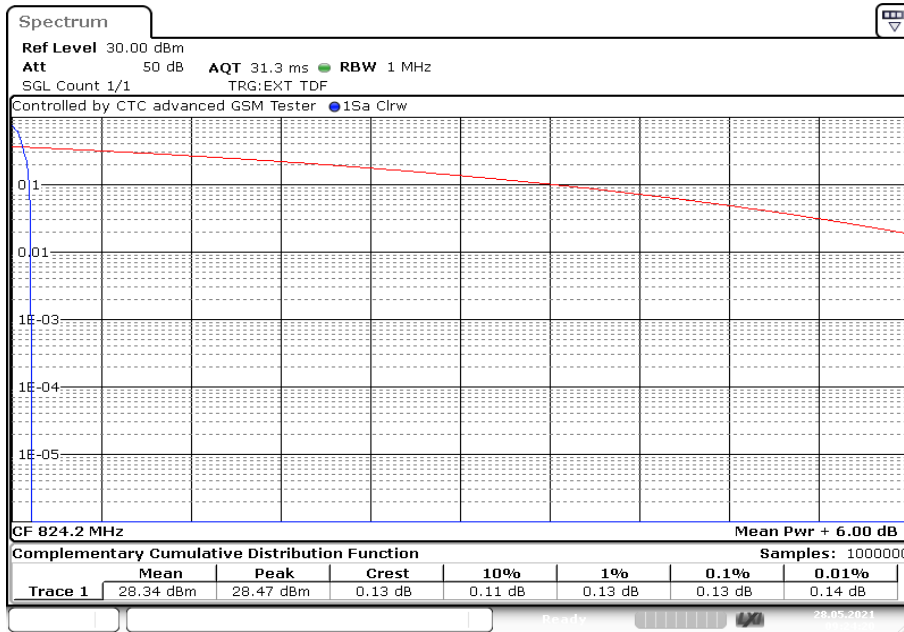

Plot 2: CCDF, channel 189

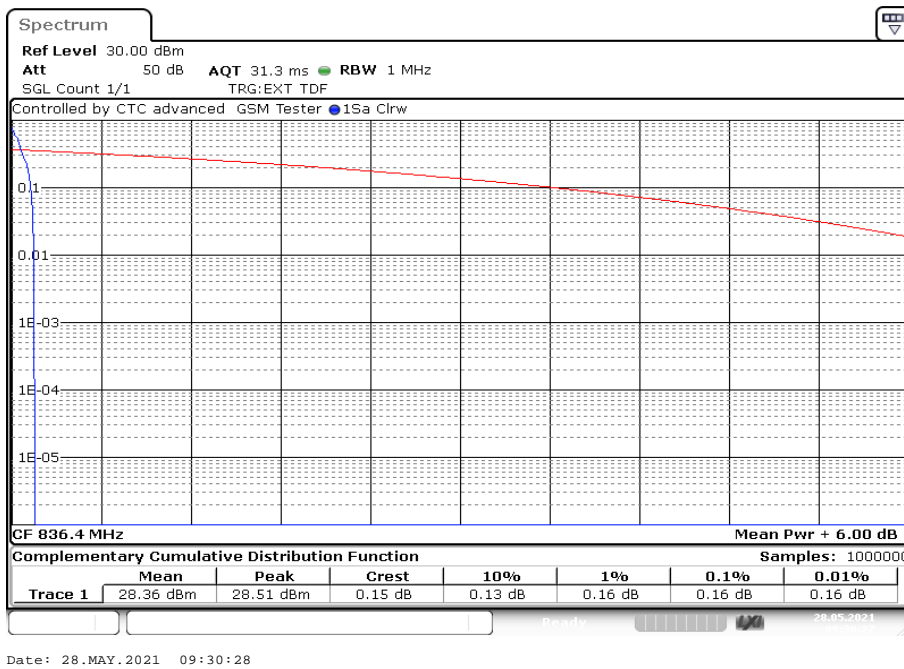

Plot 3: CCDF, channel 251

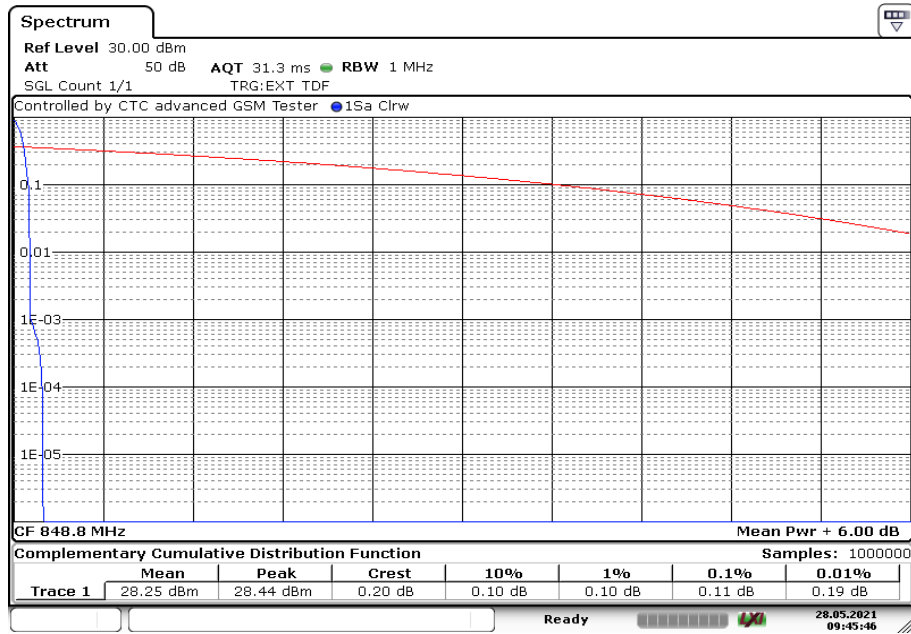

Date: 28.MAY.2021 09:45:46

Plots: 8 PSK

Plot 1: CCDF, channel 128

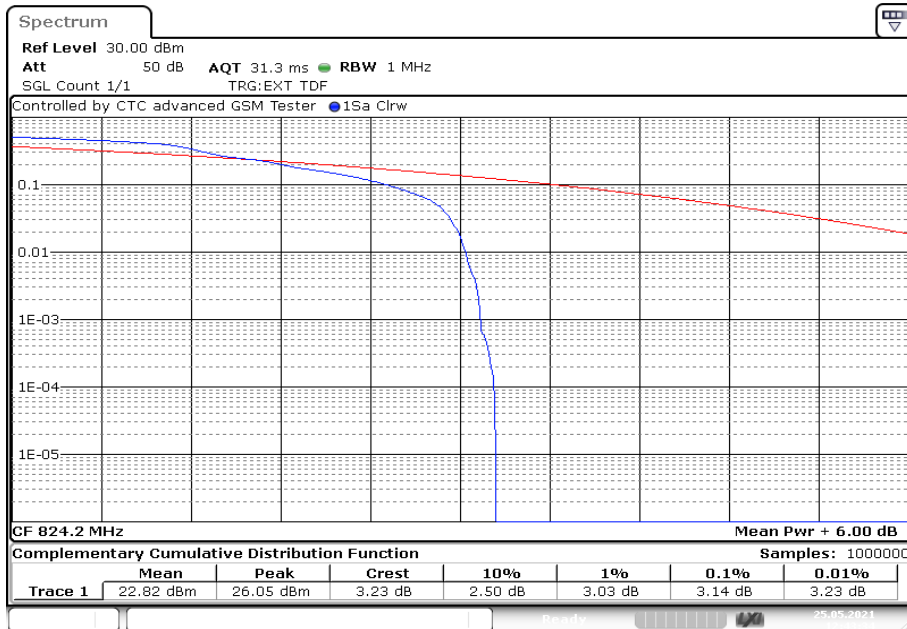

Date: 25.MAY.2021 12:43:34

Plot 2: CCDF, channel 189

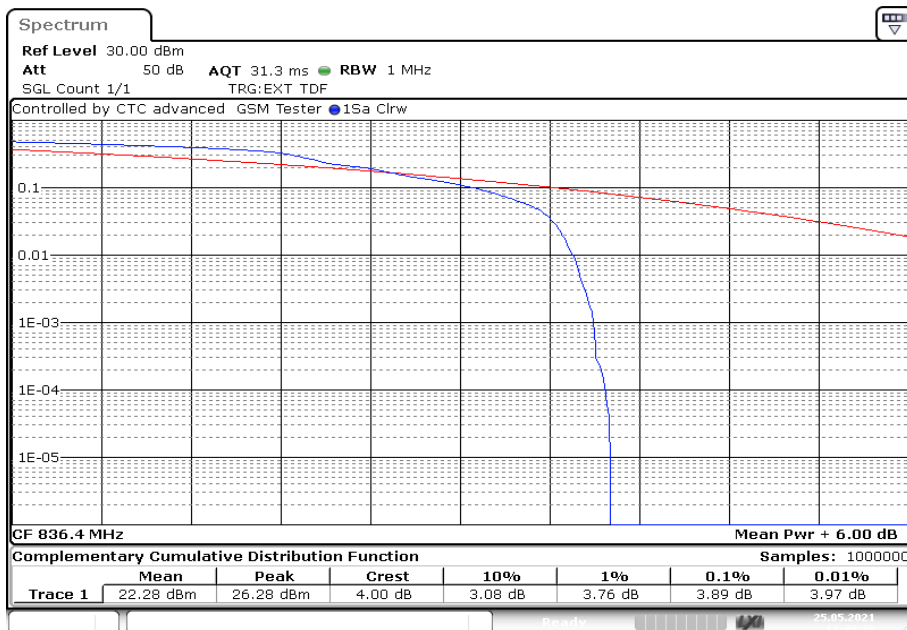

Date: 25.MAY.2021 12:49:29

Plot 3: CCDF, channel 251

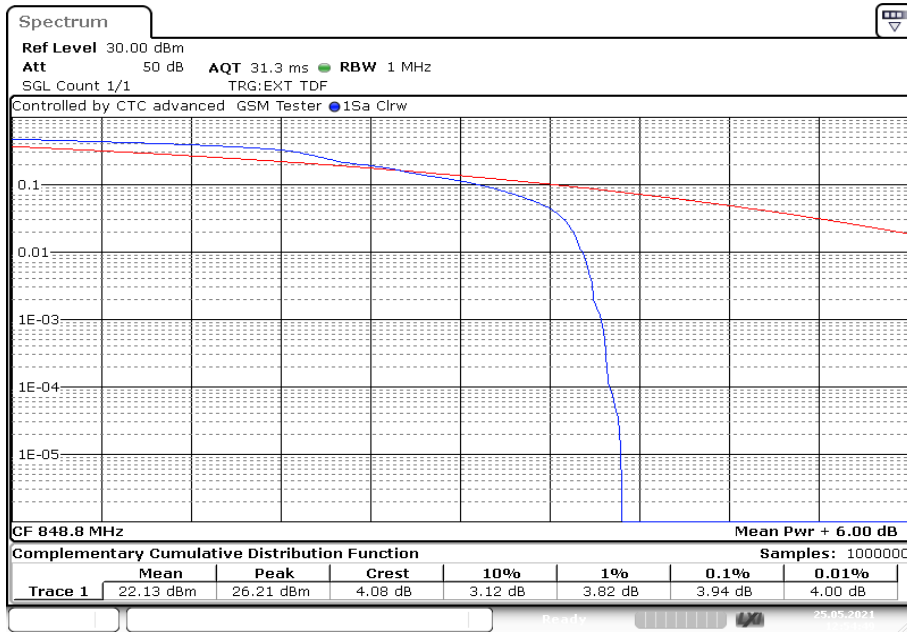

Date: 25.MAY.2021 12:54:50

11.2 Spurious emissions radiated

Description:

The following steps outline the procedure used to measure the radiated emissions from the mobile station. The site is constructed in accordance with ANSI C63.4:2014 requirements and is recognized by the FCC to be in compliance for a 3 and a 10 meter site. The spectrum was scanned from 30 MHz to the 10th harmonic of the highest frequency generated within the equipment, which is the transmitted carrier that can be as high as 848.8 MHz. Measurements made up to 9 GHz. The resolution bandwidth is set as outlined in Part 22.917. The spectrum was scanned with the mobile station transmitting at carrier frequencies that pertain to low, mid and high channels of the GSM-850 band.

Measurement:

Measurement parameters	
Detector:	Peak
Sweep time:	2 s
Resolution bandwidth:	100 kHz
Video bandwidth:	300 kHz
Span:	100 MHz Steps
Trace mode:	Max Hold
Used equipment:	See chapter 7.1 – setup A, 7.2 – setup A, 7.2 – setup B
Measurement uncertainty:	See chapter 9

Limits:

FCC	IC
$\text{Attenuation} \geq 43 + 10\log(P)$ (P, Power in Watts)	
-13 dBm	

Results GPRS & EGPRS:

Radiated emissions measurements were made only at the center carrier frequency of the GSM-850 band (836.4 MHz). The measurements shows the cabinet radiation in transmit mode. The antenna port can be terminated with 50 Ω .

Results:

Spurious emission level (dBm)								
Harmonic	Ch. 128 Freq. (MHz)	Level [dBm]	Harmonic	Ch. 189 Freq. (MHz)	Level [dBm]	Harmonic	Ch. 251 Freq. (MHz)	Level [dBm]
2	1648.4	-/-	2	1672.8	-/-	2	1697.6	-/-
3	2472.6	-/-	3	2509.2	-/-	3	2546.4	-/-
4	3296.8	-/-	4	3345.6	-/-	4	3395.2	-/-
5	4121.0	-/-	5	4182.0	-/-	5	4244.0	-/-
6	4945.2	-/-	6	5018.4	-/-	6	5092.8	-/-
7	5769.4	-/-	7	5854.8	-/-	7	5941.6	-/-
8	6593.6	-/-	8	6691.2	-/-	8	6790.4	-/-
9	7417.8	-/-	9	7527.6	-/-	9	7639.2	-/-
10	8242.0	-/-	10	8364.0	-/-	10	8488.0	-/-

Plots: GMSK

Plot 1: Channel 189 (Traffic mode up to 30 MHz)

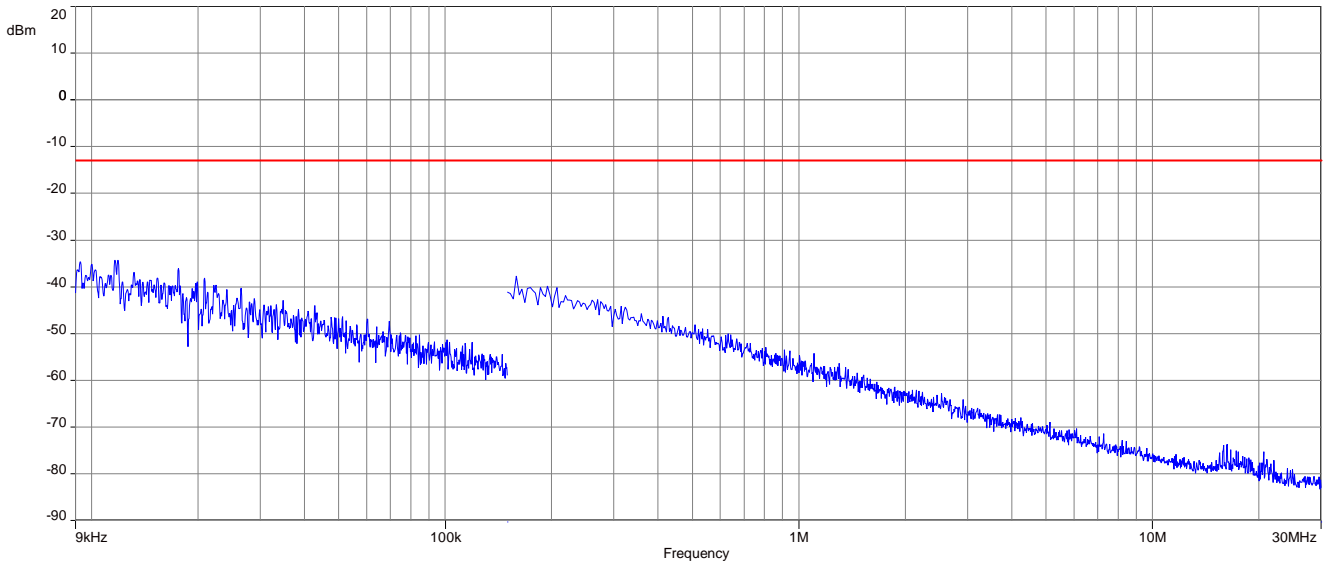

Plot 2: Channel 189 (30 MHz – 1 GHz)

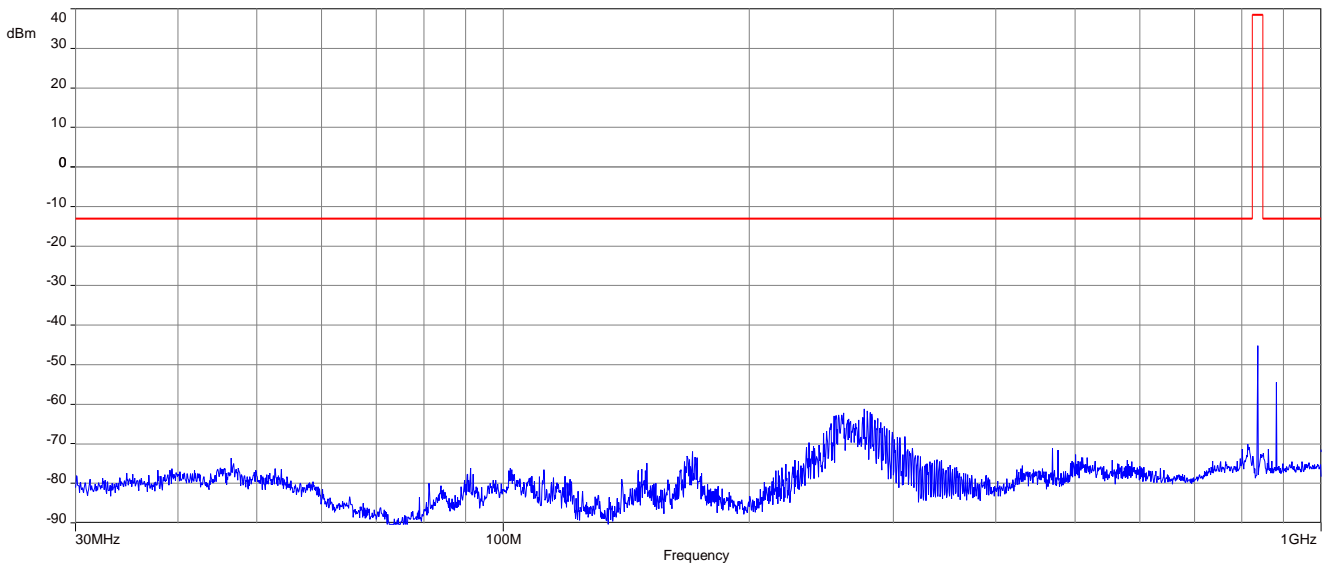

Carrier notched with 835 MHz rejection filter.

Plot 3: Channel 189 (1 GHz – 9 GHz)

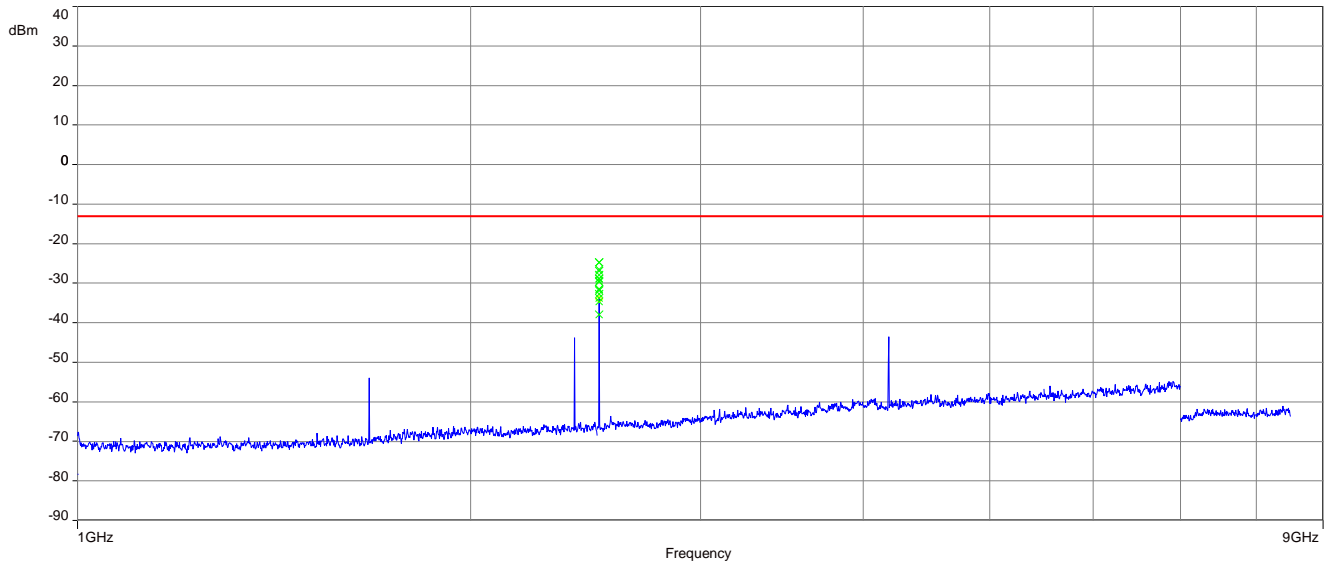

Plots: 8 PSK

Plot 1: Channel 189 (Traffic mode up to 30 MHz)

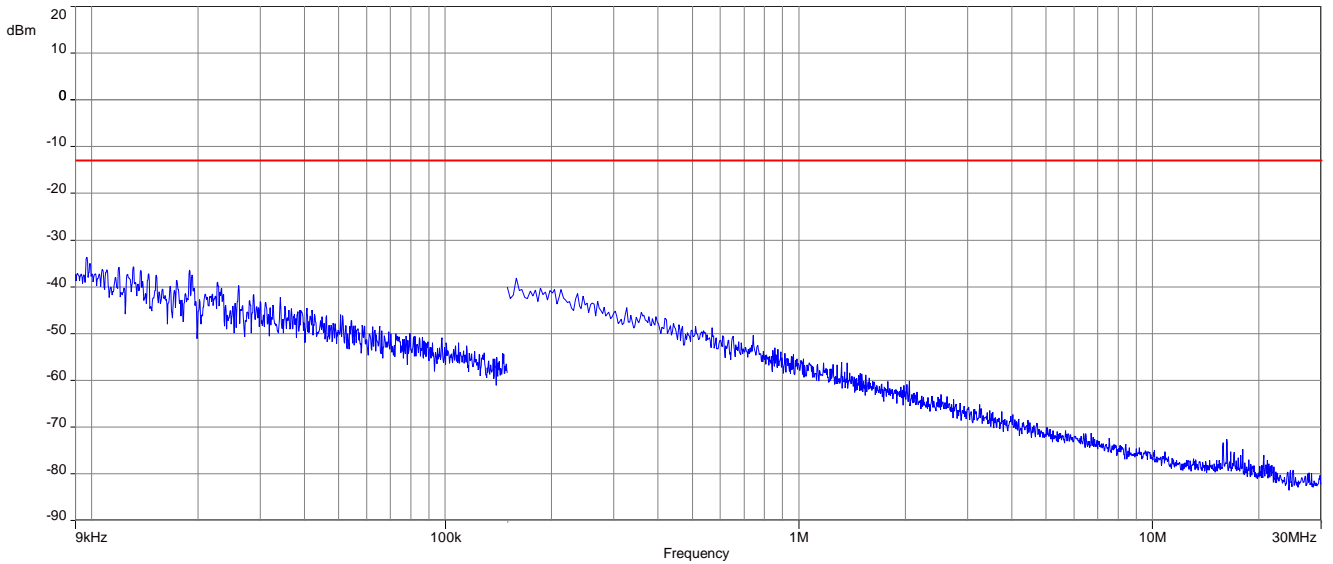

Plot 2: Channel 189 (30 MHz – 1 GHz)

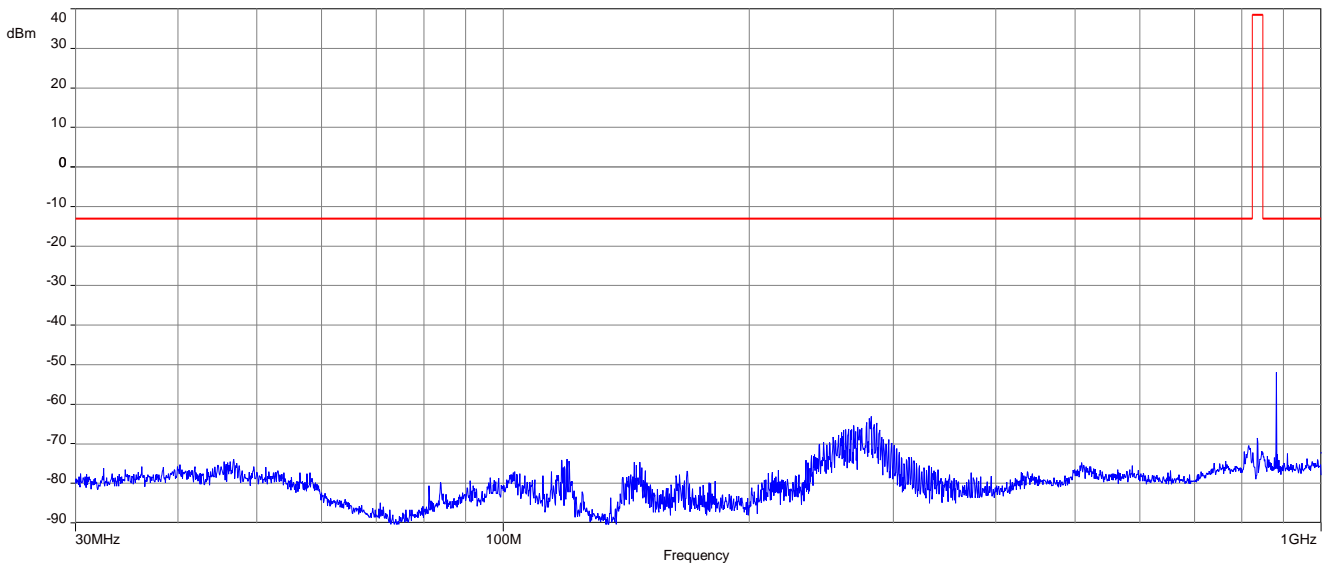

Carrier notched with 835 MHz rejection filter.

Plot 3: Channel 189 (1 GHz – 8.5 GHz)

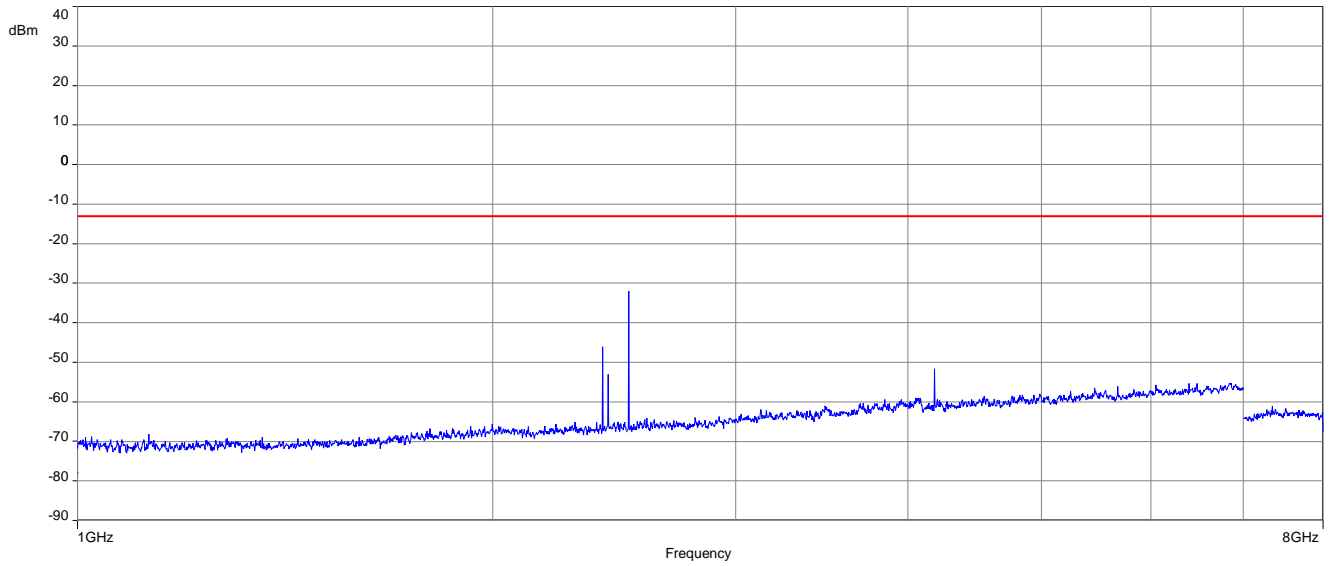

12 Results PCS 1900

12.1 RF output power

Description:

This paragraph contains average power, peak output power, PAPR and ERP measurements for the mobile station.

The plots in this test report represents only an example of the measurements. All plots of this chapter are available on request.

The red line in the measurements indicates the ideal Gaussian distribution for the measured amplitude range.

Measurement:

The mobile was set up for the maximum output power with pseudo random data modulation.

To determine the Peak-To-Average Power Ratio (PAPR) the measurement was performed with the Power Complementary Cumulative Distribution Function (CCDF).

Measurement parameters	
Detector:	Sample
AQT:	See plot
Resolution bandwidth:	1 MHz
Used equipment:	See chapter 7.2 – setup B (radiated) See chapter 7.4 – setup A (conducted)
Measurement uncertainty:	See chapter 9

Limits:

FCC	IC
+33.00 dBm In measuring transmissions in this band using an average power technique, the peak-to-average ratio (PAR) of the transmission may not exceed 13 dB.	

Results:

Output Power (conducted) GMSK mode			
Frequency (MHz)	Peak Output Power (dBm)	Average Output Power (dBm)	Peak to Average Ratio (dB) CCDF
1850.2	24.6	23.9	0.68
1880.0	24.9	24.6	0.17
1909.8	25.0	24.8	0.19

Output Power (conducted) 8-PSK mode			
Frequency (MHz)	Peak Output Power (dBm)	Average Output Power (dBm)	Peak to Average Ratio (dB) CCDF
1850.2	24.6	21.1	3.5
1880.0	24.4	20.4	3.9
1909.8	24.7	21.3	3.2

Output Power (radiated) GMSK mode	
Frequency (MHz)	Average Output Power (dBm) - EIRP
1850.2	23.5
1880.0	23.6
1909.8	23.0

Output Power (radiated) 8-PSK mode	
Frequency (MHz)	Average Output Power (dBm) - EIRP
1850.2	20.7
1880.0	19.4
1909.8	19.5

Plots: GMSK

Plot 1: CCDF, channel 512

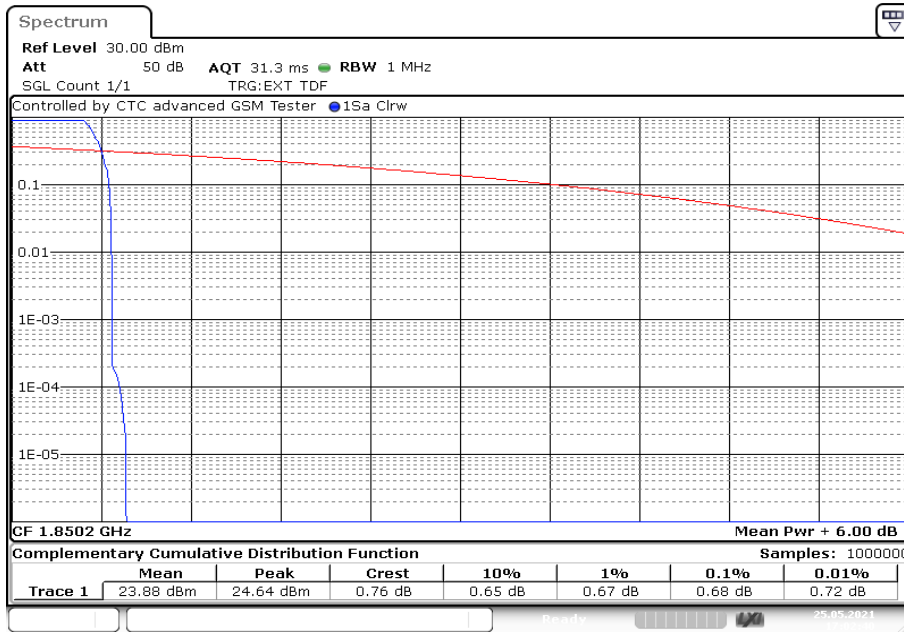

Date: 25.MAY.2021 17:02:41

Plot 2: CCDF, channel 661

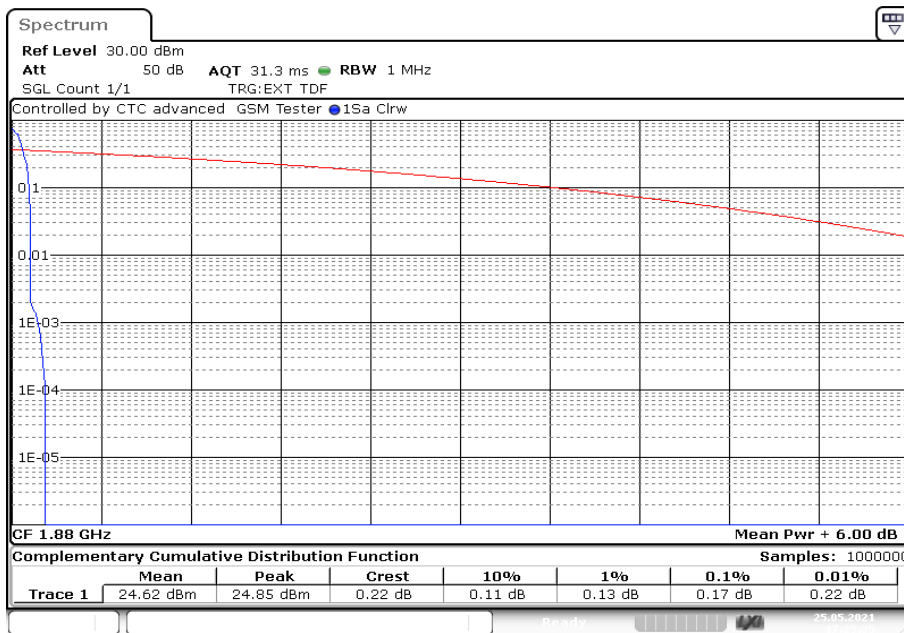

Date: 25.MAY.2021 17:25:35

Plot 3: CCDF, channel 810

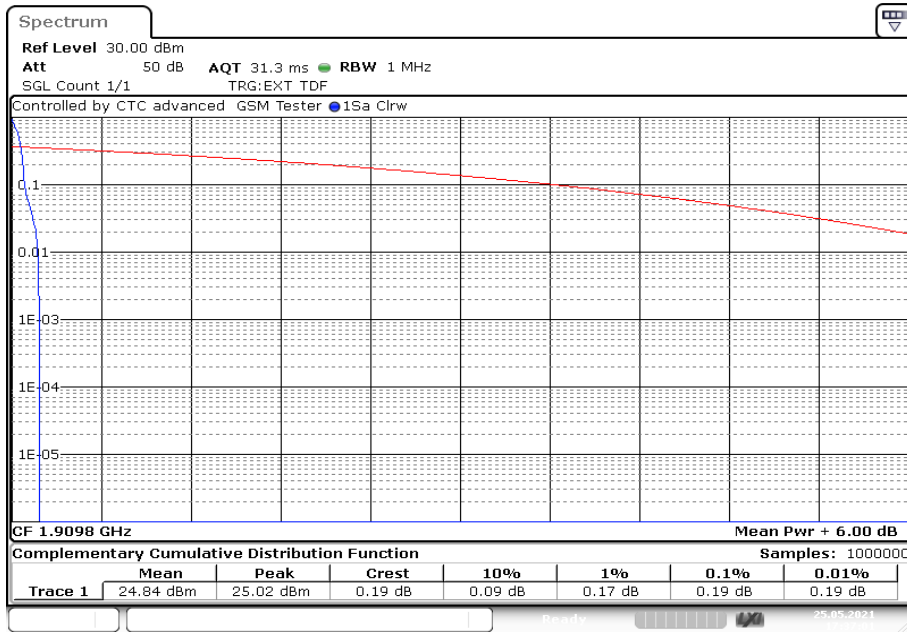

Date: 25.MAY.2021 17:37:02

Plots: 8 PSK

Plot 1: CCDF, channel 512

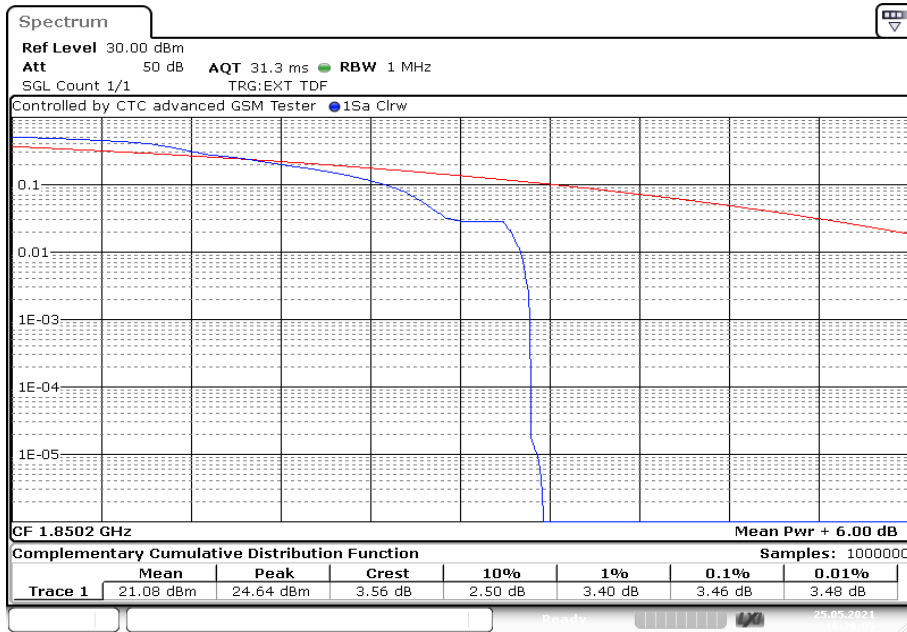

Date: 25.MAY.2021 16:26:06

Plot 2: CCDF, channel 661

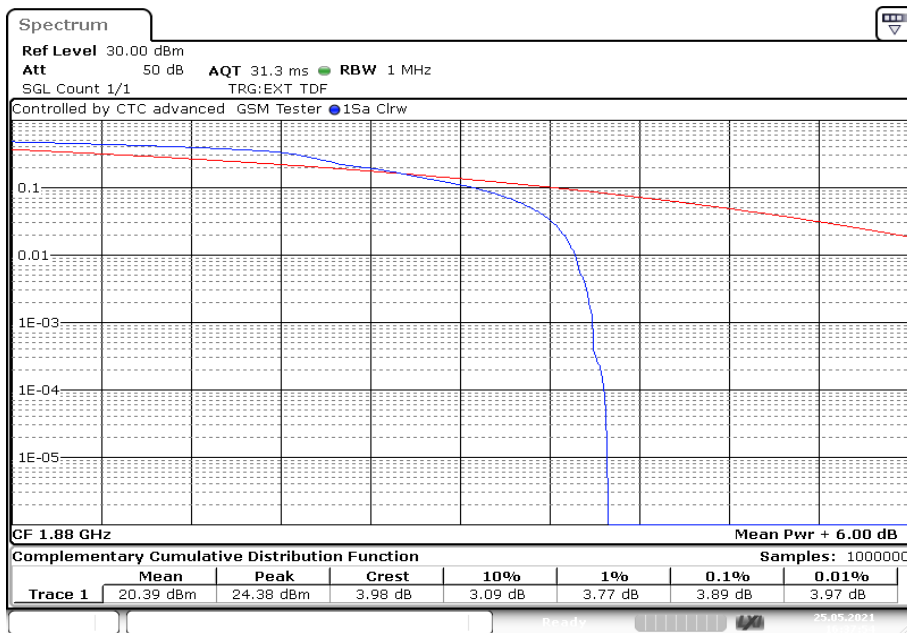

Date: 25.MAY.2021 16:37:55

Plot 3: CCDF, channel 810

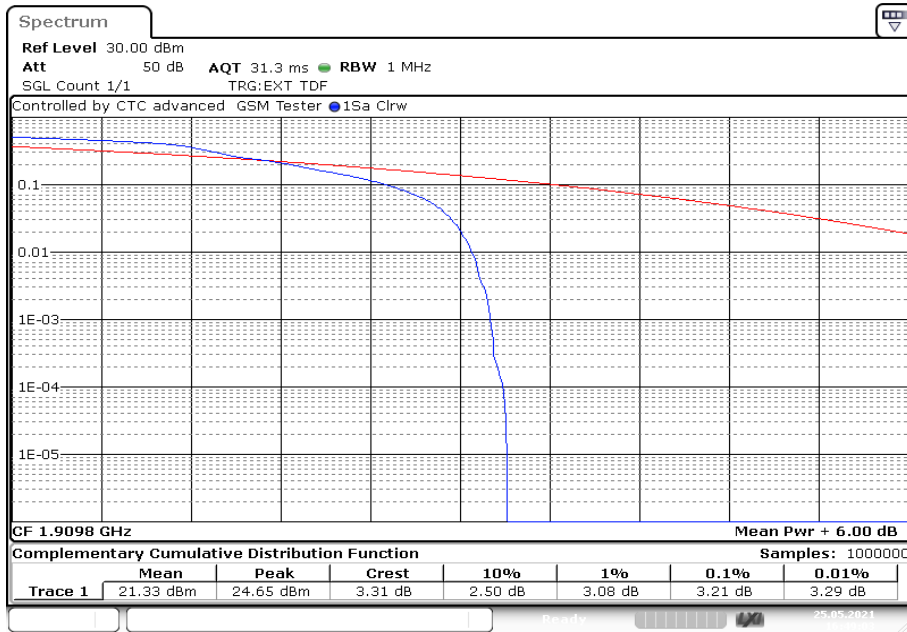

Date: 25.MAY.2021 16:49:04

12.2 Spurious emissions radiated

Description:

The following steps outline the procedure used to measure the radiated emissions from the mobile station. The site is constructed in accordance with ANSI C63.4:2014 requirements and is recognized by the FCC to be in compliance for a 3 and a 10 meter site. The spectrum was scanned from 30 MHz to the 10th harmonic of the highest frequency generated within the equipment, which is the transmitted carrier that can be as high as 1910 MHz. Measurement made up to 26 GHz. The resolution bandwidth is set as outlined in Part 24.238. The spectrum was scanned with the mobile station transmitting at carrier frequencies that pertain to low, mid and high channels of the PCS1900 band.

Measurement:

Measurement parameters	
Detector:	Peak
Sweep time:	2 sec.
Resolution bandwidth:	1 MHz
Video bandwidth:	3 MHz
Span:	100 MHz Steps
Trace mode:	Max Hold
Used equipment:	See chapter 7.1 - setup A & 7.2 – setup A/B & 7.3 – setup B
Measurement uncertainty:	See chapter 9

Limits:

FCC	IC
Attenuation $\geq 43 + 10\log(P)$ (P, Power in Watts)	
-13 dBm	

Results GPRS & EGPRS:

Radiated emissions measurements were made only at the center carrier frequencies of the PCS1900 band (1880.0 MHz) to show the compliance with cabinet radiation limits.

Results:

Spurious emission level (dBm)								
Harmonic	Ch. 512 Freq. (MHz)	Level [dBm]	Harmonic	Ch. 661 Freq. (MHz)	Level [dBm]	Harmonic	Ch. 810 Freq. (MHz)	Level [dBm]
2	3700.4	-/-	2	3760.0	-/-	2	3819.6	-/-
3	5550.6	-/-	3	5640.0	-/-	3	5729.4	-/-
4	7400.8	-/-	4	7520.0	-/-	4	7639.2	-/-
5	9251.0	-/-	5	9400.0	-/-	5	9549.0	-/-
6	11101.2	-/-	6	11280.0	-/-	6	11458.8	-/-
7	12951.4	-/-	7	13160.0	-/-	7	13368.6	-/-
8	14801.6	-/-	8	15040.0	-/-	8	15278.4	-/-
9	16651.8	-/-	9	16920.0	-/-	9	17188.2	-/-
10	18502.0	-/-	10	18800.0	-/-	10	19098.0	-/-

Plots: GMSK

Plot 1: Channel 661 (Traffic mode up to 30 MHz)

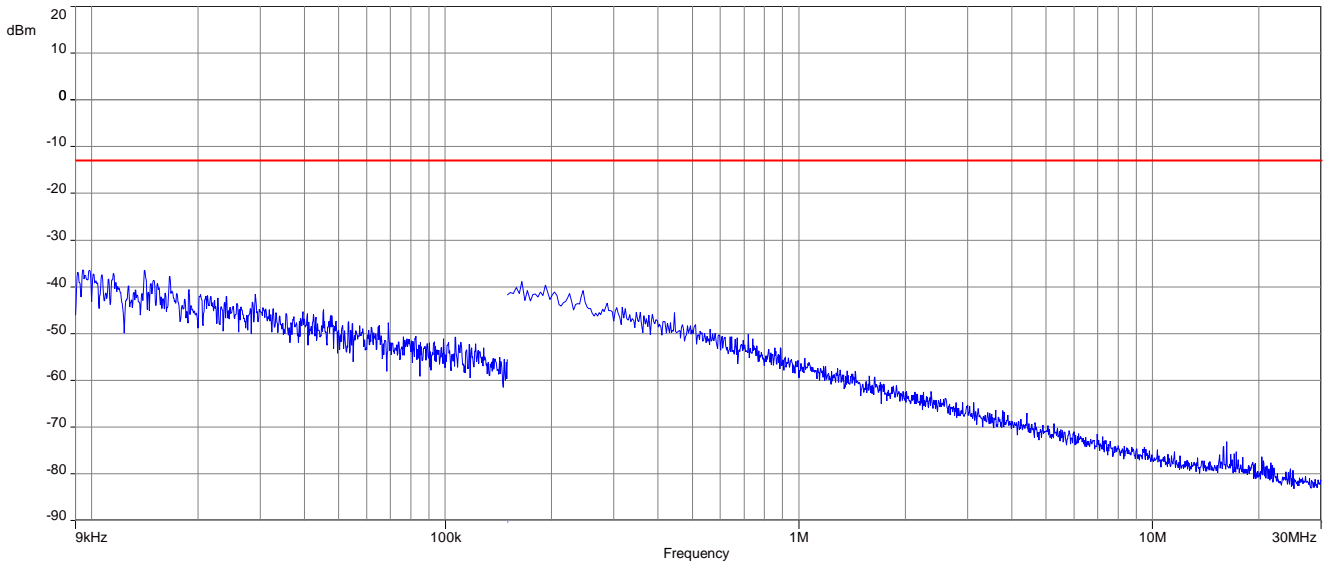

Plot 2: Channel 661 (30 MHz – 1 GHz)

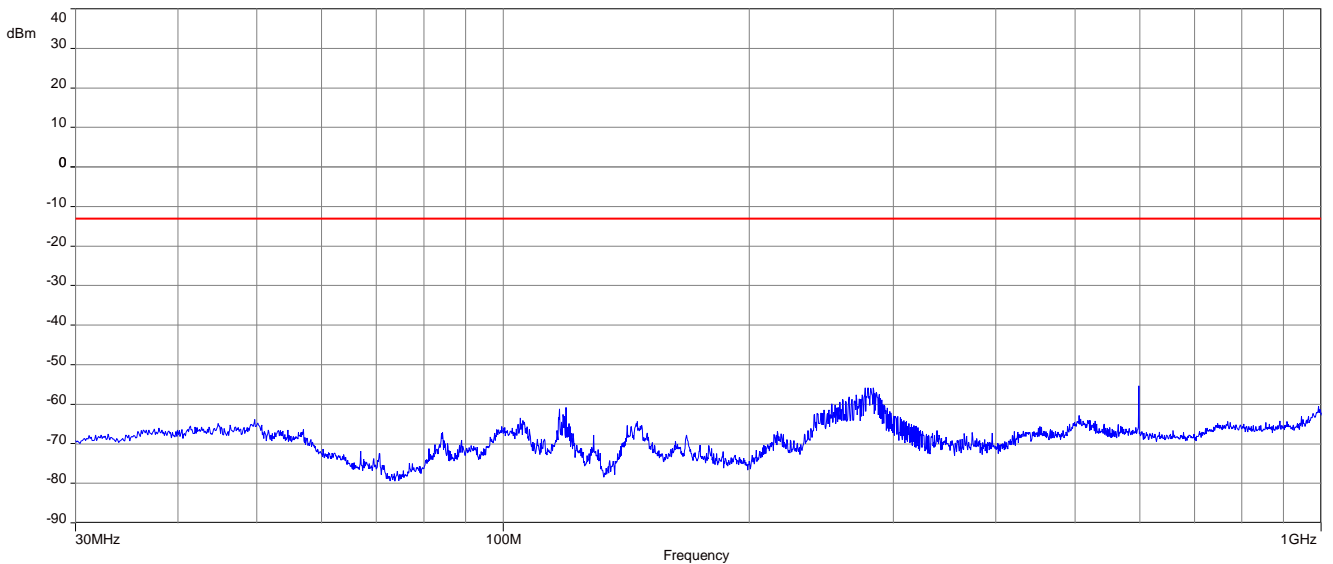

Plot 3: Channel 661 (1 GHz - 18 GHz)

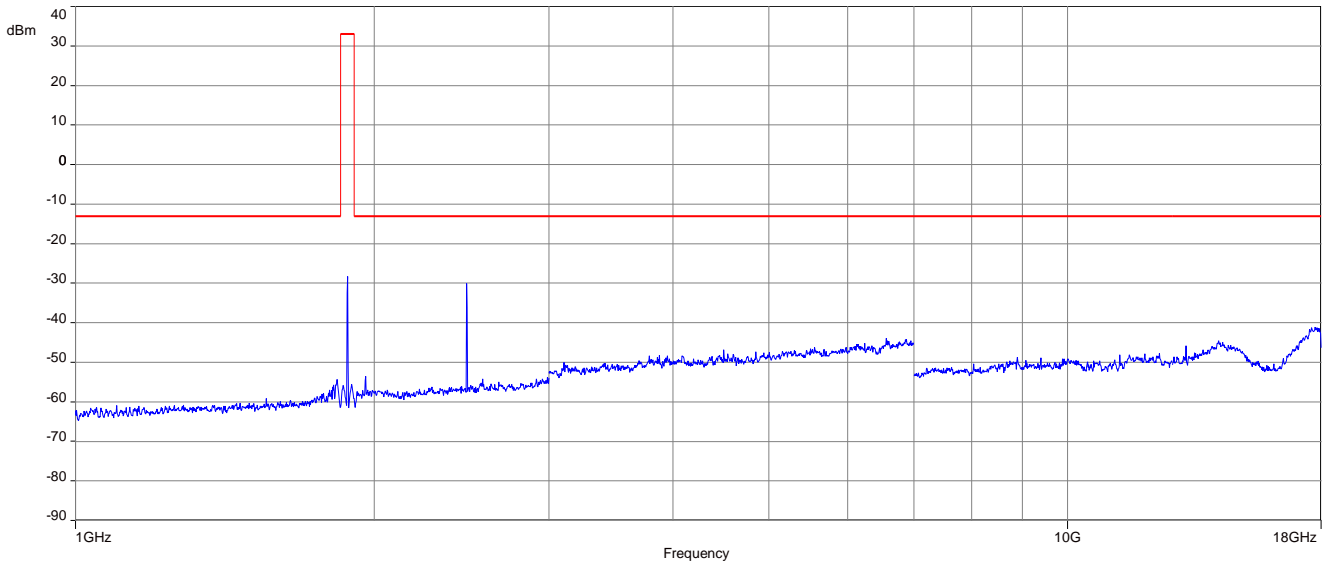

Carrier notched with 1.9 GHz rejection filter. The detected emissions @ 2.4 GHz are the advertiser channels from the BT LE radio part of the device.

Plot 4: Channel 661 (18 GHz - 26 GHz)

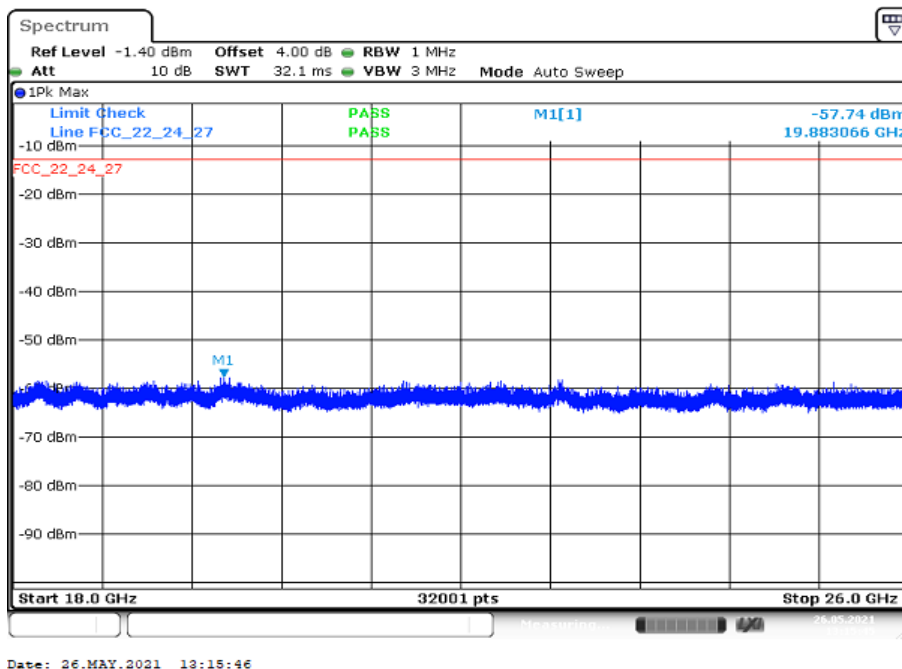

Plots: 8 PSK

Plot 1: Channel 661 (Traffic mode up to 30 MHz)

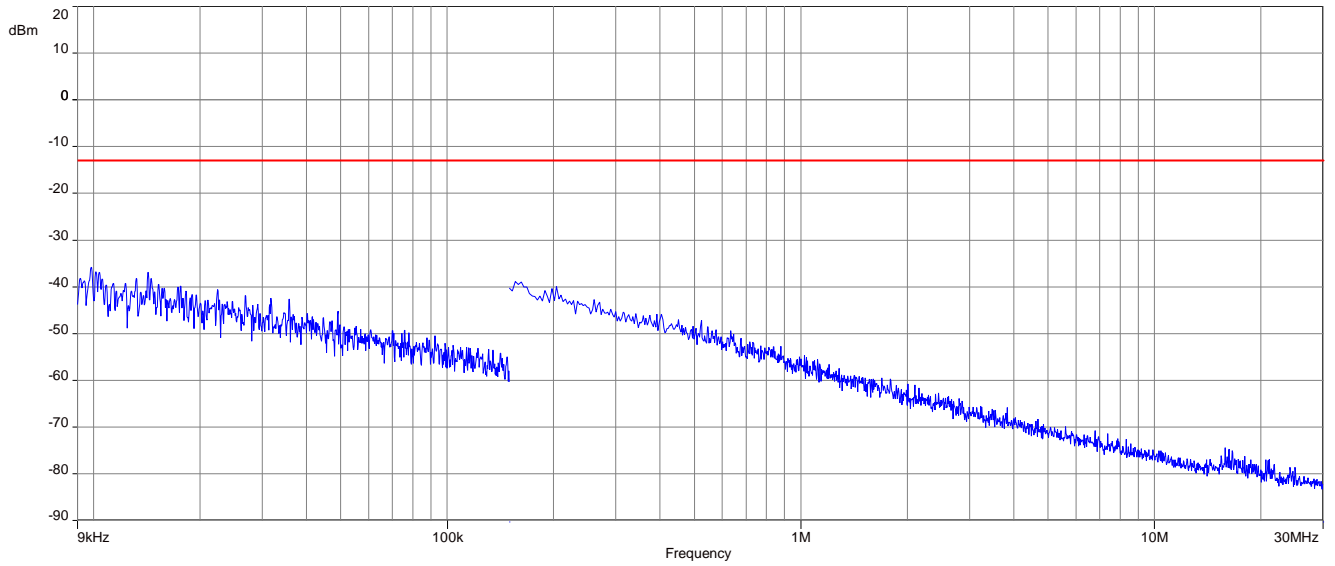

Plot 2: Channel 661 (30 MHz – 1 GHz)

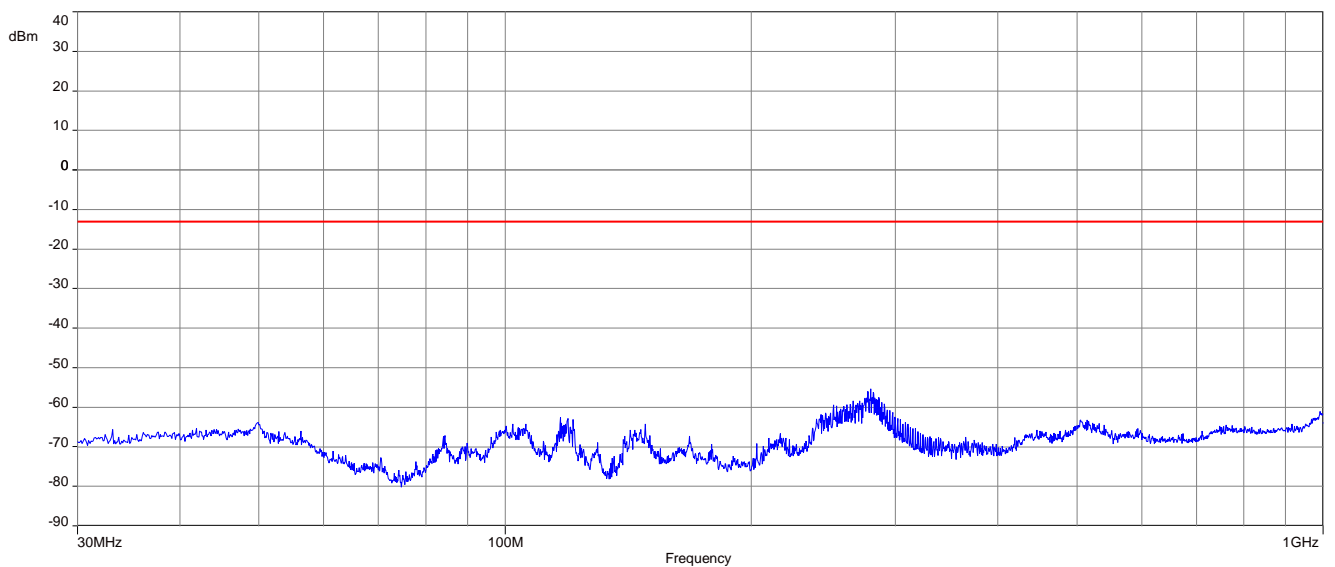

Plot 3: Channel 661 (1 GHz - 18 GHz)

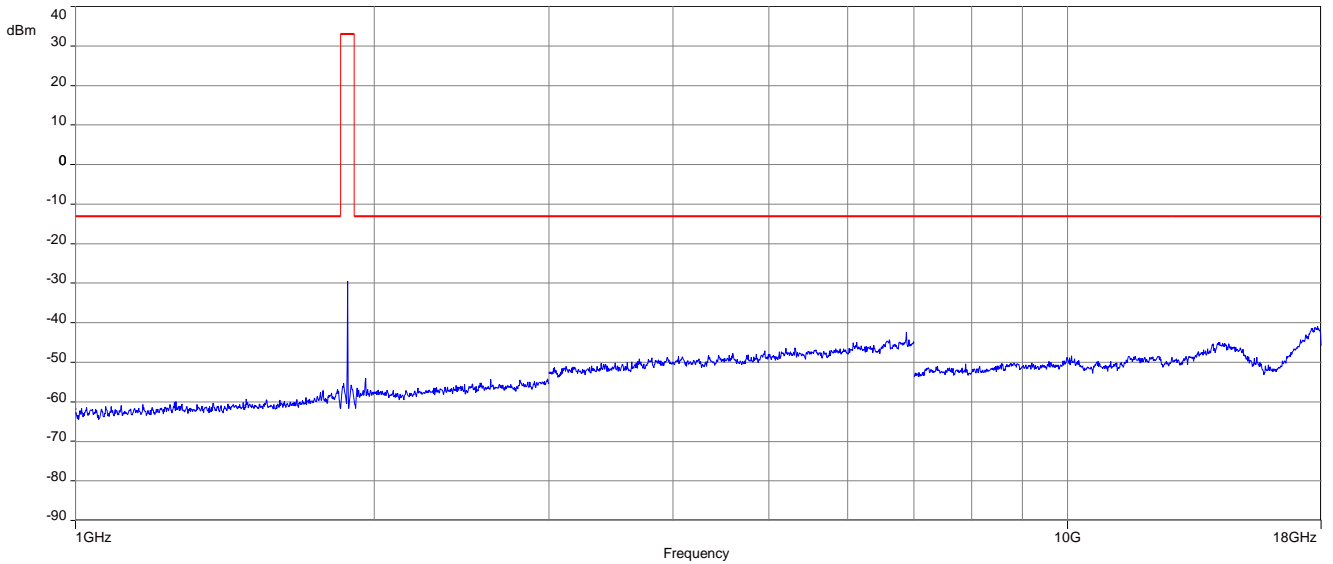

Carrier notched with 1.9 GHz rejection filter. The detected emissions

Plot 4: Channel 661 (18 GHz - 26 GHz)

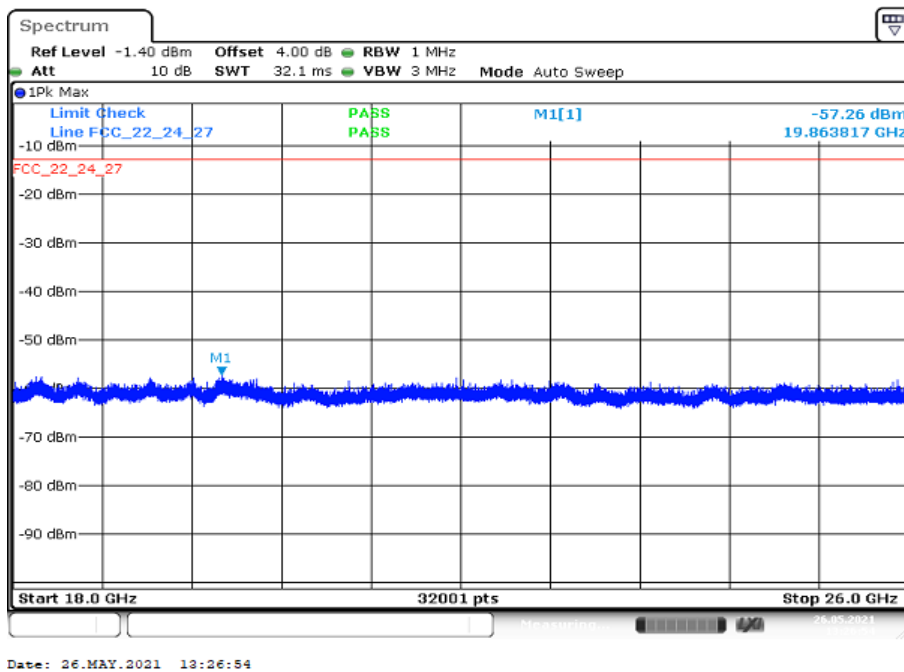

13 Results UMTS band II

All UMTS-band measurements are done in WCDMA mode only.

The connection was established with the following setup: WCDMA CS-RMC, Max Power (All Bit up)

13.1 RF output power

Description:

This paragraph contains average power, peak output power and EIRP measurements for the mobile station. In all cases, the peak output power is within the required mask (this mask is specified in the JTC standards, TIA PN3389 Vol. 1 Chap 7, and is no FCC requirement).

Measurement:

The mobile was set up for the maximum output power with pseudo random data modulation.

To determine the Peak-To-Average Power Ratio (PAPR) the measurement was performed with the Power Complementary Cumulative Distribution Function (CCDF).

Measurement parameters	
Detector:	Peak and RMS (Power in Burst)
Sweep time:	Auto
Video bandwidth:	10 MHz
Resolution bandwidth:	10 MHz
Span:	Zero Span
Trace mode:	Max hold
Used equipment:	See chapter 7.2 – setup B See chapter 7.4 – setup B
Measurement uncertainty:	See chapter 9

Limits:

FCC	IC
CFR Part 24.232 CFR Part 2.1046	RSS 133
Nominal Peak Output Power	
+33.00 dBm	
In measuring transmissions in this band using an average power technique, the peak-to-average ratio (PAR) of the transmission may not exceed 13 dB.	

Results:

Output Power (conducted) WCDMA mode			
Frequency (MHz)	Peak Output Power (dBm)	Average Output Power (dBm)	Peak to Average Ratio (dB) CCDF
1852.4	24.8	21.5	3.04
1880.0	25.8	22.1	2.99
1907.6	25.6	21.9	3.04

Output Power (radiated) WCDMA mode	
Frequency (MHz)	Average Output Power (dBm) - EIRP
1852.4	21.1
1880.0	21.1
1907.6	20.1

Plots:

Plot 1: CCDF, channel 9262

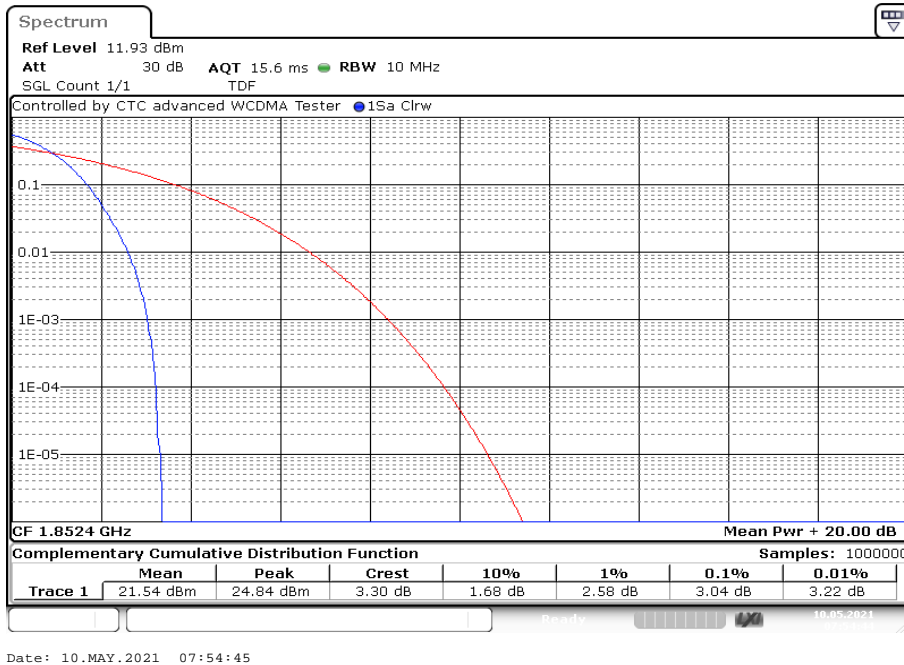

Plot 2: CCDF, channel 9400

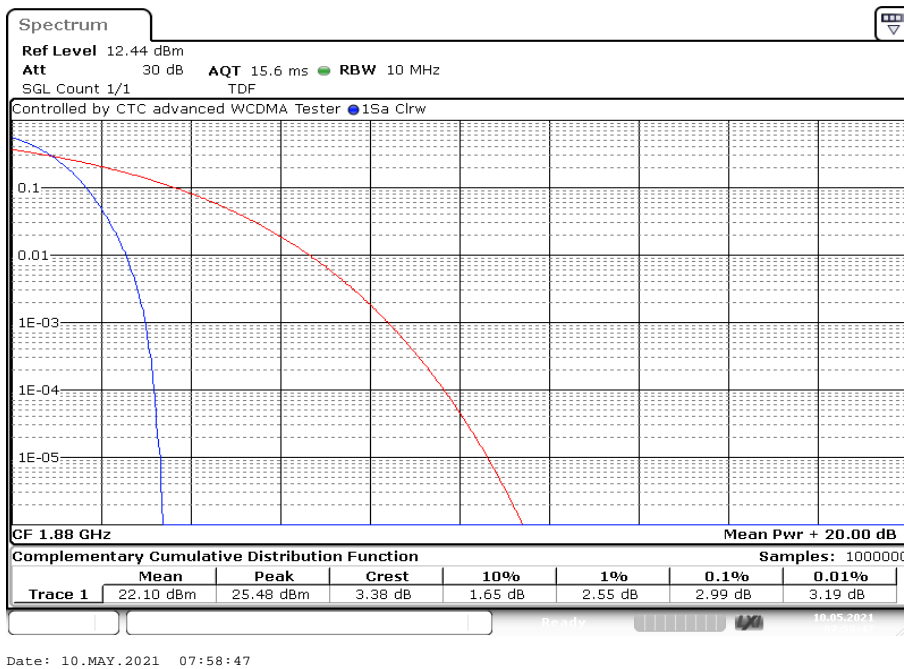

Plot 3: CCDF, channel 9538

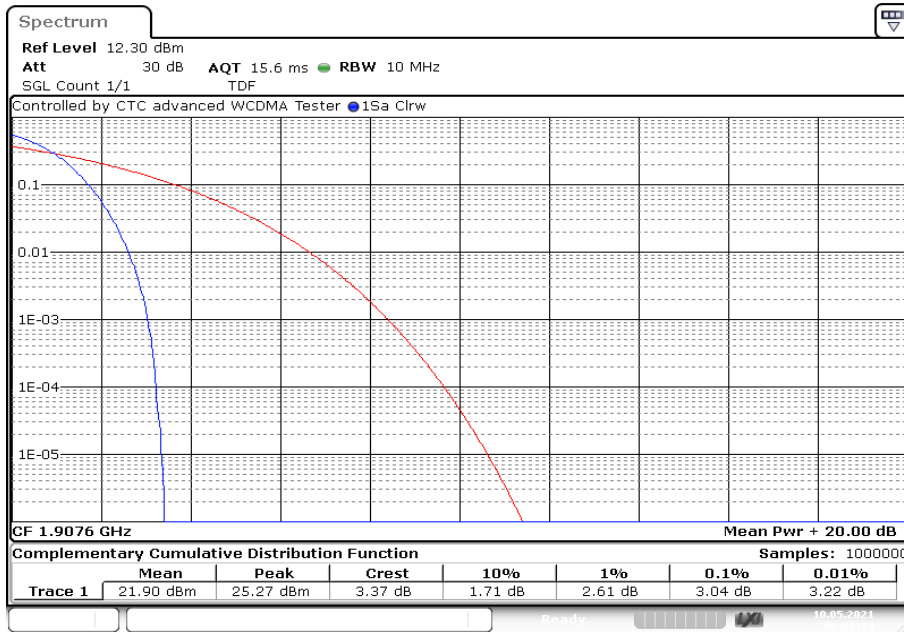

Date: 10.MAY.2021 08:02:15

13.2 Spurious emissions radiated

Description:

The following steps outline the procedure used to measure the radiated emissions from the mobile station. The site is constructed in accordance with ANSI C63.4:2014 requirements and is recognized by the FCC to be in compliance for a 3 and a 10 meter site. The spectrum was scanned from 30 MHz to the 10th harmonic of the highest frequency generated within the equipment, which is the transmitted carrier that can be as high as 1910 MHz. Measurement made up to 26 GHz. The resolution bandwidth is set as outlined in Part 24.238.

Measurement:

Measurement parameters	
Detector:	Peak
Sweep time:	2 sec.
Resolution bandwidth:	1 MHz
Video bandwidth:	3 MHz
Span:	100 MHz Steps
Trace mode:	Max hold
Used equipment:	See chapter 7.1 - setup B & 7.2 - setup A/B & 7.3 - setup A
Measurement uncertainty:	See chapter 9

Limits:

FCC	IC
Attenuation $\geq 43 + 10\log(P)$ (P, Power in Watts)	
-13 dBm	

Results UMTS band II:

Radiated emissions measurements were made only at the center carrier frequencies of the band II (1880.0 MHz) to show the compliance with cabinet radiation limits.

Spurious Emission Level (dBm)								
Harmonic	Ch. 9262 Freq. (MHz)	Level [dBm]	Harmonic	Ch. 9400 Freq. (MHz)	Level [dBm]	Harmonic	Ch. 9538 Freq. (MHz)	Level [dBm]
2	3704.8	-/-	2	3760.0	-/-	2	3815.2	-/-
3	5557.2	-/-	3	5640.0	-/-	3	5722.8	-/-
4	7409.6	-/-	4	7520.0	-/-	4	7630.4	-/-
5	9262.0	-/-	5	9400.0	-/-	5	9538.0	-/-
6	11114.4	-/-	6	11280.0	-/-	6	11445.6	-/-
7	12966.8	-/-	7	13160.0	-/-	7	13353.2	-/-
8	14819.2	-/-	8	15040.0	-/-	8	15260.8	-/-
9	16671.6	-/-	9	16920.0	-/-	9	17168.4	-/-
10	18524.0	-/-	10	18800.0	-/-	10	19076.0	-/-
Additional emissions								
Frequency			Detector / RBW			Level [dBm]		
1834.2 MHz			Peak / 1 MHz			-18.9		
-/-			-/-			-/-		

Plots:

Plot 1: Channel 9400 (Traffic mode up to 30 MHz)

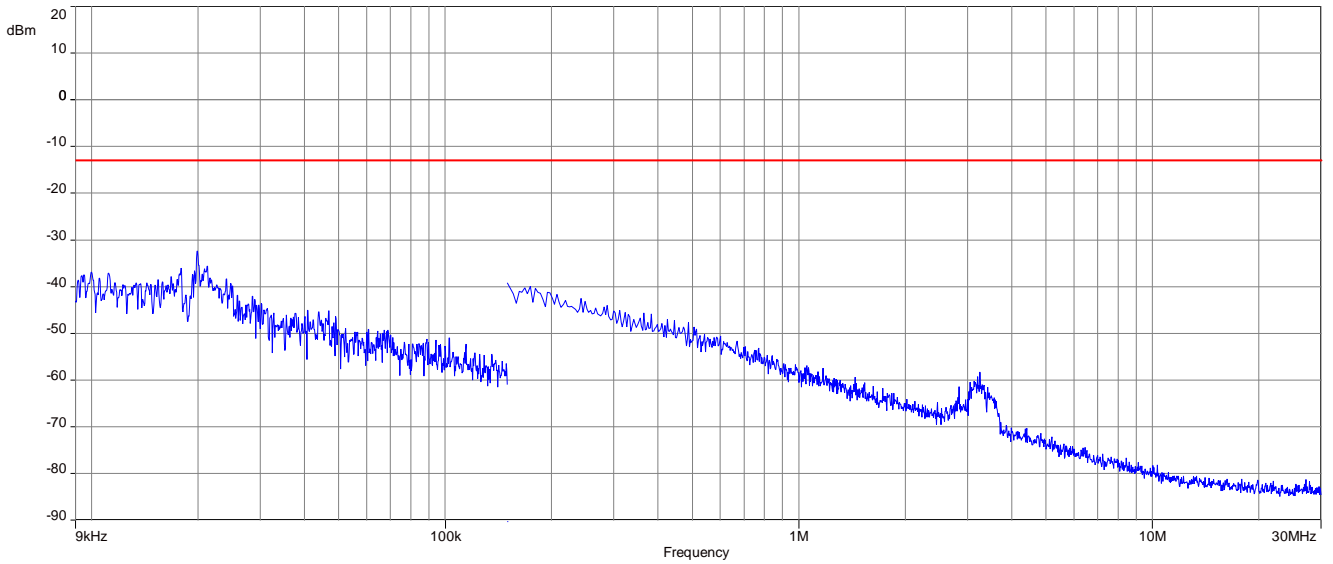

Plot 2: Channel 9400 (30 MHz – 1 GHz)

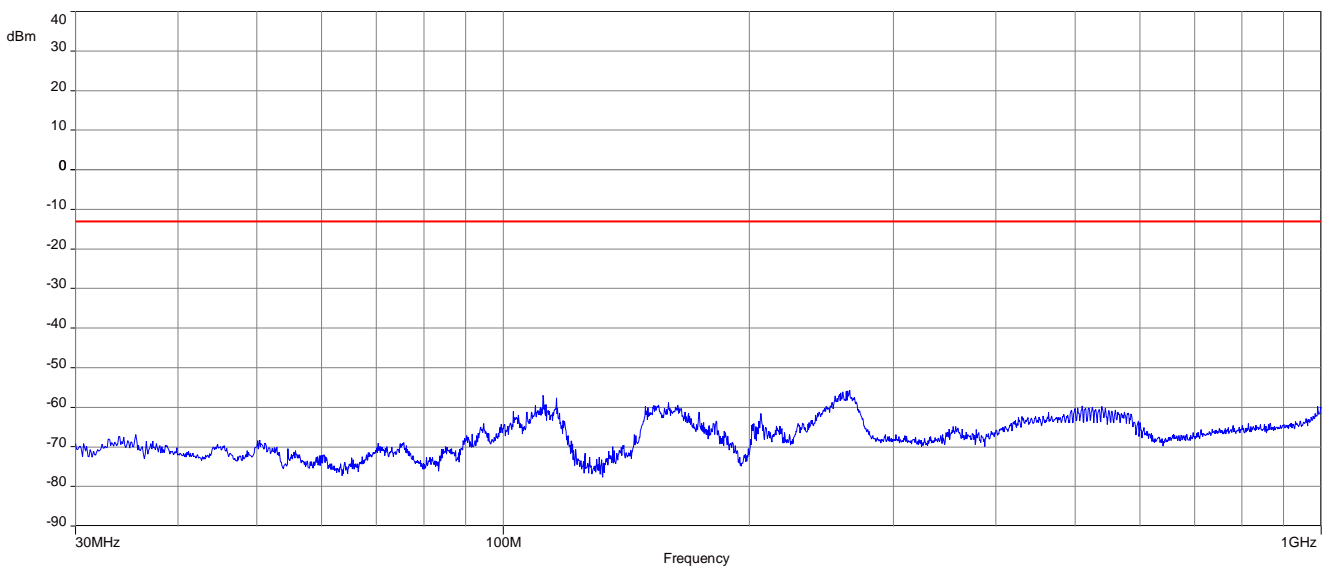

Plot 3: Channel 9400 (1 GHz – 18 GHz)

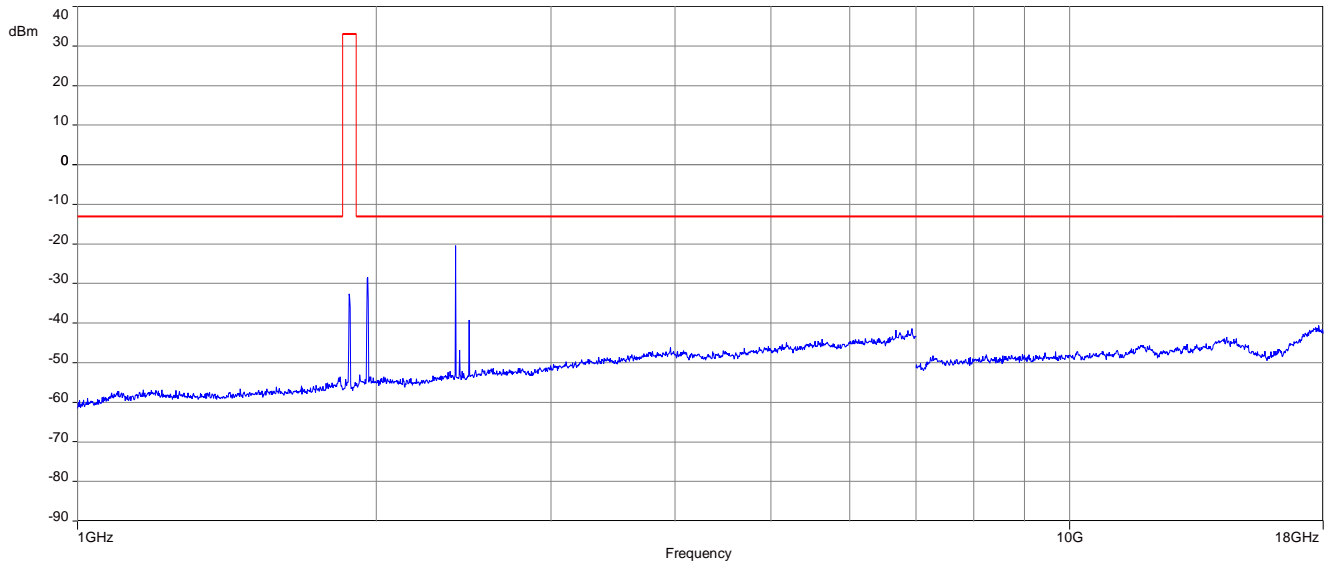

Carrier notched with 1.9 GHz rejection filter. The detected emissions @ 2.4 GHz are the advertiser channels from the BT LE radio part of the device.

Plot 4: Channel 9400 (18 GHz - 26 GHz)

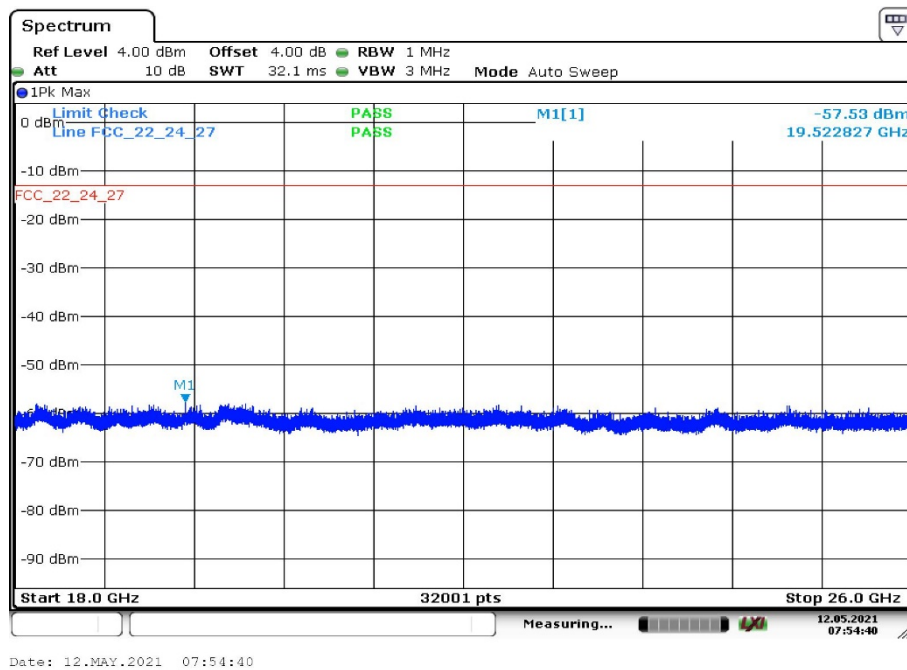

14 Results UMTS band IV

All UMTS-band measurements are done in WCDMA mode only.

The connection was established with the following setup: WCDMA CS-RMC, Max Power (All Bit up)

14.1 RF output power

Description:

This paragraph contains average power, peak output power and EIRP measurements for the mobile station. In all cases, the peak output power is within the required mask (this mask is specified in the JTC standards, TIA PN3389 Vol. 1 Chap 7, and is no FCC requirement).

Measurement:

The mobile was set up for the maximum output power with pseudo random data modulation.

To determine the Peak-To-Average Power Ratio (PAPR) the measurement was performed with the Power Complementary Cumulative Distribution Function (CCDF).

Measurement parameters	
Detector:	Peak and RMS (Power in Burst)
Sweep time:	Auto
Video bandwidth:	10 MHz
Resolution bandwidth:	10 MHz
Span:	Zero Span
Trace mode:	Max Hold
Used equipment:	See chapter 7.2 – setup B See chapter 7.4 – setup B
Measurement uncertainty:	See chapter 9

Limits:

FCC	IC
CFR Part 27.50 CFR Part 2.1046	RSS 139
Nominal Peak Output Power	
+30.00 dBm	
In measuring transmissions in this band using an average power technique, the peak-to-average ratio (PAR) of the transmission may not exceed 13 dB.	

Results:

Output Power (conducted) WCDMA mode			
Frequency (MHz)	Peak Output Power (dBm)	Average Output Power (dBm)	Peak to Average Ratio (dB) CCDF
1712.4	24.8	21.4	3.10
1732.4	25.2	21.9	2.96
1752.6	24.2	20.9	2.93

Output Power (radiated) WCDMA mode	
Frequency (MHz)	Average Output Power (dBm) - EIRP
1712.4	19.4
1732.4	20.9
1752.6	19.5

Plots:

Plot 1: CCDF, channel 1312

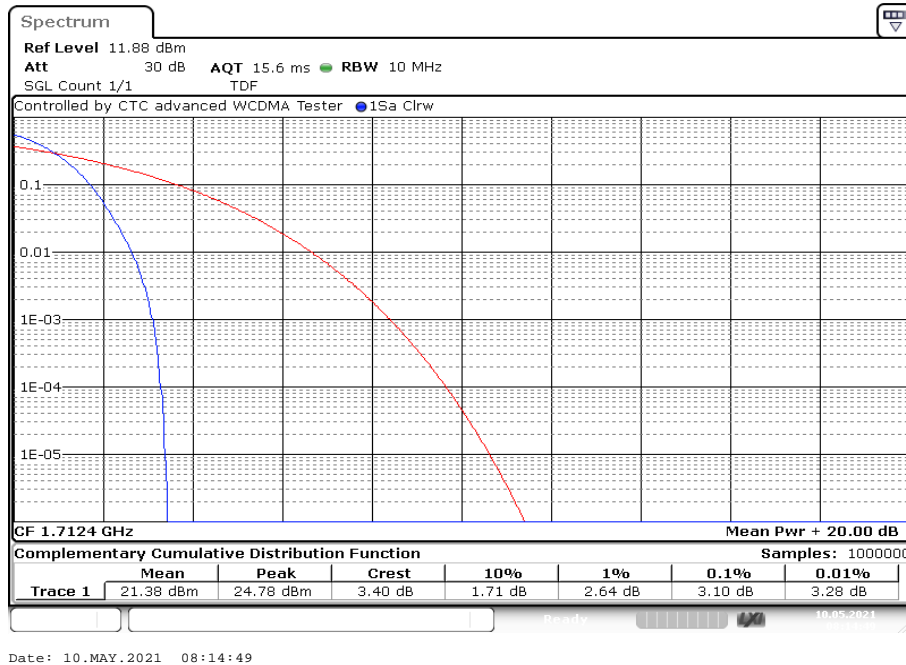

Plot 2: CCDF, channel 1412

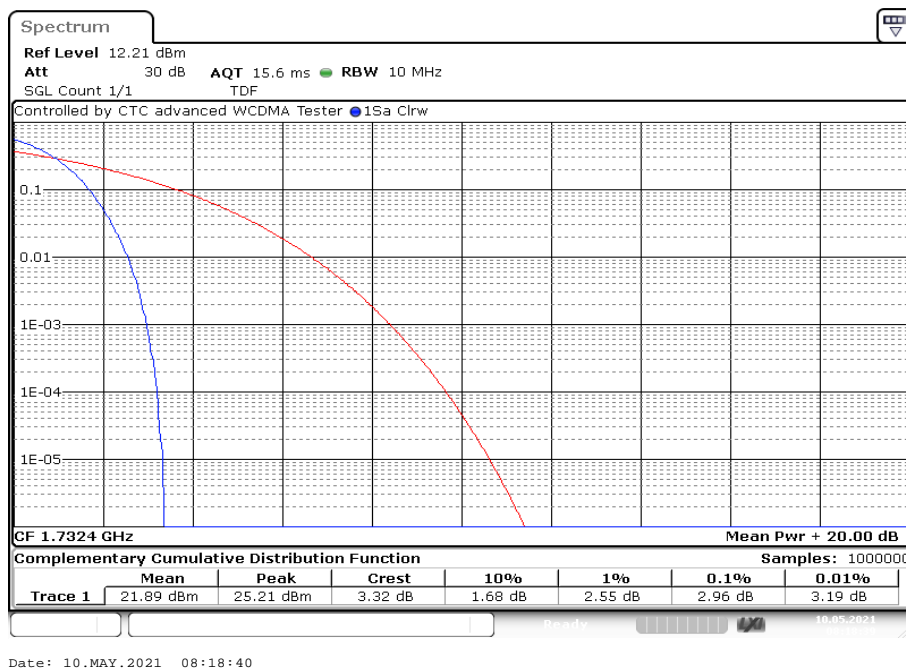

Plot 3: CCDF, channel 1513

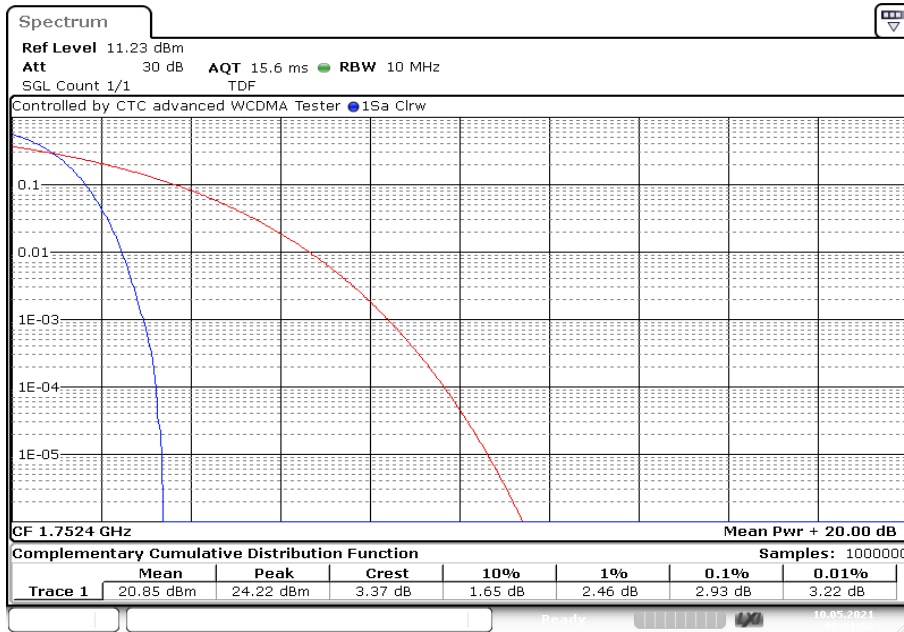

Date: 10.MAY.2021 08:21:56

14.2 Spurious emissions radiated

Description:

The following steps outline the procedure used to measure the radiated emissions from the mobile station. The site is constructed in accordance with ANSI C63.4:2014 requirements and is recognized by the FCC to be in compliance for a 3 and a 10 meter site. The spectrum was scanned from 30 MHz to the 10th harmonic of the highest frequency generated within the equipment, which is the transmitted carrier that can be as high as 1755 MHz. The resolution bandwidth is set as outlined in Part 27.53.

Measurement:

Measurement parameters	
Detector:	Peak
Sweep time:	2 sec.
Video bandwidth:	3 MHz
Resolution bandwidth:	1 MHz
Span:	100 MHz Steps
Trace mode:	Max Hold
Used equipment:	See chapter 7.1 – setup B; 7.2 – setup A/B; 7.3 – setup A
Measurement uncertainty:	See chapter 9

Limits:

FCC	IC
CFR Part 27.53(g) CFR Part 2.1053	RSS 139
Spurious Emissions Radiated	
Attenuation $\geq 43 + 10\log(P)$ (P, Power in Watts)	
-13 dBm	

Results UMTS band IV:

Radiated emissions measurements were made only at the center carrier frequencies of the band IV (1732.4 MHz) to show the compliance with cabinet radiation limits.

Spurious Emission Level (dBm)								
Harmonic	Ch. 1312 Freq. (MHz)	Level [dBm]	Harmonic	Ch. 1412 Freq. (MHz)	Level [dBm]	Harmonic	Ch. 1513 Freq. (MHz)	Level [dBm]
2	3424.8	-/-	2	3464.8	-/-	2	3505.2	-/-
3	5137.2	-/-	3	5197.2	-/-	3	5257.8	-/-
4	6849.6	-/-	4	6929.6	-/-	4	7010.4	-/-
5	8562.0	-/-	5	8662.0	-/-	5	8763.0	-/-
6	10274.4	-/-	6	10394.4	-/-	6	10515.6	-/-
7	11986.8	-/-	7	12126.8	-/-	7	12268.2	-/-
8	13699.2	-/-	8	13859.2	-/-	8	14020.8	-/-
9	15411.6	-/-	9	15591.6	-/-	9	15773.4	-/-
10	17124.0	-/-	10	17324.0	-/-	10	17526.0	-/-

Plots:

Plot 1: Channel 1412 (Traffic mode up to 30 MHz)

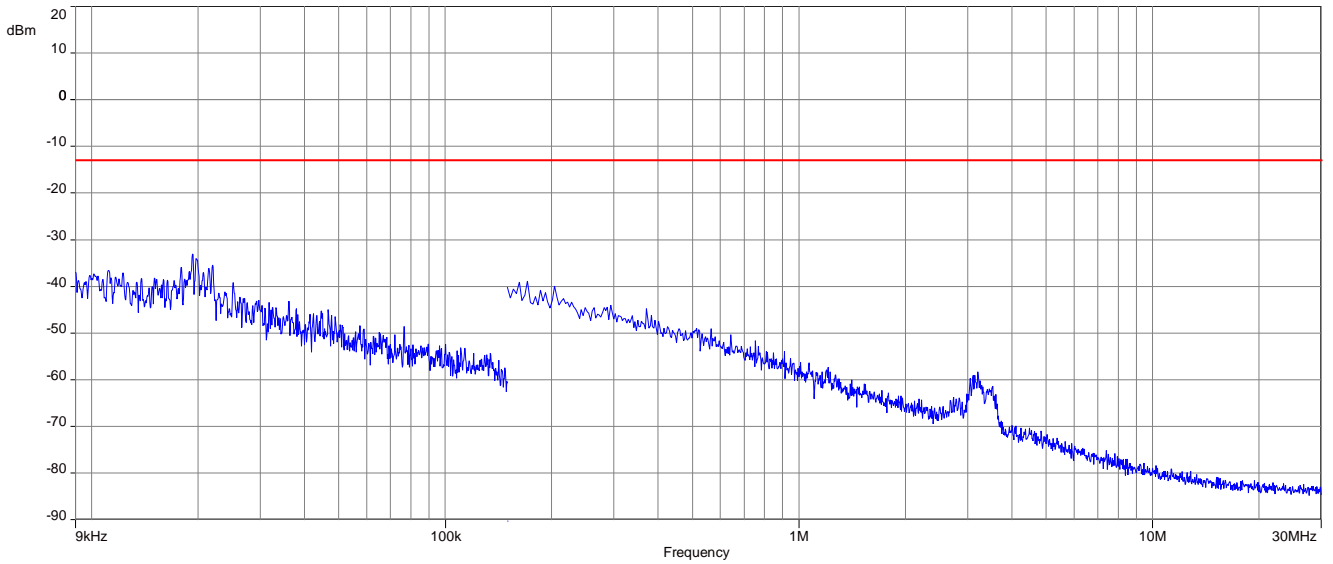

Plot 2: Channel 1412 (30 MHz – 1 GHz)

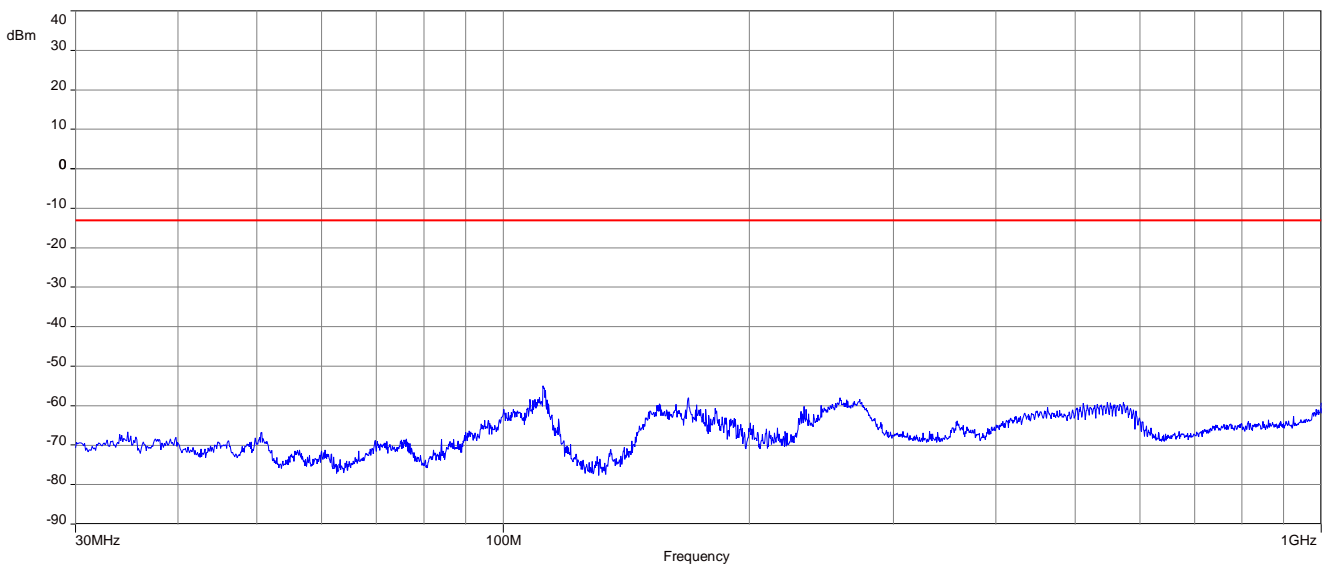

Plot 3: Channel 1412 (1 GHz – 18 GHz)

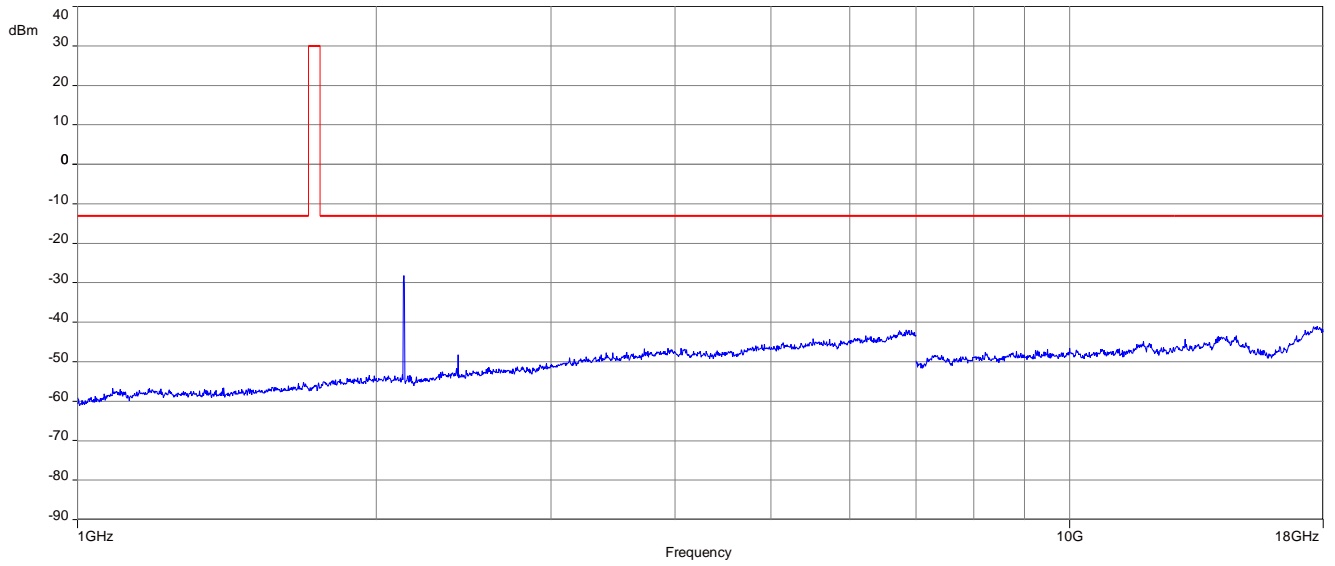

15 Results UMTS band V

All UMTS-band measurements are done in WCDMA mode only.

The connection was established with the following setup: WCDMA CS-RMC, Max Power (All Bit up)

15.1 RF output power

Description:

This paragraph contains average power, peak output power and ERP measurements for the mobile station. In all cases, the peak output power is within the required mask (this mask is specified in the JTC standards, TIA PN3389 Vol. 1 Chap 7, and is no FCC requirement).

Measurement:

The mobile was set up for the maximum output power with pseudo random data modulation.

To determine the Peak-To-Average Power Ratio (PAPR) the measurement was performed with the Power Complementary Cumulative Distribution Function (CCDF).

Measurement parameters	
Detector:	Peak and RMS (Power in Burst)
Sweep time:	Auto
Video bandwidth:	10 MHz
Resolution bandwidth:	10 MHz
Span:	Zero Span
Trace mode:	Max Hold
Used equipment:	See chapter 7.1 – setup A See chapter 7.4 – setup B
Measurement uncertainty:	see chapter 9

Limits:

FCC	IC
CFR Part 22.913 CFR Part 2.1046	RSS 132
Nominal Peak Output Power	
+38.45 dBm	
In measuring transmissions in this band using an average power technique, the peak-to-average ratio (PAR) of the transmission may not exceed 13 dB.	

Results:

Output Power (conducted) WCDMA mode			
Frequency (MHz)	Peak Output Power (dBm)	Average Output Power (dBm)	Peak to Average Ratio (dB) CCDF
826.4	26.1	22.7	3.13
836.0	25.7	22.3	3.10
846.6	26.0	22.7	3.01

Output Power (radiated) WCDMA mode	
Frequency (MHz)	Average Output Power (dBm) - ERP
826.4	20.1
836.0	20.0
846.6	20.2

Plots:

Plot 1: CCDF, channel 4132

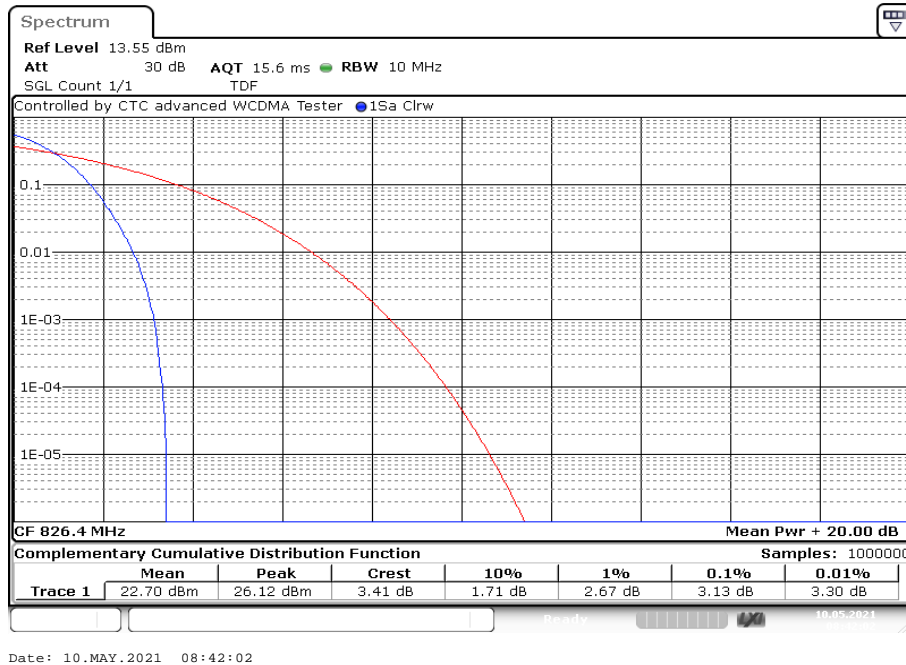

Plot 2: CCDF, channel 4180

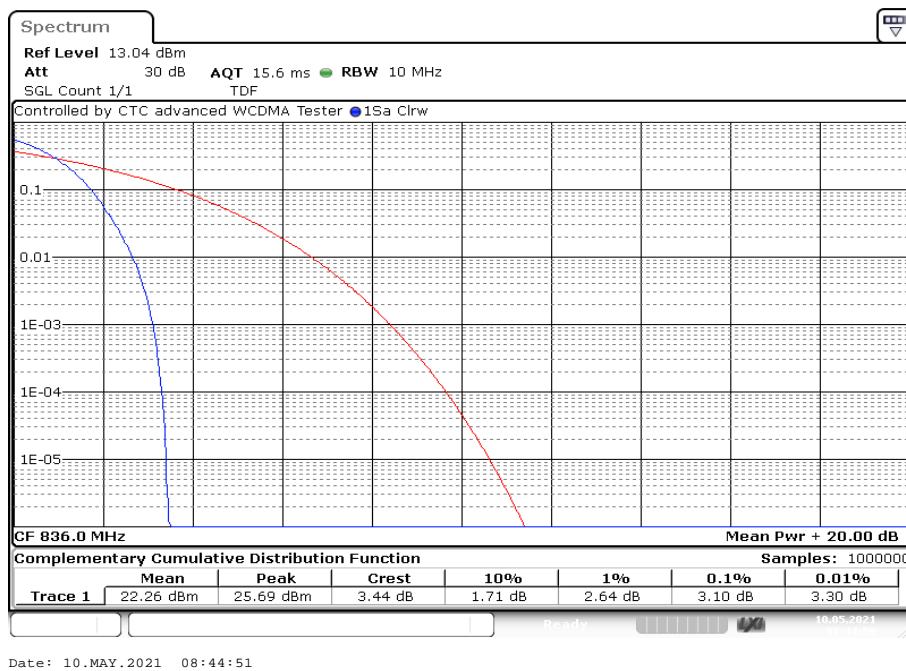

Plot 3: CCDF, channel 4233

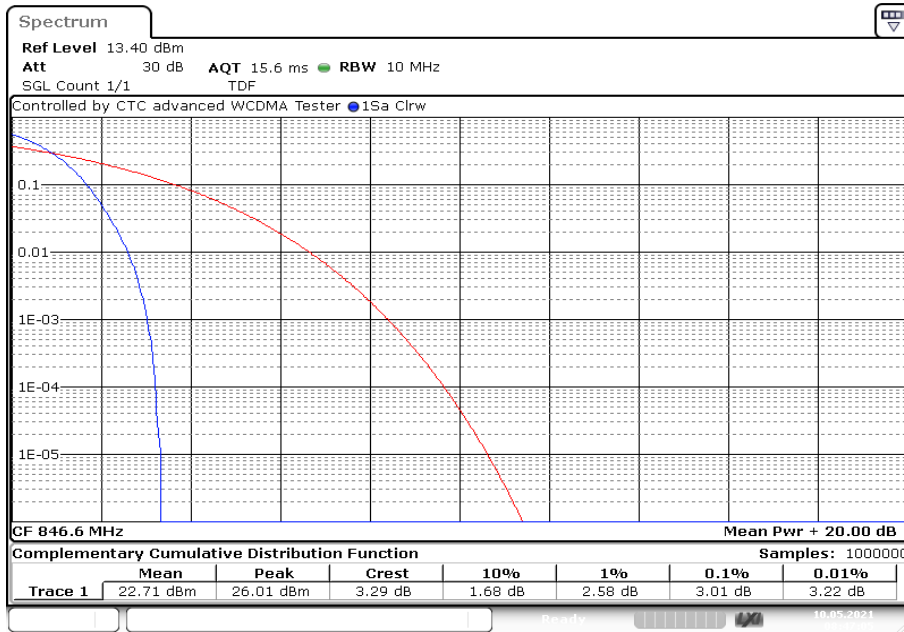

Date: 10.MAY.2021 08:47:05

15.2 Spurious emissions radiated

Description:

The following steps outline the procedure used to measure the radiated emissions from the mobile station. The site is constructed in accordance with ANSI C63.4:2014 requirements and is recognized by the FCC to be in compliance for a 3 and a 10 meter site. The spectrum was scanned from 30 MHz to the 10th harmonic of the highest frequency generated within the equipment, which is the transmitted carrier that can be as high as 848.6 MHz. Measurements made up to 9 GHz. The resolution bandwidth is set as outlined in Part 22.917.

Measurement:

Measurement parameters	
Detector:	Peak
Sweep time:	2 sec.
Video bandwidth:	300 kHz
Resolution bandwidth:	100 kHz
Span:	100 MHz Steps
Trace mode:	Max Hold
Used equipment:	See chapter 7.1 – setup B, 7.2 – setup A/B
Measurement uncertainty:	See chapter 9

Limits:

FCC	IC
CFR Part 22.917 CFR Part 2.1053	RSS 132
Spurious Emissions Radiated	
Attenuation $\geq 43 + 10\log(P)$ (P, Power in Watts)	
-13 dBm	

Results UMTS band V:

Radiated emissions measurements were made only at the center carrier frequencies of the band V (836.4 MHz) to show the compliance with cabinet radiation limits.

Spurious Emission Level (dBm)								
Harmonic	Ch. 4132 Freq. (MHz)	Level [dBm]	Harmonic	Ch. 4180 Freq. (MHz)	Level [dBm]	Harmonic	Ch. 4233 Freq. (MHz)	Level [dBm]
2	1652.8	-/-	2	1672.0	All emissions are more than 20dB below the limit.	2	1693.2	-/-
3	2479.2	-/-	3	2508.0		3	2539.8	-/-
4	3305.6	-/-	4	3344.0		4	3386.4	-/-
5	4132.0	-/-	5	4180.0		5	4233.0	-/-
6	4958.4	-/-	6	5016.0		6	5079.6	-/-
7	5784.8	-/-	7	5852.0		7	5926.2	-/-
8	6611.2	-/-	8	6688.0		8	6772.8	-/-
9	7437.6	-/-	9	7524.0		9	7619.4	-/-
10	8264.0	-/-	10	8360.0		10	8466.0	-/-

Plots:

Plot 1: Channel 4180 (Traffic mode up to 30 MHz)

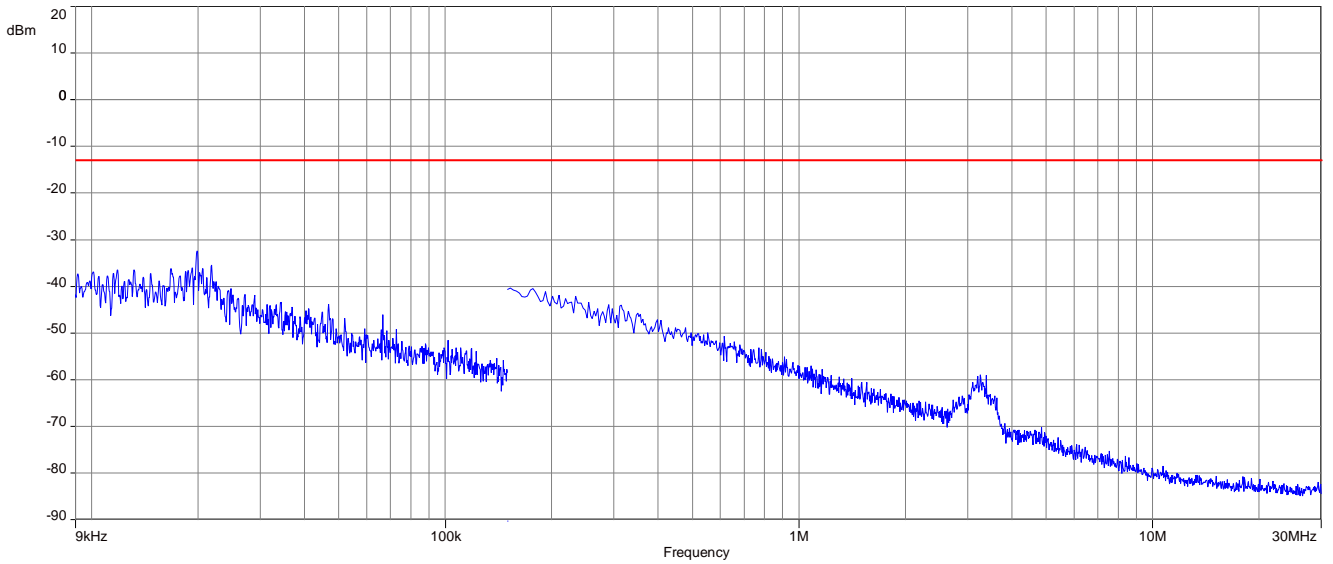

Plot 2: Channel 4180 (30 MHz – 1 GHz)

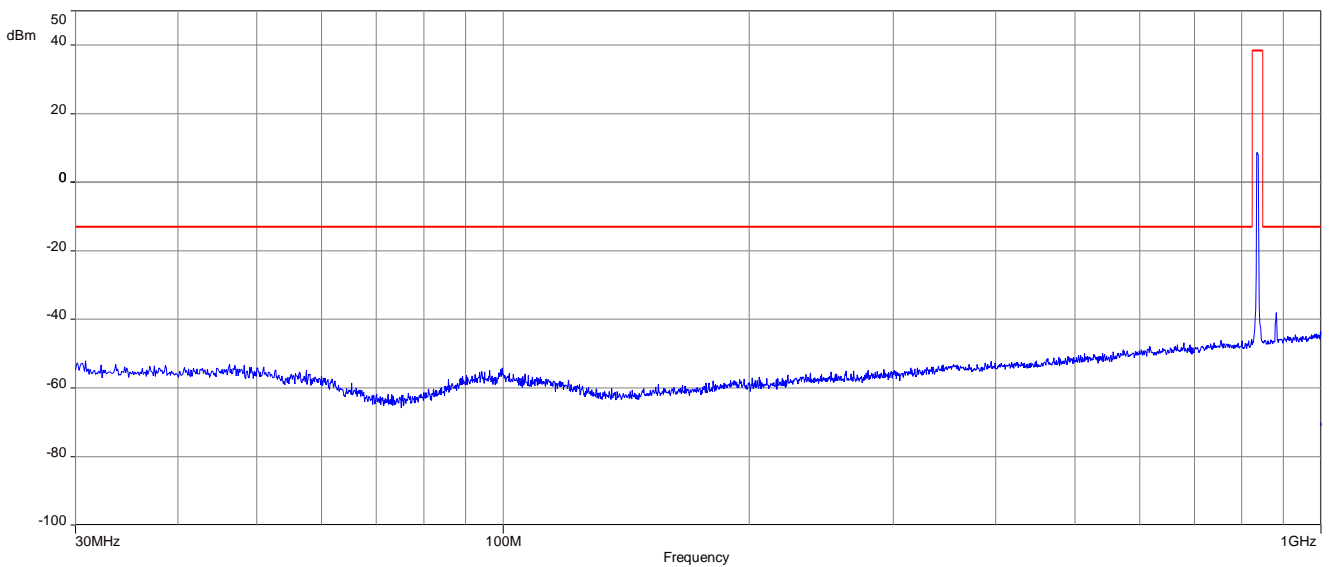

Plot 3: Channel 4180 (1 GHz – 9 GHz)

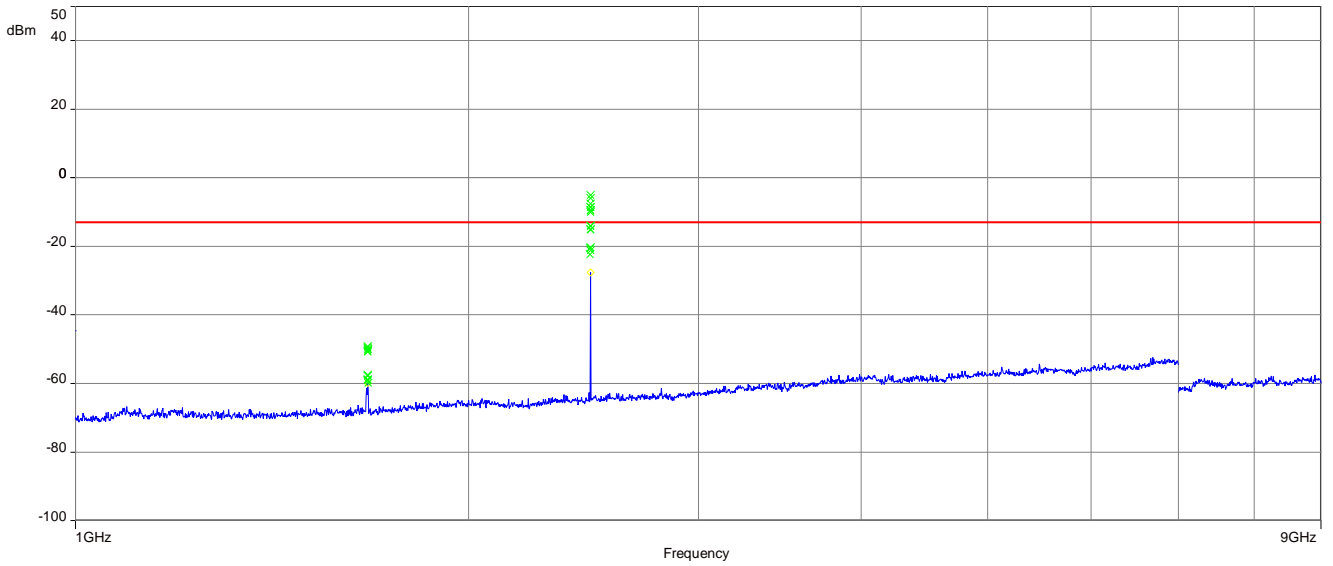

The detected emissions @ 2.4 GHz are the advertiser channels from the BT LE radio part of the device.

16 Summary of measurement results LTE band 2

<input type="checkbox"/>	No deviations from the technical specifications were ascertained
<input type="checkbox"/>	There were deviations from the technical specifications ascertained
<input checked="" type="checkbox"/>	This test report is only a partial test report. The content and verdict of the performed test cases are listed below.

16.1 LTE – Band 2

TC identifier	Description	verdict	date	Remark
RF-Testing	CFR Part 24 RSS 133	See table	2021-06-08	Delta tests according to manufacturer demand!

Test Case	temperature conditions	power source voltages	C	NC	NA	NP	Remark
RF Output Power	Nominal	Nominal	<input checked="" type="checkbox"/>	<input type="checkbox"/>	<input type="checkbox"/>	<input type="checkbox"/>	-/-
Frequency Stability	Extreme	Extreme	<input type="checkbox"/>	<input type="checkbox"/>	<input type="checkbox"/>	<input checked="" type="checkbox"/>	-/-
Spurious Emissions Radiated	Nominal	Nominal	<input checked="" type="checkbox"/>	<input type="checkbox"/>	<input type="checkbox"/>	<input type="checkbox"/>	-/-
Spurious Emissions Conducted	Nominal	Nominal	<input type="checkbox"/>	<input type="checkbox"/>	<input type="checkbox"/>	<input checked="" type="checkbox"/>	-/-
Block Edge Compliance	Nominal	Nominal	<input type="checkbox"/>	<input type="checkbox"/>	<input type="checkbox"/>	<input checked="" type="checkbox"/>	-/-
Occupied Bandwidth	Nominal	Nominal	<input type="checkbox"/>	<input type="checkbox"/>	<input type="checkbox"/>	<input checked="" type="checkbox"/>	-/-

Notes:

C	Compliant	NC	Not compliant	NA	Not applicable	NP	Not performed
----------	-----------	-----------	---------------	-----------	----------------	-----------	---------------

17 RF measurements LTE band 2

17.1 Description of test setup

For the spurious measurements we use the substitution method according TIA/EIA 603.

17.2 Results

17.2.1 RF output power

Description:

This paragraph contains average power, peak output power and EIRP measurements for the mobile station. In all cases, the peak output power is within the required mask (this mask is specified in the JTC standards, TIA PN3389 Vol. 1 Chap 7, and is no FCC requirement).

Measurement:

The mobile was set up for the maximum output power with pseudo random data modulation.

To determine the Peak-To-Average Power Ratio (PAPR) the measurement was performed with the Power Complementary Cumulative Distribution Function (CCDF).

Measurement parameters	
Detector	Measured with CMW500
Sweep time	
Video bandwidth	
Resolution bandwidth	
Span	
Trace mode	
Setup	See chapter 7.2 - setup B, 7.4 – setup B
Measurement uncertainty	See chapter 9

Limits:

FCC	ISED
Nominal Peak Output Power	
+33.00 dBm	
In measuring transmissions in this band using an average power technique, the peak-to-average ratio (PAR) of the transmission may not exceed 13 dB.	

Results:

Output Power (conducted)						
Bandwidth (MHz)	Frequency (MHz)	Resource block allocation	Average Output Power (dBm) QPSK	Peak to Average Ratio (dB)	Average Output Power (dBm) 16-QAM	Peak to Average Ratio (dB)
1.4	1850.7	1 RB low	17.6	4.8	16.9	5.6
		1 RB high	17.6	4.9	16.9	5.7
		50% RB mid	17.5	4.8	16.8	5.7
		100% RB	16.7	5.4	15.8	6.3
	1880.0	1 RB low	18.5	4.6	17.8	5.4
		1 RB high	18.6	4.6	17.9	5.3
		50% RB mid	18.5	4.6	17.7	5.4
		100% RB	17.7	5.2	16.7	6.1
	1909.3	1 RB low	18.5	3.6	17.7	4.5
		1 RB high	18.3	3.4	17.6	4.2
		50% RB mid	18.3	3.5	17.5	4.4
		100% RB	17.6	4.2	16.7	5.2
3	1851.5	1 RB low	17.5	4.8	16.8	5.6
		1 RB high	17.4	5.1	16.6	5.9
		50% RB mid	16.6	5.4	15.8	6.1
		100% RB	16.6	5.3	15.7	6.1
	1880.0	1 RB low	18.3	4.9	17.5	5.6
		1 RB high	18.6	4.5	17.8	5.2
		50% RB mid	17.7	5.2	16.7	6.1
		100% RB	17.7	5.2	16.7	6.1
	1908.5	1 RB low	18.1	4.4	17.4	5.2
		1 RB high	18.3	3.4	17.7	4.1
		50% RB mid	17.6	4.6	16.6	5.5
		100% RB	17.6	4.6	16.6	5.6
5	1852.5	1 RB low	17.6	4.6	17.0	5.3
		1 RB high	17.0	5.2	16.4	5.9
		50% RB mid	16.5	5.3	15.6	6.2
		100% RB	16.5	5.4	15.6	6.1
	1880.0	1 RB low	18.0	5.0	17.3	5.8
		1 RB high	18.6	4.3	17.9	5.1
		50% RB mid	17.7	5.2	16.7	6.0
		100% RB	17.6	5.2	16.6	6.1
	1907.5	1 RB low	17.1	5.2	16.4	6.1
		1 RB high	18.5	3.3	17.6	4.2
		50% RB mid	17.4	5.0	16.4	5.9
		100% RB	17.3	5.0	16.3	5.9

10	1855	1 RB low	17.5	4.7	16.8	5.5
		1 RB high	16.4	5.5	15.6	6.3
		50% RB mid	16.1	5.6	15.1	6.5
		100% RB	16.1	5.5	15.1	6.3
	1880	1 RB low	17.3	5.3	16.6	5.9
		1 RB high	18.5	4.3	17.5	5.1
		50% RB mid	17.7	5.2	16.7	6.1
		100% RB	17.4	5.2	16.4	6.1
	1905	1 RB low	16.1	5.6	15.5	6.4
		1 RB high	18.3	3.3	17.5	4.2
		50% RB mid	16.4	5.6	15.4	6.5
		100% RB	16.5	5.6	15.5	6.3
15	1857.5	1 RB low	17.4	4.7	16.7	5.4
		1 RB high	16.2	5.6	15.4	6.5
		50% RB mid	15.8	5.7	14.8	6.4
		100% RB	15.8	5.9	14.8	6.4
	1880.0	1 RB low	17.0	5.2	16.3	6.3
		1 RB high	17.8	4.4	16.9	5.4
		50% RB mid	17.6	5.1	16.6	6.0
		100% RB	17.3	5.3	16.2	6.1
	1902.5	1 RB low	16.3	5.4	15.4	6.3
		1 RB high	18.2	3.3	17.4	4.2
		50% RB mid	15.7	5.8	14.7	6.6
		100% RB	16.0	5.9	15.0	6.5
20	1860	1 RB low	17.3	4.4	16.5	5.4
		1 RB high	16.4	5.4	15.6	6.6
		50% RB mid	15.7	5.7	14.7	6.5
		100% RB	15.8	5.6	14.8	6.3
	1880	1 RB low	16.6	5.2	15.8	6.2
		1 RB high	17.3	4.5	16.5	5.3
		50% RB mid	17.5	5.2	16.5	6.0
		100% RB	17.0	5.2	16.0	6.0
	1900	1 RB low	17.0	4.7	16.4	5.4
		1 RB high	18.2	3.2	17.6	3.9
		50% RB mid	15.6	5.8	14.5	6.5
		100% RB	15.9	5.8	14.9	6.6

The radiated output power is measured in the mode with the highest conducted output power.

Output Power (radiated)			
Bandwidth (MHz)	Frequency (MHz)	Average Output Power (dBm)	Average Output Power (dBm)
		QPSK	16-QAM
1.4	1850.7	17.2	16.5
	1880.0	17.6	16.9
	1909.3	16.7	15.9
3	1851.5	17.1	16.4
	1880.0	17.6	16.8
	1908.5	16.5	15.9
5	1852.5	17.2	16.6
	1880.0	17.6	16.9
	1907.5	16.7	15.8
10	1855.0	17.1	16.4
	1880.0	17.5	16.5
	1905.0	16.5	15.7
15	1857.5	17.0	16.3
	1880.0	16.8	15.9
	1902.5	16.4	15.6
20	1860.0	16.9	16.1
	1880.0	16.5	15.5
	1900.0	16.4	15.8

17.2.2 Spurious emissions radiated

Description:

The following steps outline the procedure used to measure the radiated emissions from the mobile station. The site is constructed in accordance with ANSI C63.4:2014 requirements and is recognized by the FCC to be in compliance for a 3 and a 10 meter site. The spectrum was scanned from 30 MHz to the 10th harmonic of the highest frequency generated within the equipment, which is the transmitted carrier that can be as high as 1910 MHz. Measurement made up to 25 GHz. The resolution bandwidth is set as outlined in Part 24.238. The spectrum was scanned with the mobile station transmitting at carrier frequencies that pertain to low, mid and high channels of the LTE band II.

Measurement:

Measurement parameters	
Detector	Peak
Sweep time	2 sec.
Video bandwidth	Below 1 GHz: 100 kHz Above 1 GHz: 1 MHz
Resolution bandwidth	Below 1 GHz: 100 kHz Above 1 GHz: 1 MHz
Span	100 MHz Steps
Trace mode	Max Hold
Setup	See chapter 7.1 - setup B; 7.2 - setup A/B ; 7.3 - setup A
Measurement uncertainty	See chapter 9

Limits:

FCC	ISED
Spurious Emissions Radiated	
Attenuation $\geq 43 + 10\log(P)$ / (P, Power in Watts)	
-13 dBm	

QPSK:

Spurious Emission Level (dBm)								
Harmonic	Lowest channel Freq. (MHz)	Level [dBm]	Harmonic	Middle channel Freq. (MHz)	Level [dBm]	Harmonic	Highest channel Freq. (MHz)	Level [dBm]
2	3710.0	All detected emissions are more than 20dB below the limit!	2	3760.0	All detected emissions are more than 20dB below the limit!	2	3810.0	All detected emissions are more than 20dB below the limit!
3	5565.0		3	5640.0		3	5715.0	
4	7420.0		4	7520.0		4	7620.0	
5	9275.0		5	9400.0		5	9525.0	
6	11130.0		6	11280.0		6	11430.0	
7	12985.0		7	13160.0		7	13335.0	
8	14840.0		8	15040.0		8	15240.0	
9	16695.0		9	16920.0		9	17145.0	
10	18550.0		10	18800.0		10	19050.0	

16-QAM:

Spurious Emission Level (dBm)								
Harmonic	Lowest channel Freq. (MHz)	Level [dBm]	Harmonic	Middle channel Freq. (MHz)	Level [dBm]	Harmonic	Highest channel Freq. (MHz)	Level [dBm]
2	3710.0	All detected emissions are more than 20dB below the limit!	2	3760.0	All detected emissions are more than 20dB below the limit!	2	3810.0	All detected emissions are more than 20dB below the limit!
3	5565.0		3	5640.0		3	5715.0	
4	7420.0		4	7520.0		4	7620.0	
5	9275.0		5	9400.0		5	9525.0	
6	11130.0		6	11280.0		6	11430.0	
7	12985.0		7	13160.0		7	13335.0	
8	14840.0		8	15040.0		8	15240.0	
9	16695.0		9	16920.0		9	17145.0	
10	18550.0		10	18800.0		10	19050.0	

Results: QPSK with 10 MHz channel bandwidth

Plot 1: Channel 18900 (Traffic mode up to 30 MHz)

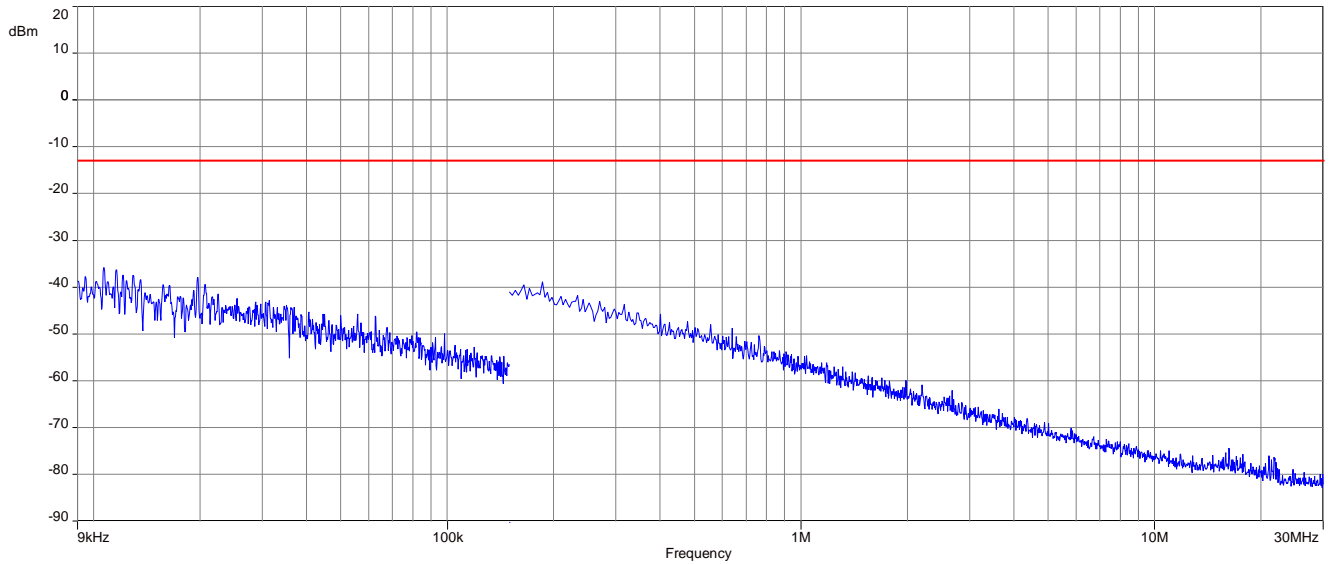

Plot 2: Channel 18900 (30 MHz – 1 GHz)

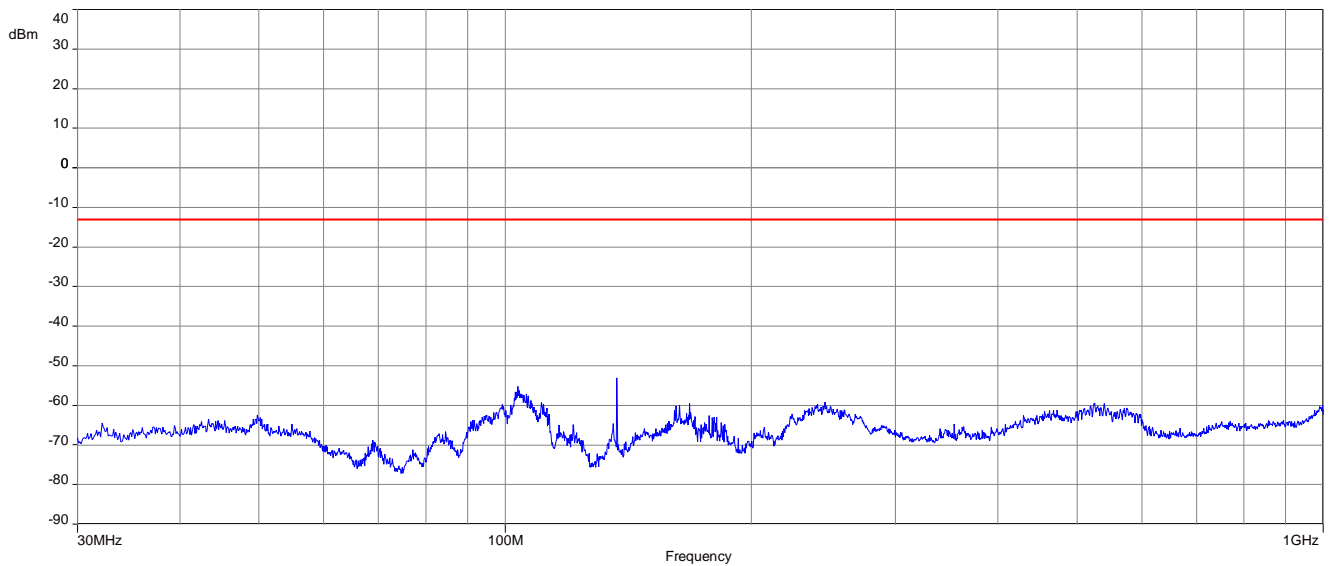

Plot 3: Channel 18900 (1 GHz – 18 GHz)

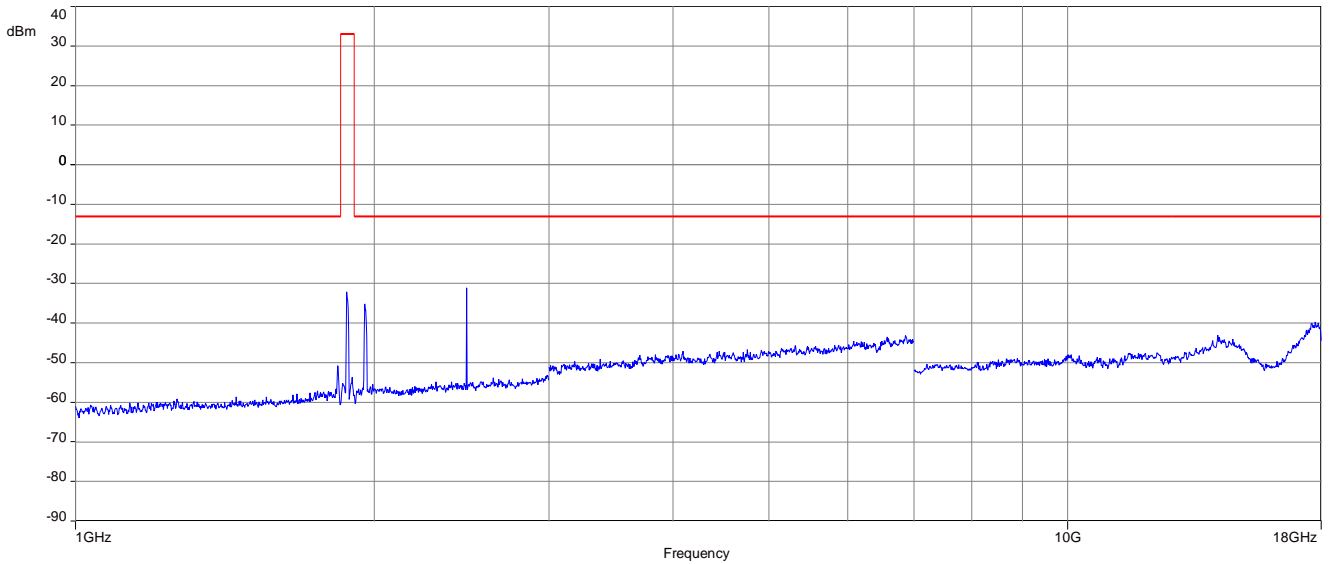

Carrier notched with 1.9 GHz rejection filter. The detected emissions @ 2.4 GHz are the advertiser channels from the BT LE radio part of the device.

Plot 4: Channel 18900 (18 GHz – 26 GHz)

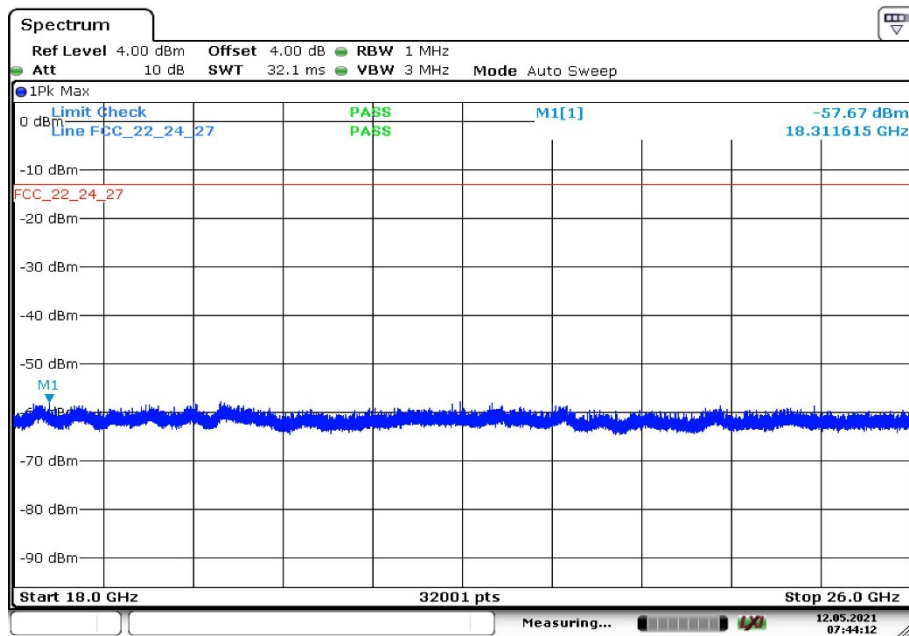

Date: 12.MAY.2021 07:44:12

Results: 16-QAM with 10 MHz channel bandwidth

Plot 1: Channel 18900 (Traffic mode up to 30 MHz)

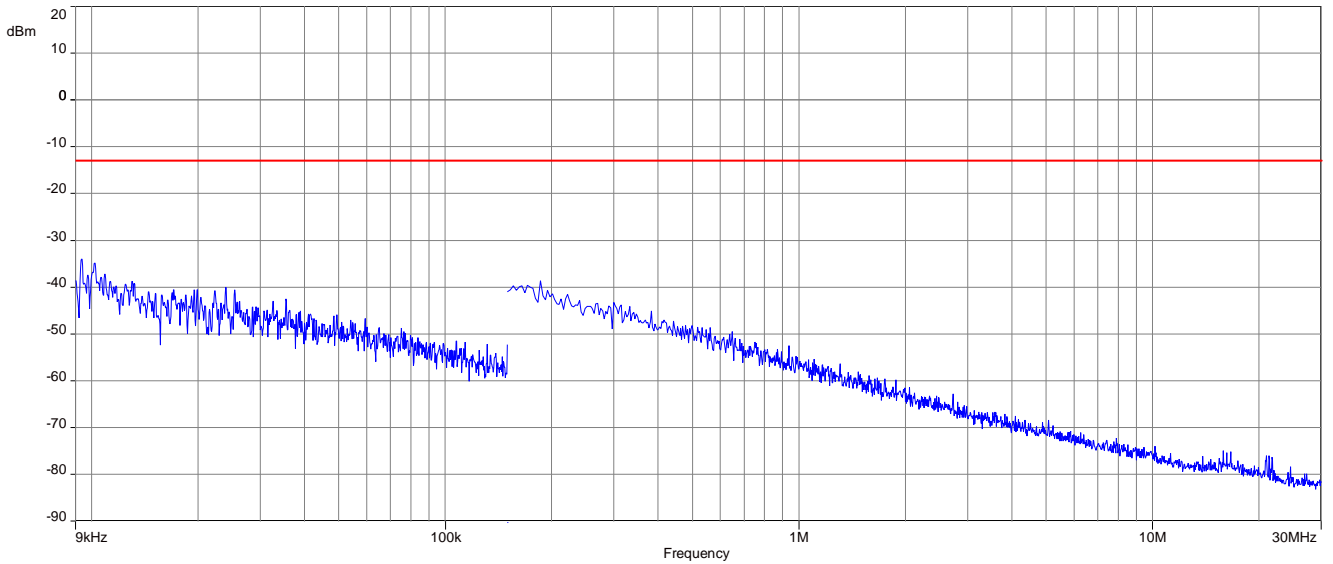

Plot 2: Channel 18900 (30 MHz – 1 GHz)

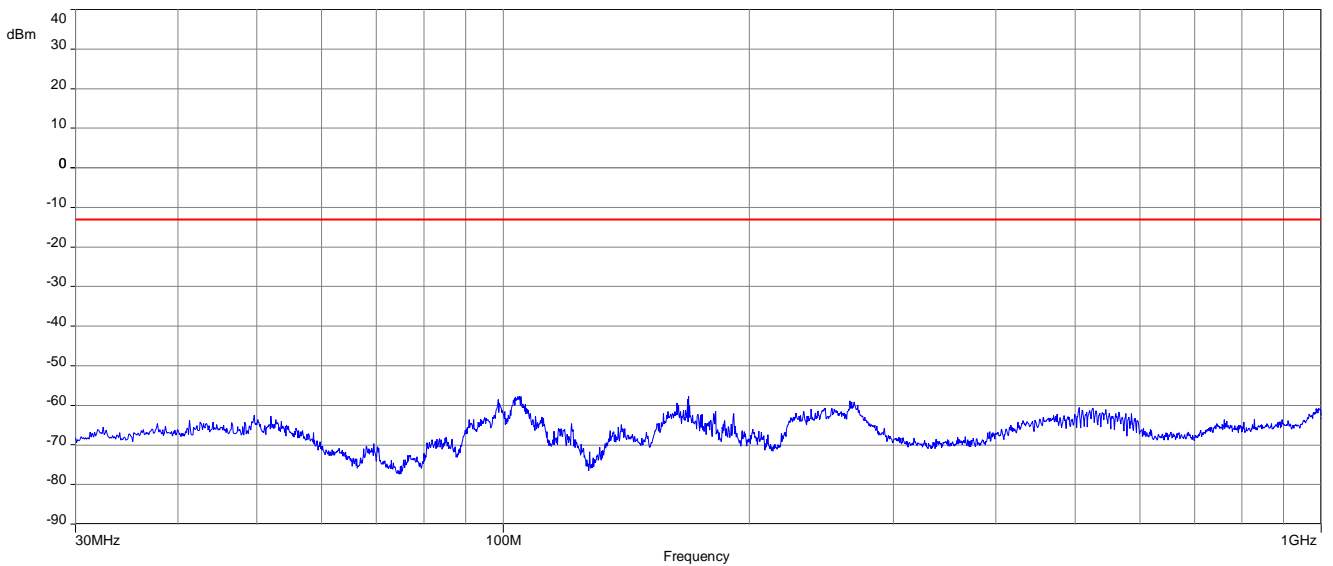

Plot 3: Channel 18900 (1 GHz – 18 GHz)

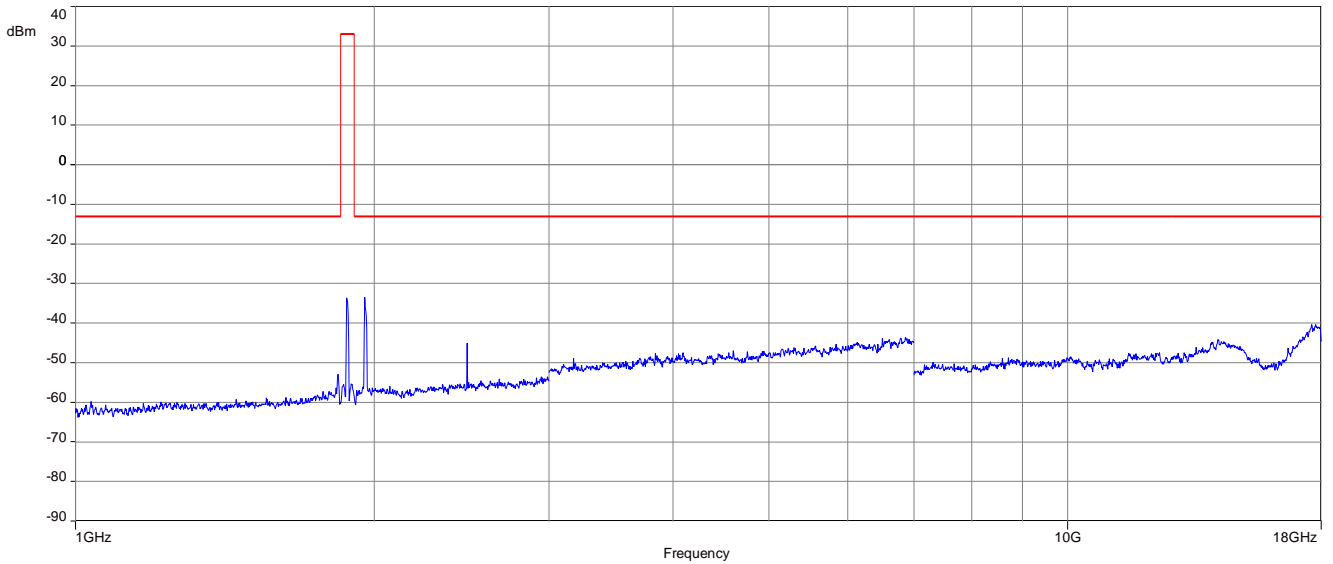

Carrier notched with 1.9 GHz rejection filter. The detected emissions @ 2.4 GHz are the advertiser channels from the BT LE radio part of the device.

Plot 4: Channel 18900 (18 GHz – 26 GHz)

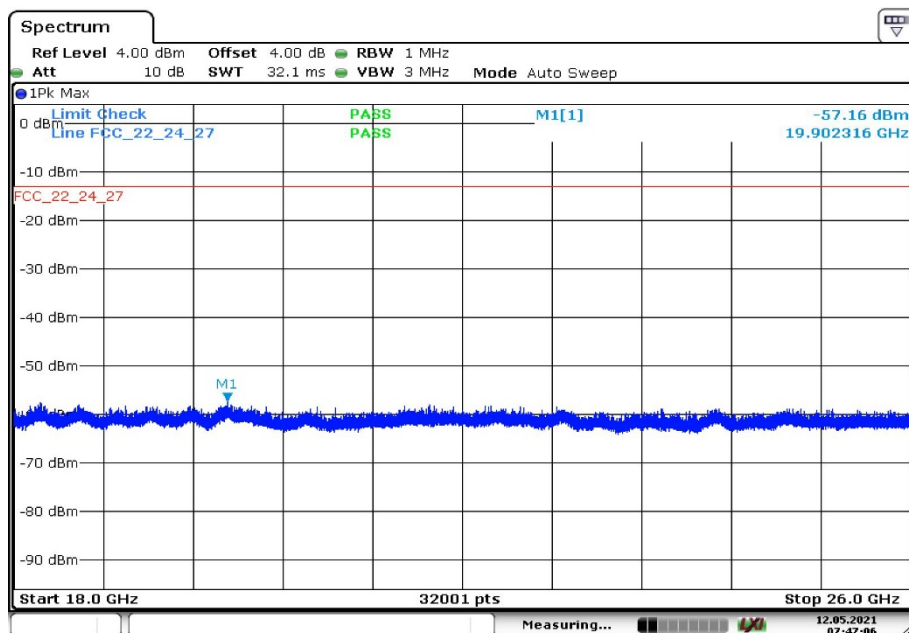

Date: 12.MAY.2021 07:47:06

18 Summary of measurement results LTE band 5

<input type="checkbox"/>	No deviations from the technical specifications were ascertained
<input type="checkbox"/>	There were deviations from the technical specifications ascertained
<input checked="" type="checkbox"/>	This test report is only a partial test report. The content and verdict of the performed test cases are listed below.

18.1 LTE – Band 5

TC identifier	Description	verdict	date	Remark
RF-Testing	CFR Part 22 RSS 132	See table	2021-06-08	Delta tests according to manufacturer demand!

Test Case	temperature conditions	power source voltages	C	NC	NA	NP	Remark
RF Output Power	Nominal	Nominal	<input checked="" type="checkbox"/>	<input type="checkbox"/>	<input type="checkbox"/>	<input type="checkbox"/>	-/-
Frequency Stability	Extreme	Extreme	<input type="checkbox"/>	<input type="checkbox"/>	<input type="checkbox"/>	<input checked="" type="checkbox"/>	-/-
Spurious Emissions Radiated	Nominal	Nominal	<input checked="" type="checkbox"/>	<input type="checkbox"/>	<input type="checkbox"/>	<input type="checkbox"/>	-/-
Spurious Emissions Conducted	Nominal	Nominal	<input type="checkbox"/>	<input type="checkbox"/>	<input type="checkbox"/>	<input checked="" type="checkbox"/>	-/-
Block Edge Compliance	Nominal	Nominal	<input type="checkbox"/>	<input type="checkbox"/>	<input type="checkbox"/>	<input checked="" type="checkbox"/>	-/-
Occupied Bandwidth	Nominal	Nominal	<input type="checkbox"/>	<input type="checkbox"/>	<input type="checkbox"/>	<input checked="" type="checkbox"/>	-/-

Notes:

C	Compliant	NC	Not compliant	NA	Not applicable	NP	Not performed
----------	-----------	-----------	---------------	-----------	----------------	-----------	---------------

19 RF measurements LTE band 5

19.1 Description of test setup

For the spurious measurements we use the substitution method according TIA/EIA 603.

19.2 Results

The EUT was set to transmit the maximum power.

19.2.1 RF output power

Description:

This paragraph contains conducted average power, ERP and Peak-to-Average Power Ratio measurements for the mobile station.

Measurement:

The mobile was set up for the maximum output power with pseudo random data modulation.

To determine the Peak-To-Average Power Ratio (PAPR) the measurement was performed with the Power Complementary Cumulative Distribution Function (CCDF).

Measurement parameters	
Detector	Measured with CMW500
Sweep time	
Video bandwidth	
Resolution bandwidth	
Span	
Trace mode	
Setup	See chapter 7.1 - setup B, 7.4 – setup B
Measurement uncertainty	See chapter 9

Limits:

FCC	ISED
Nominal Peak Output Power	
+38.45 dBm (FCC) / +33 dBm (IC)	
In measuring transmissions in this band using an average power technique, the peak-to-average ratio (PAR) of the transmission may not exceed 13 dB.	

Results:

Output Power (conducted)						
Bandwidth (MHz)	Frequency (MHz)	Resource block allocation	Average Output Power (dBm) QPSK	Peak to Average Ratio (dB)	Average Output Power (dBm) 16-QAM	Peak to Average Ratio (dB)
1.4	824.7	1 RB low	18.0	5.2	17.2	6.0
		1 RB high	18.2	5.0	17.3	5.8
		50% RB mid	18.1	4.9	17.2	5.9
		100% RB	17.1	5.5	16.2	6.4
	836.5	1 RB low	17.5	5.6	16.6	6.3
		1 RB high	17.5	5.7	16.7	6.3
		50% RB mid	17.5	5.5	16.6	6.4
		100% RB	16.5	5.8	15.5	6.7
	848.3	1 RB low	18.1	4.5	17.2	5.3
		1 RB high	18.1	4.4	17.2	5.3
		50% RB mid	18.0	4.5	17.1	5.4
		100% RB	17.2	5.1	16.2	5.9
3	825.5	1 RB low	17.9	5.2	17.0	5.9
		1 RB high	18.2	4.8	17.4	5.6
		50% RB mid	17.2	5.4	16.1	6.3
		100% RB	17.2	5.4	16.1	6.3
	836.5	1 RB low	17.4	5.4	16.6	6.2
		1 RB high	17.7	5.5	16.9	6.5
		50% RB mid	16.5	5.8	15.6	6.6
		100% RB	16.5	5.8	15.5	6.8
	847.5	1 RB low	18.1	4.7	17.3	5.5
		1 RB high	18.0	4.6	17.2	5.4
		50% RB mid	17.2	5.1	16.3	5.9
		100% RB	17.2	5.0	16.2	6.0
5	826.5	1 RB low	18.0	5.0	17.3	5.9
		1 RB high	18.3	4.5	17.5	5.3
		50% RB mid	17.2	5.3	16.2	6.2
		100% RB	17.2	5.3	16.2	6.1
	836.5	1 RB low	17.6	5.2	16.7	6.1
		1 RB high	17.7	5.7	16.9	6.6
		50% RB mid	16.6	5.8	15.6	6.5
		100% RB	16.6	5.7	15.5	6.6
	846.5	1 RB low	18.1	4.9	17.3	5.9
		1 RB high	18.1	4.5	17.3	5.3
		50% RB mid	17.2	5.2	16.2	6.0
		100% RB	17.2	5.2	16.2	5.9

10	829	1 RB low	18.0	5.1	17.1	6.0
		1 RB high	17.7	4.9	16.8	5.8
		50% RB mid	17.2	5.2	16.2	6.1
		100% RB	17.1	5.2	16.0	6.1
	836.5	1 RB low	17.8	4.7	17.0	5.5
		1 RB high	17.6	5.7	16.7	6.3
		50% RB mid	16.6	5.8	15.6	6.6
		100% RB	16.6	5.7	15.6	6.5
	844	1 RB low	17.5	5.6	16.7	6.6
		1 RB high	17.9	4.5	17.1	5.4
		50% RB mid	17.1	5.5	16.1	6.4
		100% RB	17.0	5.5	15.9	6.3

The radiated output power is measured in the mode with the highest conducted output power.

Output Power (radiated)			
Bandwidth (MHz)	Frequency (MHz)	Average Output Power (dBm)	Average Output Power (dBm)
		QPSK	16-QAM
1.4	824.7	15.6	14.7
	836.5	15.2	14.4
	848.3	15.6	14.7
3	825.5	15.6	14.8
	836.5	15.4	14.6
	847.5	15.6	14.8
5	826.5	15.7	14.9
	836.5	15.4	14.6
	846.5	15.6	14.8
10	829.0	15.4	14.5
	836.5	15.5	14.7
	844.0	15.4	14.6

19.2.2 Spurious emissions radiated

Description:

The following steps outline the procedure used to measure the radiated emissions from the mobile station. The site is constructed in accordance with ANSI C63.4:2014 requirements and is recognized by the FCC to be in compliance for a 3 and a 10 meter site. The spectrum was scanned from 30 MHz to the 10th harmonic of the highest frequency generated within the equipment, which is the transmitted carrier that can be as high as 846.6 MHz. Measurement made up to 12.75 GHz. The resolution bandwidth is set as outlined in Part 22.917. The spectrum was scanned with the mobile station transmitting at carrier frequencies that pertain to low, mid and high channels of the LTE band V.

Measurement:

Measurement parameters	
Detector	Peak
Sweep time	2 sec.
Video bandwidth	Below 1 GHz: 100 kHz Above 1 GHz: 1 MHz
Resolution bandwidth	Below 1 GHz: 100 kHz Above 1 GHz: 1 MHz
Span	100 MHz Steps
Trace mode	Max Hold
Setup	See chapter 7.1 - setup B; 7.2 - setup A/B
Measurement uncertainty	See chapter 9

Limits:

FCC	IC
Spurious Emissions Radiated	
Attenuation $\geq 43 + 10\log(P)$ / (P, Power in Watts)	
-13 dBm	

QPSK:

Spurious Emission Level (dBm)								
Harmonic	Lowest channel Freq. (MHz)	Level [dBm]	Harmonic	Middle channel Freq. (MHz)	Level [dBm]	Harmonic	Highest channel Freq. (MHz)	Level [dBm]
2	1658.0	All detected emissions are more than 20dB below the limit!	2	1673.0	All detected emissions are more than 20dB below the limit!	2	1688.0	All detected emissions are more than 20dB below the limit!
3	2487.0		3	2509.5		3	2532.0	
4	3316.0		4	3346.0		4	3376.0	
5	4145.0		5	4182.5		5	4220.0	
6	4974.0		6	5019.0		6	5064.0	
7	5803.0		7	5855.5		7	5908.0	
8	6632.0		8	6692.0		8	6752.0	
9	7461.0		9	7528.5		9	7596.0	
10	8290.0		10	8365.0		10	8440.0	

16-QAM:

Spurious Emission Level (dBm)								
Harmonic	Lowest channel Freq. (MHz)	Level [dBm]	Harmonic	Middle channel Freq. (MHz)	Level [dBm]	Harmonic	Highest channel Freq. (MHz)	Level [dBm]
2	1658.0	All detected emissions are more than 20dB below the limit!	2	1673.0	All detected emissions are more than 20dB below the limit!	2	1688.0	All detected emissions are more than 20dB below the limit!
3	2487.0		3	2509.5		3	2532.0	
4	3316.0		4	3346.0		4	3376.0	
5	4145.0		5	4182.5		5	4220.0	
6	4974.0		6	5019.0		6	5064.0	
7	5803.0		7	5855.5		7	5908.0	
8	6632.0		8	6692.0		8	6752.0	
9	7461.0		9	7528.5		9	7596.0	
10	8290.0		10	8365.0		10	8440.0	

Results: QPSK with 10 MHz channel bandwidth

Plot 1: Channel 20525 (Traffic mode up to 30 MHz)

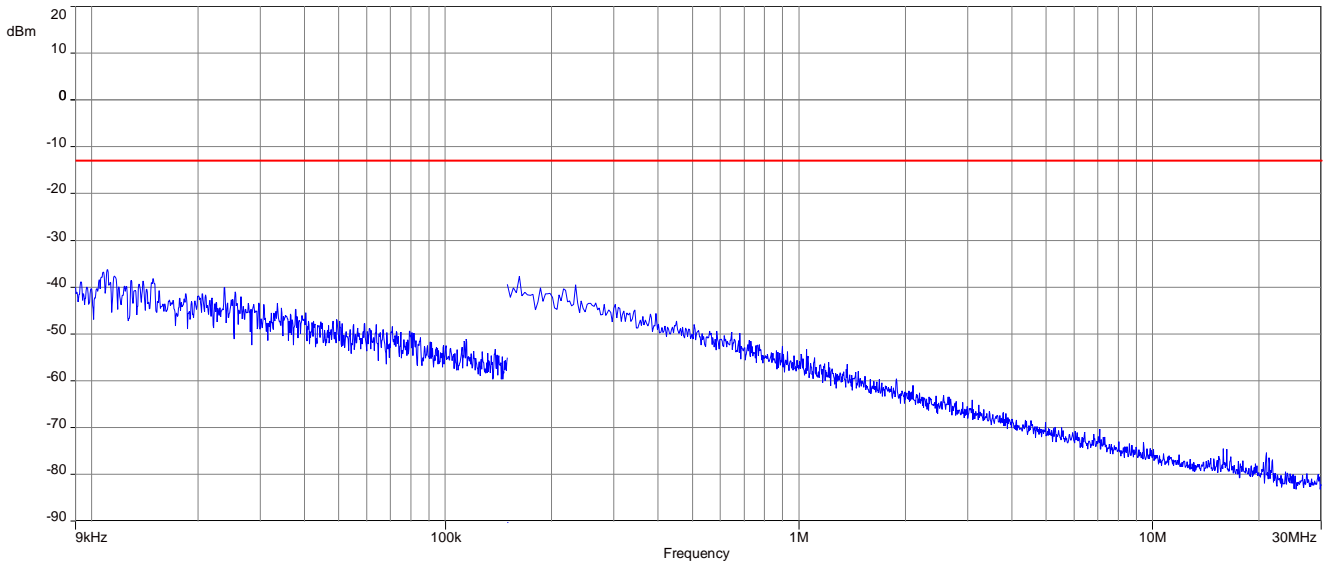

Plot 2: Channel 20525 (30 MHz – 1 GHz)

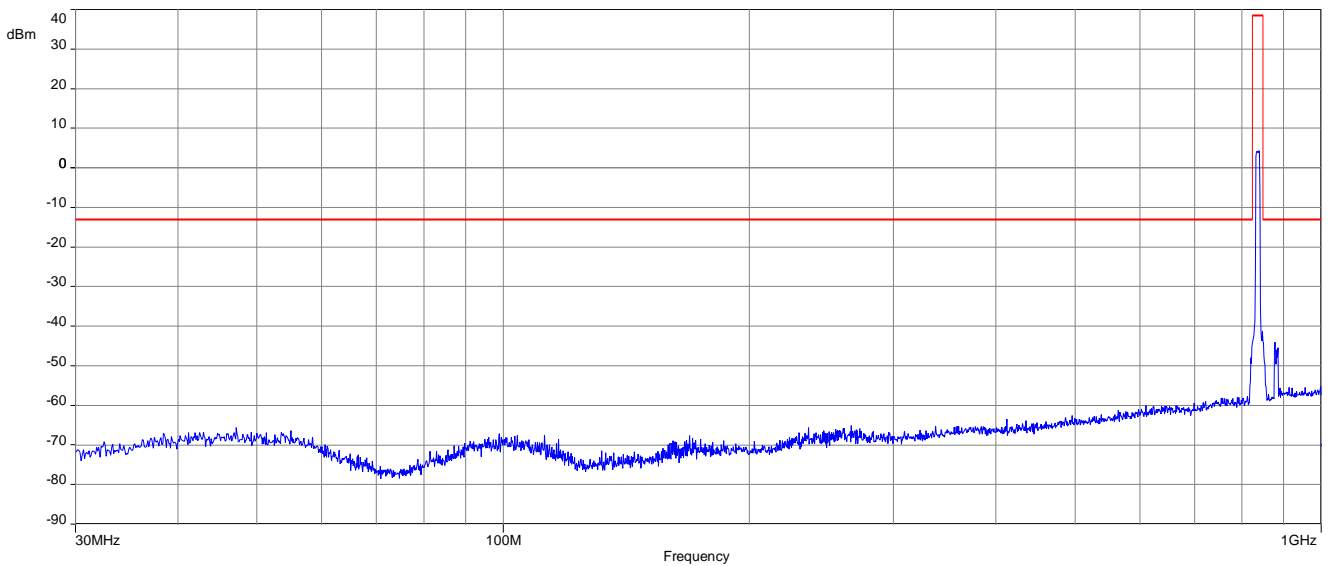

Plot 3: Channel 20525 (1 GHz – 9 GHz)

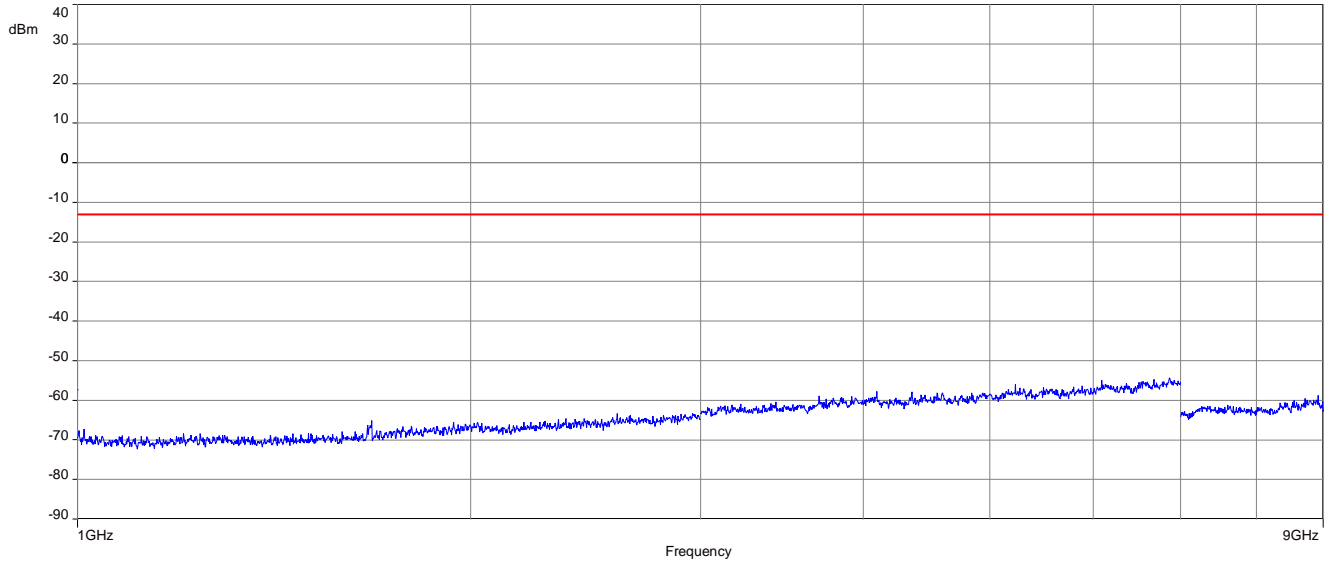

Results: 16-QAM with 10 MHz channel bandwidth

Plot 1: Channel 20525 (Traffic mode up to 30 MHz)

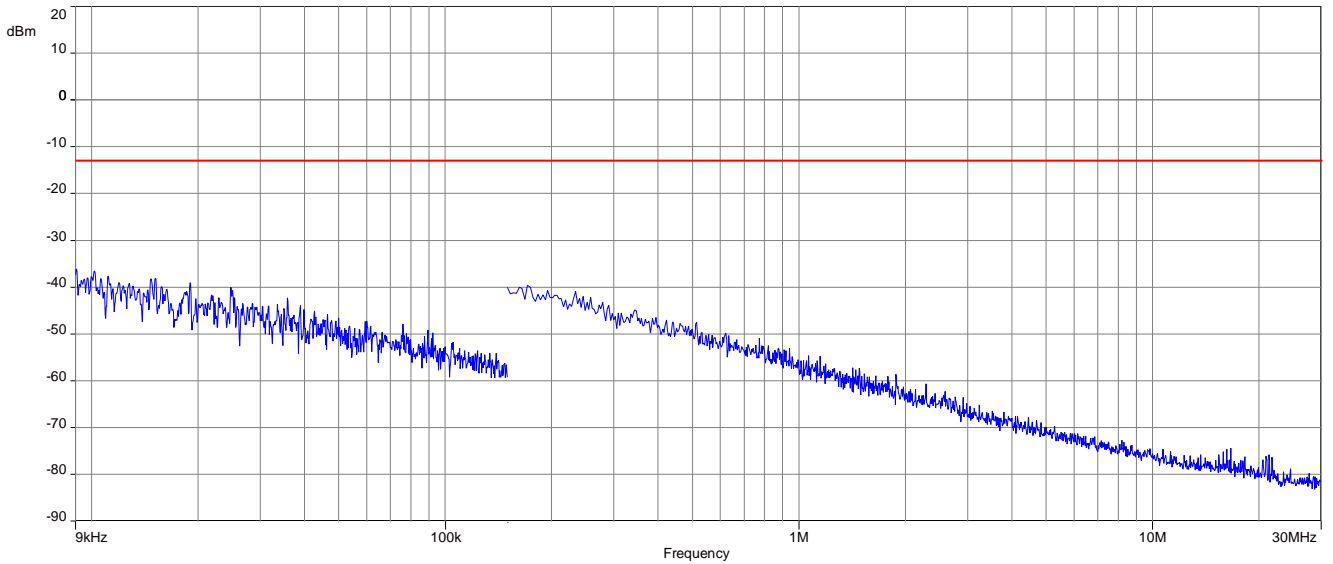

Plot 2: Channel 20525 (30 MHz – 1 GHz)

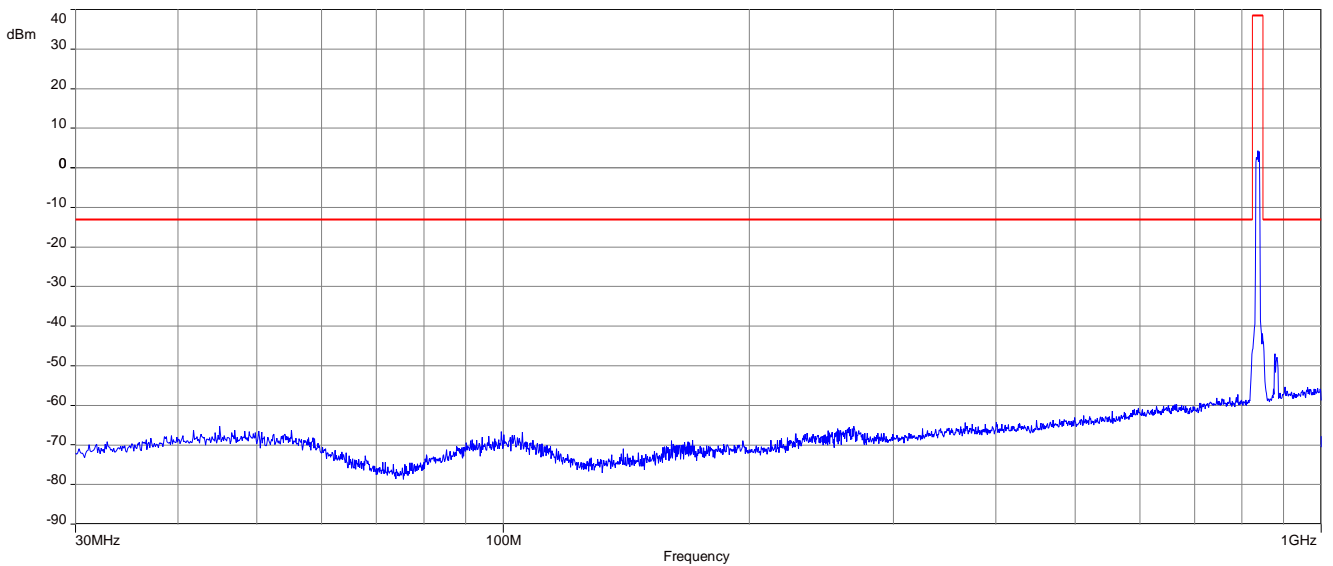

Plot 3: Channel 20525 (1 GHz – 9 GHz)

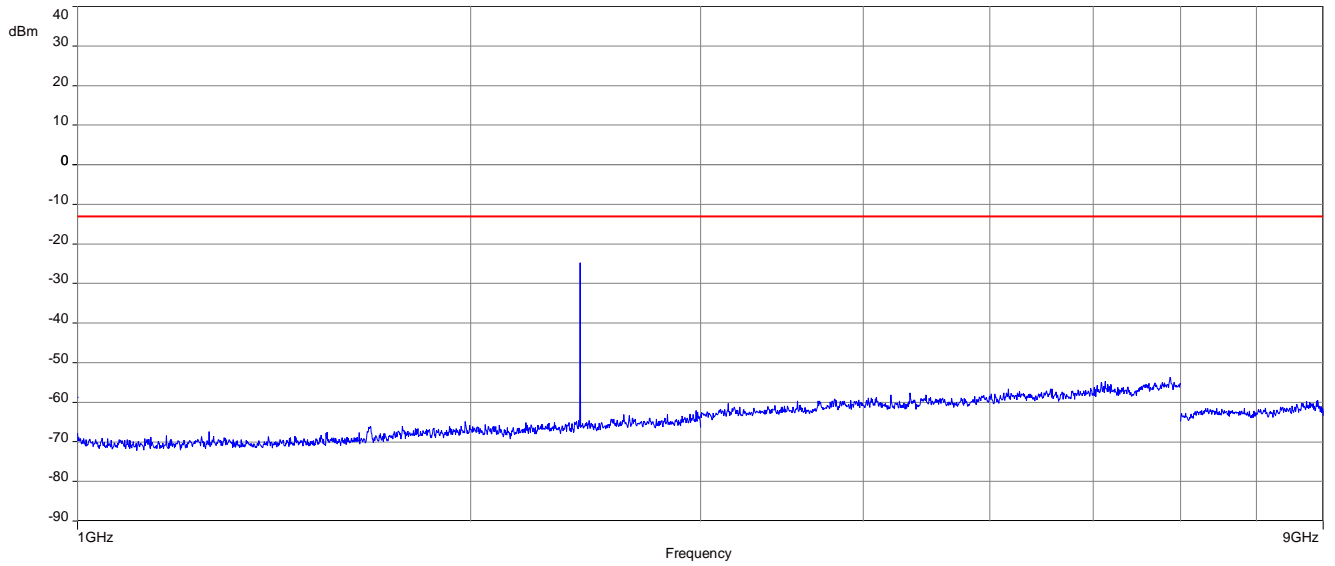

The detected emissions @ 2.4 GHz are the advertiser channels from the BT LE radio part of the device.

20 Summary of measurement results LTE band 4

<input type="checkbox"/>	No deviations from the technical specifications were ascertained
<input type="checkbox"/>	There were deviations from the technical specifications ascertained
<input checked="" type="checkbox"/>	This test report is only a partial test report. The content and verdict of the performed test cases are listed below.

TC identifier	Description	verdict	date	Remark
RF-Testing	CFR Part 27 RSS-130, RSS 139, RSS-199	See table!	2021-06-08	Delta tests according to manufacturer demand!

20.1 LTE – Band 4

Test Case	temperature conditions	power source voltages	C	NC	NA	NP	Remark
RF Output Power	Nominal	Nominal	<input checked="" type="checkbox"/>	<input type="checkbox"/>	<input type="checkbox"/>	<input type="checkbox"/>	-/-
Frequency Stability	Extreme	Extreme	<input type="checkbox"/>	<input type="checkbox"/>	<input type="checkbox"/>	<input checked="" type="checkbox"/>	-/-
Spurious Emissions Radiated	Nominal	Nominal	<input checked="" type="checkbox"/>	<input type="checkbox"/>	<input type="checkbox"/>	<input type="checkbox"/>	-/-
Spurious Emissions Conducted	Nominal	Nominal	<input type="checkbox"/>	<input type="checkbox"/>	<input type="checkbox"/>	<input checked="" type="checkbox"/>	-/-
Block Edge Compliance	Nominal	Nominal	<input type="checkbox"/>	<input type="checkbox"/>	<input type="checkbox"/>	<input checked="" type="checkbox"/>	-/-
Occupied Bandwidth	Nominal	Nominal	<input type="checkbox"/>	<input type="checkbox"/>	<input type="checkbox"/>	<input checked="" type="checkbox"/>	-/-

Notes:

C	Compliant	NC	Not compliant	NA	Not applicable	NP	Not performed
----------	-----------	-----------	---------------	-----------	----------------	-----------	---------------

21 RF measurements LTE band 4

21.1 Description of test setup

For the spurious measurements we use the substitution method according TIA/EIA 603.

21.2 Results LTE

The EUT was set to transmit the maximum power.

21.2.1 RF output power

Description:

This paragraph contains average power, peak output power and EIRP measurements for the mobile station. In all cases, the peak output power is within the required mask (this mask is specified in the JTC standards, TIA PN3389 Vol. 1 Chap 7, and is no FCC requirement).

Measurement:

The mobile was set up for the maximum output power with pseudo random data modulation.

To determine the Peak-To-Average Power Ratio (PAPR) the measurement was performed with the Power Complementary Cumulative Distribution Function (CCDF).

Measurement parameters	
Detector	Measured with CMW500
Sweep time	
Video bandwidth	
Resolution bandwidth	
Span	
Trace mode	
Setup	See chapter 7.2 - setup B, 7.4 – setup B
Measurement uncertainty	See chapter 9

Limits:

FCC	ISED
Average E.I.R.P. Output Power	
+30.00 dBm	
In measuring transmissions in this band using an average power technique, the peak-to-average ratio (PAR) of the transmission may not exceed 13 dB.	

Results:

Output Power (conducted)						
Bandwidth (MHz)	Frequency (MHz)	Resource block allocation	Average Output Power (dBm) QPSK	Peak to Average Ratio (dB)	Average Output Power (dBm) 16-QAM	Peak to Average Ratio (dB)
1.4	1710.7	1 RB low	17.3	5.1	16.5	5.8
		1 RB high	17.3	5.1	16.5	5.9
		50% RB mid	17.3	4.9	16.4	5.8
		100% RB	16.3	5.5	15.4	6.3
	1732.5	1 RB low	17.7	4.6	16.9	5.4
		1 RB high	17.9	4.7	17.1	5.4
		50% RB mid	17.8	4.7	16.8	5.7
		100% RB	16.9	5.2	15.9	6.1
	1754.3	1 RB low	16.6	5.3	15.8	6.2
		1 RB high	16.8	5.3	15.9	6.1
		50% RB mid	16.6	5.5	15.7	6.3
		100% RB	15.8	5.7	14.7	6.4
3	1711.5	1 RB low	17.2	5.1	16.4	6.0
		1 RB high	17.1	5.2	16.3	5.9
		50% RB mid	16.3	5.6	15.4	6.2
		100% RB	16.2	5.5	15.3	6.2
	1732.5	1 RB low	17.7	4.7	16.9	5.4
		1 RB high	17.9	4.7	17.0	5.5
		50% RB mid	16.9	5.2	15.8	6.1
		100% RB	16.9	5.3	15.9	6.2
	1753.5	1 RB low	16.4	5.4	15.7	6.2
		1 RB high	16.8	5.3	16.0	6.2
		50% RB mid	15.7	5.6	14.6	6.3
		100% RB	15.7	5.6	14.5	6.5
5	1712.5	1 RB low	17.3	5.0	16.6	5.9
		1 RB high	17.3	5.0	16.6	5.8
		50% RB mid	16.2	5.4	15.3	6.2
		100% RB	16.3	5.5	15.2	6.2
	1732.5	1 RB low	17.8	4.7	17.0	5.6
		1 RB high	17.9	4.7	17.1	5.5
		50% RB mid	16.9	5.2	15.9	6.0
		100% RB	16.9	5.2	15.9	6.1
	1752.5	1 RB low	16.4	5.4	15.6	6.2
		1 RB high	16.7	5.4	16.0	6.3
		50% RB mid	15.6	5.6	14.5	6.3
		100% RB	15.7	5.6	14.5	6.2

10	1715.0	1 RB low	17.2	5.1	16.4	5.9
		1 RB high	17.1	5.1	16.3	6.0
		50% RB mid	16.2	5.5	15.3	6.3
		100% RB	16.2	5.5	15.2	6.3
	1732.5	1 RB low	17.5	4.8	16.7	5.6
		1 RB high	17.6	4.7	16.8	5.4
		50% RB mid	16.9	5.3	15.9	6.1
		100% RB	16.8	5.3	15.8	6.1
	1750.0	1 RB low	16.6	5.2	15.8	6.1
		1 RB high	16.5	5.4	15.7	6.3
		50% RB mid	15.5	5.7	14.6	6.5
		100% RB	15.5	5.8	14.6	6.4
15	1717.5	1 RB low	17.0	5.1	16.2	6.0
		1 RB high	17.0	5.0	16.2	5.8
		50% RB mid	16.3	5.5	15.3	6.3
		100% RB	16.2	5.7	15.1	6.3
	1732.5	1 RB low	17.2	4.8	16.4	5.7
		1 RB high	17.1	4.7	16.2	5.6
		50% RB mid	17.0	5.2	16.0	6.1
		100% RB	16.8	5.4	15.7	6.1
	1747.5	1 RB low	17.1	4.9	16.2	5.7
		1 RB high	16.4	5.4	15.6	6.3
		50% RB mid	15.7	5.6	14.8	6.4
		100% RB	15.7	5.9	14.7	6.4
20	1720.0	1 RB low	16.9	4.9	16.1	5.9
		1 RB high	17.4	4.5	16.7	5.4
		50% RB mid	16.3	5.5	15.3	6.3
		100% RB	16.3	5.4	15.2	6.2
	1732.5	1 RB low	17.0	4.7	16.2	5.6
		1 RB high	17.0	4.7	16.2	5.5
		50% RB mid	16.9	5.2	15.9	6.0
		100% RB	16.6	5.3	15.6	6.1
	1745.0	1 RB low	17.4	4.4	16.7	5.2
		1 RB high	16.3	5.3	15.6	6.2
		50% RB mid	16.0	5.5	15.0	6.2
		100% RB	15.9	5.5	15.0	6.2

The radiated output power is measured in the mode with the highest conducted output power.

Output Power (radiated)			
Bandwidth (MHz)	Frequency (MHz)	Average Output Power (dBm)	Average Output Power (dBm)
		QPSK	16-QAM
1.4	1710.7	15.3	14.5
	1732.5	16.9	16.1
	1754.3	15.4	14.5
3	1711.5	15.2	14.4
	1732.5	16.9	16.0
	1753.5	15.4	14.6
5	1712.5	15.3	14.6
	1732.5	16.9	16.1
	1752.5	15.3	14.6
10	1715.0	15.2	14.4
	1732.5	16.6	15.8
	1750.0	15.2	14.4
15	1717.5	15.0	14.2
	1732.5	16.2	15.4
	1747.5	15.7	14.8
20	1720.0	15.4	14.7
	1732.5	16.0	15.2
	1745.0	16.0	15.3

21.2.2 Spurious emissions radiated

Description:

The following steps outline the procedure used to measure the radiated emissions from the mobile station. The site is constructed in accordance with ANSI C63.4:2014 requirements and is recognized by the FCC to be in compliance for a 3 and a 10 meter site. The spectrum was scanned from 30 MHz to the 10th harmonic of the highest frequency generated within the equipment, which is the transmitted carrier that can be as high as 1755 MHz. Measurement made up to 26 GHz. The resolution bandwidth is set as outlined in Part 27.53. The spectrum was scanned with the mobile station transmitting at carrier frequencies that pertain to low, mid and high channels of the LTE band 4.

Measurement:

Measurement parameters	
Detector	Peak
Sweep time	2 sec.
Video bandwidth	Below 1 GHz: 100 kHz Above 1 GHz: 1 MHz
Resolution bandwidth	Below 1 GHz: 100 kHz Above 1 GHz: 1 MHz
Span	100 MHz Steps
Trace mode	Max Hold
Setup	See chapter 7.1 - setup B; 7.2 - setup A/B; 7.3 - setup A
Measurement uncertainty	See chapter 9

Limits:

FCC	ISED
Spurious Emissions Radiated	
Attenuation $\geq 43 + 10\log(P)$ / (P, Power in Watts)	
-13 dBm	

QPSK

Spurious Emission Level (dBm)					
Lowest channel		Middle channel		Highest channel	
Spurious emissions	Level [dBm]	Spurious emissions	Level [dBm]	Spurious emissions	Level [dBm]
All detected emissions are more than 20dB below the limit!					
	-		-		-
	-		-		-
	-		-		-
	-		-		-
	-		-		-
	-		-		-
	-		-		-

16-QAM

Spurious Emission Level (dBm)					
Lowest channel		Middle channel		Highest channel	
Spurious emissions	Level [dBm]	Spurious emissions	Level [dBm]	Spurious emissions	Level [dBm]
All detected emissions are more than 20dB below the limit!					
	-		-		-
	-		-		-
	-		-		-
	-		-		-
	-		-		-
	-		-		-
	-		-		-

Results: QPSK with 10 MHz channel bandwidth

Plot 1: Middle channel, up to 30 MHz

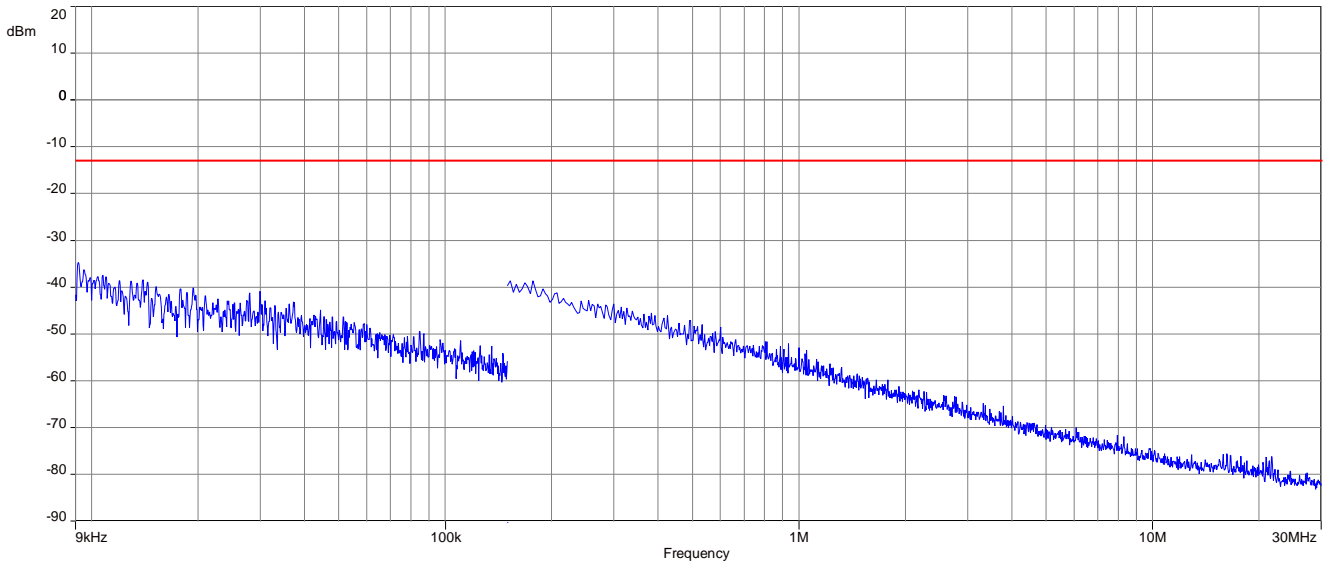

Plot 2: Middle channel, 30 MHz to 1 GHz

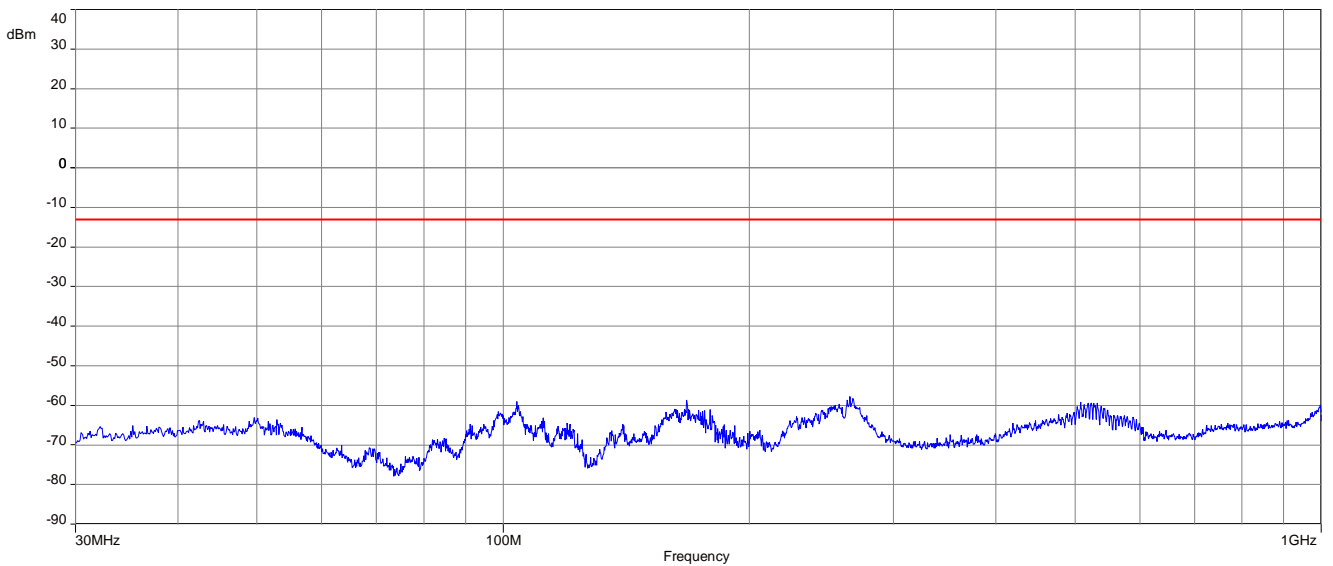

Plot 3: Middle channel, 1 GHz to 18 GHz

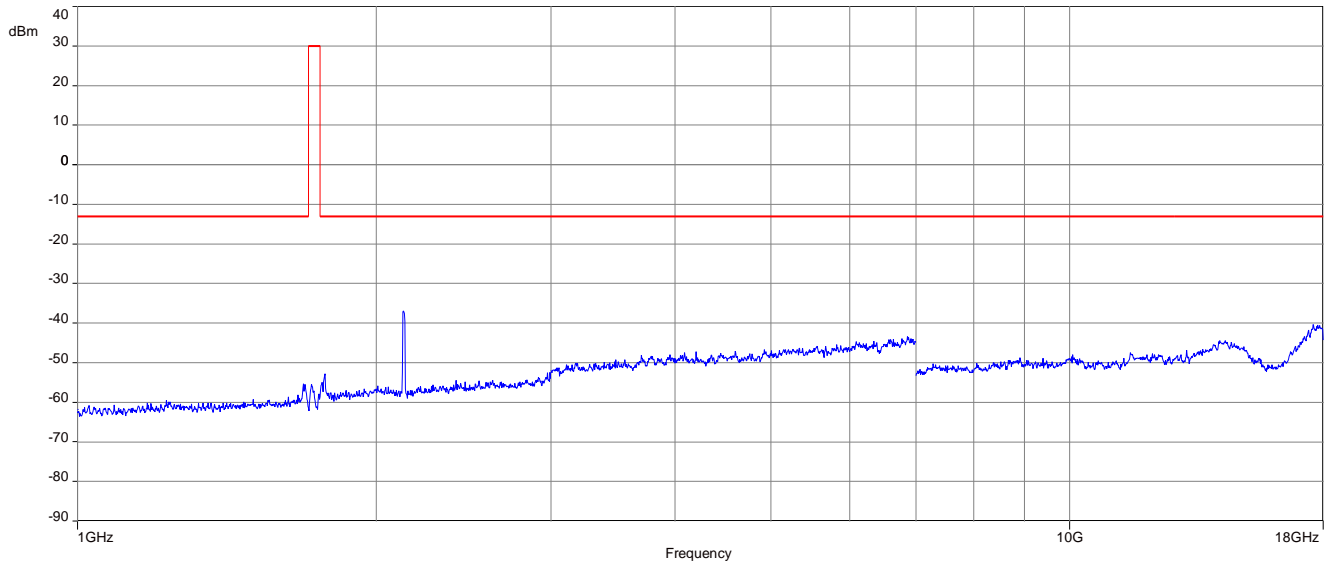

Carrier notched with 1.7 GHz rejection filter, the shown peak around 2.1 GHz is caused by the downlink signal.

Results: 16-QAM with 10 MHz channel bandwidth

Plot 1: Middle channel, up to 30 MHz

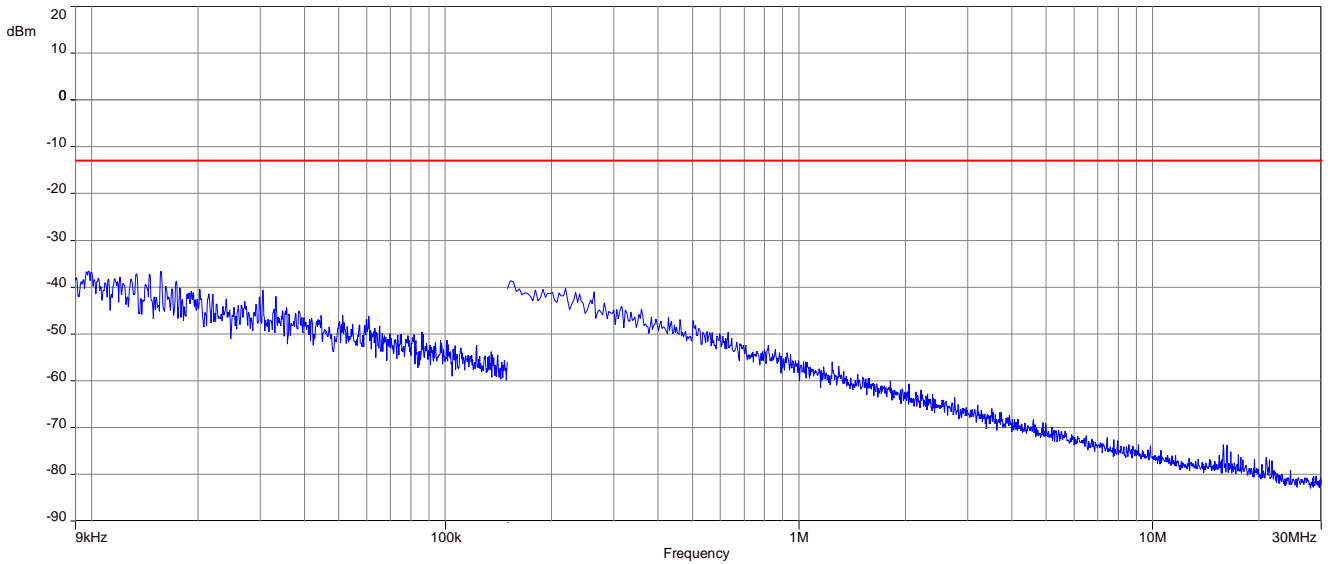

Plot 2: Middle channel, 30 MHz to 1 GHz

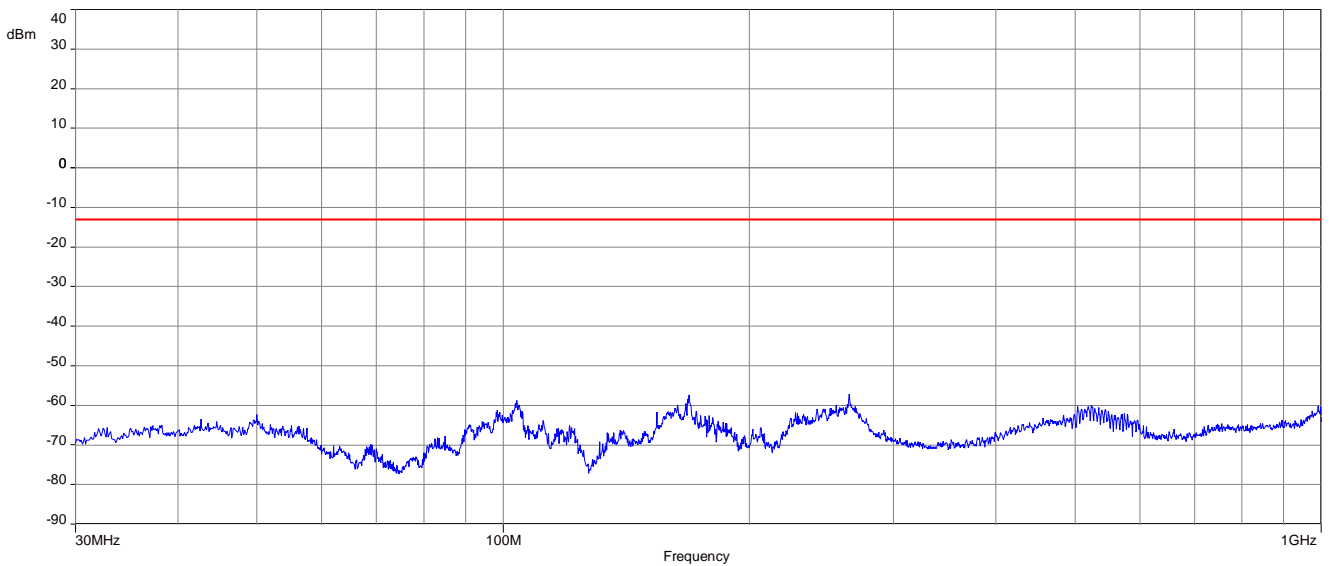

Plot 3: Middle channel, 1 GHz to 18 GHz

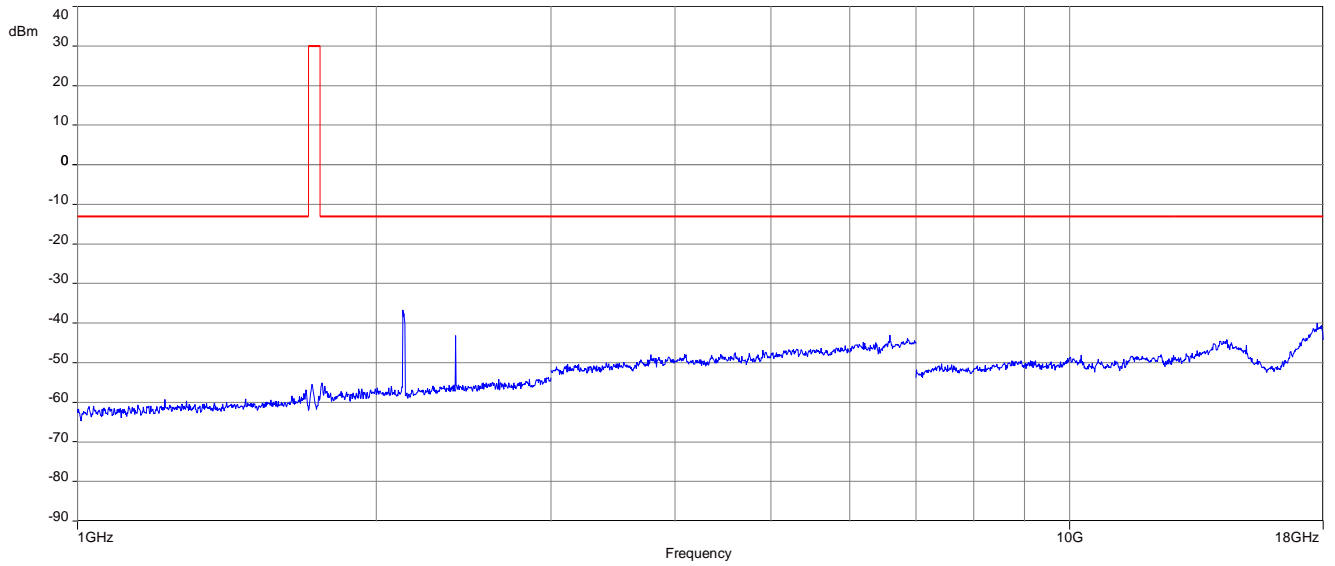

Carrier notched with 1.7 GHz rejection filter, the shown peak around 2.1 GHz is caused by the downlink signal. The detected emissions @ 2.4 GHz are the advertiser channels from the BT LE radio part of the device.

22 Summary of measurement results LTE band 7

<input type="checkbox"/>	No deviations from the technical specifications were ascertained
<input type="checkbox"/>	There were deviations from the technical specifications ascertained
<input checked="" type="checkbox"/>	This test report is only a partial test report. The content and verdict of the performed test cases are listed below.

TC identifier	Description	verdict	date	Remark
RF-Testing	CFR Part 27 RSS-199	See table!	2021-06-08	Delta tests according to manufacturer demand!

22.1 LTE – Band 7

Test Case	temperature conditions	power source voltages	C	NC	NA	NP	Remark
RF Output Power	Nominal	Nominal	<input checked="" type="checkbox"/>	<input type="checkbox"/>	<input type="checkbox"/>	<input type="checkbox"/>	-/-
Frequency Stability	Extreme	Extreme	<input type="checkbox"/>	<input type="checkbox"/>	<input type="checkbox"/>	<input checked="" type="checkbox"/>	-/-
Spurious Emissions Radiated	Nominal	Nominal	<input checked="" type="checkbox"/>	<input type="checkbox"/>	<input type="checkbox"/>	<input type="checkbox"/>	-/-
Spurious Emissions Conducted	Nominal	Nominal	<input type="checkbox"/>	<input type="checkbox"/>	<input type="checkbox"/>	<input checked="" type="checkbox"/>	-/-
Block Edge Compliance	Nominal	Nominal	<input type="checkbox"/>	<input type="checkbox"/>	<input type="checkbox"/>	<input checked="" type="checkbox"/>	-/-
Occupied Bandwidth	Nominal	Nominal	<input type="checkbox"/>	<input type="checkbox"/>	<input type="checkbox"/>	<input checked="" type="checkbox"/>	-/-

Notes:

C	Compliant	NC	Not compliant	NA	Not applicable	NP	Not performed
----------	-----------	-----------	---------------	-----------	----------------	-----------	---------------

23 RF measurements LTE band 7

23.1 Description of test setup

For the spurious measurements we use the substitution method according TIA/EIA 603.

23.2 Results LTE – Band 7

The EUT was set to transmit the maximum power.

23.2.1 RF output power

Description:

This paragraph contains average power, peak output power and EIRP measurements for the mobile station. In all cases, the peak output power is within the required mask (this mask is specified in the JTC standards, TIA PN3389 Vol. 1 Chap 7, and is no FCC requirement).

Measurement:

The mobile was set up for the maximum output power with pseudo random data modulation.

To determine the Peak-To-Average Power Ratio (PAPR) the measurement was performed with the Power Complementary Cumulative Distribution Function (CCDF).

Measurement parameters	
Detector	Measured with CMW500
Sweep time	
Video bandwidth	
Resolution bandwidth	
Span	
Trace mode	
Setup	See chapter 7.2 - setup B, 7.4 – setup B
Measurement uncertainty	See chapter 9

Limits:

FCC	ISED
AVG: 33 dBm	Peak: 33 dBm
Max Output Power	
In measuring transmissions in this band using an average power technique, the peak-to-average ratio (PAR) of the transmission may not exceed 13 dB.	

Results:

Output Power (conducted)						
Bandwidth (MHz)	Frequency (MHz)	Resource block allocation	Average Output Power (dBm) QPSK	Peak to Average Ratio (dB)	Average Output Power (dBm) 16-QAM	Peak to Average Ratio (dB)
5	20775 / 2502.5	1 RB low	17.3	4.8	16.8	5.4
		1 RB high	17.5	5.0	16.9	5.7
		50% RB mid	16.8	5.2	15.7	5.9
		100% RB	16.7	5.3	15.8	5.9
	21100 / 2535.0	1 RB low	18.6	4.8	17.9	5.4
		1 RB high	18.8	4.7	18.2	5.3
		50% RB mid	17.9	5.1	16.8	5.7
		100% RB	17.9	5.1	16.9	5.8
	21425 / 2567.5	1 RB low	18.3	4.9	17.4	5.7
		1 RB high	18.4	4.8	17.8	5.6
		50% RB mid	17.5	5.4	16.7	5.9
		100% RB	17.5	5.4	16.7	5.9
10	20800 / 2505.0	1 RB low	17.3	5.1	16.4	5.8
		1 RB high	17.4	5.1	16.7	5.7
		50% RB mid	16.7	5.4	15.8	6.0
		100% RB	16.7	5.3	15.7	6.0
	21100 / 2535.0	1 RB low	18.4	4.7	17.7	5.2
		1 RB high	18.6	4.6	17.8	5.3
		50% RB mid	17.9	5.2	16.9	5.7
		100% RB	17.9	5.1	16.9	5.8
	21400 / 2565.0	1 RB low	17.8	5.0	17.2	5.6
		1 RB high	18.1	4.9	17.4	5.7
		50% RB mid	17.3	5.4	16.5	6.0
		100% RB	17.3	5.5	16.4	6.0
15	20825 / 2507.5	1 RB low	17.2	5.0	16.3	5.7
		1 RB high	17.4	5.1	16.7	5.7
		50% RB mid	16.7	5.3	15.7	5.9
		100% RB	16.6	5.6	15.7	6.0
	21100 / 2535.0	1 RB low	18.3	4.5	17.5	5.3
		1 RB high	18.5	4.5	17.7	5.4
		50% RB mid	17.9	5.1	16.9	5.7
		100% RB	17.8	5.2	16.8	5.7
	21375 / 2562.5	1 RB low	17.8	4.9	17.2	5.5
		1 RB high	17.7	5.0	17.1	5.6
		50% RB mid	17.1	5.5	16.3	6.1
		100% RB	17.1	5.7	16.3	6.1

20	20850 / 2510.0	1 RB low	17.0	4.9	16.4	5.8
		1 RB high	17.7	4.9	16.8	5.9
		50% RB mid	16.8	5.4	15.8	6.0
		100% RB	16.7	5.3	15.7	5.9
	21100 / 2535.0	1 RB low	18.2	4.4	17.4	5.2
		1 RB high	18.3	4.5	17.6	5.2
		50% RB mid	17.9	5.2	17.0	5.9
		100% RB	17.7	5.2	16.8	5.8
	21350 / 2560.0	1 RB low	18.0	4.7	17.3	5.3
		1 RB high	17.7	4.6	17.0	5.5
		50% RB mid	17.1	5.5	16.3	6.1
		100% RB	17.1	5.4	16.2	6.0

The radiated output power is measured in the mode with the highest conducted output power.

Output Power (radiated)			
Bandwidth (MHz)	Frequency (MHz)	Average Output Power (dBm)	
		QPSK	16-QAM
5	2502.5	23.3	22.7
	2535.0	23.6	23.0
	2567.5	24.0	23.4
10	2505.0	23.2	22.5
	2535.0	23.5	22.7
	2565.0	23.8	23.0
15	2507.5	23.2	22.5
	2535.0	23.5	22.7
	2562.5	23.7	22.9
20	2510.0	23.5	22.6
	2535.0	23.4	22.8
	2560.0	23.6	22.9

23.2.2 Spurious emissions radiated

Description:

The following steps outline the procedure used to measure the radiated emissions from the mobile station. The site is constructed in accordance with ANSI C63.4:2014 requirements and is recognized by the FCC to be in compliance for a 3 and a 10 meter site. The spectrum was scanned from 30 MHz to the 10th harmonic of the highest frequency generated within the equipment, which is the transmitted carrier that can be as high as 2569.3 MHz. This was rounded up to 26 GHz. The resolution bandwidth is set as outlined in Part 27.53. The spectrum was scanned with the mobile station transmitting at carrier frequencies that pertain to low, mid and high channels of the LTE band 7.

Measurement:

Measurement parameters	
Detector	Peak
Sweep time	2 sec.
Video bandwidth	Below 1 GHz: 100 kHz Above 1 GHz: 1 MHz
Resolution bandwidth	Below 1 GHz: 100 kHz Above 1 GHz: 1 MHz
Span	100 MHz Steps
Trace mode	Max Hold
Setup	See chapter 7.1 - setup B; 7.2 - setup A/B; 7.3 - setup A
Measurement uncertainty	See chapter 9

Limits:

FCC	ISED
Spurious Emissions Radiated	
Attenuation $\geq 43 + 10\log(P)$ / (P, Power in Watts)	
-13 dBm	

QPSK

Spurious Emission Level (dBm)					
Lowest channel		Middle channel		Highest channel	
Spurious emissions	Level [dBm]	Spurious emissions	Level [dBm]	Spurious emissions	Level [dBm]
All detected emissions are more than 20dB below the limit!					
	-		-		-
	-		-		-
	-		-		-
	-		-		-
	-		-		-
	-		-		-
	-		-		-

16-QAM

Spurious Emission Level (dBm)					
Lowest channel		Middle channel		Highest channel	
Spurious emissions	Level [dBm]	Spurious emissions	Level [dBm]	Spurious emissions	Level [dBm]
All detected emissions are more than 20dB below the limit!					
	-		-		-
	-		-		-
	-		-		-
	-		-		-
	-		-		-
	-		-		-
	-		-		-

Results: QPSK with 10 MHz channel bandwidth

Plot 1: Middle channel, up to 30 MHz

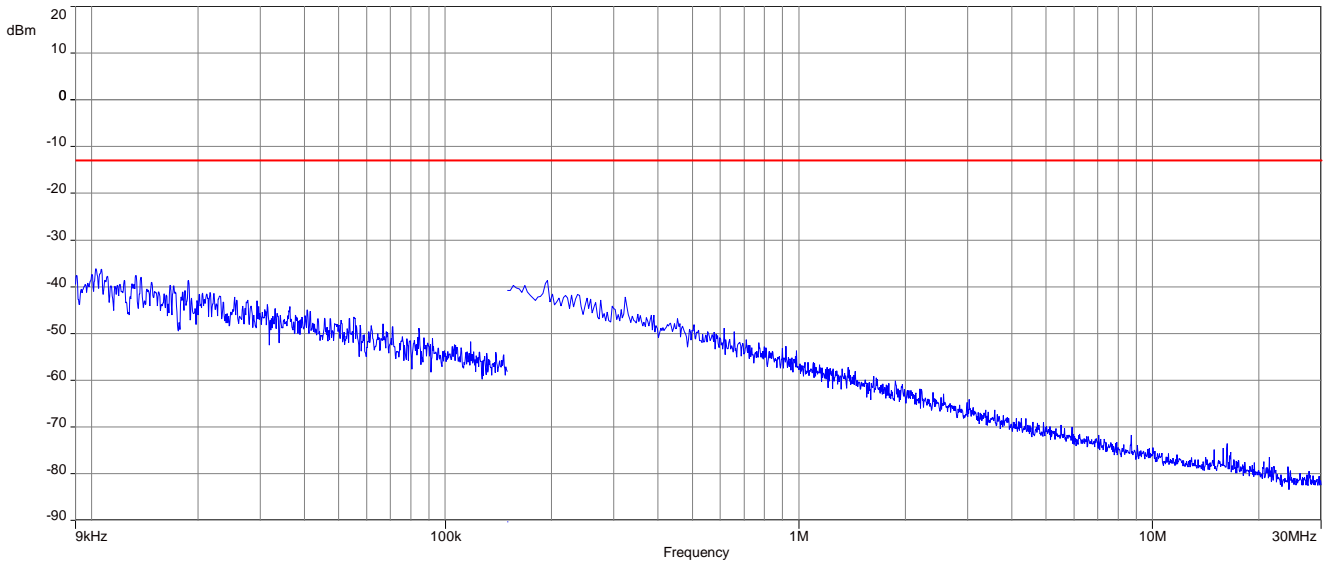

Plot 2: Middle channel, 30 MHz to 1 GHz

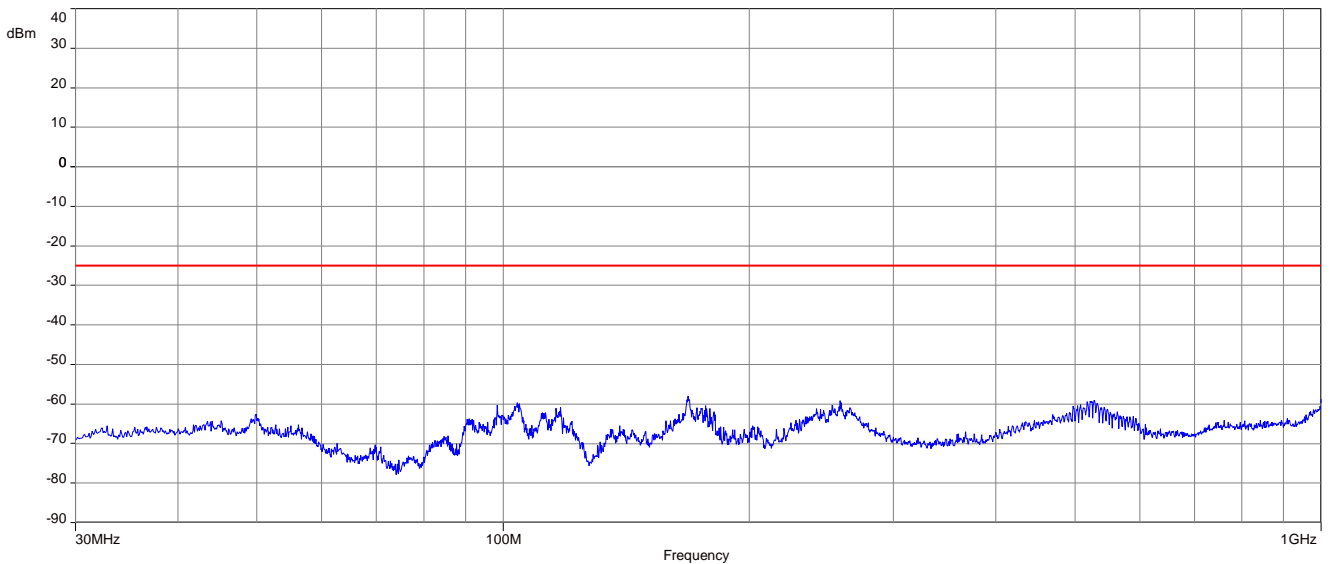

Plot 3: Middle channel, 1 GHz to 18 GHz

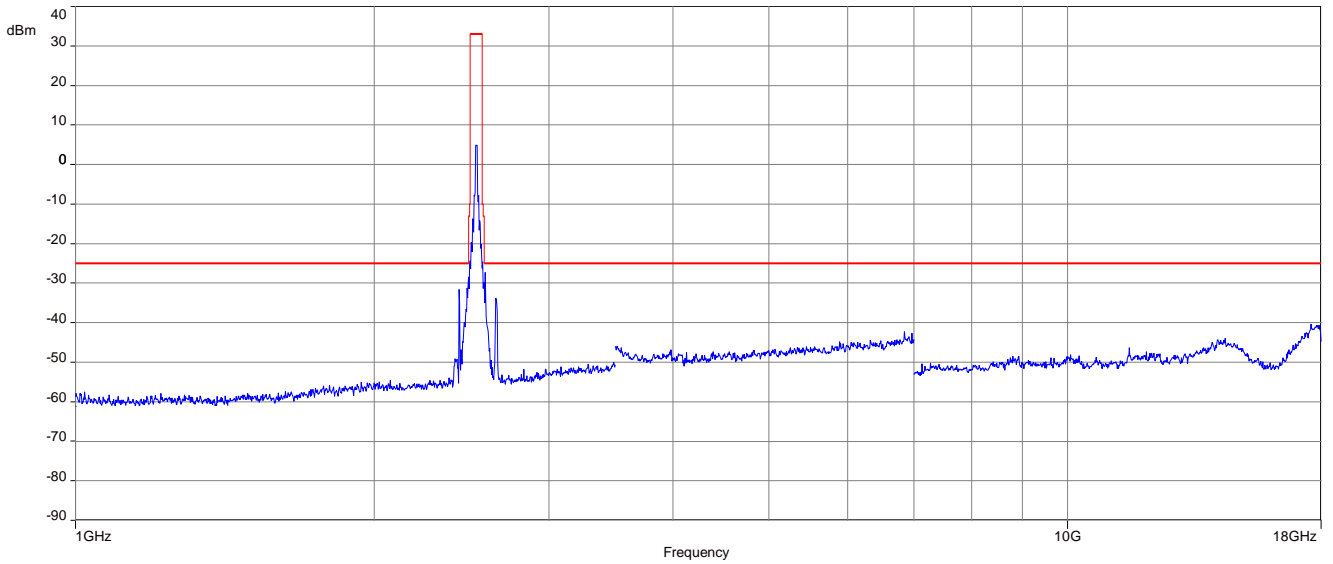

Plot 4: Middle channel, 18 GHz to 26 GHz

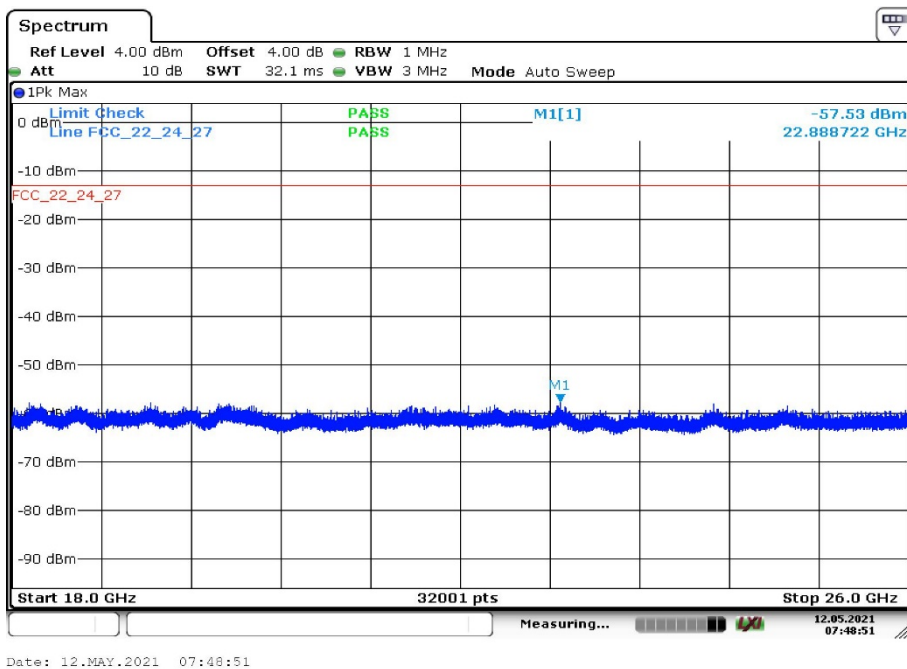

Results: 16-QAM with 10 MHz channel bandwidth

Plot 1: Middle channel, up to 30 MHz

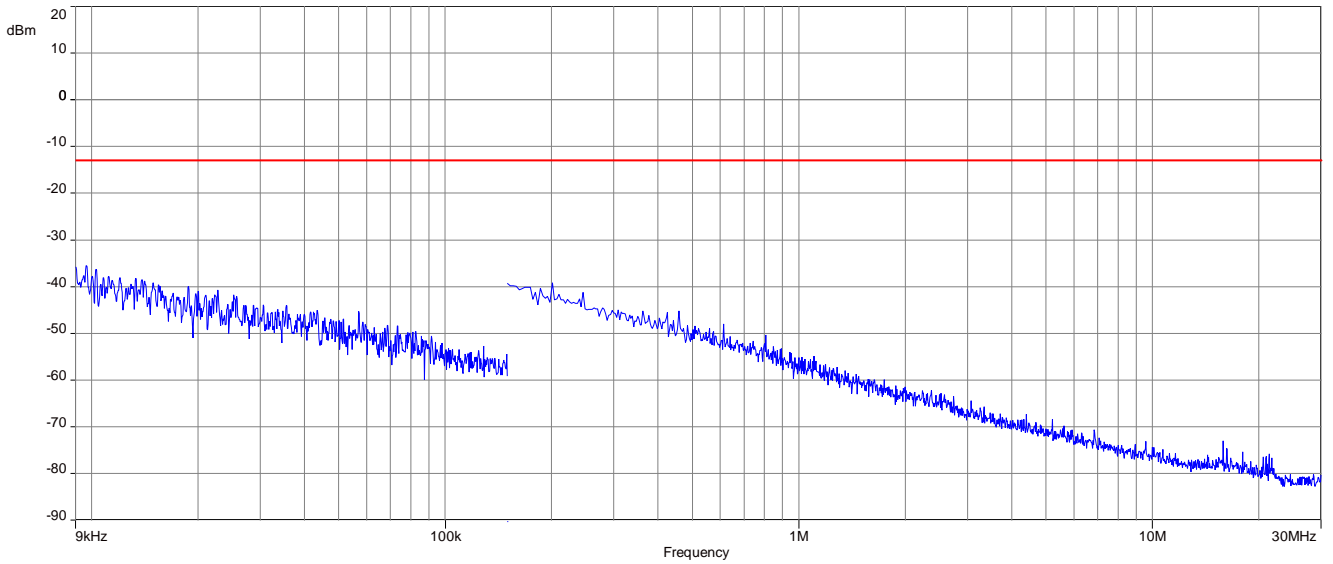

Plot 2: Middle channel, 30 MHz to 1 GHz

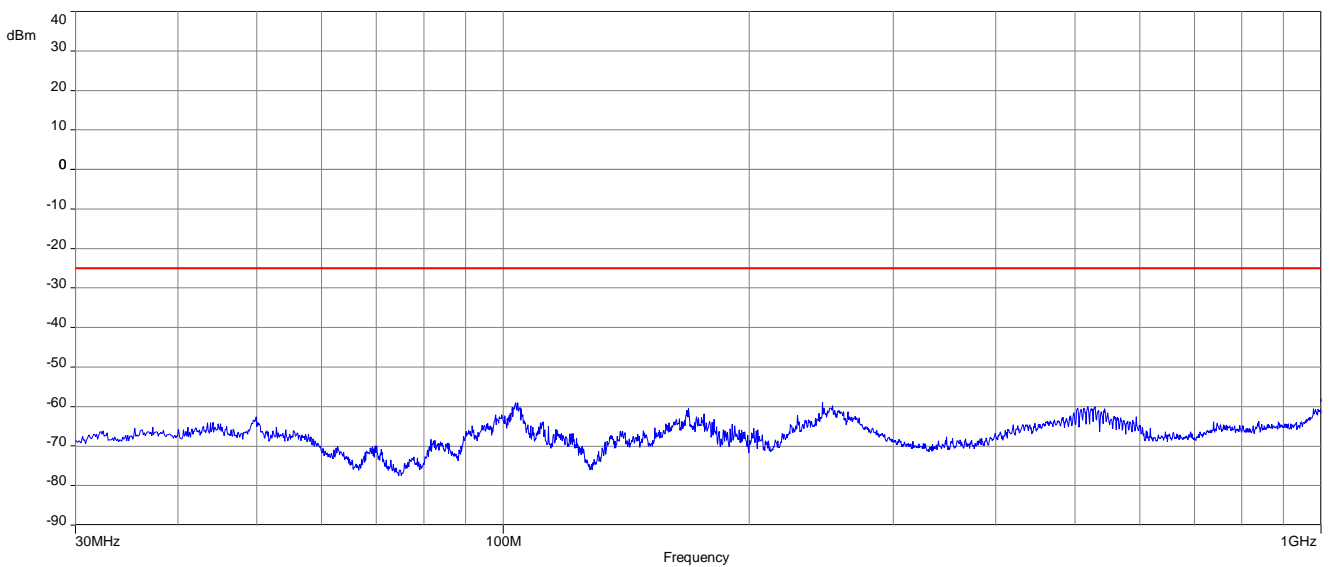

Plot 3: Middle channel, 1 GHz to 18 GHz

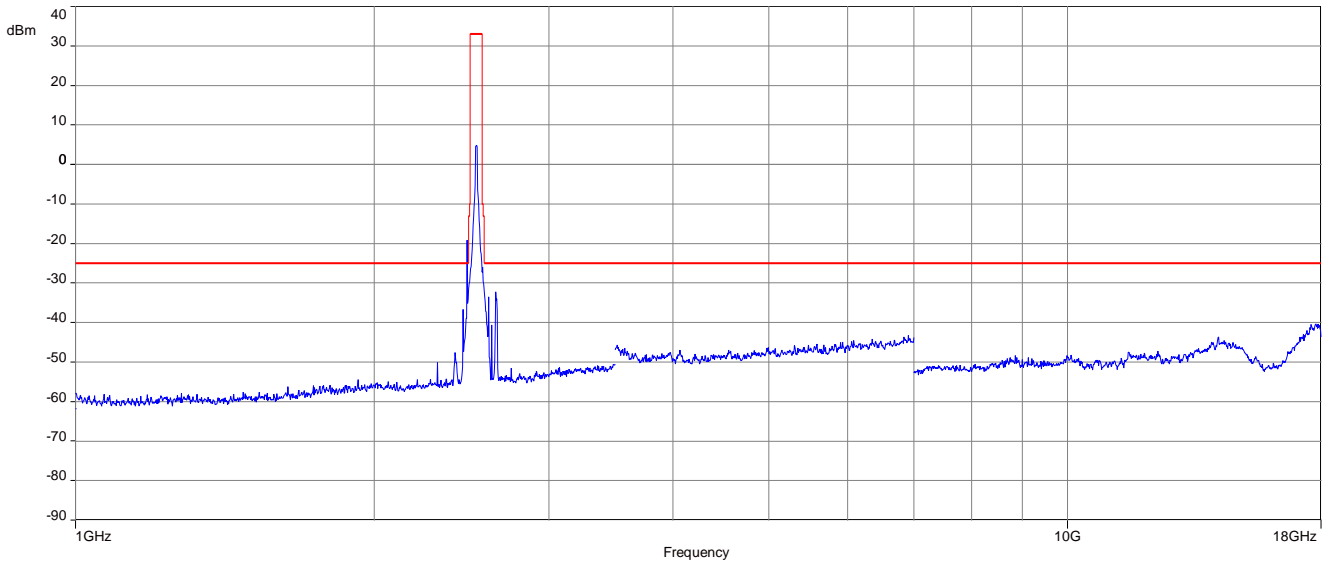

The emission at 2480 MHz is caused by the advertising BT LE.

Plot 4: Middle channel, 18 GHz to 26 GHz

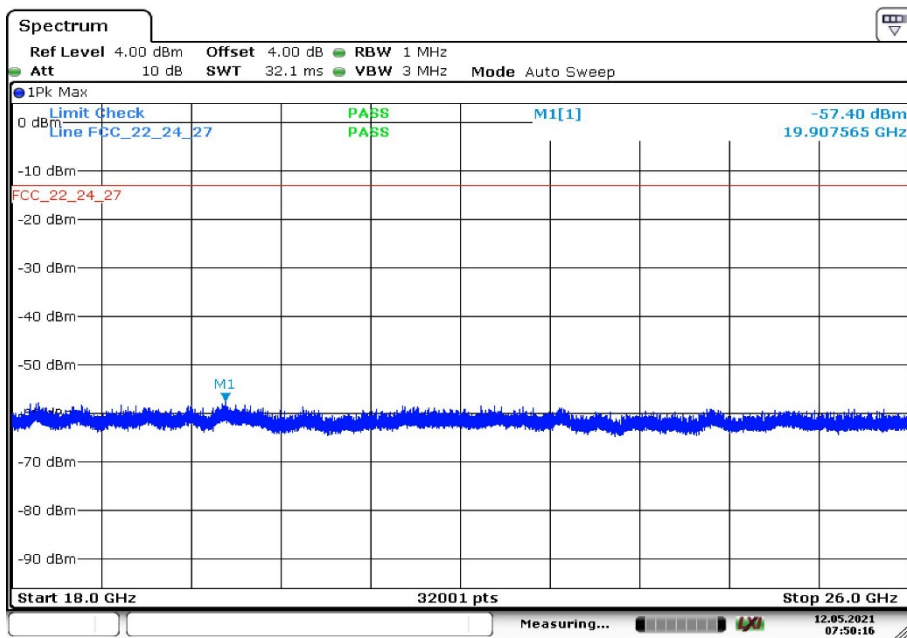

24 Summary of measurement results LTE band 17

<input type="checkbox"/>	No deviations from the technical specifications were ascertained
<input type="checkbox"/>	There were deviations from the technical specifications ascertained
<input checked="" type="checkbox"/>	This test report is only a partial test report. The content and verdict of the performed test cases are listed below.

TC identifier	Description	verdict	date	Remark
RF-Testing	CFR Part 27 RSS-130	See table!	2021-06-08	Delta tests according to manufacturer demand!

24.1 LTE – Band 17

Test Case	temperature conditions	power source voltages	C	NC	NA	NP	Remark
RF Output Power	Nominal	Nominal	<input checked="" type="checkbox"/>	<input type="checkbox"/>	<input type="checkbox"/>	<input type="checkbox"/>	-/-
Frequency Stability	Extreme	Extreme	<input type="checkbox"/>	<input type="checkbox"/>	<input type="checkbox"/>	<input checked="" type="checkbox"/>	-/-
Spurious Emissions Radiated	Nominal	Nominal	<input checked="" type="checkbox"/>	<input type="checkbox"/>	<input type="checkbox"/>	<input type="checkbox"/>	-/-
Spurious Emissions Conducted	Nominal	Nominal	<input type="checkbox"/>	<input type="checkbox"/>	<input type="checkbox"/>	<input checked="" type="checkbox"/>	-/-
Block Edge Compliance	Nominal	Nominal	<input type="checkbox"/>	<input type="checkbox"/>	<input type="checkbox"/>	<input checked="" type="checkbox"/>	-/-
Occupied Bandwidth	Nominal	Nominal	<input type="checkbox"/>	<input type="checkbox"/>	<input type="checkbox"/>	<input checked="" type="checkbox"/>	-/-

Notes:

C	Compliant	NC	Not compliant	NA	Not applicable	NP	Not performed
----------	-----------	-----------	---------------	-----------	----------------	-----------	---------------

25 RF measurements LTE 17

25.1 Description of test setup

For the spurious measurements we use the substitution method according TIA/EIA 603.

25.2 Results LTE – Band 17

The EUT was set to transmit the maximum power.

25.2.1 RF output power

Description:

This paragraph contains average power, peak output power and EIRP measurements for the mobile station. In all cases, the peak output power is within the required mask (this mask is specified in the JTC standards, TIA PN3389 Vol. 1 Chap 7, and is no FCC requirement).

Measurement:

The mobile was set up for the maximum output power with pseudo random data modulation.

To determine the Peak-To-Average Power Ratio (PAPR) the measurement was performed with the Power Complementary Cumulative Distribution Function (CCDF).

Measurement parameters	
Detector	Measured with CMW500
Sweep time	
Video bandwidth	
Resolution bandwidth	
Span	
Trace mode	
Setup	See chapter 7.1 - setup B, 7.4 – setup B
Measurement uncertainty	See chapter 9

Limits:

FCC	ISED
Average E.I.R.P. Output Power	
34.77 dBm (FCC) / +37.00 dBm (ISED)	
In measuring transmissions in this band using an average power technique, the peak-to-average ratio (PAR) of the transmission may not exceed 13 dB.	

Results:

Output Power (conducted)						
Bandwidth (MHz)	Frequency (MHz)	Resource block allocation	Average Output Power (dBm) QPSK	Peak to Average Ratio (dB)	Average Output Power (dBm) 16-QAM	Peak to Average Ratio (dB)
5	706.5	1 RB low	17.9	5.2	17.0	6.2
		1 RB high	18.3	4.8	17.5	5.7
		50% RB mid	17.0	5.4	16.0	6.3
		100% RB	17.0	5.5	16.0	6.3
	710.0	1 RB low	18.1	4.9	17.2	5.8
		1 RB high	17.6	5.8	16.7	6.8
		50% RB mid	17.1	5.6	16.1	6.3
		100% RB	17.1	5.5	16.0	6.4
	713.5	1 RB low	17.7	5.5	16.9	6.5
		1 RB high	17.8	5.3	17.0	6.1
		50% RB mid	16.4	5.9	15.5	6.7
		100% RB	16.5	5.9	15.4	6.6
10	709.0	1 RB low	17.7	5.5	16.7	6.5
		1 RB high	17.6	5.9	16.9	6.7
		50% RB mid	17.1	5.5	16.1	6.3
		100% RB	16.9	5.5	15.9	6.4
	710.0	1 RB low	17.8	5.2	16.8	6.0
		1 RB high	17.0	5.9	16.3	6.4
		50% RB mid	17.1	5.5	16.1	6.4
		100% RB	16.9	5.5	15.9	6.4
	711	1 RB low	18.0	4.9	17.1	5.9
		1 RB high	17.6	5.3	16.9	6.2
		50% RB mid	16.9	5.7	15.9	6.6
		100% RB	16.9	5.6	15.8	6.3

The radiated output power is measured in the mode with the highest conducted output power.

Output Power (radiated)			
Bandwidth (MHz)	Frequency (MHz)	Average Output Power (dBm)	Average Output Power (dBm)
		QPSK	16-QAM
5	706.5	15.3	14.5
	710.0	15.1	14.2
	713.5	14.9	14.0
10	709.0	15.3	14.5
	710.0	15.1	14.2
	711.0	15.2	14.3

25.2.2 Spurious emissions radiated

Description:

The following steps outline the procedure used to measure the radiated emissions from the mobile station. The site is constructed in accordance with ANSI C63.4:2014 requirements and is recognized by the FCC to be in compliance for a 3 and a 10 meter site. The spectrum was scanned from 30 MHz to the 10th harmonic of the highest frequency generated within the equipment, which is the transmitted carrier that can be as high as 746 MHz. Measurement is made up to 12.75 GHz. The resolution bandwidth is set as outlined in Part 27.53. The spectrum was scanned with the mobile station transmitting at carrier frequencies that pertain to low, mid and high channels of the LTE band 17.

Measurement:

Measurement parameters	
Detector	Peak
Sweep time	2 sec.
Video bandwidth	Below 1 GHz: 100 kHz Above 1 GHz: 1 MHz
Resolution bandwidth	Below 1 GHz: 100 kHz Above 1 GHz: 1 MHz
Span	100 MHz Steps
Trace mode	Max Hold
Setup	See chapter 7.1 - setup B; 7.2 - setup A/B; 7.3 – setup A
Measurement uncertainty	See chapter 9

Limits:

FCC	ISED
Spurious Emissions Radiated	
Attenuation $\geq 43 + 10\log(P)$ / (P, Power in Watts)	
-13 dBm	

QPSK

Spurious Emission Level (dBm)					
Lowest channel		Middle channel		Highest channel	
Spurious emissions	Level [dBm]	Spurious emissions	Level [dBm]	Spurious emissions	Level [dBm]
All detected emissions are more than 20dB below the limit!					
	-		-		-
	-		-		-
	-		-		-
	-		-		-
	-		-		-
	-		-		-
	-		-		-

16-QAM

Spurious Emission Level (dBm)					
Lowest channel		Middle channel		Highest channel	
Spurious emissions	Level [dBm]	Spurious emissions	Level [dBm]	Spurious emissions	Level [dBm]
All detected emissions are more than 20dB below the limit!					
	-		-		-
	-		-		-
	-		-		-
	-		-		-
	-		-		-
	-		-		-
	-		-		-

Results: QPSK with 10 MHz channel bandwidth

Plot 1: Middle channel, up to 30 MHz

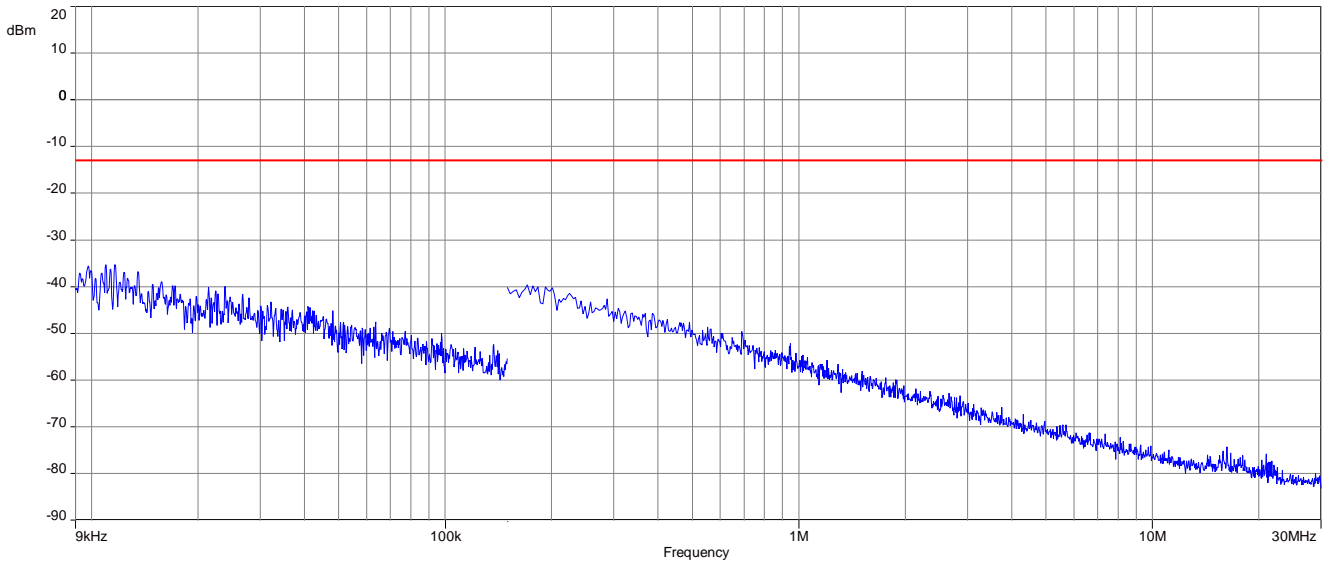

Plot 2: Middle channel, 30 MHz to 1 GHz

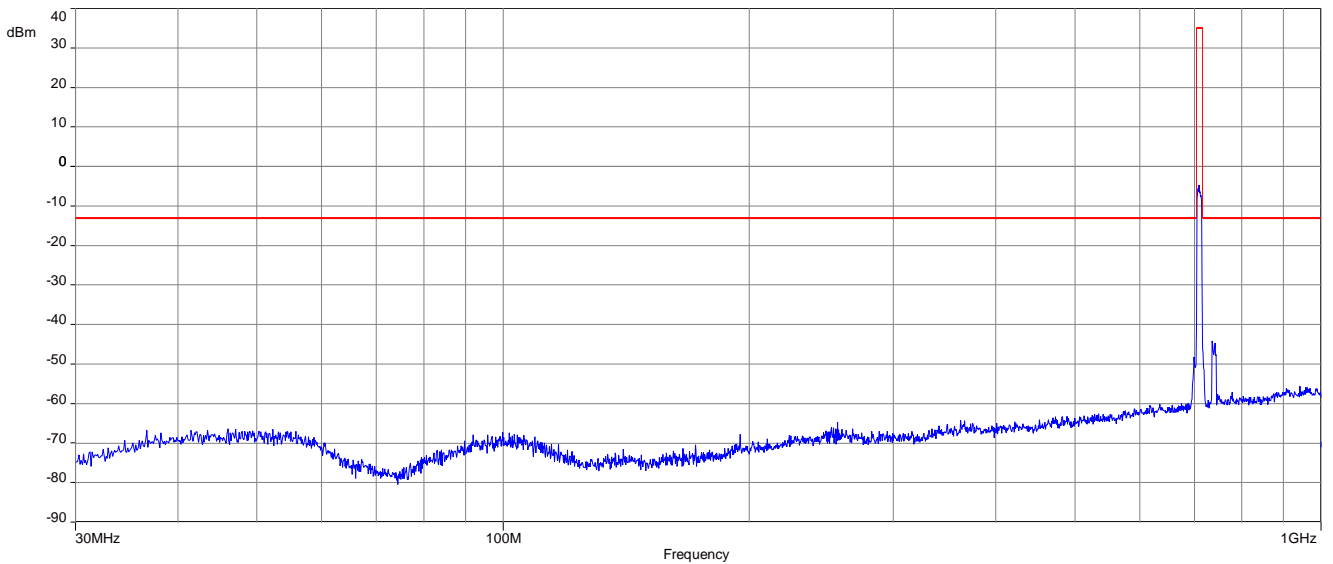

Plot 3: Middle channel, 1 GHz to 8 GHz

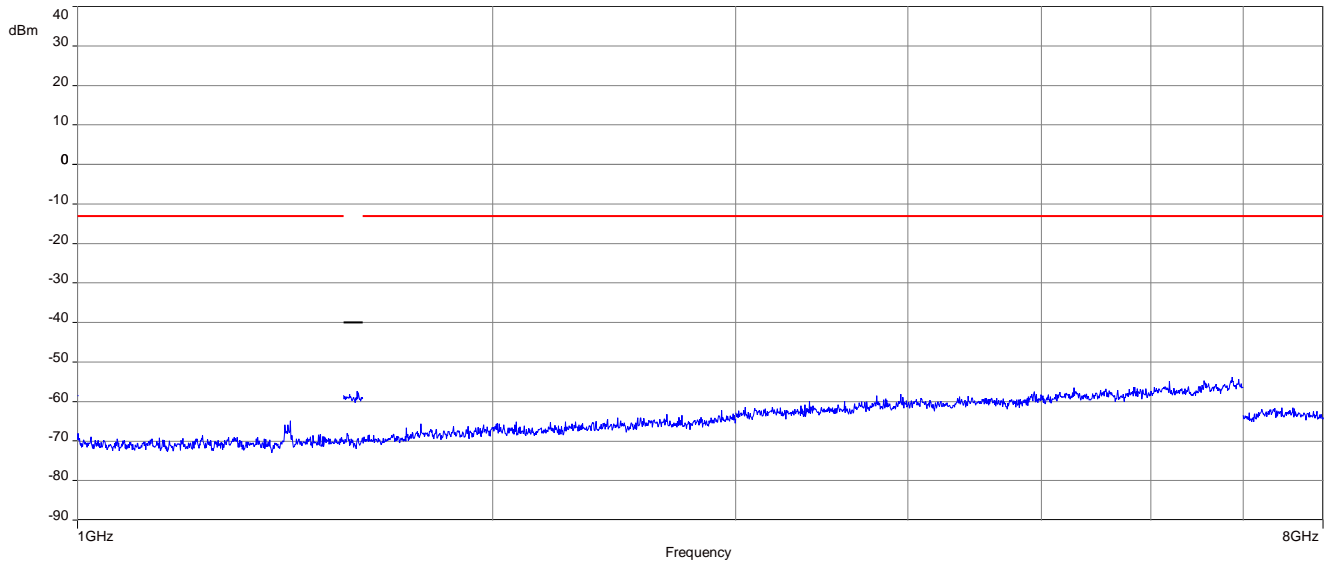

Results: 16-QAM with 10 MHz channel bandwidth

Plot 1: Middle channel, up to 30 MHz

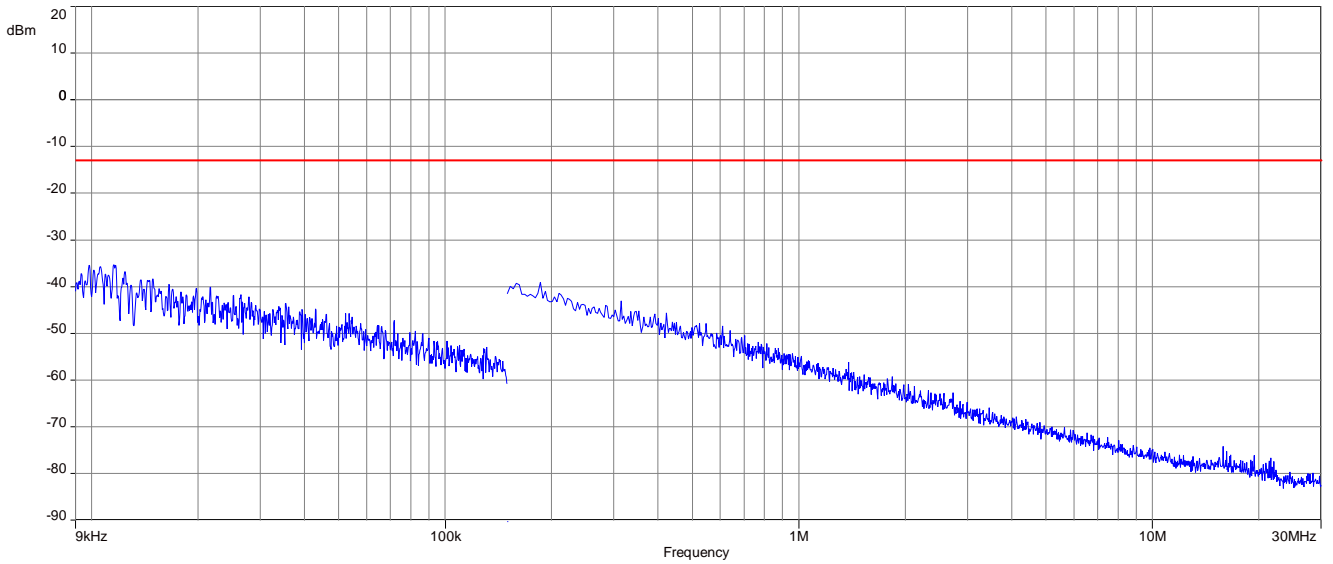

Plot 2: Middle channel, 30 MHz to 1 GHz

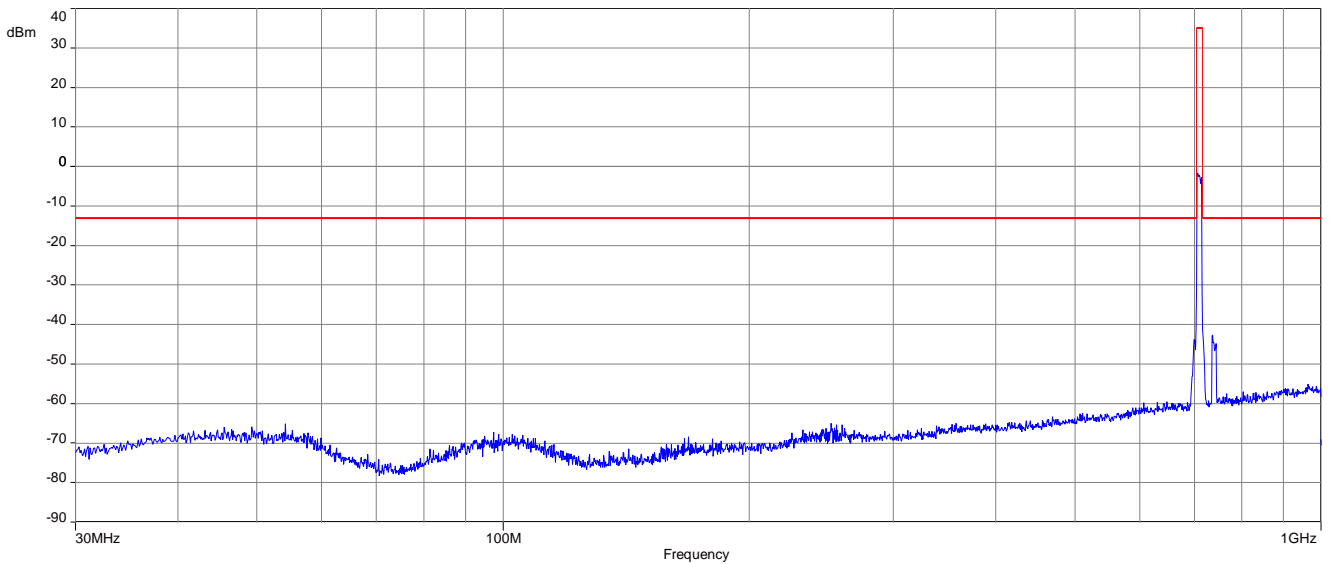

Plot 3: Middle channel, 1 GHz to 8 GHz

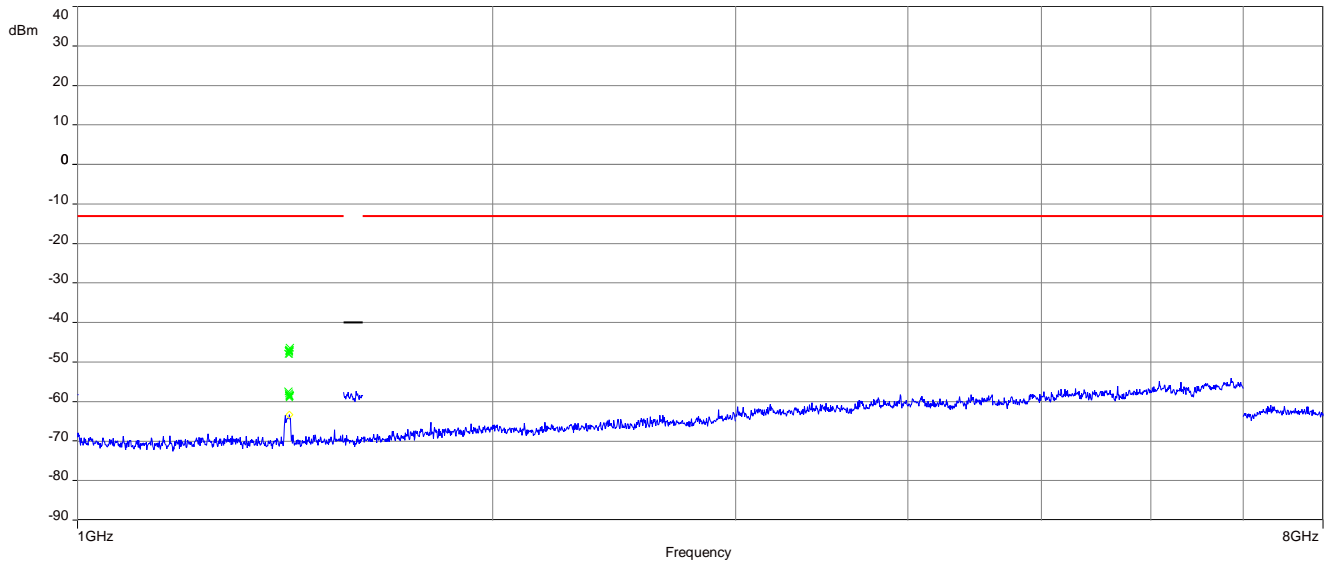

26 Observations

No observations except those reported with the single test cases have been made.

27 Glossary

EUT	Equipment under test
DUT	Device under test
UUT	Unit under test
GUE	GNSS User Equipment
ETSI	European Telecommunications Standards Institute
EN	European Standard
FCC	Federal Communications Commission
FCC ID	Company Identifier at FCC
IC	Industry Canada
PMN	Product marketing name
HMN	Host marketing name
HVIN	Hardware version identification number
FVIN	Firmware version identification number
EMC	Electromagnetic Compatibility
HW	Hardware
SW	Software
Inv. No.	Inventory number
S/N or SN	Serial number
C	Compliant
NC	Not compliant
NA	Not applicable
NP	Not performed
PP	Positive peak
QP	Quasi peak
AVG	Average
OC	Operating channel
OCW	Operating channel bandwidth
OBW	Occupied bandwidth
OOB	Out of band
DFS	Dynamic frequency selection
CAC	Channel availability check
OP	Occupancy period
NOP	Non occupancy period
DC	Duty cycle
PER	Packet error rate
CW	Clean wave
MC	Modulated carrier
WLAN	Wireless local area network
RLAN	Radio local area network
DSSS	Dynamic sequence spread spectrum
OFDM	Orthogonal frequency division multiplexing
FHSS	Frequency hopping spread spectrum
GNSS	Global Navigation Satellite System
C/N₀	Carrier to noise-density ratio, expressed in dB-Hz

28 Document history

Version	Applied changes	Date of release
-/-	Initial release	2021-06-08

29 Accreditation Certificate – D-PL-12076-01-04

first page	last page
 <p>Deutsche Akkreditierungsstelle GmbH</p> <p>Entrusted according to Section 8 subsection 1 AkkStelleG in connection with Section 1 subsection 1 AkkStelleGBV Signatory to the Multilateral Agreements of EA, ILAC and IAF for Mutual Recognition</p> <p>Accreditation </p> <p>The Deutsche Akkreditierungsstelle GmbH attests that the testing laboratory</p> <p>CTC advanced GmbH Untertürkheimer Straße 6-10, 66117 Saarbrücken</p> <p>is competent under the terms of DIN EN ISO/IEC 17025:2018 to carry out tests in the following fields:</p> <p>Telecommunication (TC) and Electromagnetic Compatibility (EMC) for Canadian Standards</p> <p>The accreditation certificate shall only apply in connection with the notice of accreditation of 09.06.2020 with the accreditation number D-PL-12076-01. It comprises the cover sheet, the reverse side of the cover sheet and the following annex with a total of 07 pages.</p> <p>Registration number of the certificate: D-PL-12076-01-04</p> <p>Frankfurt am Main, 09.06.2020</p> <p>by order:  Head of Division</p> <p><small>The certificate together with its annex reflects the status at the time of the date of issue. The current status of the scope of accreditation can be found in the database of accredited bodies of Deutsche Akkreditierungsstelle GmbH. https://www.dakks.de/en/content/accredited-bodies-dakks See notes on reverse.</small></p>	<p>Deutsche Akkreditierungsstelle GmbH</p> <p>Office Berlin Spittelmarkt 10 10117 Berlin</p> <p>Office Frankfurt am Main Europa-Allee 52 60327 Frankfurt am Main</p> <p>Office Braunschweig Bundesallee 100 38116 Braunschweig</p> <p>The publication of extracts of the accreditation certificate is subject to the prior written approval by Deutsche Akkreditierungsstelle GmbH (DAkks). Exempted is the unchanged form of separate disseminations of the cover sheet by the conformity assessment body mentioned overleaf.</p> <p>No impression shall be made that the accreditation also extends to fields beyond the scope of accreditation attested by DAkks.</p> <p>The accreditation was granted pursuant to the Act on the Accreditation Body (AkkStelleG) of 31 July 2009 (Federal Law Gazette I p. 2525) and the Regulation (EC) No 765/2008 of the European Parliament and of the Council of 9 July 2008 setting out the requirements for accreditation and market surveillance relating to the marketing of products (Official Journal of the European Union L 218 of 9 July 2008, p. 30). DAkks is a signatory to the Multilateral Agreements for Mutual Recognition of the European co-operation for Accreditation (EA), International Accreditation Forum (IAF) and International Laboratory Accreditation Cooperation (ILAC). The signatories to these agreements recognise each other's accreditations.</p> <p>The up-to-date state of membership can be retrieved from the following websites: EA: www.european-accreditation.org ILAC: www.ilac.org IAF: www.iaf.nu</p>

Note: The current certificate annex is published on the website (link see below) of the Accreditation Body DAkks or may be received by CTC advanced GmbH on request

<https://www.dakks.de/as/ast/d/D-PL-12076-01-04e.pdf>

30 Accreditation Certificate – D-PL-12076-01-05

first page	last page			
 <p>Deutsche Akkreditierungsstelle GmbH</p> <p>Entrusted according to Section 8 subsection 1 AkkStelleG in connection with Section 1 subsection 1 AkkStelleGBV Signatory to the Multilateral Agreements of EA, ILAC and IAF for Mutual Recognition</p> <p>Accreditation </p> <p>The Deutsche Akkreditierungsstelle GmbH attests that the testing laboratory CTC advanced GmbH Untertürkheimer Straße 6-10, 66117 Saarbrücken</p> <p>is competent under the terms of DIN EN ISO/IEC 17025:2018 to carry out tests in the following fields: Telecommunication (FCC Requirements)</p> <p>The accreditation certificate shall only apply in connection with the notice of accreditation of 09.06.2020 with the accreditation number D-PL-12076-01. It comprises the cover sheet, the reverse side of the cover sheet and the following annex with a total of 05 pages.</p> <p>Registration number of the certificate: D-PL-12076-01-05</p> <p>Frankfurt am Main, 09.06.2020</p> <p>by order of Dipl.-Ing. (FH)  Eigner Head of Division</p> <p><small>The certificate together with its annex reflects the status at the time of the date of issue. The current status of the scope of accreditation can be found in the database of accredited bodies of Deutsche Akkreditierungsstelle GmbH. https://www.dakks.de/en/content/accredited-bodies-dakks See notes annex 1.</small></p>	<p>Deutsche Akkreditierungsstelle GmbH</p> <table border="0"> <tr> <td>Office Berlin Spittelmarkt 10 10117 Berlin</td> <td>Office Frankfurt am Main Europa-Allee 52 60327 Frankfurt am Main</td> <td>Office Braunschweig Bundesallee 100 38116 Braunschweig</td> </tr> </table> <p>The publication of extracts of the accreditation certificate is subject to the prior written approval by Deutsche Akkreditierungsstelle GmbH (DAKKS). Exempted is the unchanged form of separate disseminations of the cover sheet by the conformity assessment body mentioned overleaf.</p> <p>No impression shall be made that the accreditation also extends to fields beyond the scope of accreditation attested by DAKKS.</p> <p>The accreditation was granted pursuant to the Act on the Accreditation Body (AkkStelleG) of 31 July 2009 (Federal Law Gazette I p. 2625) and the Regulation (EC) No 765/2008 of the European Parliament and of the Council of 9 July 2008 setting out the requirements for accreditation and market surveillance relating to the marketing of products (Official Journal of the European Union L 218 of 9 July 2008, p. 30). DAKKS is a signatory to the Multilateral Agreements for Mutual Recognition of the European co-operation for Accreditation (EA), International Accreditation Forum (IAF) and International Laboratory Accreditation Cooperation (ILAC). The signatories to these agreements recognise each other's accreditations.</p> <p>The up-to-date state of membership can be retrieved from the following websites: EA: www.european-accreditation.org ILAC: www.ilac.org IAF: www.iaf.nu</p>	Office Berlin Spittelmarkt 10 10117 Berlin	Office Frankfurt am Main Europa-Allee 52 60327 Frankfurt am Main	Office Braunschweig Bundesallee 100 38116 Braunschweig
Office Berlin Spittelmarkt 10 10117 Berlin	Office Frankfurt am Main Europa-Allee 52 60327 Frankfurt am Main	Office Braunschweig Bundesallee 100 38116 Braunschweig		

Note: The current certificate annex is published on the website (link see below) of the Accreditation Body DAKKS or may be received by CTC advanced GmbH on request

<https://www.dakks.de/as/ast/d/D-PL-12076-01-05e.pdf>

END OF TEST REPORT