

SAR TEST REPORT

Product:	Rugged Smart Phone
Model No:	TDC100_WiFi
Additinoal Model:	N/A
Trade Mark:	Trimble
FCC ID:	NZI-10900330
IC ID	9288A-10900330
Report No:	WT-1606-0018
Issued Date:	Aug 26,2016

Issued for:

TRIMBLE EUROPE B.V.
European Regional Fulfilment Centre Meerheide,45 5521DZ Eersel THE
NETHERLANDS

Issued By:

Inventec Appliances(Jiangning) Corporation Testing Laboratory
Address: 133, Jiang-Jun Road, Jiangning Economic and Technological
Development Zone, Nanjing , P.R.C China
Tel:025-52262313 Fax: 025-52787690

TABLE OF CONTENTS

1. Test Certification	2
2. Test Result Summary	4
3. EUT Description	5
4. RF Exposure Limit	6
5. SAR Measurement System Configuration	6
6. Measurement Procedure	14
7. Conducted Output Power	17
8. SAR Test Results Summary	18
9. System Check Results	26
10. SAR Test Data	30
Appendix A: EUT Photos	76
Appendix B: Test Setup Photos	77
APPENDIX C: PROBE CALIBRATION CERTIFICATE	80
APPENDIX D: DIPOLE CALIBRATION REPORT	89

1. TEST CERTIFICATION

Product:	Rugged Smart Phone
Model No.:	TDC100_WiFi
Additional Model:	N/A
Trade Mark:	Trimble
Applicant:	TRIMBLE EUROPE B.V.
Address:	European Regional Fulfilment Centre Meerheide,45 5521DZ Eersel THE NETHERLANDS
Manufacturer:	TRIMBLE EUROPE B.V.
Address:	1 rue Thomas Edison, ZAC de la Fleuriaye, 44470 CARQUEFOU, France
Date of Test:	Aug 22, 2016
SAR Max. Values:	0.29W/Kg (1g) for Body; 0.22W/Kg (1g) for Head
Applicable Standards:	FCC 47 CFR Parts 1&2,ANSI C95.1-2005,IEEE 1528-2013 RSS-102

Tested By: Zhang Shugui Date: 2016.8.26
 Reviewed By: Ji Jianlin Date: 2016.8.26
 Approved By: Ji Jianlin Date: 2016.8.26

2. TEST RESULT SUMMARY

The maximum results of Specific Absorption Rate (SAR) found during test as bellows:

<Highest Reported standalone SAR Summary>

Exposure Position	Frequency Band	Reported 1g SAR (W/kg)	Equipment Class	Highest Reported 1g SAR (W/kg)
Head	WiFi 2.4GHz	0.22	DTS	0.22
Body (5mm Gap)	WiFi 2.4GHz	0.29	DTS	0.29

3. EUT DESCRIPTION

Product Name:	Rugged Smart Phone
Model :	TDC100_WiFi
Additional Model:	N/A
Trade Mark:	Trimble
Hardware Version:	TDC100.WiFi_V1.0
Software Version:	TDC100.WiFi.16.22.03
Power Supply:	Rechargeable Li-ion Battery DC3.7V
WIFI	
Supported type:	802.11b/802.11g/802.11n
Modulation:	802.11b: DSSS 802.11g/802.11n:OFDM
Operation frequency:	802.11b/802.11g/802.11n(HT20):2412MHz~2462MHz;
Channel number:	1CH/6CH/11CH
Channel separation:	5MHz
BT	
Bluetooth Version:	BT4.0(BR/EDR+BLE)
EUT Production stage:	Production unit

4. SAR MEASUREMENT SYSTEM CONFIGURATION

4.1 Measurement Set-up

The OPENSAR system for performing compliance tests consist of the following items: A standard high precision 6-axis robot (KUKA) with controller and software. KUKA Control Panel (KCP) A dosimetric probe, i.e., an isotropic E-field probe optimized and calibrated for usage in tissue simulating liquid. The probe is equipped with a Video Positioning System (VPS).The stress sensor is composed with mechanical and electronic when the electronic part detects a change on the electro-mechanical switch; it sends an “Emergency signal” to the robot controller that to stop robot’s moves A computer operating Windows XP. OPENSAR software Remote control with teaches pendant and additional circuitry for robot safety such as warning lamps, etc. The SAM phantom enabling testing left-hand right-hand and body usage. The Position device for handheld EUT Tissue simulating liquid mixed according to the given recipes. System validation dipoles to validate the proper functioning of the system.

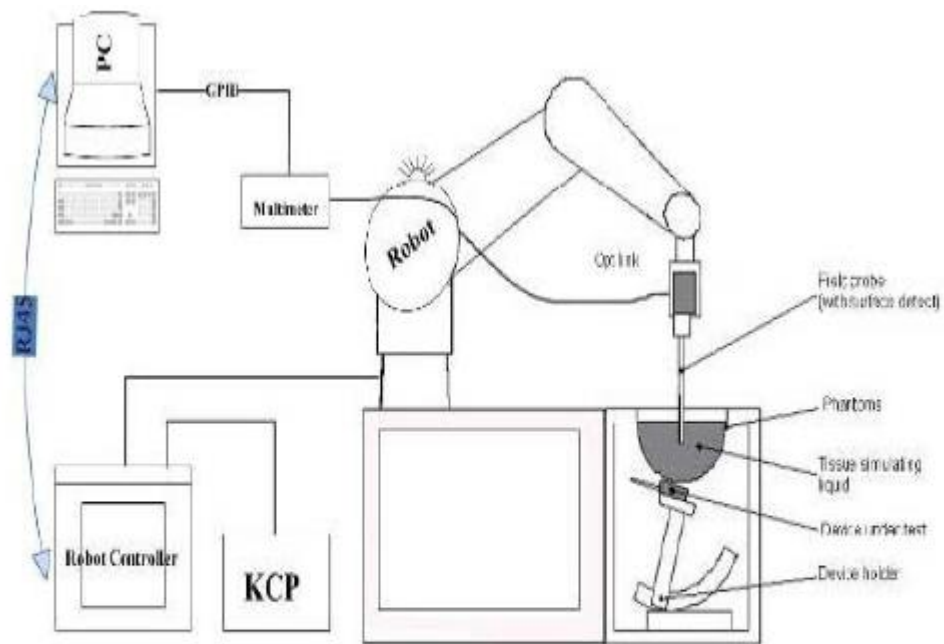

KUKA SAR Test System Configuration

4.2 E-field Probe

The SAR measurement is conducted with the dosimetric probe (manufactured by SATIMO). The probe is specially designed and calibrated for use in liquid with high permittivity. The dosimetric probe has special calibration in liquid at different frequency. This probe has a built in optical surface detection system to prevent from collision with phantom.

Probe Specification

Construction Symmetrical design with triangular core Interleaved sensors Built-in shielding against static charges PEEK enclosure material (resistant to organic solvents, e.g., DGBE) Calibration ISO/IEC 17025 calibration service available.

Device Type	COMOSAR DOSIMETRIC E FIELD PROBE
Manufacturer	Satimo
Model	SSE5
Serial Number	SN 18/11 EP121
Frequency Range of Probe	0.7 GHz-3GHz
Resistance of Three Dipoles at Connector	Dipole 1:R1=0.180MΩ Dipole 2:R2=0.191MΩ Dipole 3:R3=0.179MΩ



Figure 1 – Satimo COMOSAR Dosimetric E field Dipole

Device Type	COMOSAR DOSIMETRIC E FIELD PROBE
Manufacturer	Satimo
Model	SSE5
Serial Number	SN 35/11 EP131
Frequency Range of Probe	0.7 GHz-3GHz
Resistance of Three Dipoles at Connector	Dipole 1: R1=0.999 MΩ Dipole 2: R2=1.244 MΩ Dipole 3: R3=1.253 MΩ



Figure 1 – Satimo COMOSAR Dosimetric E field Dipole

4.3 Phantom

The SAM Phantom SAM72/ SAM73 is constructed of a fiberglass shell integrated in a wooden table. The shape of the shell is in compliance with the specification set in IEEE P1528 and CENELEC EN62209-1, EN62209-2:2010.

The phantom enables the dosimetric evaluation of left and right hand phone usage as well as body mounted usage at the flat phantom region.

A cover prevents the evaporation of the liquid.

Reference markings on the Phantom allow the complete setup of all predefined phantom positions and measurement grids by manually teaching three points in the robot.

System checking was performed using the flat section, whilst Head SAR tests used the left and right head profile sections.

Body SAR testing also used the flat section between the head profiles.

Name: COMOSAR IEEE SAM PHANTOM

S/N:3909 SAM 72 / 3909 SAM 73

Manufacture: SATIMO



Name: COMOSAR IEEE SAM PHANTOM

S/N: SN 3909 ELLI16

Manufacture: SATIMO

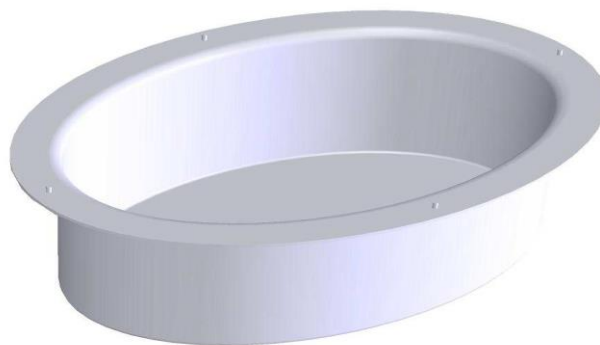

4.4 Device holder

The SAR value is approximately inversely proportional to the square of the distance between the source and the internal surface of the phantom. For a source at 5 mm distance, a positioning uncertainty of 0.5 mm would produce a SAR uncertainty of 20 %. An accurate device positioning is therefore essential for accurate and repeatable measurements.

This Positioning system allows the translation of the mobile phone along the X, Y and Z axis, as well as the required rotation around the phantom ear, for the 2 positions defined by standards (0° “cheek” position and 15° “tilt” position).

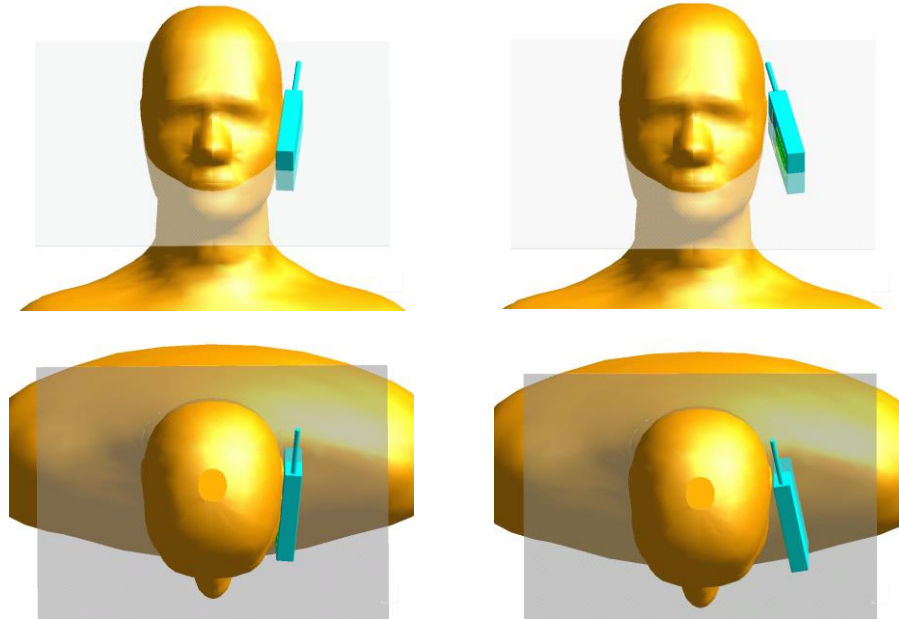
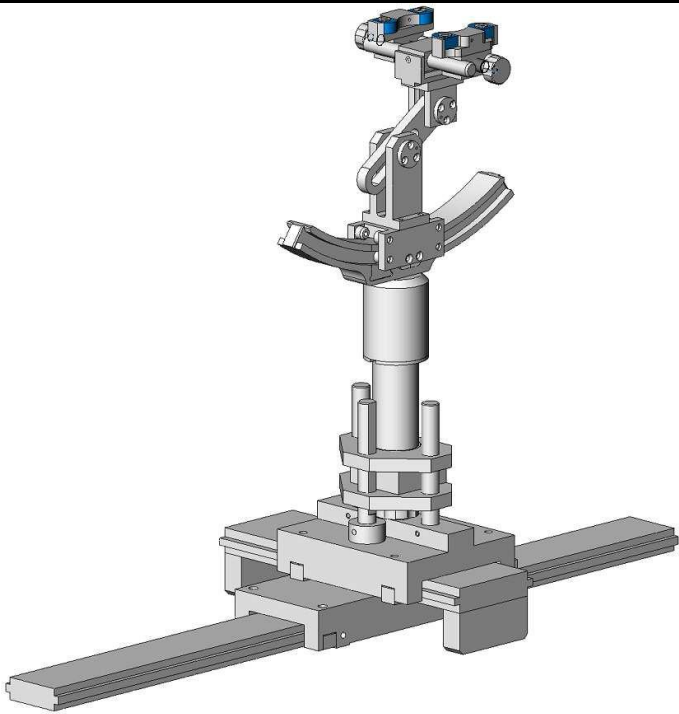

Fig1:Cheek and Tilt positions requested by CENELEC and IEEE

Mobile phone positioning system characteristics

	<p>Totally metal-free design</p> <p>Rotation point on ear opening</p> <p>Translation to lock the device under test under the flat part or under the left or right ear</p> <p>High repeatability with rotation point external adjustment</p> <p>Easy and accurate position according to all standards</p> <p>Compliance with mobile phone, PMR or PDA dimensions</p>
---	---

X translation	700 mm
Y translation	250 mm
Z translation	100 mm

The correct position can be easily defined thanks to an additional tool with a pointer. With this tool, the top part of the system, above the curved rail, can be fixed definitively, so that the subsequent adjustments just concern the angle or the X, Y or Z axis.

It simplifies the positioning of the acoustic output of the telephone on the cross section of the phantom, before rolling the system underneath the phantom. Moreover, it improves the accuracy and repeatability of the positioning with a tolerance ≤ 0.5 mm.

4.5 Tissue Dielectric Parameters

According to IEEE1528, the liquid parameters for head are the same as body requirements. For SAR measurement of the field distribution inside the phantom.

The phantom must be filled with homogeneous tissue simulating liquid a depth of at least 15cm, For head SAR testing, the liquid height from the ear reference point(ERP) of the phantom to the liquid top surface is larger than 15cm, For body SAR testing, the liquid height from the center of the flat phantom to the liquid top surface is larger than 15cm.

TYPICAL COMPOSITION OF INGREDIENTS FOR LIQUID TISSUE PHANTOMS

Ingredients (% by weight)	Frequency (MHz)									
	450		835		915		1900		2450	
Tissue Type	Head	Body	Head	Body	Head	Body	Head	Body	Head	Body
Water	38.56	51.16	41.45	52.4	41.05	56.0	54.9	40.4	62.7	73.2
Salt (NaCl)	3.95	1.49	1.45	1.4	1.35	0.76	0.18	0.5	0.5	0.04
Sugar	56.32	46.78	56.0	45.0	56.5	41.76	0.0	58.0	0.0	0.0
HEC	0.98	0.52	1.0	1.0	1.0	1.21	0.0	1.0	0.0	0.0
Bactericide	0.19	0.05	0.1	0.1	0.1	0.27	0.0	0.1	0.0	0.0
Triton X-100	0.0	0.0	0.0	0.0	0.0	0.0	0.0	0.0	36.8	0.0
DGBE	0.0	0.0	0.0	0.0	0.0	0.0	44.92	0.0	0.0	26.7
Dielectric Constant	43.42	58.0	42.54	56.1	42.0	56.8	39.9	54.0	39.8	52.5
Conductivity (S/m)	0.85	0.83	0.91	0.95	1.0	1.07	1.42	1.45	1.88	1.78

Salt: 99% Pure Sodium Chloride Sugar: 98% Pure Sucrose
 Water: De-ionized, 16 MΩ resistivity HEC: Hydroxyethyl Cellulose
 DGBE: 99% Di(ethylene glycol) butyl ether, [2-(2-butoxyethoxy)ethanol]
 Triton X-100 (ultra pure): Polyethylene glycol mono [4-(1,1, 3, 3-tetramethylbutyl)phenyl]ether

Target Frequency (MHz)	Head		Body	
	ϵ_r	σ (S/m)	ϵ_r	σ (S/m)
150	52.3	0.76	61.9	0.80
300	45.3	0.87	58.2	0.92
450	43.5	0.87	56.7	0.94
835	41.5	0.90	55.2	0.97
900	41.5	0.97	55.0	1.05
915	41.5	0.98	55.0	1.06
1450	40.5	1.20	54.0	1.30
1610	40.3	1.29	53.8	1.40
1800 – 2000	40.0	1.40	53.3	1.52
2450	39.2	1.80	52.7	1.95
3000	38.5	2.40	52.0	2.73
5800	35.3	5.27	48.2	6.00

(ϵ_r = relative permittivity, σ = conductivity and $\rho = 1000 \text{ kg/m}^3$)

4.6 Tissue-equivalent Liquid-Head Properties

Frequency (MHz)	Test Date	Temp °C	Measured Dielectric Parameters		Target Dielectric Parameters		Limit (Within±5%)	
			ϵ_r	σ (s/m)	ϵ_r	σ (s/m)	Dev ϵ_r (%)	Dev σ (%)
2450	22/8/2016	22.0	39.89	1.73	39.2	1.80	1.8	-3.9

4.7 Tissue-equivalent Liquid-Body Properties

Frequency (MHz)	Test Date	Temp °C	Measured Dielectric Parameters		Target Dielectric Parameters		Limit (Within±5%)	
			ϵ_r	σ (s/m)	ϵ_r	σ (s/m)	Dev ϵ_r (%)	Dev σ (%)
2450	22/8/2016	22.0	51.3	1.88	52.7	1.95	-2.7	-3.6

4.8 Sensitivity In Liquid

Probe	Liquid	Frequency (MHz+/-100MHz)	Permittivity	Epsilon(S/m)	ConvF
EP131	HL2450	2450	39.05	1.77	7.22
	BL2450	2450	52.97	1.93	7.46

4.9 System Check

System validation has to be performed with the below input power measurement test setup described in §8.2.4-IEEE 1528-page 65. The SAR system must be validated against its performance specifications before it is deployed. When SAR probe and system component or software are changed, upgraded or recalibrated, these must be validated with the SAR system(s) that operates with such component. Reference dipoles are used with the required tissue-equivalent media for system validation.

System check results have to be equal or near the values determined during dipole calibration with the relevant liquids and test system ($\pm 10\%$).

System check is performed regularly on all frequency bands where tests are performed with the OPENSAR system.

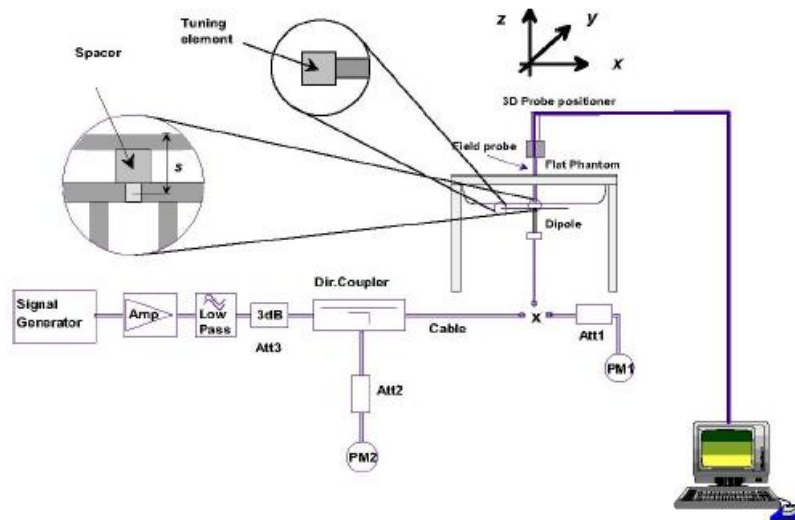

System Validation is used for verifying the accuracy of the probe and readout electronics, and performance of the software.

System Check Set-up

Verification Results (Head)	Frequency (MHz)	Measured Value in 10dBm (W/kg)		Normalized to 1W (W/kg)		Target Value Frequency (W/kg)		Deviation (%)	
		1 g Average	10 g Average	1 g Average	10 g Average	1 g Average	10 g Average	1 g Average	10 g Average
		2450	0.560	0.232	56.00	23.20	52.40	24.00	6.9

Verification Result (Body)	Frequency (MHz)	Measured Value in 20dBm (W/kg)		Normalized to 1W (W/kg)		Target Value Frequency (W/kg)		Deviation (%)	
		1 g Average	10 g Average	1 g Average	10 g Average	1 g Average	10 g Average	1 g Average	10 g Average
		2450	4.967	2.301	49.67	23.01	52.40	24.00	-5.2

Comparing to the original SAR value provided by SATIMO, the verification data should be within its specification of 10%. Table shows the target SAR and measured SAR after normalized to 1W input power. The table indicates the system performance check can meet the variation criterion and the plots can be referred to Section 10 of this report.

5. MEASUREMENT PROCEDURE

5.1 Measurement Process Diagram

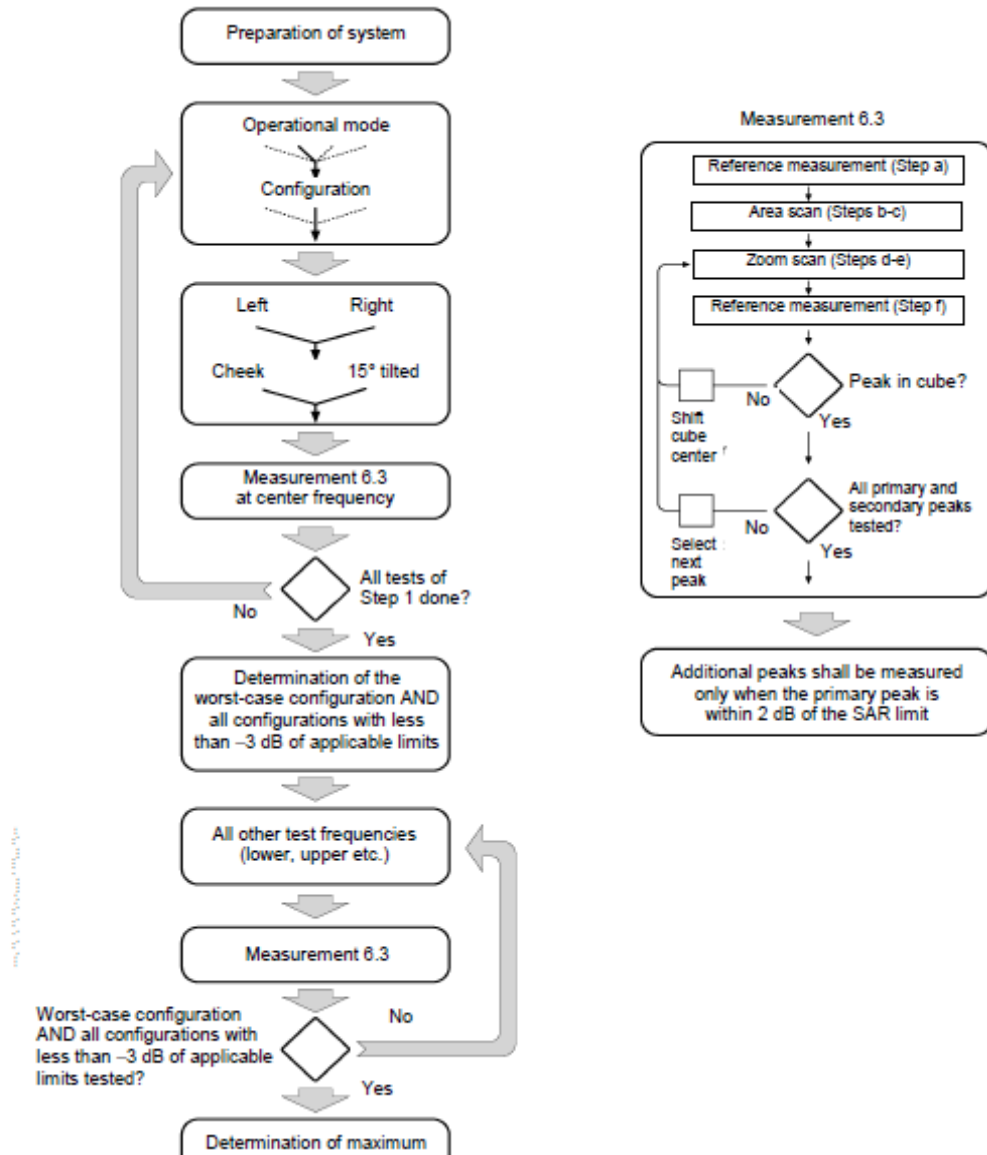

5.2 Measurement Procedure

5.2.1 Setup a Call Connection

The maximum transmitting power through software control

5.2.2 Power Reference Measurement

The reference and drift jobs are useful jobs for monitoring the power drift of the device under test in the batch process. Both jobs measure the field at a specified reference position, at selectable distance from the phantom surface. The reference position can be either the selected section's grid reference point or a user point in this section. The reference job projects the selected point onto the phantom surface, orients the probe perpendicularly to the surface, and approaches the surface using the selected detection method.

5.2.3 Area Scan

Area scans are defined prior to the measurement process being executed with a user defined variable spacing between each measurement point (integral) allowing low uncertainty measurements to be conducted. Scans defined for FCC applications utilize a 10mm² step integral, with 1mm interpolation used to locate the peak SAR area used for zoom scan assessments.

When an Area Scan has measured all reachable points, it computes the field maxima found in the scanned area, within a range of the global maximum. The range (in dB) is specified in the standards for compliance testing. For example, a 2 dB range is required in IEEE 1528-2013, EN 50361 and IEC 62209 standards, whereby 3 dB is a requirement when compliance is assessed in accordance with the ARIB standard.

5.2.4 Zoom Scan

Zoom scans are used to assess the peak spatial SAR values within a cubic averaging volume containing 1 g and 10 g of simulated tissue. The default zoom scan measures 5 x 5 x 4 points within a cube whose base faces are centered around the maximum found in a preceding area scan job within the same procedure. If the preceding Area Scan job indicates more than one maximum, the number of Zoom Scans has to be enlarged accordingly (The default number inserted is 1).

5.2.5 Power Drift measurement

The drift job measures the field at the same location as the most recent reference job within the same procedure, and with the same settings. The drift measurement gives the field difference in dB from the reading conducted within the last reference measurement. Several drift measurements are possible for one reference measurement. This allows a user to monitor the power drift of the device under test within a batch process.

In the properties of the Drift job, the user can specify a limit for the drift and have OPENSAR software stop the measurements if this limit is exceeded.

If the power drifts more than 5%, the SAR will be retested.

6. HOTSPOT MODE EVALUATION PROCEDURE

The SAR evaluation procedures for Portable Devices with Wireless Router function is according to KDB 941225 D06 Hot Spot SAR v01r01.

SAR must be tested for all surfaces and edges (side) with a transmitting antenna with in 2.5cm from that surface or edge, at a test separation distance of 5mm, in the wireless mode that support wireless routing.

Edge configurations:

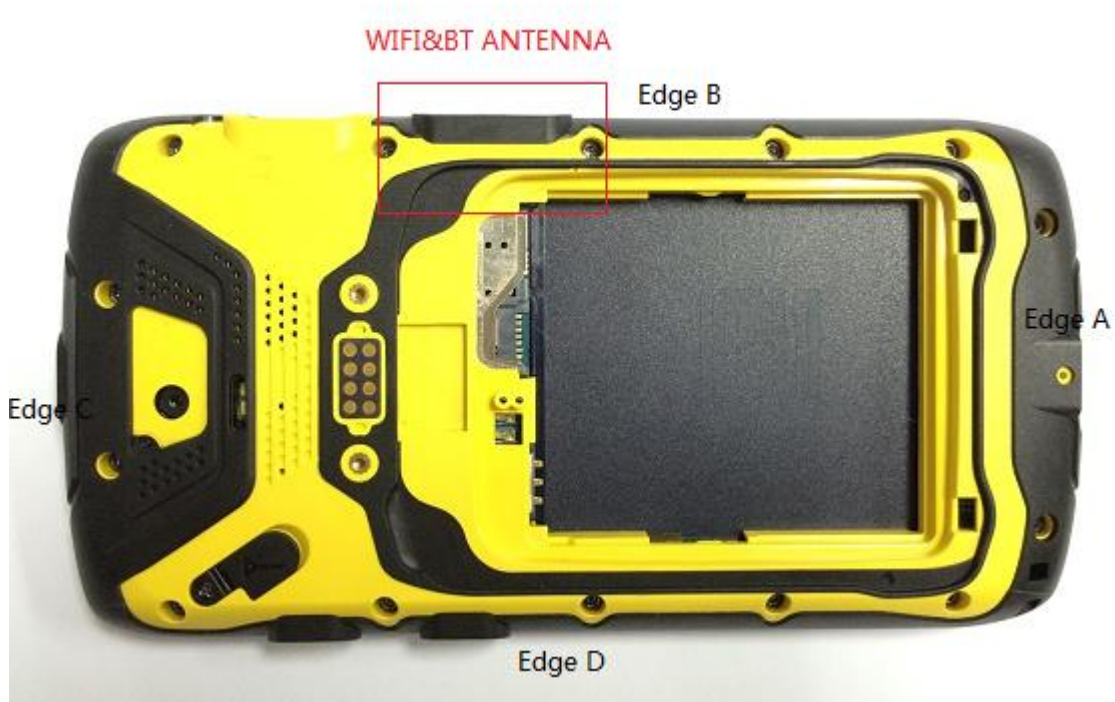

Hotspot side for SAR(Test distance:5mm)						
Antennas	Back	Front	Edge A	Edge B	Edge C	Edge D
WiFi	Yes	Yes	No	Yes	No	No
WiFi+Earphone	Yes	Yes	No	No	No	No

7. CONDUCTED OUTPUT POWER

7.1 WIFI AVG-POWER

Mode	1CH	6CH	11CH
WIFI 802.11b	15.4dBm	15.8dBm	15.4dBm
WIFI 802.11g	13.5dBm	13.7dBm	13.5dBm
WIFI 802.11n	13.4dBm	13.6dBm	13.1dBm

7.2 Bluetooth

Band	Mode	CH#	Frequency (MHz)	Output Avg Power (dBm)
BT	BT4.0(BR/EDR) GFSK	0	2402	7.35
		39	2441	6.66
		78	2480	4.36
	BT4.0(BR/EDR) $\pi/4$ -DQPSK	0	2402	7.69
		39	2441	6.56
		78	2480	6.56
	BT4.0(BR/EDR) 8-DPSK	0	2402	7.75
		39	2441	7.05
		78	2480	4.68
	BT4.0(BLE)	0	2402	-0.74
		19	2440	-0.71
		39	2480	-3.72

Note: 1. According to output power of WiFi, SAR is required 802.11b mode
 2. According to KDB 447498, the SAR test for Bluetooth is exclusion.

8. SAR TEST RESULTS SUMMARY

8.1 Head SAR 1g Value

Band	Mode	Position	CH.	Freq. (MHz)	SAR 1g (W/Kg)	Scaling Factor	Scaled SAR1g (W/Kg)
WiFi	802.11b	Left cheek	2412	1CH	0.15	1.15	0.17
		Right cheek		1CH	0.20		0.23
		Left cheek	2437	6CH	0.16	1.05	0.17
		Right cheek		6CH	0.22		0.23
		Left cheek	2462	11CH	0.08	1.15	0.09
		Right cheek		11CH	0.12		0.14
		Left tilt	2437	6CH	0.05	1.05	0.05
		Right tilt	2437	6CH	0.11	1.05	0.12

8.2 Body-Worn 1g SAR(5mm Gap)

Band	Mode	Position	CH.	Freq. (MHz)	SAR1g (W/Kg)	Scaling Factor	Scaled SAR1g (W/Kg)
WiFi	802.11b	Front	1CH	2412	0.03	1.15	0.04
		back			0.25		0.29
		Left			0.20		0.23
		Front	6CH	2437	0.02	1.05	0.02
		back			0.29		0.31
		Left			0.21		0.22
		Front	11CH	2462	0.01	1.15	0.01
		back			0.27		0.31
		Left			0.16		0.18
WiFi+ Earphone	802.11b	Front	1CH	2412	0.02	1.15	0.02
		back			0.19		0.22
		Front	6CH	2437	0.02	1.05	0.02
		back			0.20		0.21
		Front	11CH	2462	0.01	1.15	0.01
		back			0.16		0.18

Note:

Body-worn SAR testing was performed at 5mm separation, and this distance is

determined by the handset manufacturer that there will be body-worn accessories that users may acquire at the time of equipment certification, to enable users to purchase aftermarket body-worn accessories with the required minimum separation.

2. Determination of the worst-case configuration and all configurations with less than 3 dB of applicable limits.

4. When the 1g SAR for the mid-band channel or the channel with the highest output power satisfy the following conditions, testing of the other channels in the band is not required. (Per KDB 447498 D01 General RF Exposure Guidance)

5. Per FCC Publication 447498, if the reported (scaled) SAR measured at the middle channel or highest output power channel for each test configuration is $\leq 0.8\text{W/Kg}$ then testing at the other channels is not required for such test configurations. When the Maximum output power variation across the required test channels is 1/2 dB, instead of the middle channel, the highest output power channel was used.

8.2 Scaling Factor calculation

WIFI SAR test channel	SAR test channel Power (dBm)	Tune-up power tolerance (dBm)	Scaling Factor
1CH	15.4	Max output power= 15.5 ± 0.5	1.15
6CH	15.8		1.05
11CH	15.4		1.15

8.3 Measurement Uncertainty (450MHz-3GHz)

UNCERTAINTY EVALUATION FOR HANDSET SAR TEST									
a	b	c	d	e= f(d,k)	f	g	h= cxf/e	i= cxg/e	k
Uncertainty Component	Sec.	Tol. (± %)	Prob. Dist.	Div.	c_i (1 g)	c_i (10 g)	1 g u_i (± %)	10 g u_i (± %)	v_i
Measurement System									
Probe Calibration	E.2.1.	6	N	1	1	1	6	6	∞
Axial Isotropy	E.2.2.	3	R	$\sqrt{3}$	$(1-c_p)^{1/2}$	$(1-c_p)^{1/2}$	1,22474	1,22474	∞
Hemispherical Isotropy	E.2.2.	4	R	$\sqrt{3}$	$\sqrt{c_p}$	$\sqrt{c_p}$	1,63299	1,63299	∞
Boundary Effect	E.2.3.	1	R	$\sqrt{3}$	1	1	0,57735	0,57735	∞
Linearity	E.2.4.	5	R	$\sqrt{3}$	1	1	2,88675	2,88675	∞
System Detection Limits	E.2.5.	1	R	$\sqrt{3}$	1	1	0,57735	0,57735	∞
Readout Electronics	E.2.6.	0,5	N	1	1	1	0,5	0,5	∞
Response Time	E.2.7.	0,2	R	$\sqrt{3}$	1	1	0,11547	0,11547	∞
Integration Time	E.2.8.	2	R	$\sqrt{3}$	1	1	1,1547	1,1547	∞
RF Ambient Conditions	E.6.1.	3	R	$\sqrt{3}$	1	1	1,73205	1,73205	∞
Probe Positioner Mechanical Tolerance	E.6.2.	2	R	$\sqrt{3}$	1	1	1,1547	1,1547	∞
Probe Positioning with respect to Phantom Shell	E.6.3.	1	R	$\sqrt{3}$	1	1	0,57735	0,57735	∞
Extrapolation, interpolation and Integration Algorithms for Max. SAR Evaluation	E.5.2.	1,5	R	$\sqrt{3}$	1	1	0,86603	0,86603	∞
Test sample Related									
Test Sample Positioning	E.4.2.1.	1,5	N	1	1	1	1,5	1,5	N-1
Device Holder Uncertainty	E.4.1.1.	5	N	1	1	1	5	5	N-1
Output Power Variation - SAR drift measurement	6.6.2.	3	R	$\sqrt{3}$	1	1	1,73205	1,73205	∞
Phantom and Tissue Parameters									
Phantom Uncertainty (shape and thickness tolerances)	E.3.1.	4	R	$\sqrt{3}$	1	1	2,3094	2,3094	∞
Liquid Conductivity - deviation from target values	E.3.2.	5	R	$\sqrt{3}$	0,64	0,43	1,84752	1,2413	∞
Liquid Conductivity - measurement uncertainty	E.3.3.	2,5	N	1	0,64	0,43	1,6	1,075	M
Liquid Permittivity - deviation from target values	E.3.2.	3	R	$\sqrt{3}$	0,6	0,49	1,03923	0,8487	∞
Liquid Permittivity - measurement uncertainty	E.3.3.	2,5	N	1	0,6	0,49	1,5	1,225	M
Combined Standard Uncertainty			RSS				9,66051	9,52428	
Expanded Uncertainty (95% CONFIDENCE INTERVAL)			k				18,9346	18,6676	

UNCERTAINTY FOR SYSTEM PERFORMANCE CHECK

a	b	c	d	e= f(d,k)	f	g	h= cxf/e	i= cxg/e	k
Uncertainty Component	Sec.	Tol. (± %)	Prob. Dist.	Div.	c _i (1 g)	c _i (10 g)	1 g u _i (± %)	10 g u _i (± %)	v _i
Measurement System									
Probe Calibration	E.2.1.	6	N	1	1	1	6	6	∞
Axial Isotropy	E.2.2.	3	R	√3	(1-c _p) ^{1/2}	(1-c _p) ^{1/2}	1,22474	1,22474	∞
Hemispherical Isotropy	E.2.2.	5	R	√3	√c _p	√c _p	2,04124	2,04124	∞
Boundary Effect	E.2.3.	1	R	√3	1	1	0,57735	0,57735	∞
Linearity	E.2.4.	5	R	√3	1	1	2,88675	2,88675	∞
System Detection Limits	E.2.5.	1	R	√3	1	1	0,57735	0,57735	∞
Readout Electronics	E.2.6.	0,5	N	1	1	1	0,5	0,5	∞
Response Time	E.2.7.	0,2	R	√3	1	1	0,11547	0,11547	∞
Integration Time	E.2.8.	2	R	√3	1	1	1,1547	1,1547	∞
RF Ambient Conditions	E.6.1.	3	R	√3	1	1	1,73205	1,73205	∞
Probe Positioner Mechanical Tolerance	E.6.2.	2	R	√3	1	1	1,1547	1,1547	∞
Probe Positioning with respect to Phantom Shell	E.6.3.	1	R	√3	1	1	0,57735	0,57735	∞
Extrapolation, interpolation and Integration Algorithms for Max. SAR Evaluation	E.5.2.	1,5	R	√3	1	1	0,86603	0,86603	∞
Dipole									
Dipole Axis to Liquid Distance	8, E.4.2.	1	N	√3	1	1	0,57735	0,57735	N-1
Input Power and SAR drift measurement	8, 6.6.2.	2	R	√3	1	1	1,1547	1,1547	∞
Phantom and Tissue Parameters									
Phantom Uncertainty (shape and thickness tolerances)	E.3.1.	4	R	√3	1	1	2,3094	2,3094	∞
Liquid Conductivity - deviation from target values	E.3.2.	5	R	√3	0,64	0,43	1,84752	1,2413	∞
Liquid Conductivity - measurement uncertainty	E.3.3.	2,5	N	1	0,64	0,43	1,6	1,075	M
Liquid Permittivity - deviation from target values	E.3.2.	3	R	√3	0,6	0,49	1,03923	0,8487	∞
Liquid Permittivity - measurement uncertainty	E.3.3.	2,5	N	1	0,6	0,49	1,5	1,225	M
Combined Standard Uncertainty			RSS				8,09272	7,9296	
Expanded Uncertainty (95% CONFIDENCE INTERVAL)			k				15,8617	15,542	

8.4 Test Equipment List

Test Equipment	Manufacturer	Model	Serial Number	Calibration	
				Calibration Date	Calibration Due
Multimeter	Keithley	2000	1247155	2016/02/27	2017/02/28
Network Analyzer	Agilent	8753E	MY40000219	2015/11/27	2016/11/28
Radio tester	R & S	CMU200	112824	2015/11/29	2016/11/28
Radio tester	R & S	CMW500	129747	2015/11/06	2016/11/07
Power meter with USB connection to PC/Software	R & S	NRP-Z23	100129	2016/06/17	2017/06/16
Signal Generator	Agilent	E4432B	GB38450323	2016/04/09	2017/04/08
E-Field PROBE	SATIMO	SSE5	35/11	2014/09/22	2017/09/22
DIPOLE 2450	SATIMO	DIPJ122	39/09	2016/07/01	2018/07/01
Communication Antenna	SATIMO	ANTA29	39/09	N/A	N/A
Mobile Phone Position Device	SATIMO	MSH60	39/09	N/A	N/A
SAM PHANTOM	SATIMO	SAM72/SAM73	39/09	N/A	N/A
SAM PHANTOM	SATIMO	ELLI16	39/09	N/A	N/A
6 AXIS ROBOT	KUKA	KR5	949009	N/A	N/A
Power Meter	R & S	NRP	101109	2016/01/09	2017/01/09
Power Sensor	R & S	NRP-Z91	100350	2016/01/09	2017/01/09
Coaxial Directional Coupler	Agilent	87300C	MY44300185	2016/06/28	2017/06/27

Note:

N/A means this equipment no need to calibrate

The OPENSAR System calibration period was 3 years. In this period our lab is performing verification every six months.

9. TEST STANDARDS AND CONFIGURATION

9.1 Test Standards

Leading reference documents for testing:

No.	Identity	Document Title
1	47 CFR§2.1093	Radio Frequency Radiation Exposure Evaluation: Portable Devices
2	ANSI C95.1-2005	IEEE Standard for Safety Levels with Respect to human Exposure to Radio Frequency Electromagnetic Fields, 3kHz to 300GHz
3	IEEE 1528-2013	Recommended Practice for Determining the Peak Spatial-Average Specific Absorption Rate (SAR) in the Human Head from Wireless Communications Devices: Measurement Techniques.
4	KDB 447498 D01	General RF Exposure Guidance v06: Mobile and Portable Devices RF Exposure Procedures and Equipment Authorization Policies.
5	KDB941225 D06	Hotspot Mode SAR v02r01: SAR Evaluation Procedures for Portable Devices with Wireless Router Capabilities
6	KDB248227 D01	802.11 Wi-Fi SAR v02r02: SAR GUIDANCE FOR IEEE 802.11 (Wi-Fi) TRANSMITTERS

9.2 Device Category and SAR Limits

Controlled Environments are defined as locations where there is exposure that may be incurred by persons who are aware of the potential for exposure(i.e. as a result of employment or occupation). In general, occupational/controlled exposure limits are applicable to situations in which persons are exposed as a consequence of their employment, who have been made fully aware of the potential for exposure and can exercise control over their exposure. The exposure category is also applicable when the exposure is of a transient nature due to incidental passage through a location where the exposure levels may be higher than the general population/uncontrolled limits, but the exposed person is fully aware of the potential for exposure and can exercise control over his or her exposure by leaving the area or by some other appropriate means.

Limits for occupational/controlled Exposure(W/kg)

Whole-Body	Partial-Body	Hands, Wrists, Feet and Ankles
0.4	8.0	20.0

Limits for General population/Uncontrolled Exposure(W/kg)

Whole-Body	Partial-Body	Hands, Wrists, Feet and Ankles
0.08	1.60	4.00

This device belongs to portable device category because its radiating structure is allowed to be used within 20 centimeters of the body of the user. Limit for General Population/Uncontrolled exposure should be applied for this device, it is 1.6 W/kg as averaged over any 1 gram of tissue.

10. SYSTEM CHECK RESULTS

Date of measurement: 2016/08/22

Phantom: Validation plane

SAR Probe: SN_3511_EP131

Input Power:10dBm

Dipole Model: CW2450

<u>Area Scan</u>	<u>dx=8mm dy=8mmh= 5.00 mm</u>
<u>ZoomScan</u>	<u>7x7x7,dx=5mm dy=5mm dz=5mm, dx=8mm dy=8mm, h= 5.00 mm</u>
<u>Phantom</u>	<u>Validation plane</u>
<u>Device Position</u>	<u>Dipole</u>
<u>Band</u>	<u>CW2450</u>
<u>Channels</u>	<u>Middle</u>
<u>Signal</u>	<u>CW (Crest factor: 1.0)</u>
Frequency (MHz)	2450.000000
Relative permittivity (real part)	39.886002
Relative permittivity (imaginary part)	12.591600
Conductivity (S/m)	1.733857
Variation (%)	0.460000

SURFACE SAR

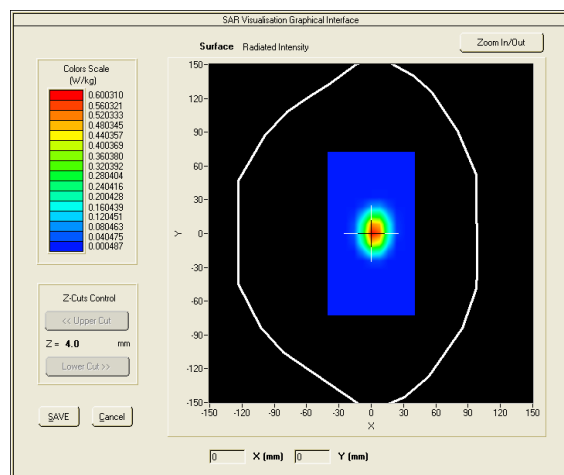

VOLUME SAR

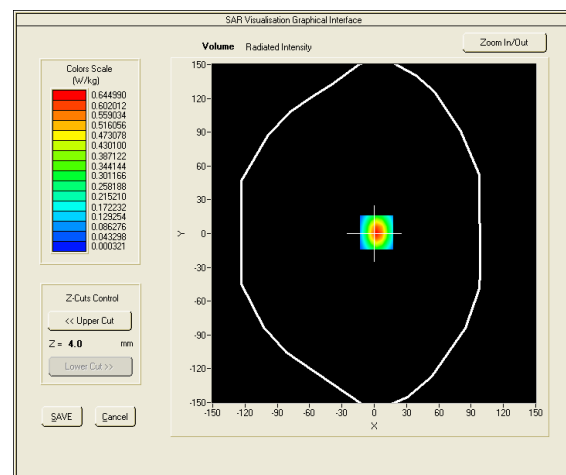

Maximum location: X=2.00, Y=1.00
 SAR Peak: 1.17 W/kg

SAR 10g (W/Kg)	0.231538
SAR 1g (W/Kg)	0.560114

Z (mm)	0.00	4.00	9.00	14.00	19.00
SAR (W/Kg)	1.1716	0.6450	0.2697	0.0927	0.0220

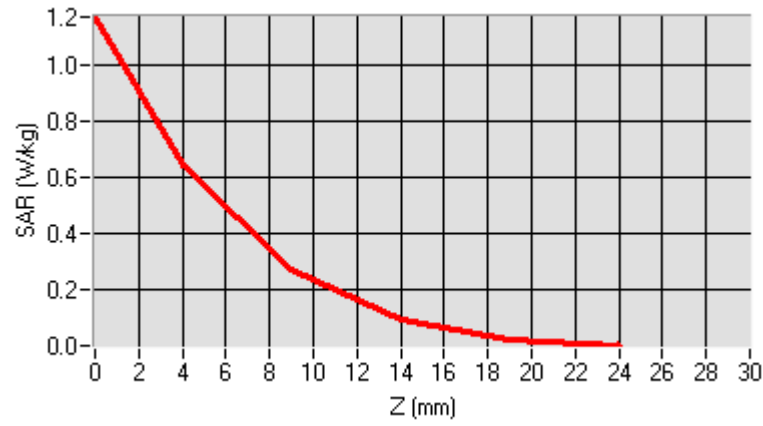

3D screen shot

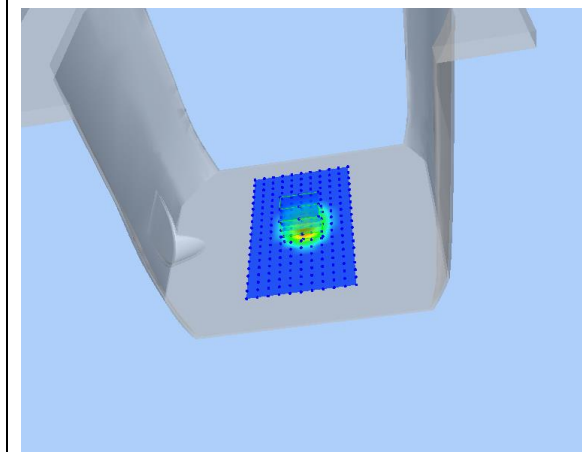

Date of measurement: 2016/08/22

Phantom: ELLI16

SAR Probe: SN_3511_EP131

Input Power:20dBm

Dipole Model: CW2450

<u>Area Scan</u>	<u>dx=8mm dy=8mmh= 5.00 mm</u>
<u>ZoomScan</u>	<u>7x7x7,dx=5mm dy=5mm dz=5mm, dx=8mm dy=8mm, h= 5.00 mm</u>
<u>Phantom</u>	<u>ELLI16</u>
<u>Device Position</u>	<u>Dipole</u>
<u>Band</u>	<u>CW2450</u>
<u>Channels</u>	<u>Middle</u>
<u>Signal</u>	<u>CW (Crest factor: 1.0)</u>
Frequency (MHz)	2450.000000
Relative permittivity (real part)	51.281399
Relative permittivity (imaginary part)	13.786300
Conductivity (S/m)	1.876469
Variation (%)	-0.030000

SURFACE SAR

VOLUME SAR

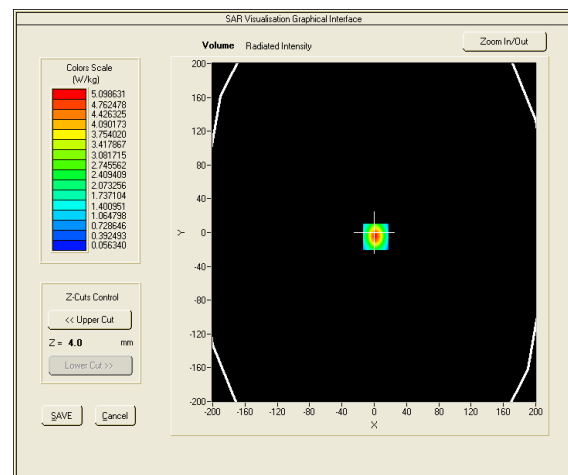
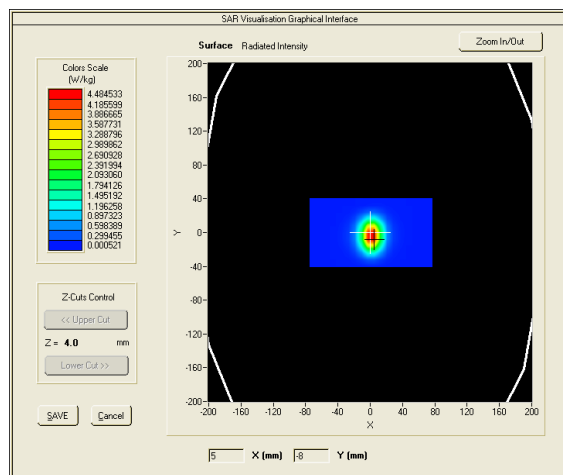

Maximum location: X=3.00, Y=-6.00
 SAR Peak: 9.27 W/kg

SAR 10g (W/Kg)	2.300676
SAR 1g (W/Kg)	4.966787

Z (mm)	0.00	4.00	9.00	14.00	19.00
SAR (W/Kg)	8.9011	5.3809	2.7377	1.3689	0.7058

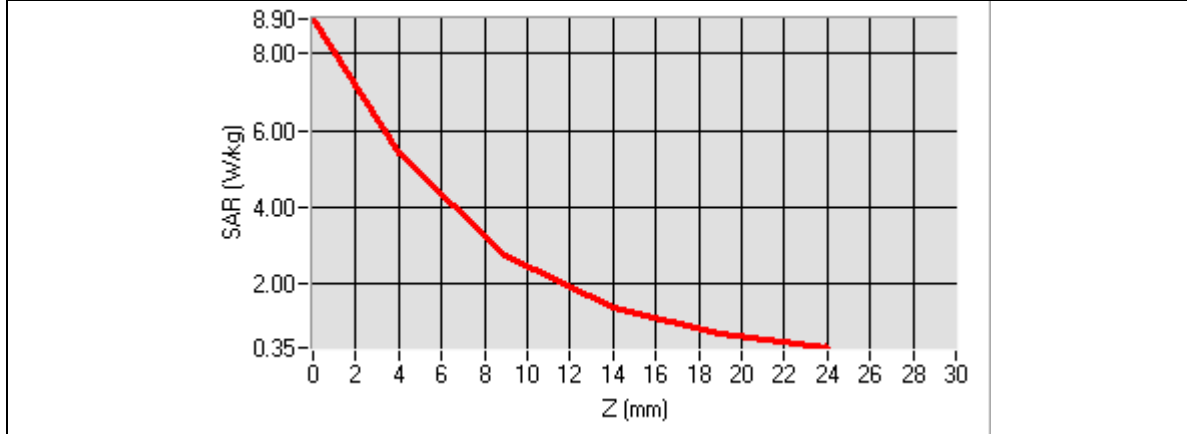

3D screen shot	Hot spot position

11. SAR TEST DATA

WIFI

MEASUREMENT 1 Date of measurement: 2016/08/22

Area Scan	<u>sam_direct_droit2_surf8mm.txt, h= 5.00 mm</u>
ZoomScan	<u>7x7x7,dx=5mm dy=5mm dz=5mm, sam_direct_droit2_surf8mm.txt, h= 5.00 mm</u>
Phantom	<u>Right head</u>
Device Position	<u>Cheek</u>
Band	<u>CUSTOM (WIFI)</u>
Channels	<u>Low</u>
Signal	<u>Duty Cycle: 1.00 (Crest factor: 1.0)</u>

Frequency (MHz)	2412.000000
Relative permittivity (real part)	39.267555
Relative permittivity (imaginary part)	13.167644
Conductivity (S/m)	1.764464
Variation (%)	-0.420000

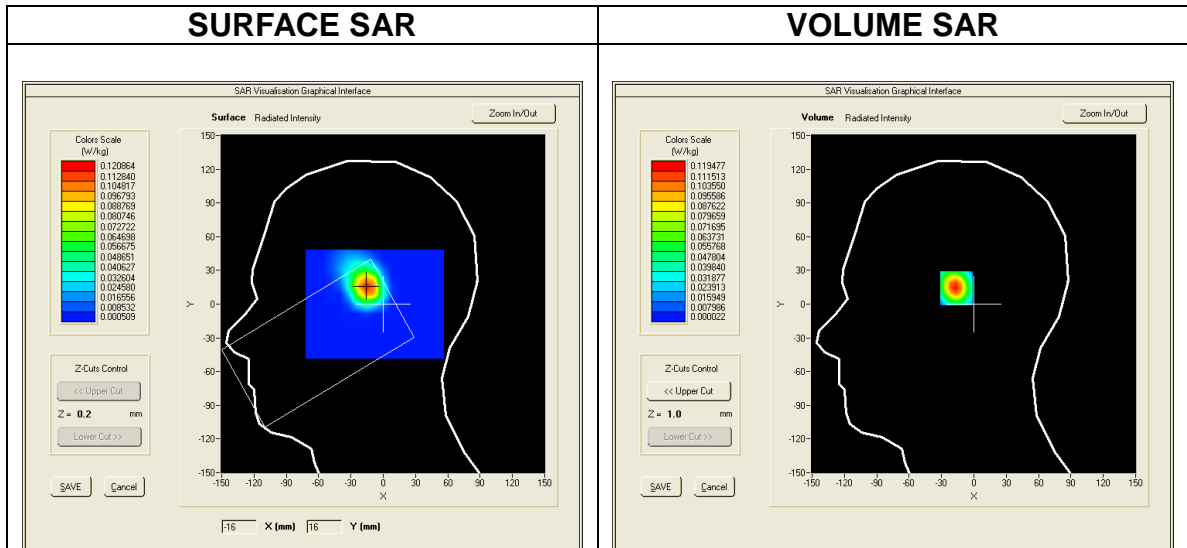

Maximum location: X=-45.00, Y=8.00
SAR Peak: 0.39 W/kg

SAR 10g (W/Kg)	0.094366
SAR 1g (W/Kg)	0.201461

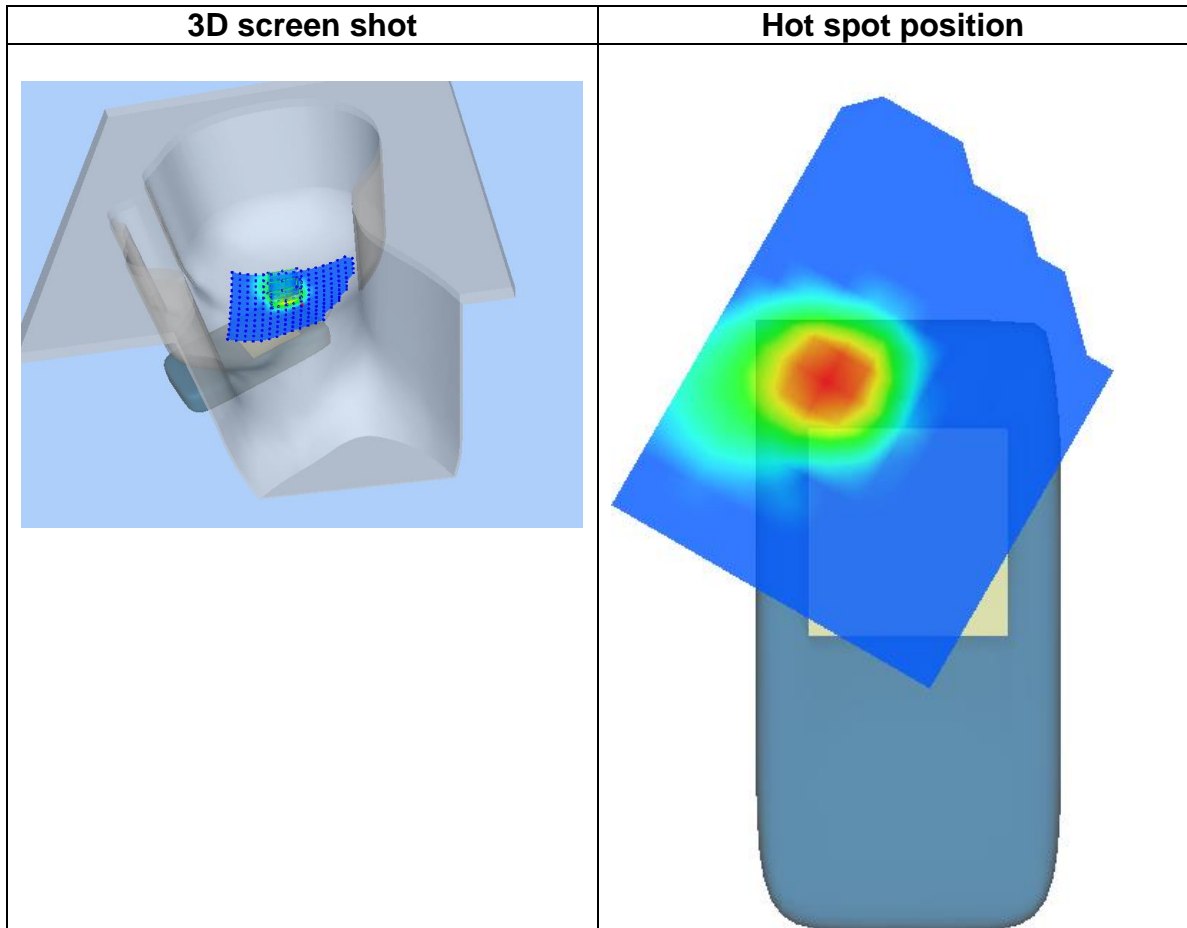
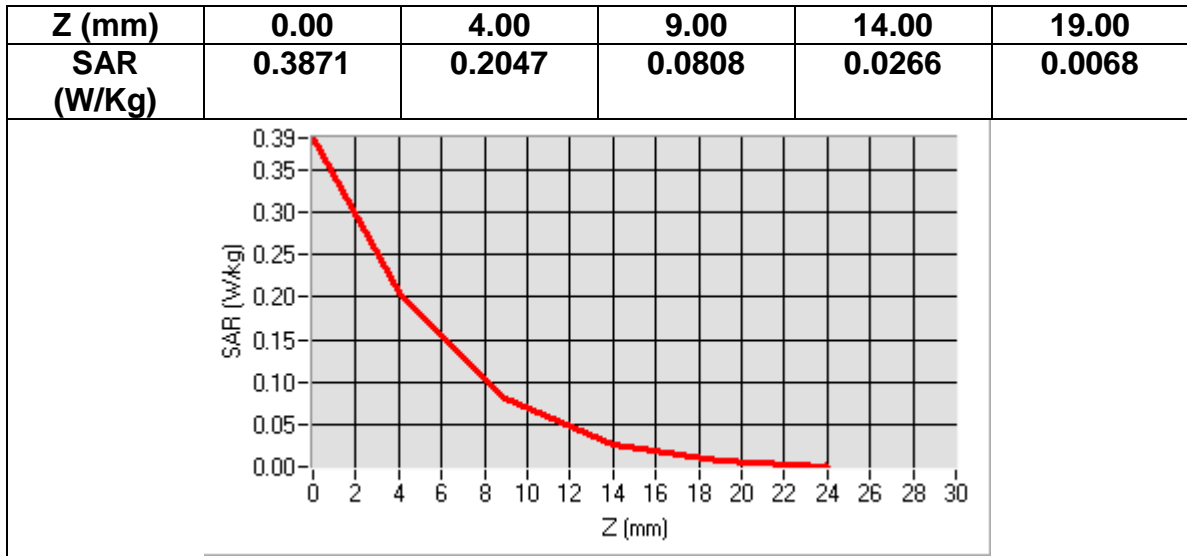

MEASUREMENT 2
 Date of measurement: 2016/08/22

Area Scan	<u>sam_direct_droit2_surf8mm.txt, h= 5.00 mm</u>
ZoomScan	<u>7x7x7,dx=5mm dy=5mm dz=5mm, sam_direct_droit2_surf8mm.txt, h= 5.00 mm</u>
Phantom	<u>Right head</u>
Device Position	<u>Cheek</u>
Band	<u>CUSTOM (WIFI)</u>
Channels	<u>Middle</u>
Signal	<u>Duty Cycle: 1.00 (Crest factor: 1.0)</u>

Frequency (MHz)	2437.000000
Relative permittivity (real part)	39.214222
Relative permittivity (imaginary part)	13.208978
Conductivity (S/m)	1.792018
Variation (%)	-0.420000

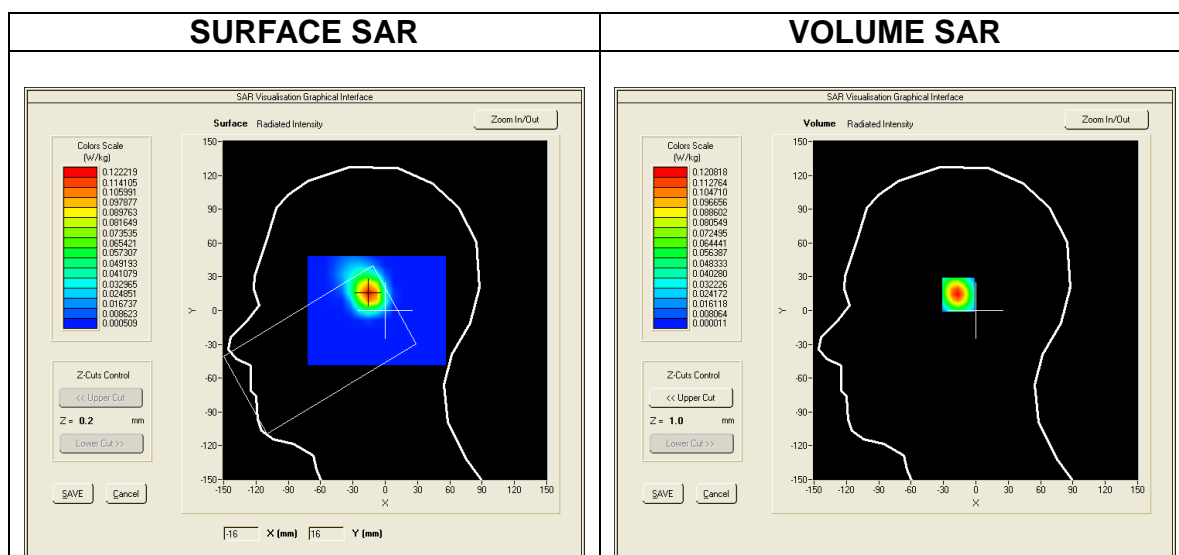

Maximum location: X=-48.00, Y=16.00
SAR Peak: 0.45 W/kg

SAR 10g (W/Kg)	0.101701
SAR 1g (W/Kg)	0.221933

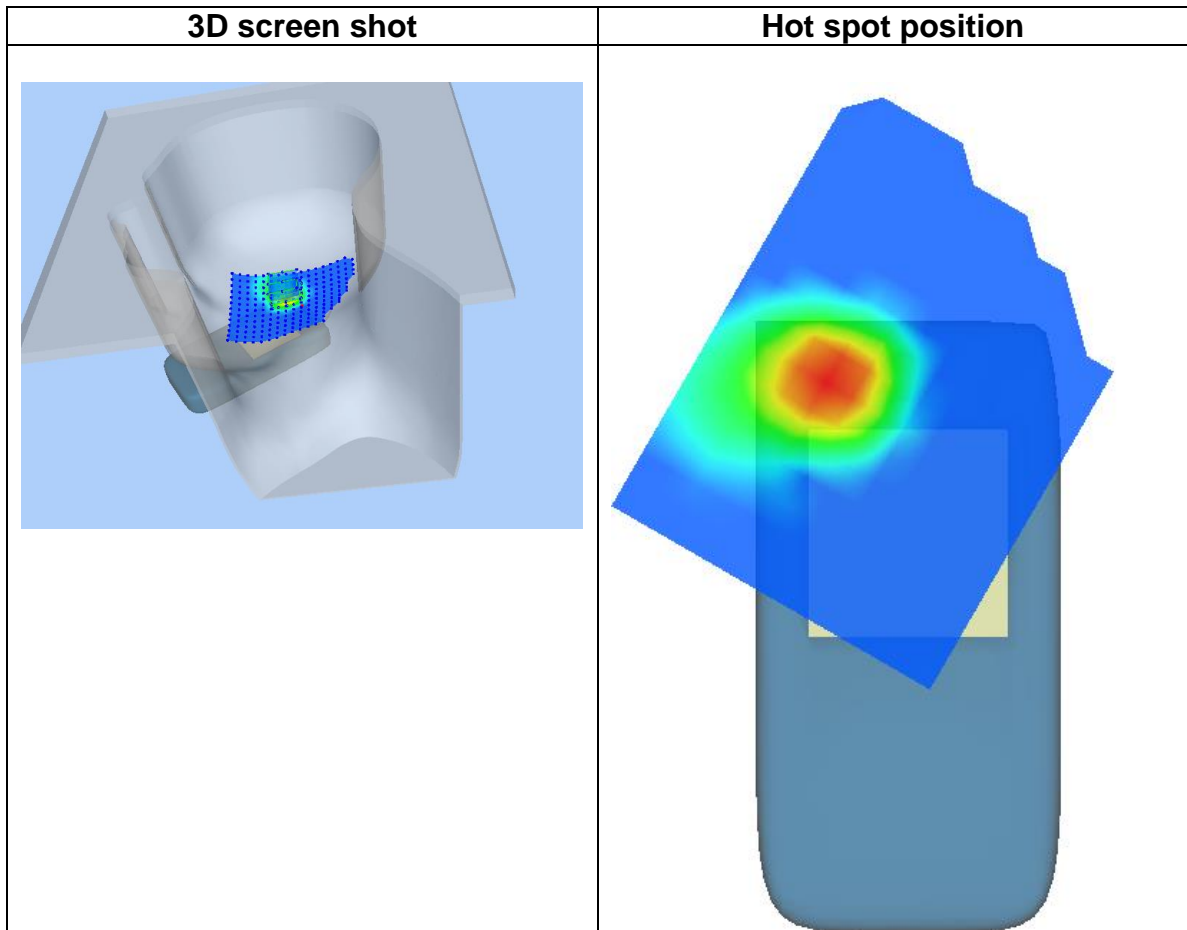
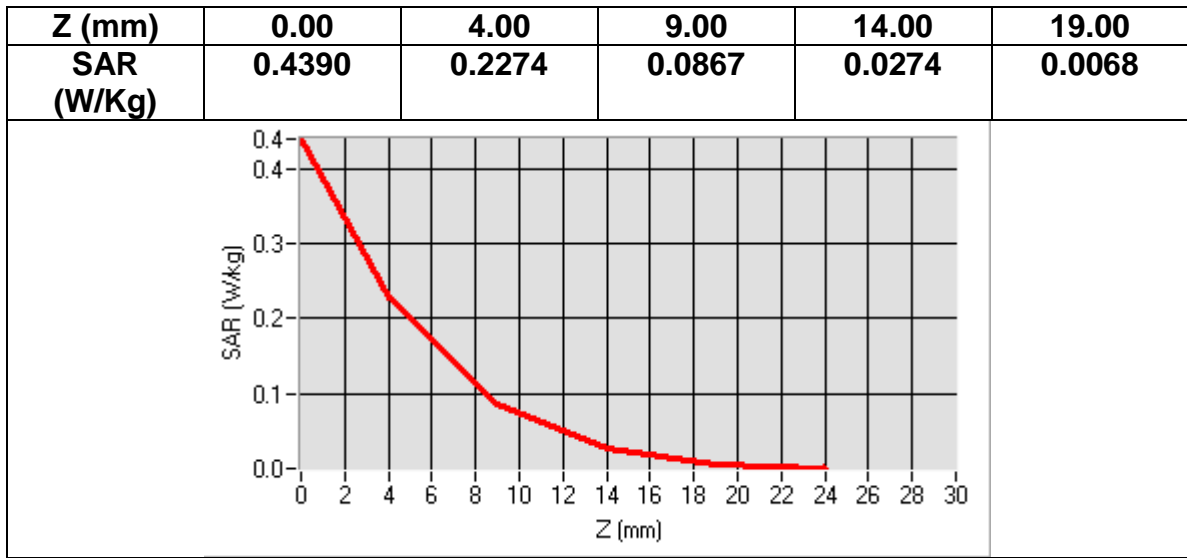

MEASUREMENT 3
Date of measurement: 2016/08/22

Area Scan	<u>sam_direct_droit2_surf8mm.txt, h= 5.00 mm</u>
ZoomScan	<u>7x7x7,dx=5mm dy=5mm dz=5mm, sam_direct_droit2_surf8mm.txt, h= 5.00 mm</u>
Phantom	<u>Right head</u>
Device Position	<u>Cheek</u>
Band	<u>CUSTOM (WIFI)</u>
Channels	<u>High</u>
Signal	<u>Duty Cycle: 1.00 (Crest factor: 1.0)</u>

Frequency (MHz)	2462.000000
Relative permittivity (real part)	39.172001
Relative permittivity (imaginary part)	13.267200
Conductivity (S/m)	1.822029
Variation (%)	-0.020000

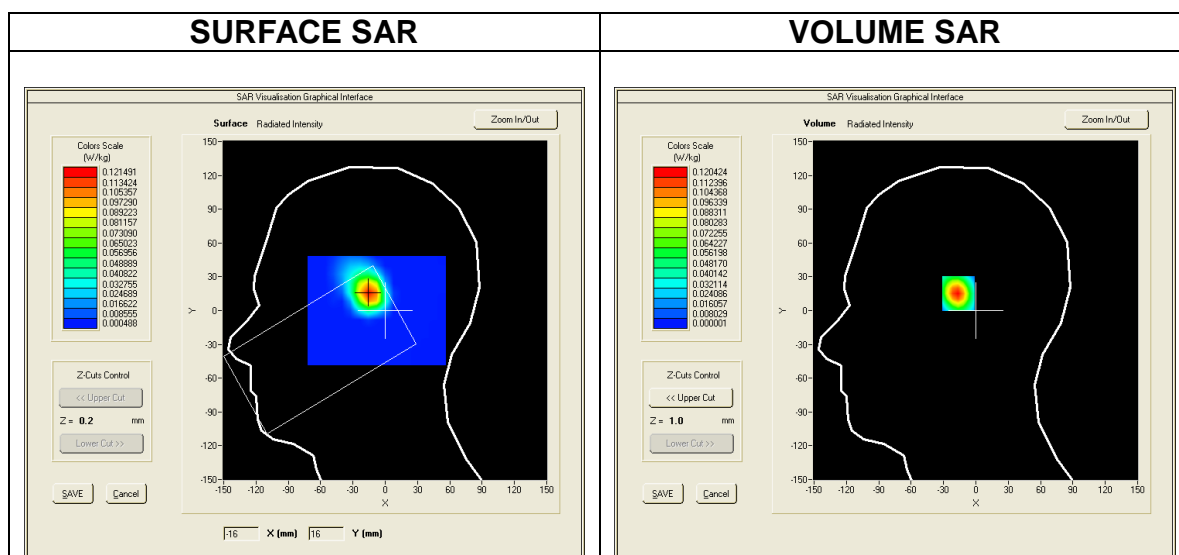

Maximum location: X=-48.00, Y=16.00
SAR Peak: 0.28 W/kg

SAR 10g (W/Kg)	0.052746
SAR 1g (W/Kg)	0.123820

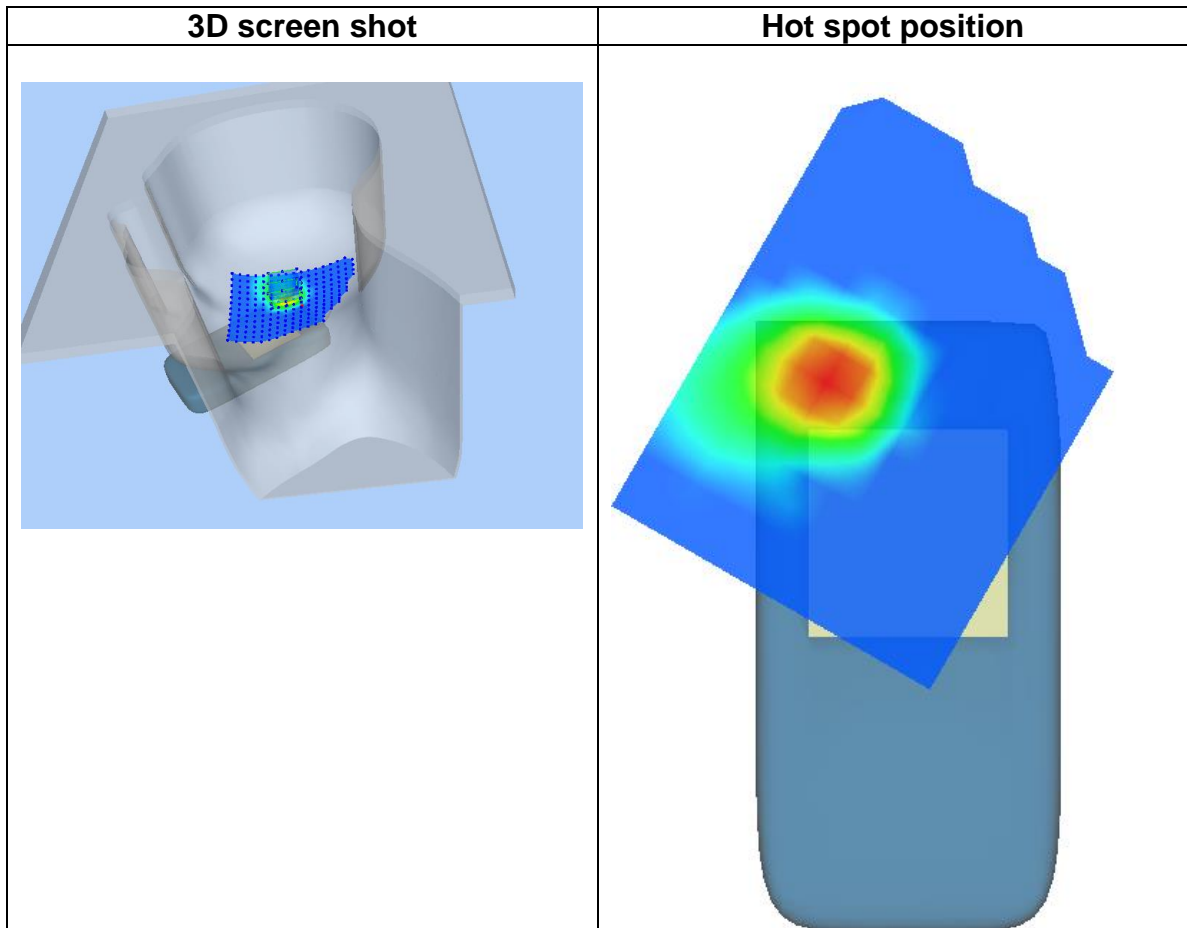
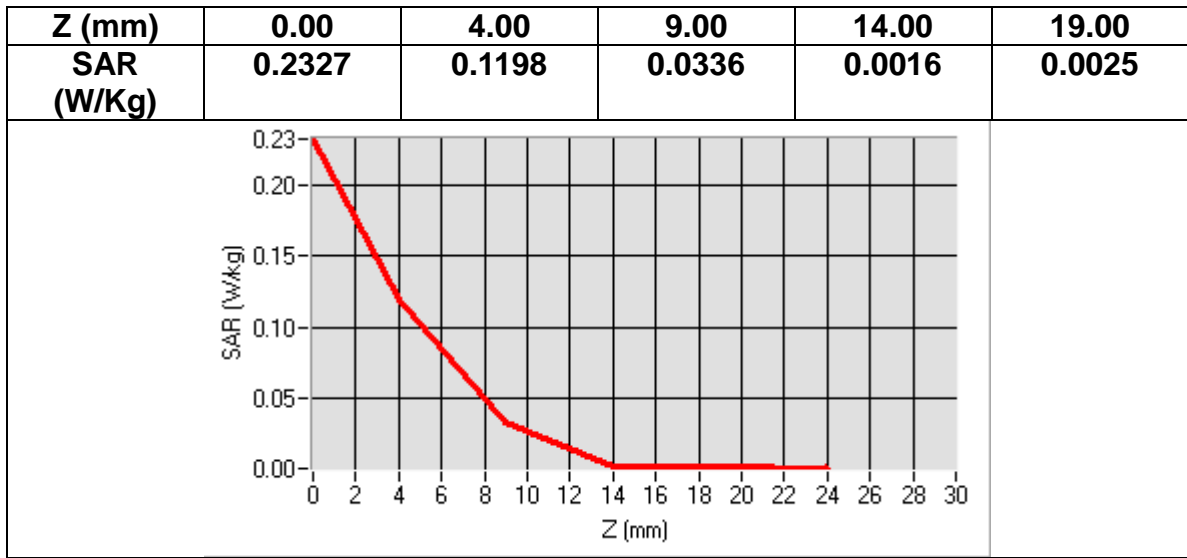

MEASUREMENT 4
Date of measurement: 2016/08/22

Area Scan	<u>sam_direct_droit2_surf8mm.txt, h= 5.00 mm</u>
ZoomScan	<u>7x7x7,dx=5mm dy=5mm dz=5mm, sam_direct_droit2_surf8mm.txt, h= 5.00 mm</u>
Phantom	<u>Left head</u>
Device Position	<u>Cheek</u>
Band	<u>CUSTOM (WIFI)</u>
Channels	<u>Low</u>
Signal	<u>Duty Cycle: 1.00 (Crest factor: 1.0)</u>

Frequency (MHz)	2412.000000
Relative permittivity (real part)	39.267555
Relative permittivity (imaginary part)	13.167644
Conductivity (S/m)	1.764464
Variation (%)	3.330000

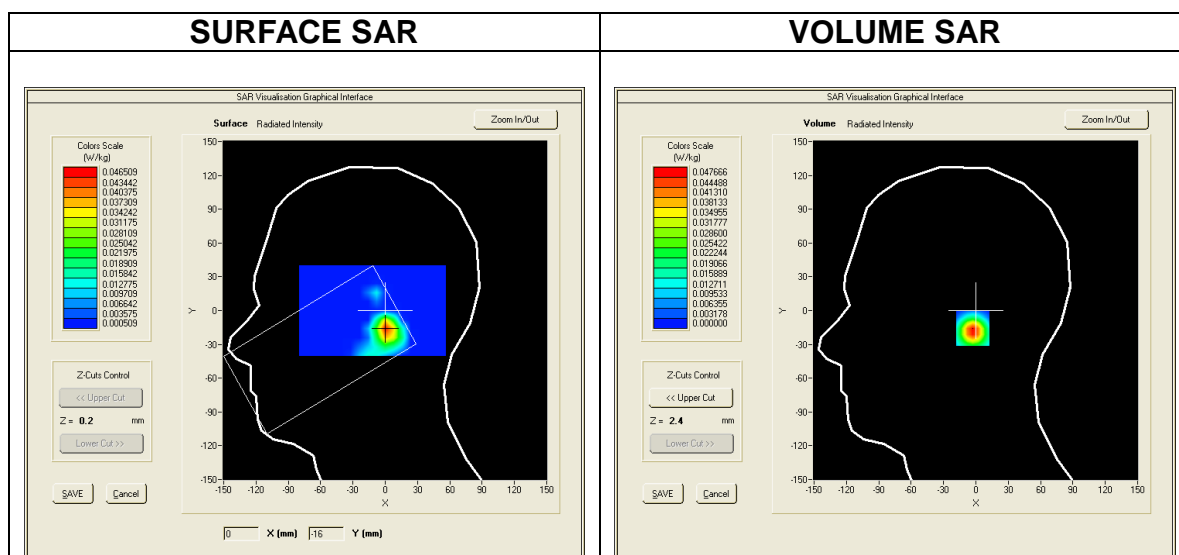

Maximum location: X=-30.00, Y=-55.00
SAR Peak: 0.31 W/kg

SAR 10g (W/Kg)	0.067628
SAR 1g (W/Kg)	0.153251

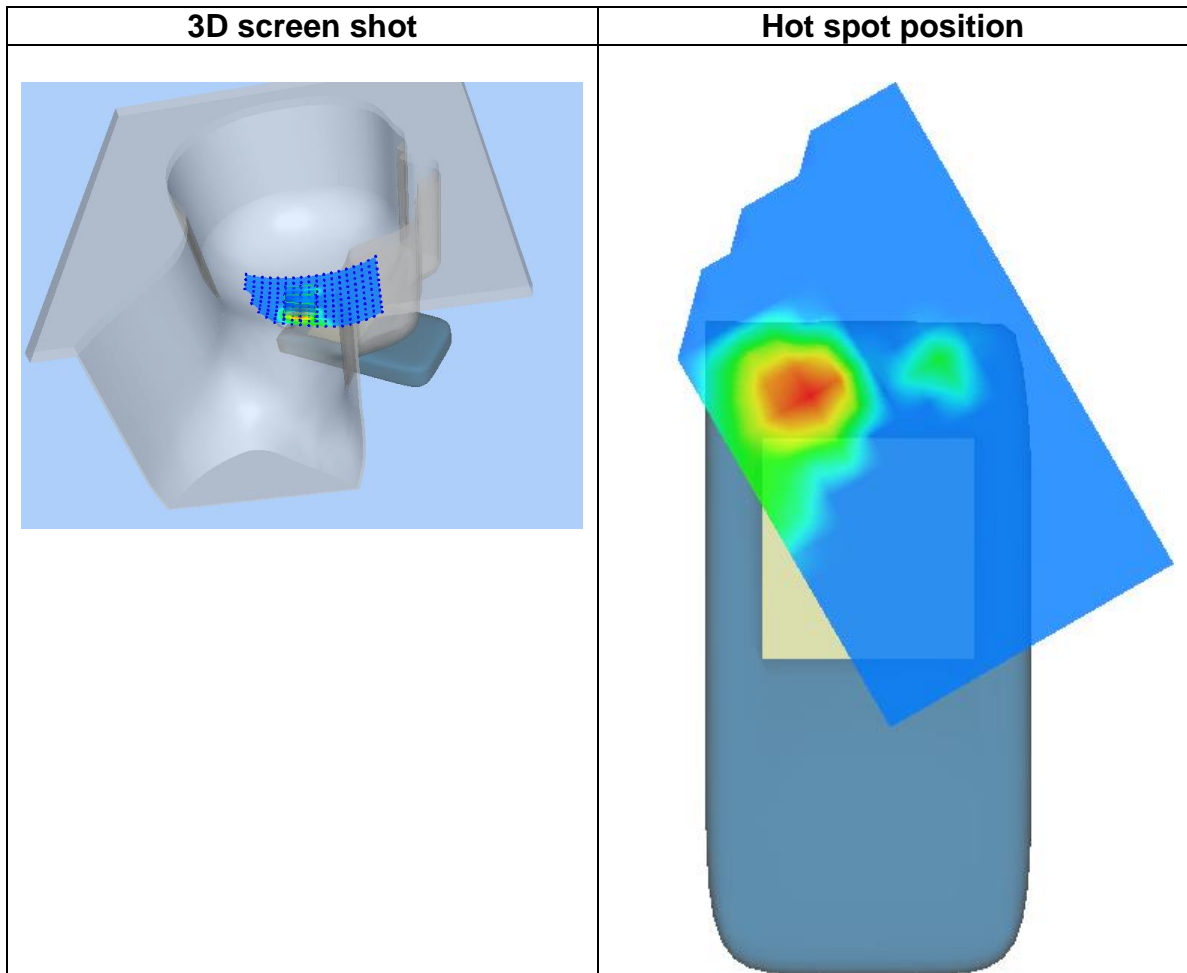
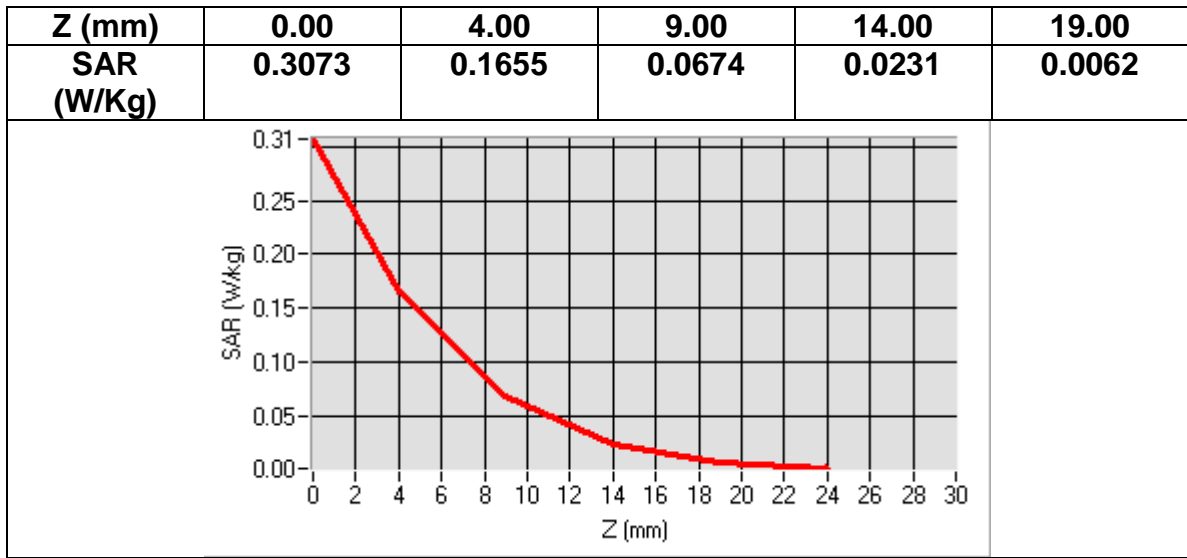

MEASUREMENT 5
Date of measurement: 2016/08/22

Area Scan	<u>sam_direct_droit2_surf8mm.txt, h= 5.00 mm</u>
ZoomScan	<u>7x7x7,dx=5mm dy=5mm dz=5mm, sam_direct_droit2_surf8mm.txt, h= 5.00 mm</u>
Phantom	<u>Left head</u>
Device Position	<u>Cheek</u>
Band	<u>CUSTOM (WIFI)</u>
Channels	<u>Middle</u>
Signal	<u>Duty Cycle: 1.00 (Crest factor: 1.0)</u>

Frequency (MHz)	2437.000000
Relative permittivity (real part)	39.214222
Relative permittivity (imaginary part)	13.208978
Conductivity (S/m)	1.792018
Variation (%)	3.490000

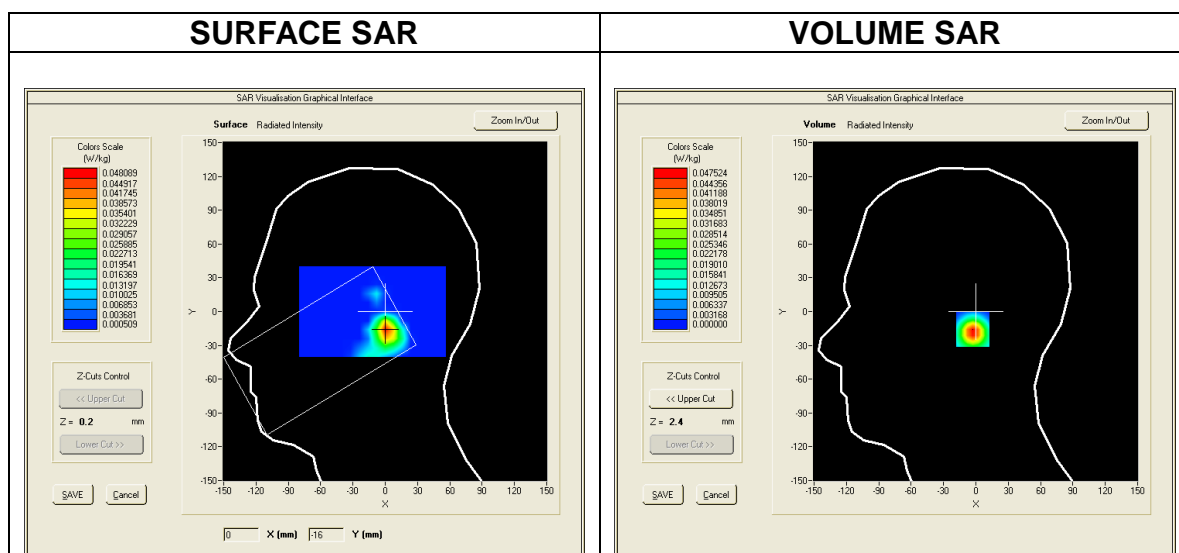

Maximum location: X=-29.00, Y=-55.00
SAR Peak: 0.33 W/kg

SAR 10g (W/Kg)	0.071039
SAR 1g (W/Kg)	0.161836

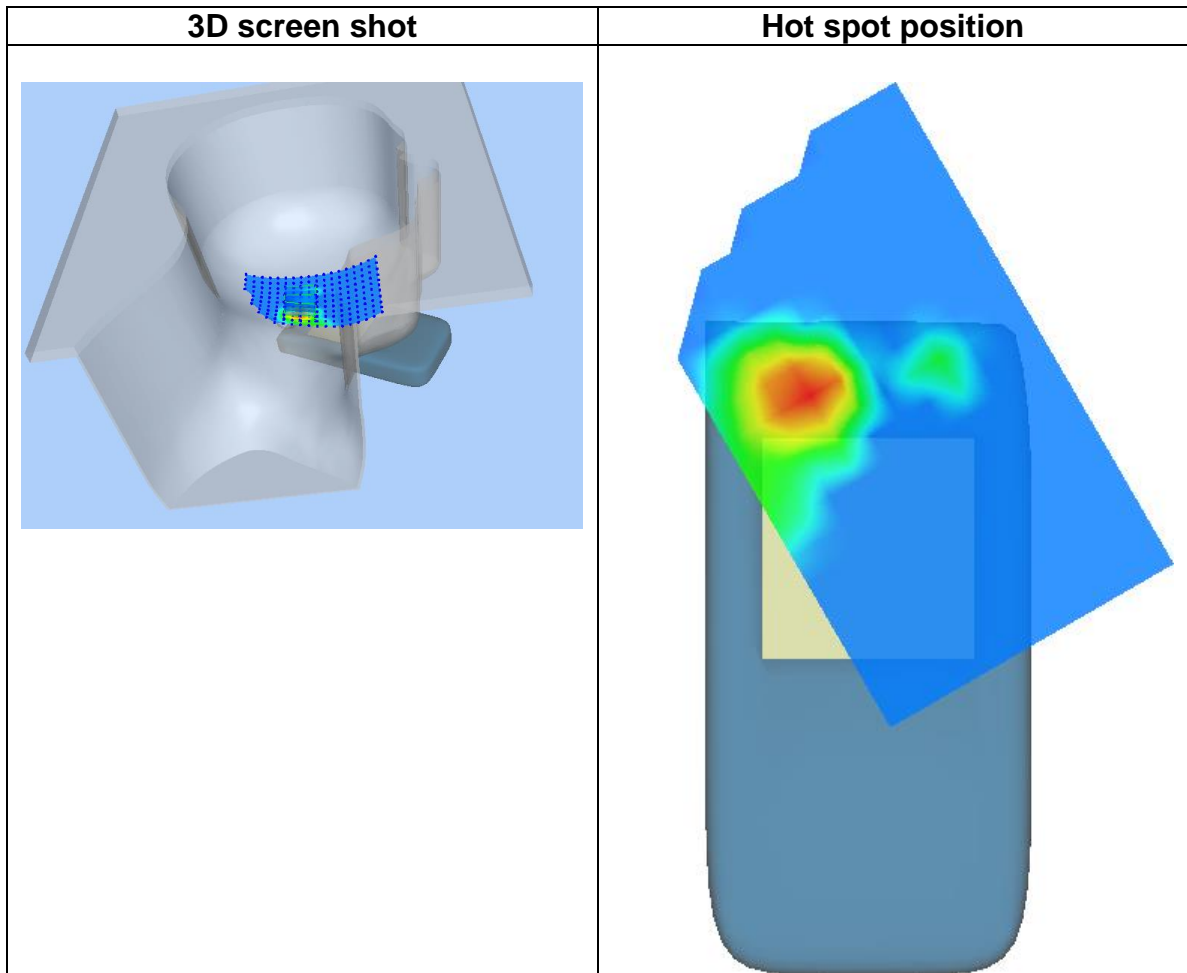
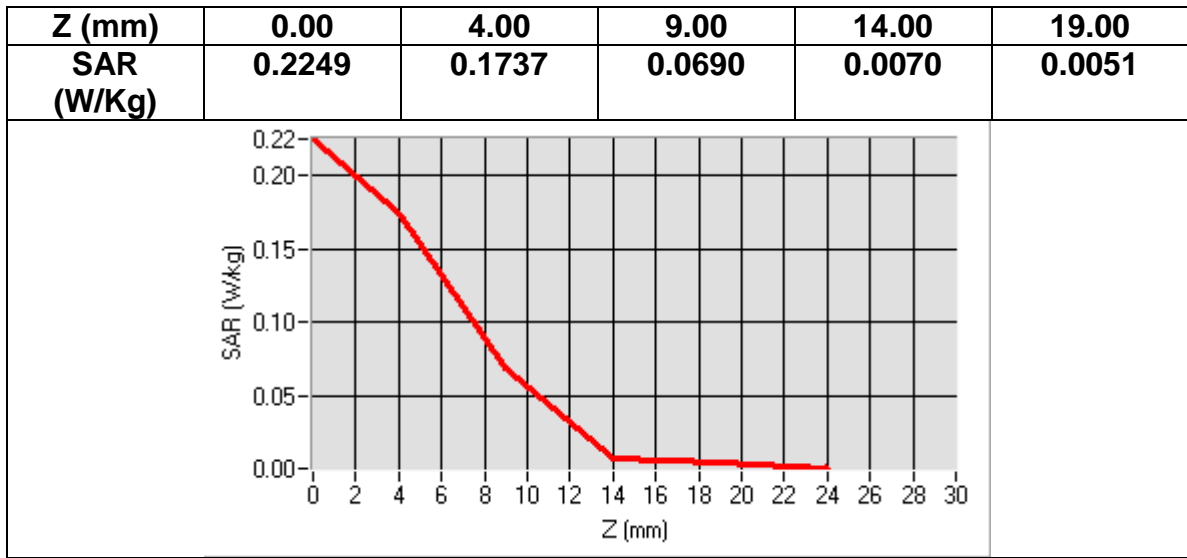

MEASUREMENT 6
Date of measurement: 2016/08/22

Area Scan	<u>sam_direct_droit2_surf8mm.txt, h= 5.00 mm</u>
ZoomScan	<u>7x7x7,dx=5mm dy=5mm dz=5mm,</u> <u>sam_direct_droit2_surf8mm.txt, h= 5.00 mm</u>
Phantom	<u>Left head</u>
Device Position	<u>Cheek</u>
Band	<u>CUSTOM (WIFI)</u>
Channels	<u>High</u>
Signal	<u>Duty Cycle: 1.00 (Crest factor: 1.0)</u>

Frequency (MHz)	2462.000000
Relative permittivity (real part)	39.172001
Relative permittivity (imaginary part)	13.267200
Conductivity (S/m)	1.822029
Variation (%)	2.170000

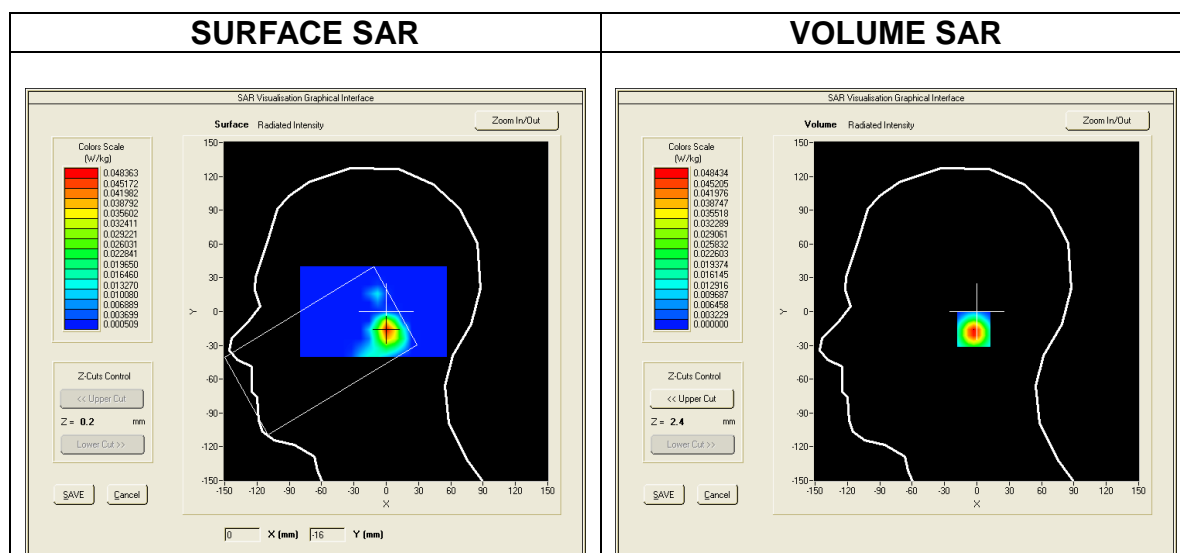

Maximum location: X=-29.00, Y=-55.00
SAR Peak: 0.18 W/kg

SAR 10g (W/Kg)	0.033267
SAR 1g (W/Kg)	0.081233

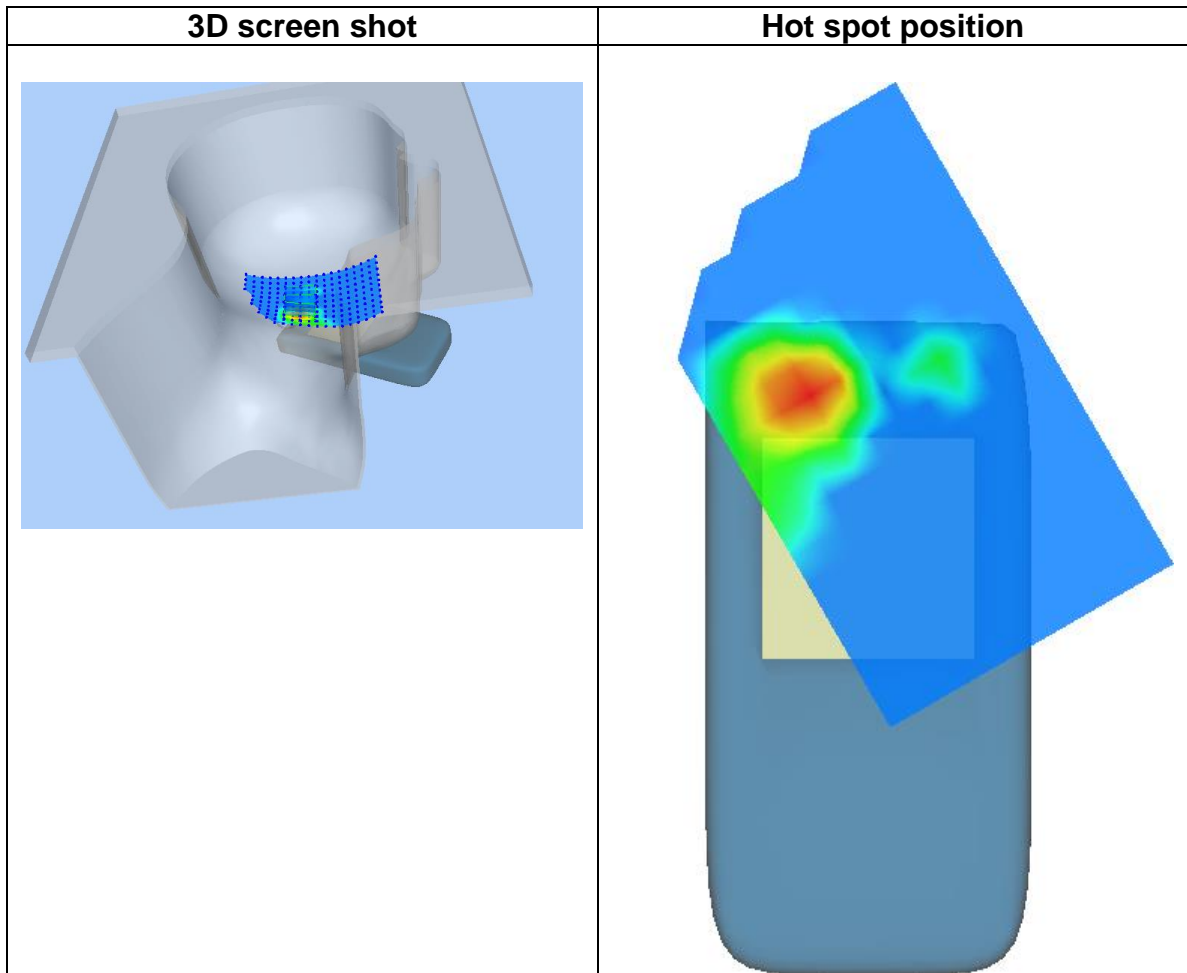
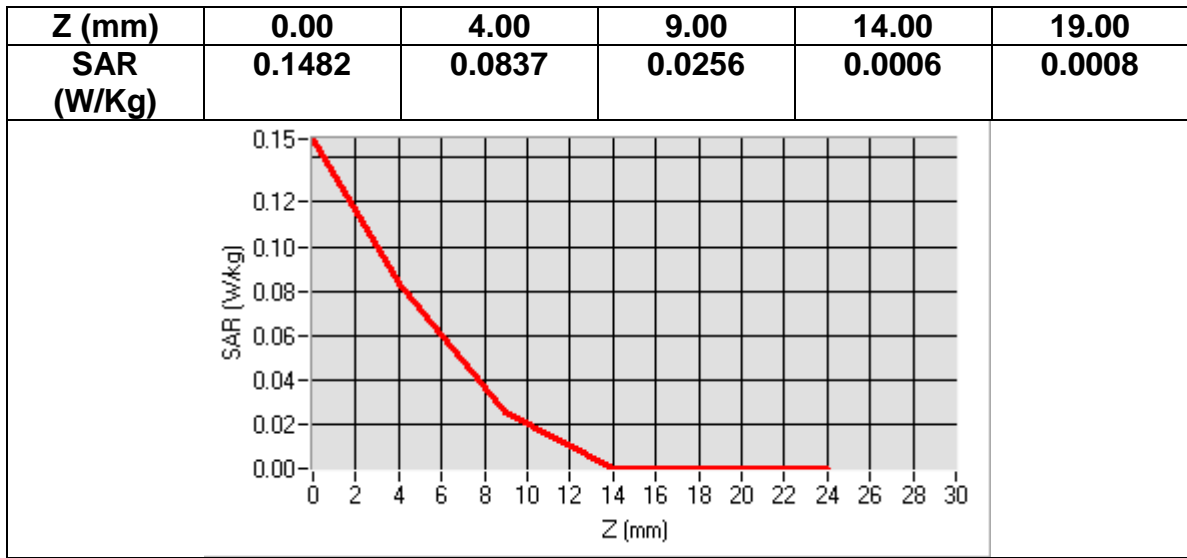

MEASUREMENT 7
Date of measurement: 2016/08/22

Area Scan	<u>dx=8mm dy=8mm, h= 5.00 mm</u>
ZoomScan	<u>7x7x7,dx=5mm dy=5mm dz=5mm,</u> <u>dx=8mm dy=8mm, h= 5.00 mm</u>
Phantom	<u>ELLI16</u>
Device Position	<u>FRONT BODY</u>
Band	<u>CUSTOM (WIFI)</u>
Channels	<u>Low</u>
Signal	<u>Duty Cycle: 1.00 (Crest factor: 1.0)</u>

Frequency (MHz)	2412.000000
Relative permittivity (real part)	52.750668
Relative permittivity (imaginary part)	14.275111
Conductivity (S/m)	1.912865
Variation (%)	-3.620000

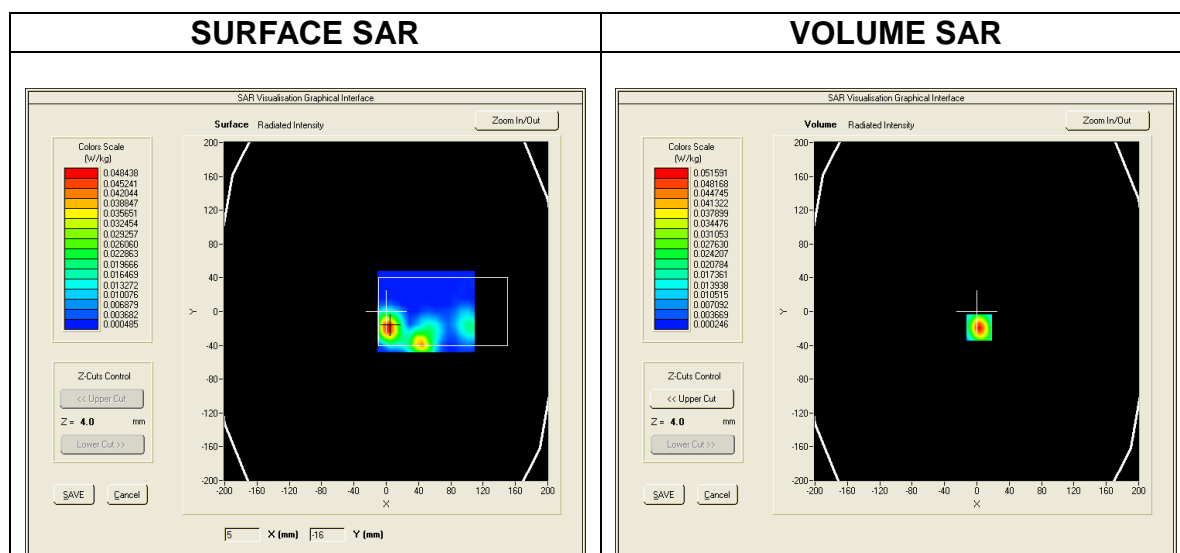

Maximum location: X=36.00, Y=-33.00
SAR Peak: 0.05 W/kg

SAR 10g (W/Kg)	0.013503
SAR 1g (W/Kg)	0.024756

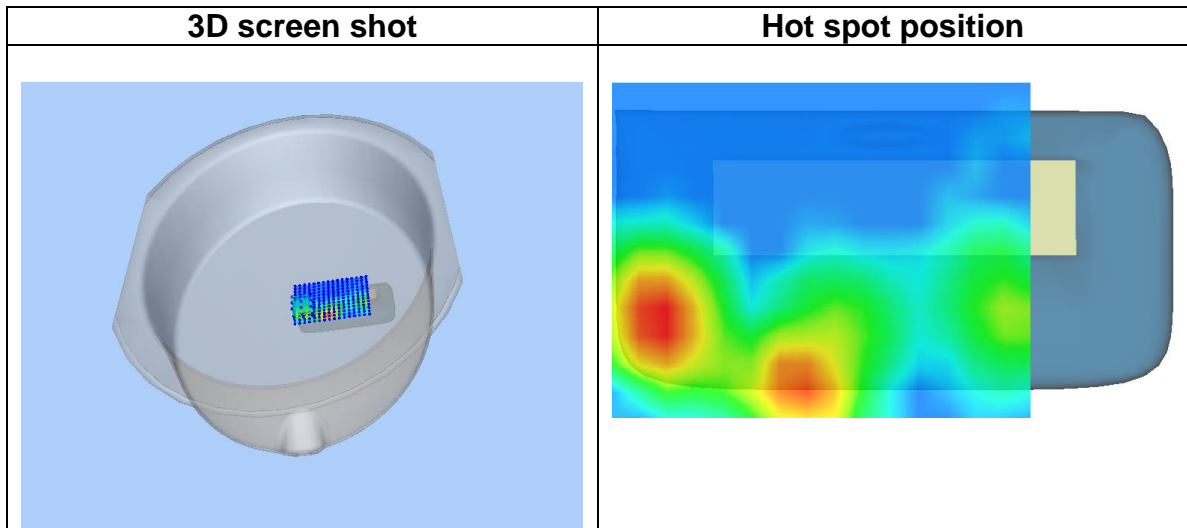
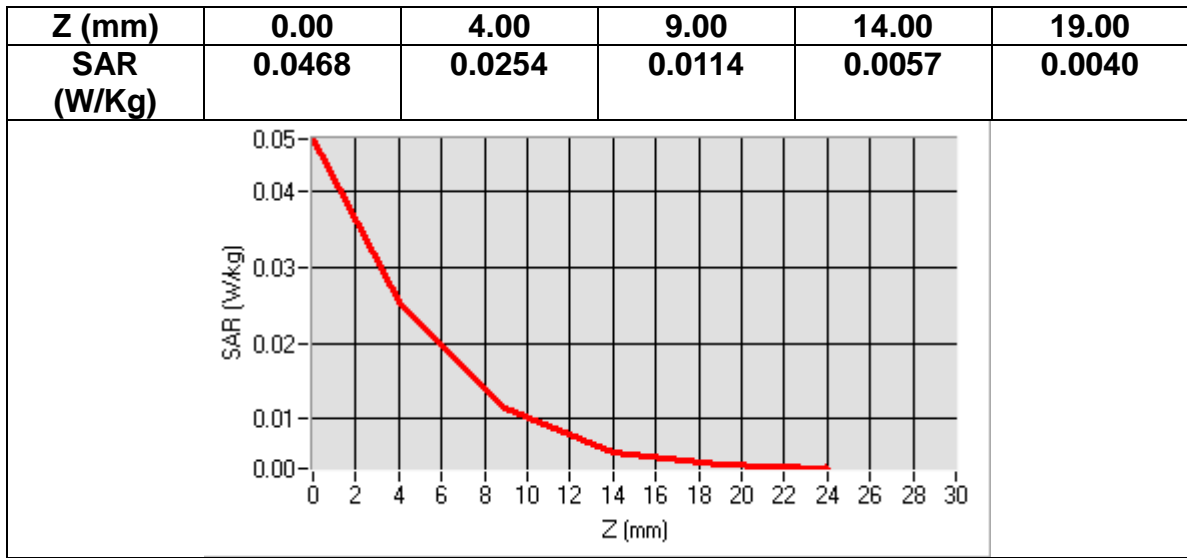

MEASUREMENT 8
Date of measurement: 2016/08/22

Area Scan	<u>dx=8mm dy=8mm, h= 5.00 mm</u>
ZoomScan	<u>7x7x7,dx=5mm dy=5mm dz=5mm, dx=8mm dy=8mm, h= 5.00 mm</u>
Phantom	<u>ELLI16</u>
Device Position	<u>FRONT BODY</u>
Band	<u>CUSTOM (WIFI)</u>
Channels	<u>Middle</u>
Signal	<u>Duty Cycle: 1.00 (Crest factor: 1.0)</u>

Frequency (MHz)	2437.000000
Relative permittivity (real part)	52.710667
Relative permittivity (imaginary part)	14.318444
Conductivity (S/m)	1.942536
Variation (%)	-0.420000

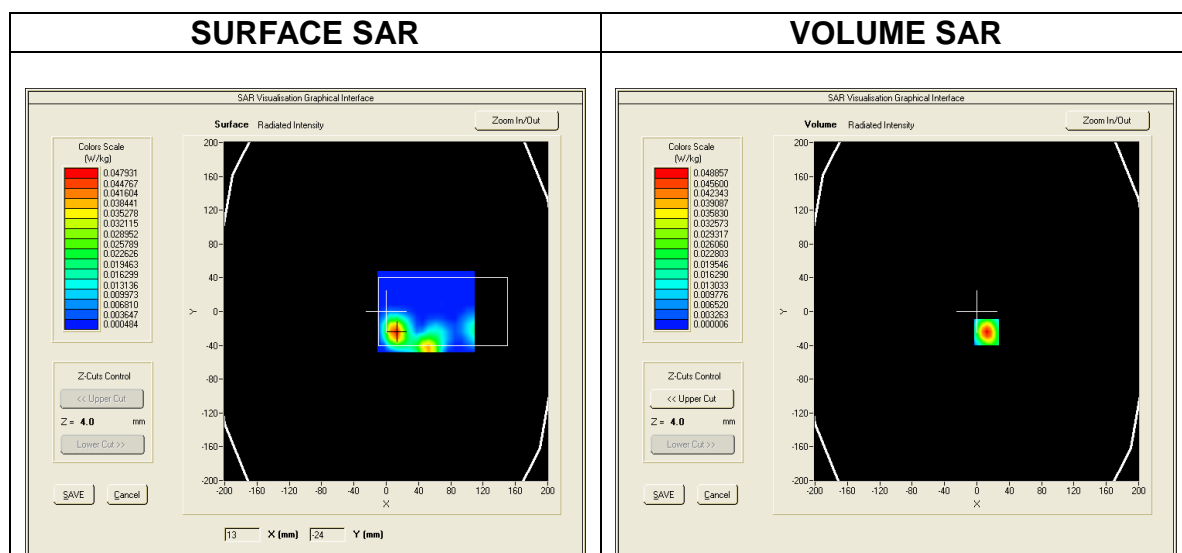

Maximum location: X=38.00, Y=-32.00
SAR Peak: 0.05 W/kg

SAR 10g (W/Kg)	0.007754
SAR 1g (W/Kg)	0.018923

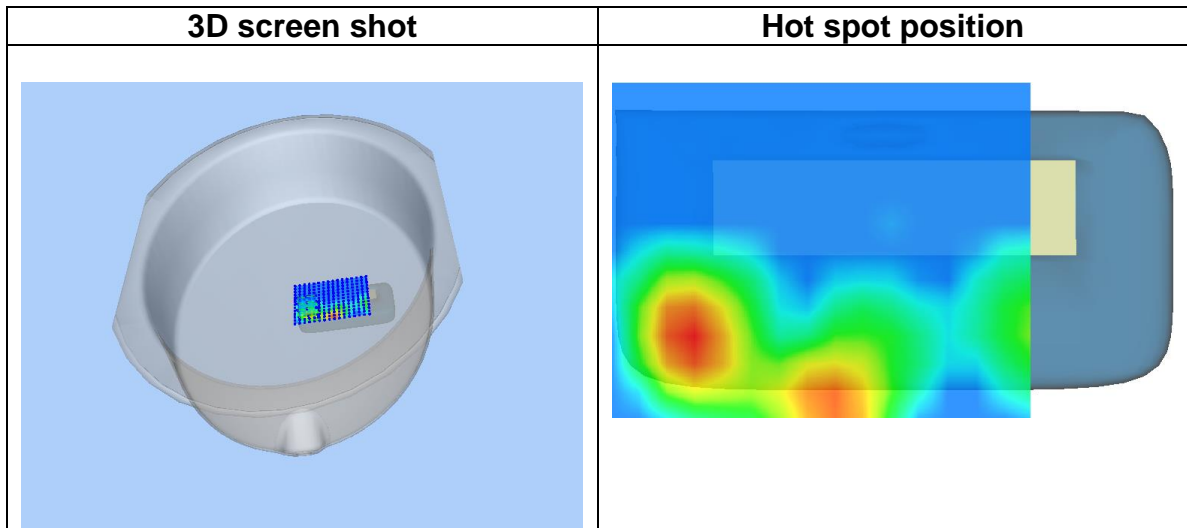
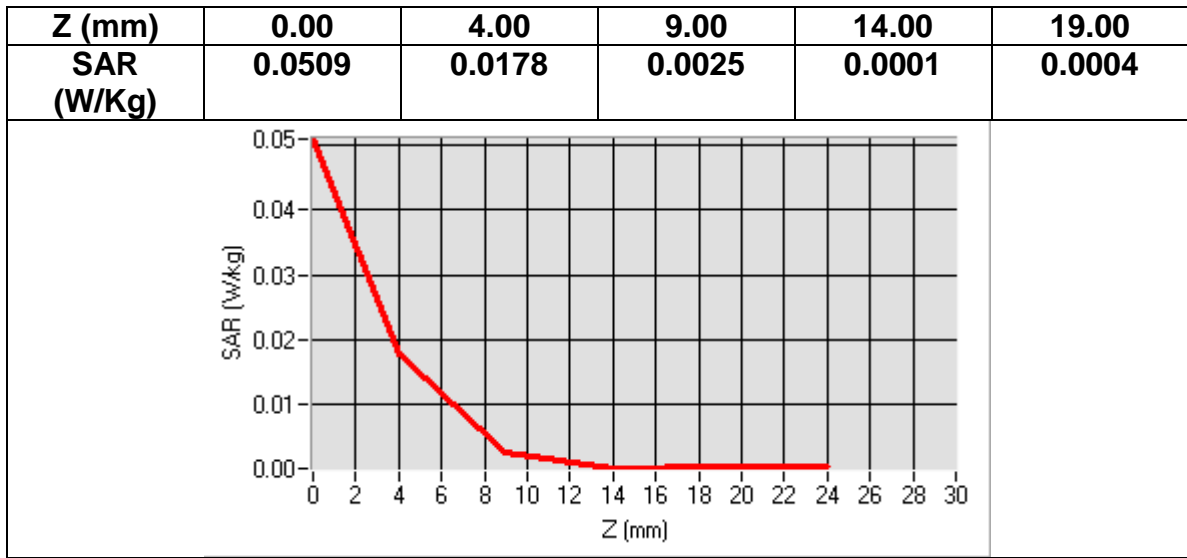

MEASUREMENT 9
 Date of measurement: 2016/08/22

Area Scan	<u>dx=8mm dy=8mm, h= 5.00 mm</u>
ZoomScan	<u>7x7x7,dx=5mm dy=5mm dz=5mm,</u> <u>dx=8mm dy=8mm, h= 5.00 mm</u>
Phantom	<u>ELLI16</u>
Device Position	<u>FRONT BODY</u>
Band	<u>CUSTOM (WIFI)</u>
Channels	<u>High</u>
Signal	<u>Duty Cycle: 1.00 (Crest factor: 1.0)</u>

Frequency (MHz)	2462.000000
Relative permittivity (real part)	52.672001
Relative permittivity (imaginary part)	14.412000
Conductivity (S/m)	1.979248
Variation (%)	-0.620000

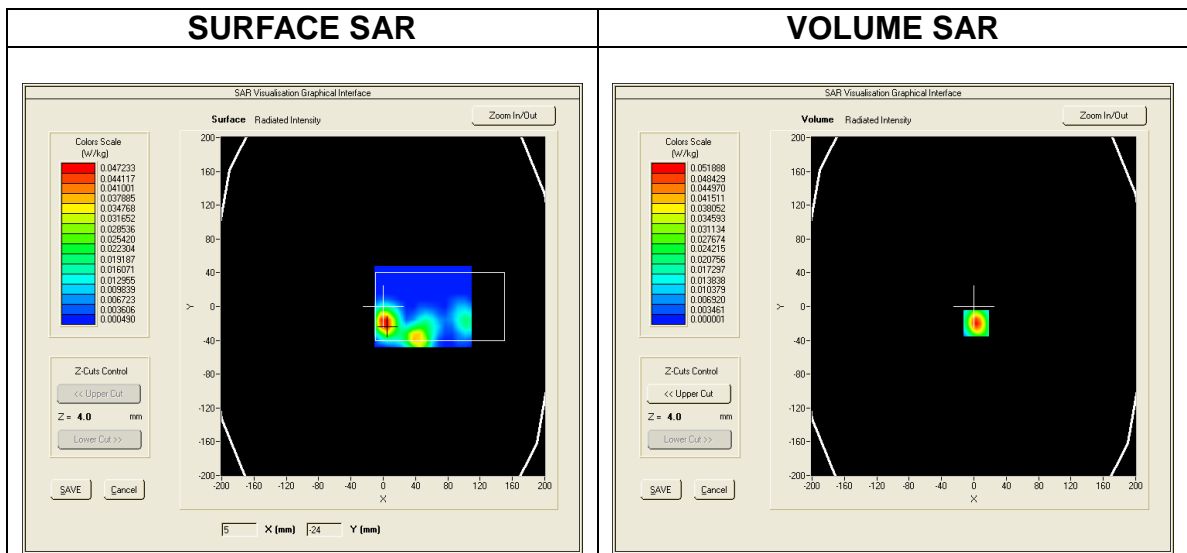

Maximum location: X=46.00, Y=-39.00
SAR Peak: 0.03 W/kg

SAR 10g (W/Kg)	0.003524
SAR 1g (W/Kg)	0.009574

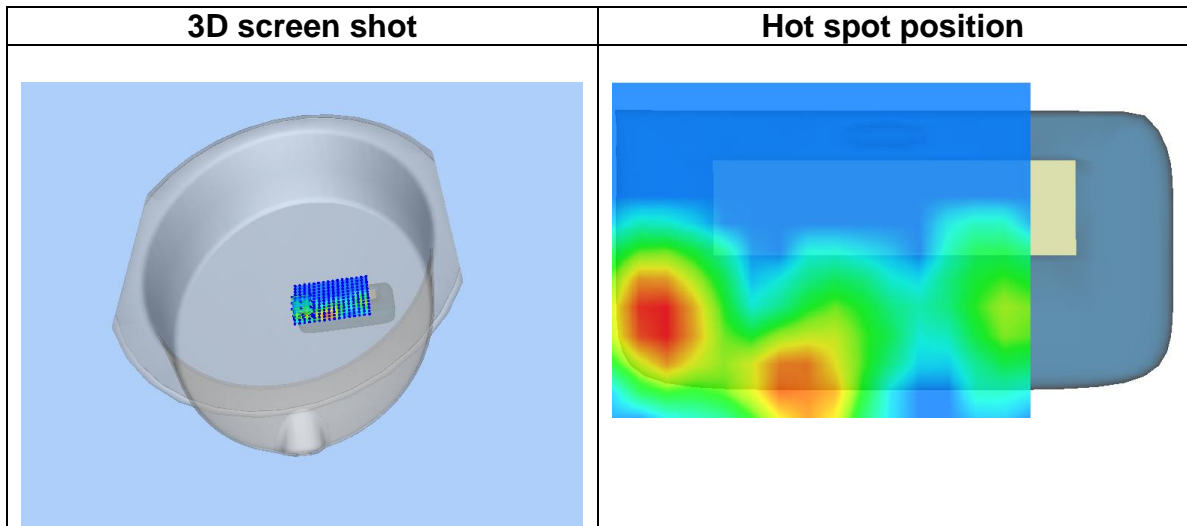
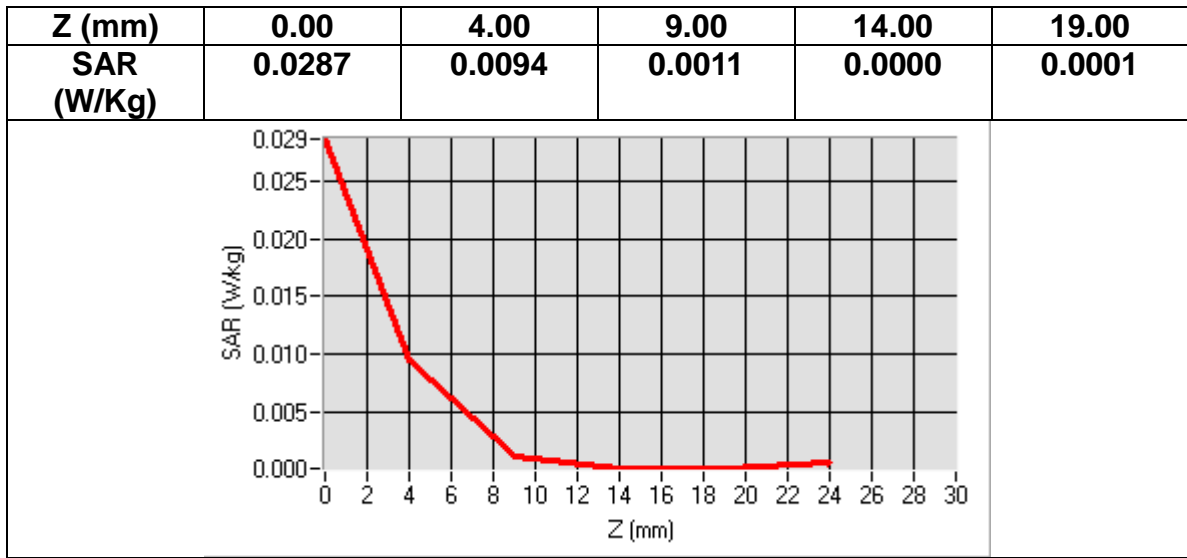

MEASUREMENT 10
Date of measurement: 2016/08/22

Area Scan	<u>dx=8mm dy=8mm, h= 5.00 mm</u>
ZoomScan	<u>7x7x7,dx=5mm dy=5mm dz=5mm, dx=8mm dy=8mm, h= 5.00 mm</u>
Phantom	<u>ELLI16</u>
Device Position	<u>BACK BODY</u>
Band	<u>CUSTOM (WIFI)</u>
Channels	<u>Low</u>
Signal	<u>Duty Cycle: 1.00 (Crest factor: 1.0)</u>

Frequency (MHz)	2412.000000
Relative permittivity (real part)	52.750668
Relative permittivity (imaginary part)	14.275111
Conductivity (S/m)	1.912865
Variation (%)	-3.020000

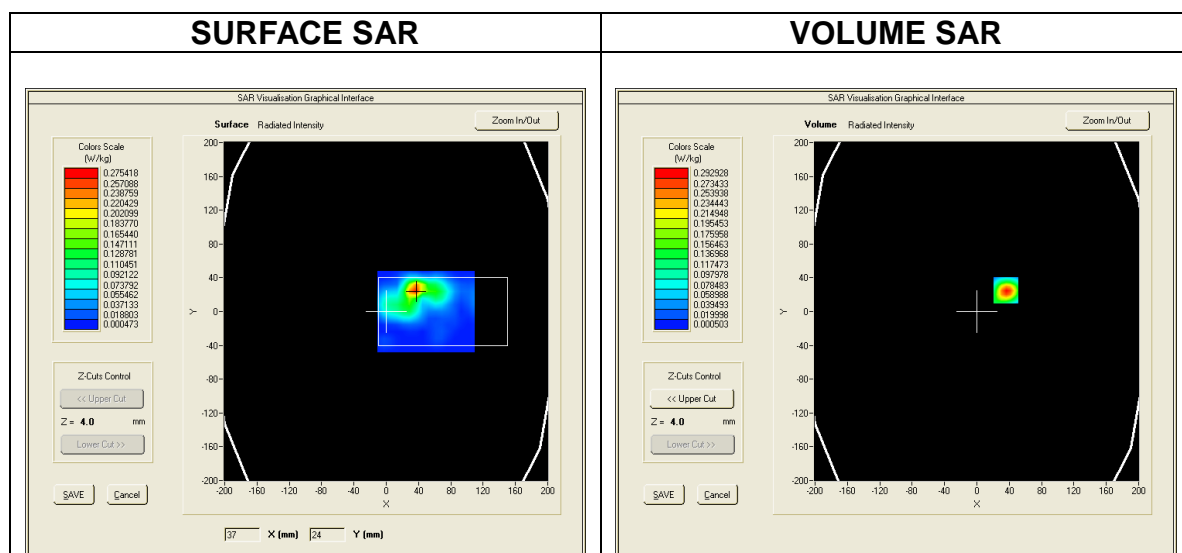

Maximum location: X=-28.00, Y=-40.00
SAR Peak: 0.49 W/kg

SAR 10g (W/Kg)	0.109112
SAR 1g (W/Kg)	0.253398

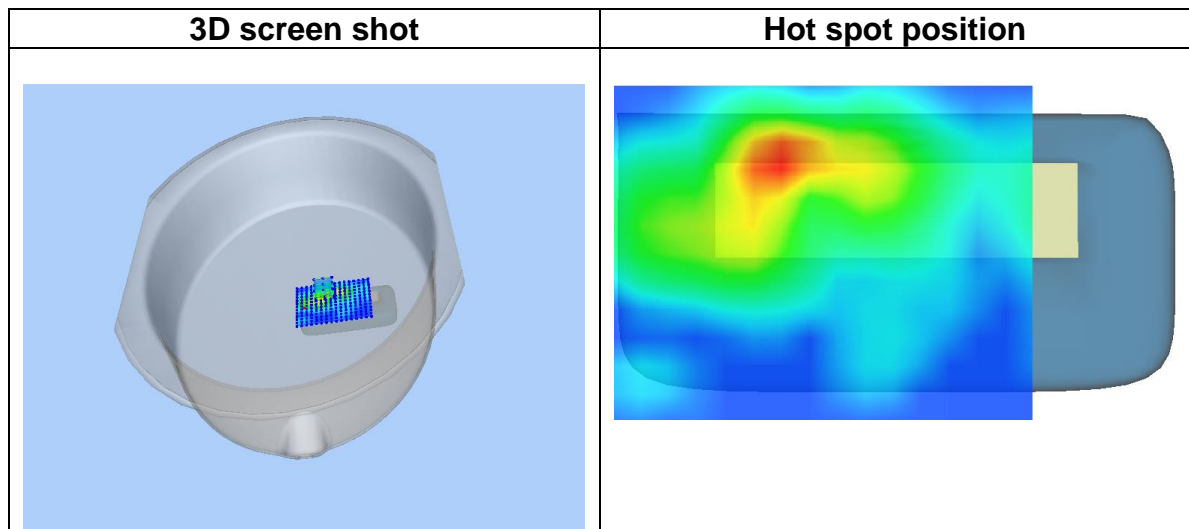
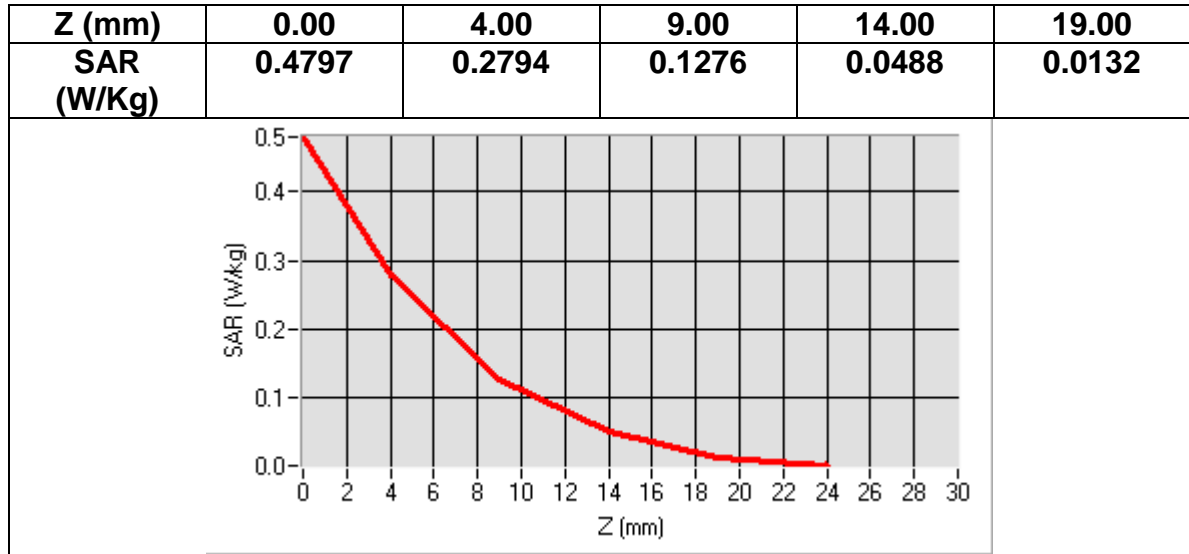

MEASUREMENT 11
Date of measurement: 2016/08/22

Area Scan	<u>dx=8mm dy=8mm, h= 5.00 mm</u>
ZoomScan	<u>7x7x7,dx=5mm dy=5mm dz=5mm, dx=8mm dy=8mm, h= 5.00 mm</u>
Phantom	<u>ELLI16</u>
Device Position	<u>BACK BODY</u>
Band	<u>CUSTOM (WIFI)</u>
Channels	<u>Middle</u>
Signal	<u>Duty Cycle: 1.00 (Crest factor: 1.0)</u>

Frequency (MHz)	2437.000000
Relative permittivity (real part)	52.710667
Relative permittivity (imaginary part)	14.318444
Conductivity (S/m)	1.942536
Variation (%)	-0.240000

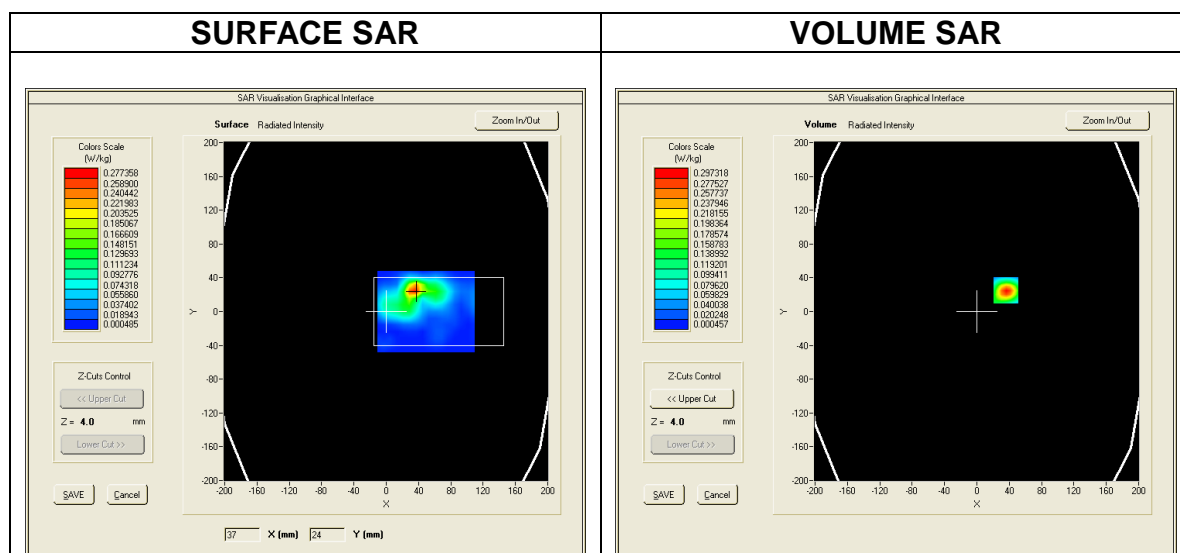

Maximum location: X=-28.00, Y=-40.00
SAR Peak: 0.55 W/kg

SAR 10g (W/Kg)	0.121678
SAR 1g (W/Kg)	0.286325

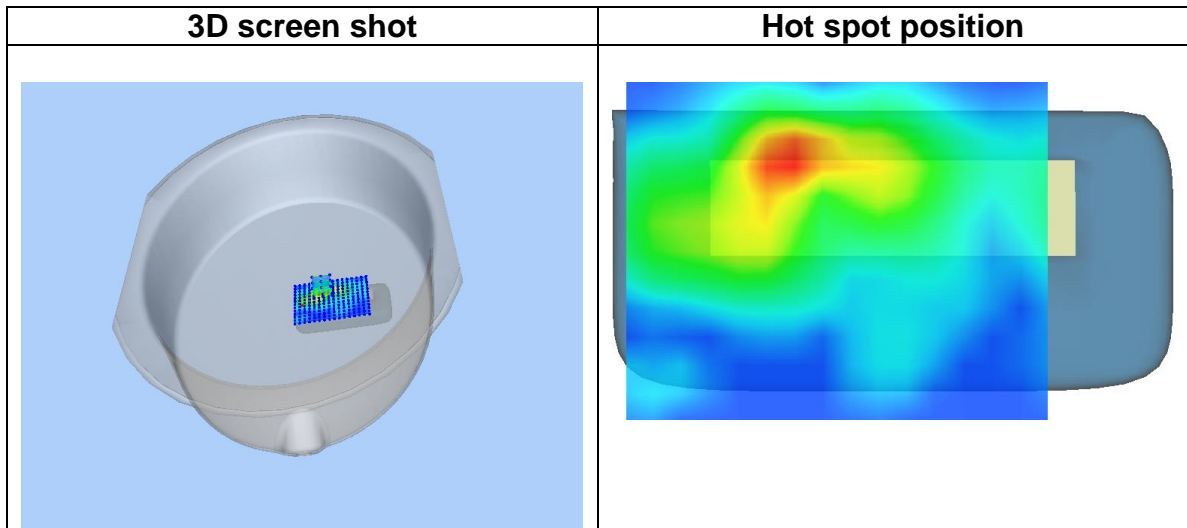
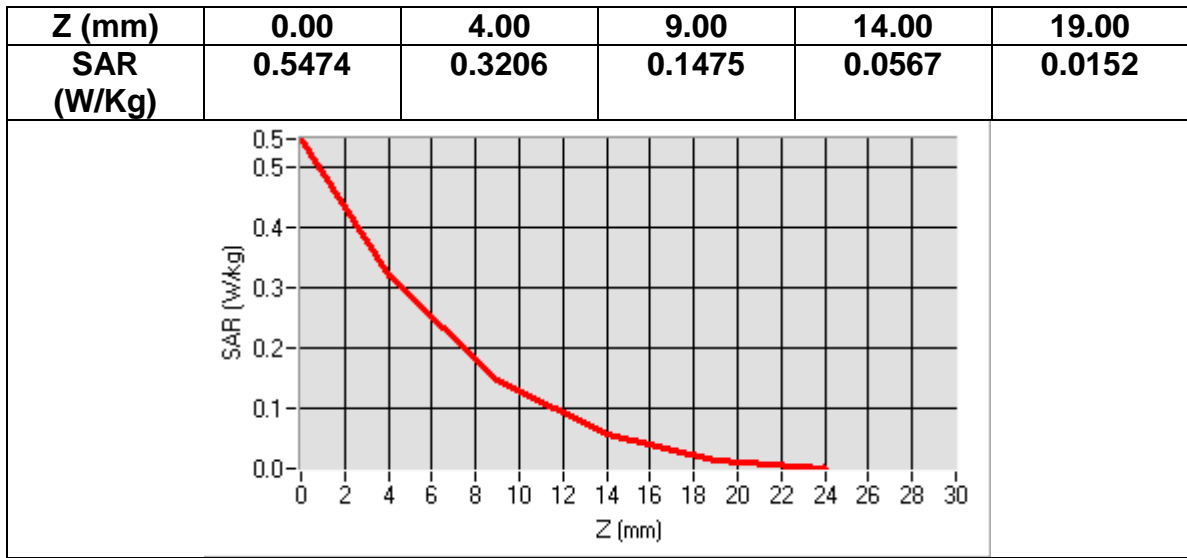

MEASUREMENT 12
Date of measurement: 2016/08/22

Area Scan	<u>dx=8mm dy=8mm, h= 5.00 mm</u>
ZoomScan	<u>7x7x7,dx=5mm dy=5mm dz=5mm, dx=8mm dy=8mm, h= 5.00 mm</u>
Phantom	<u>ELLI16</u>
Device Position	<u>BACK BODY</u>
Band	<u>CUSTOM (WIFI)</u>
Channels	<u>High</u>
Signal	<u>Duty Cycle: 1.00 (Crest factor: 1.0)</u>

Frequency (MHz)	2462.000000
Relative permittivity (real part)	52.672001
Relative permittivity (imaginary part)	14.412000
Conductivity (S/m)	1.979248
Variation (%)	-4.360001

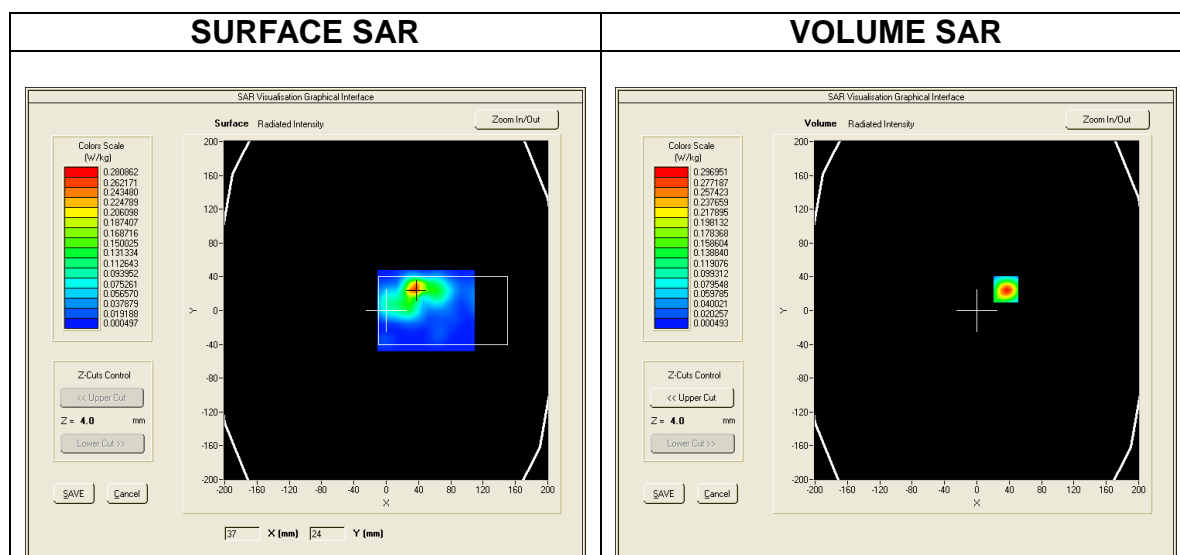

Maximum location: X=-28.00, Y=-40.00
SAR Peak: 0.53 W/kg

SAR 10g (W/Kg)	0.110055
SAR 1g (W/Kg)	0.266005

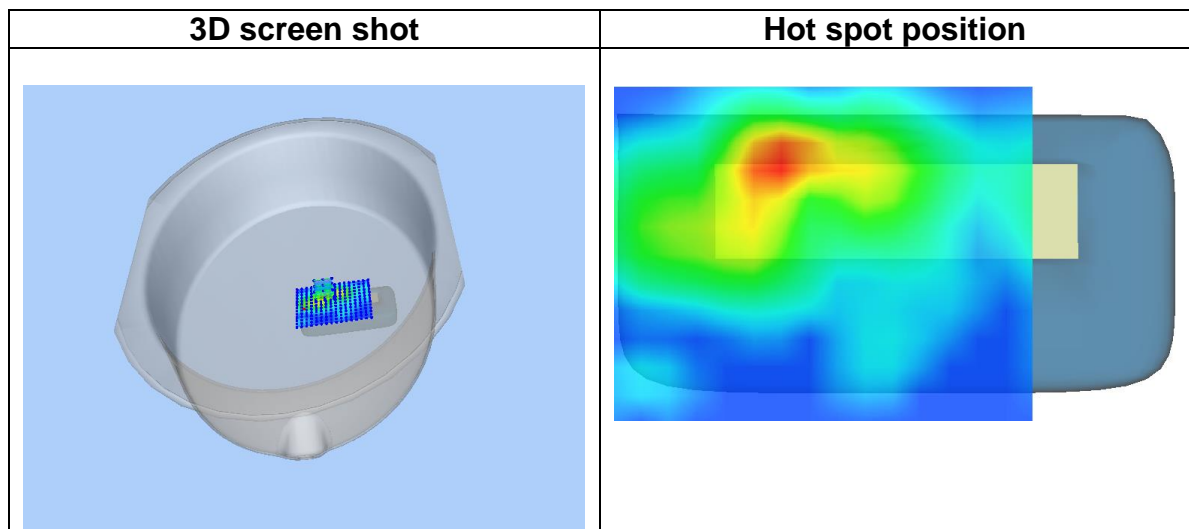
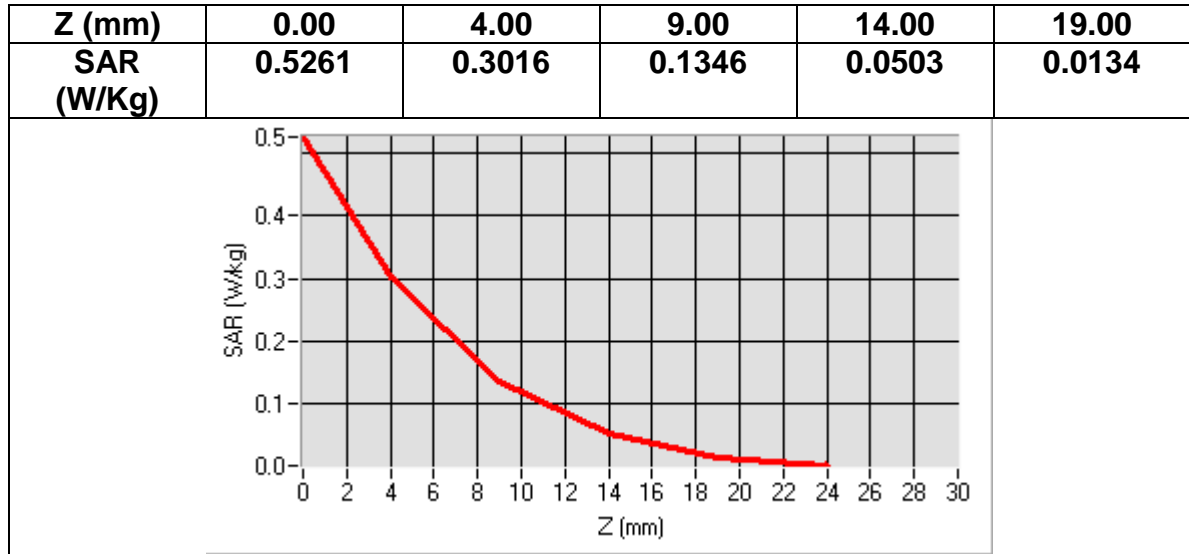

MEASUREMENT 13
 Date of measurement: 2016/08/22

Area Scan	<u>dx=8mm dy=8mm, h= 5.00 mm</u>
ZoomScan	<u>7x7x7,dx=5mm dy=5mm dz=5mm, dx=8mm dy=8mm, h= 5.00 mm</u>
Phantom	<u>ELLI16</u>
Device Position	<u>LEFT BODY</u>
Band	<u>CUSTOM (WIFI)</u>
Channels	<u>Low</u>
Signal	<u>Duty Cycle: 1.00 (Crest factor: 1.0)</u>

Frequency (MHz)	2412.000000
Relative permittivity (real part)	52.750668
Relative permittivity (imaginary part)	14.275111
Conductivity (S/m)	1.912865
Variation (%)	-2.700000

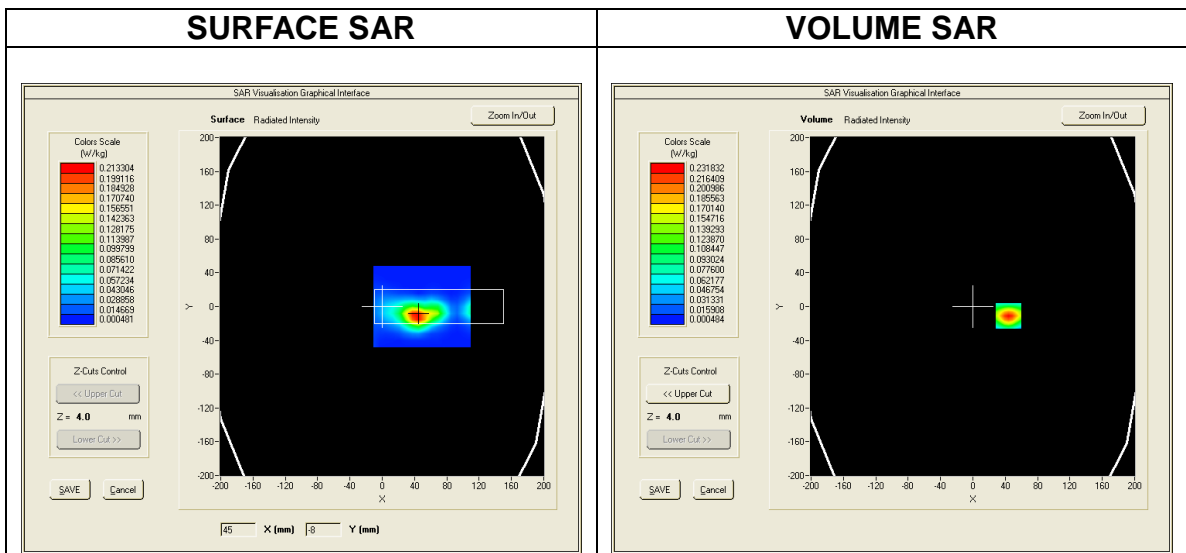

Maximum location: X=13.00, Y=-31.00
SAR Peak: 0.38 W/kg

SAR 10g (W/Kg)	0.085550
SAR 1g (W/Kg)	0.199442

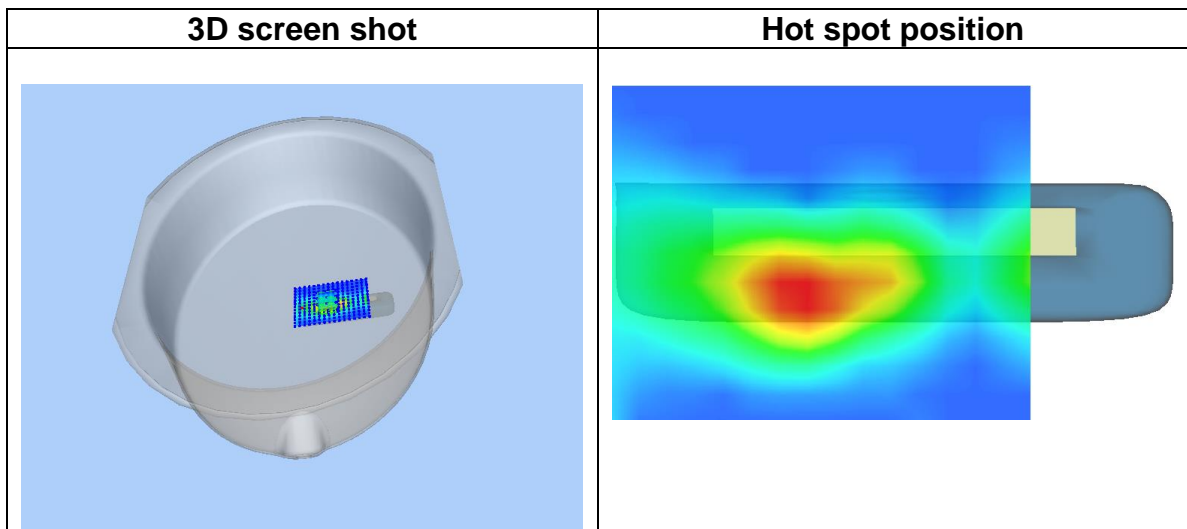
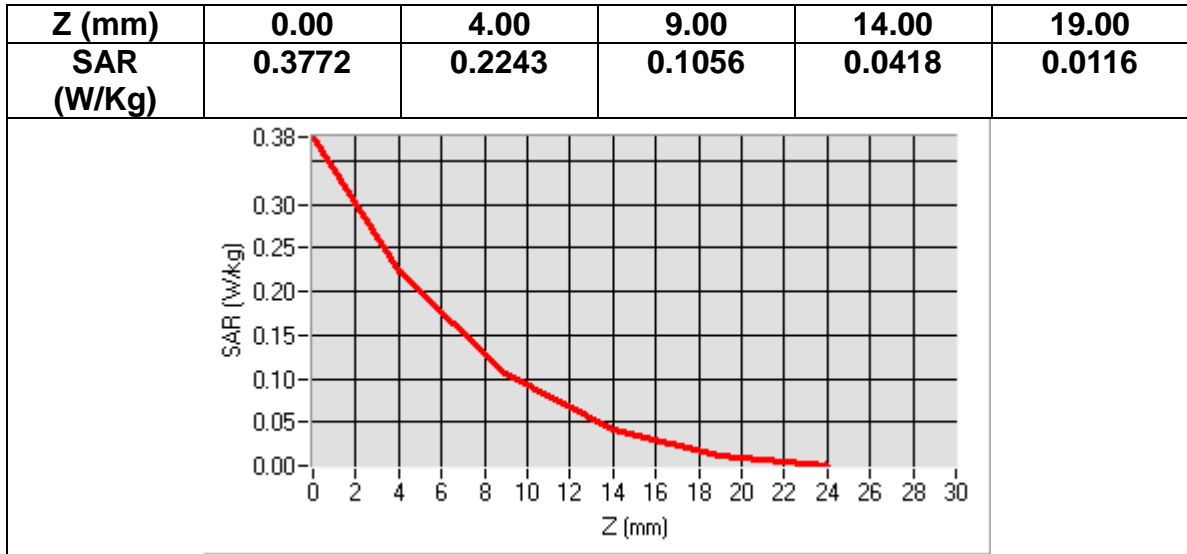

MEASUREMENT 14
 Date of measurement: 2016/08/22

Area Scan	<u>dx=8mm dy=8mm, h= 5.00 mm</u>
ZoomScan	<u>7x7x7,dx=5mm dy=5mm dz=5mm, dx=8mm dy=8mm, h= 5.00 mm</u>
Phantom	<u>ELLI16</u>
Device Position	<u>LEFT BODY</u>
Band	<u>CUSTOM (WIFI)</u>
Channels	<u>Middle</u>
Signal	<u>Duty Cycle: 1.00 (Crest factor: 1.0)</u>

Frequency (MHz)	2437.000000
Relative permittivity (real part)	52.710667
Relative permittivity (imaginary part)	14.318444
Conductivity (S/m)	1.942536
Variation (%)	-4.320000

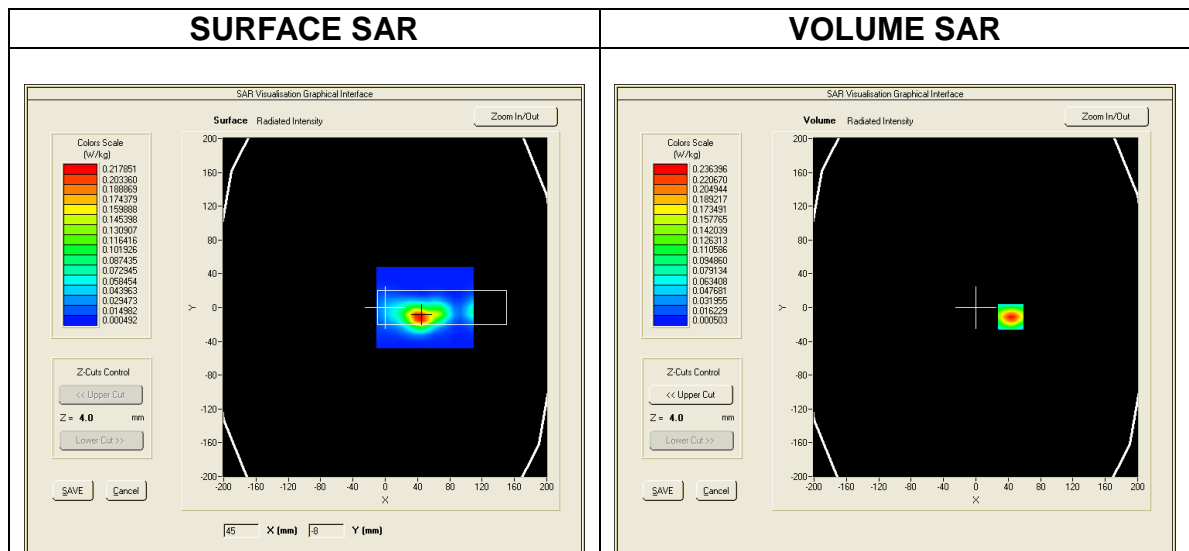

Maximum location: X=13.00, Y=-32.00
SAR Peak: 0.40 W/kg

SAR 10g (W/Kg)	0.088553
SAR 1g (W/Kg)	0.206524

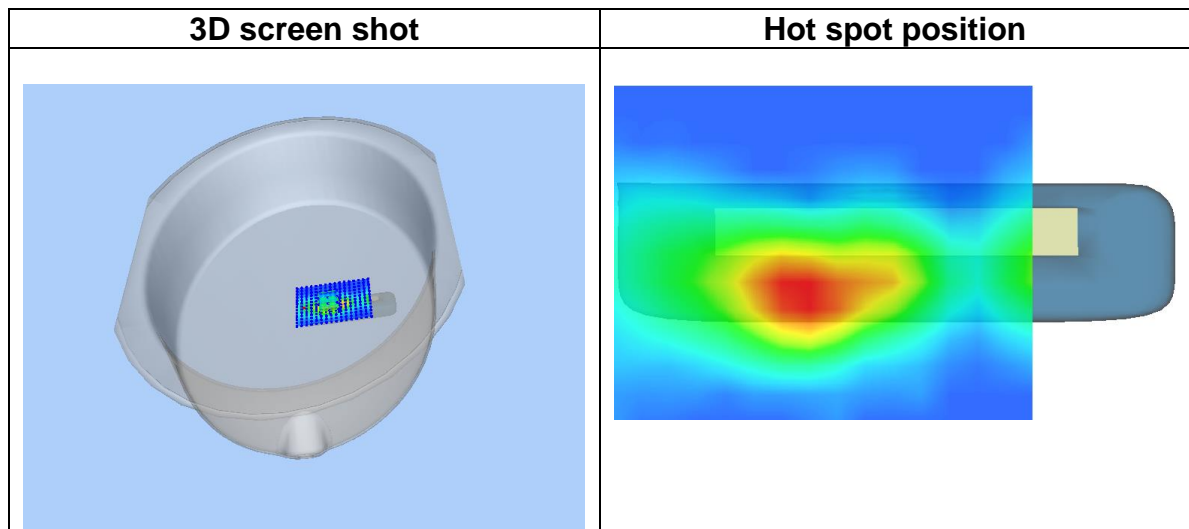
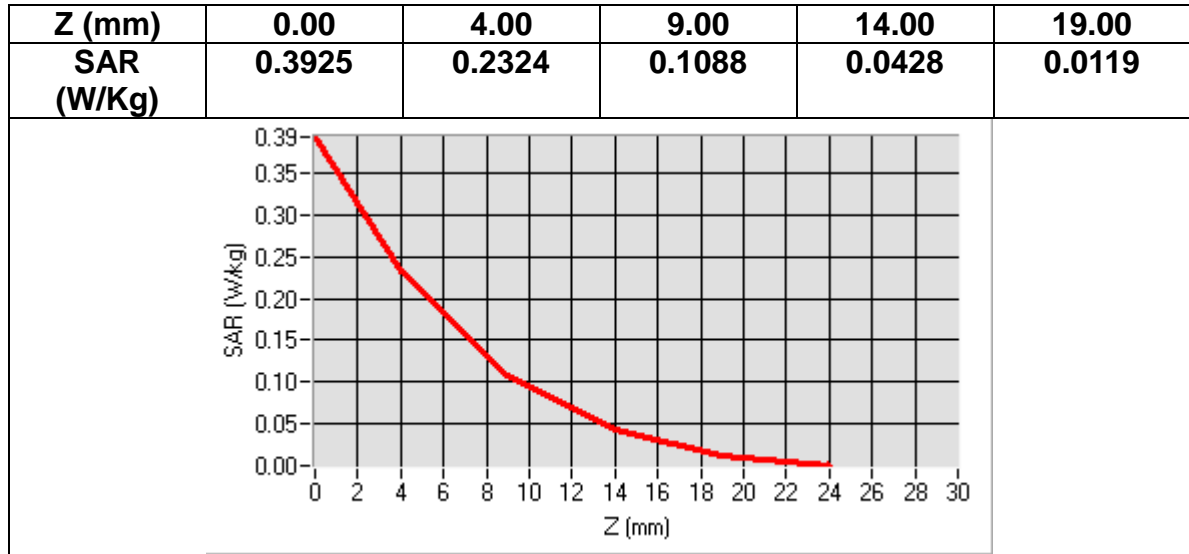

MEASUREMENT 15
Date of measurement: 2016/08/22

Area Scan	<u>dx=8mm dy=8mm, h= 5.00 mm</u>
ZoomScan	<u>7x7x7,dx=5mm dy=5mm dz=5mm, dx=8mm dy=8mm, h= 5.00 mm</u>
Phantom	<u>ELLI16</u>
Device Position	<u>LEFT BODY</u>
Band	<u>CUSTOM (WIFI)</u>
Channels	<u>High</u>
Signal	<u>Duty Cycle: 1.00 (Crest factor: 1.0)</u>

Frequency (MHz)	2462.000000
Relative permittivity (real part)	52.672001
Relative permittivity (imaginary part)	14.412000
Conductivity (S/m)	1.979248
Variation (%)	-3.260000

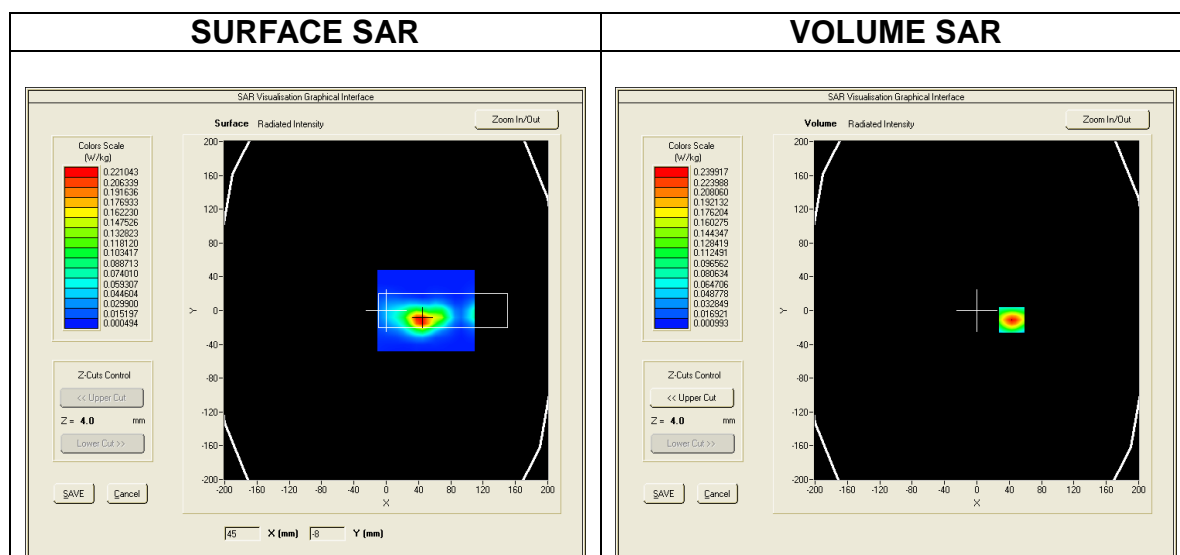

Maximum location: X=13.00, Y=-32.00
SAR Peak: 0.32 W/kg

SAR 10g (W/Kg)	0.065516
SAR 1g (W/Kg)	0.157226

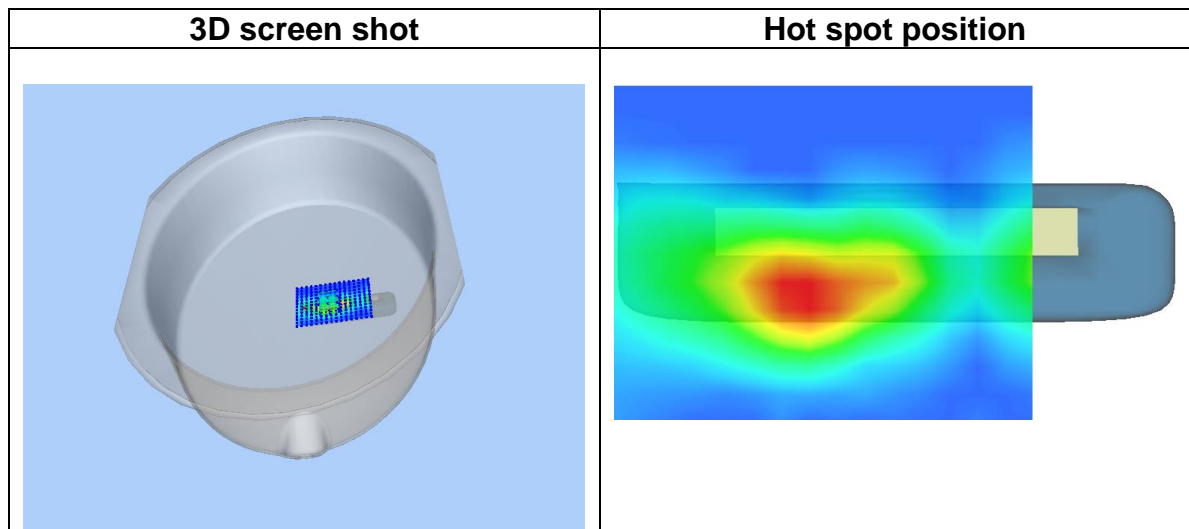
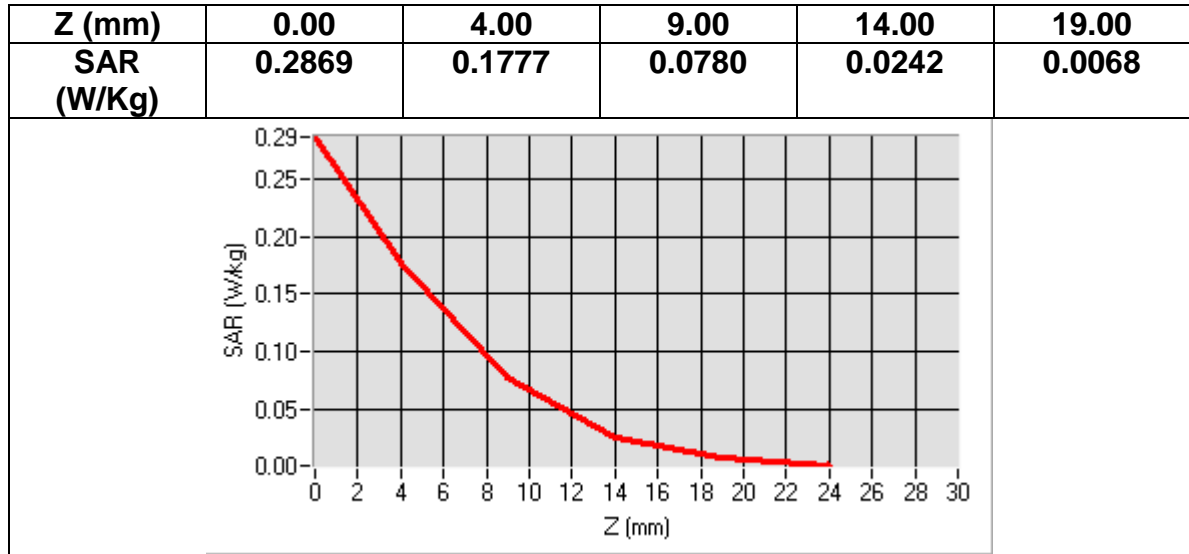

MEASUREMENT 16
Date of measurement: 2016/08/22

Area Scan	<u>dx=8mm dy=8mm, h= 5.00 mm</u>
ZoomScan	<u>7x7x7,dx=5mm dy=5mm dz=5mm,Very fast/ndx=8mm dy=8mm, h= 5.00 mm</u>
Phantom	<u>ELLI16</u>
Device Position	<u>FRONT BODY+EARPHONE</u>
Band	<u>CUSTOM (WIFI)</u>
Channels	<u>Low</u>
Signal	<u>Duty Cycle: 1.00 (Crest factor: 1.0)</u>

Frequency (MHz)	2412.000000
Relative permittivity (real part)	52.750668
Relative permittivity (imaginary part)	14.275111
Conductivity (S/m)	1.912865
Variation (%)	-1.250000

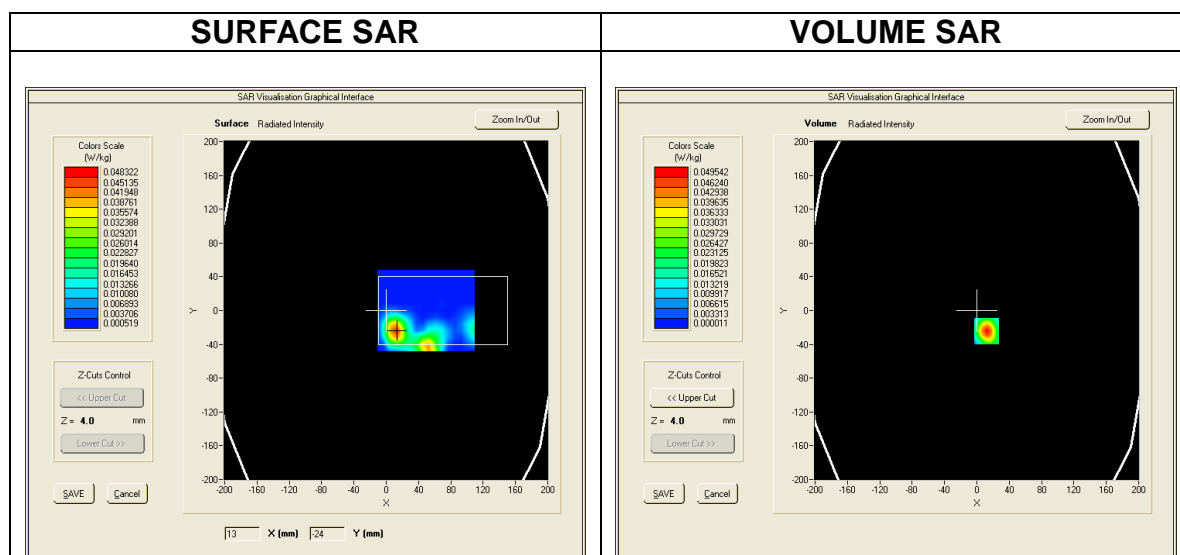

Maximum location: X=36.00, Y=-28.00
SAR Peak: 0.05 W/kg

SAR 10g (W/Kg)	0.008608
SAR 1g (W/Kg)	0.021906

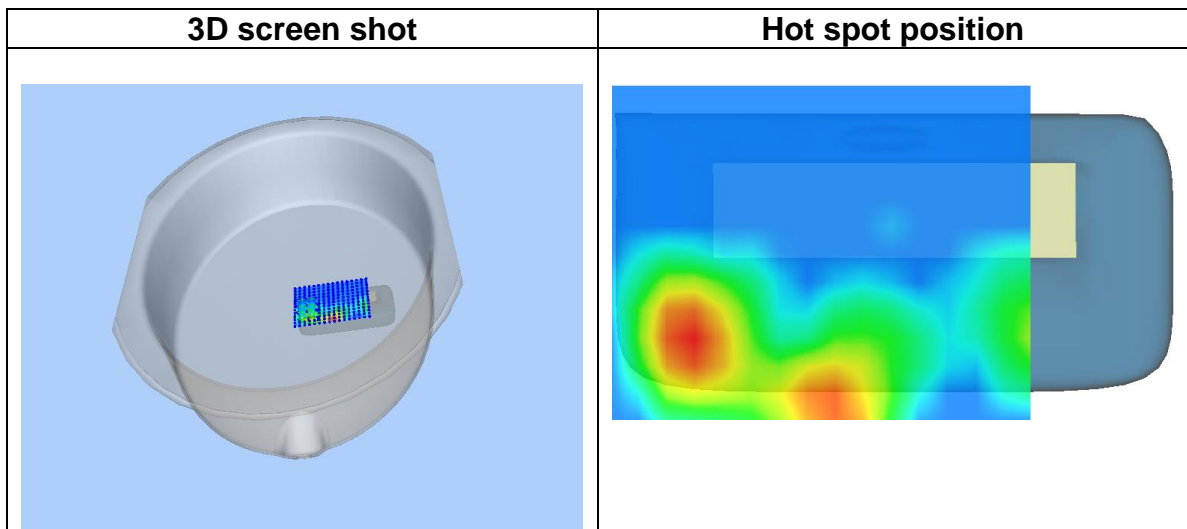
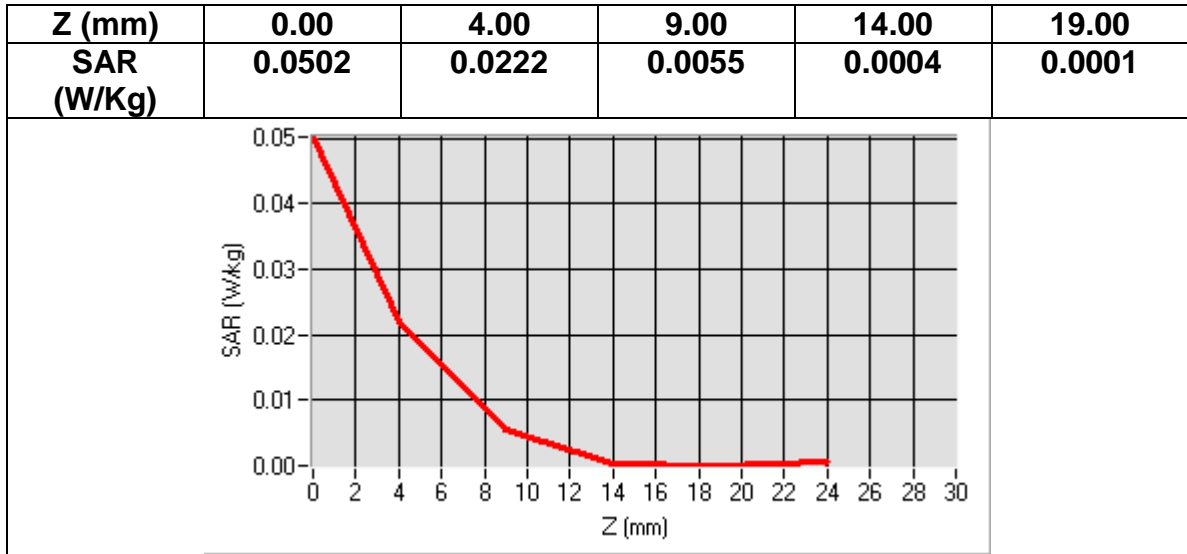

MEASUREMENT 17
Date of measurement: 2016/08/22

Area Scan	<u>dx=8mm dy=8mm, h= 5.00 mm</u>
ZoomScan	<u>7x7x7,dx=5mm dy=5mm dz=5mm, dx=8mm dy=8mm, h= 5.00 mm</u>
Phantom	<u>ELLI16</u>
Device Position	<u>FRONT BODY+EARPHONE</u>
Band	<u>CUSTOM (WIFI)</u>
Channels	<u>Middle</u>
Signal	<u>Duty Cycle: 1.00 (Crest factor: 1.0)</u>

Frequency (MHz)	2437.000000
Relative permittivity (real part)	52.710667
Relative permittivity (imaginary part)	14.318444
Conductivity (S/m)	1.942536
Variation (%)	-1.050000

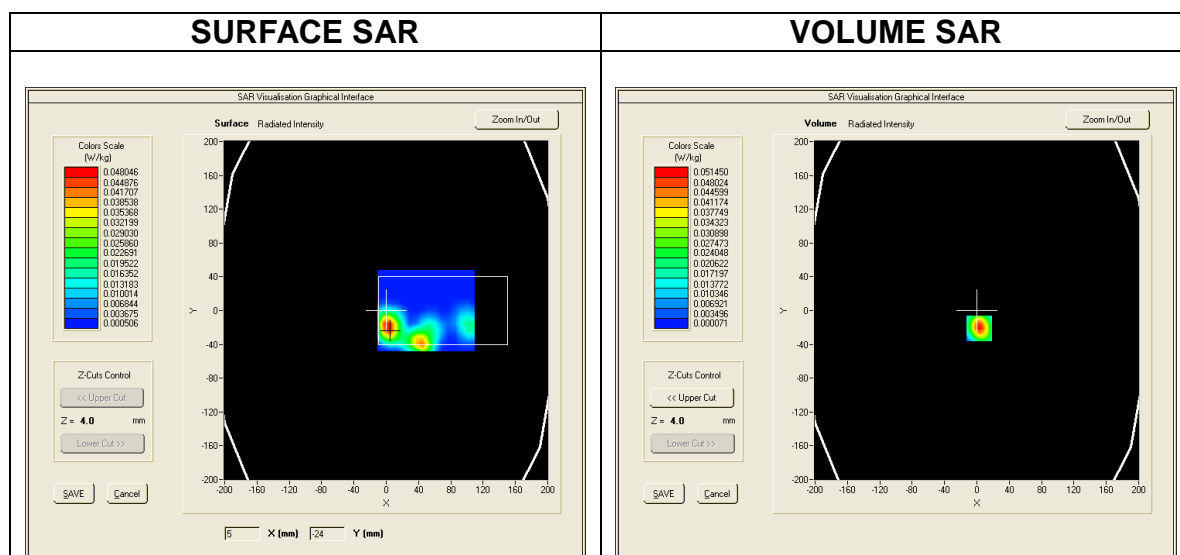

Maximum location: X=37.00, Y=-30.00
SAR Peak: 0.07 W/kg

SAR 10g (W/Kg)	0.008283
SAR 1g (W/Kg)	0.022569

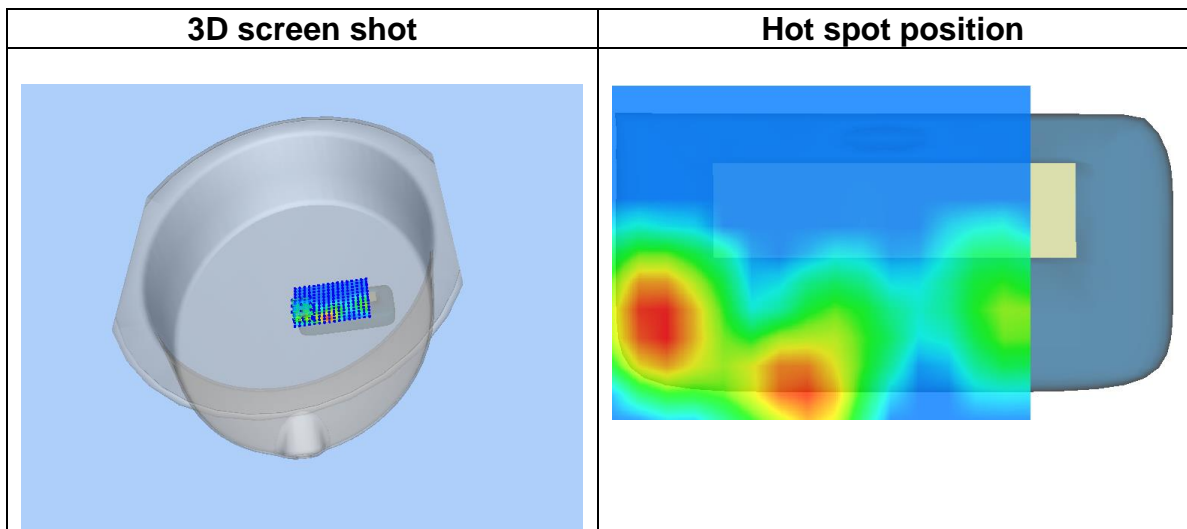
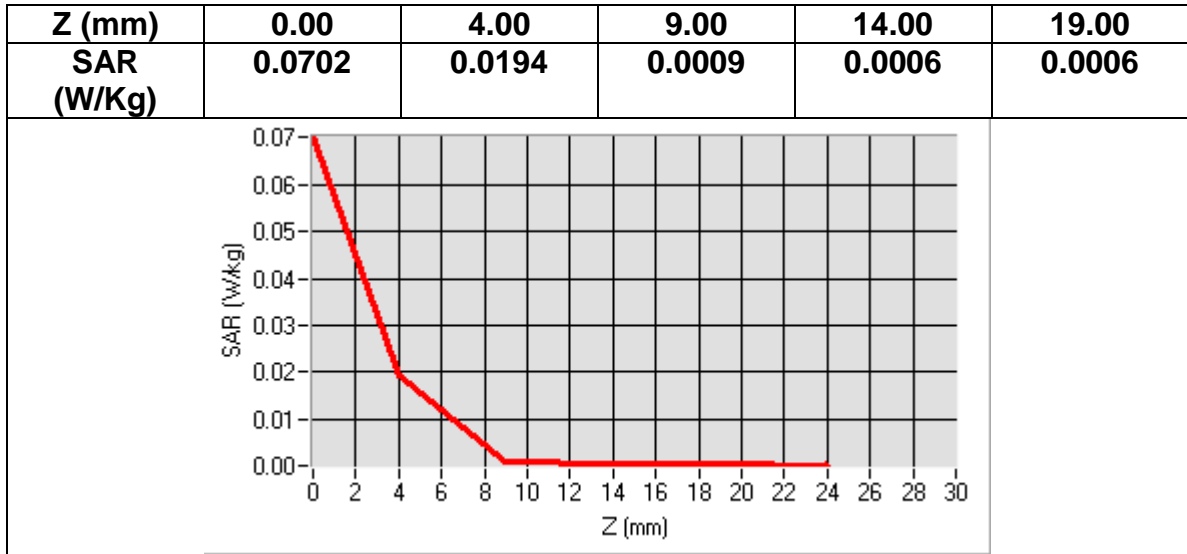

MEASUREMENT 18
Date of measurement: 2016/08/22

Area Scan	<u>dx=8mm dy=8mm, h= 5.00 mm</u>
ZoomScan	<u>7x7x7,dx=5mm dy=5mm dz=5mm, dx=8mm dy=8mm, h= 5.00 mm</u>
Phantom	<u>ELLI16</u>
Device Position	<u>FRONT BODY+EARPHONE</u>
Band	<u>CUSTOM (WIFI)</u>
Channels	<u>High</u>
Signal	<u>Duty Cycle: 1.00 (Crest factor: 1.0)</u>

Frequency (MHz)	2462.000000
Relative permittivity (real part)	52.672001
Relative permittivity (imaginary part)	14.412000
Conductivity (S/m)	1.979248
Variation (%)	-0.010000

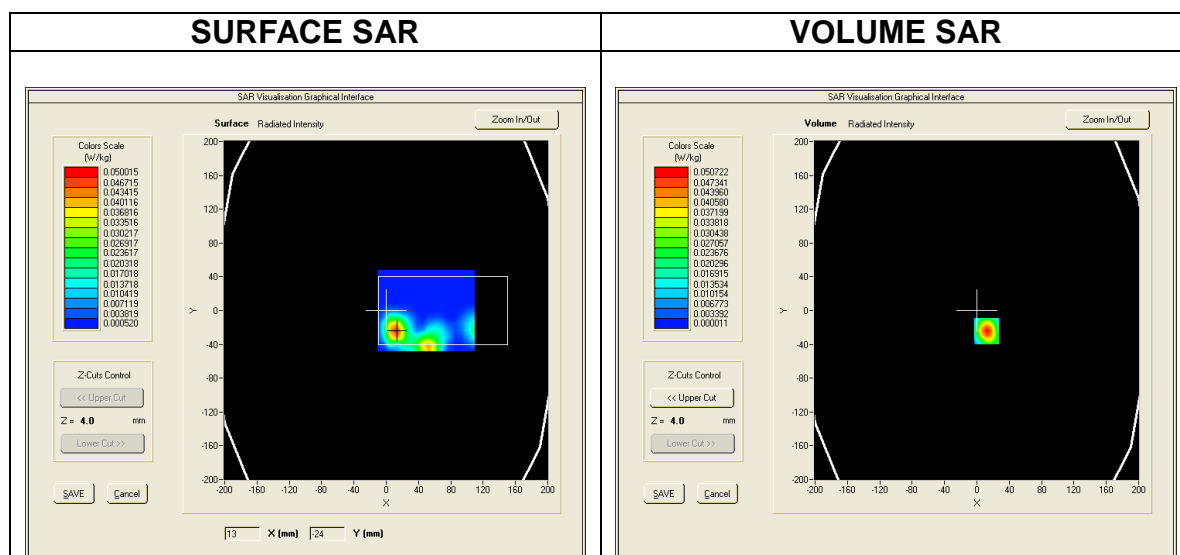

Maximum location: X=46.00, Y=-35.00
SAR Peak: 0.04 W/kg

SAR 10g (W/Kg)	0.003538
SAR 1g (W/Kg)	0.011427

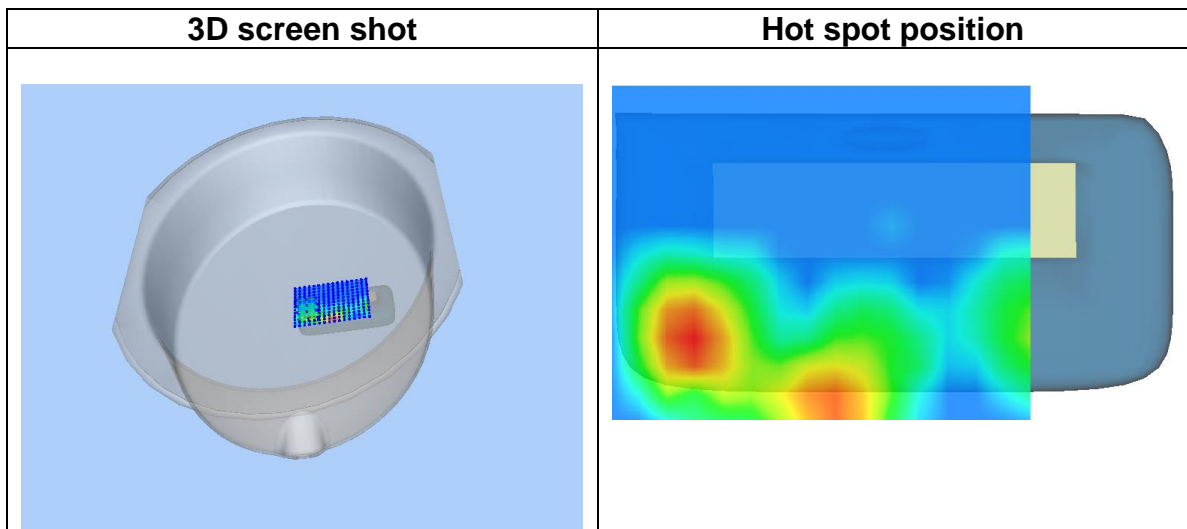
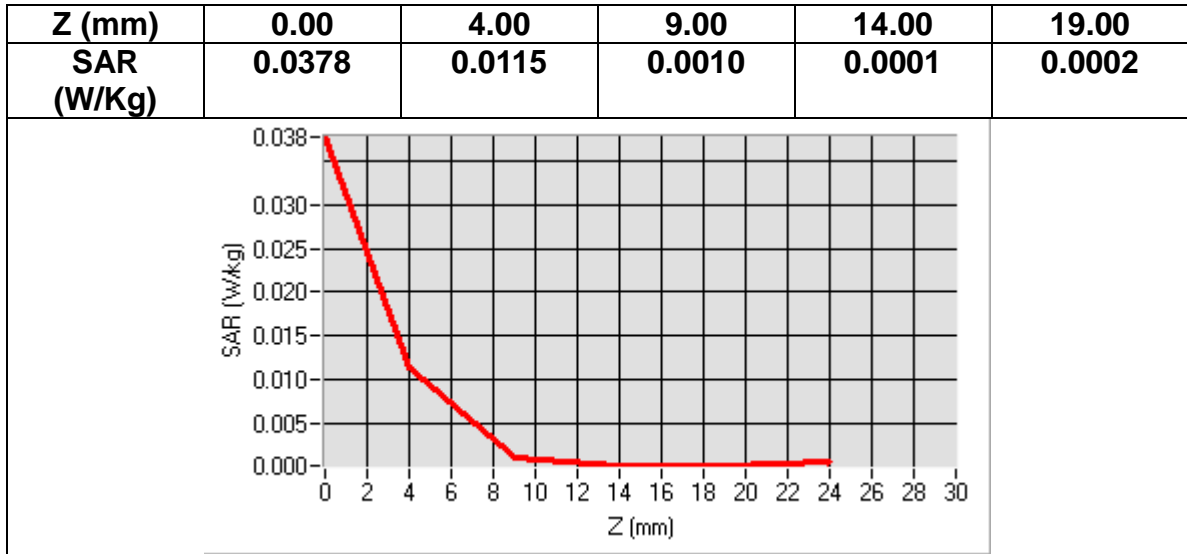

MEASUREMENT 19
 Date of measurement: 2016/08/22

Area Scan	<u>dx=8mm dy=8mm, h= 5.00 mm</u>
ZoomScan	<u>7x7x7,dx=5mm dy=5mm dz=5mm, dx=8mm dy=8mm, h= 5.00 mm</u>
Phantom	<u>ELLI16</u>
Device Position	<u>BACK BODY+EARPHONE</u>
Band	<u>CUSTOM (WIFI)</u>
Channels	<u>Low</u>
Signal	<u>Duty Cycle: 1.00 (Crest factor: 1.0)</u>

Frequency (MHz)	2412.000000
Relative permittivity (real part)	52.750668
Relative permittivity (imaginary part)	14.275111
Conductivity (S/m)	1.912865
Variation (%)	-3.960000

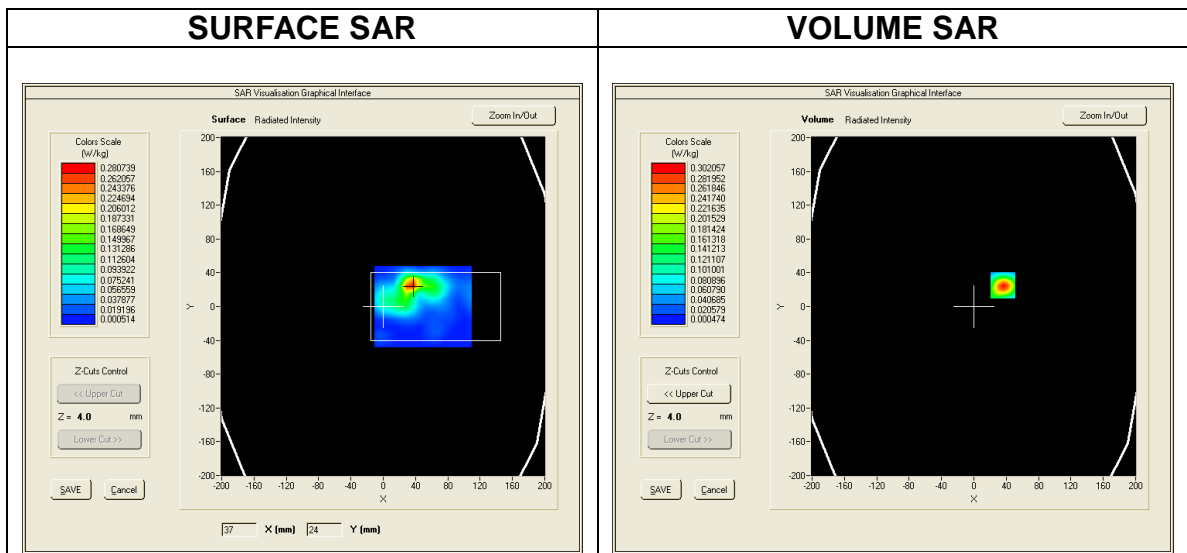

Maximum location: X=-27.00, Y=-40.00
SAR Peak: 0.38 W/kg

SAR 10g (W/Kg)	0.087399
SAR 1g (W/Kg)	0.192302

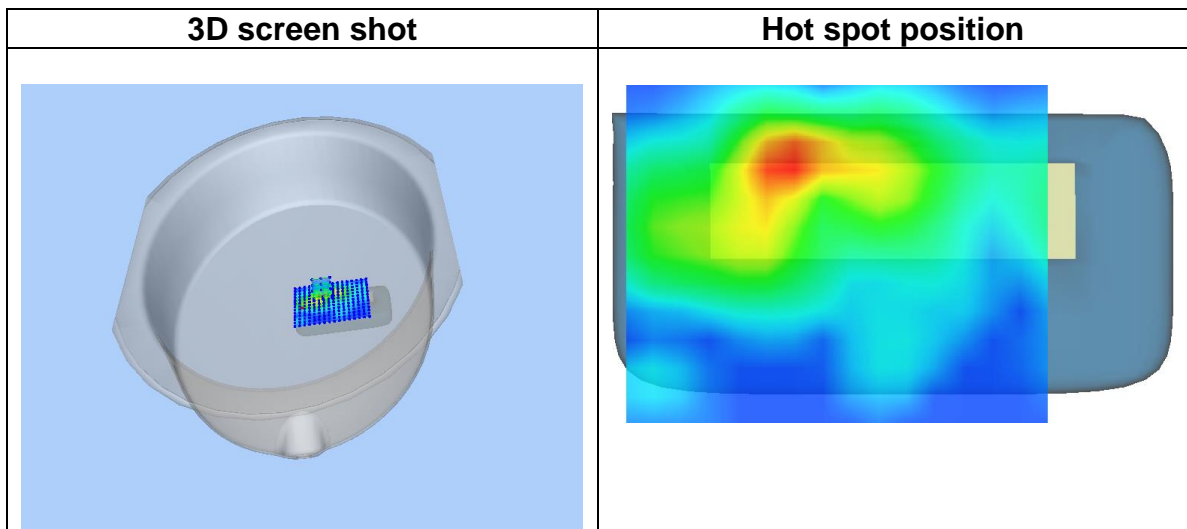
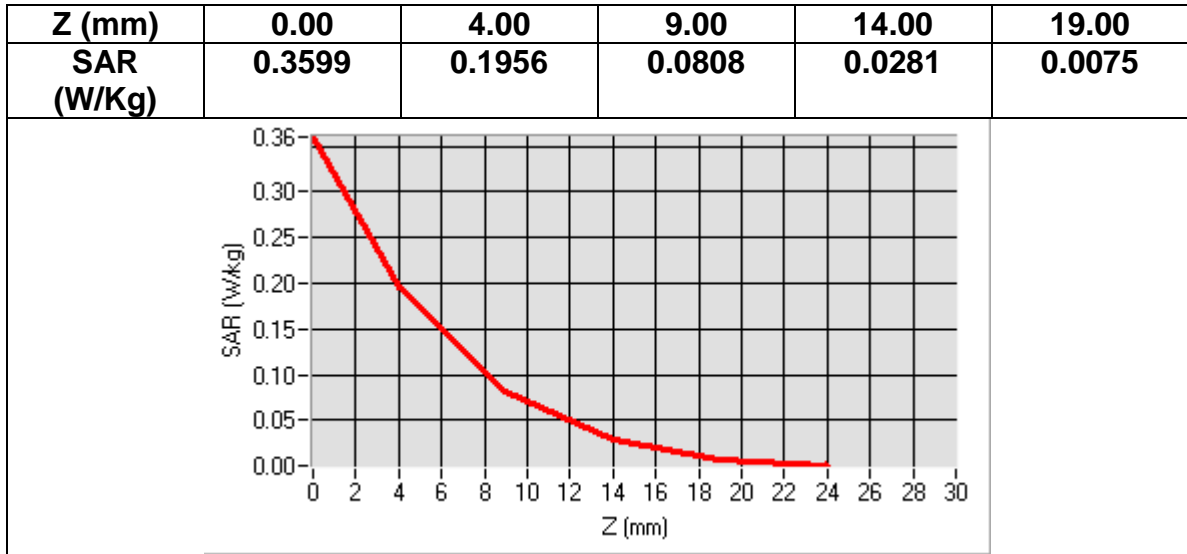

MEASUREMENT 20
 Date of measurement: 2016/08/22

Area Scan	<u>dx=8mm dy=8mm, h= 5.00 mm</u>
ZoomScan	<u>7x7x7,dx=5mm dy=5mm dz=5mm, dx=8mm dy=8mm, h= 5.00 mm</u>
Phantom	<u>ELLI16</u>
Device Position	<u>BACK BODY+EARPHONE</u>
Band	<u>CUSTOM (WIFI)</u>
Channels	<u>Middle</u>
Signal	<u>Duty Cycle: 1.00 (Crest factor: 1.0)</u>

Frequency (MHz)	2437.000000
Relative permittivity (real part)	52.710667
Relative permittivity (imaginary part)	14.318444
Conductivity (S/m)	1.942536
Variation (%)	-4.430000

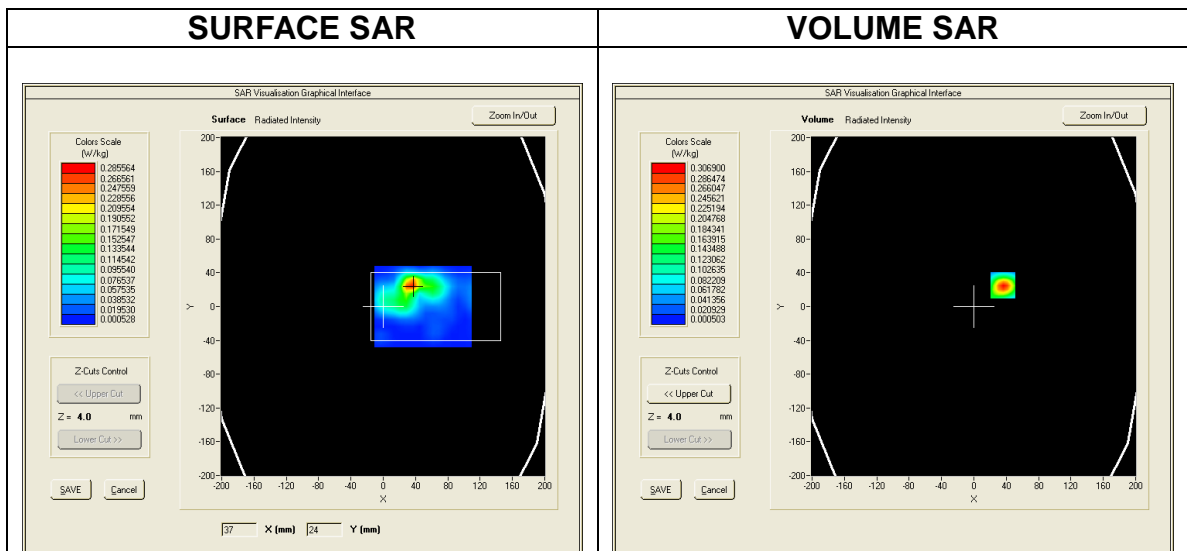

Maximum location: X=-27.00, Y=-40.00
SAR Peak: 0.39 W/kg

SAR 10g (W/Kg)	0.088084
SAR 1g (W/Kg)	0.195876

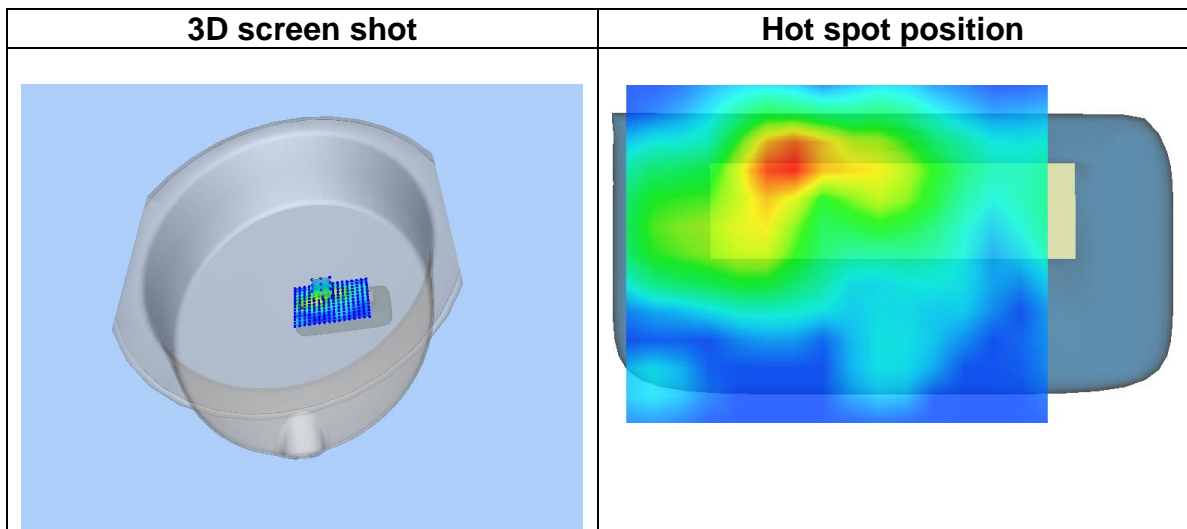
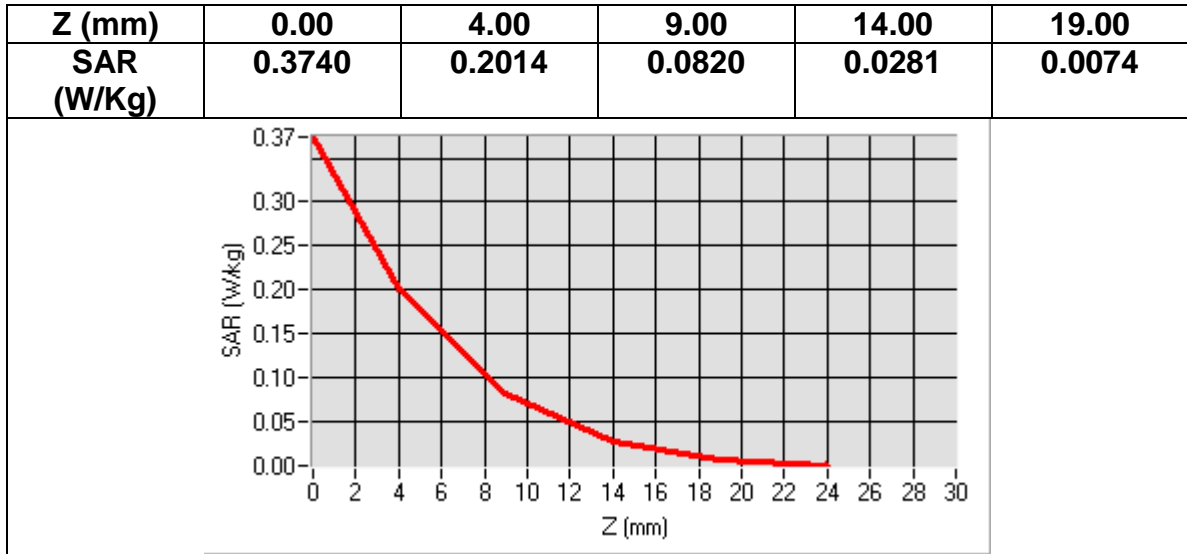

MEASUREMENT 21
Date of measurement: 2016/08/22

Area Scan	<u>dx=8mm dy=8mm, h= 5.00 mm</u>
ZoomScan	<u>7x7x7,dx=5mm dy=5mm dz=5mm, dx=8mm dy=8mm, h= 5.00 mm</u>
Phantom	<u>ELLI16</u>
Device Position	<u>BACK BODY+EARPHONE</u>
Band	<u>CUSTOM (WIFI)</u>
Channels	<u>High</u>
Signal	<u>Duty Cycle: 1.00 (Crest factor: 1.0)</u>

Frequency (MHz)	2462.000000
Relative permittivity (real part)	52.672001
Relative permittivity (imaginary part)	14.412000
Conductivity (S/m)	1.979248
Variation (%)	-3.810000

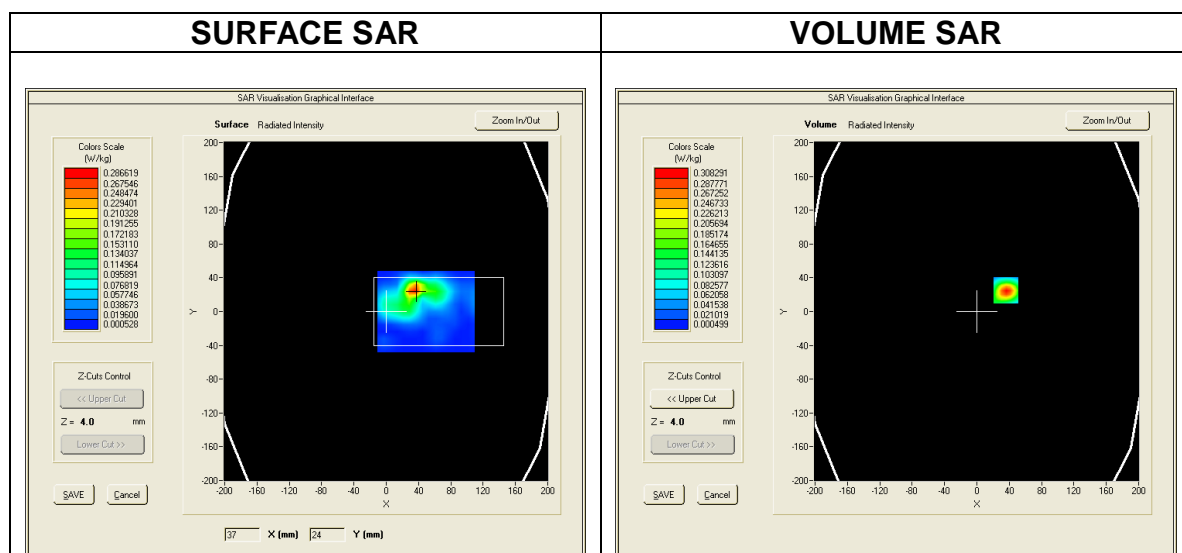

Maximum location: X=-28.00, Y=-40.00
SAR Peak: 0.33 W/kg

SAR 10g (W/Kg)	0.071817
SAR 1g (W/Kg)	0.164376

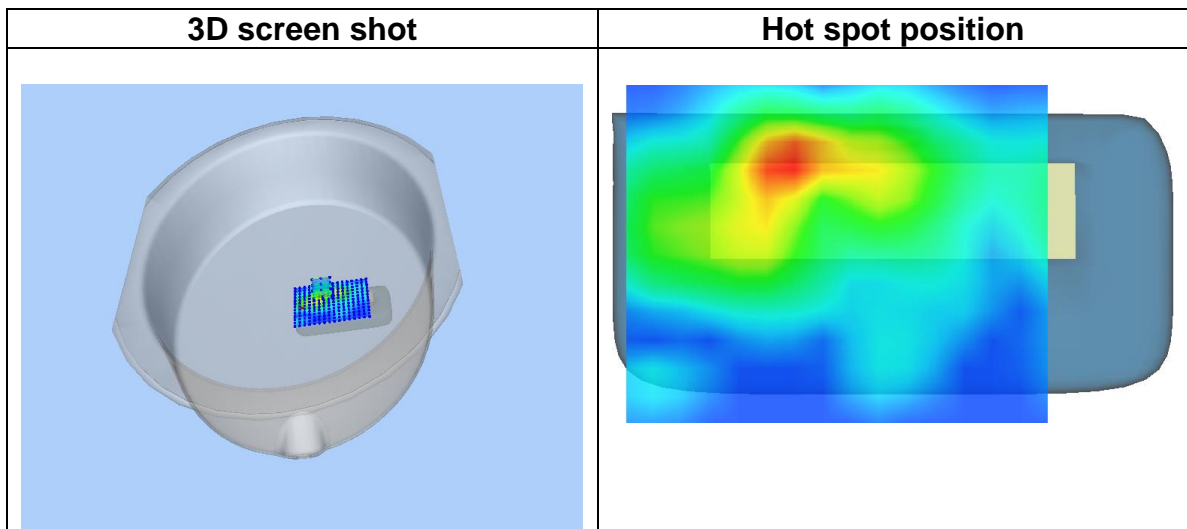
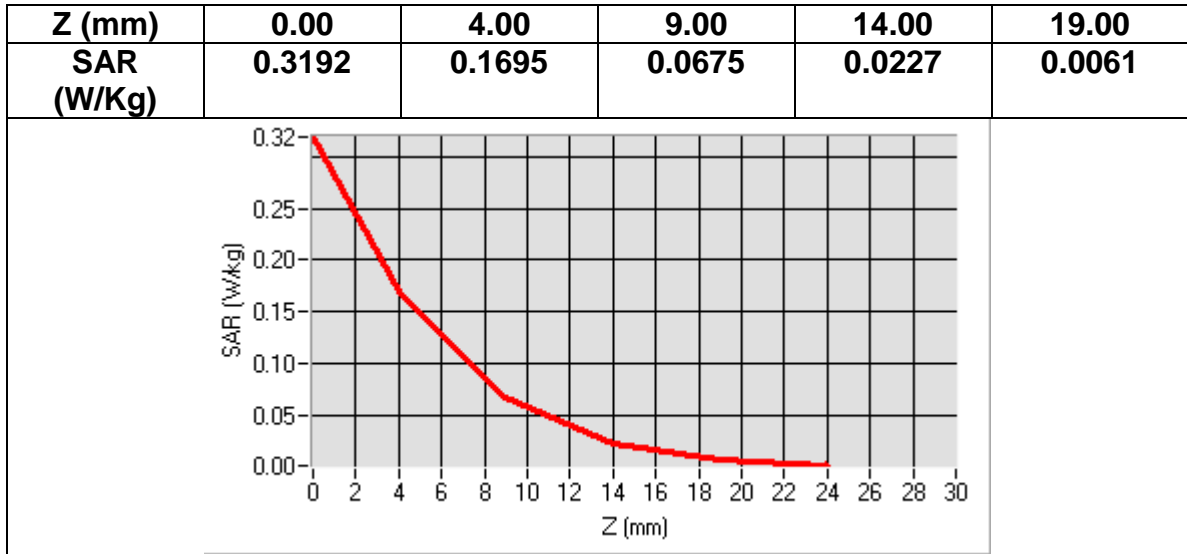

MEASUREMENT 22
 Date of measurement: 2016/08/22

Area Scan	<u>dx=8mm dy=8mm, h= 5.00 mm</u>
ZoomScan	<u>7x7x7,dx=5mm dy=5mm dz=5mm, dx=8mm dy=8mm, h= 5.00 mm</u>
Phantom	<u>Left head</u>
Device Position	<u>Tilt</u>
Band	<u>CUSTOM (WIFI)</u>
Channels	<u>Middle</u>
Signal	<u>Duty Cycle: 1.00 (Crest factor: 1.0)</u>

Frequency (MHz)	2437.000000
Relative permittivity (real part)	39.214222
Relative permittivity (imaginary part)	13.208978
Conductivity (S/m)	1.792018
Variation (%)	2.490000

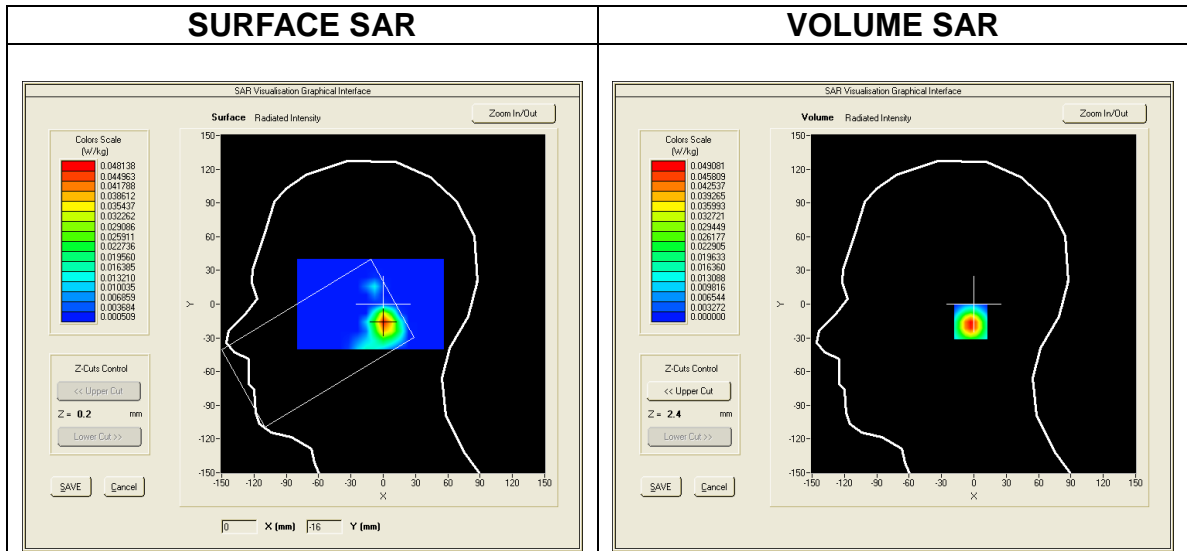

Maximum location: X=1.00, Y=-16.00
SAR Peak: 0.13 W/kg

SAR 10g (W/Kg)	0.018196
SAR 1g (W/Kg)	0.048078

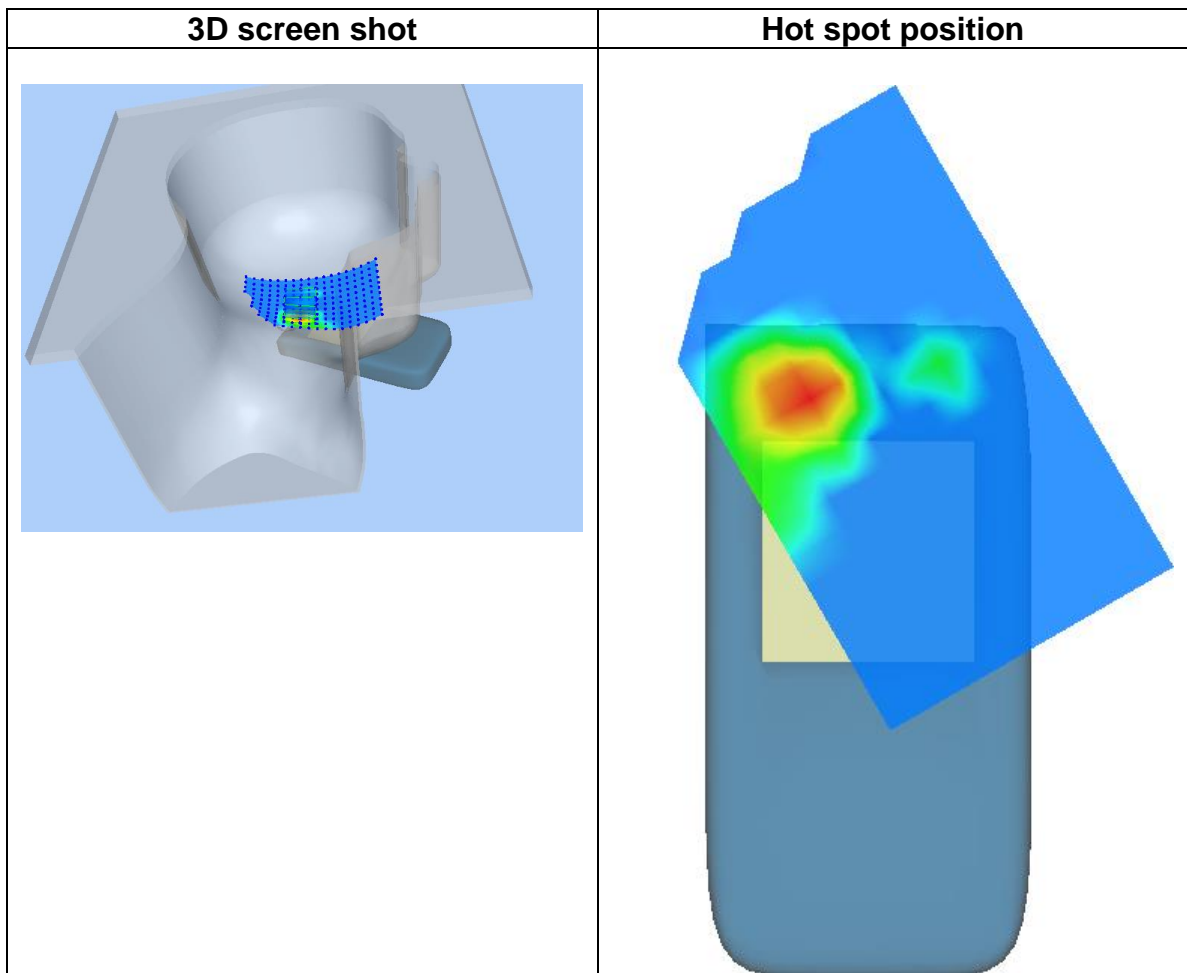
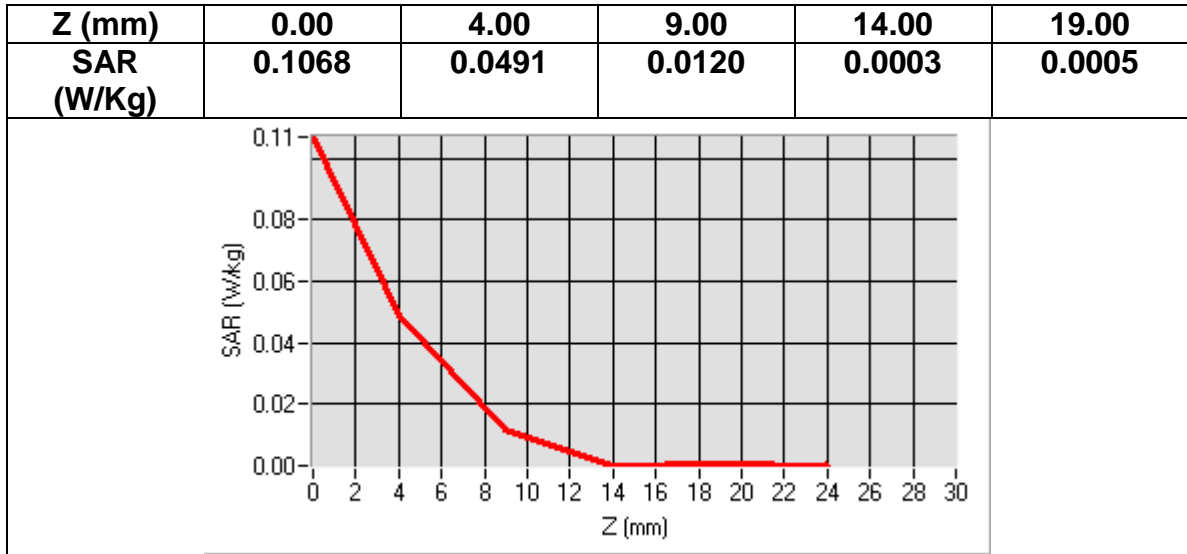

MEASUREMENT 23
 Date of measurement: 2016/08/22

Area Scan	<u>dx=8mm dy=8mm, h= 5.00 mm</u>
ZoomScan	<u>7x7x7,dx=5mm dy=5mm dz=5mm, dx=8mm dy=8mm, h= 5.00 mm</u>
Phantom	<u>Right head</u>
Device Position	<u>Tilt</u>
Band	<u>CUSTOM (WIFI)</u>
Channels	<u>Middle</u>
Signal	<u>Duty Cycle: 1.00 (Crest factor: 1.0)</u>

Frequency (MHz)	2437.000000
Relative permittivity (real part)	39.214222
Relative permittivity (imaginary part)	13.208978
Conductivity (S/m)	1.792018
Variation (%)	1.430020

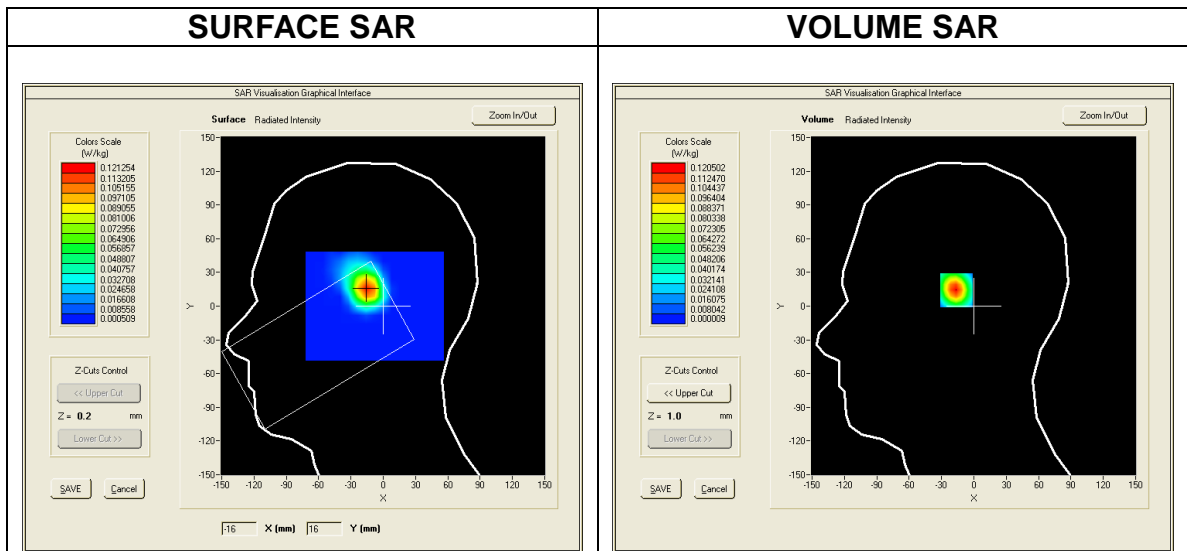

Maximum location: X=-15.00, Y=15.00
SAR Peak: 0.23 W/kg

SAR 10g (W/Kg)	0.044950
SAR 1g (W/Kg)	0.109093

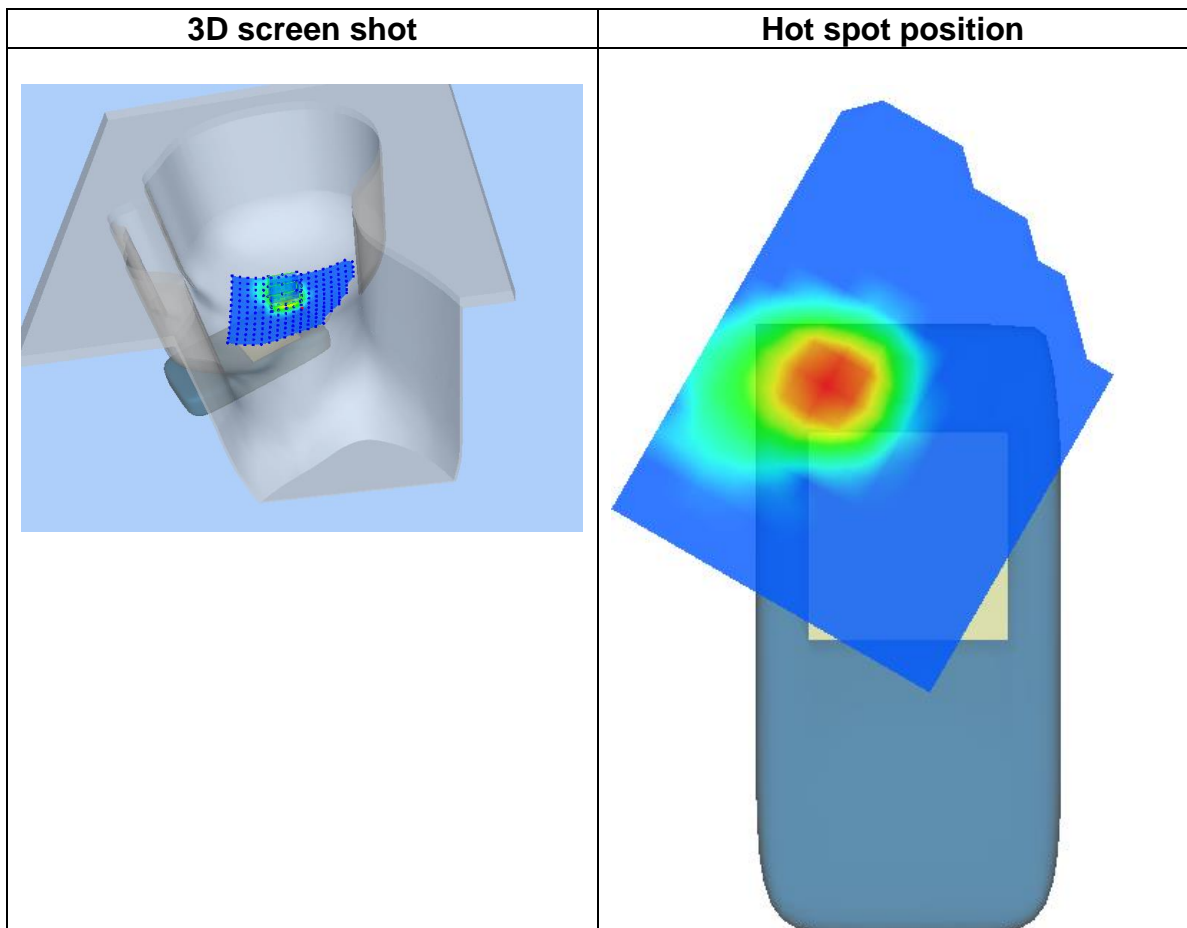
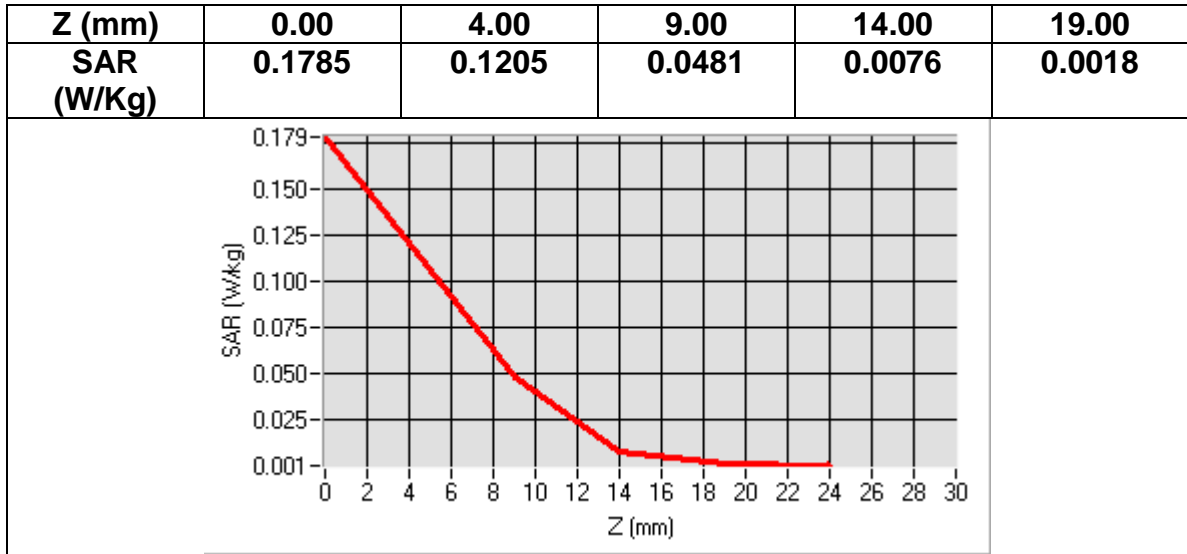

APPENDIX A: EUT PHOTOS



APPENDIX B: TEST SETUP PHOTOS

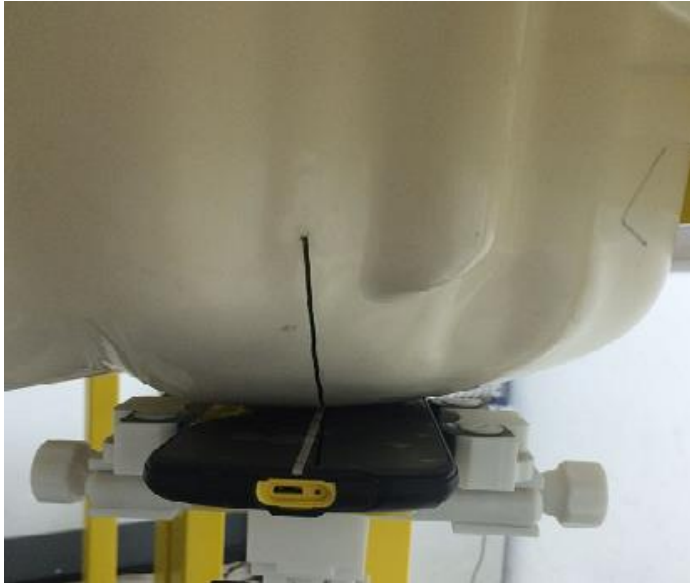

LEFT CHEEK



RIGHT CHEEK



LEFT TILT



RIGHT TILT

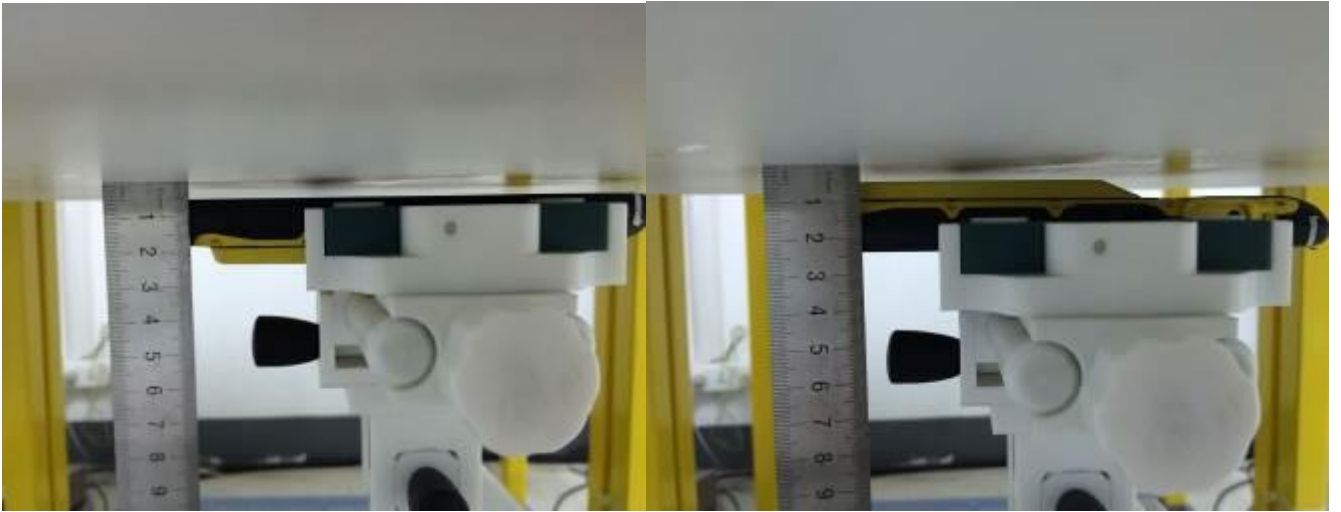

BODY-FRONT

BODY-BACK

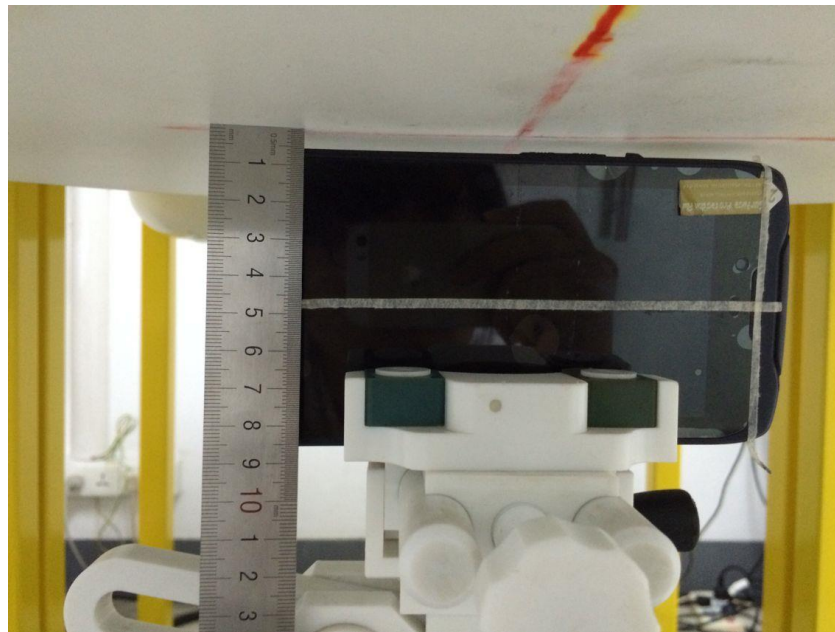

LEFT BODY

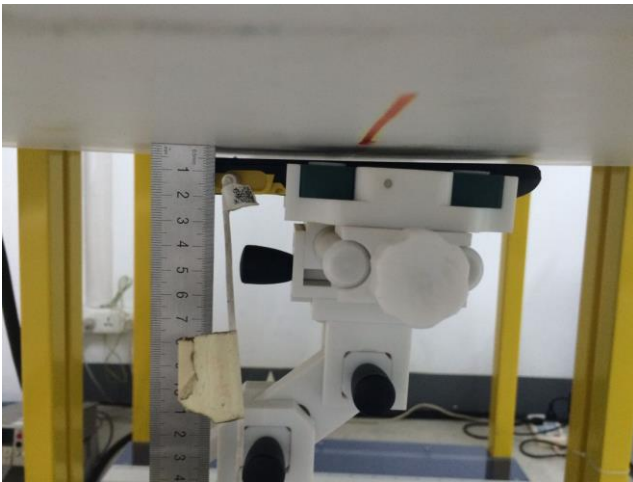

FRONT BODY+EARPHONE

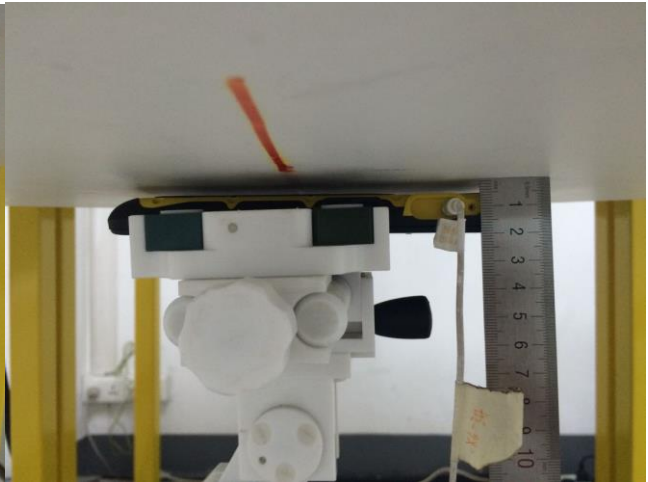

BACK BODY+EARPHONE

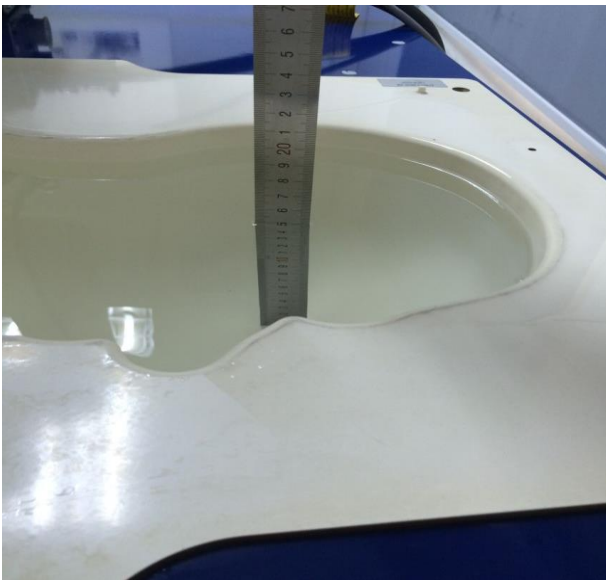

HEAD LIQUID DEPTH

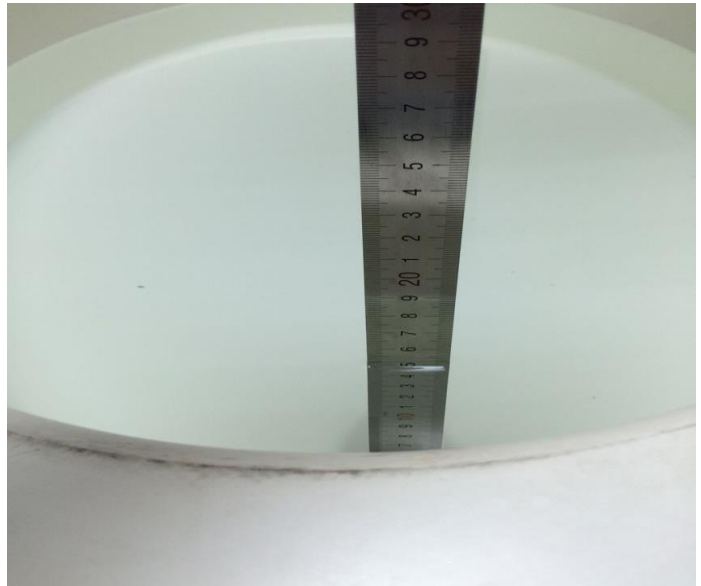

BODY LIQUID DEPTH

APPENDIX C: PROBE CALIBRATION CERTIFICATE



COMOSAR E-Field Probe Calibration Report

Ref : ACR.266.2.14.SATU.A

**INVENTEC APPLIANCES (JIANGNING)
CORPORATION**
**133 JIANG-JUN ROAD, JIANGNING ECONOMIC AND
TECHNOLOGICAL DEVELOPMENT ZONE**
NANJING 211153 PR CHINA
SATIMO COMOSAR DOSIMETRIC E-FIELD PROBE
SERIAL NO.: SN 35/11 EP131

Calibrated at SATIMO US
2105 Barrett Park Dr. - Kennesaw, GA 30144



09/22/2014

Summary:

This document presents the method and results from an accredited COMOSAR Dosimetric E-Field Probe calibration performed in SATIMO USA using the CALISAR / CALIBAIR test bench, for use with a SATIMO COMOSAR system only. All calibration results are traceable to national metrology institutions.



	<i>Name</i>	<i>Function</i>	<i>Date</i>	<i>Signature</i>
<i>Prepared by :</i>	Jérôme LUC	Product Manager	9/23/2014	<i>JS</i>
<i>Checked by :</i>	Jérôme LUC	Product Manager	9/23/2014	<i>JS</i>
<i>Approved by :</i>	Kim RUTKOWSKI	Quality Manager	9/23/2014	<i>Kim Rutkowski</i>

	<i>Customer Name</i>
<i>Distribution :</i>	Inventec Appliances (Jiangning) Corporation

<i>Issue</i>	<i>Date</i>	<i>Modifications</i>
A	9/23/2014	Initial release



TABLE OF CONTENTS

1	Device Under Test	4
2	Product Description	4
2.1	General Information	4
3	Measurement Method	4
3.1	Linearity	4
3.2	Sensitivity	5
3.3	Lower Detection Limit	5
3.4	Isotropy	5
3.5	Boundary Effect	5
4	Measurement Uncertainty	5
5	Calibration Measurement Results	6
5.1	Sensitivity in air	6
5.2	Linearity	7
5.3	Sensitivity in liquid	7
5.4	Isotropy	8
6	List of Equipment	9



1 DEVICE UNDER TEST

Device Under Test	
Device Type	COMOSAR DOSIMETRIC E FIELD PROBE
Manufacturer	Satimo
Model	SSE5
Serial Number	SN 35/11 EP131
Product Condition (new / used)	Used
Frequency Range of Probe	0.7 GHz-3GHz
Resistance of Three Dipoles at Connector	Dipole 1: R1=0.999 MΩ Dipole 2: R2=1.244 MΩ Dipole 3: R3=1.253 MΩ

A yearly calibration interval is recommended.

2 PRODUCT DESCRIPTION

2.1 GENERAL INFORMATION

Satimo's COMOSAR E field Probes are built in accordance to the IEEE 1528, OET 65 Bulletin C and CEI/IEC 62209 standards.



Figure 1 – Satimo COMOSAR Dosimetric E field Dipole

Probe Length	330 mm
Length of Individual Dipoles	4.5 mm
Maximum external diameter	8 mm
Probe Tip External Diameter	5 mm
Distance between dipoles / probe extremity	2.7 mm

3 MEASUREMENT METHOD

The IEEE 1528, OET 65 Bulletin C, CENELEC EN50361 and CEI/IEC 62209 standards provide recommended practices for the probe calibrations, including the performance characteristics of interest and methods by which to assess their affect. All calibrations / measurements performed meet the fore mentioned standards.

3.1 LINEARITY

The evaluation of the linearity was done in free space using the waveguide, performing a power sweep to cover the SAR range 0.01W/kg to 100W/kg.



3.2 SENSITIVITY

The sensitivity factors of the three dipoles were determined using a two step calibration method (air and tissue simulating liquid) using waveguides as outlined in the standards.

3.3 LOWER DETECTION LIMIT

The lower detection limit was assessed using the same measurement set up as used for the linearity measurement. The required lower detection limit is 10 mW/kg.

3.4 ISOTROPY

The axial isotropy was evaluated by exposing the probe to a reference wave from a standard dipole with the dipole mounted under the flat phantom in the test configuration suggested for system validations and checks. The probe was rotated along its main axis from 0 - 360 degrees in 15 degree steps. The hemispherical isotropy is determined by inserting the probe in a thin plastic box filled with tissue-equivalent liquid, with the plastic box illuminated with the fields from a half wave dipole. The dipole is rotated about its axis (0°–180°) in 15° increments. At each step the probe is rotated about its axis (0°–360°).

3.5 BOUNDARY EFFECT

The boundary effect is defined as the deviation between the SAR measured data and the expected exponential decay in the liquid when the probe is oriented normal to the interface. To evaluate this effect, the liquid filled flat phantom is exposed to fields from either a reference dipole or waveguide. With the probe normal to the phantom surface, the peak spatial average SAR is measured and compared to the analytical value at the surface.

4 MEASUREMENT UNCERTAINTY

The guidelines outlined in the IEEE 1528, OET 65 Bulletin C, CENELEC EN50361 and CEI/IEC 62209 standards were followed to generate the measurement uncertainty associated with an E-field probe calibration using the waveguide technique. All uncertainties listed below represent an expanded uncertainty expressed at approximately the 95% confidence level using a coverage factor of k=2, traceable to the Internationally Accepted Guides to Measurement Uncertainty.

Uncertainty analysis of the probe calibration in waveguide					
ERROR SOURCES	Uncertainty value (%)	Probability Distribution	Divisor	ci	Standard Uncertainty (%)
Incident or forward power	3.00%	Rectangular	$\sqrt{3}$	1	1.732%
Reflected power	3.00%	Rectangular	$\sqrt{3}$	1	1.732%
Liquid conductivity	5.00%	Rectangular	$\sqrt{3}$	1	2.887%
Liquid permittivity	4.00%	Rectangular	$\sqrt{3}$	1	2.309%
Field homogeneity	3.00%	Rectangular	$\sqrt{3}$	1	1.732%
Field probe positioning	5.00%	Rectangular	$\sqrt{3}$	1	2.887%
Field probe linearity	3.00%	Rectangular	$\sqrt{3}$	1	1.732%



Combined standard uncertainty					5.831%
Expanded uncertainty 95 % confidence level k = 2					12.0%

5 CALIBRATION MEASUREMENT RESULTS

Calibration Parameters	
Liquid Temperature	21 °C
Lab Temperature	21 °C
Lab Humidity	45 %

5.1 SENSITIVITY IN AIR

Normx dipole 1 ($\mu\text{V}/(\text{V}/\text{m})^2$)	Normy dipole 2 ($\mu\text{V}/(\text{V}/\text{m})^2$)	Normz dipole 3 ($\mu\text{V}/(\text{V}/\text{m})^2$)
4.98	6.07	5.22

DCP dipole 1 (mV)	DCP dipole 2 (mV)	DCP dipole 3 (mV)
96	93	99

Calibration curves $e_i=f(V)$ ($i=1,2,3$) allow to obtain H-field value using the formula:

$$E = \sqrt{E_1^2 + E_2^2 + E_3^2}$$

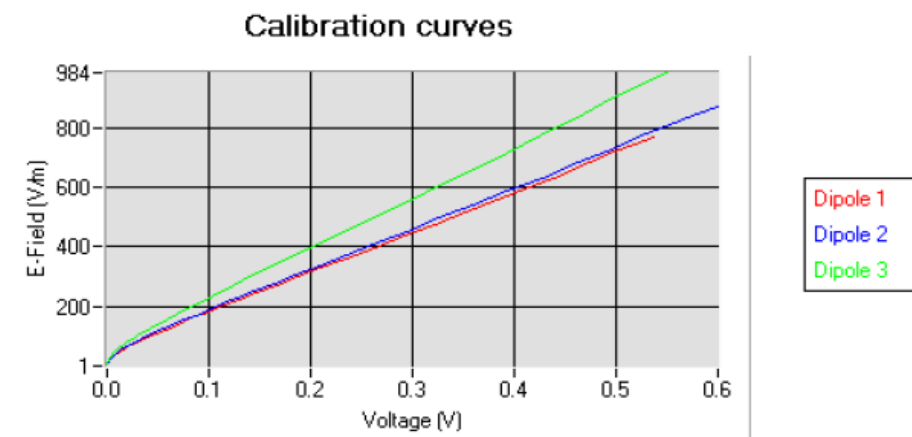



5.2 LINEARITY

Linearity

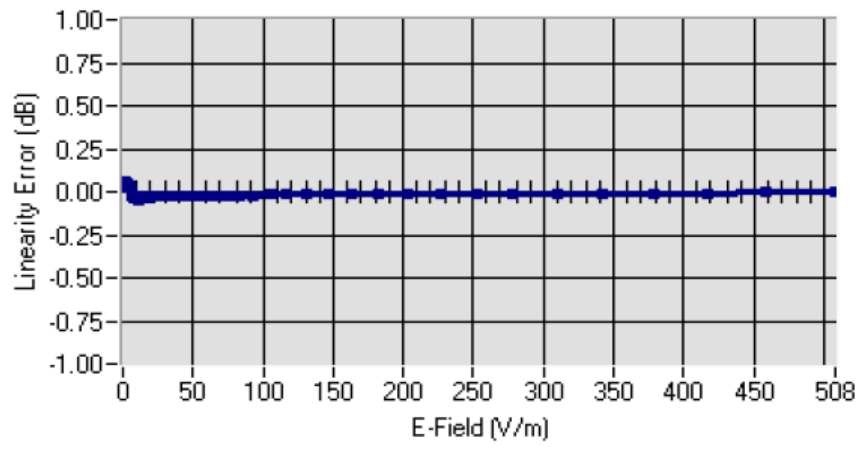

Linearity: $\pm 1.45\%$ ($\pm 0.06\text{dB}$)

5.3 SENSITIVITY IN LIQUID

Liquid	Frequency (MHz +/- 100MHz)	Permittivity	Epsilon (S/m)	ConvF
HL1800	1800	41.31	1.38	6.99
BL1800	1800	53.27	1.51	7.27
HL1900	1900	41.09	1.42	7.69
BL1900	1900	54.20	1.54	7.95
HL2000	2000	39.72	1.43	7.15
BL2000	2000	53.91	1.53	7.35
HL2000	2000	39.72	1.43	7.30
BL2000	2000	53.91	1.53	7.47
HL2450	2450	39.05	1.77	7.22
BL2450	2450	52.97	1.93	7.46
HL2600	2600	38.35	1.92	7.08
BL2600	2600	51.81	2.19	7.32

LOWER DETECTION LIMIT: 9mW/kg



5.4 ISOTROPY

HL1800 MHz

- Axial isotropy: 0.04 dB
- Hemispherical isotropy: 0.07 dB

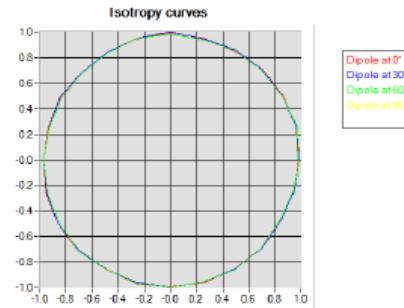



6 LIST OF EQUIPMENT

Equipment Summary Sheet				
Equipment Description	Manufacturer / Model	Identification No.	Current Calibration Date	Next Calibration Date
Flat Phantom	Satimo	SN-20/09-SAM71	Validated. No cal required.	Validated. No cal required.
COMOSAR Test Bench	Version 3	NA	Validated. No cal required.	Validated. No cal required.
Network Analyzer	Rhode & Schwarz ZVA	SN100132	02/2013	02/2016
Reference Probe	Satimo	EP 94 SN 37/08	10/2013	10/2014
Multimeter	Keithley 2000	1188656	12/2013	12/2016
Signal Generator	Agilent E4438C	MY49070581	12/2013	12/2016
Amplifier	Aethercomm	SN 046	Characterized prior to test. No cal required.	Characterized prior to test. No cal required.
Power Meter	HP E4418A	US38261498	12/2013	12/2016
Power Sensor	HP ECP-E26A	US37181460	12/2013	12/2016
Directional Coupler	Narda 4216-20	01386	Characterized prior to test. No cal required.	Characterized prior to test. No cal required.
Waveguide	Mega Industries	069Y7-158-13-712	Validated. No cal required.	Validated. No cal required.
Waveguide Transition	Mega Industries	069Y7-158-13-701	Validated. No cal required.	Validated. No cal required.
Waveguide Termination	Mega Industries	069Y7-158-13-701	Validated. No cal required.	Validated. No cal required.
Temperature / Humidity Sensor	Control Company	11-661-9	8/2012	8/2015

APPENDIX D: DIPOLE CALIBRATION REPORT

SAR Reference Dipole Calibration Report

FREQUENCY: 2450 MHZ

SERIAL NO.:SN 39/09 DIPJ122

**INVENTEC APPLIANCES (JIANGNING)
CORPORATION TESTING LABORATORY**

**133 JIANG-JUN ROAD, JIANGNING ECONOMIC AND
TECHNOLOGICAL DEVELOPMENT ZONE
NANJING 211153 PR CHINA**

Calibrated at INVENTEC

07/01/2016

	Name	Function	Date	Signature
Tested By:	Zhang shuqin	Test Engineer	07/01/2016	Zhang Shuqin
Reviewed By:	Ji jianlin	Manager	07/01/2016	Ji Jianlin
Approved By:	Xu chunxiu	Quality Manager	07/01/2016	Xu Chunxiu

Issue	Date	Modifications
A	07/01/2016	Initial release

TABLE OF CONTENTS

1.	INTRODUCTION	4
2.	DEVICE UNDER TEST	4
3.	PRODUCT DESCRIPTION	4
3.1	GENERAL INFORMATION	4
4.	MEASUREMENT METHOD	4
4.1	RETURN LOSS REQUIREMENTS	4
4.2	MECHANICAL REQUIREMENTS	4
5.	MEASUREMENT UNCERTAINTY	5
5.1	RETURN LOSS	5
5.2	DIMENSION MEASUREMENT	5
5.3	VALIDATION MEASUREMENT	5
6.	CALIBRATION MEASUREMENT RESULTS	6
6.1	RETURN LOSS AND IMPEDANCE IN HEAD LIQUID	6
6.2	RETURN LOSS AND IMPEDANCE IN BODY LIQUID	6
6.3	MECHANICAL DIMENSIONS	7
7.	VALIDATION MEASUREMENT	7
7.1	HEAD LIQUID MEASUREMENT	7
7.2	SAR MEASUREMENT RESULT WITH HEAD LIQUID	8
7.3	BODY LIQUID MEASUREMENT	10
7.4	SAR MEASUREMENT RESULT WITH BODY LIQUID	10
8.	LIST OF EQUIPMENT	12

1. INTRODUCTION

This document contains a summary of the requirements set forth by the IEEE 1528, OET 65 Bulletin C and CEI/IEC 62209 standards for reference dipoles used for SAR measurement system validations and the measurements that were performed to verify that the product complies with the fore mentioned standards.

2. DEVICE UNDER TEST

Device Under Test	
Device Type	COMOSAR 2450 MHz REFERENCE DIPOLE
Manufacturer	Satimo
Model	SID2450
Serial Number	SN 39/09 DIPJ122
Product Condition (new / used)	Used

3. PRODUCT DESCRIPTION

3.1 GENERAL INFORMATION

Satimo's COMOSAR Validation Dipoles are built in accordance to the IEEE 1528, OET 65 Bulletin C and CEI/IEC 62209 standards. The product is designed for use with the COMOSAR test bench only.



Figure 1 – Satimo COMOSAR Validation Dipole

4. MEASUREMENT METHOD

The IEEE 1528, OET 65 Bulletin C and CEI/IEC 62209 standards provide requirements for reference dipoles used for system validation measurements. The following measurements were performed to verify that the product complies with the fore mentioned standards.

4.1 RETURN LOSS REQUIREMENTS

The dipole used for SAR system validation measurements and checks must have a return loss of -20 dB or better. The return loss measurement shall be performed against a liquid filled flat phantom, with the phantom constructed as outlined in the fore mentioned standards.

4.2 MECHANICAL REQUIREMENTS

The IEEE Std. 1528 and CEI/IEC 62209 standards specify the mechanical components and

dimensions of the validation dipoles, with the dimensions frequency and phantom shell thickness dependent. The COMOSAR test bench employs a 2 mm phantom shell thickness therefore the dipoles sold for use with the COMOSAR test bench comply with the requirements set forth for a 2 mm phantom shell thickness.

5. MEASUREMENT UNCERTAINTY

All uncertainties listed below represent an expanded uncertainty expressed at approximately the 95% confidence level using a coverage factor of $k=2$, traceable to the Internationally Accepted Guides to Measurement Uncertainty.

5.1 RETURN LOSS

The following uncertainties apply to the return loss measurement:

Frequency band	Expanded Uncertainty on Return Loss
400-6000MHz	0.1 dB

5.2 DIMENSION MEASUREMENT

The following uncertainties apply to the dimension measurements:

Length (mm)	Expanded Uncertainty on Length
3-300	0.05mm

5.3 VALIDATION MEASUREMENT

The guidelines outlined in the IEEE 1528, OET 65 Bulletin C, CENELEC EN50361 and CEI/IEC 62209 standards were followed to generate the measurement uncertainty for validation measurements.

Scan Volume	Expanded Uncertainty
1 g	16.19 %
10 g	15.86 %

6. CALIBRATION MEASUREMENT RESULTS

6.1 RETURN LOSS AND IMPEDANCE IN HEAD LIQUID

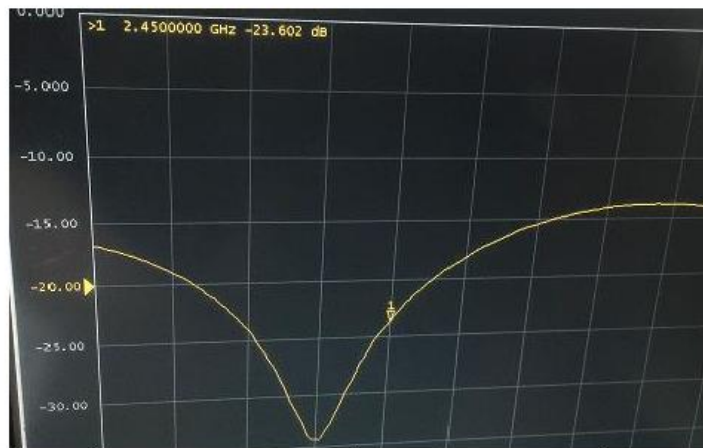

Frequency (MHz)	Return Loss (dB)	Requirement (dB)	Impedance(Ω)	
			Real	Imaginary part
2450	-23.60	-20	26.20	8.63

6.2 RETURN LOSS AND IMPEDANCE IN BODY LIQUID

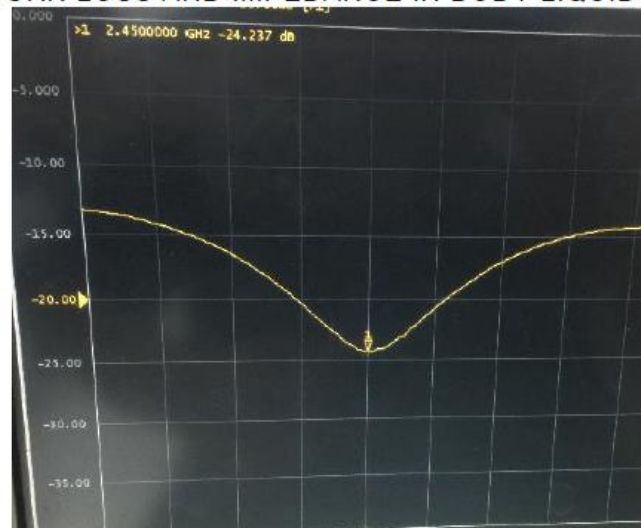

Frequency (MHz)	Return Loss (dB)	Requirement (dB)	Impedance(Ω)	
			Real	Imaginary part
2450	-24.24	-20	24.32	10.2

6.3 MECHANICAL DIMENSIONS

Frequency MHz	L mm		h mm		d mm	
	required	measured	required	measured	required	measured
300	420.0 ±1 %.		250.0 ±1 %.		6.35 ±1 %.	
450	290.0 ±1 %.		166.7 ±1 %.		6.35 ±1 %.	
750	176.0 ±1 %.		100.0 ±1 %.		6.35 ±1 %.	
835	161.0 ±1 %.		89.8 ±1 %.		3.6 ±1 %.	
900	149.0 ±1 %.		83.3 ±1 %.		3.6 ±1 %.	
1450	89.1 ±1 %.		51.7 ±1 %.		3.6 ±1 %.	
1500	80.5 ±1 %.		50.0 ±1 %.		3.6 ±1 %.	
1640	79.0 ±1 %.		45.7 ±1 %.		3.6 ±1 %.	
1750	75.2 ±1 %.		42.9 ±1 %.		3.6 ±1 %.	
1800	72.0 ±1 %.		41.7 ±1 %.		3.6 ±1 %.	
1900	68.0 ±1 %.		39.5 ±1 %.		3.6 ±1 %.	
1950	66.3 ±1 %.		38.5 ±1 %.		3.6 ±1 %.	
2000	64.5 ±1 %.		37.5 ±1 %.		3.6 ±1 %.	
2100	61.0 ±1 %.		35.7 ±1 %.		3.6 ±1 %.	
2300	55.5 ±1 %.		32.6 ±1 %.		3.6 ±1 %.	
2450	51.5 ±1 %.	pass	30.4 ±1 %.	pass	3.6 ±1 %.	pass
2600	48.5 ±1 %.		28.8 ±1 %.		3.6 ±1 %.	
3000	41.5 ±1 %.		25.0 ±1 %.		3.6 ±1 %.	
3500	37.0 ±1 %.		26.4 ±1 %.		3.6 ±1 %.	
3700	34.7 ±1 %.		26.4 ±1 %.		3.6 ±1 %.	

7. VALIDATION MEASUREMENT

The IEEE Std. 1528, OET 65 Bulletin C and CEI/IEC 62209 standards state that the system validation measurements must be performed using a reference dipole meeting the fore mentioned return loss and mechanical dimension requirements. The validation measurement must be performed against a liquid filled flat phantom, with the phantom constructed as outlined in the fore mentioned standards. Per the standards, the dipole shall be positioned below the bottom of the phantom, with the dipole length centered and parallel to the longest dimension of the flat phantom, with the top surface of the dipole at the described distance from the bottom surface of the phantom.

7.1 HEAD LIQUID MEASUREMENT

Frequency MHz	Relative permittivity(r')		Conductivity (σ) S/m	
	required	measured	required	measured
300	45.3 ±5 %		0.87 ±5 %	
450	45.3 ±5 %		0.87 ±5 %	
750	41.9 ±5 %		0.89 ±5 %	
835	41.5 ±5 %		0.90 ±5 %	
900	41.5 ±5 %		0.97 ±5 %	
1450	40.5 ±5 %		1.20 ±5 %	
1500	40.4 ±5 %		1.23 ±5 %	
1640	40.2 ±5 %		1.31 ±5 %	
1750	40.1 ±5 %		1.37 ±5 %	
1800	40.0 ±5 %		1.40 ±5 %	

1900	40.0 ±5 %		1.40 ±5 %	
1950	40.0 ±5 %		1.40 ±5 %	
2000	40.0 ±5 %		1.40 ±5 %	
2100	39.8 ±5 %		1.49 ±5 %	
2300	39.5 ±5 %		1.67 ±5 %	
2450	39.2 ±5 %	pass	1.80 ±5 %	pass
2600	39.0 ±5 %		1.96 ±5 %	
3000	38.5 ±5 %		2.40 ±5 %	
3500	37.9 ±5 %		2.91 5 %	

7.2 SAR MEASUREMENT RESULT WITH HEAD LIQUID

The IEEE Std. 1528 and CEI/IEC 62209 standards state that the system validation measurements should produce the SAR values shown below (for phantom thickness of 2 mm), within the uncertainty for the system validation. All SAR values are normalized to 1 W forward power. In bracket, the measured SAR is given with the used input power.

Software	OPENSAR V4
Phantom	SN 40/14 SAM117
Probe	SN 17/14 EP220
Liquid	Head Liquid Values: eps' : 38.0 sigma : 1.84
Distance between dipole center and liquid	10.0 mm
Area scan resolution	dx=8mm/dy=8mm
Zoon Scan Resolution	dx=8mm/dy=8m/dz=5mm
Frequency	2450 MHz
Input power	20 dBm
Liquid Temperature	22 °C
Lab Temperature	22 °C
Lab Humidity	45%

Frequency MHz	1 g SAR (W/kg/W)		10 g SAR (W/kg/W)	
	required	measured	required	measured
300	2.85		1.94	
450	4.85		3.06	
750	8.49		5.55	
835	9.56		6.22	
900	10.9		6.99	
1450	29		16	
1500	30.5		16.8	
1640	34.2		18.4	
1750	36.4		19.3	
1800	38.4		20.1	
1900	39.7		20.5	
1950	40.5		20.9	
2000	41.1		21.1	
2100	43.6		21.9	
2300	48.7		23.3	
2450	52.4	55.19(5.52)	24	24.96(2.50)
2600	55.3		24.6	

3000	63.8		25.7	
3500	67.1		25	

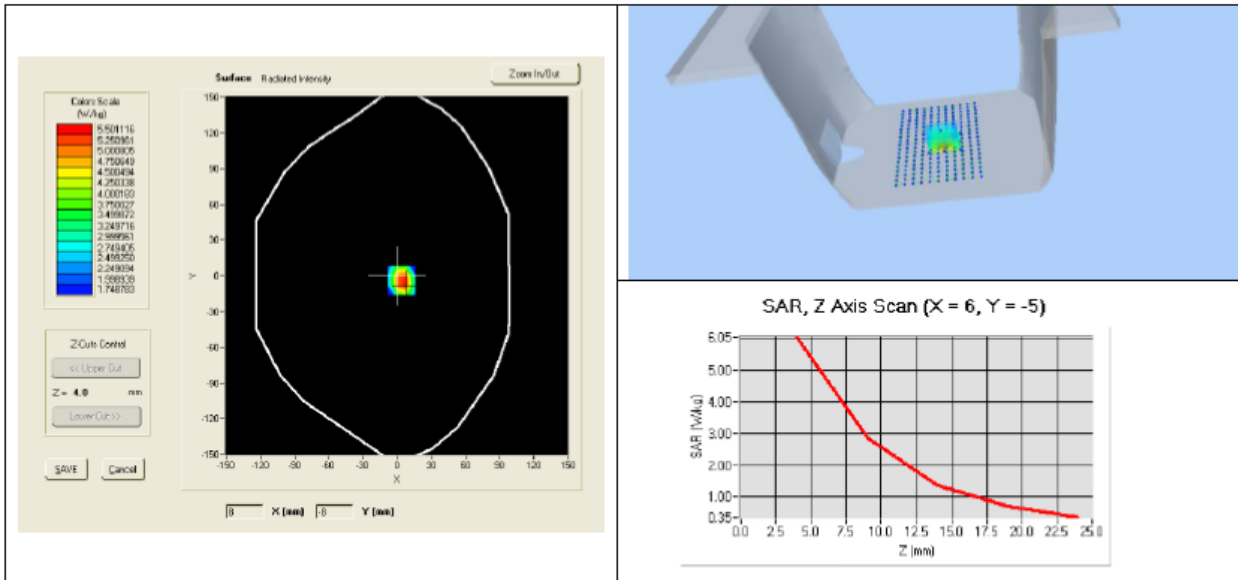

7.3 BODY LIQUID MEASUREMENT

Frequency MHz	Relative permittivity(ϵ')		Conductivity (σ) S/m	
	required	measured	required	measured
300	58.2 \pm 5 %		0.92 \pm 5 %	
450	56.7 \pm 5 %		0.94 \pm 5 %	
750	55.5 \pm 5 %		0.96 \pm 5 %	
835	55.2 \pm 5 %		0.97 \pm 5 %	
900	55.0 \pm 5 %		1.05 \pm 5 %	
915	55.0 \pm 5 %		1.06 \pm 5 %	
1450	54.0 \pm 5 %		1.30 \pm 5 %	
1610	53.8 \pm 5 %		1.40 \pm 5 %	
1800	53.3 \pm 5 %		1.52 \pm 5 %	
1900	53.3 \pm 5 %		1.52 \pm 5 %	
2000	53.3 \pm 5 %		1.52 \pm 5 %	
2100	53.2 \pm 5 %		1.62 \pm 5 %	
2450	52.7 \pm 5 %	Pass	1.95 \pm 5 %	Pass
2600	52.5 \pm 5 %		2.16 \pm 5 %	
3000	52.0 \pm 5 %		2.73 \pm 5 %	
3500	51.3 \pm 5 %		3.31 \pm 5 %	
5200	49.0 \pm 5 %		5.30 \pm 5 %	
5300	48.9 \pm 5 %		5.42 \pm 5 %	
5400	48.7 \pm 5 %		5.53 \pm 5 %	
5500	48.6 \pm 5 %		5.65 \pm 5 %	
5600	48.5 \pm 5 %		5.77 \pm 5 %	
5800	48.2 \pm 5 %		6.00 \pm 5 %	

7.4 SAR MEASUREMENT RESULT WITH BODY LIQUID

Software	OPENSAR V4
Phantom	SN 40/14 SAM117
Probe	SN 17/14 EP220
Liquid	Body Liquid Values: ϵ_s' :51.7 sigma : 1.93
Distance between dipole center and liquid	10.0 mm
Area scan resolution	dx=8mm/dy=8mm
Zoon Scan Resolution	dx=8mm/dy=8m/dz=5mm
Frequency	2450 MHz
Input power	20 dBm
Liquid Temperature	22 °C
Lab Temperature	22 °C
Lab Humidity	45 %

Frequency MHz	1 g SAR (W/kg/W) measured	10 g SAR (W/kg/W) measured
2450	52.85(5.29)	24.78(2.48)

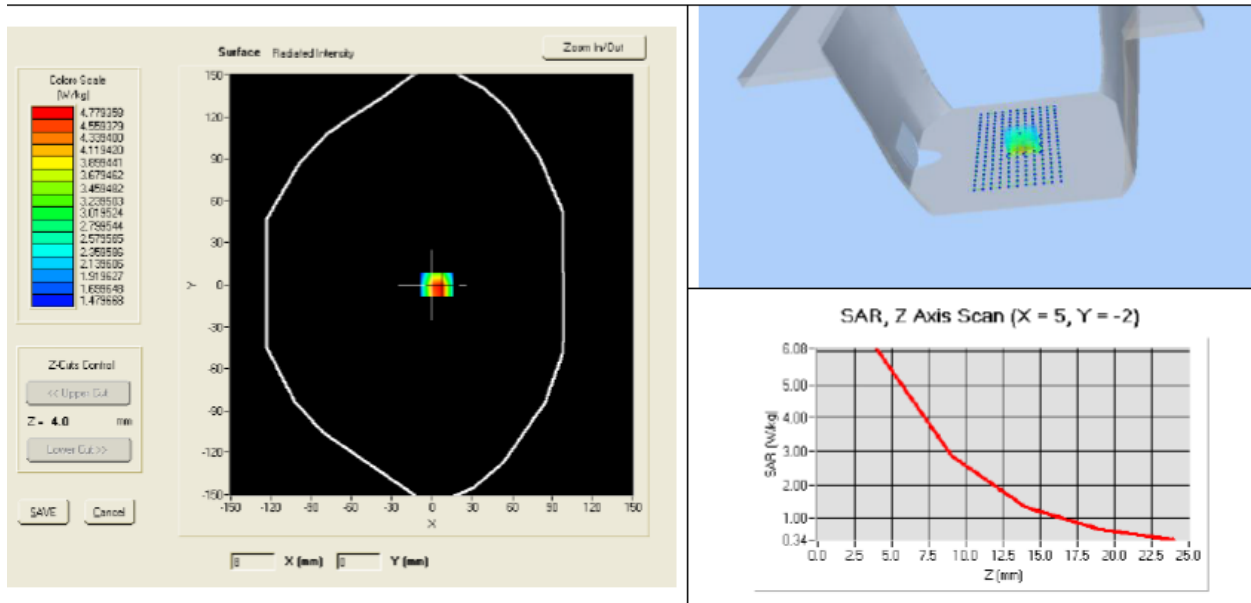

8. LIST OF EQUIPMENT

Equipment Summary Sheet				
Equipment Description	Manufacturer / Model	Identification No.	Current Calibration Date	Next Calibration Date
Flat Phantom	Satimo	SN 40/14 SAM117	Validated. No cal required.	Validated. No cal required.
COMOSAR Test Bench	Version 3	NA	Validated. No cal required.	Validated. No cal required.
Network Analyzer	Agilent	8753E	2015/11/27	2016/11/28
Reference Probe	Satimo	EP220 SN 17/14	2015/10/01	2016/10/01
Multimeter	Keithley	2000	2016/02/27	2017/02/28
Signal Generator	Agilent	E4432B	2016/04/09	2017/04/08
Power Meter with USB connection to PC/Software	R & S	NRP-Z23	2016/06/17	2017/06/16
Temperature and Humidity Sensor	JM	JM222	2016/06/06	2017/06/05
ROBOT	KUKA	501207	Validated. No cal required.	Validated. No cal required.