

TEST REPORT

ACCORDING TO: FCC 47CFR part 15 subpart C § 15.247 and subpart B

FOR:

Telematics Wireless Ltd.
2-Way RF communicator
Model:ICON240V

This report is in conformity with ISO/IEC 17025. The A2LA logo endorsement applies only to the test methods and the standards that are listed in the scope of Hermon Laboratories accreditation. The test results relate only to the items tested. This test report shall not be reproduced in any form except in full with the written approval of Hermon Laboratories Ltd.

Table of contents

1	Applicant information	3
2	Equipment under test attributes	3
3	Manufacturer information	3
4	Test details	3
5	Tests summary	4
6	EUT description	5
6.1	General information	5
6.2	Ports and lines	5
6.3	Operating frequencies	5
6.4	Changes made in the EUT	5
6.5	Test configuration	5
6.6	Transmitter characteristics	6
7	Transmitter tests according to 47CFR part 15 subpart C requirements	7
7.1	Minimum 6 dB bandwidth	7
7.2	Peak output power	9
7.3	Field strength of spurious emissions	13
7.4	Peak spectral power density	30
7.5	Conducted emissions	34
8	Emission tests according to 47CFR part 15 subpart B requirements	37
8.1	Conducted emissions	37
8.2	Radiated emission measurements	40
9	APPENDIX A Test equipment and ancillaries used for tests	45
10	APPENDIX B Test facility description	46
11	APPENDIX C Specification references	46
12	APPENDIX D Test equipment correction factors	47
13	APPENDIX E Measurement uncertainties	55
14	APPENDIX F Abbreviations and acronyms	56

1 Applicant information

Client name: Telematics Wireless Ltd.
Address: 26 Hamelaha street, POB 1911, Holon, 58117, Israel
Telephone: +972 3557 5767
Fax: +972 3557 5753
E-mail: slavas@telematics-wireless.com
Contact name: Mr. Slava Snitkovsky

2 Equipment under test attributes

Product name: 2-way RF communicator (electricity meter)
Product type: Transceiver
Model(s): ICON240V
Serial number: 70830671
Hardware version: ISA1
Software release: 01E10
Receipt date: 2/14/2007

3 Manufacturer information

Manufacturer name: Telematics Wireless Ltd.
Address: 26 Hamelaha street, POB 1911, Holon, 58117, Israel
Telephone: +972 3557 5767
Fax: +972 3557 5753
E-Mail: slavas@telematics-wireless.com
Contact name: Mr. Slava Snitkovsky



4 Test details

Project ID: 17738
Location: Hermon Laboratories Ltd. P.O.Box 23, Binyamina 30550, Israel
Test started: 2/14/2007
Test completed: 2/28/2007
Test specification(s): FCC 47CFR part 15:2005, subpart C §§15.247; subpart B

5 Tests summary

Test	Status
Transmitter characteristics	
Section 15.247(a)2, 6 dB bandwidth	Pass
Section 15.247(b)3, Peak output power	Pass
Section 15.247(e)(i), RF exposure	Pass, the exhibit to the application of certification is provided
Section 15.247(d), Radiated spurious emissions	Pass
Section 15.247(e), Peak power density	Pass
Section 15.207(a), Conducted emission	Pass
Unintentional emissions	
Section 15.107, Conducted emission at AC power port	Pass
Section 15.109, Radiated emission	Pass

Testing was completed against all relevant requirements of the test standard. The results obtained indicate that the product under test complies in full with the requirements tested. The test results relate only to the items tested. Pass/ fail decision was based on nominal values.

	Name and Title	Date	Signature
Tested by:	Mr. A. Lane, test engineer	February 28, 2007	
Reviewed by:	Mrs. M. Cherniavsky, certification engineer	March 7, 2007	
Approved by:	Mr. M. Nikishin, EMC and Radio group leader	March 8, 2007	



6 EUT description

6.1 General information

The EUT, 2-way RF communicator, is an electricity meter transceiver, including the AMR (Automatic Meter Reading) module for RF communication.

The meter readings are displayed on an internal LCD unit and are transmitted by its RF part to a collecting unit. In addition the specific parameters can be programmed via the RF link.

6.2 Ports and lines

Port type	Port description	Connected		Connector type	Qty.	Cable type	Cable length
		From	To				
Power	AC	EUT	mains	IEC 60320	1	unshielded	1.5 m

6.3 Operating frequencies

Source	Frequency, MHz
Transmitter	916.3
Clock	26

6.4 Changes made in the EUT

No changes were implemented.

6.5 Test configuration

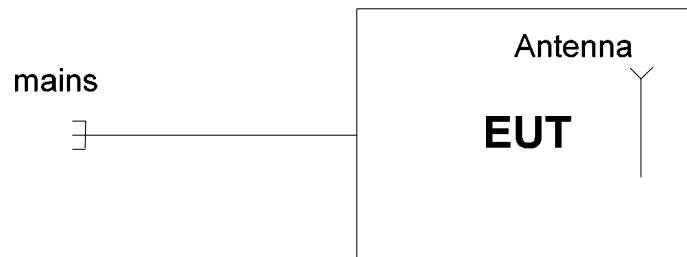



6.6 Transmitter characteristics

Type of equipment					
	Stand-alone (Equipment with or without its own control provisions)				
X	Combined equipment (Equipment where the radio part is fully integrated within another type of equipment)				
	Plug-in card (Equipment intended for a variety of host systems)				
Intended use		Condition of use			
	fixed	Always at a distance more than 2 m from all people			
X	mobile	Always at a distance more than 20 cm from all people			
	portable	May operate at a distance closer than 20 cm to human body			
Assigned frequency range		902-928 MHz			
Operating frequency range		916.3 MHz			
RF channel spacing		NA			
Maximum rated output power		At transmitter 50 Ω RF output connector			NA
		Effective radiated power (for equipment with no RF connector)			9.8 dBm
Is transmitter output power variable?		X	No		
			Yes		
			continuous variable		
			stepped variable with stepsize		
		minimum RF power			dBm
		maximum RF power			dBm
Antenna connection					
	unique coupling	standard connector	X	integral	
					with temporary RF connector
					X without temporary RF connector
Antenna/s technical characteristics					
Type	Manufacturer	Model number		Gain	
Unique coupling	Telematics wireless	Printed inverted F antenna		4 dBi	
Transmitter aggregate data rate/s		120 kbps			
Transmitter aggregate symbol (baud) rate/s		NA			
Type of modulation		FSK			
Modulating test signal (baseband)		PRBS			
Maximum transmitter duty cycle in normal use		0.12%			
Transmitter duty cycle supplied for test		8%	Tx ON time	3.9 msec	Period 54.5 msec
Transmitter power source					
	Battery	Nominal rated voltage	VDC	Battery type	Lithium
	DC	Nominal rated voltage	VDC		
X	AC mains	Nominal rated voltage	120VAC	Frequency	60 Hz
Common power source for transmitter and receiver			X	yes	no

Test specification: Section 15.247(a)2, 6 dB bandwidth			
Test procedure: FR Vol.62, page 26243, Section 15.247(a)2			
Test mode: Compliance	Verdict: PASS		
Date & Time: 2/20/2007 2:24:30 PM			
Temperature: 20°C	Air Pressure: 1010 hPa	Relative Humidity: 48%	Power Supply: 120 V AC
Remarks:			

7 Transmitter tests according to 47CFR part 15 subpart C requirements

7.1 Minimum 6 dB bandwidth

7.1.1 General

This test was performed to measure 6 dB bandwidth of the EUT carrier frequency. Specification test limits are given in Table 7.1.1.

Table 7.1.1 The 6 dB bandwidth limits

Assigned frequency, MHz	Modulation envelope reference points*, dBc	Minimum bandwidth, kHz
902.0 – 928.0	6.0	500.0
2400.0 – 2483.5		
5725.0 – 5850.0		

* - Modulation envelope reference points provided in terms of attenuation below the peak of modulated carrier.

7.1.2 Test procedure

7.1.2.1 The EUT was set up as shown in Figure 7.1.1, energized and its proper operation was checked.

7.1.2.2 The EUT was set to transmit modulated carrier.

7.1.2.3 The transmitter minimum 6 dB bandwidth was measured with spectrum analyzer as frequency delta between reference points on modulation envelope and provided in Table 7.1.2 and associated plot.

Figure 7.1.1 The 6 dB bandwidth test setup



Test specification:		Section 15.247(a)2, 6 dB bandwidth	
Test procedure:		FR Vol.62, page 26243, Section 15.247(a)2	
Test mode:	Compliance	Verdict:	PASS
Date & Time:	2/20/2007 2:24:30 PM		
Temperature: 20°C	Air Pressure: 1010 hPa	Relative Humidity: 48%	Power Supply: 120 V AC
Remarks:			

Table 7.1.2 The 6 dB bandwidth test results

ASSIGNED FREQUENCY BAND: 902 - 928 MHz
 DETECTOR USED: Peak
 SWEEP MODE: Single
 SWEEP TIME: Auto
 RESOLUTION BANDWIDTH: 100 kHz
 VIDEO BANDWIDTH: 300 kHz
 MODULATION ENVELOPE REFERENCE POINTS: 6.0 dBc

MODULATION: FSK
 MODULATING SIGNAL: PRBS

Carrier frequency, MHz	6 dB bandwidth, kHz	Limit, kHz	Margin, kHz	Verdict
916.3	610	500.0	110	Pass

Reference numbers of test equipment used

HL 0521	HL 0604						
---------	---------	--	--	--	--	--	--

Full description is given in Appendix A.

Plot 7.1.1 The 6 dB bandwidth test result, FSK modulation

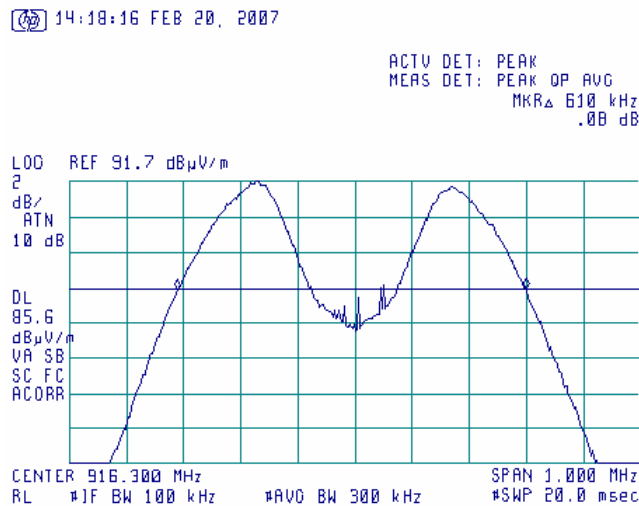

Test specification:	Section 15.247(b)3, Peak output power		
Test procedure:	FR Vol.62, page 26243, Section 15.247(b)		
Test mode:	Compliance	Verdict:	PASS
Date & Time:	2/20/2007 1:31:23 PM		
Temperature: 20°C	Air Pressure: 1010 hPa	Relative Humidity: 48%	Power Supply: 120 V AC
Remarks:			

7.2 Peak output power

7.2.1 General

This test was performed to measure the maximum peak output power radiated by transmitter. Specification test limits are given in Table 7.2.1.

Table 7.2.1 Peak output power limits

Assigned frequency range, MHz	Maximum antenna gain, dBi	Peak output power*		Equivalent field strength limit @ 3m, dB(μV/m)**
		W	dBm	
902.0 – 928.0	6.0	1.0	30.0	131.2
2400.0 – 2483.5				
5725.0 – 5850.0				

*- The limit is provided in terms of conducted RF power at the antenna connector. If transmitting antennas of directional gain greater than 6 dBi are used, the peak output power limit shall be reduced below the stated value as follows:

- by 1 dB for every 3 dB that the directional gain of antenna exceeds 6 dBi for fixed point-to-point transmitters operate in 2400-2483.5 MHz band;
- without any corresponding reduction for fixed point-to-point transmitters operate in 5725-5850 MHz band;
- by the amount in dB that the directional gain of antenna exceeds 6 dBi for the rest of transmitters.

**- Equivalent field strength limit was calculated from the peak output power as follows: $E = \sqrt{30 \times P \times G} / r$, where P is peak output power in Watts, r is antenna to EUT distance in meters and G is transmitter antenna gain in dBi.

7.2.2 Test procedure

7.2.2.1 The EUT was set up as shown in Figure 7.2.1, energized and its proper operation was checked.

7.2.2.2 The EUT was adjusted to produce maximum available to end user RF output power.

7.2.2.3 The resolution bandwidth of spectrum analyzer was set wider than 6 dB bandwidth of the EUT and the field strength of the EUT carrier frequency was measured with antenna connected to spectrum analyzer/ EMI receiver. To find maximum radiation the turntable was rotated 360° and the measuring antenna height was swept in both vertical and horizontal polarizations.

7.2.2.4 The maximum field strength of the EUT carrier frequency was measured as provided in Table 7.2.2 and associated plots.

7.2.2.5 The maximum peak output power was calculated from the field strength of carrier as follows:

$$P = (E \times d)^2 / (30 \times G),$$

where P is the peak output power in W, E is the field strength in V/m, d is the test distance and G is the transmitter numeric antenna gain over an isotropic radiator.

The above equation was converted in logarithmic units for 3 m test distance:

$$\text{Peak output power in dBm} = \text{Field strength in dB}(\mu\text{V/m}) - \text{Transmitter antenna gain in dBi} - 95.2 \text{ dB}$$

7.2.2.6 The worst test results (the lowest margins) were recorded in Table 7.2.2.

Test specification:	Section 15.247(b)3, Peak output power		
Test procedure:	FR Vol.62, page 26243, Section 15.247(b)		
Test mode:	Compliance	Verdict:	PASS
Date & Time:	2/20/2007 1:31:23 PM		
Temperature: 20°C	Air Pressure: 1010 hPa	Relative Humidity: 48%	Power Supply: 120 V AC
Remarks:			

Figure 7.2.1 Setup for carrier field strength measurements

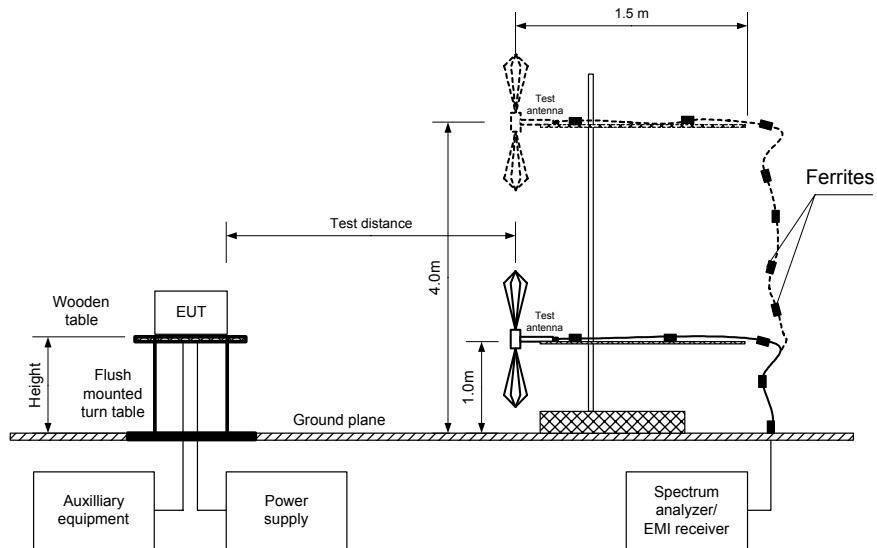

Test specification:		Section 15.247(b)3, Peak output power	
Test procedure: FR Vol.62, page 26243, Section 15.247(b)			
Test mode:	Compliance	Verdict:	PASS
Date & Time:	2/20/2007 1:31:23 PM		
Temperature: 20°C	Air Pressure: 1010 hPa	Relative Humidity: 48%	Power Supply: 120 V AC
Remarks:			

Table 7.2.2 Peak output power test results

ASSIGNED FREQUENCY: 902 - 928 MHz
TEST DISTANCE: 3 m
TEST SITE: Semi anechoic chamber
EUT HEIGHT: 0.8 m
DETECTOR USED: Peak
TEST ANTENNA TYPE: Biconilog
MODULATION: FSK
MODULATING SIGNAL: PRBS
BIT RATE: 120 kbps
TRANSMITTER OUTPUT POWER SETTINGS: Maximum
DETECTOR USED: Peak
EUT 6 dB BANDWIDTH: 580 kHz
RESOLUTION BANDWIDTH: 3 MHz
VIDEO BANDWIDTH: 3 MHz

Frequency, MHz	Field strength, dB(μV/m)	Antenna polarization	Antenna height, m	Azimuth, degrees*	EUT antenna gain, dBi	Peak output power, dBm**	Limit, dBm	Margin, dB***	Verdict
916.80	109.00	Vertical	1.0	12	4.0	9.80	30	-20.20	Pass
916.35	104.95	Horizontal	1.4	07	4.0	5.75	30	-24.25	Pass

*- EUT front panel refer to 0 degrees position of turntable.

** - Peak output power was calculated from the field strength of carrier as follows: $P = (E \times d)^2 / (30 \times G)$, where P is the peak output power in W, E is the field strength in V/m, d is the test distance in meters and G is the transmitter numeric antenna gain over an isotropic radiator. The above equation was converted in logarithmic units for 3 m test distance: *Peak output power in dBm = Field strength in dB(μV/m) - Transmitter antenna gain in dBi - 95.2 dB*

*** - Margin = Peak output power – specification limit.

Reference numbers of test equipment used

HL 0465	HL 0521	HL 0589	HL 0593	HL 0594	HL 0604	HL 1424	HL 1947
HL 2009	HL 2259						

Full description is given in Appendix A.

Test specification:	Section 15.247(b)3, Peak output power		
Test procedure:	FR Vol.62, page 26243, Section 15.247(b)		
Test mode:	Compliance	Verdict:	PASS
Date & Time:	2/20/2007 1:31:23 PM		
Temperature: 20°C	Air Pressure: 1010 hPa	Relative Humidity: 48%	Power Supply: 120 V AC
Remarks:			

Plot 7.2.1 Field strength of carrier vertical antenna polarization

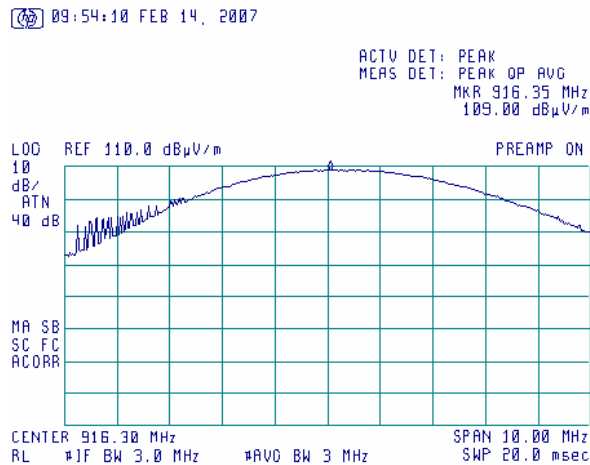

Plot 7.2.2 Field strength of carrier horizontal antenna polarization

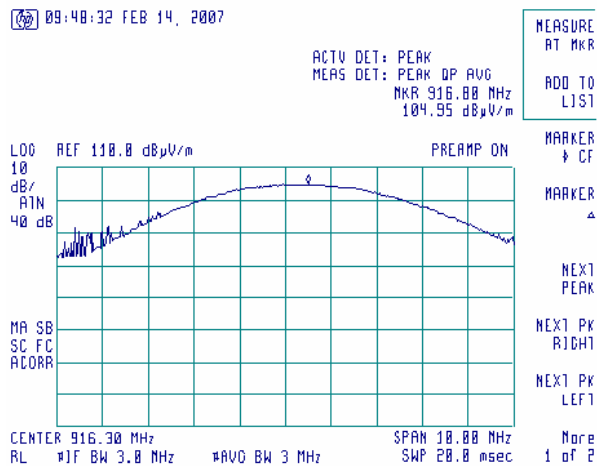

Test specification:		Section 15.247(c), Radiated spurious emissions	
Test procedure:		FR Vol. 62, page 26243, Section 15.247(c) / ANSI C63.4, Section 13.1.4	
Test mode:	Compliance	Verdict:	PASS
Date & Time:	2/27/2007 11:32:24 AM		
Temperature: 20°C	Air Pressure: 1013 hPa	Relative Humidity: 42%	Power Supply: 120 V AC
Remarks:			

7.3 Field strength of spurious emissions

7.3.1 General

This test was performed to measure field strength of spurious emissions from the EUT. Specification test limits are given in Table 7.3.1.

Table 7.3.1 Radiated spurious emissions limits

Frequency, MHz	Field strength at 3 m within restricted bands, dB(μV/m)*			Attenuation of field strength of spurious versus carrier outside restricted bands, dBc***
	Peak	Quasi Peak	Average	
0.009 – 0.090	148.5 – 128.5	NA	128.5 – 108.5**	20.0
0.090 – 0.110	NA	108.5 – 106.8**	NA	
0.110 – 0.490	126.8 – 113.8	NA	106.8 – 93.8**	
0.490 – 1.705	NA	73.8 – 63.0**	NA	
1.705 – 30.0*		69.5		
30 – 88		40.0		
88 – 216		43.5		
216 – 960		46.0		
960 – 1000		54.0		
1000 – 10 th harmonic	74.0	NA	54.0	

*- The limit for 3 m test distance was calculated using the inverse square distance extrapolation factor as follows:

$$\text{Lim}_{S_2} = \text{Lim}_{S_1} + 40 \log(S_1/S_2),$$

where S_1 and S_2 – standard defined and test distance respectively in meters.

** - The limit decreases linearly with the logarithm of frequency.

*** - The field strength limits applied from the lowest radio frequency generated in the device, without going below 9 kHz up to the tenth harmonic of the highest fundamental frequency.

7.3.2 Test procedure for spurious emission field strength measurements in 9 kHz to 30 MHz band

7.3.2.1 The EUT was set up as shown in Figure 7.3.1, energized and the performance check was conducted.

7.3.2.2 The specified frequency range was investigated with antenna connected to spectrum analyzer/ EMI receiver. To find maximum radiation the turntable was rotated 360° and the measuring antenna was rotated around its vertical axis.

7.3.2.3 The worst test results (the lowest margins) were recorded and shown in the associated plots.

7.3.3 Test procedure for spurious emission field strength measurements above 30 MHz

7.3.3.1 The EUT was set up as shown in Figure 7.3.2, energized and the performance check was conducted.

7.3.3.2 The specified frequency range was investigated with antenna connected to spectrum analyzer/ EMI receiver. To find maximum radiation the turntable was rotated 360°, the measuring antenna height was changed from 1 to 4 m, its polarization was switched from vertical to horizontal.

7.3.3.3 The worst test results (the lowest margins) were recorded and shown in the associated plots.

Test specification:	Section 15.247(c), Radiated spurious emissions		
Test procedure:	FR Vol. 62, page 26243, Section 15.247(c) / ANSI C63.4, Section 13.1.4		
Test mode:	Compliance	Verdict:	PASS
Date & Time:	2/27/2007 11:32:24 AM		
Temperature: 20°C	Air Pressure: 1013 hPa	Relative Humidity: 42%	Power Supply: 120 V AC
Remarks:			

Figure 7.3.1 Setup for spurious emission field strength measurements below 30 MHz

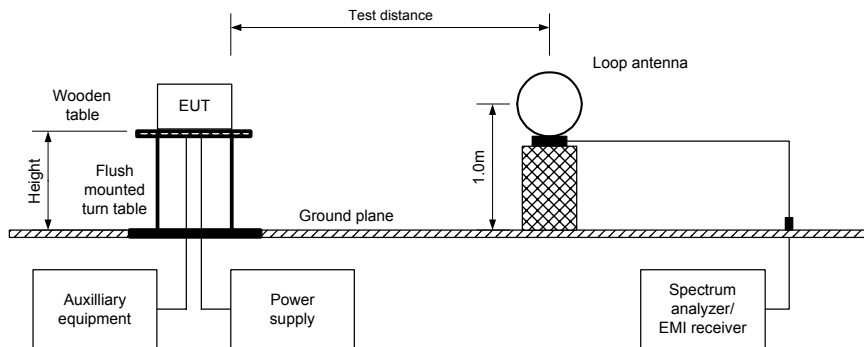
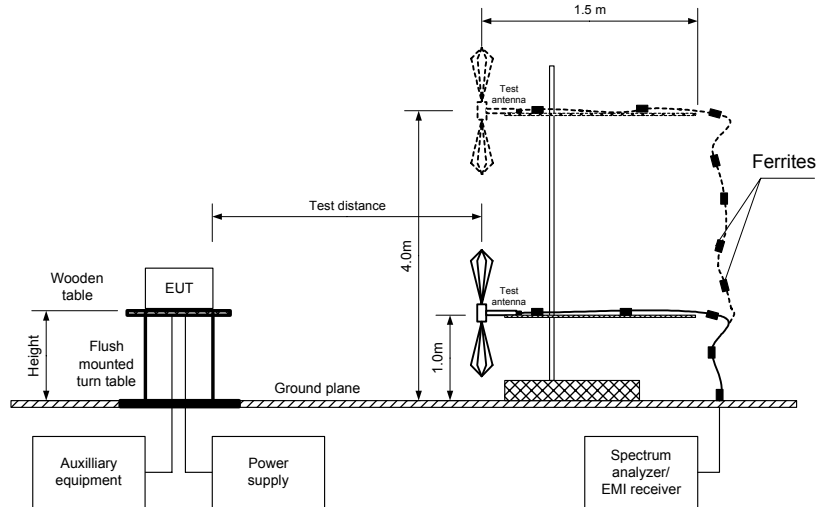

Figure 7.3.2 Setup for spurious emission field strength measurements above 30 MHz



Test specification:		Section 15.247(c), Radiated spurious emissions	
Test procedure:		FR Vol. 62, page 26243, Section 15.247(c) / ANSI C63.4, Section 13.1.4	
Test mode:	Compliance	Verdict:	PASS
Date & Time:	2/27/2007 11:32:24 AM		
Temperature: 20°C	Air Pressure: 1013 hPa	Relative Humidity: 42%	Power Supply: 120 V AC
Remarks:			

Table 7.3.2 Field strength of emissions outside restricted bands

ASSIGNED FREQUENCY: 902-928 MHz
 INVESTIGATED FREQUENCY RANGE: 0.009 – 10000 MHz
 TEST DISTANCE: 3 m
 MODULATION: FSK
 MODULATING SIGNAL: PRBS
 DUTY CYCLE: 8%
 TRANSMITTER OUTPUT POWER SETTINGS: Maximum
 TRANSMITTER OUTPUT POWER: 9.8 dBm at carrier frequency
 DETECTOR USED: Peak
 RESOLUTION BANDWIDTH: 100 kHz
 VIDEO BANDWIDTH: 300 kHz
 TEST ANTENNA TYPE: Active loop (9 kHz – 30 MHz)
 Biconical (30 MHz – 200 MHz)
 Log periodic (200 MHz – 1000 MHz)
 Biconilog (30 MHz – 1000 MHz)
 Double ridged guide (above 1000 MHz)

Frequency, MHz	Field strength of spurious, dB(μV/m)	Antenna polarization	Antenna height, m	Azimuth, degrees*	Field strength of carrier, dB(μV/m)	Attenuation below carrier, dBc	Limit, dBc	Margin, dB**	Verdict
Carrier frequency 916.3MHz									
5496.9	49.88	H	1.5	98	108.53	58.65	20	-38.65	Pass
6415.5	49.71	H	1.5	103		58.22		-38.22	

*- EUT front panel refers to 0 degrees position of turntable.
 **- Margin = Attenuation below carrier – specification limit.

Test specification:		Section 15.247(c), Radiated spurious emissions	
Test procedure:		FR Vol. 62, page 26243, Section 15.247(c) / ANSI C63.4, Section 13.1.4	
Test mode:	Compliance	Verdict:	PASS
Date & Time:	2/27/2007 11:32:24 AM		
Temperature: 20°C	Air Pressure: 1013 hPa	Relative Humidity: 42%	Power Supply: 120 V AC
Remarks:			

Table 7.3.3 Field strength of spurious emissions above 1 GHz within restricted bands

ASSIGNED FREQUENCY: 902-928 MHz
 INVESTIGATED FREQUENCY RANGE: 1000 – 10000 MHz
 TEST DISTANCE: 3 m
 MODULATION: FSK
 MODULATING SIGNAL: PRBS
 DUTY CYCLE: 8%
 TRANSMITTER OUTPUT POWER SETTINGS: Maximum
 TRANSMITTER OUTPUT POWER: 9.8 dBm at carrier frequency
 DETECTOR USED: Peak
 RESOLUTION BANDWIDTH: 1000 kHz
 TEST ANTENNA TYPE: Double ridged guide

Frequency, MHz	Antenna		Azimuth, degrees*	Peak field strength(VBW=3 MHz)			Average field strength(VBW=1kHz)				Verdict
	Polarization	Height, m		Measured, dB(μV/m)	Limit, dB(μV/m)	Margin, dB**	Measured, dB(μV/m)	Calculated, dB(μV/m)	Limit, dB(μV/m)	Margin, dB***	
Carrier frequency 916.3 MHz											
8246.7	H	1.5	91	55.34	74	-18.66	45.56	23.4	54	-30.6	Pass

*- EUT front panel refers to 0 degrees position of turntable.

**- Margin = Measured field strength - specification limit.

***- Margin = Calculated field strength - specification limit,
 where Calculated field strength = Measured field strength + average factor.

Table 7.3.4 Average factor calculation

Transmission pulse		Average factor, dB
Duration, ms	Period, ms	
3.90	54.5	-22.16

*- Average factor was calculated as follows
 for pulse train longer than 100 ms:

$$Average\ factor = 20 \times \log_{10} \left(\frac{Pulse\ duration}{Pulse\ period} \times \frac{Burst\ duration}{100\ ms} \times Number\ of\ bursts\ within\ 100\ ms \right)$$

Test specification:		Section 15.247(c), Radiated spurious emissions	
Test procedure:		FR Vol. 62, page 26243, Section 15.247(c) / ANSI C63.4, Section 13.1.4	
Test mode:	Compliance	Verdict:	PASS
Date & Time:	2/27/2007 11:32:24 AM		
Temperature: 20°C	Air Pressure: 1013 hPa	Relative Humidity: 42%	Power Supply: 120 V AC
Remarks:			

Table 7.3.5 Field strength of spurious emissions below 1 GHz within restricted bands

ASSIGNED FREQUENCY: 902-928 MHz
 INVESTIGATED FREQUENCY RANGE: 0.009 – 1000 MHz
 TEST DISTANCE: 3 m
 MODULATION: FSK
 MODULATING SIGNAL: PRBS
 DUTY CYCLE: 7%
 TRANSMITTER OUTPUT POWER SETTINGS: Maximum
 RESOLUTION BANDWIDTH: 0.2 kHz (9 kHz – 150 kHz)
 9.0 kHz (150 kHz – 30 MHz)
 120 kHz (30 MHz – 1000 MHz)
 VIDEO BANDWIDTH: > Resolution bandwidth
 TEST ANTENNA TYPE: Active loop (9 kHz – 30 MHz)
 Biconical (30 MHz – 200 MHz)
 Log periodic (200 MHz – 1000 MHz)
 Biconilog (30 MHz – 1000 MHz)

Frequency, MHz	Peak emission, dB(μV/m)	Quasi-peak			Antenna polarization	Antenna height, m	Turn-table position**, degrees	Verdict
		Measured emission, dB(μV/m)	Limit, dB(μV/m)	Margin, dB*				
Carrier frequency 916.3 MHz								
No spurious were found								Pass

*- Margin = Measured emission - specification limit.

** - EUT front panel refer to 0 degrees position of turntable.

Table 7.3.6 Restricted bands

MHz	MHz	MHz	MHz	MHz	GHz
0.09 - 0.11	8.37625 - 8.38675	73 - 74.6	399.9 - 410	2690 - 2900	10.6 - 12.7
0.495 - 0.505	8.41425 - 8.41475	74.8 - 75.2	608 - 614	3260 - 3267	13.25 - 13.4
2.1735 - 2.1905	12.29 - 12.293	108 - 121.94	960 - 1240	3332 - 3339	14.47 - 14.5
4.125 - 4.128	12.51975 - 12.52025	123 - 138	1300 - 1427	3345.8 - 3358	15.35 - 16.2
4.17725 - 4.17775	12.57675 - 12.57725	149.9 - 150.05	1435 - 1626.5	3600 - 4400	17.7 - 21.4
4.20725 - 4.20775	13.36 - 13.41	156.52475 - 156.52525	1645.5 - 1646.5	4500 - 5150	22.01 - 23.12
6.215 - 6.218	16.42 - 16.423	156.7 - 156.9	1660 - 1710	5350 - 5460	23.6 - 24
6.26775 - 6.26825	16.69475 - 16.69525	162.0125 - 167.17	1718.8 - 1722.2	7250 - 7750	31.2 - 31.8
6.31175 - 6.31225	16.80425 - 16.80475	167.72 - 173.2	2200 - 2300	8025 - 8500	36.43 - 36.5
8.291 - 8.294	25.5 - 25.67	240 - 285	2310 - 2390	9000 - 9200	Above 38.6
8.362 - 8.366	37.5 - 38.25	322 - 335.4	2483.5 - 2500	9300 - 9500	

Reference numbers of test equipment used

HL 0446	HL 0465	HL 0521	HL 0589	HL 0592	HL 0593	HL 0594	HL 0604
HL 1947	HL 2009	HL 2432	HL 2780				

Full description is given in Appendix A.

Test specification:	Section 15.247(c), Radiated spurious emissions		
Test procedure:	FR Vol. 62, page 26243, Section 15.247(c) / ANSI C63.4, Section 13.1.4		
Test mode:	Compliance	Verdict:	PASS
Date & Time:	2/27/2007 11:32:24 AM		
Temperature: 20°C	Air Pressure: 1013 hPa	Relative Humidity: 42%	Power Supply: 120 V AC
Remarks:			

Plot 7.3.1 Radiated emission measurements at the carrier frequency

TEST SITE: Semi anechoic chamber
TEST DISTANCE: 3 m
ANTENNA POLARIZATION: Vertical and Horizontal

10:13:57 FEB 14, 2007

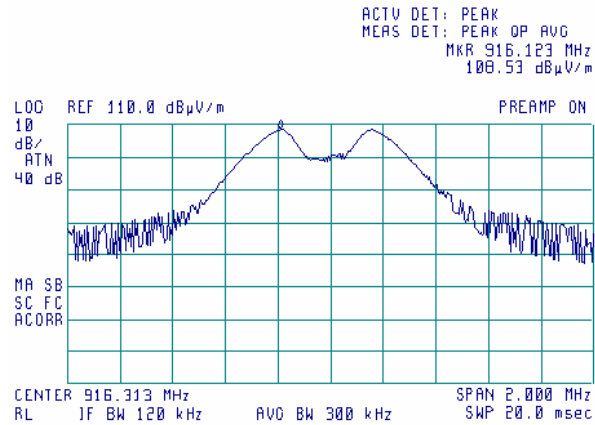

Test specification:	Section 15.247(c), Radiated spurious emissions		
Test procedure:	FR Vol. 62, page 26243, Section 15.247(c) / ANSI C63.4, Section 13.1.4		
Test mode:	Compliance	Verdict:	PASS
Date & Time:	2/27/2007 11:32:24 AM		
Temperature: 20°C	Air Pressure: 1013 hPa	Relative Humidity: 42%	Power Supply: 120 V AC
Remarks:			

Plot 7.3.2 Radiated emission measurements from 9 to 150 kHz at the carrier frequency

TEST SITE: Semi anechoic chamber
TEST DISTANCE: 3 m
ANTENNA POLARIZATION: Vertical

11:33:51 FEB 16, 2007

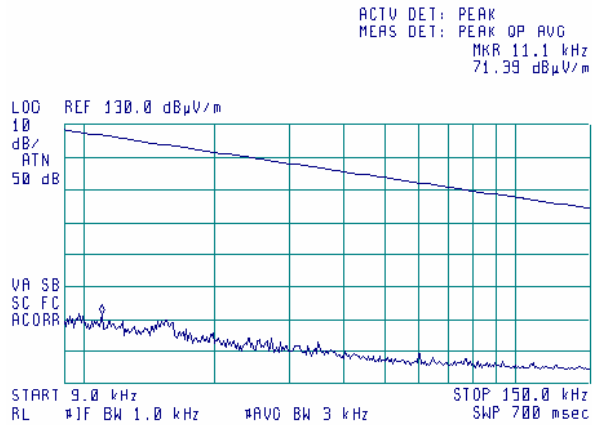

Plot 7.3.3 Radiated emission measurements from 0.15 to 30 MHz at the carrier frequency

TEST SITE: Semi anechoic chamber
TEST DISTANCE: 3 m
ANTENNA POLARIZATION: Vertical

11:38:39 FEB 16, 2007

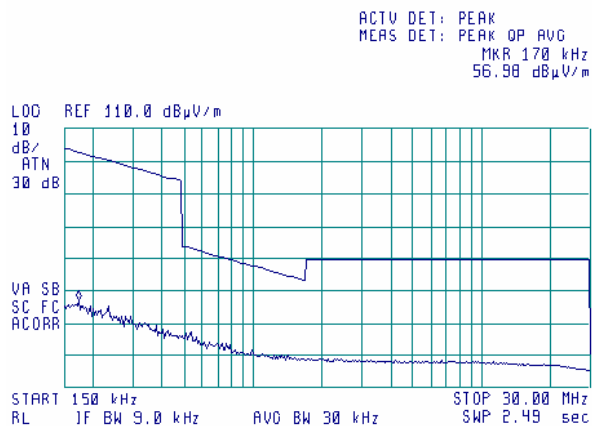

Test specification: Section 15.247(c), Radiated spurious emissions			
Test procedure: FR Vol. 62, page 26243, Section 15.247(c) / ANSI C63.4, Section 13.1.4			
Test mode: Compliance	Verdict: PASS		
Date & Time: 2/27/2007 11:32:24 AM			
Temperature: 20°C	Air Pressure: 1013 hPa	Relative Humidity: 42%	Power Supply: 120 V AC
Remarks:			

Plot 7.3.4 Radiated emission measurements from 30 to 1000 MHz at the carrier frequency

TEST SITE: Semi anechoic chamber
TEST DISTANCE: 3 m
ANTENNA POLARIZATION: Vertical and Horizontal

08:53:17 FEB 14, 2007

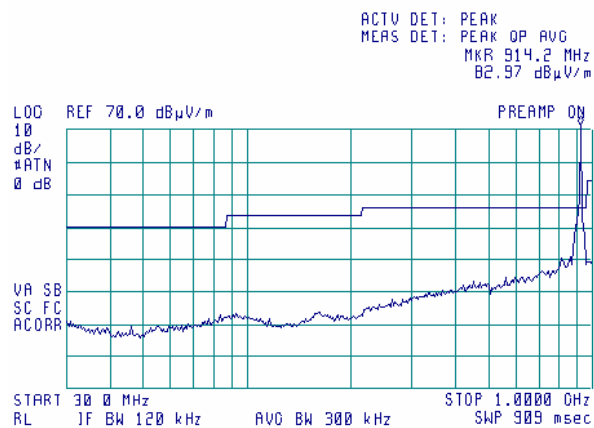

Plot 7.3.5 Radiated emission measurements from 1000 to 2900MHz at the carrier frequency

TEST SITE: Semi anechoic chamber
TEST DISTANCE: 3 m
ANTENNA POLARIZATION: Vertical and Horizontal

13:25:35 FEB 20, 2007

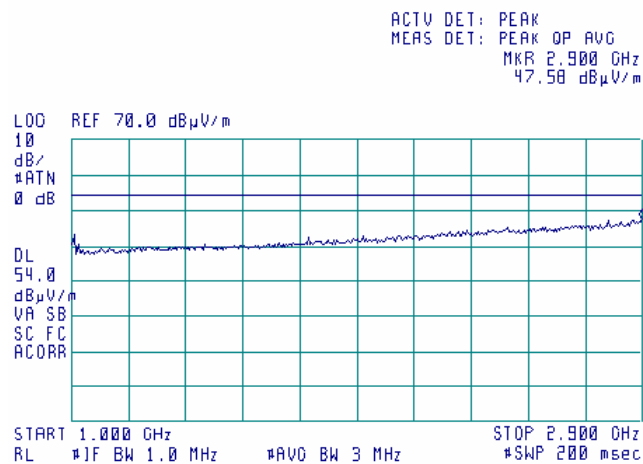

Test specification:	Section 15.247(c), Radiated spurious emissions		
Test procedure:	FR Vol. 62, page 26243, Section 15.247(c) / ANSI C63.4, Section 13.1.4		
Test mode:	Compliance	Verdict:	PASS
Date & Time:	2/27/2007 11:32:24 AM		
Temperature: 20°C	Air Pressure: 1013 hPa	Relative Humidity: 42%	Power Supply: 120 V AC
Remarks:			

Plot 7.3.6 Radiated emission measurements from 2900 to 4000 MHz at the carrier frequency

TEST SITE: Semi anechoic chamber
TEST DISTANCE: 3 m
ANTENNA POLARIZATION: Vertical and Horizontal

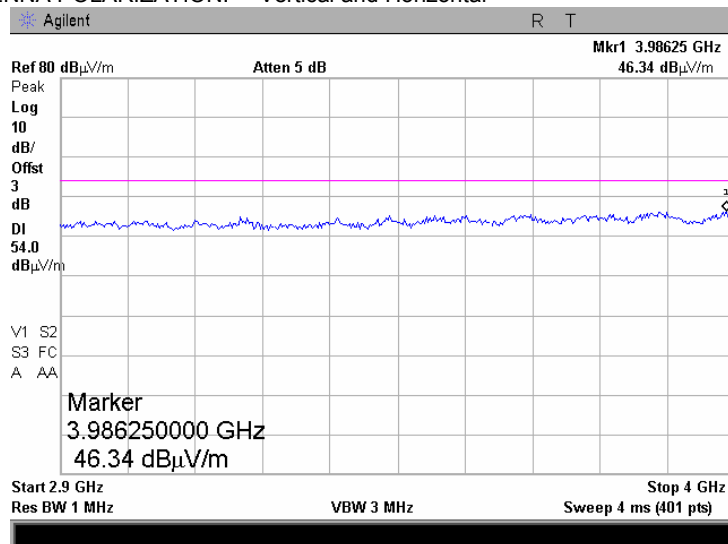

Plot 7.3.7 Radiated emission measurements from 4000 to 8000 MHz at the carrier frequency

TEST SITE: Semi anechoic chamber
TEST DISTANCE: 3 m
ANTENNA POLARIZATION: Vertical and Horizontal

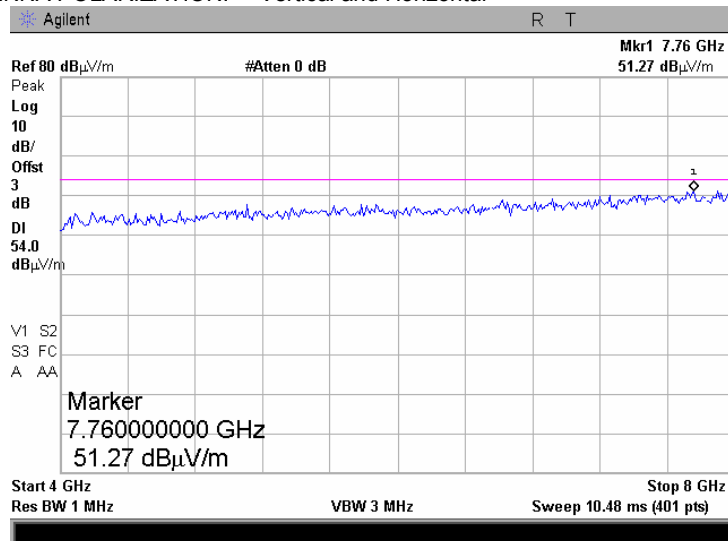

Test specification: Section 15.247(c), Radiated spurious emissions			
Test procedure: FR Vol. 62, page 26243, Section 15.247(c) / ANSI C63.4, Section 13.1.4			
Test mode: Compliance	Verdict: PASS		
Date & Time: 2/27/2007 11:32:24 AM			
Temperature: 20°C	Air Pressure: 1013 hPa	Relative Humidity: 42%	Power Supply: 120 V AC
Remarks:			

Plot 7.3.8 Radiated emission measurements from 8000 to 10000 MHz at the carrier frequency

TEST SITE: Semi anechoic chamber
 TEST DISTANCE: 3 m
 ANTENNA POLARIZATION: Vertical and Horizontal
 DETECTOR: Peak

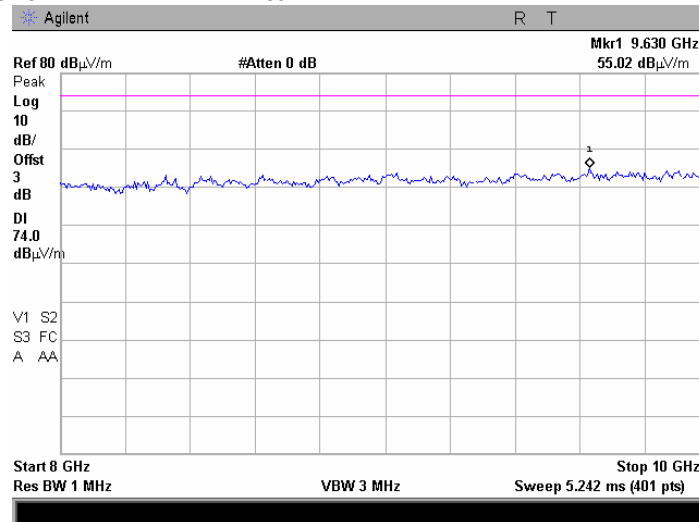

Plot 7.3.9 Radiated emission measurements from 8000 to 10000 MHz at the carrier frequency

TEST SITE: Semi anechoic chamber
 TEST DISTANCE: 3 m
 ANTENNA POLARIZATION: Vertical and Horizontal
 DETECTOR: Average

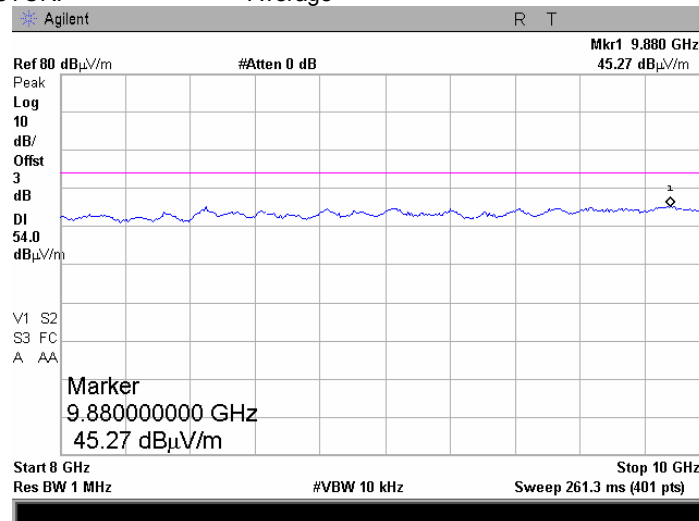

Test specification:	Section 15.247(c), Radiated spurious emissions		
Test procedure:	FR Vol. 62, page 26243, Section 15.247(c) / ANSI C63.4, Section 13.1.4		
Test mode:	Compliance	Verdict:	PASS
Date & Time:	2/27/2007 11:32:24 AM		
Temperature: 20°C	Air Pressure: 1013 hPa	Relative Humidity: 42%	Power Supply: 120 V AC
Remarks:			

Plot 7.3.10 Radiated emission measurements at the second harmonic of carrier frequency

TEST SITE: Semi anechoic chamber
TEST DISTANCE: 3 m
ANTENNA POLARIZATION: Vertical and Horizontal

13:20:48 FEB 16, 2007

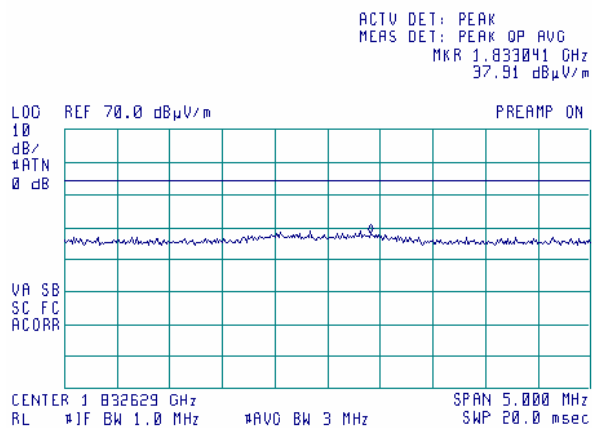

Plot 7.3.11 Radiated emission measurements at the third harmonic of carrier frequency

TEST SITE: OATS
TEST DISTANCE: 3 m
ANTENNA POLARIZATION: Vertical and Horizontal

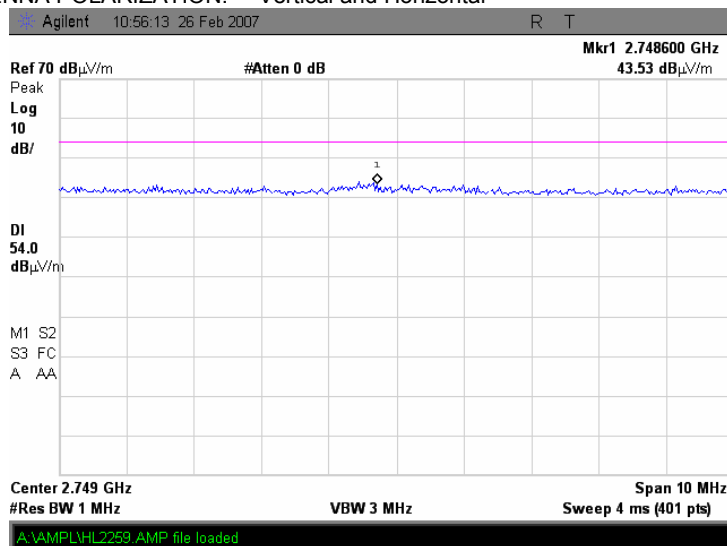

Test specification: Section 15.247(c), Radiated spurious emissions			
Test procedure: FR Vol. 62, page 26243, Section 15.247(c) / ANSI C63.4, Section 13.1.4			
Test mode: Compliance	Verdict: PASS		
Date & Time: 2/27/2007 11:32:24 AM			
Temperature: 20°C	Air Pressure: 1013 hPa	Relative Humidity: 42%	Power Supply: 120 V AC
Remarks:			

Plot 7.3.12 Radiated emission measurements at the fourth harmonic of carrier frequency

TEST SITE: OATS
TEST DISTANCE: 3 m
ANTENNA POLARIZATION: Vertical and Horizontal

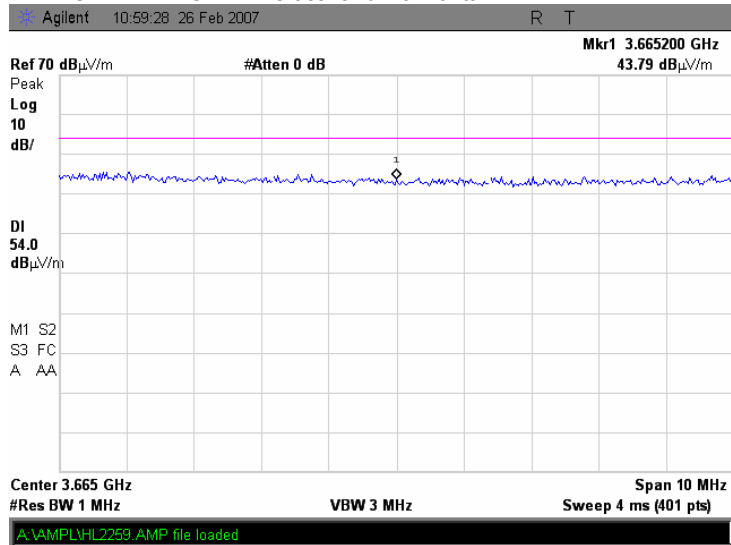

Plot 7.3.13 Radiated emission measurements at the fifth harmonic of carrier frequency

TEST SITE: OATS
TEST DISTANCE: 3 m
ANTENNA POLARIZATION: Vertical and Horizontal

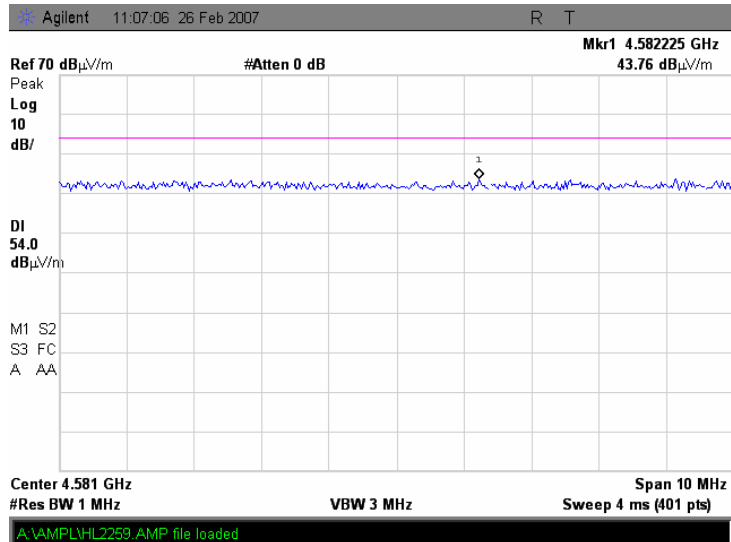

Test specification: Section 15.247(c), Radiated spurious emissions			
Test procedure: FR Vol. 62, page 26243, Section 15.247(c) / ANSI C63.4, Section 13.1.4			
Test mode: Compliance	Verdict: PASS		
Date & Time: 2/27/2007 11:32:24 AM			
Temperature: 20°C	Air Pressure: 1013 hPa	Relative Humidity: 42%	Power Supply: 120 V AC
Remarks:			

Plot 7.3.14 Radiated emission measurements at the sixth harmonic of carrier frequency

TEST SITE: OATS
TEST DISTANCE: 3 m
ANTENNA POLARIZATION: Vertical and Horizontal

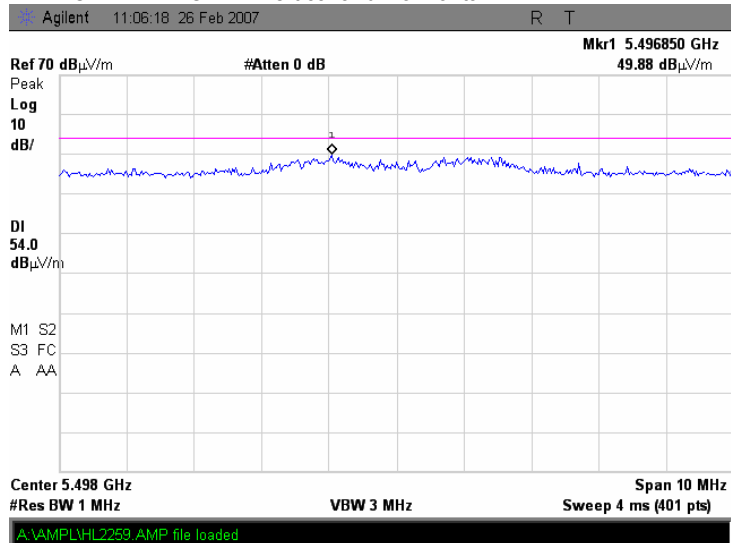

Plot 7.3.15 Radiated emission measurements at the seventh harmonic of mid carrier frequency

TEST SITE: OATS
TEST DISTANCE: 3 m
ANTENNA POLARIZATION: Vertical and Horizontal

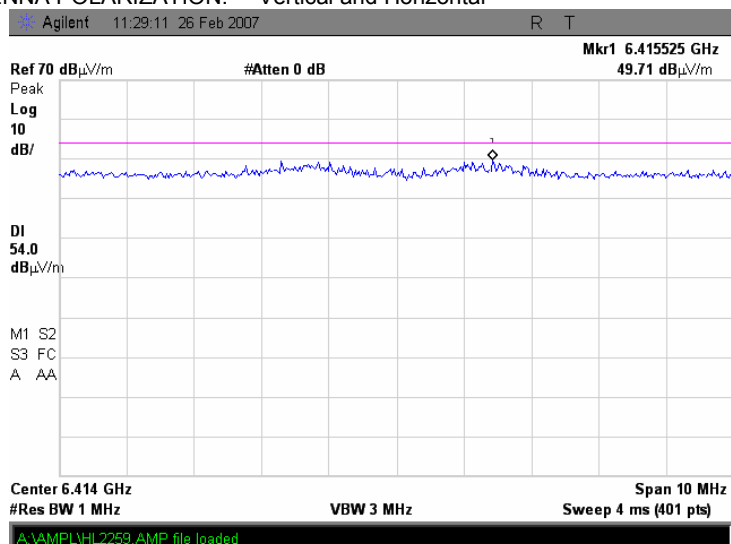

Test specification:	Section 15.247(c), Radiated spurious emissions		
Test procedure:	FR Vol. 62, page 26243, Section 15.247(c) / ANSI C63.4, Section 13.1.4		
Test mode:	Compliance	Verdict:	PASS
Date & Time:	2/27/2007 11:32:24 AM		
Temperature: 20°C	Air Pressure: 1013 hPa	Relative Humidity: 42%	Power Supply: 120 V AC
Remarks:			

Plot 7.3.16 Radiated emission measurements at the eighth harmonic of carrier frequency

TEST SITE: OATS
TEST DISTANCE: 3 m
ANTENNA POLARIZATION: Vertical and Horizontal

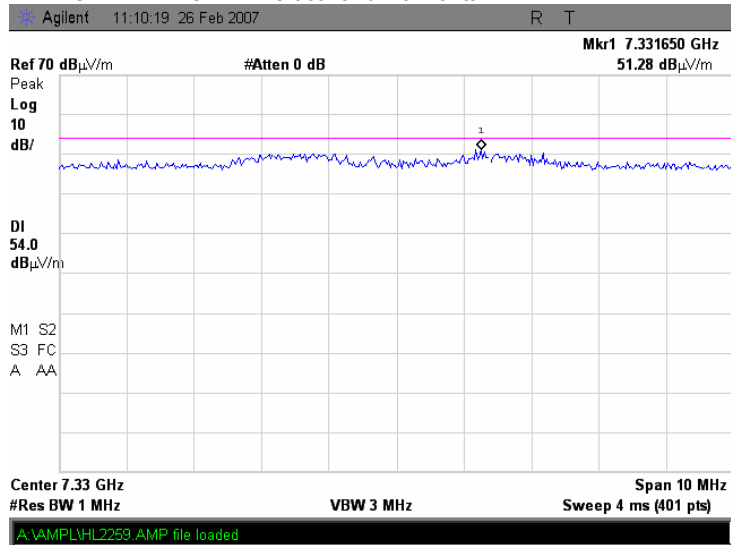

Test specification:	Section 15.247(c), Radiated spurious emissions		
Test procedure:	FR Vol. 62, page 26243, Section 15.247(c) / ANSI C63.4, Section 13.1.4		
Test mode:	Compliance	Verdict:	PASS
Date & Time:	2/27/2007 11:32:24 AM		
Temperature: 20°C	Air Pressure: 1013 hPa	Relative Humidity: 42%	Power Supply: 120 V AC
Remarks:			

Plot 7.3.17 Radiated emission measurements at the ninth harmonic of carrier frequency

TEST SITE: OATS
TEST DISTANCE: 3 m
ANTENNA POLARIZATION: Vertical and Horizontal

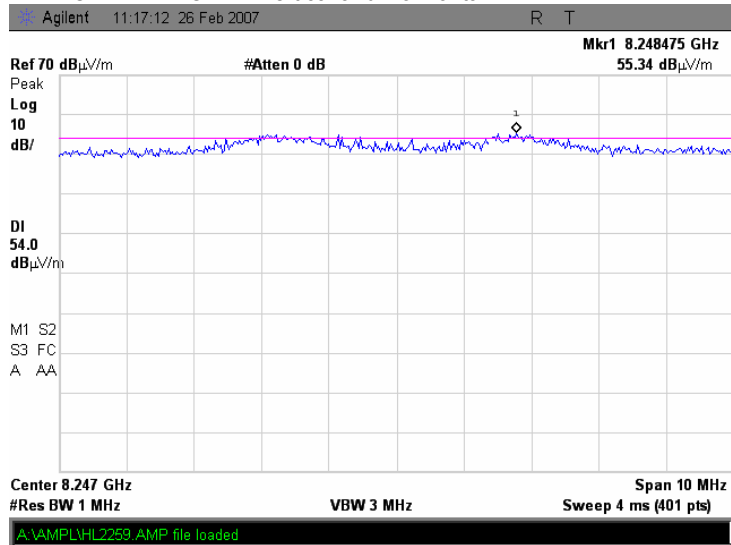

Plot 7.3.18 Radiated emission measurements at the ninth harmonic of carrier frequency average

TEST SITE: OATS
TEST DISTANCE: 3 m
ANTENNA POLARIZATION: Vertical and Horizontal

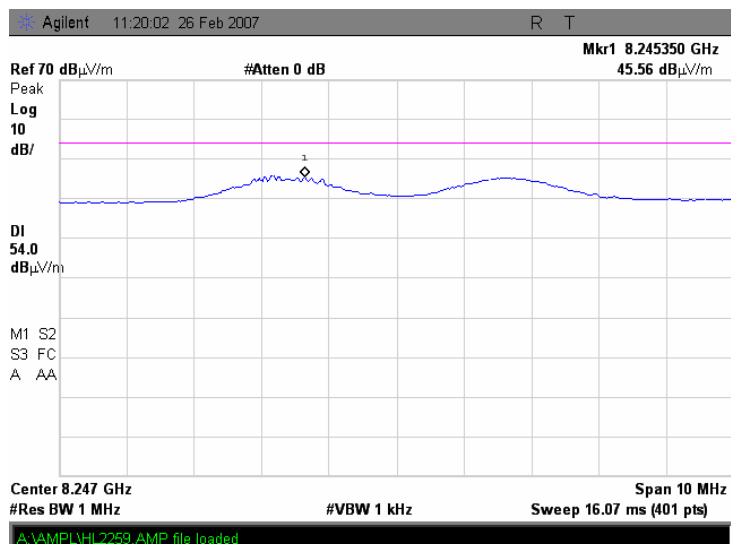

Test specification:	Section 15.247(c), Radiated spurious emissions		
Test procedure:	FR Vol. 62, page 26243, Section 15.247(c) / ANSI C63.4, Section 13.1.4		
Test mode:	Compliance	Verdict:	PASS
Date & Time:	2/27/2007 11:32:24 AM		
Temperature: 20°C	Air Pressure: 1013 hPa	Relative Humidity: 42%	Power Supply: 120 V AC
Remarks:			

Plot 7.3.19 Radiated emission measurements at the tenth harmonic of carrier frequency

TEST SITE: OATS
 TEST DISTANCE: 3 m
 ANTENNA POLARIZATION: Vertical and Horizontal

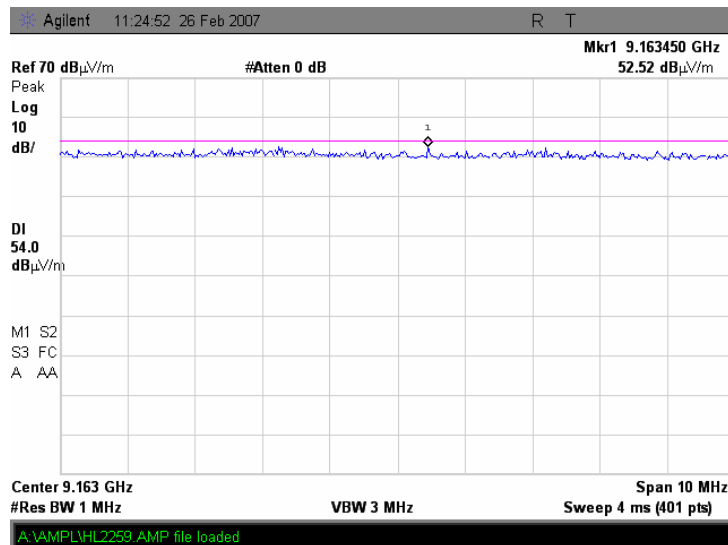

Test specification:	Section 15.247(c), Radiated spurious emissions		
Test procedure:	FR Vol. 62, page 26243, Section 15.247(c) / ANSI C63.4, Section 13.1.4		
Test mode:	Compliance	Verdict:	PASS
Date & Time:	2/27/2007 11:32:24 AM		
Temperature: 20°C	Air Pressure: 1013 hPa	Relative Humidity: 42%	Power Supply: 120 V AC
Remarks:			

Plot 7.3.20 Transmission pulse duration

13:56:41 FEB 20, 2007

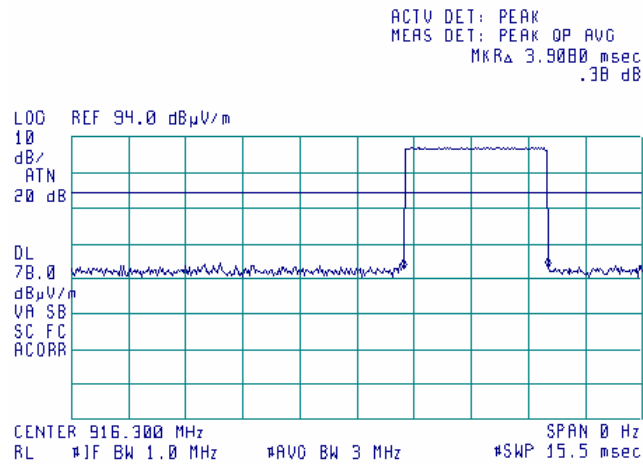

Plot 7.3.21 Transmission pulse period

13:54:54 FEB 20, 2007

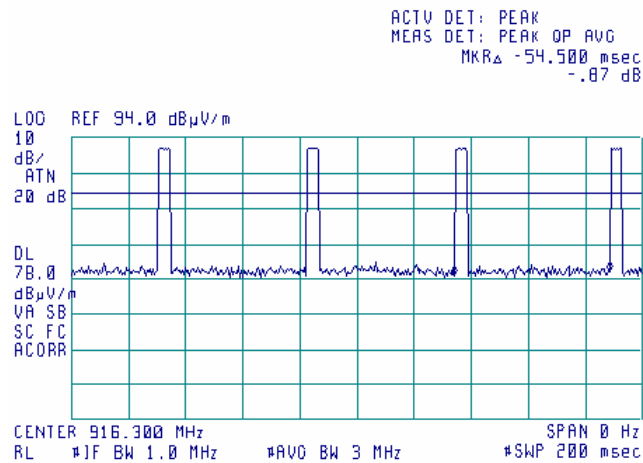

Test specification:		Section 15.247(d), Peak power density	
Test procedure:		FR Vol. 62, page 26243, Section 15.247(d)	
Test mode:	Compliance	Verdict:	PASS
Date & Time:	2/20/2007 1:35:08 PM		
Temperature: 20°C	Air Pressure: 1010 hPa	Relative Humidity: 48%	Power Supply: 120 V AC
Remarks:			

7.4 Peak spectral power density

7.4.1 General

This test was performed to measure the peak spectral power density radiated by the transmitter RF antenna. Specification test limits are given in Table 7.4.1.

Table 7.4.1 Peak spectral power density limits

Assigned frequency range, MHz	Measurement bandwidth, kHz	Peak spectral power density, dBm	Equivalent field strength limit @ 3m, dB(μ V/m)*
902.0 – 928.0	3.0	8.0	103.2
2400.0 – 2483.5			
5725.0 – 5850.0			

* - Equivalent field strength limit was calculated from the peak spectral power density as follows: $E = \sqrt{30 \times P} / r$, where P is peak spectral power density and r is antenna to EUT distance in meters.

7.4.2 Test procedure for field strength measurements

- 7.4.2.1 The EUT was set up as shown in Figure 7.4.1, energized and its proper operation was checked.
- 7.4.2.2 The EUT was adjusted to produce maximum available to end user RF output power.
- 7.4.2.3 The field strength of the EUT carrier frequency was measured with antenna connected to spectrum analyzer/ EMI receiver. To find maximum radiation the turntable was rotated 360° and the measuring antenna height was swept in both vertical and horizontal polarizations.
- 7.4.2.4 The frequency span of spectrum analyzer was set to capture the entire 6 dB band of the transmitter, in peak hold mode with resolution bandwidth set to 3.0 kHz, video bandwidth wider than resolution bandwidth, auto sweep time and sufficient number of sweeps was allowed for trace stabilization. The spectrum lines spacing was verified to be wider than 3 kHz. Otherwise the resolution bandwidth was reduced until individual spectrum lines were resolved and the power of individual spectrum lines was integrated over 3 kHz band.
- 7.4.2.5 The peak of emission was zoomed with span set just wide enough to capture the emission peak area and sweep time was set equal to span width divided by resolution bandwidth. Spectrum analyzer was set in peak hold mode, sufficient number of sweeps was allowed for trace stabilization and peak spectral power density was measured as provided in Table 7.4.2 and associated plots.

Test specification:	Section 15.247(d), Peak power density		
Test procedure:	FR Vol. 62, page 26243, Section 15.247(d)		
Test mode:	Compliance	Verdict:	PASS
Date & Time:	2/20/2007 1:35:08 PM		
Temperature: 20°C	Air Pressure: 1010 hPa	Relative Humidity: 48%	Power Supply: 120 V AC
Remarks:			

Figure 7.4.1 Setup for carrier field strength measurements

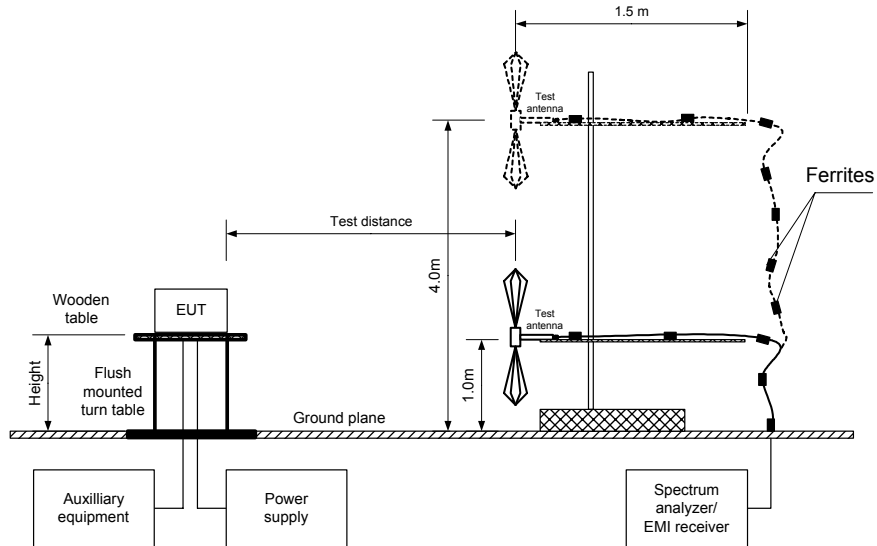

Test specification:		Section 15.247(d), Peak power density	
Test procedure:		FR Vol. 62, page 26243, Section 15.247(d)	
Test mode:	Compliance	Verdict:	PASS
Date & Time:	2/20/2007 1:35:08 PM		
Temperature: 20°C	Air Pressure: 1010 hPa	Relative Humidity: 48%	Power Supply: 120 V AC
Remarks:			

Table 7.4.2 Field strength measurement of peak spectral power density

ASSIGNED FREQUENCY: 902 – 928 MHz
 TEST DISTANCE: 3 m
 TEST SITE: Semi anechoic chamber
 EUT HEIGHT: 0.8 m
 DETECTOR USED: Peak
 RESOLUTION BANDWIDTH: 3 kHz
 VIDEO BANDWIDTH: 10 kHz
 TEST ANTENNA TYPE: Biconical (30 MHz – 1000 MHz)
 MODULATION: FSK
 MODULATING SIGNAL: PRBS
 BIT RATE: 120 kbps
 TRANSMITTER OUTPUT POWER SETTINGS: Maximum
 TRANSMITTER OUTPUT POWER: 9.8 dBm at carrier frequency

Frequency, MHz	Field strength, dB(μV/m)	EUT antenna gain, dBi	Limit, dB(μV/m)	Margin, dB*	Antenna polarization	Antenna height, m	Turn-table position**, degrees
916.1190	101.91	4	103.2	-5.29	Vertical	1.0	158

*- Margin = Field strength - EUT antenna gain - calculated field strength limit.

** - EUT front panel refer to 0 degrees position of turntable.

Reference numbers of test equipment used

HL 0465	HL 0521	HL 0589	HL 0593	HL 0594	HL 0604	HL 1424	HL 1947
HL 2009	HL 2259						

Full description is given in Appendix A.

Test specification:	Section 15.247(d), Peak power density		
Test procedure:	FR Vol. 62, page 26243, Section 15.247(d)		
Test mode:	Compliance	Verdict:	PASS
Date & Time:	2/20/2007 1:35:08 PM		
Temperature: 20°C	Air Pressure: 1010 hPa	Relative Humidity: 48%	Power Supply: 120 V AC
Remarks:			

Plot 7.4.1 Peak spectral power density within 6 dB band

10:06:09 FEB 14, 2007

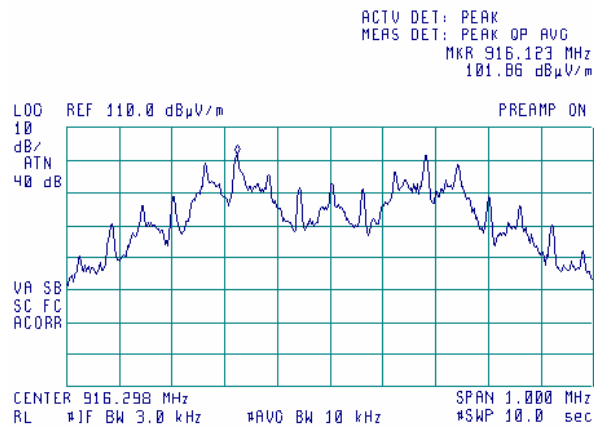

Plot 7.4.2 Peak spectral power density zoomed at the peak

10:11:28 FEB 14, 2007

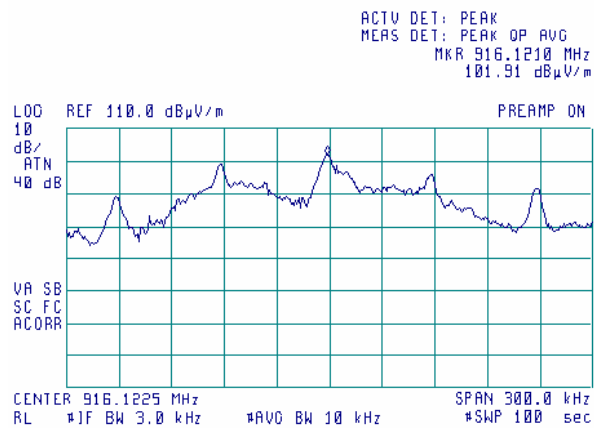

Test specification:		Section 15.207(a), Conducted emission	
Test procedure:		ANSI C63.4, Section 13.1.3	
Test mode:	Compliance	Verdict:	PASS
Date & Time:	2/20/2007 4:40:24 PM		
Temperature: 20°C	Air Pressure: 1010 hPa	Relative Humidity: 48%	Power Supply: 120 V AC
Remarks:			

7.5 Conducted emissions

7.5.1 General

This test was performed to measure common mode conducted emissions at the power port. Specification test limits are given in Table 7.5.1.

Table 7.5.1 Limits for conducted emissions

Frequency, MHz	Class B limit, dB(μ V)	
	QP	AVRG
0.15 - 0.5	66 - 56*	56 - 46*
0.5 - 5.0	56	46
5.0 - 30	60	50

* The limit decreases linearly with the logarithm of frequency.

7.5.2 Test procedure

7.5.2.1 The EUT was set up as shown in Figure 7.5.1, energized and the performance check was conducted.

7.5.2.2 The measurements were performed at power terminals with the LISN, connected to a spectrum analyzer in the frequency range referred to in Table 7.5.2. Unused coaxial connector of the LISN was terminated with 50 Ohm. Quasi-peak and average detectors were used throughout the testing.

7.5.2.3 The position of the device cables was varied to determine maximum emission level.

7.5.2.4 The worst test results (the lowest margins) were recorded in Table 7.5.2 and shown in the associated plots.

Figure 7.5.1 Setup for conducted emission measurements, table-top equipment

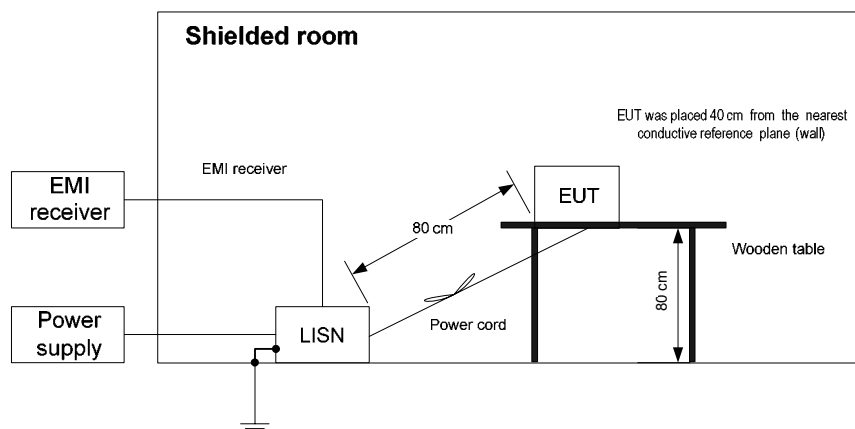

Test specification:	Section 15.207(a), Conducted emission		
Test procedure:	ANSI C63.4, Section 13.1.3		
Test mode:	Compliance	Verdict: PASS	
Date & Time:	2/20/2007 4:40:24 PM		
Temperature: 20°C	Air Pressure: 1010 hPa	Relative Humidity: 48%	Power Supply: 120 V AC
Remarks:			

Table 7.5.2 Conducted emission test results

LINE: AC mains
 EUT OPERATING MODE: Transmit
 EUT SET UP: TABLE-TOP
 TEST SITE: SHIELDED ROOM
 DETECTORS USED: PEAK / QUASI-PEAK / AVERAGE
 FREQUENCY RANGE: 150 kHz - 30 MHz
 RESOLUTION BANDWIDTH: 9 kHz

Frequency, MHz	Peak emission, dB(μV)	Quasi-peak			Average			Line ID	Verdict
		Measured emission, dB(μV)	Limit, dB(μV)	Margin, dB*	Measured emission, dB(μV)	Limit, dB(μV)	Margin, dB*		
All emissions were at least 20 dB below the specified limit								L1	Pass
								L2	Pass

*- Margin = Measured emission - specification limit.

Reference numbers of test equipment used

HL 0163	HK 0466	HL 0521	HL 0787	HL 1503			
---------	---------	---------	---------	---------	--	--	--

Full description is given in Appendix A.

Test specification: Section 15.207(a), Conducted emission			
Test procedure: ANSI C63.4, Section 13.1.3			
Test mode: Compliance	Verdict: PASS		
Date & Time: 2/20/2007 4:40:24 PM			
Temperature: 20°C	Air Pressure: 1010 hPa	Relative Humidity: 48%	Power Supply: 120 V AC
Remarks:			

Plot 7.5.1 Conducted emission measurements

LINE: L1
EUT OPERATING MODE: Transmit
LIMIT: QUASI-PEAK, AVERAGE
DETECTOR: PEAK

16:36:17 FEB 20, 2007

ACTV DET: PEAK
MEAS DET: PEAK OP AVG
MKR 28.31 MHz
29.34 dBµV

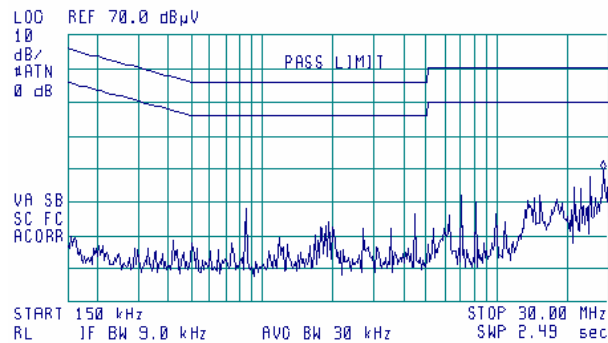

Plot 7.5.2 Conducted emission measurements

LINE: L2
EUT OPERATING MODE: Transmit
LIMIT: QUASI-PEAK, AVERAGE
DETECTOR: PEAK

16:33:56 FEB 20, 2007

ACTV DET: PEAK
MEAS DET: PEAK OP AVG
MKR 25.79 MHz
29.00 dBµV

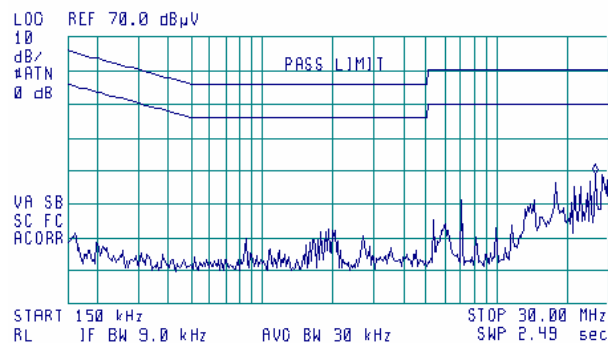

Test specification:		Section 15.107, Conducted emission at AC power port	
Test procedure:		ANSI C63.4, Sections 11.5 and 12.1.3	
Test mode:	Compliance	Verdict:	PASS
Date & Time:	2/20/2007 4:34:10 PM		
Temperature: 20°C	Air Pressure: 1010 hPa	Relative Humidity: 48%	Power Supply: 120 V AC
Remarks:			

8 Emission tests according to 47CFR part 15 subpart B requirements

8.1 Conducted emissions

8.1.1 General

This test was performed to measure common mode conducted emissions at the mains power port. Specification test limits are given in Table 8.1.1.

Table 8.1.1 Limits for conducted emissions

Frequency, MHz	Class B limit, dB(μ V)		Class A limit, dB(μ V)	
	QP	AVRG	QP	AVRG
0.15 - 0.5	66 - 56*	56 - 46*	79	66
0.5 - 5.0	56	46	73	60
5.0 - 30	60	50	73	60

* The limit decreases linearly with the logarithm of frequency.

8.1.2 Test procedure

8.1.2.1 The EUT was set up as shown in Figure 8.1.1, energized and the performance check was conducted.

8.1.2.2 The measurements were performed at power terminals with the LISN, connected to a spectrum analyzer in the frequency range referred to in Table 8.1.2. Unused coaxial connector of the LISN was terminated with 50 Ohm. Quasi-peak and average detectors were used throughout the testing.

8.1.2.3 The position of the device cables was varied to determine maximum emission level.

8.1.2.4 The worst test results (the lowest margins) were recorded in Table 8.1.2 and shown in the associated plots.

Figure 8.1.1 Setup for conducted emission measurements, table-top equipment

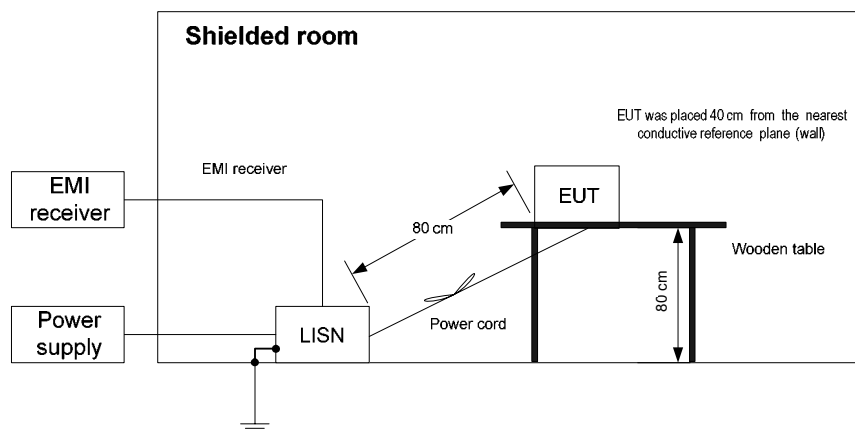

Test specification:		Section 15.107, Conducted emission at AC power port	
Test procedure:		ANSI C63.4, Sections 11.5 and 12.1.3	
Test mode:	Compliance	Verdict:	PASS
Date & Time:	2/20/2007 4:34:10 PM		
Temperature: 20°C	Air Pressure: 1010 hPa	Relative Humidity: 48%	Power Supply: 120 V AC
Remarks:			

Table 8.1.2 Conducted emission test results

LINE: AC mains
LIMIT: Class B
EUT OPERATING MODE: Stand-by
EUT SET UP: TABLE-TOP
TEST SITE: SHIELDED ROOM
DETECTORS USED: PEAK / QUASI-PEAK / AVERAGE
FREQUENCY RANGE: 150 kHz - 30 MHz
RESOLUTION BANDWIDTH: 9 kHz

Frequency, MHz	Peak emission, dB(μV)	Quasi-peak			Average			Line ID	Verdict
		Measured emission, dB(μV)	Limit, dB(μV)	Margin, dB*	Measured emission, dB(μV)	Limit, dB(μV)	Margin, dB*		
26.142029	32.81	28.75	60.00	-31.25	3.74	50.00	-46.26	L1	Pass
28.637225	30.44	28.92	60.00	-31.08	28.01	50.00	-21.99	L2	Pass

*- Margin = Measured emission - specification limit.

Reference numbers of test equipment used

HL 0163	HL 0466	HL 0521	HL 0787	HL 1503			
---------	---------	---------	---------	---------	--	--	--

Full description is given in Appendix A.

Test specification: Section 15.107, Conducted emission at AC power port			
Test procedure: ANSI C63.4, Sections 11.5 and 12.1.3			
Test mode: Compliance	Verdict: PASS		
Date & Time: 2/20/2007 4:34:10 PM			
Temperature: 20°C	Air Pressure: 1010 hPa	Relative Humidity: 48%	Power Supply: 120 V AC
Remarks:			

Plot 8.1.1 Conducted emission measurements

LINE: L1
LIMIT: Class B
EUT OPERATING MODE: Stand-by
LIMIT: QUASI-PEAK, AVERAGE
DETECTOR: PEAK

15:54:34 FEB 20, 2007

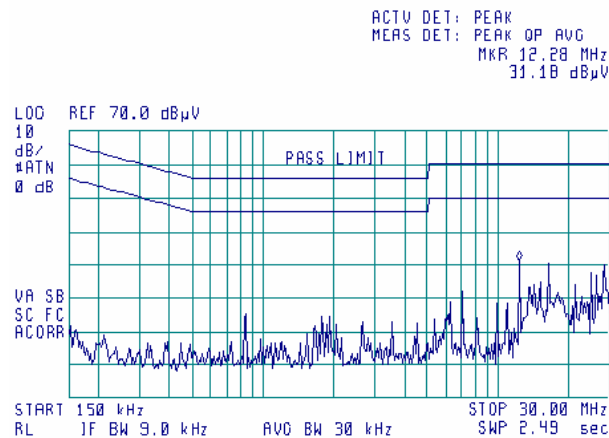

Plot 8.1.2 Conducted emission measurements

LINE: L2
LIMIT: Class B
EUT OPERATING MODE: Stand-by
LIMIT: QUASI-PEAK, AVERAGE
DETECTOR: PEAK

16:00:36 FEB 20, 2007

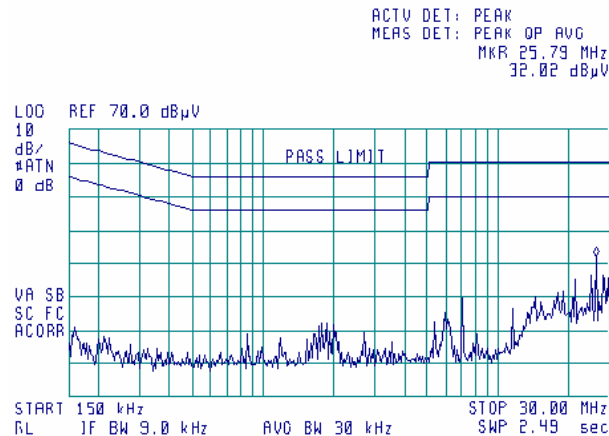

Test specification:		Section 15.109, Radiated emission	
Test procedure:		ANSI C63.4, Sections 11.6 and 12.1.4	
Test mode:	Compliance	Verdict:	PASS
Date & Time:	2/20/2007 1:27:41 PM		
Temperature: 20°C	Air Pressure: 1010 hPa	Relative Humidity: 48%	Power Supply: 120 V AC
Remarks:			

8.2 Radiated emission measurements

8.2.1 General

This test was performed to measure radiated emissions from the EUT enclosure. Specification test limits are given in Table 8.2.1.

Table 8.2.1 Radiated emission test limits

Frequency, MHz	Class B limit, dB(μV/m)		Class A limit, dB(μV/m)	
	10 m distance	3 m distance	10 m distance	3 m distance
30 - 88	29.5*	40.0	39.0	49.5*
88 - 216	33.0*	43.5	43.5	54.0*
216 - 960	35.5*	46.0	46.4	56.9*
Above 960	43.5*	54.0	49.5	60.0*

* The limit for test distance other than specified was calculated using the inverse linear distance extrapolation factor as follows: $Lim_{S_2} = Lim_{S_1} + 20 \log(S_1/S_2)$, where S_1 and S_2 – standard defined and test distance respectively in meters.

8.2.2 Test procedure for measurements in semi-anechoic chamber

8.2.2.1 The EUT was set up as shown in Figure 8.2.1, energized and the performance check was conducted.

8.2.2.2 The specified frequency range was investigated with biconilog antenna connected to EMI receiver. To find maximum radiation the turntable was rotated 360°, the measuring antenna height was changed from 1 to 4 m, its polarization was switched from vertical to horizontal and the EUT cables position was varied.

8.2.2.3 The worst test results (the lowest margins) were recorded in Table 8.2.2 and shown in the associated plots.

Test specification: Section 15.109, Radiated emission			
Test procedure: ANSI C63.4, Sections 11.6 and 12.1.4			
Test mode: Compliance		Verdict: PASS	
Date & Time: 2/20/2007 1:27:41 PM			
Temperature: 20°C	Air Pressure: 1010 hPa	Relative Humidity: 48%	Power Supply: 120 V AC
Remarks:			

Figure 8.2.1 Setup for radiated emission measurements in anechoic chamber, table-top equipment

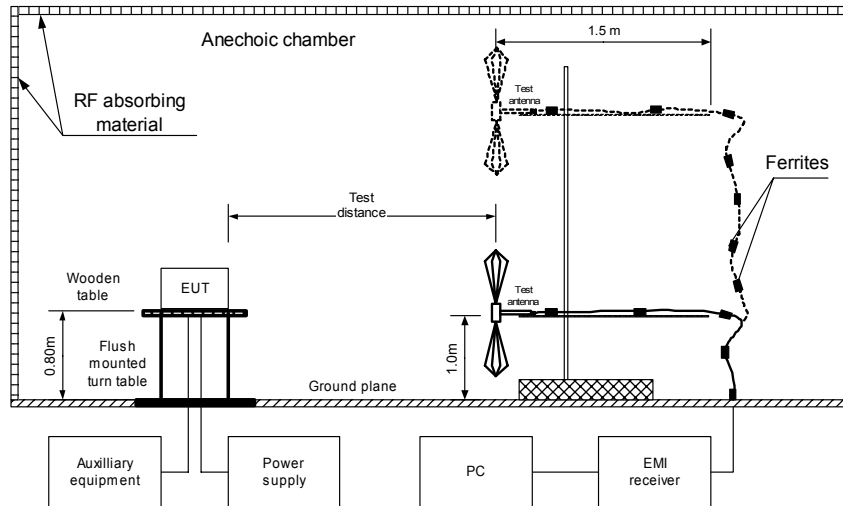

Test specification:		Section 15.109, Radiated emission	
Test procedure:		ANSI C63.4, Sections 11.6 and 12.1.4	
Test mode:	Compliance	Verdict:	PASS
Date & Time:	2/20/2007 1:27:41 PM		
Temperature: 20°C	Air Pressure: 1010 hPa	Relative Humidity: 48%	Power Supply: 120 V AC
Remarks:			

Table 8.2.2 Radiated emission test results

EUT SET UP: TABLE-TOP
LIMIT: B
EUT OPERATING MODE: Stand-by
TEST SITE: SEMI ANECHOIC CHAMBER
TEST DISTANCE: 3 m
DETECTORS USED: PEAK / QUASI-PEAK
FREQUENCY RANGE: 30 MHz – 1000 MHz
RESOLUTION BANDWIDTH: 120 kHz

Frequency, MHz	Peak emission, dB(μV/m)	Quasi-peak			Antenna polarization	Antenna height, m	Turn-table position**, degrees	Verdict
		Measured emission, dB(μV/m)	Limit, dB(μV/m)	Margin, dB*				
33.355000	28.90	23.61	-16.39	40.00	H	1.4	280	Pass
40.600000	38.85	34.02	-5.98	40.00	H	1.4	293	
42.417500	36.41	31.54	-8.46	40.00	H	1.4	274	
51.405000	32.74	27.18	-12.82	40.00	H	1.4	282	
53.190000	26.91	21.23	-18.77	40.00	H	1.4	260	
85.697500	32.70	26.69	-13.31	40.00	H	1.4	290	

TEST SITE: SEMI ANECHOIC CHAMBER
TEST DISTANCE: 3 m
DETECTORS USED: PEAK / AVERAGE
FREQUENCY RANGE: 1000 -2900MHz
RESOLUTION BANDWIDTH: 1000 kHz

Frequency, MHz	Peak emission, dB(μV/m)	Average			Antenna polarization	Antenna height, m	Turn-table position**, degrees	Verdict
		Measured emission, dB(μV/m)	Limit, dB(μV/m)	Margin, dB*				
No spurious were found								Pass

*- Margin = Measured emission - specification limit.

**- EUT front panel refer to 0 degrees position of turntable.

Reference numbers of test equipment used

HL 0465	HL 0521	HL 0589	HL 0592	HL 0593	HL 0594	HL 0604	HL 1947
HL 2009	HL 2432						

Full description is given in Appendix A.

Test specification: Section 15.109, Radiated emission			
Test procedure: ANSI C63.4, Sections 11.6 and 12.1.4			
Test mode: Compliance	Verdict: PASS		
Date & Time: 2/20/2007 1:27:41 PM			
Temperature: 20°C	Air Pressure: 1010 hPa	Relative Humidity: 48%	Power Supply: 120 V AC
Remarks:			

Plot 8.2.1 Radiated emission measurements in 30 - 1000 MHz range, vertical antenna polarization

TEST SITE: Semi anechoic chamber
LIMIT: Class B
TEST DISTANCE: 3 m
EUT OPERATING MODE: Stand-by

16:52:42 FEB 14, 2007

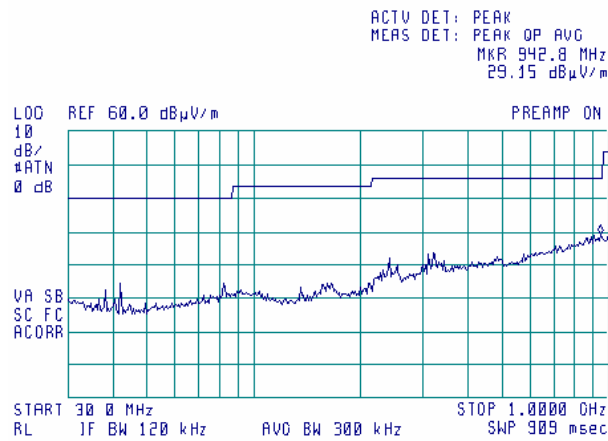

Plot 8.2.2 Radiated emission measurements in 30 - 1000 MHz range, horizontal antenna polarization

TEST SITE: Semi anechoic chamber
LIMIT: Class B
TEST DISTANCE: 3 m
EUT OPERATING MODE: Stand-by

16:54:20 FEB 14, 2007

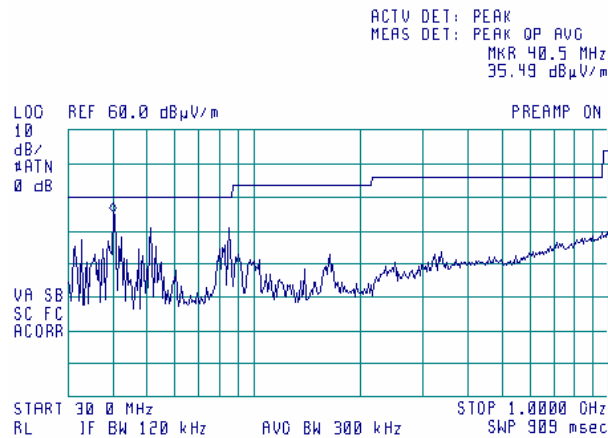

Test specification:		Section 15.109, Radiated emission	
Test procedure:		ANSI C63.4, Sections 11.6 and 12.1.4	
Test mode:	Compliance	Verdict:	PASS
Date & Time:	2/20/2007 1:27:41 PM		
Temperature: 20°C	Air Pressure: 1010 hPa	Relative Humidity: 48%	Power Supply: 120 V AC
Remarks:			

Plot 8.2.3 Radiated emission measurements above 1000 MHz, vertical & horizontal antenna polarization

TEST SITE: Semi anechoic chamber
LIMIT: Class B
TEST DISTANCE: 3 m
EUT OPERATING MODE: Stand-by

12:18:45 FEB 20, 2007

ACTV DET: PEAK
MEAS DET: PEAK OP AVG
MKR 2.900 GHz
47.05 dB μ V/m

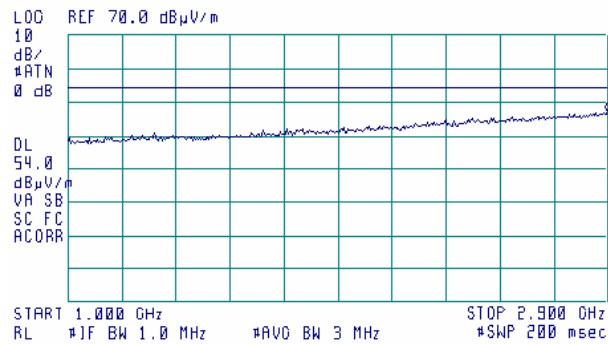

9 APPENDIX A Test equipment and ancillaries used for tests

HL No	Description	Manufacturer	Model	Ser. No.	Last Cal.	Due Cal.
0163	LISN FCC/VDE/50 Ohm/50 uH + 5 Ohm, MIL-STD-461E, CISPR 16-1	Electro-Metrics	ANS 25/2	1314	01-Oct-06	01-Oct-07
0446	Antenna, Loop, Active, 10 kHz - 30 MHz	EMCO	6502	2857	28-Jun-06	28-Jun-07
0465	Anechoic Chamber 9(L) x 6.5(W) x 5.5(H) m	HL	AC - 1	023	23-Aug-05	23-Aug-08
0466	Shielded Room 3(L) x 3(W) x 2,4(H) m	HL	SR - 1	024	11-Nov-06	11-Nov-07
0521	EMI Receiver (Spectrum Analyzer) with RF filter section 9 kHz-6.5 GHz	Hewlett Packard	8546A	3617A 00319, 3448A002 53	26-Sep-06	26-Sep-07
0589	Cable Coaxial, GORE A2P01POL118, 2.3 m	HL	GORE-3	176	02-Dec-06	02-Dec-07
0592	Position Controller	HL	L2-SR3000 (HL CRL-3)	100	18-May-06	18-May-07
0593	Antenna Mast, 1-4 m Pneumatic	Madgesh	AM-F1	101	02-Feb-07	02-Feb-08
0594	Turn Table FOR ANECHOIC CHAMBER flush mount d=1.2 m Pneumatic	HL	TT-WDC1	102	26-Jan-07	26-Jan-08
0604	Antenna BiconiLog Log-Periodic/T Bow-TIE 26 - 2000 MHz	EMCO	3141	9611-1011	10-Jan-07	10-Jan-08
0787	Transient Limiter 9 kHz-200 MHz	Hewlett Packard	11947A	3107A018 77	21-Nov-06	21-Nov-07
1424	Spectrum Analyzer, 30 Hz- 40 GHz	Agilent Technologies	8564EC	3946A002 19	30-Aug-06	30-Aug-07
1503	Cable RF, 6 m, BNC/BNC	Belden	M17/167 MIL-C-17	1503	11-Sep-06	11-Sep-07
1947	Cable 18GHz, 6.5 m, blue	Rhophase Microwave Limited	NPS-1803A-6500-NPS	T4974	17-Oct-06	17-Oct-07
2009	Cable RF, 8 m	Alpha Wire	RG-214	C-56	02-Dec-06	02-Dec-07
2259	Amplifier Low Noise 2-20 GHz	Sophia Wireless	LNA0220-C	0223	05-Nov-06	05-Nov-07
2432	Antenna, Double-Ridged Waveguide Horn 1-18 GHz	EMC Test Systems	3115	00027177	03-Mar-07	03-Mar-08
2780	EMC analyzer, 100 Hz to 26.5 GHz	Agilent Technologies	E7405A	MY451024 6	11-Jun-06	11-Jun-07

10 APPENDIX B Test facility description

Tests were performed at Hermon Laboratories Ltd., which is a fully independent, private, EMC, safety, environmental and telecommunication testing facility. Hermon Laboratories is listed by the Federal Communications Commission (USA) for all parts of Code of Federal Regulations 47 (CFR 47) and by Industry Canada for electromagnetic emissions (file numbers IC 2186-1 for OATS and IC 2186-2 for anechoic chamber), certified by VCCI, Japan (the registration numbers are R-808 for OATS, R-1082 for anechoic chamber, C-845 for conducted emissions site), assessed by TNO Certification EP&S (Netherlands) for a number of EMC, telecommunications, environmental, safety standards, and by AMTAC (UK) for safety of medical devices. The laboratory is accredited by American Association for Laboratory Accreditation (USA) according to ISO/IEC 17025 for electromagnetic compatibility, product safety, telecommunications testing and environmental simulation (for exact scope please refer to Certificate No. 839.01) and approved by Israel Ministry of environmental protection, radiation hazards department (Permit number 1158).

Address: P.O. Box 23, Binyamina 30500, Israel.
Telephone: +972 4628 8001
Fax: +972 4628 8277
e-mail: mail@hermonlabs.com
website: www.hermonlabs.com

Person for contact: Mr. Alex Usoskin, CEO.

11 APPENDIX C Specification references

47CFR part 15: 2006	Radio Frequency Devices.
FR Vol.62	Federal Register, Volume 62, May 13, 1997
ANSI C63.2: 1996	American National Standard for Instrumentation-Electromagnetic Noise and Field Strength, 10 kHz to 40 GHz-Specifications.
ANSI C63.4: 2003	American National Standard for Methods of Measurement of Radio-Noise Emissions from Low-Voltage Electrical and Electronic Equipment in the Range of 9 kHz to 40 GHz.

12 APPENDIX D Test equipment correction factors

Correction factor
Line impedance stabilization network
Model ANS-25/2
Electro-Metrics

Frequency, MHz	Correction factor, dB
0.01	4.7
0.02	2.1
0.03	1.1
0.04	0.7
0.05	0.5
0.1	0.2
0.2	0.1
0.4	0.1
0.6	0.1
0.8	0.1
1	0.1
2	0.1
3	0.1
4	0.1
6	0.1
10	0.1
12	0.1
16	0.1
18	0.1
20	0.1
25	0.1
28	0.1
30	0.1

The correction factor in dB is to be added to meter readings of an interference analyzer or a spectrum analyzer.

Antenna factor
Active loop antenna
Model 6502, S/N 2857, HL 0446

Frequency, MHz	Magnetic antenna factor, dB	Electric antenna factor, dB
0.009	-32.8	18.7
0.010	-33.8	17.7
0.020	-38.3	13.2
0.050	-41.1	10.4
0.075	-41.3	10.2
0.100	-41.6	9.9
0.150	-41.7	9.8
0.250	-41.6	9.9
0.500	-41.8	9.8
0.750	-41.9	9.7
1.000	-41.4	10.1
2.000	-41.5	10.0
3.000	-41.4	10.2
4.000	-41.4	10.1
5.000	-41.5	10.1
10.000	-41.9	9.6
15.000	-41.9	9.6
20.000	-42.2	9.3
25.000	-42.8	8.7
30.000	-44.0	7.5

Antenna factor in dB(1/m) is to be added to receiver meter reading in dB(μ V) to convert it into field intensity in dB(μ V/m).

**Antenna factor
Biconilog antenna EMCO Model 3141
Ser.No.1011, HL 0604**

Frequency, MHz	Antenna Factor, dB(1/m)	Frequency, MHz	Antenna Factor, dB(1/m)
26	7.8	940	24.0
28	7.8	960	24.1
30	7.8	980	24.5
40	7.2	1000	24.9
60	7.1	1020	25.0
70	8.5	1040	25.2
80	9.4	1060	25.4
90	9.8	1080	25.6
100	9.7	1100	25.7
110	9.3	1120	26.0
120	8.8	1140	26.4
130	8.7	1160	27.0
140	9.2	1180	27.0
150	9.8	1200	26.7
160	10.2	1220	26.5
170	10.4	1240	26.5
180	10.4	1260	26.5
190	10.3	1280	26.6
200	10.6	1300	27.0
220	11.6	1320	27.8
240	12.4	1340	28.3
260	12.8	1360	28.2
280	13.7	1380	27.9
300	14.7	1400	27.9
320	15.2	1420	27.9
340	15.4	1440	27.8
360	16.1	1460	27.8
380	16.4	1480	28.0
400	16.6	1500	28.5
420	16.7	1520	28.9
440	17.0	1540	29.6
460	17.7	1560	29.8
480	18.1	1580	29.6
500	18.5	1600	29.5
520	19.1	1620	29.3
540	19.5	1640	29.2
560	19.8	1660	29.4
580	20.6	1680	29.6
600	21.3	1700	29.8
620	21.5	1720	30.3
640	21.2	1740	30.8
660	21.4	1760	31.1
680	21.9	1780	31.0
700	22.2	1800	30.9
720	22.2	1820	30.7
740	22.1	1840	30.6
760	22.3	1860	30.6
780	22.6	1880	30.6
800	22.7	1900	30.6
820	22.9	1920	30.7
840	23.1	1940	30.9
860	23.4	1960	31.2
880	23.8	1980	31.6
900	24.1	2000	32.0
920	24.1		

Antenna factor in dB(1/m) is to be added to receiver meter reading in dB(μV) to convert it into field intensity in dB(μV/m).

**Antenna factor
Double-ridged guide horn antenna
Model 3115, serial number: 00027177, HL2432**

Frequency, MHz	Antenna factor. dB(1/m)
1000.0	24.7
1500.0	25.7
2000.0	27.8
2500.0	28.9
3000.0	30.7
3500.0	31.8
4000.0	33.0
4500.0	32.8
5000.0	34.2
5500.0	34.9
6000.0	35.2
6500.0	35.4
7000.0	36.3
7500.0	37.3
8000.0	37.5
8500.0	38.0
9000.0	38.3
9500.0	38.3
10000.0	38.7
10500.0	38.7
11000.0	38.9
11500.0	39.5
12000.0	39.5
12500.0	39.4
13000.0	40.5
13500.0	40.8
14000.0	41.5
14500.0	41.3
15000.0	40.2
15500.0	38.7
16000.0	38.5
16500.0	39.8
17000.0	41.9
17500.0	45.8
18000.0	49.1

Antenna factor in dB(1/m) is to be added to receiver meter reading in dB(μ V) to convert it into field intensity in dB(μ V/m).

Cable loss
Cable Coaxial, GORE A2P01POL118, 2.3 m, model:GORE-3, HL 0589
+ Cable Coaxial, ANDREW PSWJ4, 6m, model: ANDREW-6, HL 1004

No.	Frequency, MHz	Cable loss, dB	Tolerance (Specification), dB	Measurement uncertainty, dB
1	30	0.33	≤ 6.5	±0.12
2	50	0.40		
3	100	0.57		
4	300	0.97		
5	500	1.25		
6	800	1.59		
7	1000	1.81		
8	1200	1.97		
9	1400	2.15		
10	1600	2.28		
11	1800	2.43		
12	2000	2.61		
13	2200	2.75		
14	2400	2.89		
15	2600	2.97		
16	2800	3.21	≤ 6.5	±0.12
17	3000	3.32		
18	3300	3.47		
19	3600	3.62		
20	3900	3.84		
21	4200	3.92		
22	4500	4.07		±0.17
23	4800	4.36		
24	5100	4.62		
25	5400	4.78		
26	5700	5.16		
27	6000	5.67		
28	6500	5.99		

Cable loss
Cable coaxial, 6 m, model: M17/167 MIL-C-17, HL 1503

Frequency, MHz	Cable loss, dB
0.15	0.043
1	0.077
3	0.139
5	0.169
10	0.248
30	0.430
50	0.561
75	0.697
100	0.822
300	1.446
500	1.901
800	2.663
1000	2.829
1500	3.569
2000	4.179

Cable loss
Cable 18 GHz, 6.5 m, blue, model: NPS-1803A-6500-NPS, S/N T4974, HL 1947

Frequency, GHz	Cable loss, dB
0.03	0.30
0.05	0.38
0.10	0.53
0.20	0.74
0.30	0.91
0.40	1.05
0.50	1.18
0.60	1.29
0.70	1.40
0.80	1.50
0.90	1.59
1.00	1.68
1.10	1.77
1.20	1.86
1.30	1.94
1.40	2.01
1.50	2.08
1.60	2.16
1.70	2.22
1.80	2.29
1.90	2.36
2.00	2.42
2.10	2.48
2.20	2.54
2.30	2.60
2.40	2.66
2.50	2.71
2.60	2.77
2.70	2.83
2.80	2.89
2.90	2.95
3.10	3.06
3.30	3.17
3.50	3.28
3.70	3.39
3.90	3.51
4.10	3.62
4.30	3.76
4.50	3.87
4.70	4.01
4.90	4.10
5.10	4.21
5.30	4.31
5.50	4.43
5.70	4.56
5.90	4.71

Frequency, GHz	Cable loss, dB
6.10	4.87
6.30	4.95
6.50	4.94
6.70	4.88
6.90	4.87
7.10	4.83
7.30	4.85
7.50	4.86
7.70	4.91
7.90	4.96
8.10	5.03
8.30	5.08
8.50	5.13
8.70	5.21
8.90	5.22
9.10	5.34
9.30	5.35
9.50	5.52
9.70	5.51
9.90	5.66
10.10	5.70
10.30	5.78
10.50	5.79
10.70	5.82
10.90	5.86
11.10	5.94
11.30	6.06
11.50	6.21
11.70	6.44
11.90	6.61
12.10	6.76
12.40	6.68
13.00	6.66
13.50	6.81
14.00	6.90
14.50	6.90
15.00	6.97
15.50	7.17
16.00	7.28
16.50	7.27
17.00	7.38
17.50	7.68
18.00	7.92

Cable loss
RF cable 8 m, model RG-214, HL 2009

No.	Frequency, MHz	Cable loss, dB	Tolerance (Specification), dB	Measurement uncertainty, dB
1	1	0.10	NA	±0.12
2	10	0.14		
3	30	0.25		
4	50	0.34		
5	100	0.53		
6	300	0.99		
7	500	1.31		
8	800	1.73		
9	1000	1.98		
10	1100	2.11		
11	1200	2.21		
12	1300	2.35		
13	1400	2.46		
14	1500	2.55		
15	1600	2.68		
16	1700	2.78		
17	1800	2.88		
18	1900	2.98		
19	2000	3.09		

13 APPENDIX E Measurement uncertainties

Expanded uncertainty at 95% confidence in Hermon Labs EMC measurements

Test description	Expanded uncertainty
Conducted carrier power at RF antenna connector	Below 12.4 GHz: ± 1.7 dB 12.4 GHz to 40 GHz: ± 2.3 dB
Conducted emissions at RF antenna connector	9 kHz to 2.9 GHz: ± 2.6 dB 2.9 GHz to 6.46 GHz: ± 3.5 dB 6.46 GHz to 13.2 GHz: ± 4.3 dB 13.2 GHz to 22.0 GHz: ± 5.0 dB 22.0 GHz to 26.8 GHz: ± 5.5 dB 26.8 GHz to 40.0 GHz: ± 4.8 dB
Occupied bandwidth	± 8.0 %
Duty cycle, timing (Tx ON / OFF) and average factor measurements	± 1.0 %
Conducted emissions with LISN	9 kHz to 150 kHz: ± 3.9 dB 150 kHz to 30 MHz: ± 3.8 dB
Radiated emissions at 3 m measuring distance Horizontal polarization Vertical polarization	Biconilog antenna: ± 5.3 dB Biconical antenna: ± 5.0 dB Log periodic antenna: ± 5.3 dB Double ridged horn antenna: ± 5.3 dB Biconilog antenna: ± 6.0 dB Biconical antenna: ± 5.7 dB Log periodic antenna: ± 6.0 dB Double ridged horn antenna: ± 6.0 dB

Hermon Laboratories is accredited by A2LA for calibration according to present requirements of ISO/IEC 17025 and NCSL Z540-1. The accreditation is granted to perform calibration of parameters that are listed in the Scope of Hermon Laboratories Accreditation.

Hermon Laboratories calibrates its reference and transfer standards by calibration laboratories accredited to ISO/IEC 17025 by a mutually recognized Accreditation Body or by a recognized national metrology institute. All reference and transfer standards used in the calibration system are traceable to national or international standards.

In-house calibration of all test and measurement equipment is performed on a regular basis according to Hermon Laboratories calibration procedures, manufacturer calibration/verification procedures or procedures defined in the relevant standards. The Hermon Laboratories test and measurement equipment is calibrated within the tolerances specified by the manufacturers and/or by the relevant standards.

14 APPENDIX F Abbreviations and acronyms

A	ampere
AC	alternating current
AM	amplitude modulation
AVRG	average (detector)
BB	broad band
cm	centimeter
dB	decibel
dBm	decibel referred to one milliwatt
dB(μ V)	decibel referred to one microvolt
dB(μ V/m)	decibel referred to one microvolt per meter
dB(μ A)	decibel referred to one microampere
DC	direct current
EMC	electromagnetic compatibility
EUT	equipment under test
GHz	gigahertz
GND	ground
H	height
HL	Hermon laboratories
Hz	hertz
k	kilo
kHz	kilohertz
L	length
LISN	line impedance stabilization network
m	meter
MHz	megahertz
min	minute
mm	millimeter
ms	millisecond
μ s	microsecond
NA	not applicable
NB	narrow band
OATS	open area test site
Ω	Ohm
QP	quasi-peak
PM	pulse modulation
PS	power supply
RE	radiated emission
RF	radio frequency
rms	root mean square
s	second
V	volt
W	width