

# ENGINEERING TEST REPORT

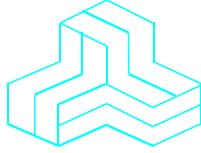

## 900MHz OEM Frequency Hopping Module Model No.: MHX910A

**FCC ID: NS904P11**

*Applicant:*

**Microhard Systems Inc.  
#17, 2135 - 32nd Avenue N.E.  
Calgary, Alberta  
Canada T2E 6Z3**

*In Accordance With*

**Federal Communications Commission (FCC)  
Part 15, Subpart C, Section 15.247  
Frequency Hopping Spread Spectrum (FHSS)  
Operating in 902 - 928 MHz Band**

**UltraTech's File No.: MCRS-004F15C247**

This Test report is Issued under the Authority of  
Tri M. Luu, Professional Engineer,  
Vice President of Engineering  
UltraTech Group of Labs



Date: November 23, 2004

Report Prepared by: Dan Huynh

Tested by: Mr. Hung Trinh, EMI/RFI Technician

Issued Date: November 23, 2004

Test Dates: November 9-19, 2004

*The results in this Test Report apply only to the sample(s) tested, and the sample tested is randomly selected.  
This report must not be used by the client to claim product endorsement by NVLAP or any agency of the US Government.*

## UltraTech

3000 Bristol Circle, Oakville, Ontario, Canada, L6H 6G4  
Tel.: (905) 829-1570 Fax.: (905) 829-8050  
Website: [www.ultratech-labs.com](http://www.ultratech-labs.com), Email: [vic@ultratech-labs.com](mailto:vic@ultratech-labs.com), Email: [tri@ultratech-labs.com](mailto:tri@ultratech-labs.com)



31040/SIT



C-1376



46390-2049



200093-0



SL2-IN-E-1119R



00-034



## TABLE OF CONTENTS

<b>EXHIBIT 1.</b>	<b>SUBMITTAL CHECK LIST .....</b>	<b>1</b>
<b>EXHIBIT 2.</b>	<b>INTRODUCTION.....</b>	<b>2</b>
2.1.	SCOPE .....	2
2.2.	RELATED SUBMITTAL(S)/GRANT(S).....	2
2.3.	NORMATIVE REFERENCES .....	2
<b>EXHIBIT 3.</b>	<b>PERFORMANCE ASSESSMENT .....</b>	<b>3</b>
3.1.	CLIENT INFORMATION .....	3
3.2.	EQUIPMENT UNDER TEST (EUT) INFORMATION.....	3
3.3.	EUT’S TECHNICAL SPECIFICATIONS.....	4
3.4.	ASSOCIATED ANTENNA DESCRIPTIONS .....	4
3.5.	LIST OF EUT’S PORTS.....	5
3.6.	ANCILLARY EQUIPMENT .....	5
<b>EXHIBIT 4.</b>	<b>EUT OPERATING CONDITIONS AND CONFIGURATIONS DURING TESTS.....</b>	<b>6</b>
4.1.	CLIMATE TEST CONDITIONS .....	6
4.2.	OPERATIONAL TEST CONDITIONS & ARRANGEMENT FOR TESTS .....	6
<b>EXHIBIT 5.</b>	<b>SUMMARY OF TEST RESULTS.....</b>	<b>7</b>
5.1.	LOCATION OF TESTS.....	7
5.2.	APPLICABILITY & SUMMARY OF EMC EMISSION TEST RESULTS .....	7
5.3.	MODIFICATIONS INCORPORATED IN THE EUT FOR COMPLIANCE PURPOSES .....	7
<b>EXHIBIT 6.</b>	<b>MEASUREMENTS, EXAMINATIONS &amp; TEST DATA FOR EMC EMISSIONS .....</b>	<b>8</b>
6.1.	TEST PROCEDURES .....	8
6.2.	MEASUREMENT UNCERTAINTIES .....	8
6.3.	MEASUREMENT EQUIPMENT USED .....	8
6.4.	ESSENTIAL/PRIMARY FUNCTIONS AS DECLARED BY THE MANUFACTURER.....	8
6.5.	COMPLIANCE WITH FCC PART 15 – GENERAL TECHNICAL REQUIREMENTS .....	9
6.6.	AC POWER LINE CONDUCTED EMISSIONS [47 CFR §15.107(a)] .....	11
6.7.	PROVISIONS FOR FREQUENCY HOPPING SYSTEMS [§ 15.247(a)(1)].....	14
6.8.	PEAK OUTPUT POWER & EQUIVALENT ISOTROPIC RADIATED POWER (EIRP) [§ 15.247(b)].....	35
6.9.	RF EXPOSURE REQUIRMENTS [ §§ 15.247(b)(4), 1.1310 & 2.1091].....	37
6.10.	TRANSMITTER BAND-EDGE & SPURIOUS CONDUCTED EMISSIONS [§ 15.247(c)] .....	40
6.11.	TRANSMITTER SPURIOUS RADIATED EMISSIONS AT 3 METERS [ §§ 15.247(c), 15.209 & 15.205].....	57
<b>EXHIBIT 7.</b>	<b>MEASUREMENT UNCERTAINTY.....</b>	<b>94</b>
7.1.	LINE CONDUCTED EMISSION MEASUREMENT UNCERTAINTY.....	94
7.2.	RADIATED EMISSION MEASUREMENT UNCERTAINTY .....	95
<b>EXHIBIT 8.</b>	<b>MEASUREMENT METHODS.....</b>	<b>96</b>
8.1.	GENERAL TEST CONDITIONS.....	96
8.2.	METHOD OF MEASUREMENTS - AC MAINS CONDUCTED EMISSIONS .....	97
8.3.	EQUIVALENT ISOTROPIC RADIATED POWER (EIRP).....	98
8.4.	SPURIOUS EMISSIONS (CONDUCTED & RADIATED).....	101
8.5.	ALTERNATIVE TEST PROCEDURES .....	104

## EXHIBIT 1. SUBMITTAL CHECK LIST

Annex No.	Exhibit Type	Description of Contents	Quality Check (OK)
--	Test Report	<ul style="list-style-type: none"> <li>▪ Exhibit 1: Submittal check lists</li> <li>▪ Exhibit 2: Introduction</li> <li>▪ Exhibit 3: Performance Assessment</li> <li>▪ Exhibit 4: EUT Operation and Configuration during Tests</li> <li>▪ Exhibit 5: Summary of test Results</li> <li>▪ Exhibit 6: Measurement Data</li> <li>▪ Exhibit 7: Measurement Uncertainty</li> <li>▪ Exhibit 8: Measurement Methods</li> </ul>	OK
1	Test Setup Photos	<ul style="list-style-type: none"> <li>▪ AC Conducted Emissions Setup Photos</li> <li>▪ Radiated Emissions Setup Photos</li> </ul>	OK
2	External EUT Photos	External EUT Photos	OK
3	Internal EUT Photos	Internal EUT Photos	OK
4	Cover Letters	<ul style="list-style-type: none"> <li>▪ Letter from Ultratech for Certification Request</li> <li>▪ Letter from the Applicant to appoint Ultratech to act as an agent</li> <li>▪ Letter from the Applicant to request for Confidentiality Filing</li> <li>▪ Microhard Systems Inc. Modular Request</li> </ul>	OK
5	Attestation Statements	--	--
6	ID Label/Location Info	<ul style="list-style-type: none"> <li>▪ ID Label</li> <li>▪ Location of ID Label</li> </ul>	OK
7	Block Diagrams	Block Diagram	OK
8	Schematic Diagrams	Schematics	OK
9	Parts List/Tune Up Info	Parts List	OK
10	Operational Description	Operation Description	OK
11	RF Exposure Info	MPE Evaluation, see section 6.9 in this Test Report for details.	OK
12	Users Manual	900 MHz Spread Spectrum OEM Module Operating Manual	OK

### ULTRATECH GROUP OF LABS

3000 Bristol Circle, Oakville, Ontario, Canada L6H 6G4  
 Tel. #: 905-829-1570, Fax. #: 905-829-8050, Email: [vic@ultratech-labs.com](mailto:vic@ultratech-labs.com), Website: <http://www.ultratech-labs.com>

File #: MCRS-004F15C247  
 November 23, 2004

*All test results contained in this engineering test report are traceable to National Institute of Standards and Technology (NIST)*

## EXHIBIT 2. INTRODUCTION

### 2.1. SCOPE

<b>Reference:</b>	FCC Part 15, Subpart C, Section 15.247
<b>Title:</b>	Code of Federal Regulations (CFR), Title 47 – Telecommunication, Part 15
<b>Purpose of Test:</b>	To gain FCC Certification Authorization for Frequency Hopping Spread Spectrum and Digitally Modulated Device Transceiver Operating in the Frequency Band 902 - 928 MHz.
<b>Test Procedures:</b>	Both conducted and radiated emissions measurements were conducted in accordance with American National Standards Institute ANSI C63.4 - American National Standard for Methods of Measurement of Radio-Noise Emissions from Low-Voltage Electrical and Electronic Equipment in the Range of 9 kHz to 40 GHz.
<b>Environmental Classification:</b>	[ x ] Commercial, industrial or business environment [ x ] Residential environment

### 2.2. RELATED SUBMITTAL(S)/GRANT(S)

None.

### 2.3. NORMATIVE REFERENCES

Publication	Year	Title
47 CFR Parts 0-19	2003	Code of Federal Regulations – Telecommunication
ANSI C63.4	2003	American National Standard for Methods of Measurement of Radio-Noise Emissions from Low-Voltage Electrical and Electronic Equipment in the Range of 9 kHz to 40 GHz
CISPR 22 & EN 55022	2003 2003	Limits and Methods of Measurements of Radio Disturbance Characteristics of Information Technology Equipment
CISPR 16-1	2003	Specification for Radio Disturbance and Immunity measuring apparatus and methods
FCC Public Notice DA 00-705	2000	Filing and Measurement Guidelines for Frequency Hopping Spread Spectrum Systems
FCC Public Notice DA 00-1407	2000	Part 15 Unlicensed Modular Transmitter Approval
FCC ET Docket No. 99-231	2002	Amendment to FCC Part 15 of the Commission's Rules Regarding to Spread Spectrum Devices

## EXHIBIT 3. PERFORMANCE ASSESSMENT

### 3.1. CLIENT INFORMATION

APPLICANT	
<b>Name:</b>	Microhard Systems Inc.
<b>Address:</b>	#17, 2135 - 32nd Avenue N.E. Calgary, Alberta Canada T2E 6Z3
<b>Contact Person:</b>	Mr. Hany Shenouda Phone #: 403 248-0028 Fax #: 403 248 2762 Email Address: shenouda@microhardcorp.com

MANUFACTURER	
<b>Name:</b>	Microhard Systems Inc.
<b>Address:</b>	#17, 2135 - 32nd Avenue N.E. Calgary, Alberta Canada T2E 6Z3
<b>Contact Person:</b>	Mr. Hany Shenouda Phone #: 403 248-0028 Fax #: 403 248-2762 Email Address: shenouda@microhardcorp.com

### 3.2. EQUIPMENT UNDER TEST (EUT) INFORMATION

The following information (with the exception of the Date of Receipt) has been supplied by the applicant.

<b>Brand Name:</b>	Microhard Systems Inc.
<b>Product Name:</b>	900 MHz OEM Frequency Hopping Module
<b>Model Name or Number:</b>	MHX910A
<b>Serial Number:</b>	Test Sample
<b>Type of Equipment:</b>	Spread Spectrum Transmitter
<b>Input Power Supply Type:</b>	External Regulated DC Sources
<b>Primary User Functions of EUT:</b>	Modular transceiver for long-range data communications between industrial serial communications devices.

---

**ULTRATECH GROUP OF LABS**

3000 Bristol Circle, Oakville, Ontario, Canada L6H 6G4  
Tel. #: 905-829-1570, Fax. #: 905-829-8050, Email: [vic@ultratech-labs.com](mailto:vic@ultratech-labs.com), Website: <http://www.ultratech-labs.com>

File #: MCRS-004F15C247

November 23, 2004

*All test results contained in this engineering test report are traceable to National Institute of Standards and Technology (NIST)*

### 3.3. EUT'S TECHNICAL SPECIFICATIONS

TRANSMITTER	
<b>Equipment Type:</b>	<ul style="list-style-type: none"><li>▪ Mobile</li><li>▪ Base Station (fixed use)</li></ul>
<b>Intended Operating Environment:</b>	<ul style="list-style-type: none"><li>▪ Commercial, industrial or business environment</li><li>▪ Residential environment</li></ul>
<b>Power Supply Requirement:</b>	5VDC to 30VDC
<b>RF Output Power Rating:</b>	1 mW – 1 W
<b>Operating Frequency Range:</b>	902.4 – 927.6 MHz
<b>RF Output Impedance:</b>	50 Ohms
<b>Channel Spacing:</b>	400 kHz
<b>Duty Cycle:</b>	Continuous
<b>20 dB Bandwidth:</b>	262.12 kHz
<b>Modulation Type:</b>	CP FSK
<b>Channel Occupancy:</b>	122.64 ms within 10 second period
<b>Antenna Connector Type:</b>	The MHX910A Module is tested with MCX and Reverse Polarity SMA

### 3.4. ASSOCIATED ANTENNA DESCRIPTIONS

There are five antenna families:

1. Quarter Wave Antenna Family
2. Rubber Ducky Antenna Family
3. Transit Antenna Family
4. Yagi Antenna Family
5. Omni Directional Antenna Family

The highest gain antenna from each of the above antenna families were selected for testing to represents the worst-case. Refer to antennas list exhibit for detailed specifications.

### 3.5. LIST OF EUT'S PORTS

Port Number	EUT's Port Description	Number of Identical Ports	Connector Type	Cable Type (Shielded/Non-shielded)
1	RF IN/OUT Port	1	Reversed SMA or MCX for external antenna	Shielded coaxial cable with unique coupling connectors
2	DC Supply & I/O Port	1	Pin Header	No cable, direct connection

### 3.6. ANCILLARY EQUIPMENT

The EUT was tested while connected to the following representative configuration of ancillary equipment necessary to exercise the ports during tests:

Ancillary Equipment # 1	
Description:	OMNIBOOK Laptop
Brand name:	Hewlett Packard
Model Name or Number:	DN-2100
FCC Certification	FCC DoC
Serial Number:	TW63403246
Connected to EUT's Port:	The laptop RS232 port is connected to EUT with respect to the test jig

## EXHIBIT 4. EUT OPERATING CONDITIONS AND CONFIGURATIONS DURING TESTS

### 4.1. CLIMATE TEST CONDITIONS

The climate conditions of the test environment are as follows:

Temperature:	21°C
Humidity:	51%
Pressure:	102 kPa
Power Input Source:	5VDC to 5.5VDC

### 4.2. OPERATIONAL TEST CONDITIONS & ARRANGEMENT FOR TESTS

<b>Operating Modes:</b>	<ul style="list-style-type: none"> <li>▪ Each of lowest, middle and highest channel frequencies transmits continuously for emissions measurements.</li> <li>▪ The EUT operates in normal Frequency Hopping mode for occupancy duration, and frequency separation.</li> </ul>
<b>Special Test Software &amp; Hardware:</b>	Special software provided by the Applicant are installed to allow the EUT to operate in hopping mode or at each channel frequency continuously. For example, the transmitter will be operated at each of lowest, middle and highest frequencies individually continuously during testing.
<b>Transmitter Test Antenna:</b>	The EUT is tested with the antenna fitted in a manner typical of normal intended use as a non-integral antenna equipment as described with the test results.

<b>Transmitter Test Signals</b>	
<b>Frequency Band(s):</b>	902.4 – 927.6 MHz
<b>Frequency(ies) Tested:</b> (Near lowest, near middle & near highest frequencies in the frequency range of operation.)	902.4, 915 and 927.6 MHz
<b>RF Power Output:</b> (measured maximum output power at antenna terminals)	1 Watts (conducted) and 36 dBm EIRP maximum
<b>Normal Test Modulation:</b>	CP FSK
<b>Modulating Signal Source:</b>	Internal



## EXHIBIT 5. SUMMARY OF TEST RESULTS

### 5.1. LOCATION OF TESTS

All of the measurements described in this report were performed at Ultratech Group of Labs located in the city of Oakville, Province of Ontario, Canada.

- AC Power Line Conducted Emissions were performed in UltraTech's shielded room, 24'(L) by 16'(W) by 8'(H).
- Radiated Emissions were performed at the Ultratech's 3 Meter Open Field Test Site (OFTS) situated in the Town of Oakville, province of Ontario.

The above sites have been calibrated in accordance with ANSI C63.4, and found to be in compliance with the requirements of Section 2.948 of the FCC Rules. The descriptions and site measurement data of the Oakville Open Field Test Site has been filed with FCC office (FCC File No.: 31040/SIT 1300B3) and Industry Canada office (Industry Canada File No.: IC2049). Last Date of Site Calibration: February 17, 2004.

### 5.2. APPLICABILITY & SUMMARY OF EMC EMISSION TEST RESULTS

FCC Section(s)	Test Requirements	Compliance (Yes/No)
15.107(a)	AC Power Line Conducted Emissions Measurements	Yes
15.247(a)(1)	Provisions for Frequency Hopping Systems	Yes
15.247(b)	Peak Output Power	Yes
15.247(b)(5), 1.1307, 1.1310, 2.1091 & 2.1093	RF Exposure Limit	Yes
15.247(c)	Band-Edge and RF Conducted Spurious Emissions at the Transmitter Antenna Terminal	Yes
15.247(c), 15.209 & 15.205	Transmitter Spurious Radiated Emissions	Yes

The digital circuit portion of the EUT has been tested and verified to comply with FCC Part 15, Subpart B, Class B Digital Devices and the associated Radio Receiver has also been tested and found to comply with FCC Part 15, Subpart B – Radio Receivers. The engineering test report is available upon request.

### 5.3. MODIFICATIONS INCORPORATED IN THE EUT FOR COMPLIANCE PURPOSES

None.

---

#### ULTRATECH GROUP OF LABS

3000 Bristol Circle, Oakville, Ontario, Canada L6H 6G4  
Tel. #: 905-829-1570, Fax. #: 905-829-8050, Email: [vic@ultratech-labs.com](mailto:vic@ultratech-labs.com), Website: <http://www.ultratech-labs.com>

File #: MCRS-004F15C247  
November 23, 2004

*All test results contained in this engineering test report are traceable to National Institute of Standards and Technology (NIST)*

---

---

## **EXHIBIT 6. MEASUREMENTS, EXAMINATIONS & TEST DATA FOR EMC EMISSIONS**

### **6.1. TEST PROCEDURES**

This section contains test results only. Details of test methods and procedures can be found in Exhibit 8 of this report, ANSI C63.4 and FCC Public Notice @ DA 00-705 (March 30, 2000) – Filing and Measurement Guidelines for Frequency Hopping Spread Spectrum Systems.

### **6.2. MEASUREMENT UNCERTAINTIES**

The measurement uncertainties stated were calculated in accordance with requirements of UKAS Document NIS 81 with a confidence level of 95%. Please refer to Exhibit 7 for Measurement Uncertainties.

### **6.3. MEASUREMENT EQUIPMENT USED**

The measurement equipment used complied with the requirements of the Standards referenced in the Methods & Procedures ANSI C63.4 and CISPR 16-1.

### **6.4. ESSENTIAL/PRIMARY FUNCTIONS AS DECLARED BY THE MANUFACTURER**

The essential function of the EUT is to correctly communicate data to and from radios over RF link.

**6.5. COMPLIANCE WITH FCC PART 15 – GENERAL TECHNICAL REQUIREMENTS**

FCC Section	FCC Rules	Manufacturer's Clarification
15.31	The hoping function must be disabled for tests, which should be performed with the EUT transmitting on the number of frequencies specified in this Section. The measurements made at the upper and lower ends of the band of operation should be made with the EUT tuned to the highest and lowest available channels.	See Operational Description
15.203	Described how the EUT complies with the requirement that either its antenna is permanently attached, or that it employs a unique antenna connector, for every antenna proposed for use with the EUT.  The exception is in those cases where EUT must be professionally installed. In order to demonstrate that professional installation is required, the following 3 points must be addressed: The application (or intended use) of the EUT The installation requirements of the EUT The method by which the EUT will be marketed	The antenna employs unique antenna connectors: MCX and Reverse Polarity SMA
15.204	Provided the information for every antenna proposed for use with the EUT: type (e.g. Yagi, patch, grid, dish, etc...), manufacturer and model number gain with reference to an isotropic radiator	Please see proposed antenna list.
15.247(a)	Description of how the EUT meets the definition of a frequency hopping spread spectrum, found in Section 2.1. Based on the technical description.	See Operational Description

FCC Section	FCC Rules	Manufacturer's Clarification
15.247(a)	<u>Pseudo Frequency Hopping Sequence:</u> Describe how the hopping sequence is generated. Provide an example of the hopping sequence channels, in order to demonstrate that the sequence meets the requirements specified in the definition of a frequency hopping spread spectrum system, found in Section 2.1	See Operational Description
15.247(a)	<u>Equal Hopping Frequency Use:</u> Describe how each individual EUT meets the requirement that each of its hopping channels is used equally on average (e.g. that each new transmission event begins on the next channel in the hopping sequence after final channel used in the previous transmission events).	See Operational Description
15.247(g)	Describe how the EUT complies with the requirement that it be designed to be capable of operating as a true frequency hopping system	See Operational Description
15.247(h)	Describe how the EUT complies with the requirement that it not have the ability to coordinated with other FHSS is an effort to avoid the simultaneous occupancy of individual hopping frequencies by multiple transmitters	See Operational Description
Public Notice DA 00-705	<u>System Receiver Input Bandwidth:</u> Describe how the associated receiver(s) complies with the requirement that its input bandwidth (either RF or IF) matches the bandwidth of the transmitted signal.	See Operational Description
Public Notice DA 00-705	<u>System Receiver Hopping Capability:</u> Describe how the associated receiver(s) has the ability to shift frequencies in synchronization with the transmitted signals	See Operational Description

## 6.6. AC POWER LINE CONDUCTED EMISSIONS [47 CFR §15.107(a)]

### 6.6.1. Limits

The equipment shall meet the limits of the following table:

Frequency of emission (MHz)	Class B Conducted Limits (dB $\mu$ V)		Measuring Bandwidth
	Quasi-peak	Average	
0.15–0.5 .....	66 to 56* .....	56 to 46*	RBW = 9 kHz
0.5–5 .....	56 .....	46	VBW $\geq$ 9 kHz for QP
5–30 .....	60 .....	50	VBW = 1 Hz for Average

\*Decreases linearly with the logarithm of the frequency

### 6.6.2. Method of Measurements

Refer to Exhibit 8, Section 8.2 of this test report & ANSI C63.4

### 6.6.3. Test Arrangement

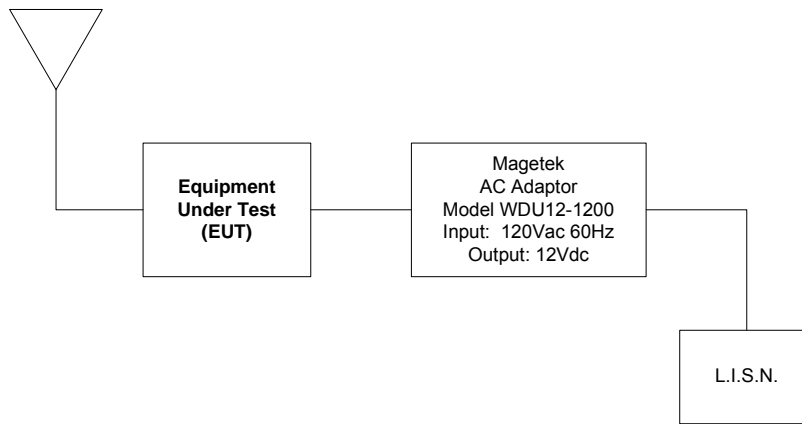

### 6.6.4. Test Equipment List

Test Instruments	Manufacturer	Model No.	Serial No.	Frequency Range
Spectrum Analyzer/ EMI Receiver	Hewlett Packard	HP 8593EM	3412A00103	9 kHz – 26.5 GHz
Transient Limiter	Hewlett Packard	11947A	310701998	9 kHz – 200 MHz 10 dB attenuation
L.I.S.N.	EMCO	3825/2	89071531	9 kHz – 200 MHz 50 Ohms / 50 $\mu$ H
24'(L) x 16'(W) x 8'(H) RF Shielded Chamber	Braden Shielding	...	...	...

6.6.5. Test Data

Plot 1:  
 AC Power Line Conducted Emissions  
 Line Voltage: 120VAC 60Hz  
 Line Tested: L1

hp

Signal	Freq (MHz)	PK Amp	QP Amp	AV Amp	QP $\Delta$ L1
1	0.153456	59.1	52.6	28.0	-13.2
2	0.504732	52.8	45.9	21.9	-10.1
3	5.861662	33.0	27.7	21.7	-32.3
4	16.962749	27.4	22.4	16.8	-37.6

ACTV DET: PEAK  
 MEAS DET: PEAK QP AVG  
 MKR 17.04 MHz  
 34.32 dB $\mu$ V

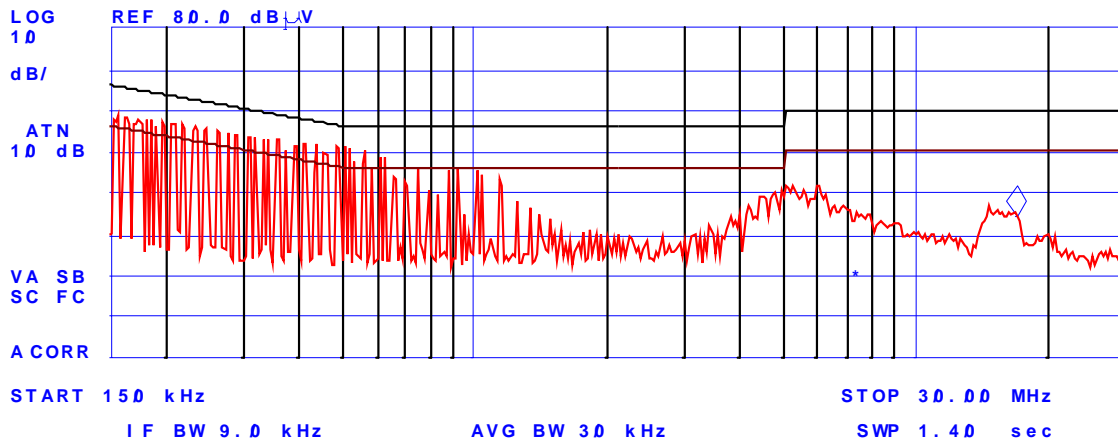

Plot 2:  
 AC Power Line Conducted Emissions  
 Line Voltage: 120VAC 60Hz  
 Line Tested: L2

hp

Signal	Freq (MHz)	PK Amp	QP Amp	AV Amp	QP $\Delta$ L1
1	0.153450	59.5	52.7	28.0	-13.1
2	0.504738	53.5	46.0	21.1	-10.0
3	5.861663	41.0	38.5	34.7	-21.5
4	16.962750	36.3	33.7	30.8	-26.3

ACTV DET: PEAK  
 MEAS DET: PEAK QP AVG  
 MKR 17.04 MHz  
 32.89 dB $\mu$ V

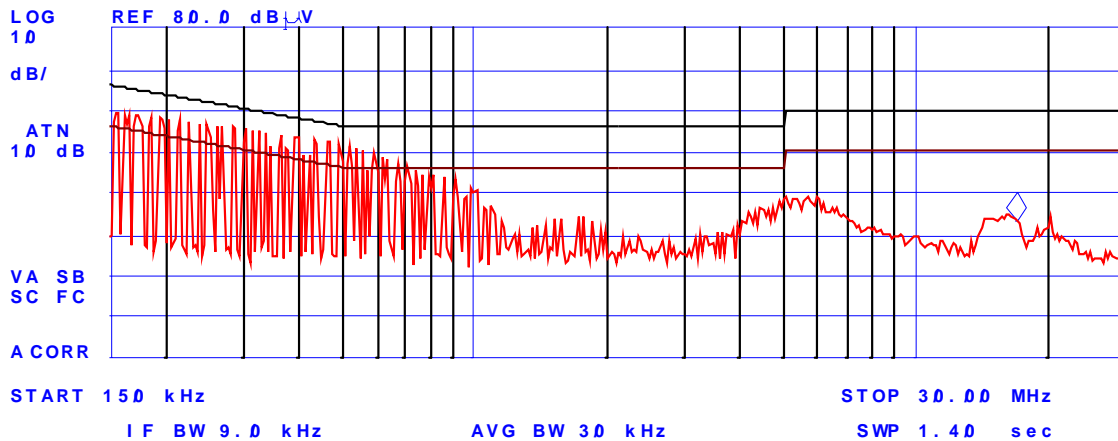

## 6.7. PROVISIONS FOR FREQUENCY HOPPING SYSTEMS [§ 15.247(a)(1)]

### 6.7.1. Limits

- **§ 15.247(a)(1)**: Frequency hopping systems shall have hopping channel carrier frequencies separated by a minimum of 25 kHz or the 20 dB bandwidth of the hopping channel, whichever is greater. The system shall hop to channel frequencies that are selected at the system hopping rate from a pseudorandomly ordered list of hopping frequencies. Each frequency must be used equally on the average by each transmitter. The system receivers shall have input bandwidths that match the hopping channel bandwidths of their corresponding transmitters and shall shift frequencies in synchronization with the transmitted signals.
- **§ 15.247(a)(1)(i)**: For frequency hopping systems operating in the 902–928 MHz band: if the 20 dB bandwidth of the hopping channel is less than 250 kHz, the system shall use at least 50 hopping frequencies and the average time of occupancy on any frequency shall not be greater than 0.4 seconds within a 20 second period; if the 20 dB bandwidth of the hopping channel is 250 kHz or greater, the system shall use at least 25 hopping frequencies and the average time of occupancy on any frequency shall not be greater than 0.4 seconds within a 10 second period. The maximum allowed 20 dB bandwidth of the hopping channel is 500 kHz.

### 6.7.2. Method of Measurements

Refer to FCC 15.247(a)(1), ANSI C63.4 and Public Notice DA 00-705

#### Carrier Frequency Separation:

The hopping function of the EUT is enabled. Use the spectrum analyzer setting as follows:

- Span = wide enough to capture the peaks of two adjacent channels
- RBW = 1% of the span
- VBW  $\geq$  RBW
- Sweep = Auto
- Detector = peak
- Trace = max hold

#### Number of hopping frequency:

The hopping function of the EUT is enabled. Use the spectrum analyzer setting as follows:

- Span = the frequency band of operation
- RBW = 1% of the span
- VBW  $\geq$  RBW
- Sweep = Auto
- Detector = peak
- Trace = max hold



**Time of Occupancy (Dwell Time):**

The hopping function of the EUT is enabled. Use the spectrum analyzer setting as follows:

- Span = 0 Hz centered on a hopping channel
- RBW = 1 MHz
- VBW  $\geq$  RBW
- Sweep = as necessary to capture the entire dwell time per hopping channel
- Detector = peak
- Trace = max hold

If possible, use the marker-delta function to determine the dwell time. If this value varies with different modes of operation (e.g. data rate modulation format, etc.), repeat this test for each variation. The limit is specified in one of the subparagraphs of this Section. Submit this plot(s). An oscilloscope may be used instead of a spectrum analyzer.

**20 dB Bandwidth:**

Use the spectrum analyzer setting as follows:

- Span = approximately 2 to 3 times the 20 dB bandwidth, centered on a hopping channel
- RBW = 1% of the 20 dB bandwidth
- VBW  $\geq$  RBW
- Sweep = auto
- Detector = peak
- Trace = max hold
- The transmitter shall be transmitting at its maximum data rate.
- Allow the trace to stabilize.
- Use the marker-to-peak function to set the marker to the peak of the emission.
- Use the marker-delta function to measure 20 dB down on both sides of the emission.
- The 20 dB BW is the delta reading in frequency between two markers.

**6.7.3. Test Arrangement**

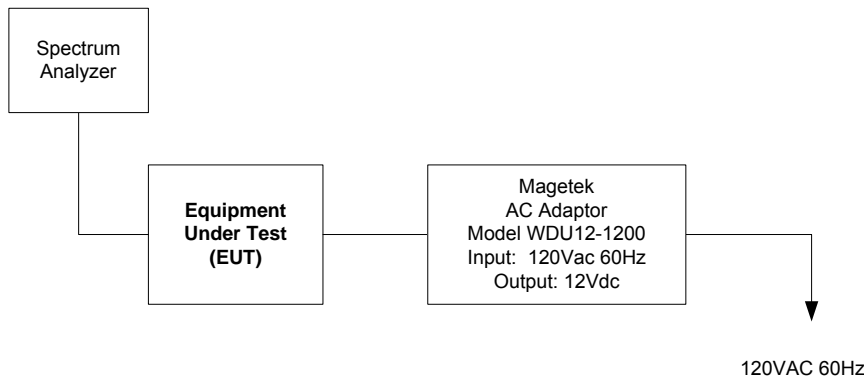

#### 6.7.4. Test Equipment List

Test Instruments	Manufacturer	Model No.	Serial No.	Frequency Range
Spectrum Analyzer	Rhode & Schwarz	FSEK20/B4/B21	834157/005	9kHz – 40GHz

#### 6.7.5. Test Data

Test Description	FCC Specification	Measured Values	Comments
20 dB BW of the hopping channel	500 kHz maximum	262.12 kHz	Pass; see plots 3 to 5 for measurement details.
Channel Hopping Frequency Separation	Minimum of 25 kHz or 20dB BW whichever is greater.	398.80 kHz	Pass; see plot 6 for measurement details.
Number hopping frequencies	At least 25 hopping frequencies	50 hopping frequencies	Pass; see plots 7 to 13 for measurement details
Average Time of Occupancy	Not greater than 0.4 seconds within 10 second period	122.64 ms within 10 second period	Pass; see plots 14 to 19 for measurement details.

Plot 3:  
20 dB Bandwidth  
Test Frequency: 902.4 MHz

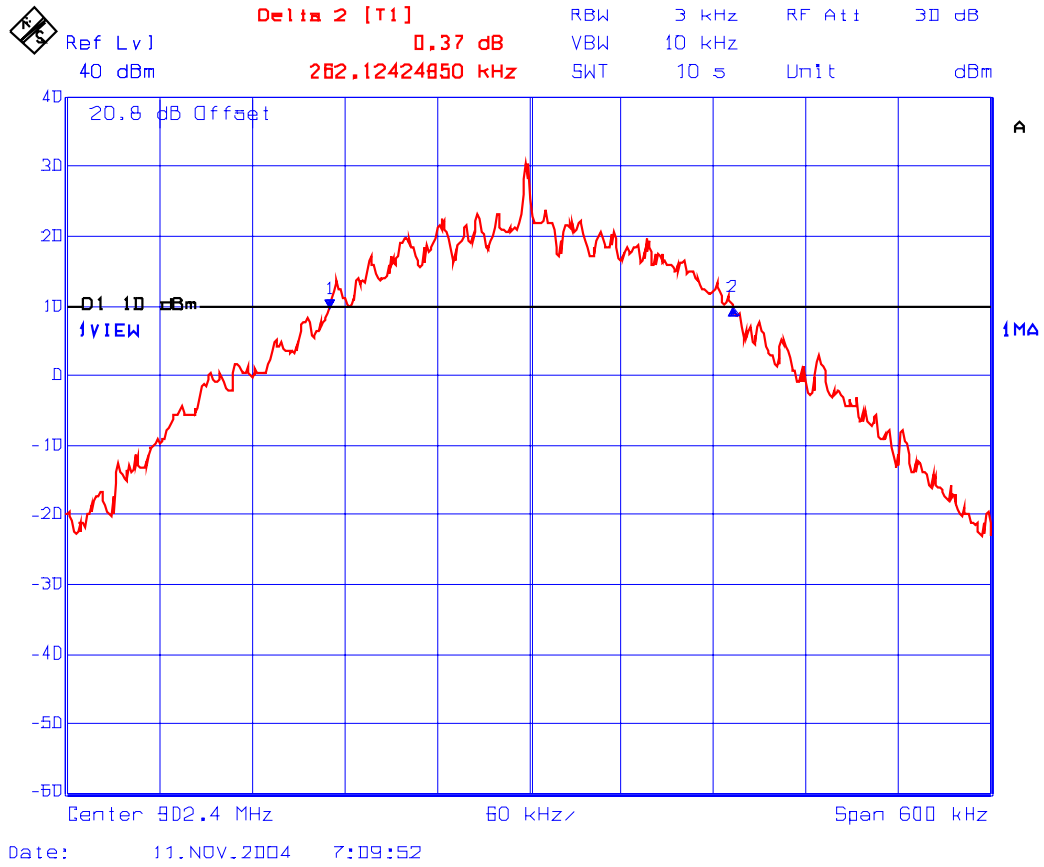

**ULTRATECH GROUP OF LABS**

3000 Bristol Circle, Oakville, Ontario, Canada L6H 6G4  
Tel. #: 905-829-1570, Fax. #: 905-829-8050, Email: [yic@ultratech-labs.com](mailto:yic@ultratech-labs.com), Website: <http://www.ultratech-labs.com>

File #: MCRS-004F15C247

November 23, 2004

All test results contained in this engineering test report are traceable to National Institute of Standards and Technology (NIST)

Plot 4:  
20 dB Bandwidth  
Test Frequency: 915 MHz

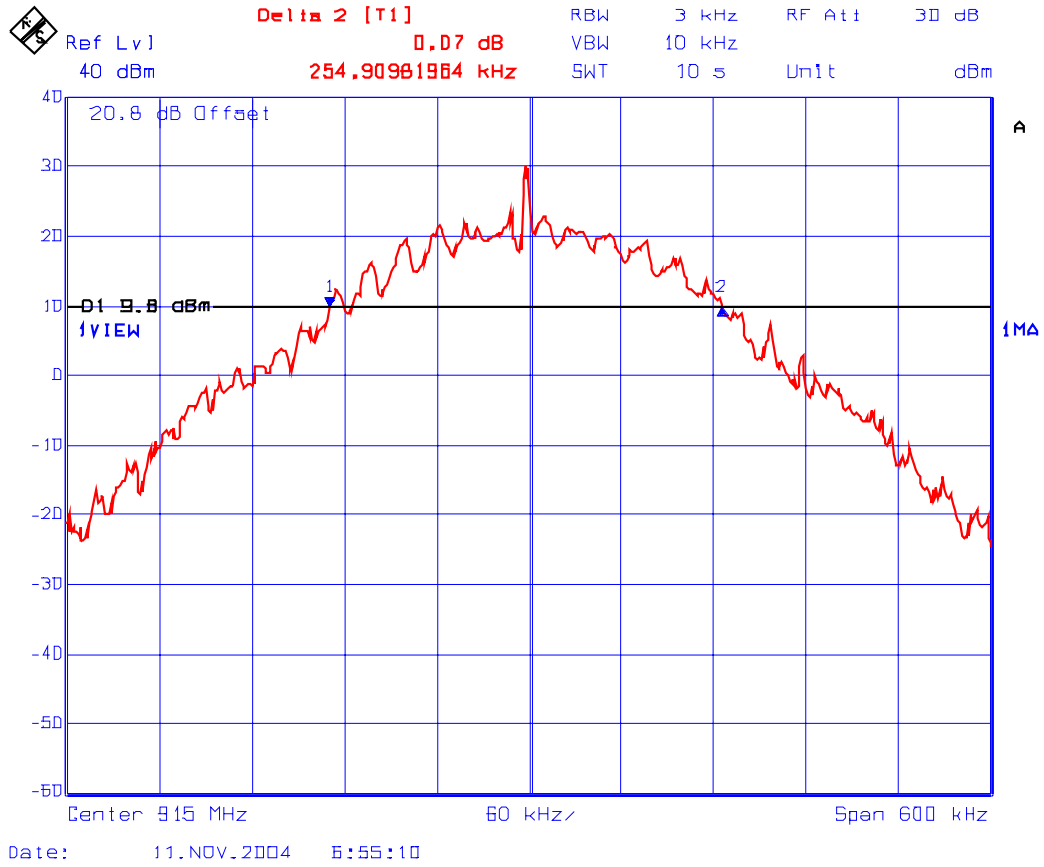

**ULTRATECH GROUP OF LABS**

3000 Bristol Circle, Oakville, Ontario, Canada L6H 6G4  
Tel. #: 905-829-1570, Fax. #: 905-829-8050, Email: [vic@ultratech-labs.com](mailto:vic@ultratech-labs.com), Website: <http://www.ultratech-labs.com>

File #: MCRS-004F15C247

November 23, 2004

All test results contained in this engineering test report are traceable to National Institute of Standards and Technology (NIST)

Plot 5:  
20 dB Bandwidth  
Test Frequency: 927.6 MHz

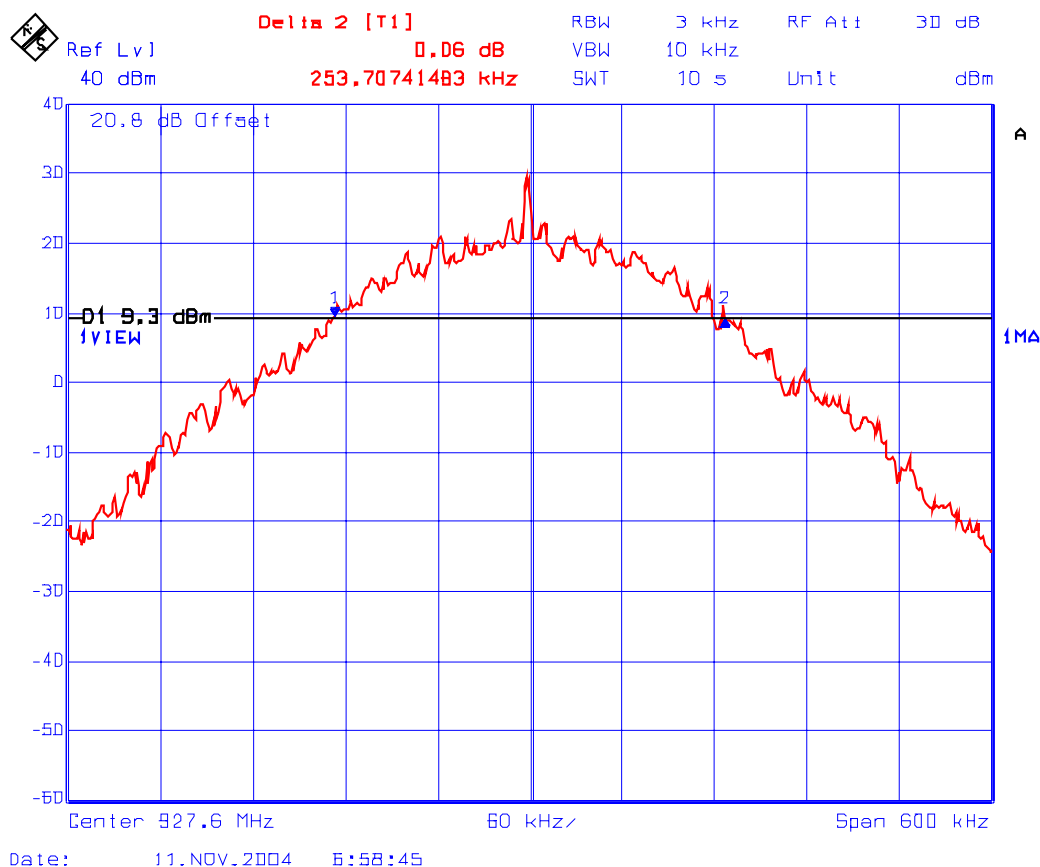

**ULTRATECH GROUP OF LABS**

3000 Bristol Circle, Oakville, Ontario, Canada L6H 6G4  
Tel. #: 905-829-1570, Fax. #: 905-829-8050, Email: [vic@ultratech-labs.com](mailto:vic@ultratech-labs.com), Website: <http://www.ultratech-labs.com>

File #: MCRS-004F15C247  
November 23, 2004

All test results contained in this engineering test report are traceable to National Institute of Standards and Technology (NIST)

Plot 6:  
Carrier Frequency Separation

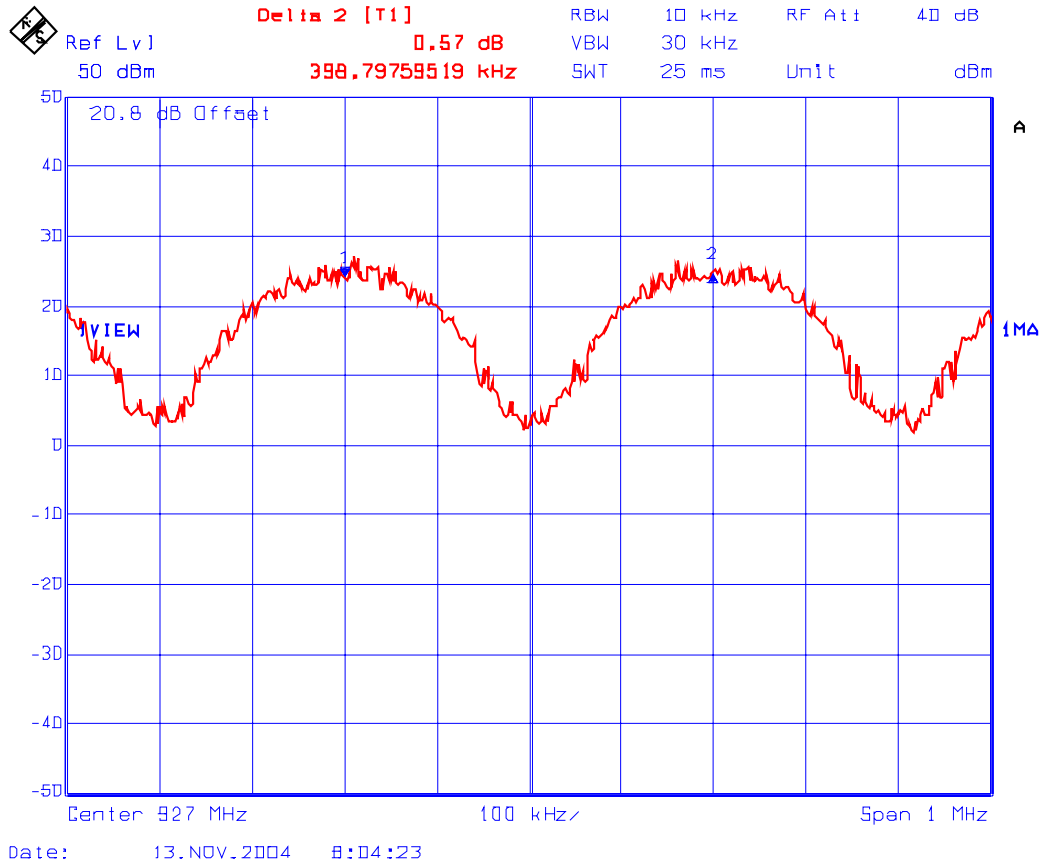

Plot 7:  
 Number of Hopping Frequencies  
 50 Hopping Frequencies (from 902-928 MHz)

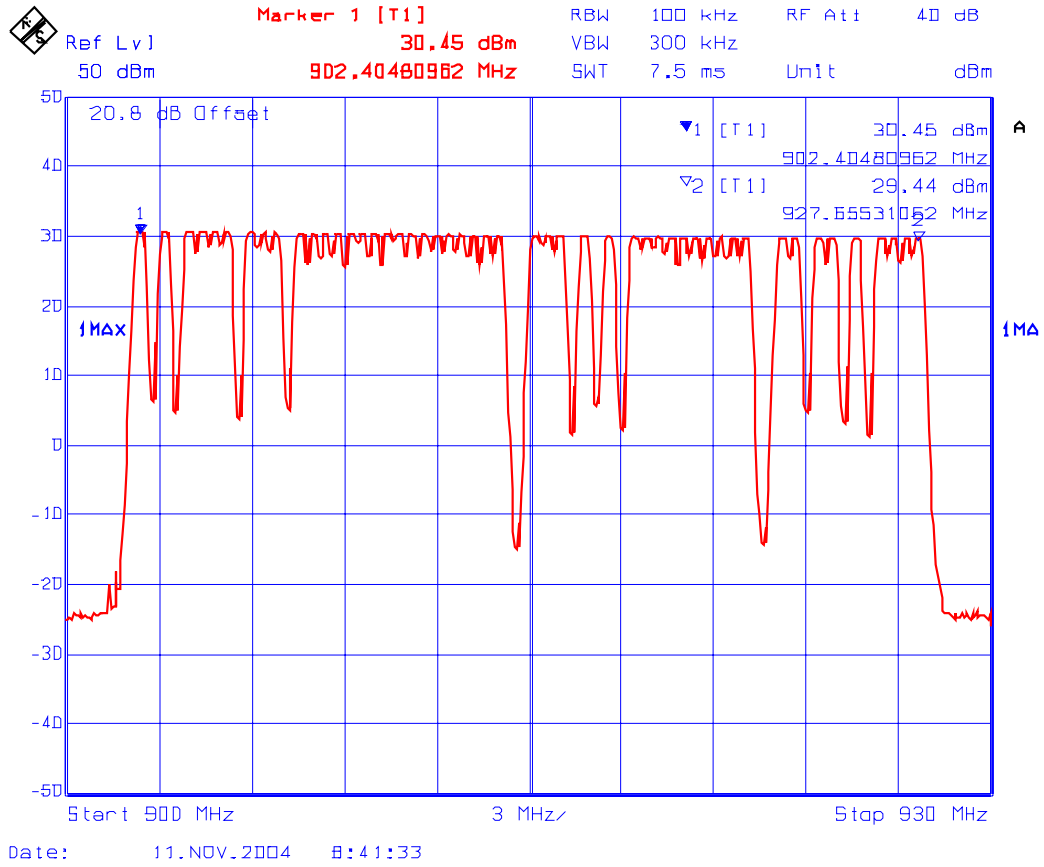

Plot 8:  
 Number of Hopping Frequencies  
 6 hopping frequencies (from 901-906 MHz)

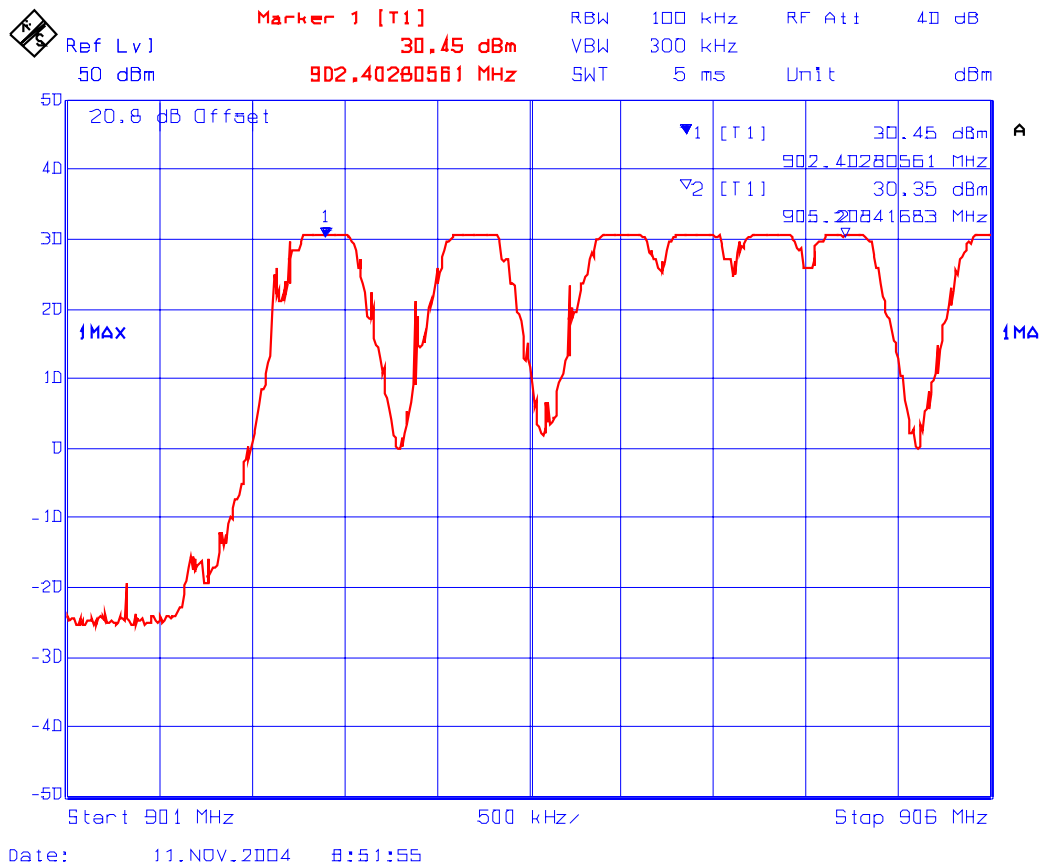



Plot 9:  
 Number of Hopping Frequencies  
 9 hopping frequencies (from 905-910 MHz)

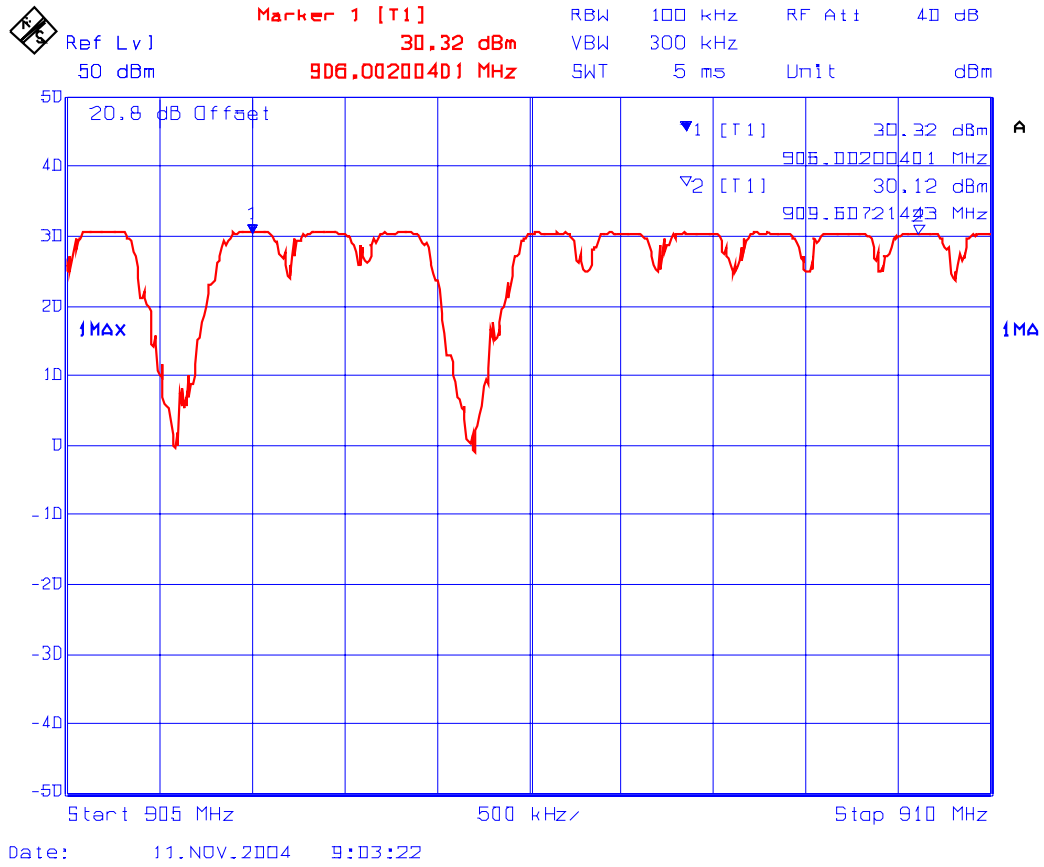

Plot 10:  
Number of Hopping Frequencies  
11 hopping frequencies (from 909-915 MHz)

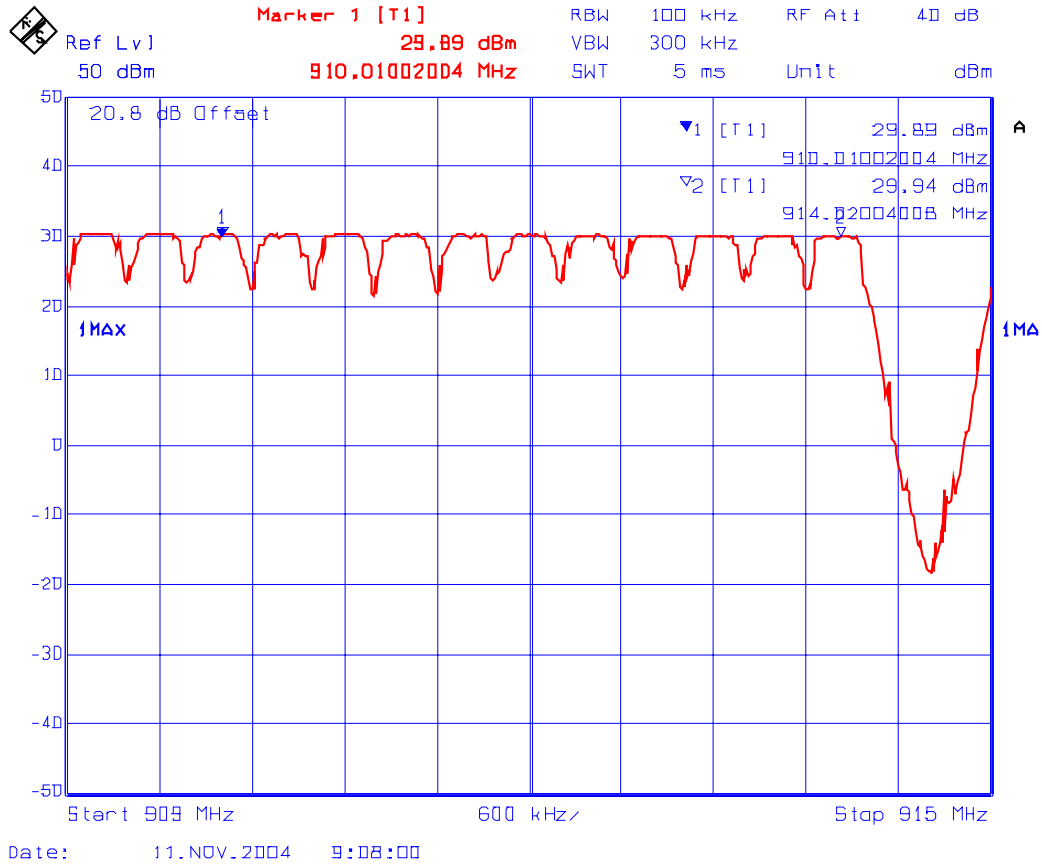

Plot 11:  
Number of Hopping Frequencies  
9 Hopping Frequencies (from 914-920 MHz)

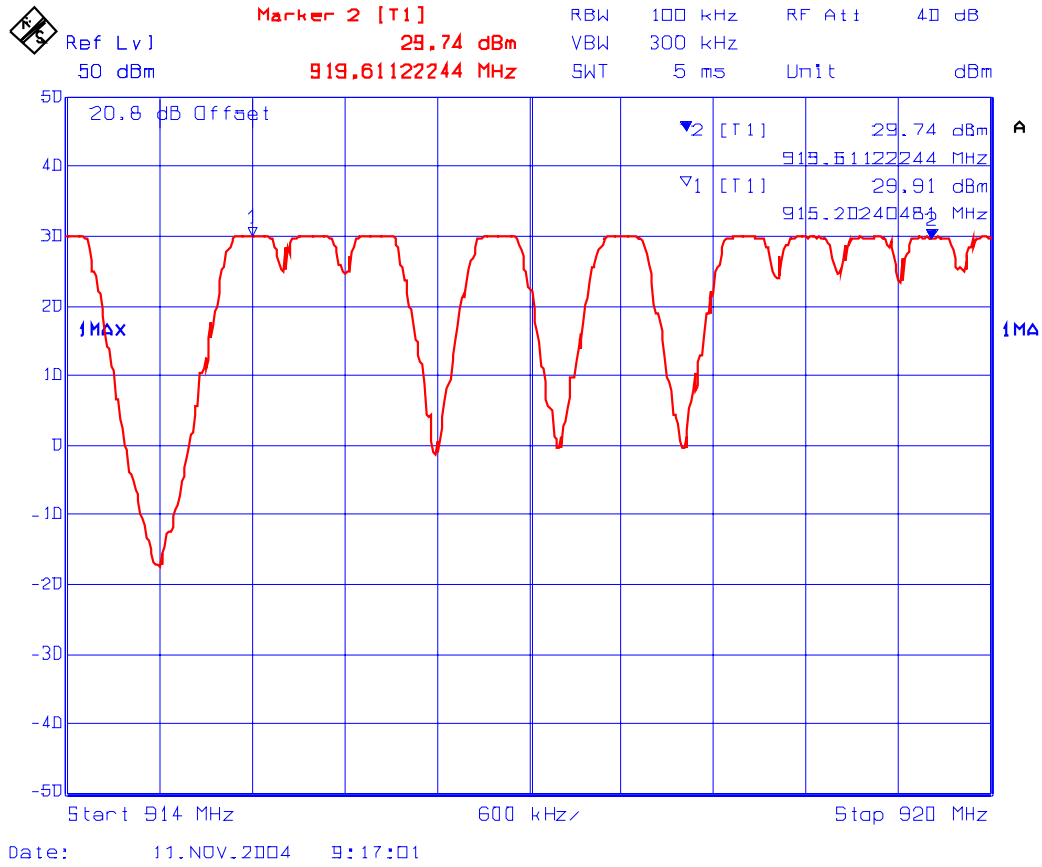

Plot 12:  
 Number of Hopping Frequencies  
 10 hopping frequencies (from 919-925 MHz)

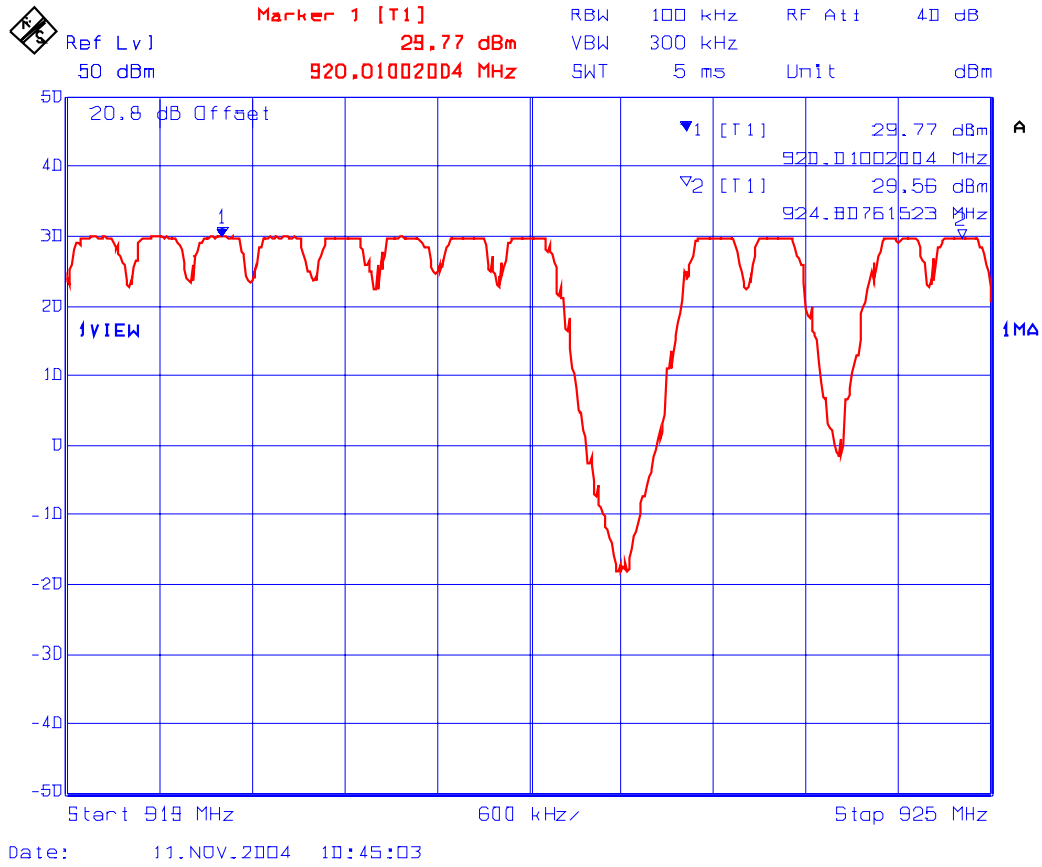

Plot 13:  
 Number of Hopping Frequencies  
 5 hopping frequencies (from 924-930 MHz)

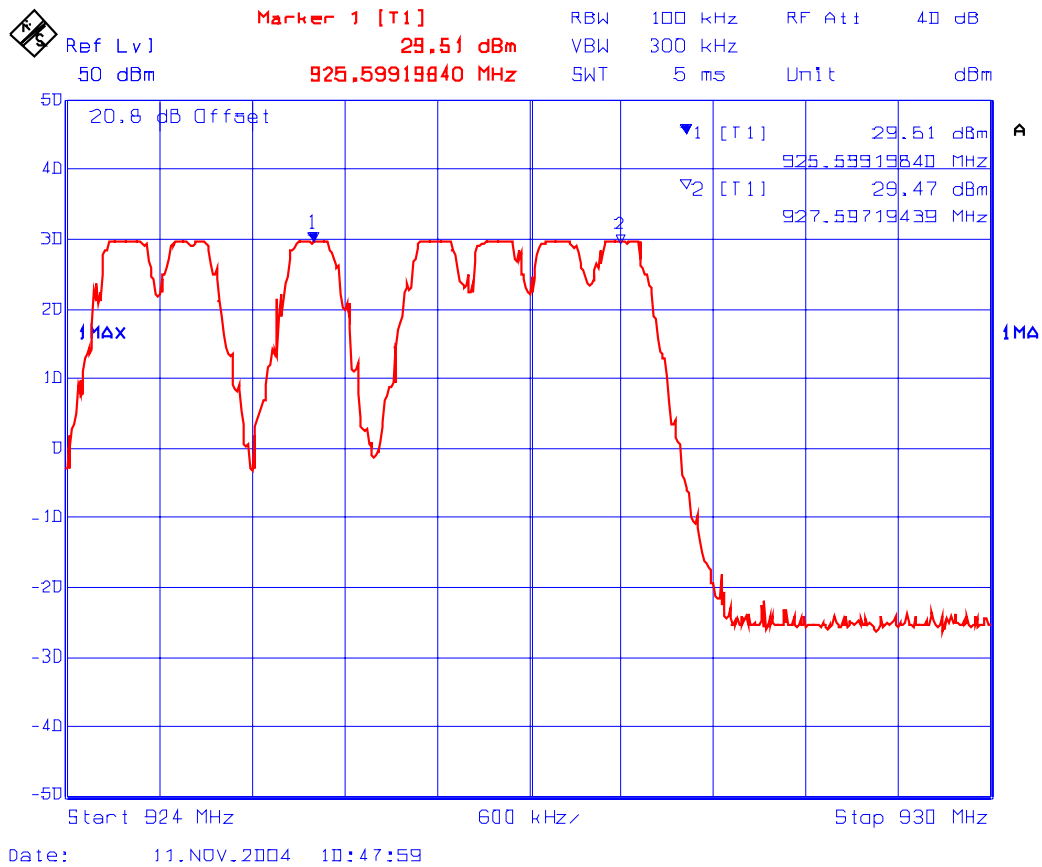

Plot 14:  
Time of Occupancy  
Test Frequency: 902.4 MHz

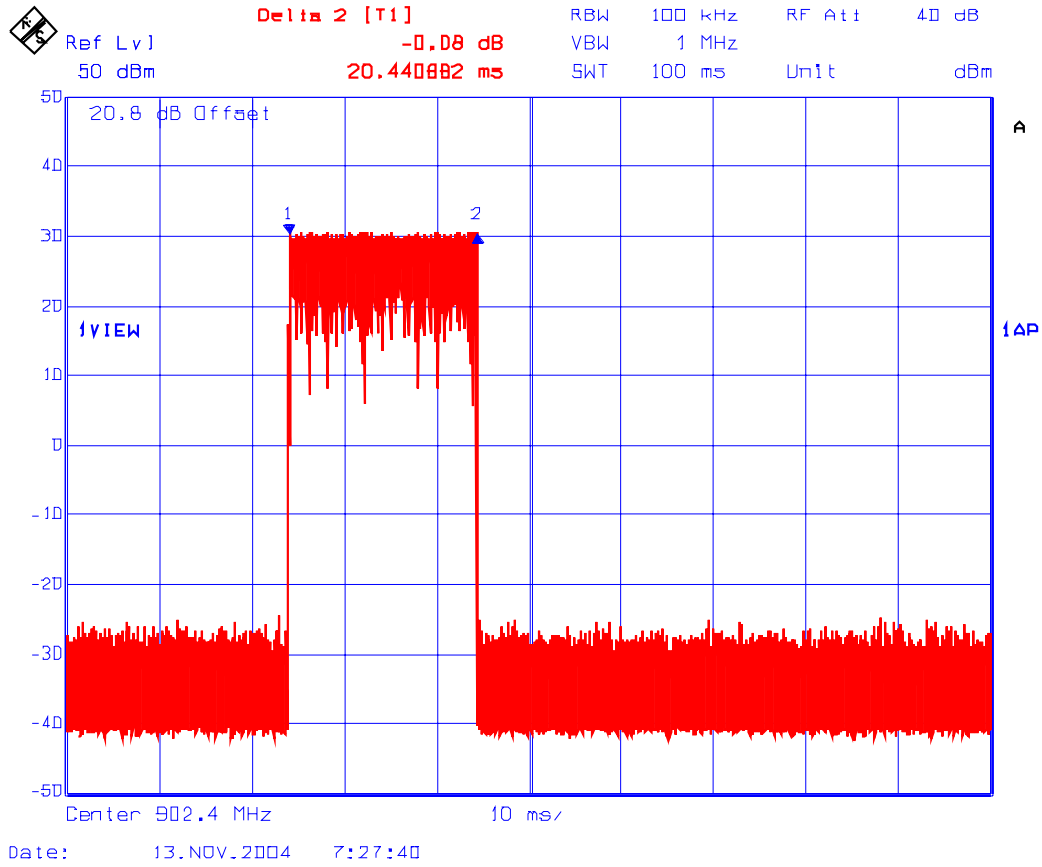

Dwell Time @ 902.4 MHz = 20.44 ms

Plot 15:  
 Time of Occupancy  
 Test Frequency: 902.4 MHz

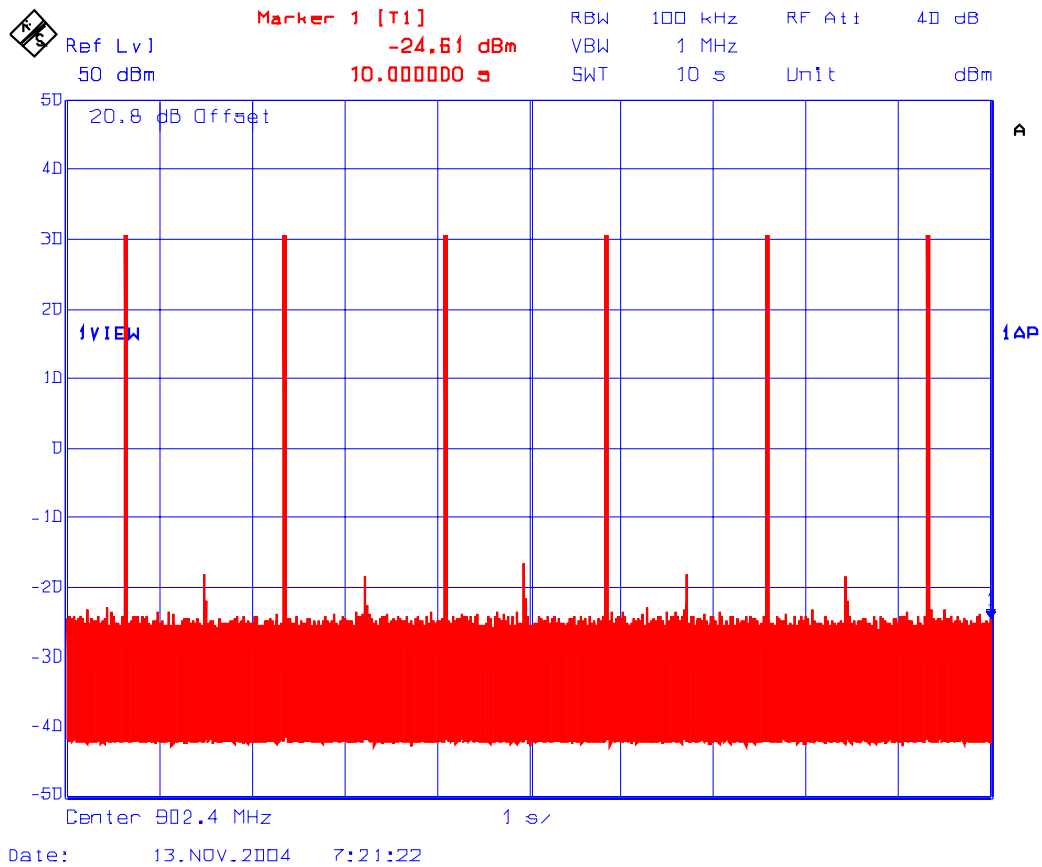

$$\begin{aligned}
 \text{Average time of occupancy in 10 s} &= (\text{Dwell Time @ 902.4 MHz}) \times (\text{number of hops in 10 s}) \\
 &= 20.44 \text{ ms} \times 6 \\
 &= 122.64 \text{ ms}
 \end{aligned}$$

Plot 16:  
Time of Occupancy  
Test Frequency: 915 MHz

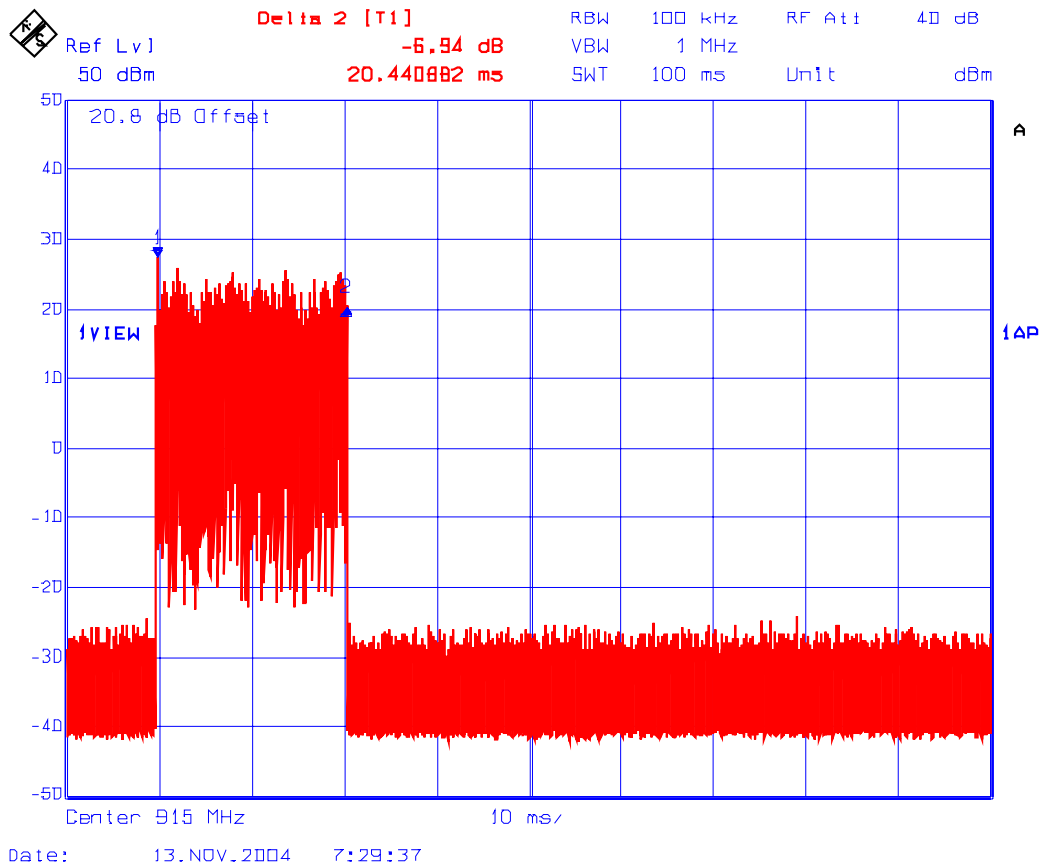

Dwell Time @ 915 MHz = 20.44 ms



Plot 17:  
 Time of Occupancy  
 Test Frequency: 915 MHz

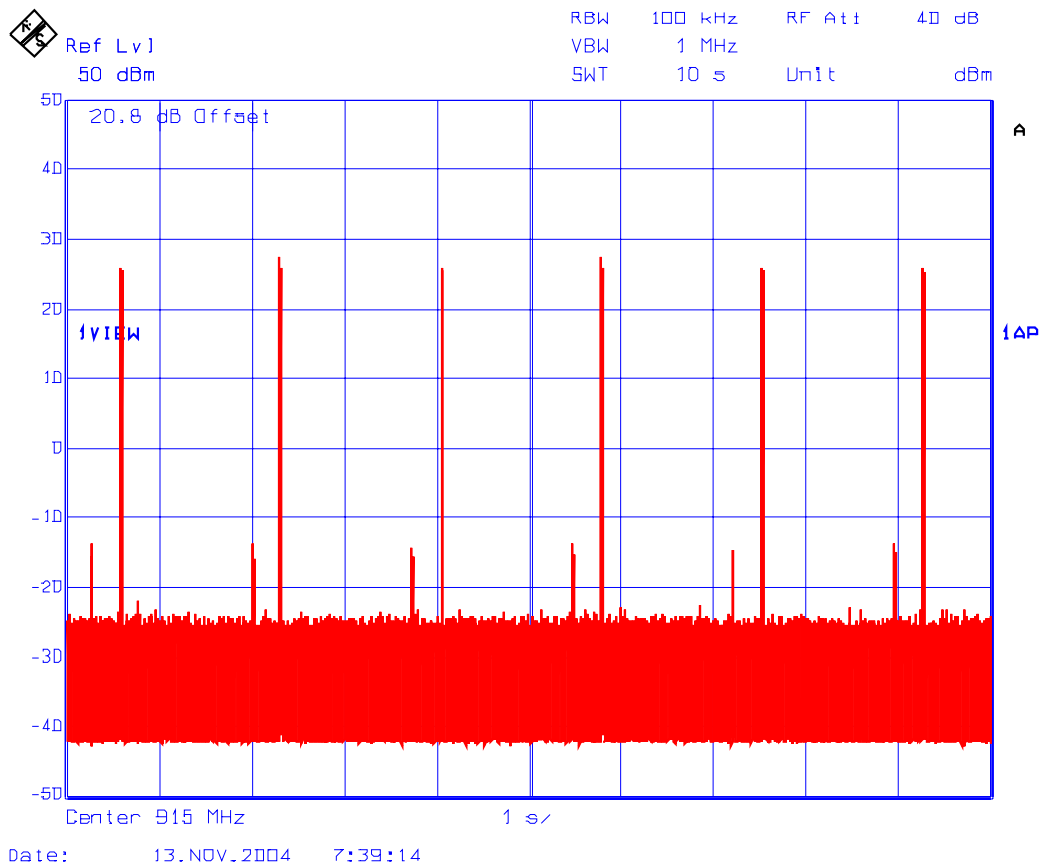

$$\begin{aligned}
 \text{Average time of occupancy in 10 s} &= (\text{Dwell Time @ 915 MHz}) \times (\text{number of hops in 10 s}) \\
 &= 20.44 \text{ ms} \times 6 \\
 &= 122.64 \text{ ms}
 \end{aligned}$$

Plot 18:  
Time of Occupancy  
Test Frequency: 927.6 MHz

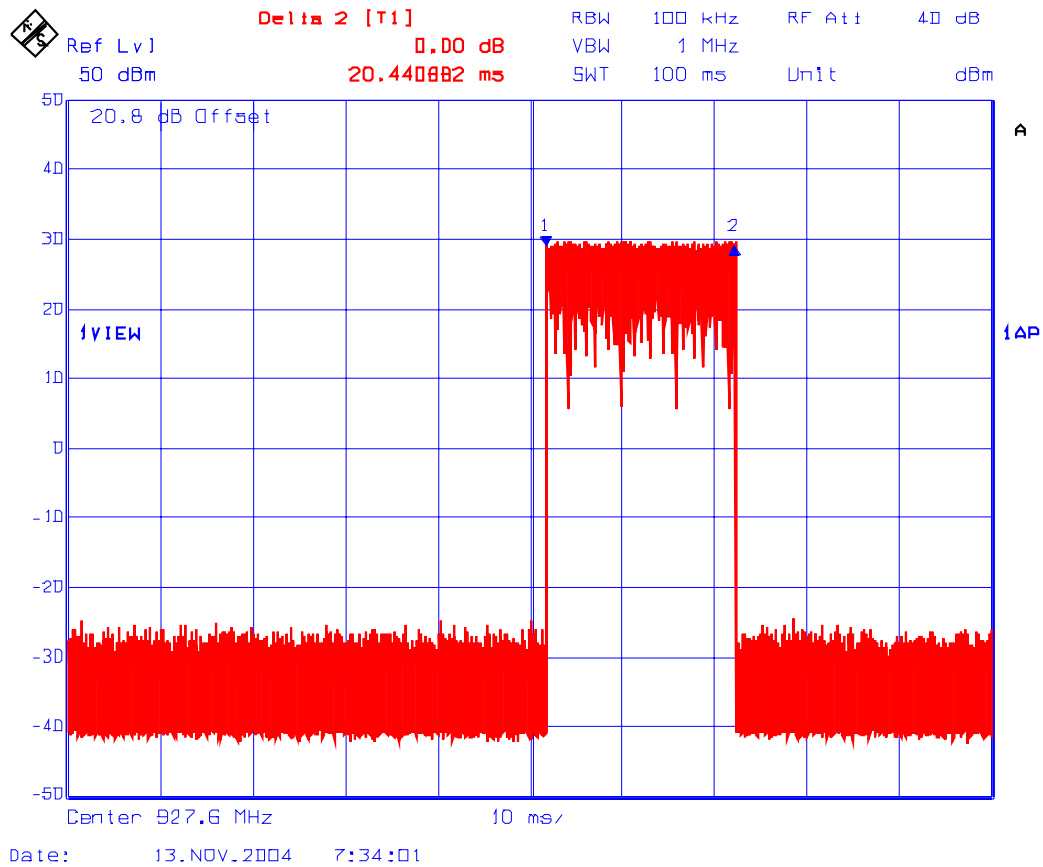

Dwell Time @ 927.6 MHz = 20.44 ms

Plot 19:  
Time of Occupancy  
Test Frequency: 927.6 MHz

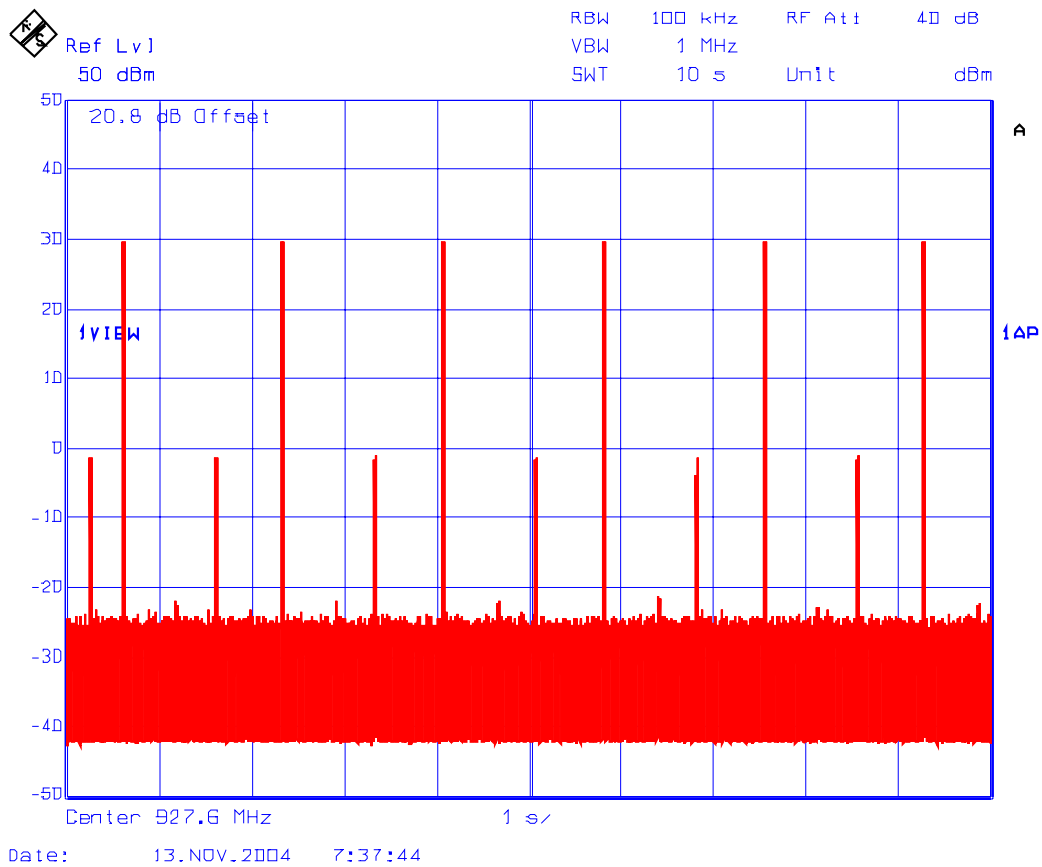

$$\begin{aligned} \text{Average time of occupancy in 10 s} &= (\text{Dwell Time @ 927.6 MHz}) \times (\text{number of hops in 10 s}) \\ &= 20.44 \text{ ms} \times 6 \\ &= 122.64 \text{ ms} \end{aligned}$$

FCC Specification	Manufacturer's Explanation
<b>FCC Requirement @ Section 15.247(a)(1):</b> The system shall hop to channel frequencies that are selected at the system hopping rate from a pseudorandomly ordered list of hopping frequencies. Each frequency must be used equally on the average by each transmitter. The system receivers shall have input bandwidths that match the hopping channel bandwidths of their corresponding transmitters and shall shift frequencies in synchronization with the transmitted signals	Conform. Refer to section 6.5 of this report.
<b>FCC Requirement @ Section 15.247(g):</b> Describe how the EUT complies with the requirement that it be designed to be capable of operating as a true frequency hopping system	Conform. Refer to section 6.5 of this report.
<b>FCC Requirement @ Section 15.247(h):</b> Describe how the EUT complies with the requirement that it does not have the ability to coordinated with other FHSS is an effort to avoid the simultaneous occupancy of individual hopping frequencies by multiple transmitters	Conform. Refer to section 6.5 of this report.

## 6.8. PEAK OUTPUT POWER & EQUIVALENT ISOTROPIC RADIATED POWER (EIRP) [§ 15.247(b)]

### 6.8.1. Limits

§15.247(b)(2): For frequency hopping systems operating in the 902-928 MHz band: 1 watt for systems employing at least 50 hopping channels; and, 0.25 watts for systems employing less than 50 hopping channels, but at least 25 hopping channels.

§15.247(b)(4): If the antennas of directional gain greater than 6 dBi are used, the peak power from the intentional radiator shall be reduced below, as appropriate, by the amount in dB that the directional gain of the antenna exceeds 6 dBi.

### 6.8.2. Method of Measurements

Refer to Exhibit 8, Section 8.3 and ANSI C63.4.

### 6.8.3. Test Arrangement

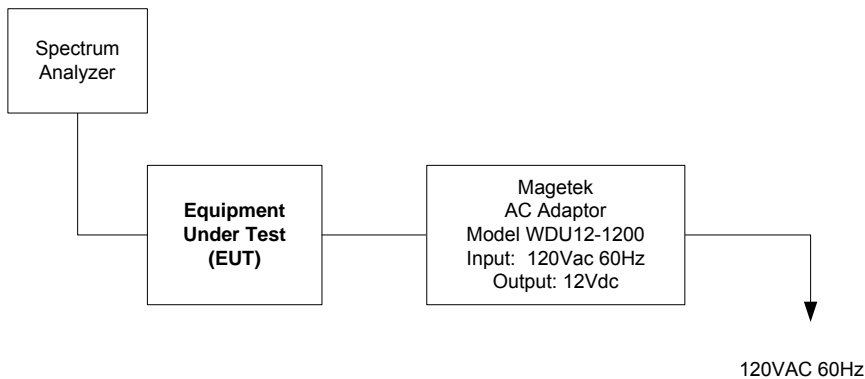

### 6.8.4. Test Equipment List

Test Instruments	Manufacturer	Model No.	Serial No.	Frequency Range
Spectrum Analyzer	Rhode & Schwarz	FSEK20/B4/B21	834157/005	9kHz – 40GHz

**6.8.5. Test Data**

Transmitter Channel	Frequency (MHz)	Peak Output Power at Antenna Terminal (dBm)	Calculated EIRP (dBm)	Peak Output Power Limit (dBm)	EIRP Limit (dBm)
Power Setting: 1W					
Lowest	902.4	29.93	See Note 1	30.0	36.0
Middle	915.0	29.81	See Note 1	30.0	36.0
Highest	927.6	29.29	See Note 1	30.0	36.0
Power Setting: 1 mW					
Lowest	902.4	0.00	See Note 1	30.0	36.0
Middle	915.0	0.11	See Note 1	30.0	36.0
Highest	927.6	-0.12	See Note 1	30.0	36.0

Notes:

1. The EIRP shall be calculated based on the transmitter antenna gain ( $G_{dBi}$ ), cable loss ( $CL_{dB}$ ) and peak output power at antenna terminal ( $P_{dBm}$ ). Calculated EIRP =  $P_{dBm} + G_{dBi} - CL_{dB}$
2. EIRP shall not exceed 36 dBm limit (Power Setting =  $36 \text{ dBm} - G_{dBi} + G_{dBi}$ ). See pages 4 - 5 of the Operating Manual for instruction of power setting.

## 6.9. RF EXPOSURE REQUIRMENTS [§§ 15.247(b)(4), 1.1310 & 2.1091]

### 6.9.1. Limits

- **FCC 15.247(b)(4):** Systems operating under provisions of this section shall be operated in a manner that ensures that the public is not exposed to radio frequency energy levels in excess of the Commission’s guidelines. See @ 1.1307(b)(1).
- **FCC 1.1310:-** The criteria listed in the following table shall be used to evaluate the environmental impact of human exposure to radio-frequency (RF) radiation as specified in 1.1307(b).

TABLE 1—LIMITS FOR MAXIMUM PERMISSIBLE EXPOSURE (MPE)

Frequency range (MHz)	Electric field strength (V/m)	Magnetic field strength (A/m)	Power density (mW/cm <sup>2</sup> )	Averaging time (minutes)
<b>(A) Limits for Occupational/Controlled Exposures</b>				
0.3–3.0 .....	614	1.63	*(100)	6
3.0–30 .....	1842/f	4.89/f	*(900/f <sup>2</sup> )	6
30–300 .....	61.4	0.163	1.0	6
300–1500 .....	.....	.....	f/300	6
1500–100,000 .....	.....	.....	5	6
<b>(B) Limits for General Population/Uncontrolled Exposure</b>				
0.3–1.34 .....	614	1.63	*(100)	30
1.34–30 .....	824/f	2.19/f	*(180/f <sup>2</sup> )	30
30–300 .....	27.5	0.073	0.2	30
300–1500 .....	.....	.....	f/1500	30
1500–100,000 .....	.....	.....	1.0	30

f = frequency in MHz

\* = Plane-wave equivalent power density

NOTE 1 TO TABLE 1: Occupational/controlled limits apply in situations in which persons are exposed as a consequence of their employment provided those persons are fully aware of the potential for exposure and can exercise control over their exposure. Limits for occupational/controlled exposure also apply in situations when an individual is transient through a location where occupational/controlled limits apply provided he or she is made aware of the potential for exposure.

NOTE 2 TO TABLE 1: General population/uncontrolled exposures apply in situations in which the general public may be exposed, or in which persons that are exposed as a consequence of their employment may not be fully aware of the potential for exposure or can not exercise control over their exposure.

### 6.9.2. Method of Measurements

Refer to FCC @ 1.1310, 2.1091 and Public Notice DA 00-705 (March 30, 2000)

Spread spectrum transmitters operating under section 15.247 are categorically from routine environmental evaluation to demonstrating RF exposure compliance with respect to MPE and/or SAR limits. These devices are not exempted from compliance (As indicated in Section 15.247(b)(4), these transmitters are required to operate in a manner that ensures that exposure to public users and nearby persons) does not exceed the Commission’s RF exposure guidelines (see Section 1.1307 and 2.1093). Unless a device operates at substantially low power levels, with a low gain antenna(s), supporting information is generally needed to establish the various potential operating configurations and exposure conditions of a transmitter and its antenna(s) in order to determine compliance with the RF exposure guidelines.

In order to demonstrate compliance with MPE requirements (see Section 2.1091), the following information is typically needed:

- (1) Calculation that estimates the minimum separation distance (20 cm or more) between an antenna and persons required to satisfy power density limits defined for free space.
- (2) Antenna installation and device operating instructions for installers (professional/unskilled users), and the parties responsible for ensuring compliance with the RF exposure requirement
- (3) Any caution statements and/or warning labels that are necessary in order to comply with the exposure limits
- (4) Any other RF exposure related issues that may affect MPE compliance

**Calculation Method of RF Safety Distance:**

$$S = PG/4\pi r^2 = EIRP/4\pi r^2$$

Where: P: power input to the antenna in mW  
EIRP: Equivalent (effective) isotropic radiated power  
S: power density mW/cm<sup>2</sup>  
G: numeric gain of antenna relative to isotropic radiator  
r: distance to centre of radiation in cm

$$r = \sqrt{EIRP/4\pi S}$$

For portable transmitters (see Section 2.1093), or devices designed to operate next to a person's body, compliance is determined with respect to the SAR limit (define in the body tissues) for near-field exposure conditions. If the maximum average output power, operating condition configurations and exposure conditions are comparable to those of existing cellular and PCS phones, SAR evaluation may be required in order to determine if such a device complies with SAR limit. When SAR evaluation data is not available, and the additional supporting information cannot assure compliance, the Commission may request that an SAR evaluation be performed, as provided for in Section 1.1307(d)



**6.9.3. Test Data**

<b>Evaluation of RF Exposure Compliance Requirements</b>	
<b>RF Exposure Requirements</b>	<b>Compliance with FCC Rules</b>
Minimum calculated separation distance between antenna and persons required: <b>*23 cm</b>	Manufacturer' instruction for separation distance between antenna and persons required: <b>23 cm.</b>
Antenna installation and device operating instructions for installers (professional/unskilled users), and the parties responsible for ensuring compliance with the RF exposure requirement	Antenna installation and device operating instructions shall be provided to installers to maintain and ensure compliance with RF exposure requirements.
Caution statements and/or warning labels that are necessary in order to comply with the exposure limits	Please refer to User's Manual for RF Exposure Information.
Any other RF exposure related issues that may affect MPE compliance	None.

\*The minimum separation distance between the antenna and bodies of users are calculated using the following formula:

RF EXPOSURE DISTANCE LIMITS:  $r = (PG/4\pi S)^{1/2} = (EIRP/4\pi S)^{1/2}$

$S = 902/1500 \text{ mW/cm}^2$   
 $EIRP = 36.0 \text{ dBm} = 10^{36/10} \text{ mW max. (Worst Case)}$

$r = (EIRP/4\pi S)^{1/2} = (10^{36/10}/4\pi(902/1500))^{1/2} = 23 \text{ cm}$

## 6.10. TRANSMITTER BAND-EDGE & SPURIOUS CONDUCTED EMISSIONS [§ 15.247(c)]

### 6.10.1. Limits

In any 100 KHz bandwidth outside the operating frequency band, the radio frequency power that is produced by modulation products of the spreading sequence, the information sequence and the carrier frequency shall be at least 20 dB below that in any 100 KHz bandwidth within the band that contains the highest level of the desired power.

### 6.10.2. Method of Measurements

Refer to Exhibit 8, Section 8.4 of this test report.

### 6.10.3. Test Arrangement

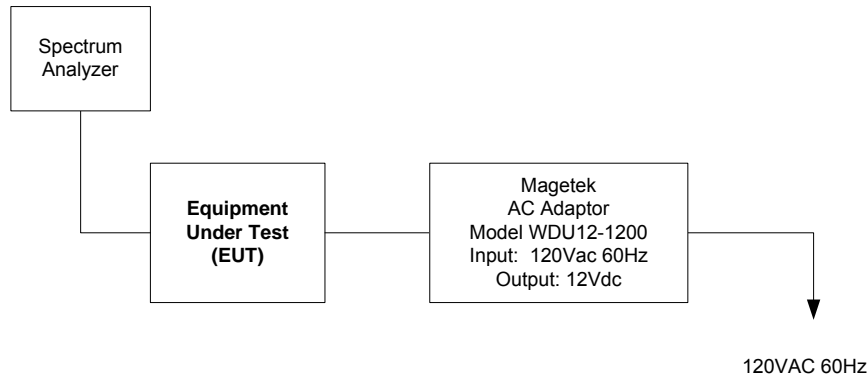

### 6.10.4. Test Equipment List

Test Instruments	Manufacturer	Model No.	Serial No.	Frequency Range
Spectrum Analyzer	Rhode & Schwarz	FSEK20/B4/B21	834157/005	9kHz – 40GHz

### 6.10.5. Test Data

#### 6.10.5.1. Band-Edge RF Conducted Emissions

Refer to the following test data plots (20 to 23) for measurement results:

Plot 20:  
Band-Edge RF Conducted Emissions  
Low End of Frequency Band  
Single Frequency Mode

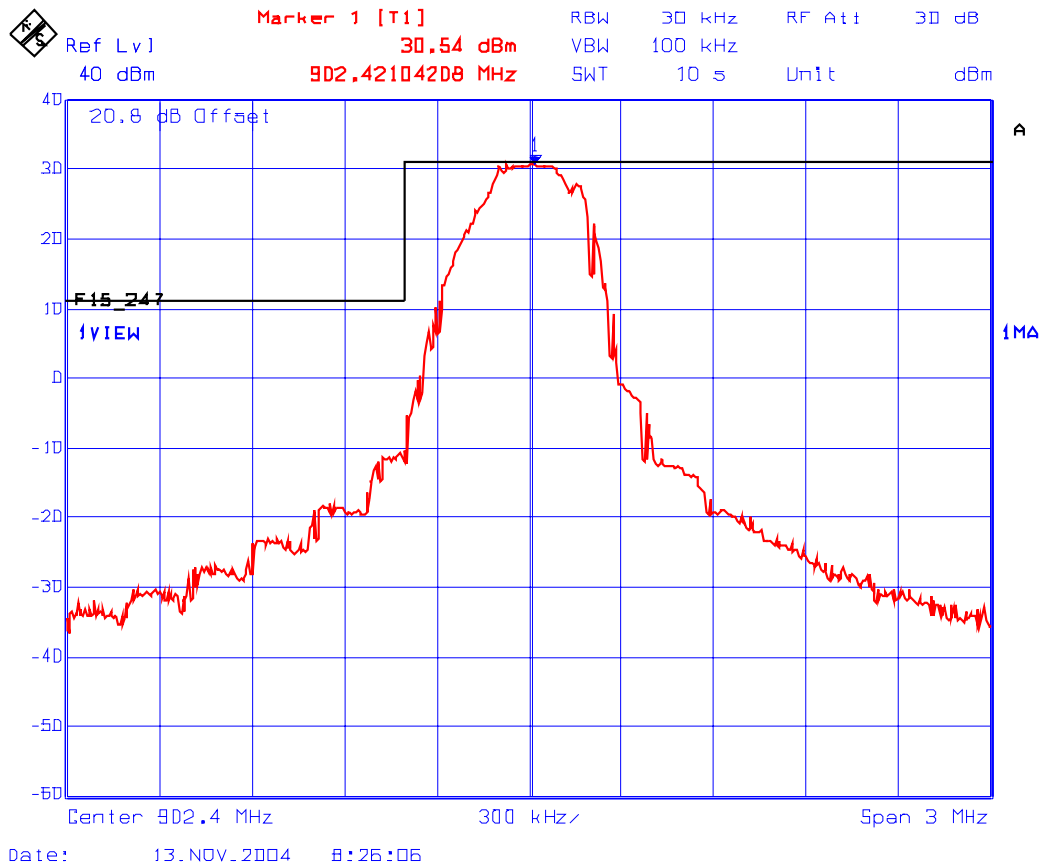

Plot 21:  
Band-Edge RF Conducted Emissions  
Low End of Frequency Band  
Pseudorandom Channel Hopping Mode

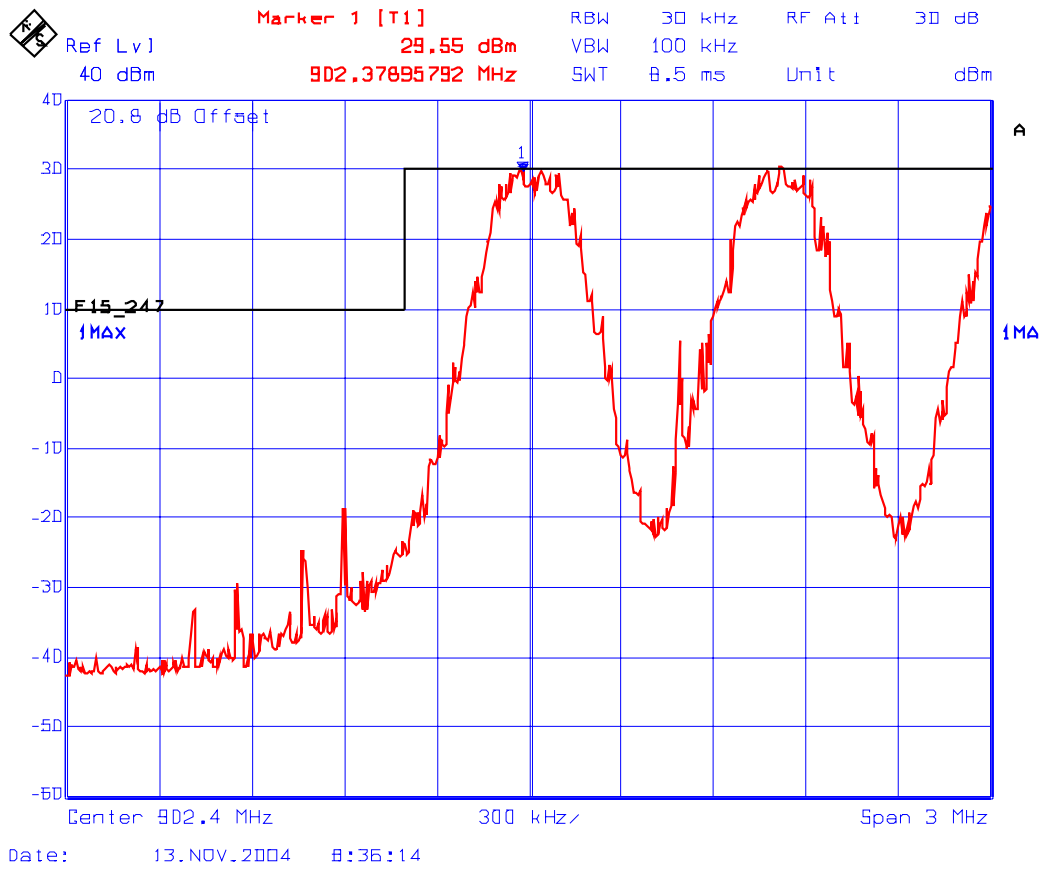

Plot 22:  
Band-Edge RF Conducted Emissions  
High End of Frequency Band  
Single Frequency Mode

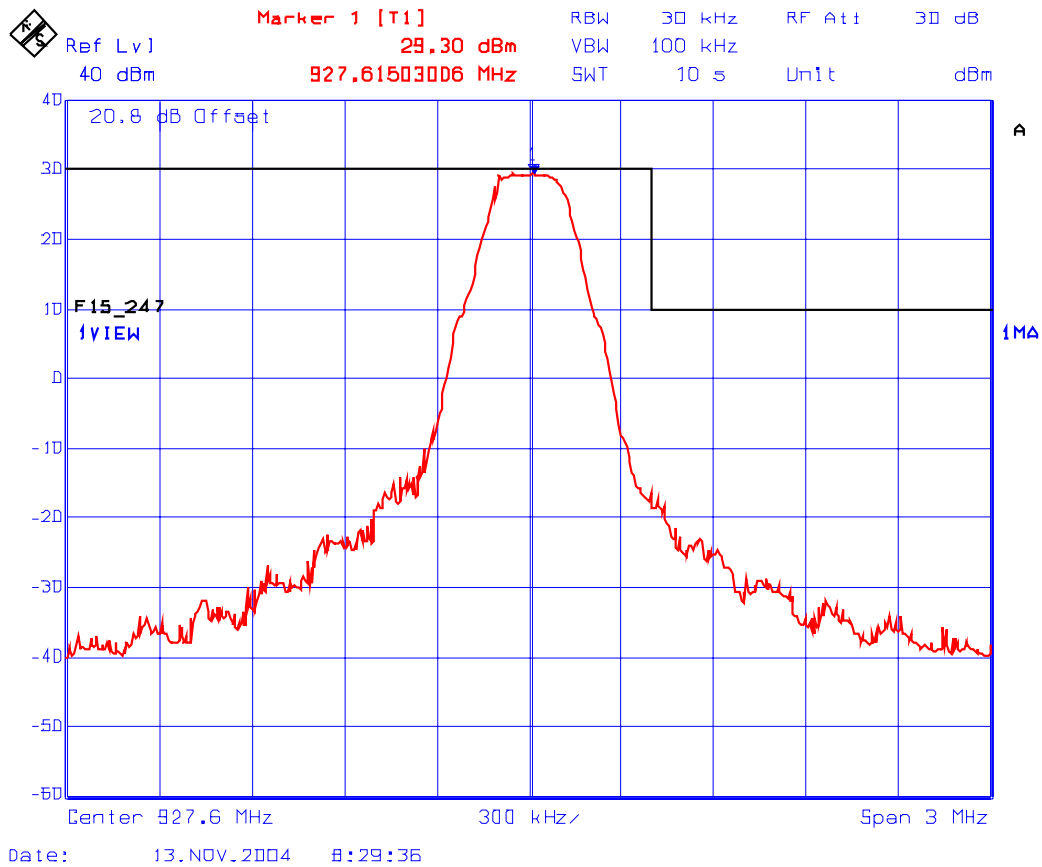

**ULTRATECH GROUP OF LABS**

3000 Bristol Circle, Oakville, Ontario, Canada L6H 6G4  
Tel. #: 905-829-1570, Fax. #: 905-829-8050, Email: [vic@ultratech-labs.com](mailto:vic@ultratech-labs.com), Website: <http://www.ultratech-labs.com>

File #: MCRS-004F15C247  
November 23, 2004

All test results contained in this engineering test report are traceable to National Institute of Standards and Technology (NIST)

Plot 23:  
Band-Edge RF Conducted Emissions  
High End of Frequency Band  
Pseudorandom Channel Hopping Mode

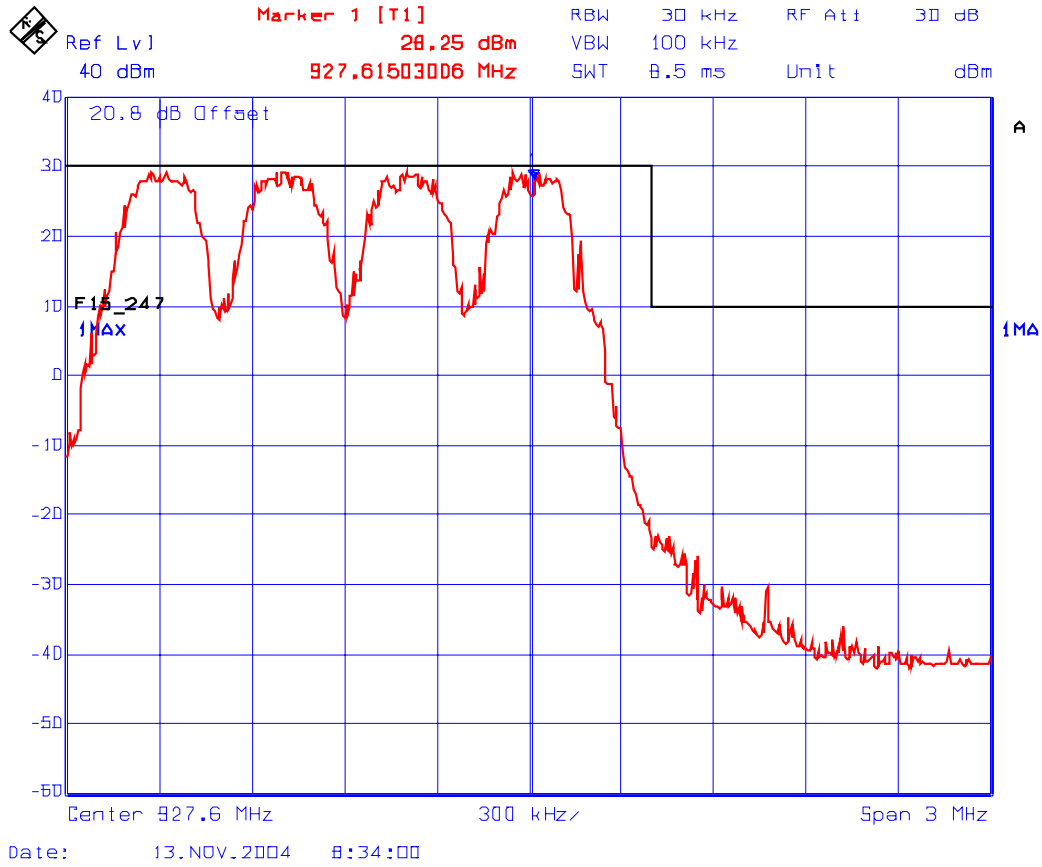

**ULTRATECH GROUP OF LABS**

3000 Bristol Circle, Oakville, Ontario, Canada L6H 6G4  
Tel. #: 905-829-1570, Fax. #: 905-829-8050, Email: [vic@ultratech-labs.com](mailto:vic@ultratech-labs.com), Website: <http://www.ultratech-labs.com>

File #: MCRS-004F15C247

November 23, 2004

All test results contained in this engineering test report are traceable to National Institute of Standards and Technology (NIST)

### 6.10.5.2. Spurious RF Conducted Emissions

#### 6.10.5.2.1. Lowest Frequency (902.4 MHz)

The emissions were scanned from 10 MHz to 10 GHz; refer to the following test data plots 24 to 27 for measurement results.

Plot 24:  
Spurious RF Conducted Emissions  
Transmitter Frequency: 902.4 MHz at 1W Output Power Setting

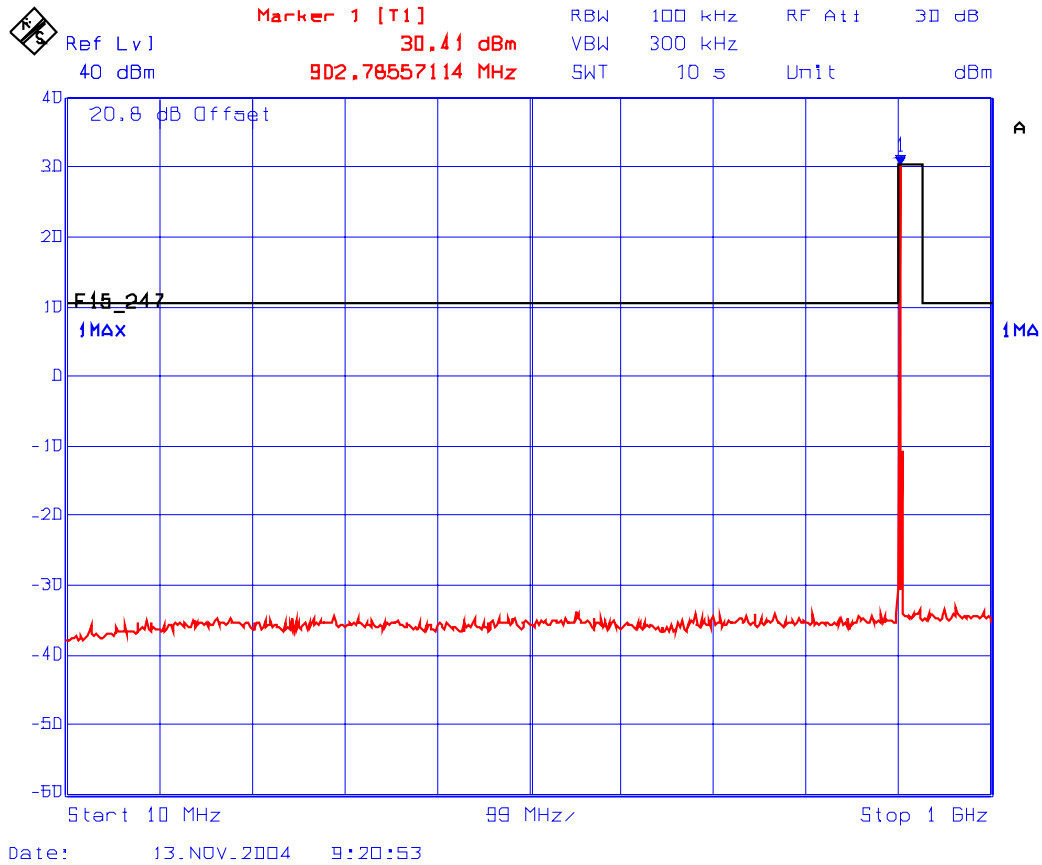

Plot 25:  
 Spurious RF Conducted Emissions  
 Transmitter Frequency: 902.4 MHz at 1W Output Power Setting

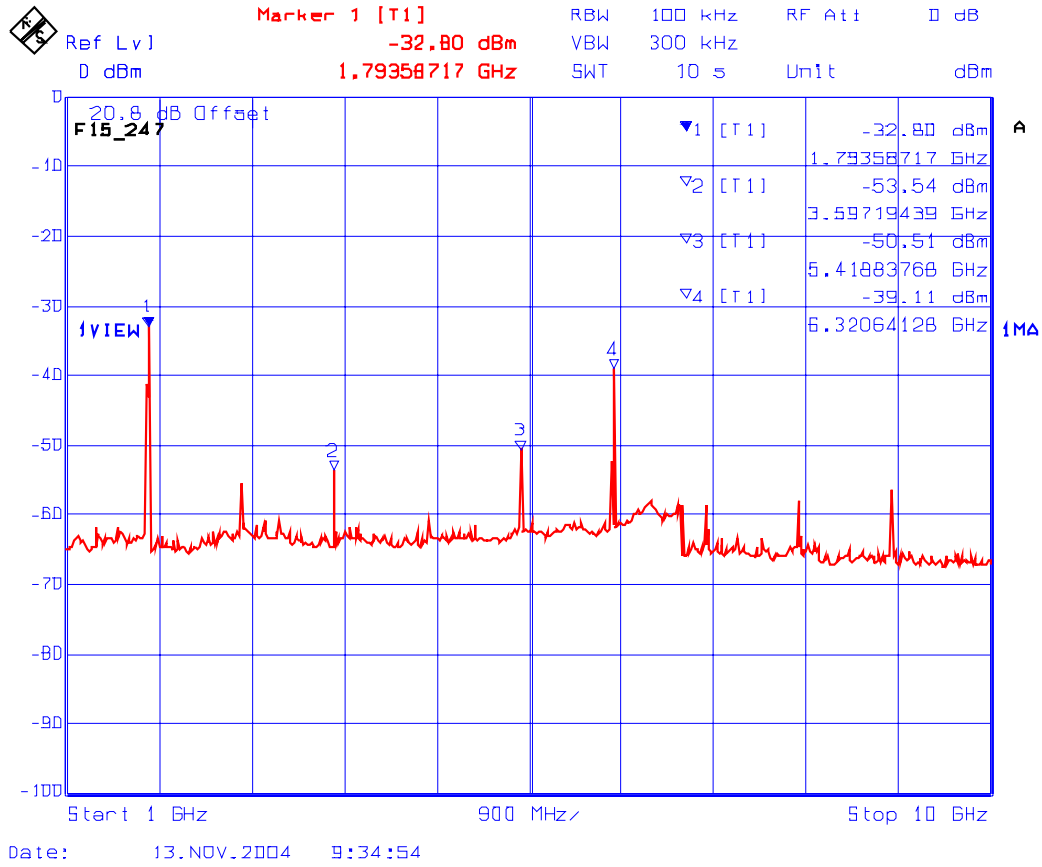



Plot 26:  
Spurious RF Conducted Emissions  
Transmitter Frequency: 902.4 MHz at 1mW Output Power Setting

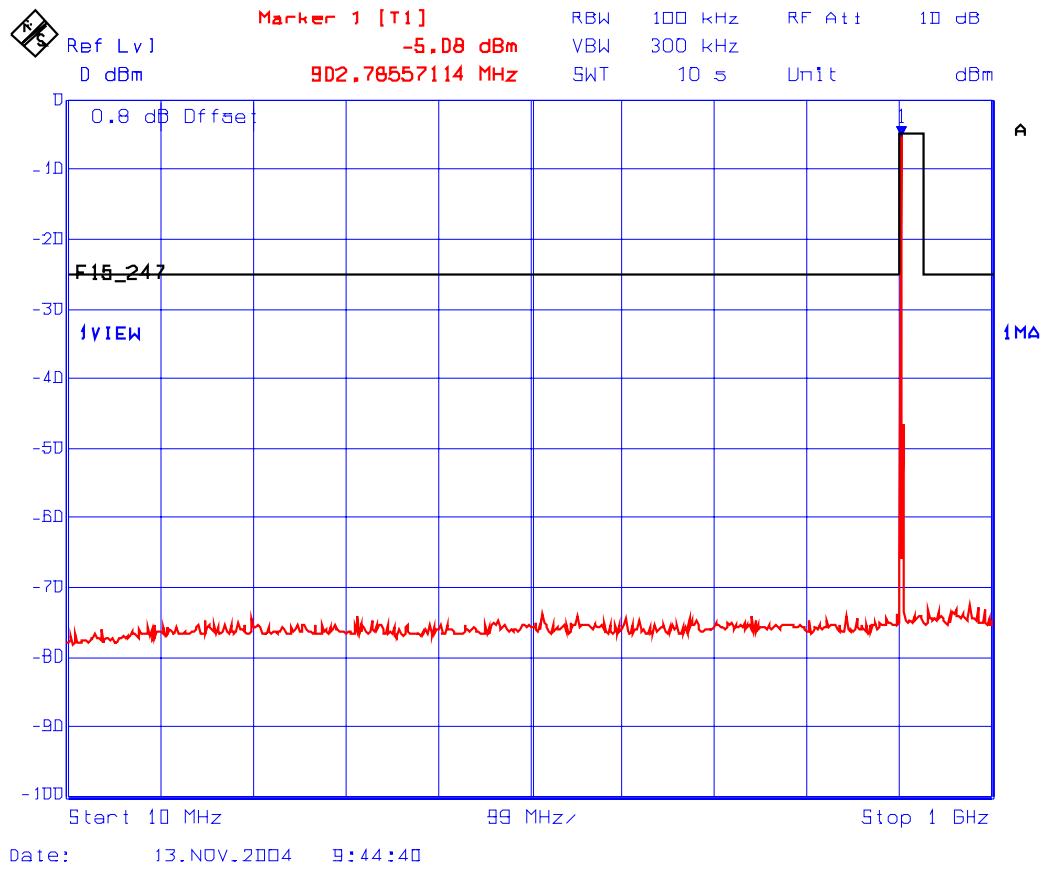

Plot 27:  
 Spurious RF Conducted Emissions  
 Transmitter Frequency: 902.4 MHz at 1mW Output Power Setting

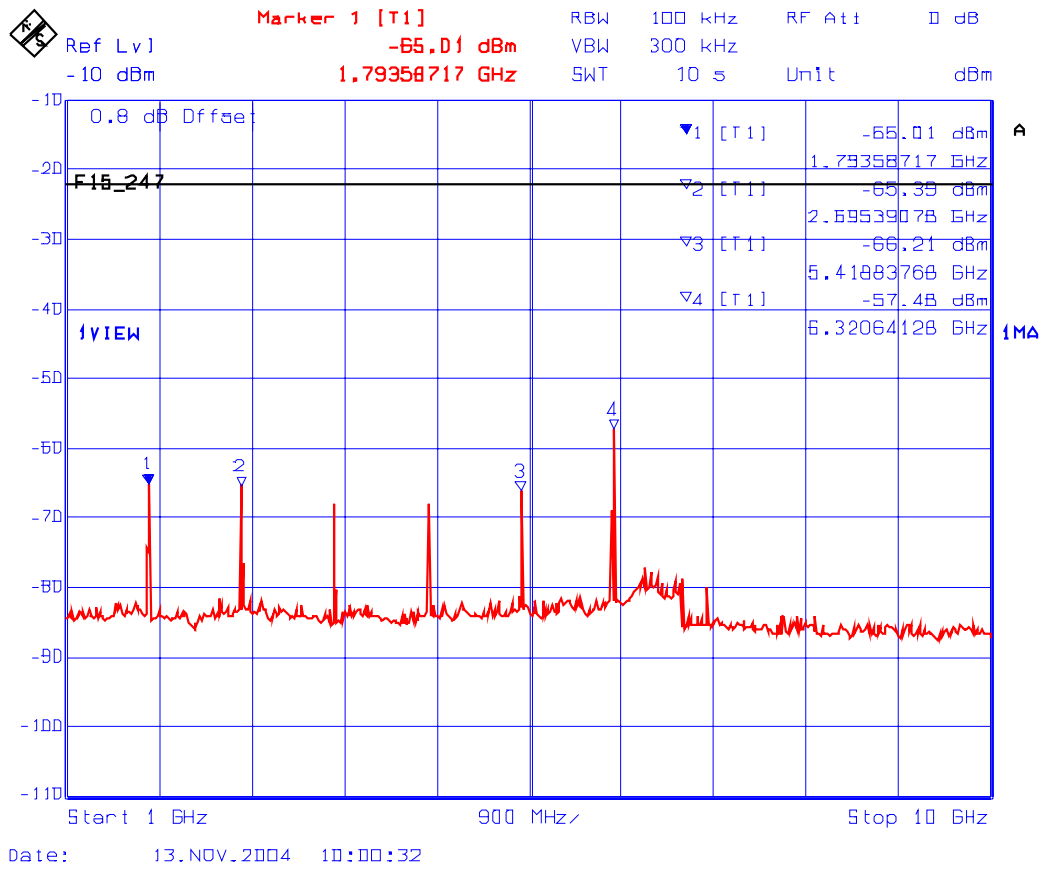

6.10.5.2.2. Middle Frequency (915.0 MHz)

The emissions were scanned from 10 MHz to 10 GHz; refer to the following test data plots 28 to 31 for measurement results.

Plot 28:  
Spurious RF Conducted Emissions  
Transmitter Frequency: 915 MHz at 1W Output Power Setting

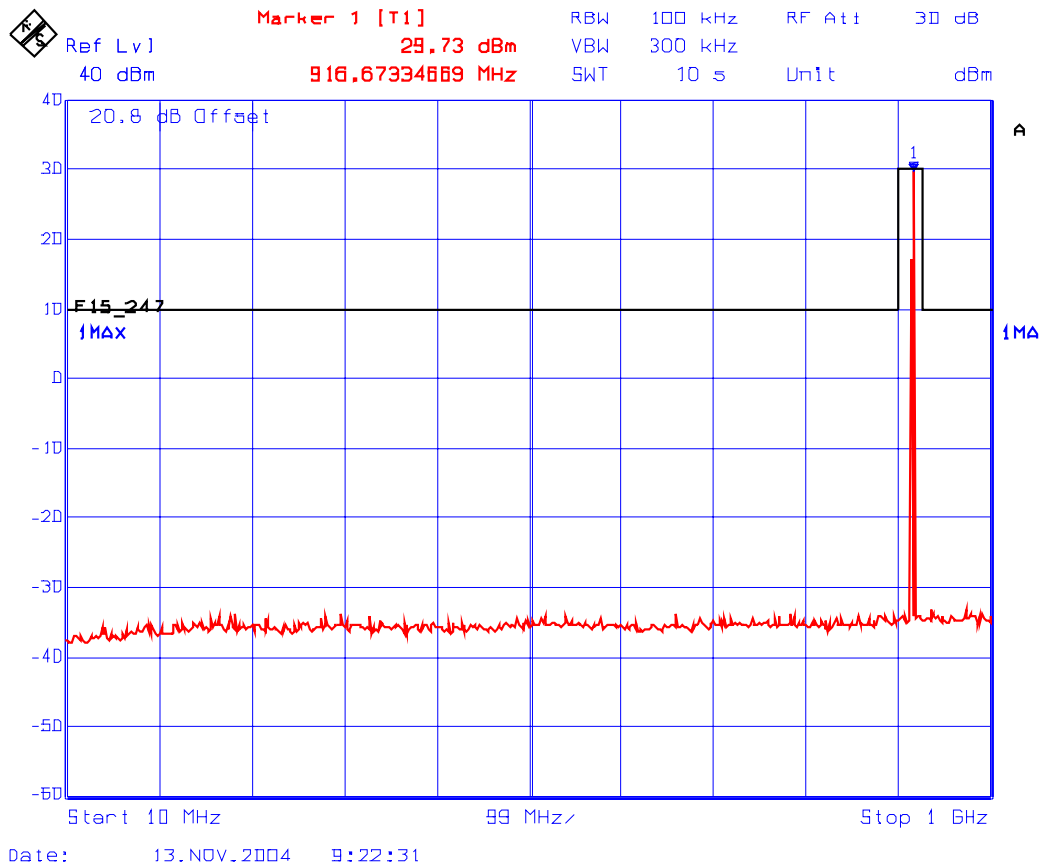

Plot 29:  
 Spurious RF Conducted Emissions  
 Transmitter Frequency: 915 MHz at 1W Output Power Setting

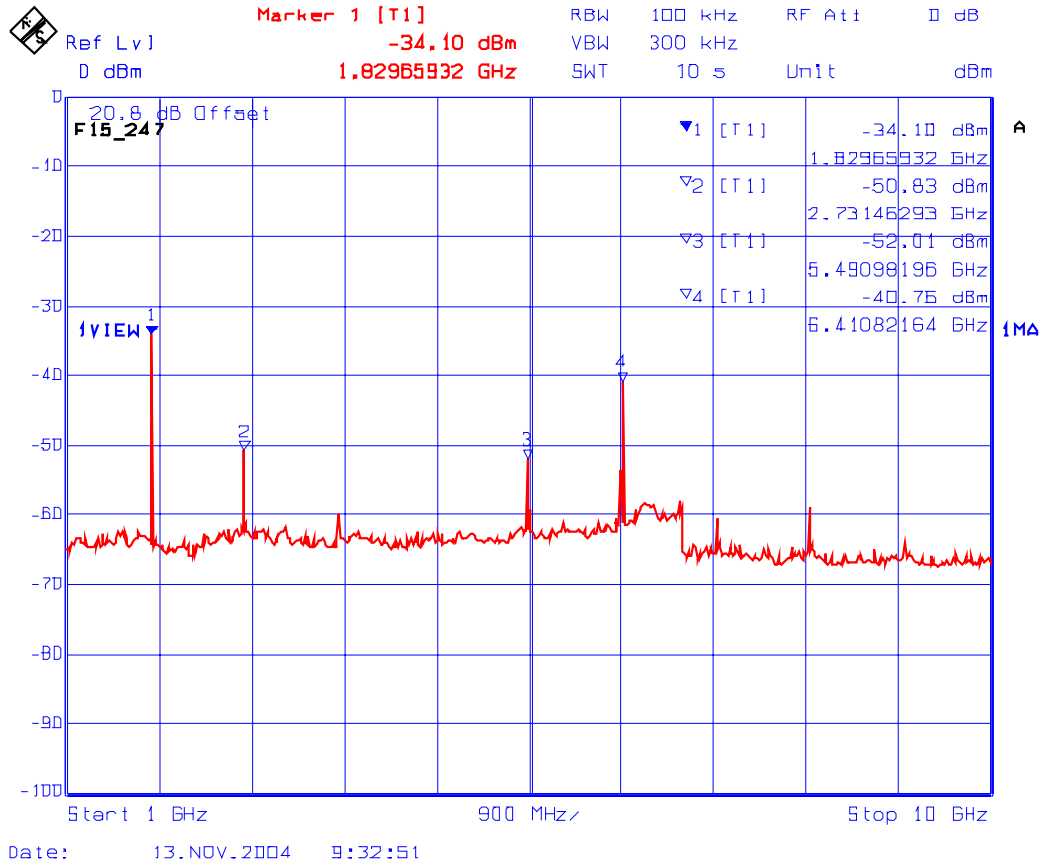

Plot 30:  
Spurious RF Conducted Emissions  
Transmitter Frequency: 915 MHz at 1mW Output Power Setting

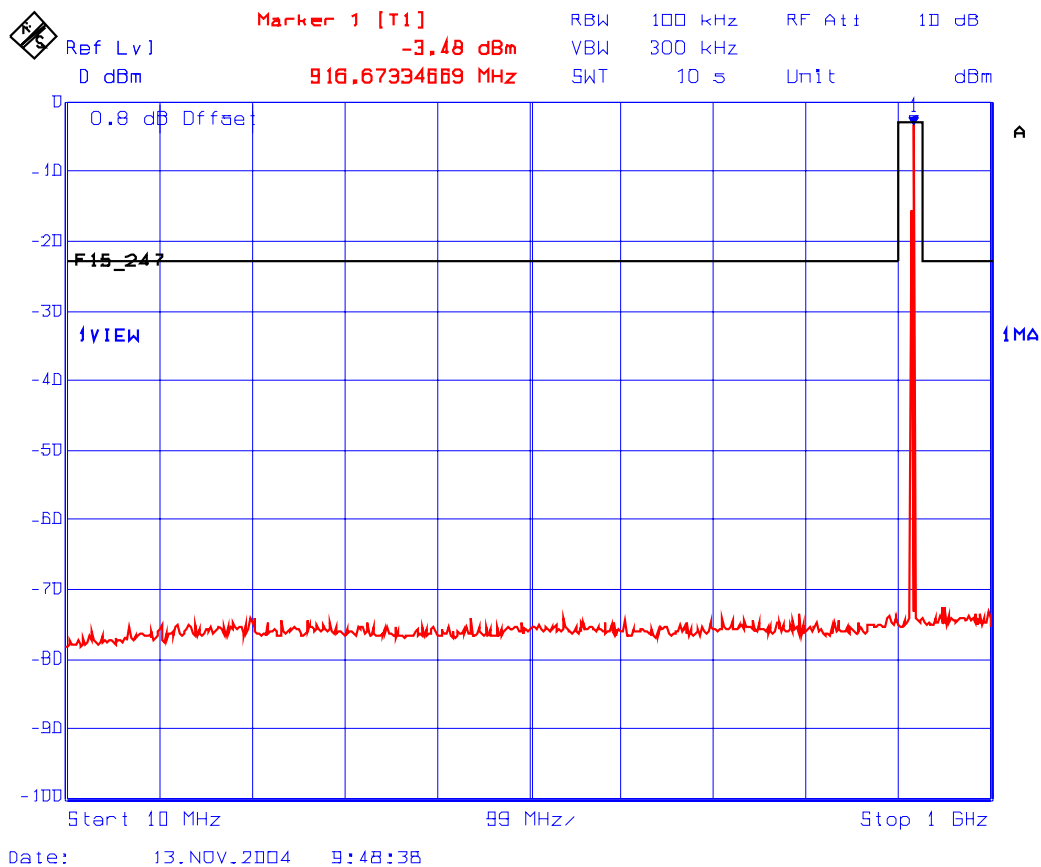

Plot 31:  
 Spurious RF Conducted Emissions  
 Transmitter Frequency: 915 MHz at 1mW Output Power Setting

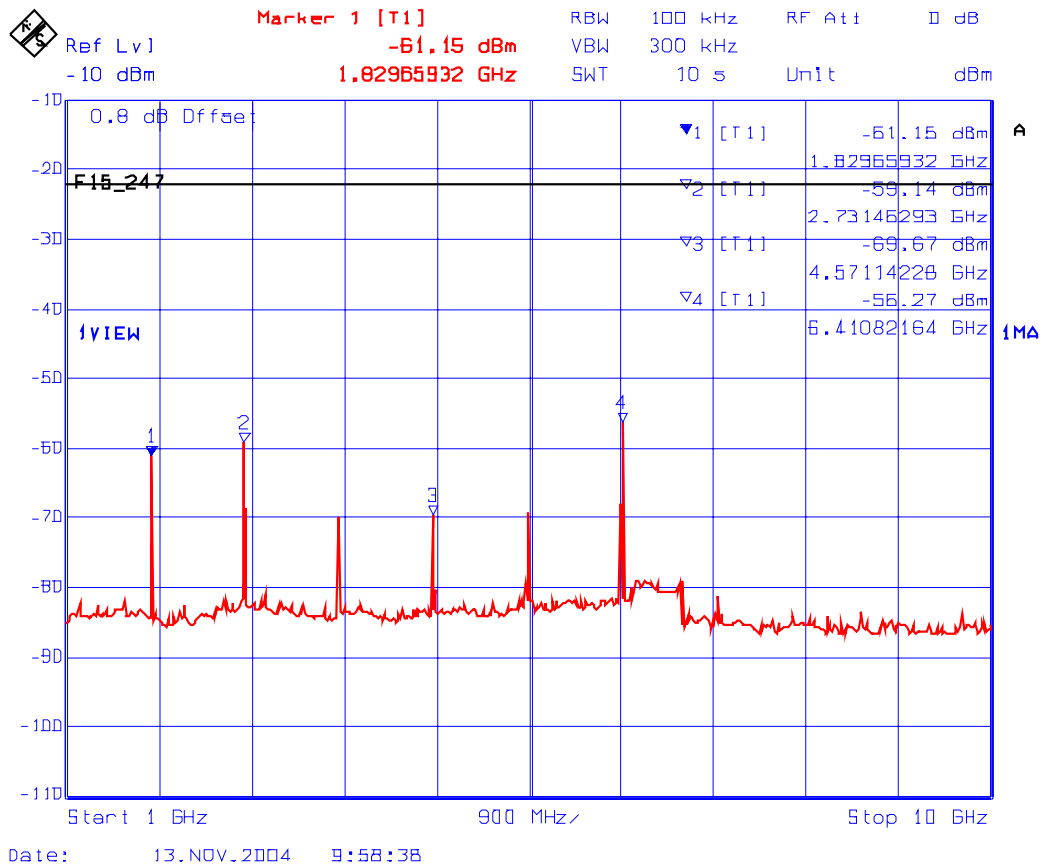

6.10.5.2.3. Highest Frequency (927.6 MHz)

The emissions were scanned from 10 MHz to 10 GHz; refer to the following test data plots 32 to 35 for measurement results.

Plot 32:  
Spurious RF Conducted Emissions  
Transmitter Frequency: 927.6 MHz at 1W Output Power Setting

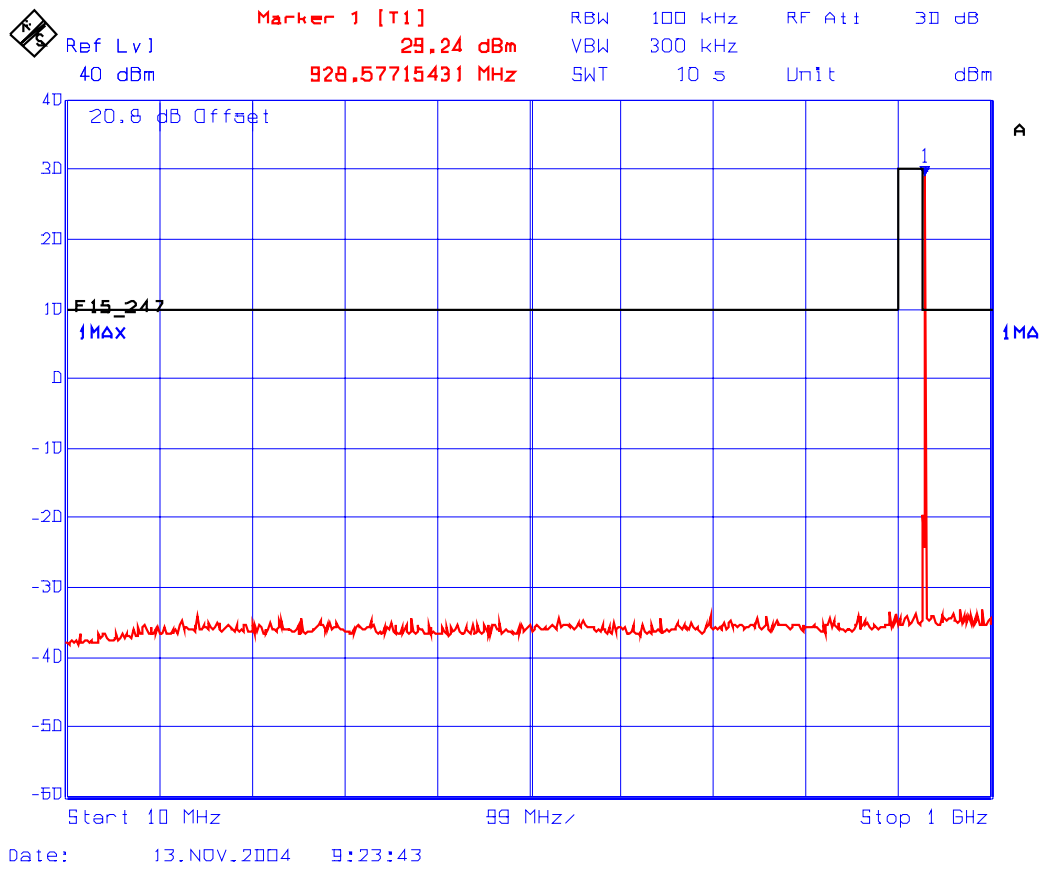

Plot 33:  
 Spurious RF Conducted Emissions  
 Transmitter Frequency: 927.6 MHz at 1W Output Power Setting

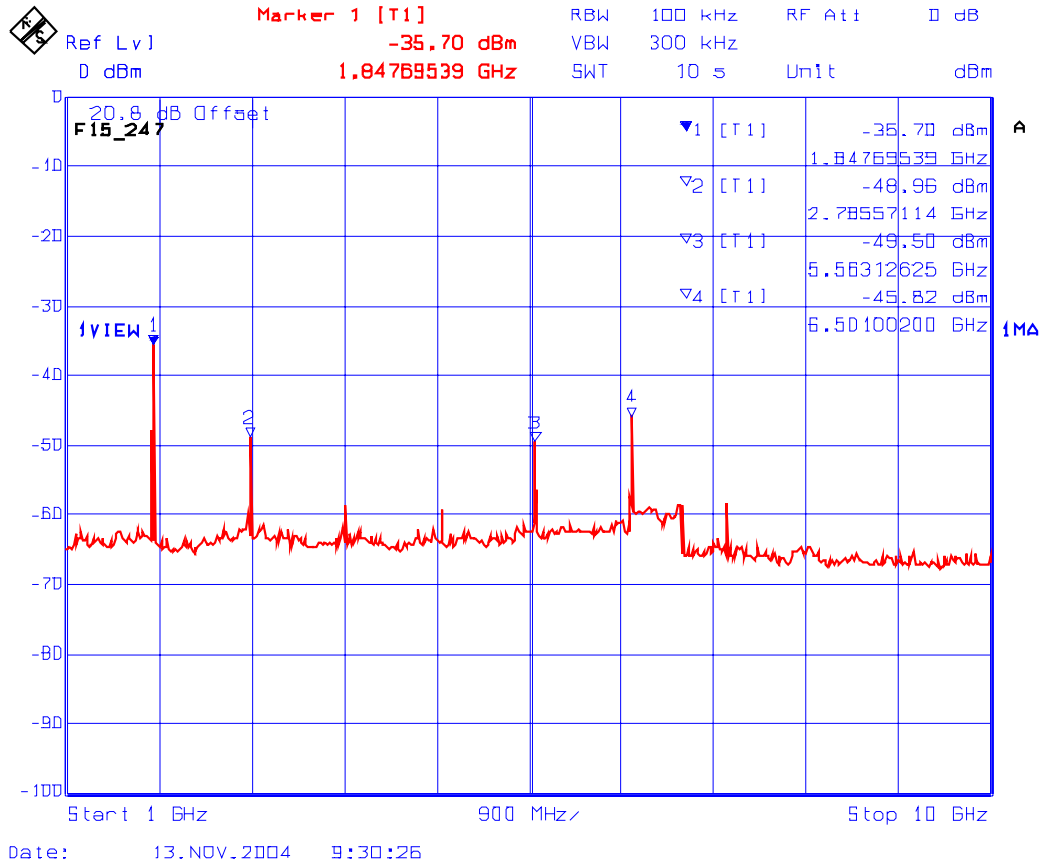



Plot 34:  
Spurious RF Conducted Emissions  
Transmitter Frequency: 927.6 MHz at 1mW Output Power Setting

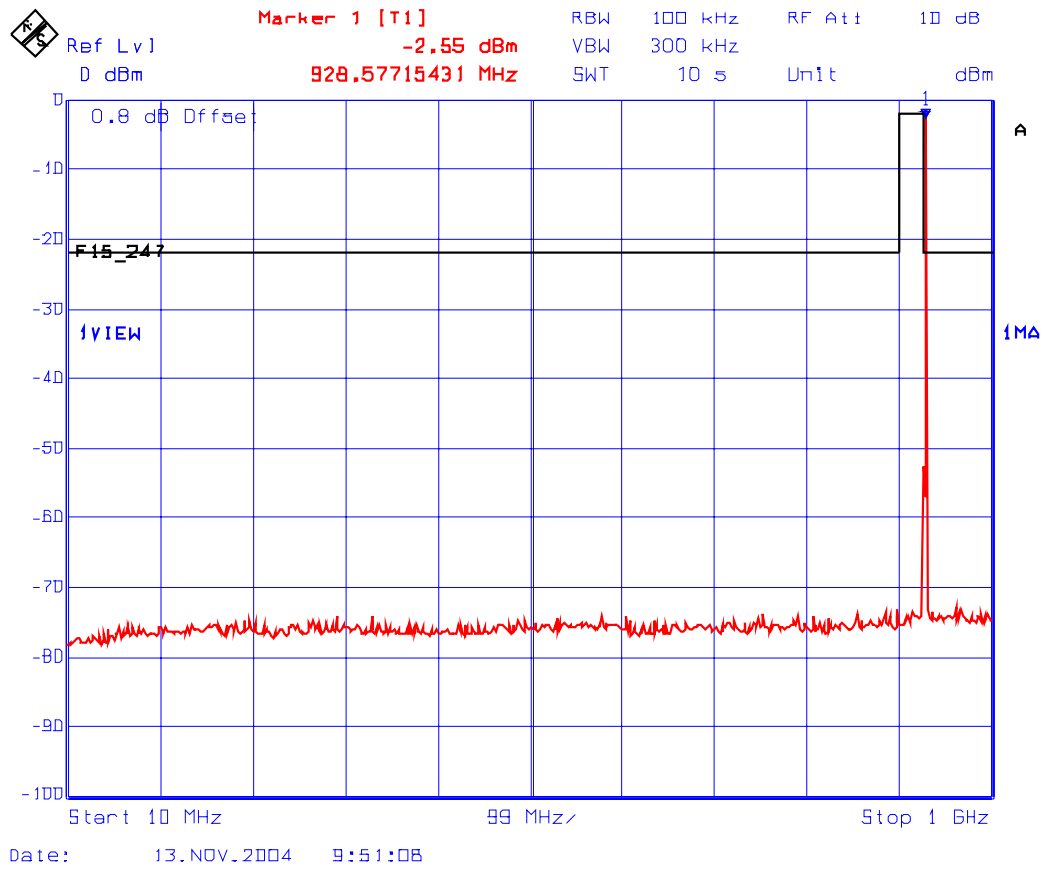

**ULTRATECH GROUP OF LABS**

3000 Bristol Circle, Oakville, Ontario, Canada L6H 6G4  
Tel. #: 905-829-1570, Fax. #: 905-829-8050, Email: [vic@ultratech-labs.com](mailto:vic@ultratech-labs.com), Website: <http://www.ultratech-labs.com>

File #: MCRS-004F15C247

November 23, 2004

All test results contained in this engineering test report are traceable to National Institute of Standards and Technology (NIST)

Plot 35:  
 Spurious RF Conducted Emissions  
 Transmitter Frequency: 927.6 MHz at 1mW Output Power Setting

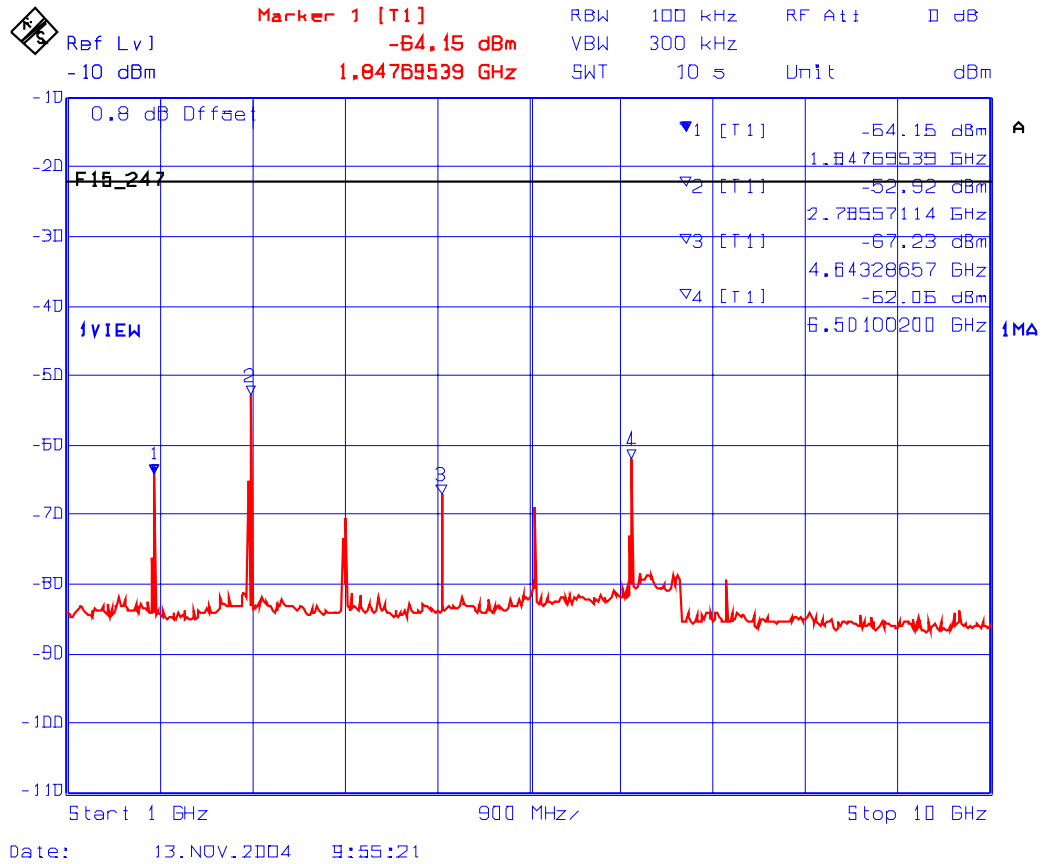

## 6.11. TRANSMITTER SPURIOUS RADIATED EMISSIONS AT 3 METERS [§§ 15.247(c), 15.209 & 15.205]

### 6.11.1. Limits

In any 100 KHz bandwidth outside the operating frequency band, the radio frequency power that is produced by modulation products of the spreading sequence, the information sequence and the carrier frequency shall be either at least 20 dB below that in any 100 KHz bandwidth within the band that contains the highest level of the desired power or shall not exceed the general levels specified in section 15.209(a), which lesser attenuation.

All other emissions inside restricted bands specified in section 15.205(a) shall not exceed the general radiated emission limits specified in section 15.209(a)

#### Remarks:

- Applies to harmonics/spurious emissions that fall in the restricted bands listed in section 15.205. The maximum permitted average field strength is listed in section 15.209.
- **47 CFR § 15.237(c):** The emission limits as specified above are based on measurement instrument employing an average detector. The provisions in section 15.35 for limiting peak emissions apply.

#### FCC CFR 47, Part 15, Subpart C, Para. 15.205(a) - Restricted Frequency Bands

MHz	MHz	MHz	GHz
0.090–0.110 .....	16.42–16.423	399.9–410	4.5–5.15
<sup>1</sup> 0.495–0.505 .....	16.69475–16.69525	608–614	5.35–5.46
2.1735–2.1905 .....	16.80425–16.80475	960–1240	7.25–7.75
4.125–4.128 .....	25.5–25.67	1300–1427	8.025–8.5
4.17725–4.17775 .....	37.5–38.25	1435–1626.5	9.0–9.2
4.20725–4.20775 .....	73–74.6	1645.5–1646.5	9.3–9.5
6.215–6.218 .....	74.8–75.2	1660–1710	10.6–12.7
6.26775–6.26825 .....	108–121.94	1718.8–1722.2	13.25–13.4
6.31175–6.31225 .....	123–138	2200–2300	14.47–14.5
8.291–8.294 .....	149.9–150.05	2310–2390	15.35–16.2
8.362–8.366 .....	156.52475–156.52525	2483.5–2500	17.7–21.4
8.37625–8.38675 .....	156.7–156.9	2655–2900	22.01–23.12
8.41425–8.41475 .....	162.0125–167.17	3260–3267	23.6–24.0
12.29–12.293 .....	167.72–173.2	3332–3339	31.2–31.8
12.51975–12.52025 .....	240–285	3345.8–3358	36.43–36.5
12.57675–12.57725 .....	322–335.4	3600–4400	( <sup>2</sup> )
13.36–13.41 .....			

<sup>1</sup> Until February 1, 1999, this restricted band shall be 0.490–0.510 MHz.

<sup>2</sup> Above 38.6

#### 47 CFR § 15.209(a)

#### -- Field Strength Limits within Restricted Frequency Bands --

Frequency (MHz)	Field Strength (microvolts/meter)	Measurement Distance (meters)
0.009 - 0.490	2,400 / F (kHz)	300
0.490 - 1.705	24,000 / F (kHz)	30
1.705 - 30.0	30	30
30 - 88	100	3
88 - 216	150	3
216 - 960	200	3
Above 960	500	3

**6.11.2. Method of Measurements**

Refer to Exhibit 8, Section 8.4 of this test report and ANSI 63.4 for detailed radiated emissions measurement procedures.

The following measurement procedures were also applied:

- Applies to harmonics/spurious that fall in the restricted bands listed in Section 15.205. the maximum permitted average field strength is listed in Section 15.209. A Pre-Amp and highpass filter are used for this measurement.
- For measurement below 1 GHz, set RBW = 100 KHz, VBW  $\geq$  100 KHz, SWEEP=AUTO.
- For measurement above 1 GHz, set RBW = 1 MHz, VBW = 1 MHz (Peak) & VBW = 10 Hz (Average), SWEEP=AUTO.
- If the emission is pulsed, modified the unit for continuous operation, then use the settings above for measurements, then correct the reading by subtracting the peak-average correction factor derived from the appropriate duty cycle calculation. See Section 15.35(b) and (c).

**6.11.3. Test Arrangement**

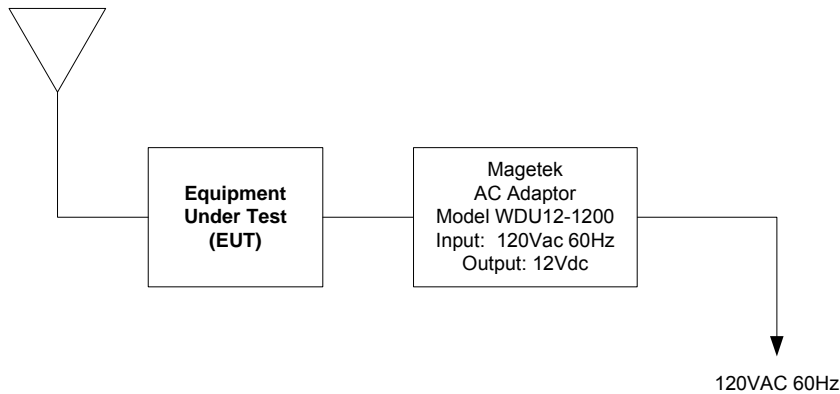

**6.11.4. Test Equipment List**

Test Instruments	Manufacturer	Model No.	Serial No.	Frequency Range
Spectrum Analyzer	Rhode & Schwarz	FSEK20/B4/B21	834157/005	9kHz – 40GHz
Microwave Amplifier	Hewlett Packard	8449B	3008A00769	1 GHz to 26.5 GHz
Biconilog Antenna	EMCO	3143	1029	20 MHz to 2 GHz
Horn Antenna	EMCO	3155	9701-5061	1 GHz – 18 GHz

**6.11.5. Test Data**

The following test results are the worst-case measurements.

**6.11.5.1. EUT with Quarter Wave Antenna, 1.5 dBi Gain, 1 Watt Power Level**

Fundamental Frequency: 902.4 MHz  
 Modulation: FHSS  
 Frequency Test Range: 10 MHz – 10 GHz

Frequency (MHz)	RF Peak Level (dBµV/m)	RF Avg Level (dBµV/m)	Antenna Plane (H/V)	Limit 15.209 (dBµV/m)	Limit 15.247 (dBµV/m)	Margin (dB)	Pass/Fail
902.4	124.36	--	V	--	--	--	--
902.4	125.92	--	H	--	--	--	--
2707.2	46.93	40.11	V	54.0	105.9	-13.9	Pass*
2707.2	47.46	41.42	H	54.0	105.9	-12.6	Pass*
3609.6	51.30	44.71	V	54.0	105.9	-9.3	Pass*
3609.6	48.68	41.51	H	54.0	105.9	-12.5	Pass*
4512.0	49.52	38.03	V	54.0	105.9	-16.0	Pass*
4512.0	49.45	39.31	H	54.0	105.9	-14.7	Pass*
5414.4	50.44	39.06	V	54.0	105.9	-14.9	Pass*
5414.4	49.15	39.00	H	54.0	105.9	-15.0	Pass*
8121.6	54.43	41.95	V	54.0	105.9	-12.1	Pass*
8121.6	53.52	40.51	H	54.0	105.9	-13.5	Pass*
9024.0	55.33	46.79	V	54.0	105.9	-7.2	Pass*
9024.0	55.39	46.80	H	54.0	105.9	-7.2	Pass*

All other spurious emissions and harmonics are more than 20 dB below the applicable limit. See test data plots (36 to 37) for band-edge emissions.

\* Emission within the restricted frequency bands.

Plot 36:  
 Band-Edge RF Radiated Emissions @ 3 meters  
 Low End of Frequency Band  
 Test Configuration 1: EUT with ¼ Wave Antenna (1.5 dBi Gain)  
 Rx Antenna Orientation: Vertical

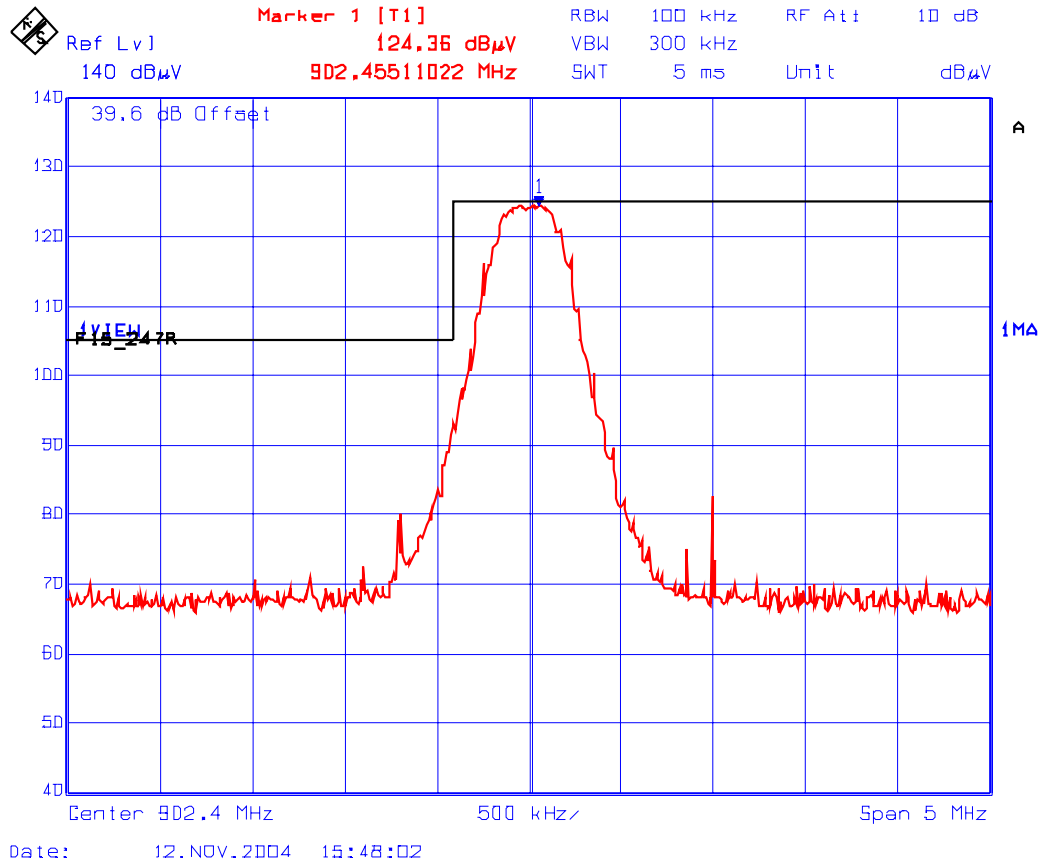

Plot 37:  
 Band-Edge RF Radiated Emissions @ 3 meters  
 Low End of Frequency Band  
 Test Configuration 1: EUT with 1/4 Wave Antenna (1.5 dBi Gain)  
 Rx Antenna Orientation: Horizontal

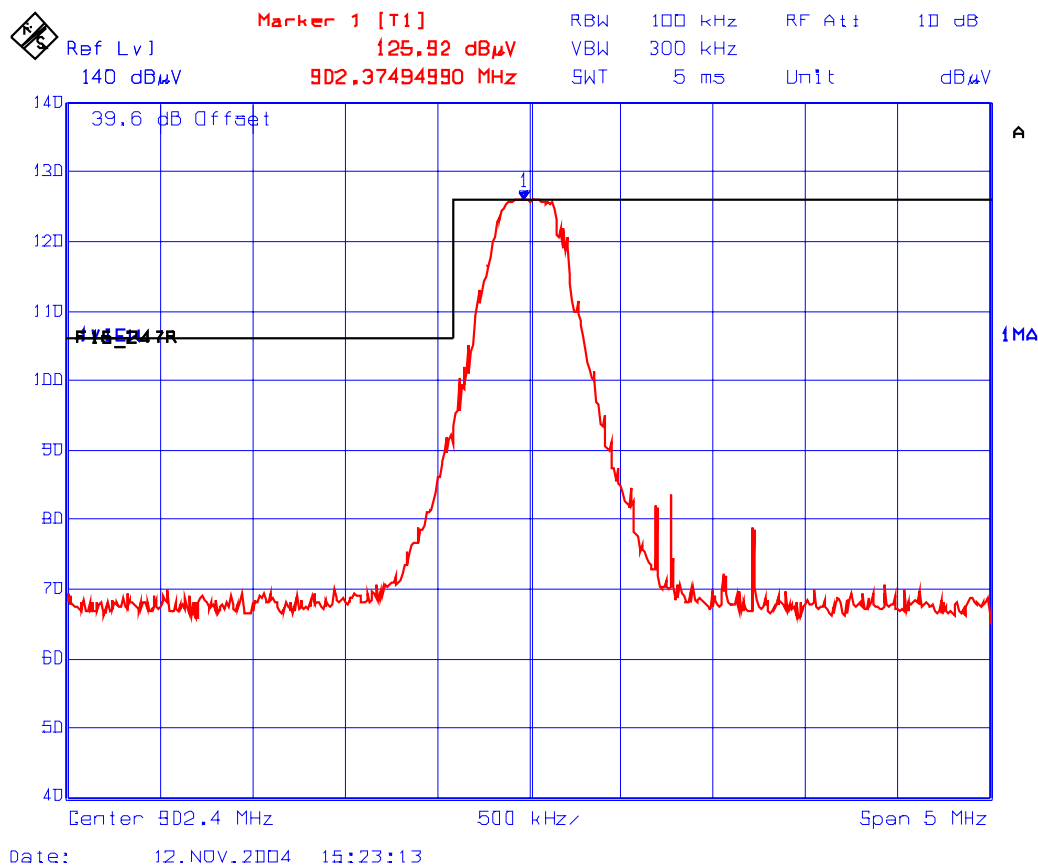

Fundamental Frequency: 915.0 MHz  
 Modulation: FHSS  
 Frequency Test Range: 10 MHz – 10 GHz

Frequency (MHz)	RF Peak Level (dBµV/m)	RF Avg Level (dBµV/m)	Antenna Plane (H/V)	Limit 15.209 (dBµV/m)	Limit 15.247 (dBµV/m)	Margin (dB)	Pass/Fail
915.0	121.43	--	V	--	--	--	--
915.0	127.32	--	H	--	--	--	--
2745.0	46.96	39.57	V	54.0	107.3	-14.4	Pass*
2745.0	47.84	40.92	H	54.0	107.3	-13.1	Pass*
3660.0	49.99	41.97	V	54.0	107.3	-12.0	Pass*
3660.0	49.98	42.84	H	54.0	107.3	-11.2	Pass*
4575.0	48.36	37.01	V	54.0	107.3	-17.0	Pass*
4575.0	49.11	37.25	H	54.0	107.3	-16.8	Pass*
7320.0	54.19	44.73	V	54.0	107.3	-9.3	Pass*
7320.0	53.84	45.33	H	54.0	107.3	-8.7	Pass*
8235.0	56.83	50.60	V	54.0	107.3	-3.4	Pass*
8235.0	56.66	49.04	H	54.0	107.3	-5.0	Pass*
9150.0	57.30	50.41	V	54.0	107.3	-3.6	Pass*
9150.0	58.23	50.74	H	54.0	107.3	-3.3	Pass*

All other spurious emissions and harmonics are more than 20 dB below the applicable limit.

\* Emission within the restricted frequency bands.



Fundamental Frequency: 927.6 MHz  
 Modulation: FHSS  
 Frequency Test Range: 10 MHz – 10 GHz

Frequency (MHz)	RF Peak Level (dBµV/m)	RF Avg Level (dBµV/m)	Antenna Plane (H/V)	Limit 15.209 (dBµV/m)	Limit 15.247 (dBµV/m)	Margin (dB)	Pass/Fail
927.6	126.60	--	V	--	--	--	--
927.6	126.70	--	H	--	--	--	--
2782.8	46.76	39.20	V	54.0	106.7	-14.8	Pass*
2782.8	51.84	48.79	H	54.0	106.7	-5.2	Pass*
3710.4	50.45	43.91	V	54.0	106.7	-10.1	Pass*
3710.4	50.88	41.77	H	54.0	106.7	-12.2	Pass*
4638.0	49.29	41.50	V	54.0	106.7	-12.5	Pass*
4638.0	49.77	41.54	H	54.0	106.7	-12.5	Pass*
7420.8	54.78	45.38	V	54.0	106.7	-8.6	Pass*
7420.8	55.55	46.97	H	54.0	106.7	-7.0	Pass*
8348.4	55.96	42.31	V	54.0	106.7	-11.7	Pass*
8348.4	56.80	47.96	H	54.0	106.7	-6.0	Pass*

All other spurious emissions and harmonics are more than 20 dB below the applicable limit. See test data plots (38 to 39) for band-edge emissions.

\* Emission within the restricted frequency bands.

Plot 38:  
Band-Edge RF Radiated Emissions @ 3 meters  
Upper End of Frequency Band  
Test Configuration 1: EUT with 1/4 Wave Antenna (1.5 dBi Gain)  
Rx Antenna Orientation: Vertical

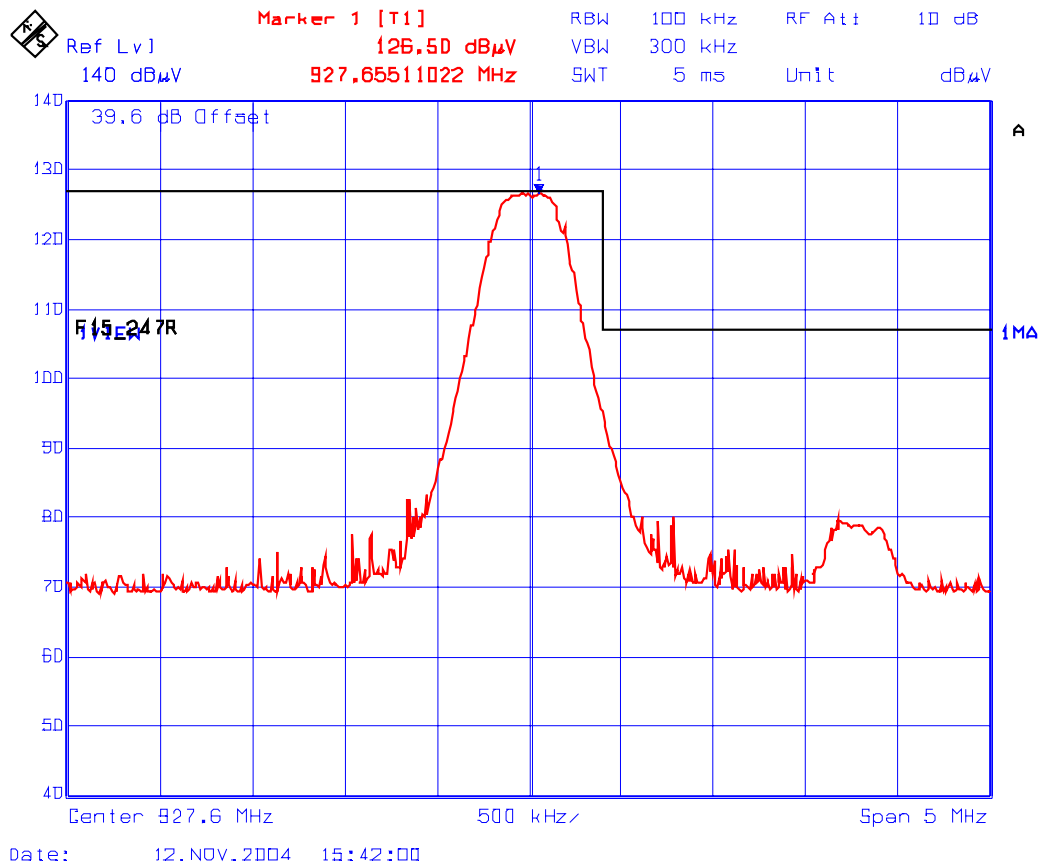

Plot 39:  
 Band-Edge RF Radiated Emissions @ 3 meters  
 Upper End of Frequency Band  
 Test Configuration 1: EUT with 1/4 Wave Antenna (1.5 dBi Gain)  
 Rx Antenna Orientation: Horizontal

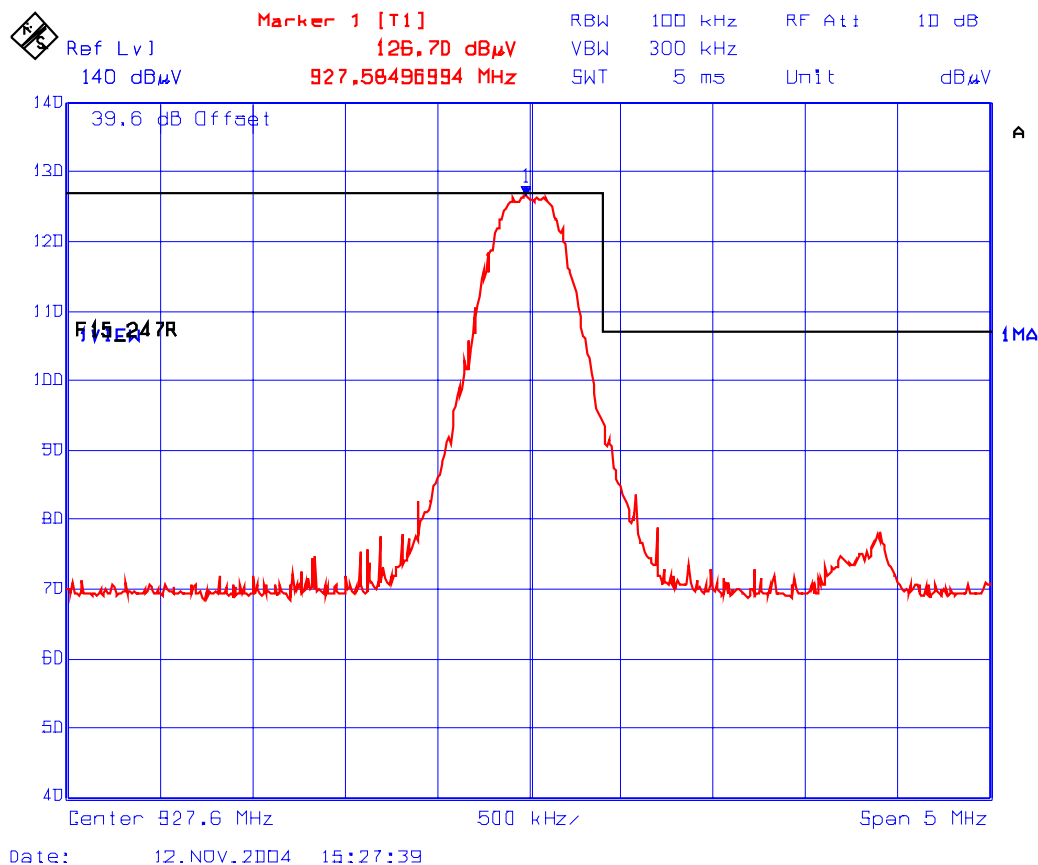

**6.11.5.2. EUT with Rubber Ducky Antenna, 2 dBi Gain, 1 Watt Power Level**

Fundamental Frequency: 902.4 MHz  
 Modulation: FHSS  
 Frequency Test Range: 10 MHz – 10 GHz

Frequency (MHz)	RF Peak Level (dBµV/m)	RF Avg Level (dBµV/m)	Antenna Plane (H/V)	Limit 15.209 (dBµV/m)	Limit 15.247 (dBµV/m)	Margin (dB)	Pass/Fail
902.4	132.33	--	V	--	--	--	--
902.4	132.28	--	H	--	--	--	--
2707.2	47.50	39.91	V	54.0	112.3	-14.1	Pass*
2707.2	48.58	43.73	H	54.0	112.3	-10.3	Pass*
3609.6	50.45	42.72	V	54.0	112.3	-11.3	Pass*
3609.6	49.66	42.75	H	54.0	112.3	-11.3	Pass*
4512.0	51.39	42.89	V	54.0	112.3	-11.1	Pass*
4512.0	50.69	44.05	H	54.0	112.3	-10.0	Pass*
5414.4	55.21	49.38	V	54.0	112.3	-4.6	Pass*
5414.4	54.84	48.72	H	54.0	112.3	-5.3	Pass*
8121.6	55.30	44.06	V	54.0	112.3	-9.9	Pass*
8121.6	54.70	41.16	H	54.0	112.3	-12.8	Pass*
9024.0	55.75	44.48	V	54.0	112.3	-9.5	Pass*
9024.0	55.60	42.11	H	54.0	112.3	-11.9	Pass*

All other spurious emissions and harmonics are more than 20 dB below the applicable limit. See test data plots (40 to 41) for band-edge emissions.

\* Emission within the restricted frequency bands.

Plot 40:  
 Band-Edge RF Radiated Emissions @ 3 meters  
 Low End of Frequency Band  
 Test Configuration 2: EUT with Rubber Duck Antenna (2 dBi Gain)  
 Rx Antenna Orientation: Vertical

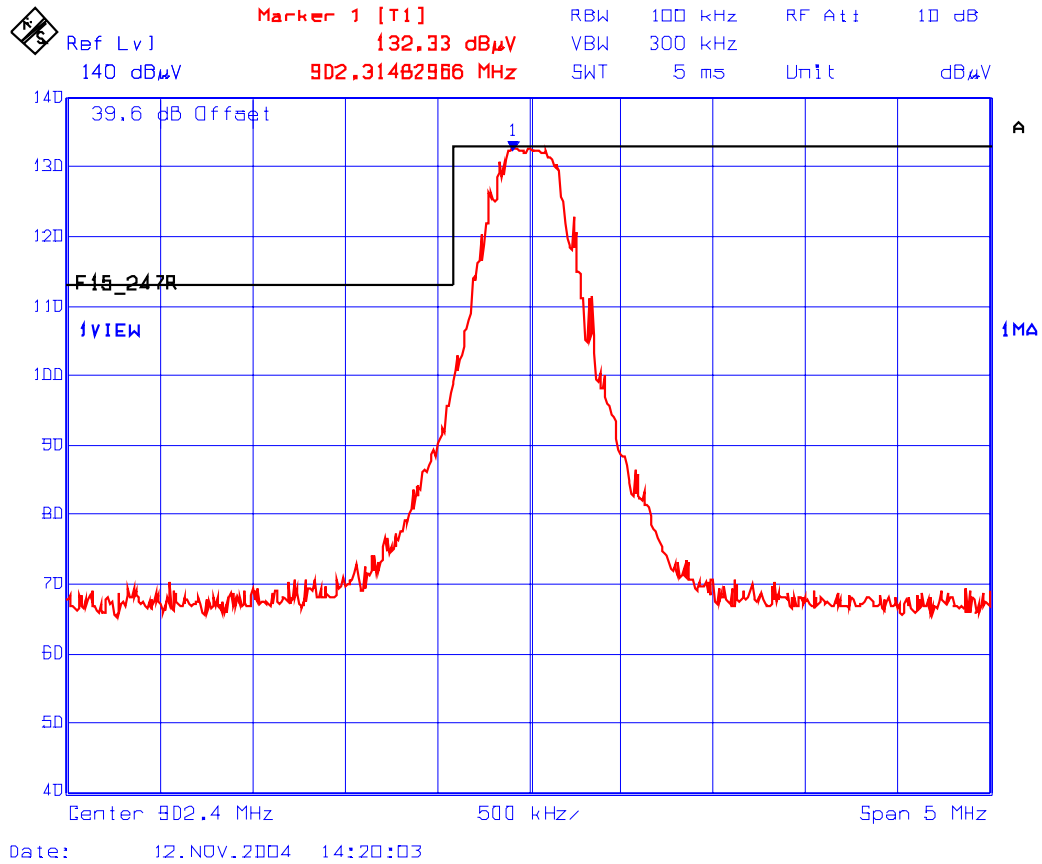

Plot 41:  
Band-Edge RF Radiated Emissions @ 3 meters  
Low End of Frequency Band  
Test Configuration 2: EUT with Rubber Duck Antenna (2 dBi Gain)  
Rx Antenna Orientation: Horizontal

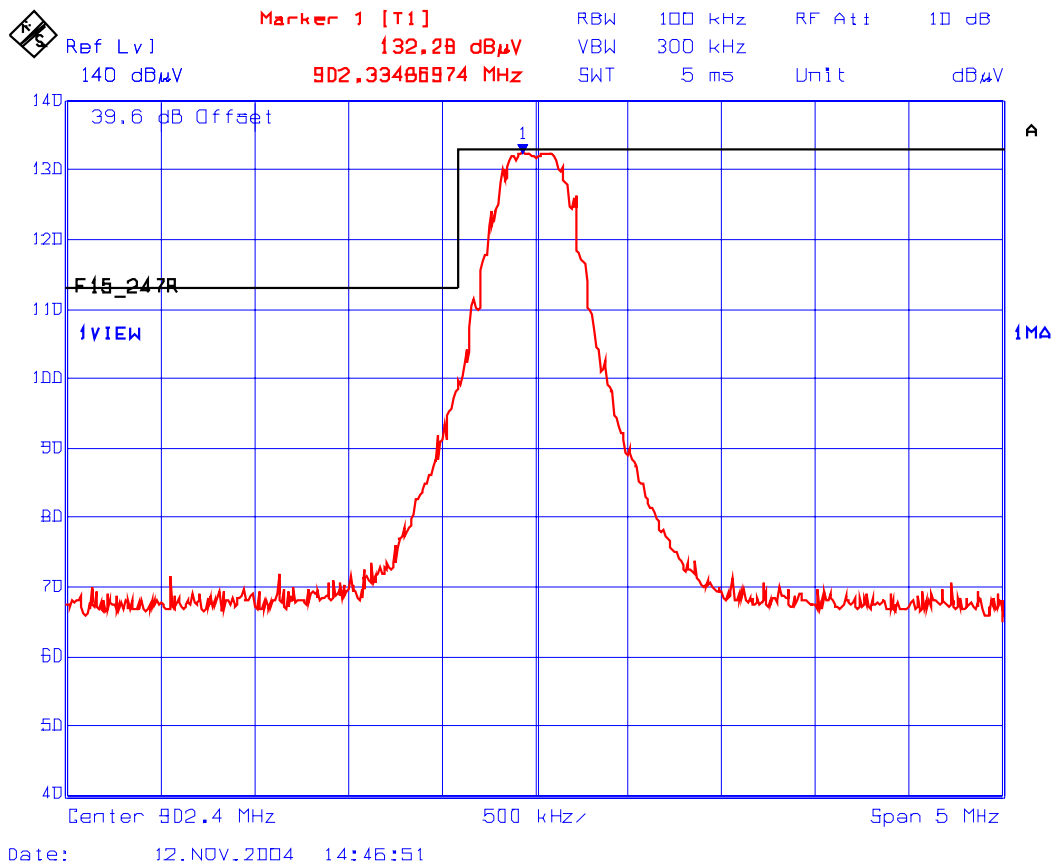

Fundamental Frequency: 915.0 MHz  
 Modulation: FHSS  
 Frequency Test Range: 10 MHz – 10 GHz

Frequency (MHz)	RF Peak Level (dBµV/m)	RF Avg Level (dBµV/m)	Antenna Plane (H/V)	Limit 15.209 (dBµV/m)	Limit 15.247 (dBµV/m)	Margin (dB)	Pass/Fail
915.0	130.89	--	V	--	--	--	--
915.0	130.83	--	H	--	--	--	--
2745.0	48.17	39.91	V	54.0	110.9	-14.1	Pass*
2745.0	49.07	43.26	H	54.0	110.9	-10.7	Pass*
3660.0	49.12	38.96	V	54.0	110.9	-15.0	Pass*
3660.0	50.67	41.57	H	54.0	110.9	-12.4	Pass*
4575.0	50.47	43.06	V	54.0	110.9	-10.9	Pass*
4575.0	51.01	44.84	H	54.0	110.9	-9.2	Pass*
7320.0	53.42	42.90	V	54.0	110.9	-11.1	Pass*
7320.0	52.05	40.13	H	54.0	110.9	-13.9	Pass*
8235.0	54.56	43.79	V	54.0	110.9	-10.2	Pass*
8235.0	53.90	42.41	H	54.0	110.9	-11.6	Pass*
9150.0	55.96	47.82	V	54.0	110.9	-6.2	Pass*
9150.0	55.88	45.54	H	54.0	110.9	-8.5	Pass*

All other spurious emissions and harmonics are more than 20 dB below the applicable limit.

\* Emission within the restricted frequency bands.

Fundamental Frequency: 927.6 MHz  
 Modulation: FHSS  
 Frequency Test Range: 10 MHz – 10 GHz

Frequency (MHz)	RF Peak Level (dBµV/m)	RF Avg Level (dBµV/m)	Antenna Plane (H/V)	Limit 15.209 (dBµV/m)	Limit 15.247 (dBµV/m)	Margin (dB)	Pass/Fail
927.6	130.30	--	V	--	--	--	--
927.6	129.39	--	H	--	--	--	--
2782.8	47.10	38.54	V	54.0	110.3	-15.5	Pass*
2782.8	49.96	45.73	H	54.0	110.3	-8.3	Pass*
3710.4	49.14	36.28	V	54.0	110.3	-17.7	Pass*
3710.4	49.47	39.21	H	54.0	110.3	-14.8	Pass*
4638.0	50.68	42.40	V	54.0	110.3	-11.6	Pass*
4638.0	52.52	47.85	H	54.0	110.3	-6.2	Pass*
7420.8	54.46	43.36	V	54.0	110.3	-10.6	Pass*
7420.8	52.96	42.73	H	54.0	110.3	-11.3	Pass*
8348.4	55.77	42.73	V	54.0	110.3	-11.3	Pass*
8348.4	55.50	44.26	H	54.0	110.3	-9.7	Pass*

All other spurious emissions and harmonics are more than 20 dB below the applicable limit. See test data plots (42 to 43) for band-edge emissions.

\* Emission within the restricted frequency bands.



Plot 42:  
Band-Edge RF Radiated Emissions @ 3 meters  
Upper End of Frequency Band  
Test Configuration 2: EUT with Rubber Duck Antenna (2 dBi Gain)  
Rx Antenna Orientation: Vertical

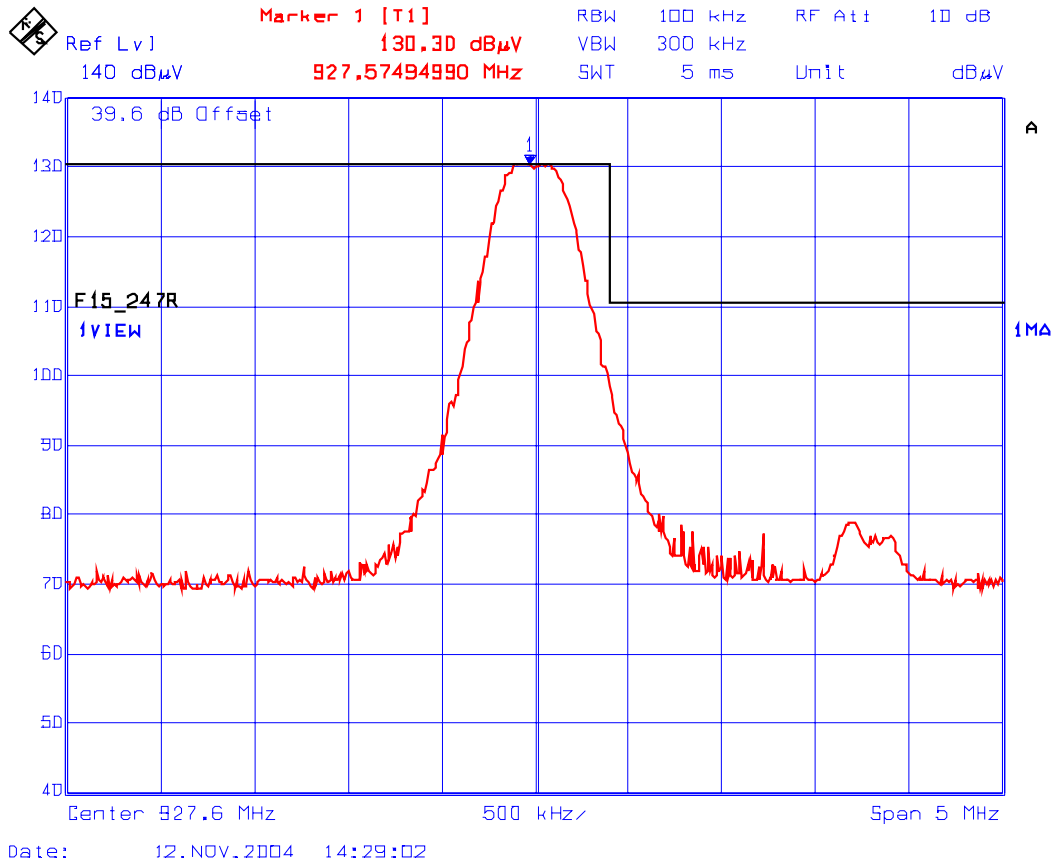

Plot 43:  
 Band-Edge RF Radiated Emissions @ 3 meters  
 Upper End of Frequency Band  
 Test Configuration 2: EUT with Rubber Duck Antenna (2 dBi Gain)  
 Rx Antenna Orientation: Horizontal

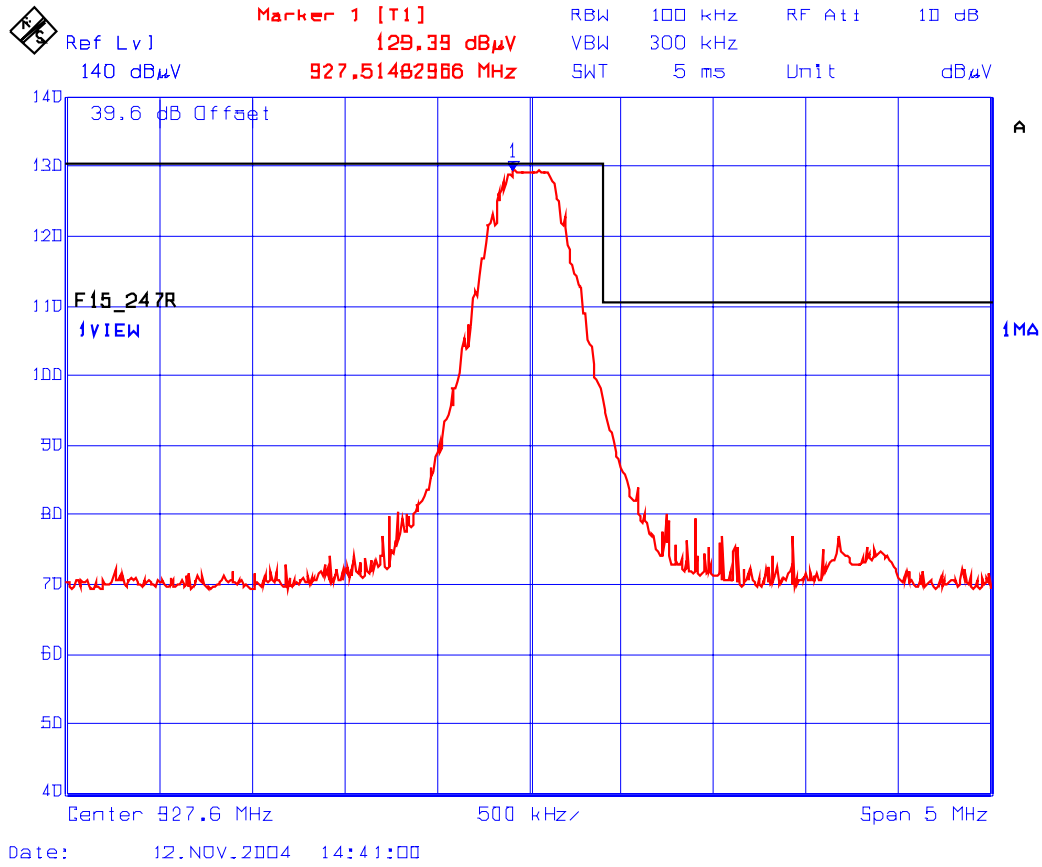

**6.11.5.3. EUT with Transit Antenna, 5.15 dBi Gain, 1 Watt Power Level**

Fundamental Frequency: 902.4 MHz  
 Modulation: FHSS  
 Frequency Test Range: 10 MHz – 10 GHz

Frequency (MHz)	RF Peak Level (dBµV/m)	RF Avg Level (dBµV/m)	Antenna Plane (H/V)	Limit 15.209 (dBµV/m)	Limit 15.247 (dBµV/m)	Margin (dB)	Pass/Fail
902.4	129.42	--	V	--	--	--	--
902.4	132.28	--	H	--	--	--	--
2707.2	46.81	39.43	V	54.0	112.3	-14.6	Pass*
2707.2	46.22	38.12	H	54.0	112.3	-15.9	Pass*
3609.6	48.47	37.92	V	54.0	112.3	-16.1	Pass*
3609.6	49.18	41.27	H	54.0	112.3	-12.7	Pass*
4512.0	48.12	39.45	V	54.0	112.3	-14.6	Pass*
4512.0	49.41	40.70	H	54.0	112.3	-13.3	Pass*
5414.4	52.50	45.88	V	54.0	112.3	-8.1	Pass*
5414.4	51.52	41.98	H	54.0	112.3	-12.0	Pass*
8121.6	56.69	48.99	V	54.0	112.3	-5.0	Pass*
8121.6	56.89	45.37	H	54.0	112.3	-8.6	Pass*
9024.0	55.27	45.67	V	54.0	112.3	-8.3	Pass*
9024.0	55.30	42.09	H	54.0	112.3	-11.9	Pass*

All other spurious emissions and harmonics are more than 20 dB below the applicable limit. See test data plots (44 to 45) for band-edge emissions.

\* Emission within the restricted frequency bands.

Plot 44:  
Band-Edge RF Radiated Emissions @ 3 meters  
Low End of Frequency Band  
Test Configuration 3: EUT with Transit Antenna (5.15 dBi Gain)  
Rx Antenna Orientation: Vertical

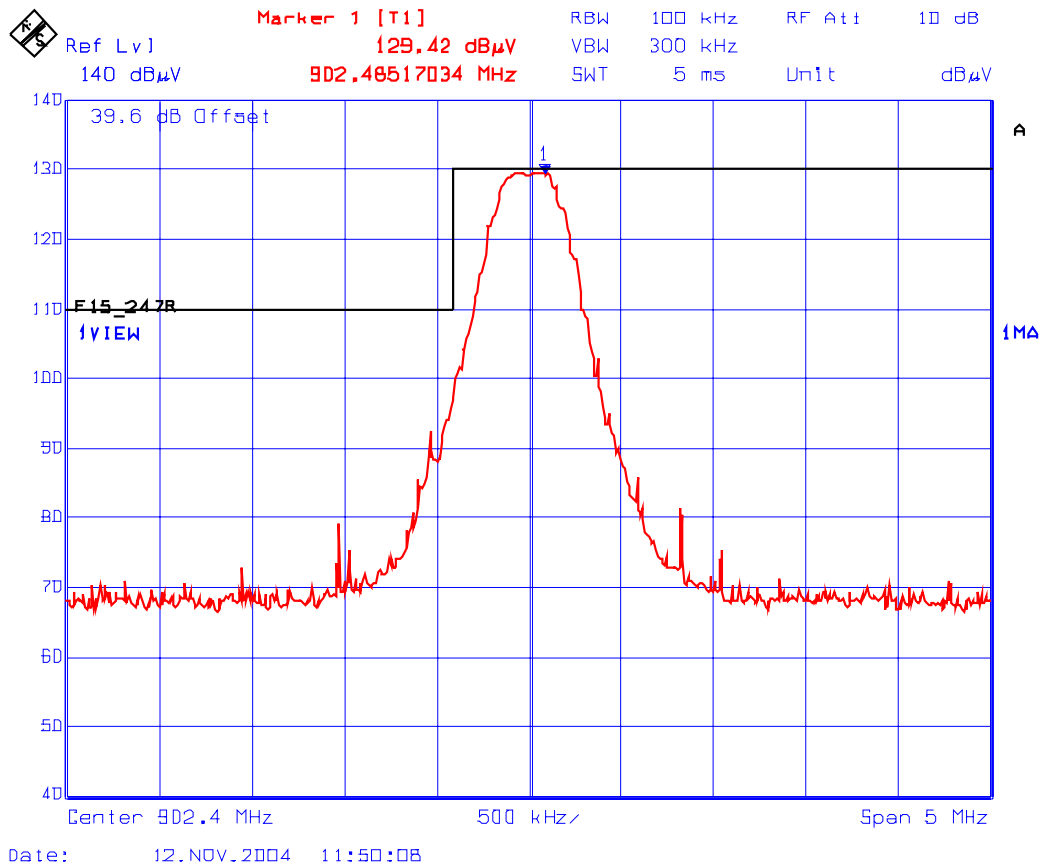

Plot 45:  
Band-Edge RF Radiated Emissions @ 3 meters  
Low End of Frequency Band  
Test Configuration 3: EUT with Transit Antenna (5.15 dBi Gain)  
Rx Antenna Orientation: Horizontal

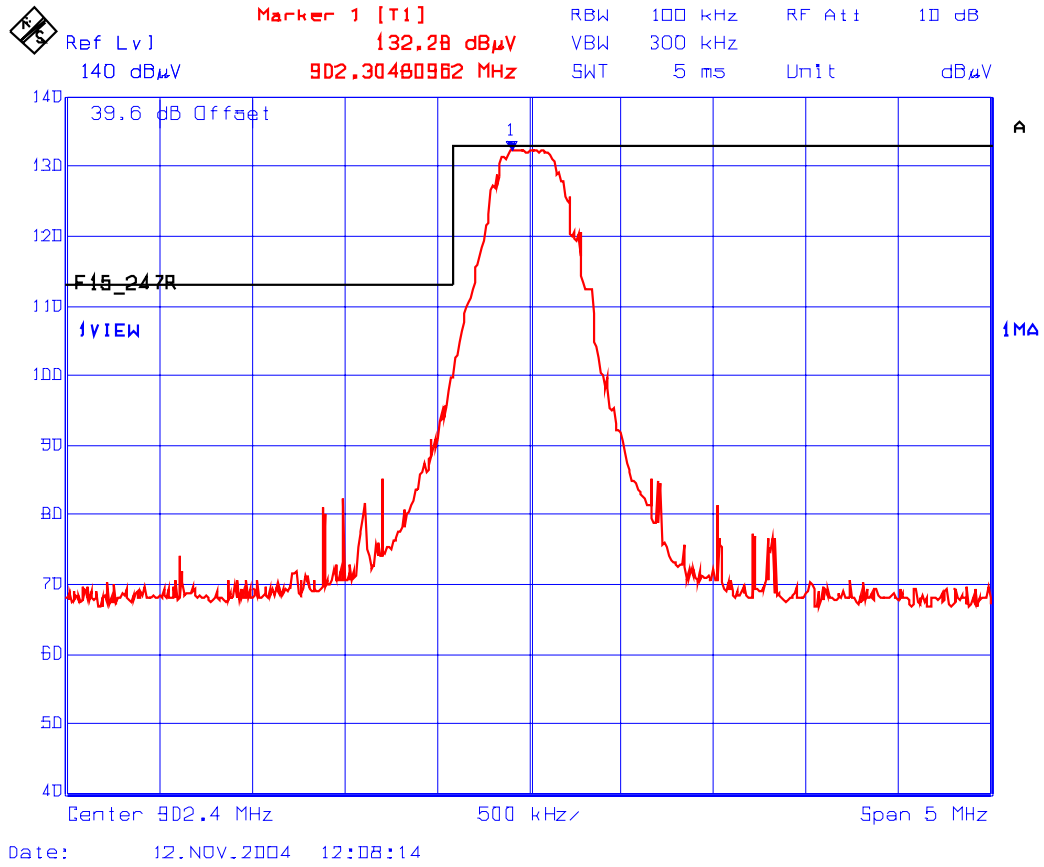

Fundamental Frequency: 915.0 MHz  
 Modulation: FHSS  
 Frequency Test Range: 10 MHz – 10 GHz

Frequency (MHz)	RF Peak Level (dBµV/m)	RF Avg Level (dBµV/m)	Antenna Plane (H/V)	Limit 15.209 (dBµV/m)	Limit 15.247 (dBµV/m)	Margin (dB)	Pass/Fail
915.0	129.66	--	V	--	--	--	--
915.0	128.84	--	H	--	--	--	--
2745.0	50.81	46.53	V	54.0	109.7	-7.5	Pass*
2745.0	51.13	47.93	H	54.0	109.7	-6.1	Pass*
3660.0	50.98	43.30	V	54.0	109.7	-10.7	Pass*
3660.0	50.48	43.74	H	54.0	109.7	-10.3	Pass*
4575.0	48.14	37.76	V	54.0	109.7	-16.2	Pass*
4575.0	49.91	42.96	H	54.0	109.7	-11.0	Pass*
7320.0	54.89	45.32	V	54.0	109.7	-8.7	Pass*
7320.0	53.78	42.41	H	54.0	109.7	-11.6	Pass*
8235.0	56.78	48.81	V	54.0	109.7	-5.2	Pass*
8235.0	56.13	48.23	H	54.0	109.7	-5.8	Pass*
9150.0	57.22	46.67	V	54.0	109.7	-7.3	Pass*
9150.0	57.53	49.28	H	54.0	109.7	-4.7	Pass*

All other spurious emissions and harmonics are more than 20 dB below the applicable limit.

\* Emission within the restricted frequency bands.

Fundamental Frequency: 927.6 MHz  
 Modulation: FHSS  
 Frequency Test Range: 10 MHz – 10 GHz

Frequency (MHz)	RF Peak Level (dBµV/m)	RF Avg Level (dBµV/m)	Antenna Plane (H/V)	Limit 15.209 (dBµV/m)	Limit 15.247 (dBµV/m)	Margin (dB)	Pass/Fail
927.6	129.19	--	V	--	--	--	--
927.6	128.71	--	H	--	--	--	--
2782.8	50.00	46.13	V	54.0	109.2	-7.9	Pass*
2782.8	51.15	47.36	H	54.0	109.2	-6.6	Pass*
3710.4	48.50	37.72	V	54.0	109.2	-16.3	Pass*
3710.4	48.56	37.86	H	54.0	109.2	-16.1	Pass*
4638.0	50.42	43.30	V	54.0	109.2	-10.7	Pass*
4638.0	50.56	42.69	H	54.0	109.2	-11.3	Pass*
7420.8	55.62	47.73	V	54.0	109.2	-6.3	Pass*
7420.8	55.10	47.40	H	54.0	109.2	-6.6	Pass*
8348.4	55.75	45.40	V	54.0	109.2	-8.6	Pass*
8348.4	55.67	44.16	H	54.0	109.2	-9.8	Pass*

All other spurious emissions and harmonics are more than 20 dB below the applicable limit. See test data plots (46 to 47) for band-edge emissions.

\* Emission within the restricted frequency bands.

Plot 46:  
Band-Edge RF Radiated Emissions @ 3 meters  
Upper End of Frequency Band  
Test Configuration 3: EUT with Transit Antenna (5.15 dBi Gain)  
Rx Antenna Orientation: Vertical

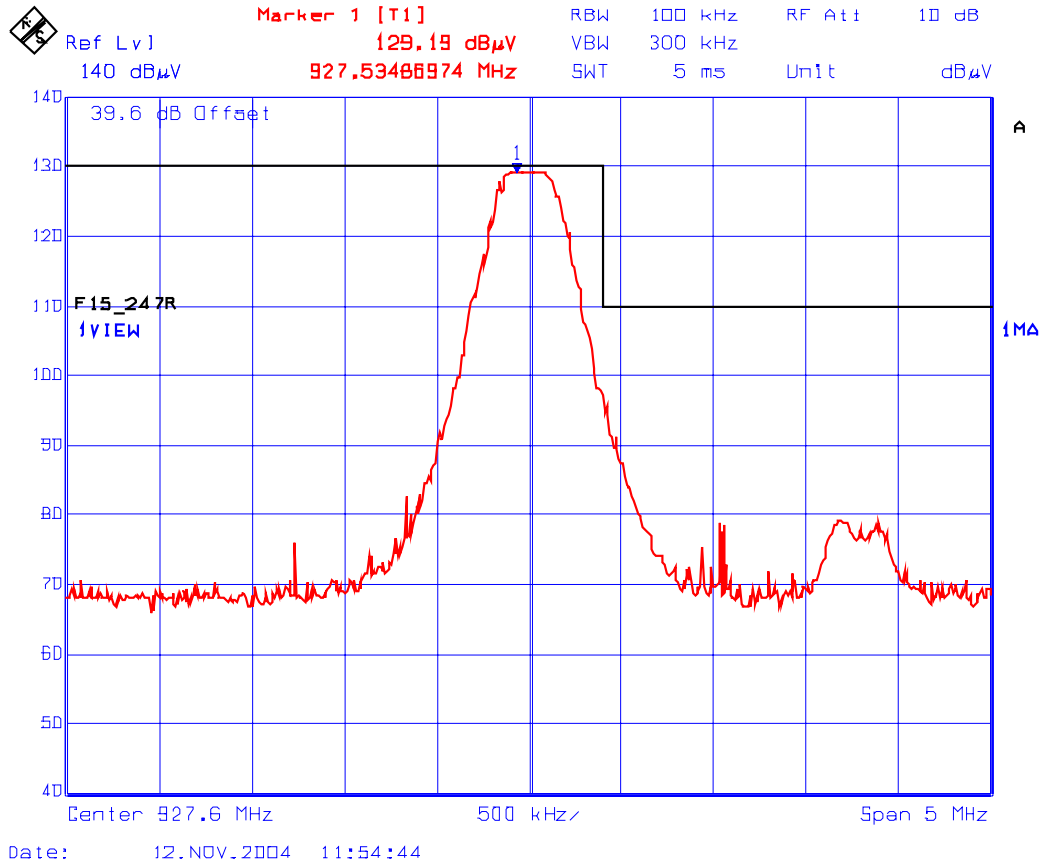



Plot 47:  
Band-Edge RF Radiated Emissions @ 3 meters  
Upper End of Frequency Band  
Test Configuration 3: EUT with Transit Antenna (5.15 dBi Gain)  
Rx Antenna Orientation: Horizontal

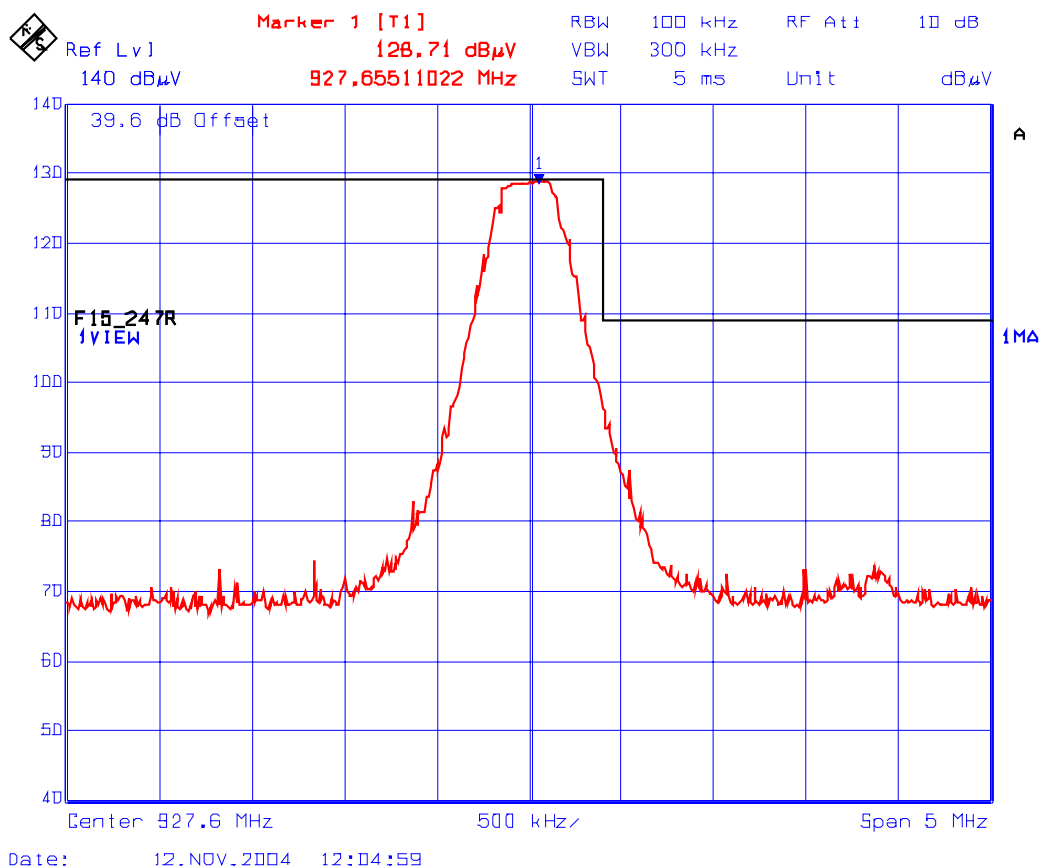

**6.11.5.4. EUT with Yagi Antenna, 14.15 dBi Gain, 0.23 W Power Level, 1.7dB Cable Loss**

Fundamental Frequency: 902.4 MHz  
 Modulation: FHSS  
 Frequency Test Range: 10 MHz – 10 GHz

Frequency (MHz)	RF Peak Level (dBµV/m)	RF Avg Level (dBµV/m)	Antenna Plane (H/V)	Limit 15.209 (dBµV/m)	Limit 15.247 (dBµV/m)	Margin (dB)	Pass/Fail
902.4	130.95	--	V	--	--	--	--
902.4	132.77	--	H	--	--	--	--
2707.2	52.40	49.06	V	54.0	112.8	-4.9	Pass*
2707.2	53.37	50.38	H	54.0	112.8	-3.6	Pass*
3609.6	53.23	49.64	V	54.0	112.8	-4.4	Pass*
3609.6	52.87	49.62	H	54.0	112.8	-4.4	Pass*
4512.0	49.60	40.27	V	54.0	112.8	-13.7	Pass*
4512.0	48.70	38.50	H	54.0	112.8	-15.5	Pass*
5414.4	52.78	44.62	V	54.0	112.8	-9.4	Pass*
5414.4	51.87	43.56	H	54.0	112.8	-10.4	Pass*

All other spurious emissions and harmonics are more than 20 dB below the applicable limit. See test data plots (48 to 49) for band-edge emissions.

\* Emission within the restricted frequency bands.

Plot 48:  
 Band-Edge RF Radiated Emissions @ 3 meters  
 Low End of Frequency Band  
 Test Configuration 4: EUT with Yagi Antenna (14.15 dBi Gain)  
 Rx Antenna Orientation: Vertical

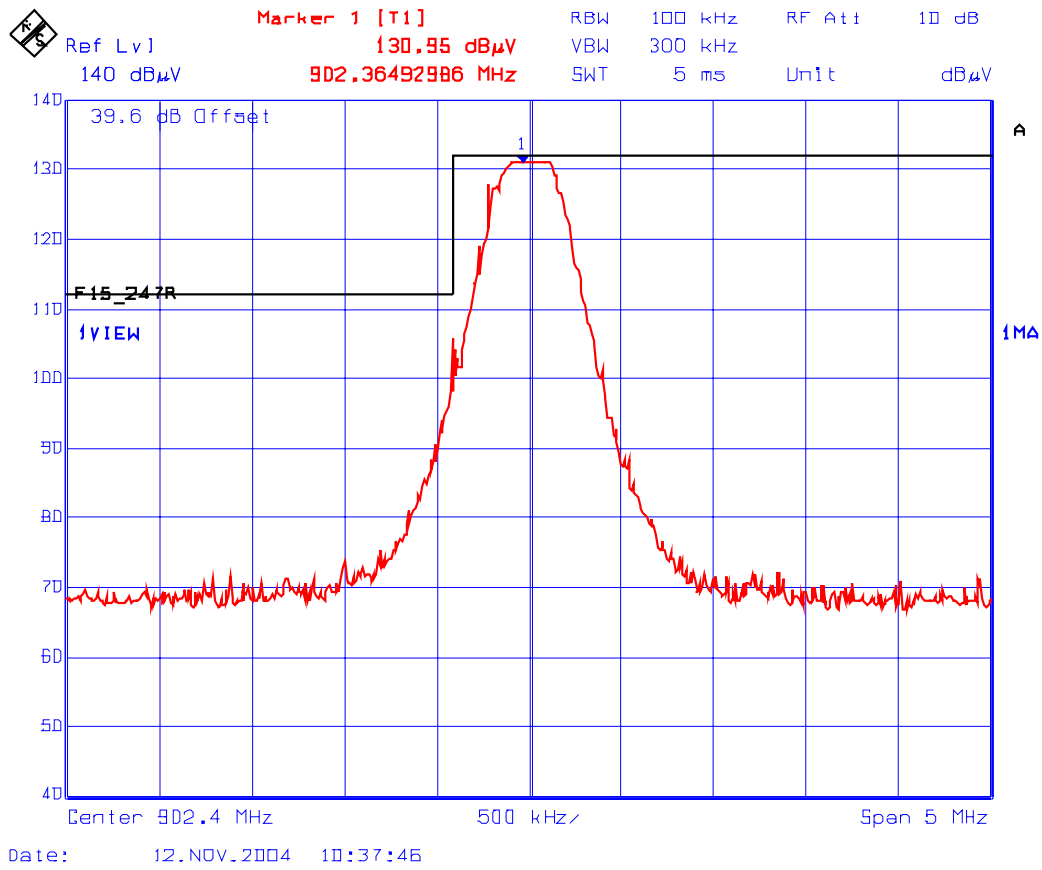

Plot 49:  
 Band-Edge RF Radiated Emissions @ 3 meters  
 Low End of Frequency Band  
 Test Configuration 4: EUT with Yagi Antenna (14.15 dBi Gain)  
 Rx Antenna Orientation: Horizontal

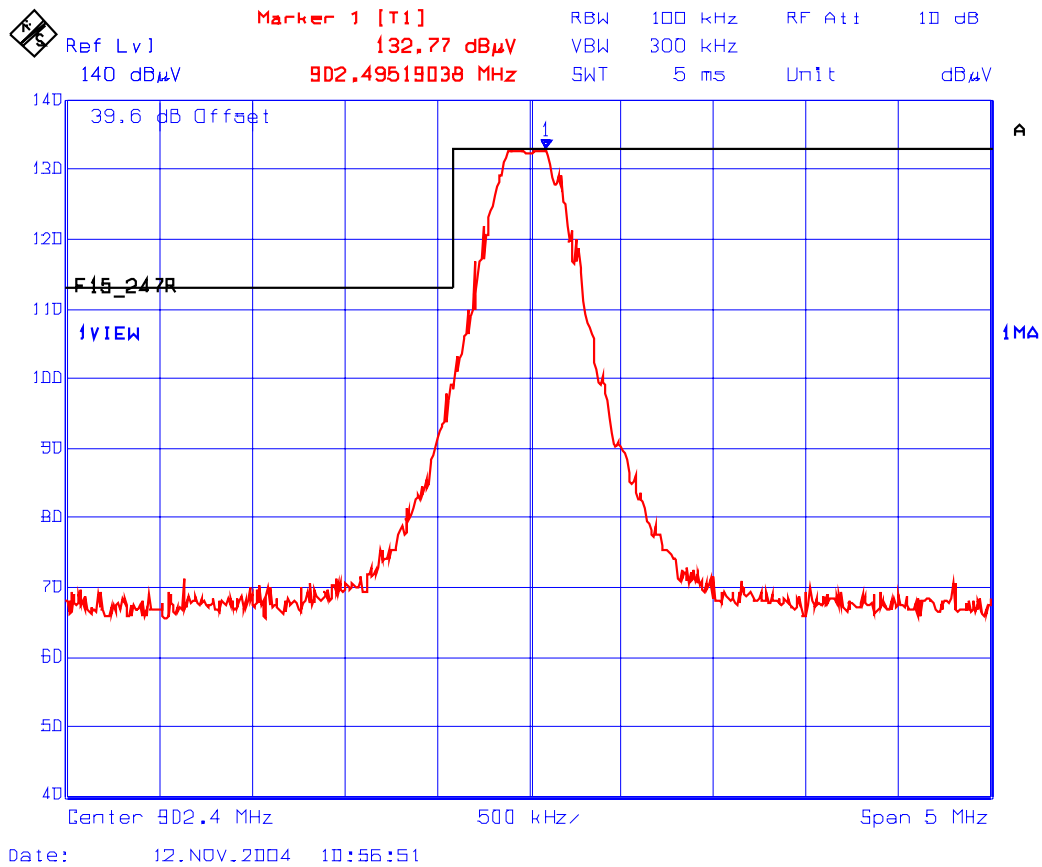

Fundamental Frequency: 915.0 MHz  
 Modulation: FHSS  
 Frequency Test Range: 10 MHz – 10 GHz

Frequency (MHz)	RF Peak Level (dBµV/m)	RF Avg Level (dBµV/m)	Antenna Plane (H/V)	Limit 15.209 (dBµV/m)	Limit 15.247 (dBµV/m)	Margin (dB)	Pass/Fail
915.0	131.08	--	V	--	--	--	--
915.0	129.88	--	H	--	--	--	--
2745.0	51.93	47.75	V	54.0	111.1	-6.3	Pass*
2745.0	51.79	48.94	H	54.0	111.1	-5.1	Pass*
3660.0	53.86	49.20	V	54.0	111.1	-4.8	Pass*
3660.0	52.20	49.42	H	54.0	111.1	-4.6	Pass*
4575.0	47.95	36.61	V	54.0	111.1	-17.4	Pass*
4575.0	48.08	36.89	H	54.0	111.1	-17.1	Pass*
7320.0	54.09	47.18	V	54.0	111.1	-6.8	Pass*
7320.0	56.33	49.53	H	54.0	111.1	-4.5	Pass*

All other spurious emissions and harmonics are more than 20 dB below the applicable limit.

\* Emission within the restricted frequency bands.

Fundamental Frequency: 927.6 MHz  
 Modulation: FHSS  
 Frequency Test Range: 10 MHz – 10 GHz

Frequency (MHz)	RF Peak Level (dBµV/m)	RF Avg Level (dBµV/m)	Antenna Plane (H/V)	Limit 15.209 (dBµV/m)	Limit 15.247 (dBµV/m)	Margin (dB)	Pass/Fail
927.6	131.80	--	V	--	--	--	--
927.6	131.58	--	H	--	--	--	--
2782.8	50.58	46.92	V	54.0	111.8	-7.1	Pass*
2782.8	49.41	45.59	H	54.0	111.8	-8.4	Pass*
3710.4	50.72	45.45	V	54.0	111.8	-8.6	Pass*
3710.4	52.99	48.88	H	54.0	111.8	-5.1	Pass*
4638.0	50.06	41.54	V	54.0	111.8	-12.5	Pass*
4638.0	48.85	35.77	H	54.0	111.8	-18.2	Pass*
7420.8	54.77	44.83	V	54.0	111.8	-9.2	Pass*
7420.8	56.17	48.09	H	54.0	111.8	-5.9	Pass*

All other spurious emissions and harmonics are more than 20 dB below the applicable limit. See test data plots (50 to 51) for band-edge emissions.

\* Emission within the restricted frequency bands.

Plot 50:  
Band-Edge RF Radiated Emissions @ 3 meters  
Upper End of Frequency Band  
Test Configuration 4: EUT with Yagi Antenna (14.15 dBi Gain)  
Rx Antenna Orientation: Vertical

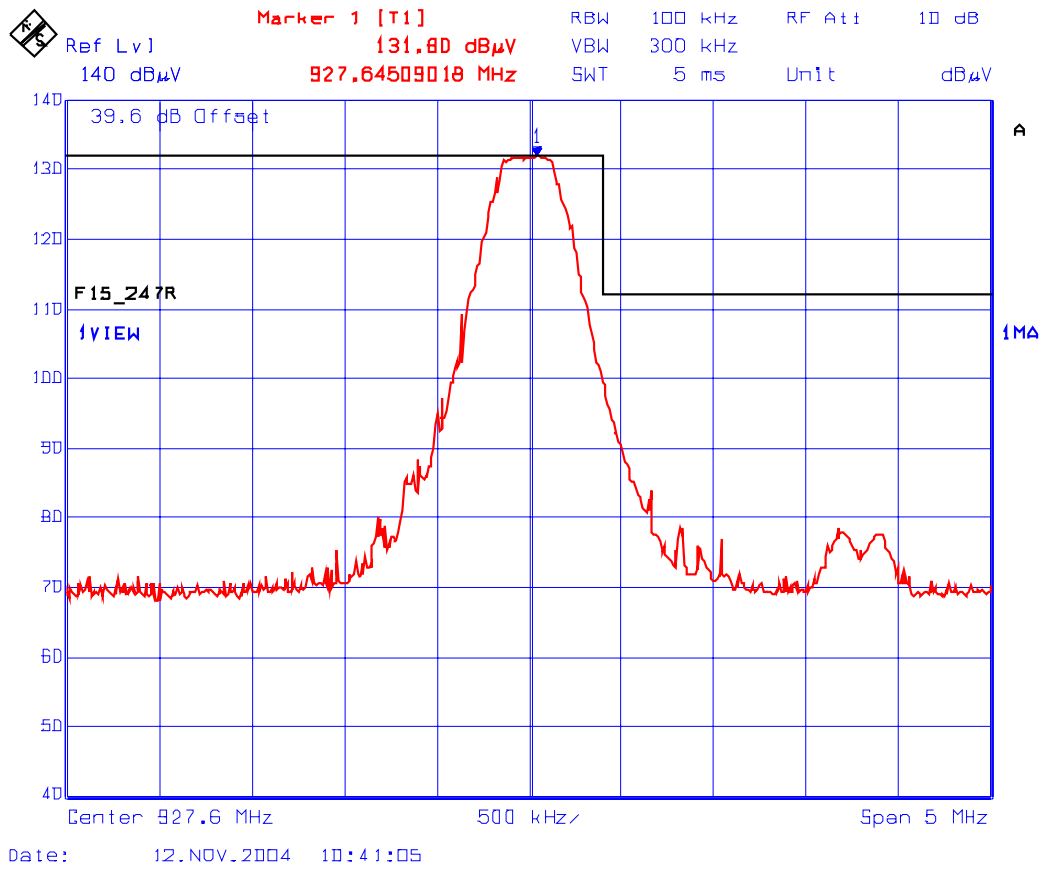

Plot 51:  
Band-Edge RF Radiated Emissions @ 3 meters  
Upper End of Frequency Band  
Test Configuration 4: EUT with Yagi Antenna (14.15 dBi Gain)  
Rx Antenna Orientation: Horizontal

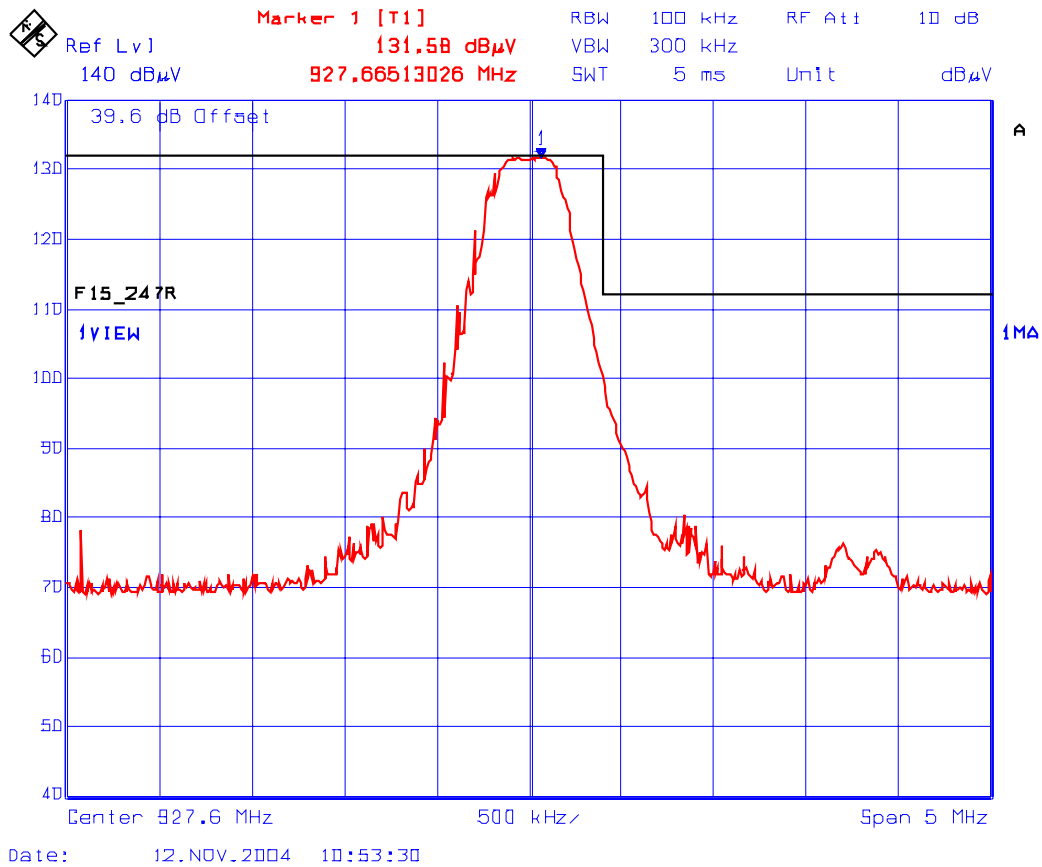



**6.11.5.5. EUT with Omni Directional Antenna, 8.15 dBi Gain, 0.89 Watt Power Level, 1.7dB Cable Loss**

Fundamental Frequency: 902.4 MHz  
 Modulation: FHSS  
 Frequency Test Range: 10 MHz – 10 GHz

Frequency (MHz)	RF Peak Level (dBµV/m)	RF Avg Level (dBµV/m)	Antenna Plane (H/V)	Limit 15.209 (dBµV/m)	Limit 15.247 (dBµV/m)	Margin (dB)	Pass/Fail
902.4	132.91	--	V	--	--	--	--
902.4	135.56	--	H	--	--	--	--
2707.2	46.39	37.63	V	54.0	115.6	-16.4	Pass*
2707.2	49.57	45.30	H	54.0	115.6	-8.7	Pass*
3609.6	50.00	41.28	V	54.0	115.6	-12.7	Pass*
3609.6	50.64	44.27	H	54.0	115.6	-9.7	Pass*
4512.0	48.74	37.28	V	54.0	115.6	-16.7	Pass*
4512.0	49.02	38.64	H	54.0	115.6	-15.4	Pass*
5414.4	52.67	43.44	V	54.0	115.6	-10.6	Pass*
5414.4	55.12	49.74	H	54.0	115.6	-4.3	Pass*
8121.6	57.69	51.99	V	54.0	115.6	-2.0	Pass*
8121.6	57.38	51.60	H	54.0	115.6	-2.4	Pass*
9024.0	55.47	45.28	V	54.0	115.6	-8.7	Pass*
9024.0	55.83	46.07	H	54.0	115.6	-7.9	Pass*

All other spurious emissions and harmonics are more than 20 dB below the applicable limit. See test data plots (52 to 53) for band-edge emissions.

\* Emission within the restricted frequency bands.

Plot 52:  
Band-Edge RF Radiated Emissions @ 3 meters  
Low End of Frequency Band  
Test Configuration 5: EUT with Omni Directional Antenna (8.15 dBi Gain)  
Rx Antenna Orientation: Vertical

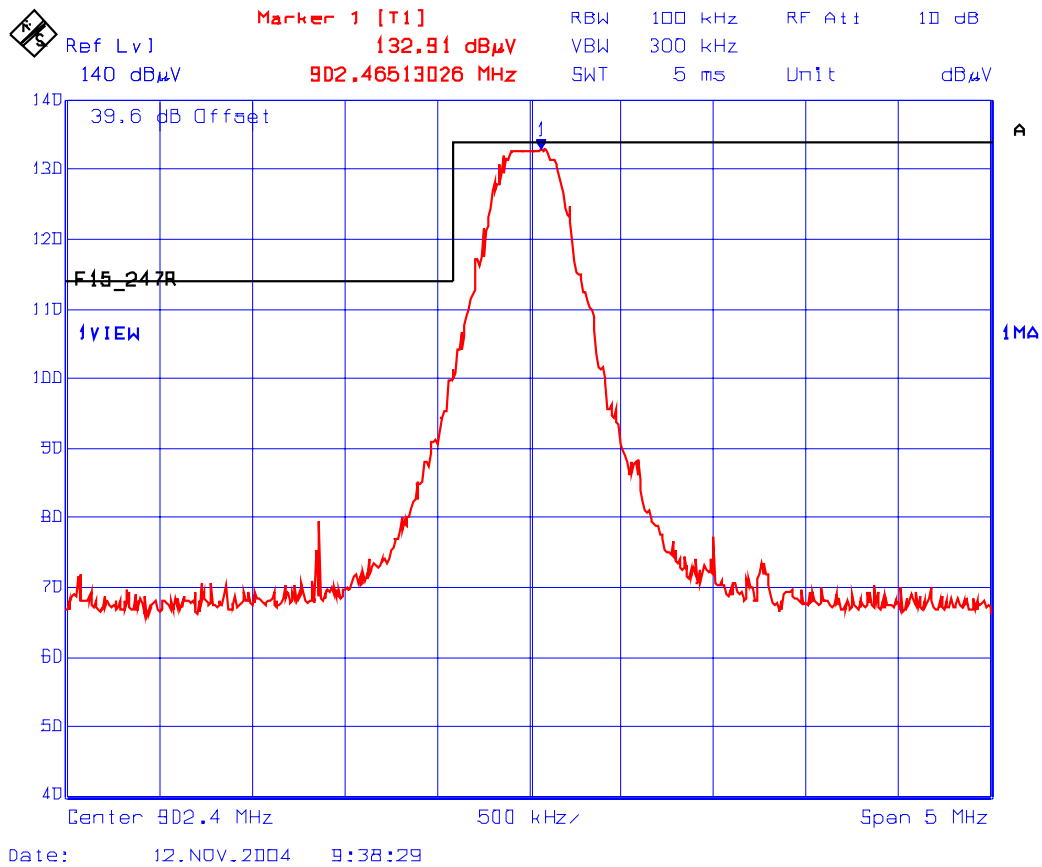

Plot 53:  
Band-Edge RF Radiated Emissions @ 3 meters  
Low End of Frequency Band  
Test Configuration 5: EUT with Omni Directional Antenna (8.15 dBi Gain)  
Rx Antenna Orientation: Horizontal

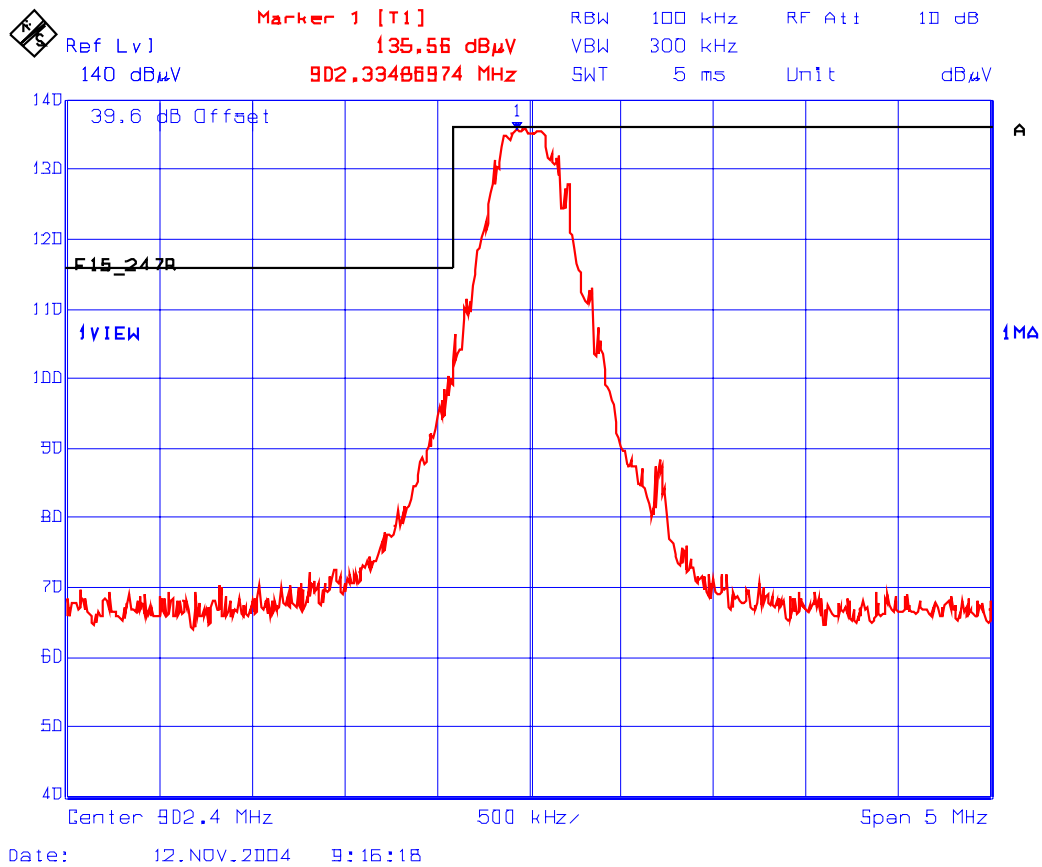

Fundamental Frequency: 915.0 MHz  
 Modulation: FHSS  
 Power Setting: 29.37 dBm  
 Frequency Test Range: 10 MHz – 10 GHz

Frequency (MHz)	RF Peak Level (dBµV/m)	RF Avg Level (dBµV/m)	Antenna Plane (H/V)	Limit 15.209 (dBµV/m)	Limit 15.247 (dBµV/m)	Margin (dB)	Pass/Fail
915.0	133.95	--	V	--	--	--	--
915.0	135.35	--	H	--	--	--	--
2745.0	47.79	41.92	V	54.0	115.4	-12.1	Pass*
2745.0	50.88	47.28	H	54.0	115.4	-6.7	Pass*
3660.0	49.41	39.97	V	54.0	115.4	-14.0	Pass*
3660.0	54.54	49.78	H	54.0	115.4	-4.2	Pass*
4575.0	48.27	36.22	V	54.0	115.4	-17.8	Pass*
4575.0	48.32	36.56	H	54.0	115.4	-17.4	Pass*
7320.0	52.70	41.72	V	54.0	115.4	-12.3	Pass*
7320.0	54.33	46.93	H	54.0	115.4	-7.1	Pass*
8235.0	55.62	44.44	V	54.0	115.4	-9.6	Pass*
8235.0	56.67	49.25	H	54.0	115.4	-4.8	Pass*
9150.0	55.24	43.45	V	54.0	115.4	-10.6	Pass*
9150.0	55.03	45.59	H	54.0	115.4	-8.4	Pass*

All other spurious emissions and harmonics are more than 20 dB below the applicable limit.

\* Emission within the restricted frequency bands.

Fundamental Frequency: 927.6 MHz  
 Modulation: FHSS  
 Power Setting: 29.10 dBm  
 Frequency Test Range: 10 MHz – 10 GHz

Frequency (MHz)	RF Peak Level (dBµV/m)	RF Avg Level (dBµV/m)	Antenna Plane (H/V)	Limit 15.209 (dBµV/m)	Limit 15.247 (dBµV/m)	Margin (dB)	Pass/Fail
927.6	132.91	--	V	--	--	--	--
927.6	133.48	--	H	--	--	--	--
2782.8	50.06	45.53	V	54.0	113.5	-8.5	Pass*
2782.8	49.02	40.67	H	54.0	113.5	-13.3	Pass*
3710.4	49.89	38.21	V	54.0	113.5	-15.8	Pass*
3710.4	49.78	36.95	H	54.0	113.5	-17.1	Pass*
4638.0	48.81	38.26	V	54.0	113.5	-15.7	Pass*
4638.0	47.85	34.24	H	54.0	113.5	-19.8	Pass*
7420.8	54.75	44.49	V	54.0	113.5	-9.5	Pass*
7420.8	56.22	49.22	H	54.0	113.5	-4.8	Pass*
8348.4	55.13	43.57	V	54.0	113.5	-10.4	Pass*
8348.4	56.35	47.65	H	54.0	113.5	-6.4	Pass*

All other spurious emissions and harmonics are more than 20 dB below the applicable limit. See test data plots (54 to 55) for band-edge emissions.

\* Emission within the restricted frequency bands.

Plot 54:  
Band-Edge RF Radiated Emissions @ 3 meters  
Upper End of Frequency Band  
Test Configuration 5: EUT with Omni Directional Antenna (8.15 dBi Gain)  
Rx Antenna Orientation: Vertical

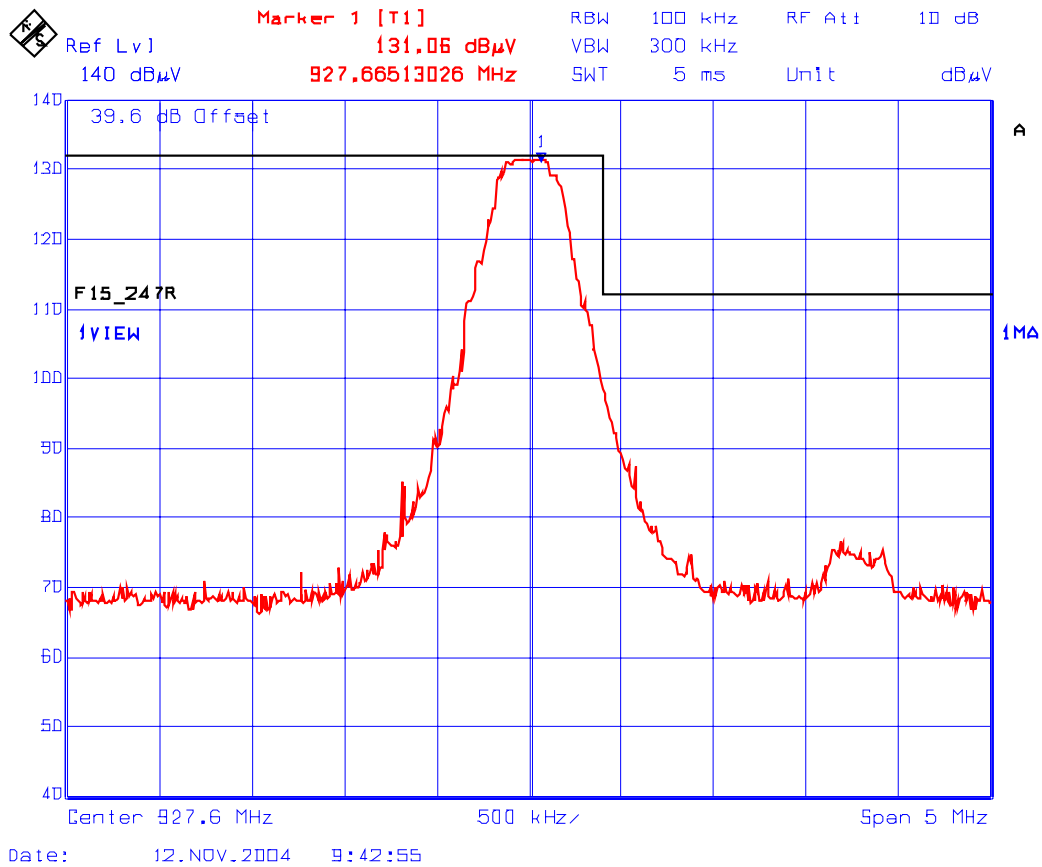

Plot 55:  
Band-Edge RF Radiated Emissions @ 3 meters  
Upper End of Frequency Band  
Test Configuration 5: EUT with Omni Directional Antenna (8.15 dBi Gain)  
Rx Antenna Orientation: Horizontal

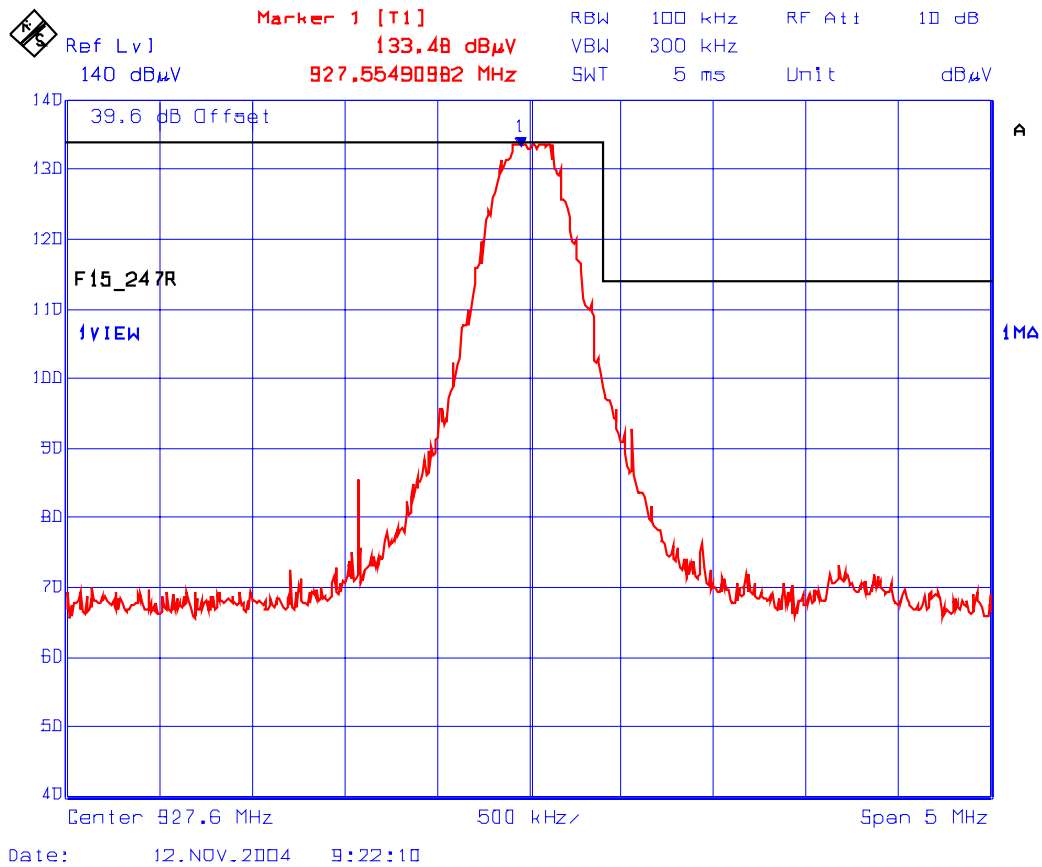

## EXHIBIT 7. MEASUREMENT UNCERTAINTY

The measurement uncertainties stated were calculated in accordance with the requirements of NIST Technical Note 1297 and NIS 81 (1994)

### 7.1. LINE CONDUCTED EMISSION MEASUREMENT UNCERTAINTY

CONTRIBUTION (Line Conducted)	PROBABILITY DISTRIBUTION	UNCERTAINTY (dB)	
		9-150 kHz	0.15-30 MHz
EMI Receiver specification	Rectangular	$\pm 1.5$	$\pm 1.5$
LISN coupling specification	Rectangular	$\pm 1.5$	$\pm 1.5$
Cable and Input Transient Limiter calibration	Normal (k=2)	$\pm 0.3$	$\pm 0.5$
Mismatch: Receiver VRC $\Gamma_1 = 0.03$ LISN VRC $\Gamma_R = 0.8(9 \text{ kHz}) 0.2 (30 \text{ MHz})$ Uncertainty limits $20\text{Log}(1 \pm \Gamma_1 \Gamma_R)$	U-Shaped	$\pm 0.2$	$\pm 0.3$
System repeatability	Std. deviation	$\pm 0.2$	$\pm 0.05$
Repeatability of EUT	--	--	--
Combined standard uncertainty	Normal	$\pm 1.25$	$\pm 1.30$
Expanded uncertainty U	Normal (k=2)	$\pm 2.50$	$\pm 2.60$

Sample Calculation for Measurement Accuracy in 450 kHz to 30 MHz Band:

$$u_c(y) = \sqrt{\sum_{i=1}^m u_i^2(y)} = \pm \sqrt{(1.5^2 + 1.5^2)/3 + (0.5/2)^2 + (0.05/2)^2 + 0.35^2} = \pm 1.30 \text{ dB}$$

$$U = 2u_c(y) = \pm 2.6 \text{ dB}$$



## 7.2. RADIATED EMISSION MEASUREMENT UNCERTAINTY

CONTRIBUTION (Radiated Emissions)	PROBABILITY DISTRIBUTION	UNCERTAINTY (+ dB)	
		3 m	10 m
Antenna Factor Calibration	Normal (k=2)	$\pm 1.0$	$\pm 1.0$
Cable Loss Calibration	Normal (k=2)	$\pm 0.3$	$\pm 0.5$
EMI Receiver specification	Rectangular	$\pm 1.5$	$\pm 1.5$
Antenna Directivity	Rectangular	+0.5	+0.5
Antenna factor variation with height	Rectangular	$\pm 2.0$	$\pm 0.5$
Antenna phase center variation	Rectangular	0.0	$\pm 0.2$
Antenna factor frequency interpolation	Rectangular	$\pm 0.25$	$\pm 0.25$
Measurement distance variation	Rectangular	$\pm 0.6$	$\pm 0.4$
Site imperfections	Rectangular	$\pm 2.0$	$\pm 2.0$
Mismatch: Receiver VRC $\Gamma_1 = 0.2$ Antenna VRC $\Gamma_R = 0.67(\text{Bi}) 0.3 (\text{Lp})$ Uncertainty limits $20\text{Log}(1+\Gamma_1\Gamma_R)$	U-Shaped	+1.1 -1.25	$\pm 0.5$
System repeatability	Std. Deviation	$\pm 0.5$	$\pm 0.5$
Repeatability of EUT		-	-
Combined standard uncertainty	Normal	+2.19 / -2.21	+1.74 / -1.72
Expanded uncertainty U	Normal (k=2)	+4.38 / -4.42	+3.48 / -3.44

Calculation for maximum uncertainty when 3m biconical antenna including a factor of k = 2 is used:

$$U = 2u_c(y) = 2x(+2.19) = +4.38 \text{ dB} \quad \text{And} \quad U = 2u_c(y) = 2x(-2.21) = -4.42 \text{ dB}$$

## EXHIBIT 8. MEASUREMENT METHODS

### 8.1. GENERAL TEST CONDITIONS

The following test conditions shall be applied throughout the tests covered in this report.

#### 8.1.1. Normal temperature and humidity

Normal temperature: +15°C to +35°C  
Relative Humidity: +20% to 75%

The actual values during tests shall be recorded in the test report.

#### 8.1.2. Normal power source

##### 8.1.2.1. Mains Voltage

The nominal test voltage of the equipment to be connected to mains shall be the nominal mains voltage which is the declared voltage or any of the declared voltages for which the equipment was designed.

The frequency of test power source corresponding to the AC mains shall be between 59 Hz and 61 Hz.

##### 8.1.2.2. Battery Power Source.

For operation from battery power sources, the nominal test voltage shall be as declared by the equipment manufacturer. This shall be recorded in the test report.

#### 8.1.3. Operating Condition of Equipment under Test

- All tests were carried out while the equipment operated at the following frequencies:
  - The lowest operating frequency,
  - The middle operating frequency and
  - The highest operating frequency
- Modulation were applied using the Test Data sequence
- The transmitter was operated at the highest output power, or in the case the equipment able to operate at more than one power level, at the lowest and highest output powers

## 8.2. METHOD OF MEASUREMENTS - AC MAINS CONDUCTED EMISSIONS

- AC Mains conducted emissions measurements were performed in accordance with the standard against appropriate limits for each detector function.
- The test was performed in the shielded room, 24'(L) by 16'(W) by 8'(H).
- The test was performed over the frequency range from 150 kHz to 30 MHz to determine the line-to-ground radio noise voltage which was conducted from the EUT power-input terminals that were directly connected to a public power network.
- The EUT normally received power from another device that connects to the public utility ac power lines, measurements would be made on that device with the EUT in operation to ensure that the device continues to comply with the appropriate limits while providing the EUT with power.
- If the EUT operates only from internal or dedicated batteries, with no provisions for connection to the public utility ac power lines, AC Mains conducted measurements are not required.
- Table-top devices were placed on a platform of nominal size 1 m by 1.5m raised 80 cm above the conducting ground plane.
- The EUT current-carrying power lead, except the ground (safety) lead, was individually connected through a LISN to the power source. All unused 50-Ohm connectors of the LISN was terminated in 50-ohm when not connected to the measuring instruments.
- The line cord of the EUT connected to one LISN which was connected to the measuring instrument. Those power cords for the units of devices not under measurement were connected to a separate multiple ac outlet. Drawings and photographs of typically conducted emission test setups were shown in the Test Report. Each current-carrying conductor of the EUT shall be individually tested.
- The EUT was normally operated with a ground (safety) connection, the EUT was connected to the ground at the LISN through a conductor provided in the lead from the ac power mains to the LISN.
- The excess length of the power cord was folded back and forth in an 8-shape on a wooden strip with a vertical prong located on the top of the LISN case.
- The EUT was set-up in its typical configuration and operated in its various modes as described in this test report.
- A preliminary scan was made by using spectrum analyzer system with the detector function set to PEAK mode (9 KHz RBW, VBW > RBW), frequency span 150 kHz to 30 MHz.
- The maximum conducted emission for a given mode of operation was found by using the following step-by-step procedure:
  - Step 1. Monitor the frequency range of interest at a fixed EUT azimuth.
  - Step 2. Manipulate the system cables and peripheral devices to produce highest amplitude signal relative to the limit. Note the amplitude and frequency of the suspect signal.
  - Step 3. The effects of various modes of operation is examined. This is done by varying equipment operation modes as step 2 is being performed.
  - Step 4. After completing step 1 through 3, record EUT and peripheral device configuration, mode of operation, cable configuration, signal levels and frequencies for final test.
- Each highest signal level at the maximized test configuration was zoomed in a small frequency span on the spectrum analyzer's display (the manipulation of cables and peripheral devices and EUT operation modes might have to be repeated to obtain the highest signal level with the spectrum analyzer set to PEAK detector mode 10 KHz RBW and VBW > RBW). The spectrum analyzer was then set to CISPR QUASI-PEAK detector mode (9 KHz RBW, 1 MHz VBW) and AVERAGE detector mode (9 kHz RBW, 1 Hz VBW). The final highest RF signal levels and frequencies were record.

### 8.3. EQUIVALENT ISOTROPIC RADIATED POWER (EIRP)

- The following shall be applied to the combination(s) of the radio device and its intended antenna(e).
- If the RF level is user adjustable, all measurements shall be made with the highest power level available to the user for that combination.
- The following method of measurement shall apply to both conducted and radiated measurements.
- The radiated measurements are performed at the Ultratech Calibrated Open Field Test Site.
- The measurement shall be performed using normal operation of the equipment with modulation.

Test procedure shall be as follows:

#### Step 1: Duty Cycle measurements

- Using a spectrum analyzer with the frequency span set to 0 Hz and the sweep time set at a suitable value to capture the envelope peaks and the duty cycle of the transmitter output signal;
- The duty cycle of the transmitter,  $x = \text{Tx on} / (\text{Tx on} + \text{Tx off})$  with  $0 < x < 1$ , is measure and recorded in the test report. For the purpose of testing, the equipment shall be operated with a duty cycle that is equal or more than 0.1.

#### Step 2: Calculation of Peak and Average EIRP

- The peak output power of the transmitter shall be determined using a wideband, calibrated RF Peak Power Meter with the power sensor with an integration period that exceeds the repetition period of the transmitter by a factor 5 or more. The observed value shall be recorded as “P” (in dBm);
- The Average EIRP shall be calculated from the above measured power output “A”, the observed duty cycle x, and the applicable antenna assembly gain “G” in dBi, according to the formula:

$$\text{Peak EIRP} = P + G$$
$$\text{Average EIRP} = \text{Peak EIRP} + 10\log(1/x)$$

Figure 1

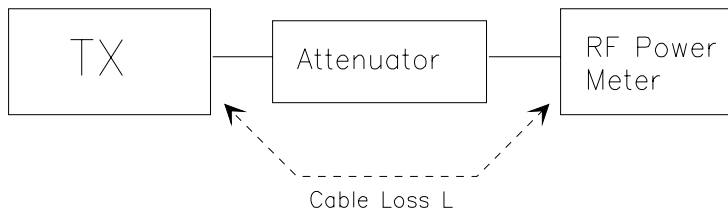

**Step 3:** Substitution Method. See Figure 2

- (a) The measurements was performed in the absence of modulation (un-modulated)
- (b) Test was performed at listed 3m open area test site (listed with FCC, IC, ITI, NVLAP, ACA & VCCI).
- (c) The transmitter under test was placed at the specified height on a non-conducting turntable (80 cm height)
- (d) The dipole test antenna was used and tuned to the transmitter carrier frequency.
- (e) The spectrum analyzer was tuned to transmitter carrier frequency. The test antenna was lowered or raised from 1 to 4 meters until the maximum signal level was detected.
- (f) The transmitter was rotated through  $360^\circ$  about a vertical axis until a higher maximum signal was received.
- (g) The test antenna was lowered or raised again from 1 to 4 meters until a maximum was obtained. This level was recorded.
- (h) The substitution dipole antenna and the signal generator replaced the transmitter and antenna under test in the same position, and the substitution dipole antenna was placed in vertical polarization. The test dipole antenna was lowered or raised as necessary to ensure that the maximum signal is still received.
- (i) The input signal to the substitution antenna was adjusted in level until an equal or a known related level to that detected from the transmitter was obtained in the test receiver. The maximum carrier radiated power is equal to the power supply by the generator.
- (j) The substitution antenna gain and cable loss were added to the signal generator level for the corrected ERP level.
- (k) Repeat steps (c) to (j) with the substitution antenna oriented in horizontal polarization.
- (l) Actual gain of the EUT's antenna is the difference of the measured ERP and measured RF power at the RF port. Correct the antenna gain if necessary.

**Figure 2**

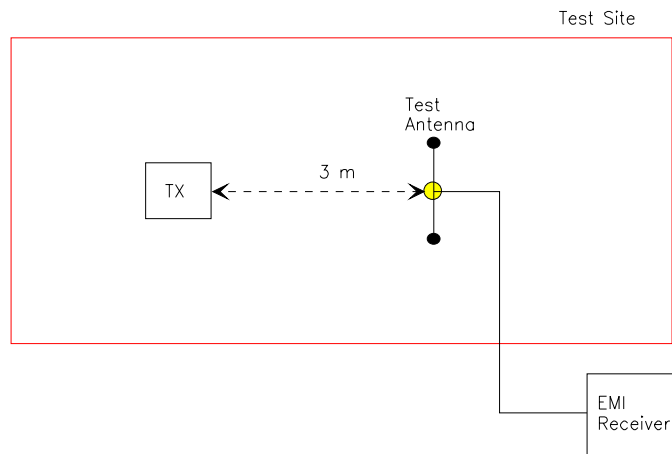
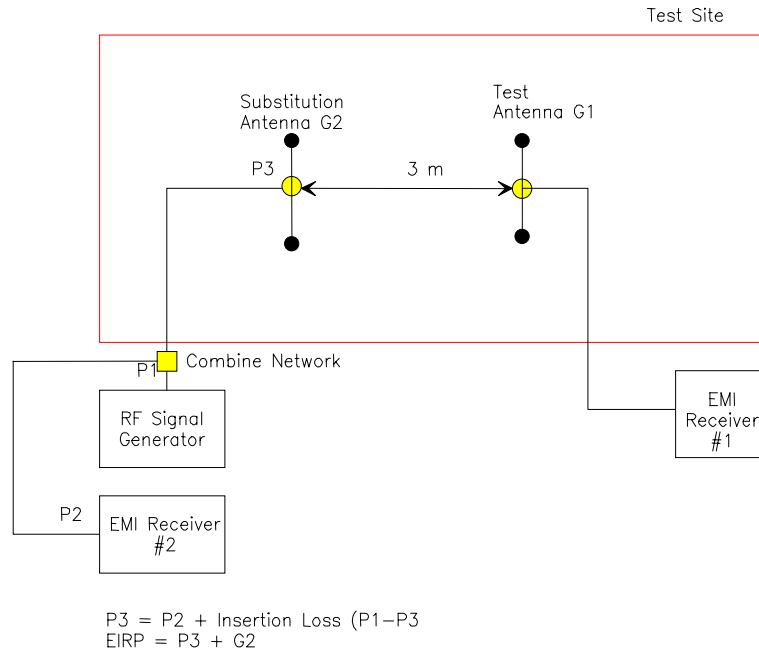

Figure 3



Use the following spectrum analyzer settings:

- Span = approximately 5 times the 20 dB BW, centered on a hopping channel
- RBW > 20 dB BW of the emission measured
- VBW = RBW
- Trace = max hold
- Allow the trace to stabilize
- Use the marker-to-marker function to set the marker to the peak of the emission.
- The indicated level is the peak output power (with the addition of the external attenuation and cable loss).
- The limit is specified in one of the subparagraph of this Section.
- Submit this plot.
- A peak responding power meter may be used instead of a spectrum analyzer.

## 8.4. SPURIOUS EMISSIONS (CONDUCTED & RADIATED)

For both conducted and radiated measurements, the spurious emissions were scanned from the lowest frequency generated by the EUT or 10 MHz whichever is lower to 10<sup>th</sup> harmonic of the highest frequency generated by the EUT.

### 8.4.1. Band-Edge and Spurious Emissions (Conducted)

#### Band-Edge Compliance of RF Conducted Emissions:

Use the following spectrum analyzer settings:

- The radio was connected to the measuring equipment via a suitable attenuator.
- Span = wide enough to capture the peak level of the emission operating on the channel closest to the band-edge, as well as any modulation products which fall outside of the authorized band of operation.
- RBW = 1 % of the span
- VBW = RBW
- Sweep = auto
- Detector function = peak
- Trace = max hold
- Allow the trace to stabilize
- Set the marker on the emission at the band-edge, or on the highest modulation product outside of the band, if this level is greater than that at the band-edge
- Enable the marker-delta function, then use the marker-to-peak function to move the marker to the peak of the in-band emission.
- The marker-delta value now displayed must comply with the limit specified
- Now, using the same instrument settings, enable the hopping function of the EUT
- Allow the trace to stabilize
- Follow the same procedure listed above to determine if any spurious emissions cause by the hopping function also comply with the specify limits.
- Submit this plot

#### Spurious RF Conducted Emissions:

Use the following spectrum analyzer settings:

- The radio was connected to the measuring equipment via a suitable attenuator.
- Span = wide enough to capture the peak level of the in-band-emission and all spurious emissions (e.g. harmonics) from the lowest frequency generated in the EUT up through the 10<sup>th</sup> harmonic. Typically, several plots are required to cover this entire span.
- RBW = 100 kHz
- VBW = RBW
- Sweep = auto
- Detector function = peak
- Trace = max hold
- Allow the trace to stabilize
- Set the marker on the any spurious emission recorded. The level displayed must comply with the limit specified in this Section.
- Submit this plot

### 8.4.2. Spurious Emissions (Radiated)

- The radiated emission measurements were performed at the UltraTech's 3 Meter Open Field Test Site (OFTS) situated in the Town of Oakville, province of Ontario. The Attenuation Characteristics of OFTS have been filed to FCC, Industry Canada, ACA/Austel, NVLap and ITI.
- Radiated emissions measurements were made using the following test instruments:
  1. Calibrated EMCO BiconiLog antenna in the frequency range from 30 MHz to 2000 MHz.
  2. Calibrated Emco Horn antennas in the frequency range above 1000 MHz (1GHz - 40 GHz).
  3. The test is required for any spurious emission or modulation product that falls in a Restricted Band, as defined in Section 15.205. It must be performed with the highest gain of each type of antenna proposed for use with the EUT. Use the following spectrum analyzer settings:
    - RBW = 100 kHz for  $f < 1\text{GHz}$  and  $\text{RBW} = 1\text{ MHz}$  for  $f \geq 1\text{ GHz}$
    - VBW = RBW
    - Sweep = auto
    - Detector function = peak
    - Trace = max hold
    - Follows the guidelines in ANSI C63.4-1992 with respect to maximizing the emission by rotating the EUT, measuring the emission while the EUT is situated in three orthogonal planes (if appropriate), adjusting the measurement antenna height and polarization, etc.. A pre-amp and highpass filter are required for this test, in order to provide the measuring system with sufficient sensitivity.
    - Allow the trace to stabilize.
    - The peak reading of the emission, after being corrected by the antenna correction factor, cable loss, pre-amp gain, etc.... is the peak field strength which comply with the limit specified in Section 15.35(b)

#### Calculation of Field Strength:

The field strength is calculated by adding the calibrated antenna factor and cable factor, and subtracting the Amplifier gain (if any) from the measured reading. The basic equation with a sample calculation is as follows:

$$\text{FS} = \text{RA} + \text{AF} + \text{CF} - \text{AG}$$

Where FS = Field Strength  
RA = Receiver/Analyzer Reading  
AF = Antenna Factor  
CF = Cable Attenuation Factor  
AG = Amplifier Gain

Example: If a receiver reading of 60.0 dB $\mu$ V is obtained, the antenna factor of 7.0 dB/m and cable factor of 1.0 dB are added, and the amplifier gain of 30 dB is subtracted. The actual field strength will be:

$$\text{Field Level} = 60 + 7.0 + 1.0 - 30 = 38.0 \text{ dB}\mu\text{V/m.}$$

$$\text{Field Level} = 10^{(38/20)} = 79.43 \mu\text{V/m.}$$



- Submit this test data
- Now set the VBW to 10Hz, while maintaining all of the other instrument settings. This peak level, once corrected, must comply with the limit specified in Section 15.209. If the dwell time per channel of the hopping signal is less than 100ms, then the reading obtained may be further adjusted by a “duty cycle correction factor”, derived from  $10\log(\text{dwell time}/100\text{mS})$  in an effort to demonstrate compliance with the 15.209.
- Submit test data

### **Maximizing The Radiated Emissions:**

- The frequencies of emissions was first detected. Then the amplitude of the emissions was measured at the specified measurement distance using required antenna height, polarization, and detector characteristics.
- During this process, cables and peripheral devices were manipulated within the range of likely configuration.
- For each mode of operation required to be tested, the frequency spectrum was monitored. Variations in antenna heights (from 1 meter to 4 meters above the ground plane), antenna polarization (horizontal plane and vertical plane), cable placement and peripheral placement were explored to produce the highest amplitude signal relative to the limit.

The maximum radiated emission for a given mode of operation was found by using the following step-by-step procedure:

- Step 1: Monitor the frequency range of interest at a fixed antenna height and EUT azimuth.
- Step 2: Manipulate the system cables to produce highest amplitude signal relative to the limit. Note the amplitude and frequency of the suspect signal.
- Step 3: Rotate the EUT 360 degrees to maximize the suspected highest amplitude signal. If the signal or another at a different frequency is observed to exceed the previously noted highest amplitude signal by 1 dB or more, go back to the azimuth and repeat Step 2. Otherwise, orient the EUT azimuth to repeat the highest amplitude observation and proceed.
- Step 4: Move the antenna over its full allowable range of travel (1 to 4 meters) to maximize the suspected highest amplitude signal. If the signal or another at a different frequency is observed to exceed the previously noted highest amplitude signal by 1 dB or more, return to Step 2 with the highest amplitude observation and proceed.
- Step 5: Change the polarization of the antenna and repeat Step 2 through 4. Compare the resulting suspected highest amplitude signal with that found for the other polarization. Select and note the higher of the two signals. This signal is termed the highest observed signal with respect to the limit for this EUT operational mode.
- Step 6: The effects of various modes of operation is examined. This is done by varying the equipment modes as steps 2 through 5 are being performed.
- Step 7: After completing steps 1 through 6, record the final highest emission level, frequency, antenna polarization and detector mode of the measuring instrument.

## 8.5. ALTERNATIVE TEST PROCEDURES

If the antenna conducted tests cannot be performed on this device, radiated tests show compliance with the peak output power limit specified in Section 15.247(b) and the spurious RF conducted emission limit specified in Section 15.247(c) are acceptable. As stated previously, a pre-amp, and, in the later case, a high pass filter, are required for the following measurements:

### 8.5.1. Peak Power Measurements

Calculate the transmitter's peak power using the following equation:

$$E = 30PG/d$$
$$P = (Ed)^2/30G$$

Where:

- E: measured maximum fundamental field strength in V/m. Utilizing a RBW, the 20 dB bandwidth of the emission  $VBW > RBW$ , peak detector function. Follow the procedures in C63.4-1992 with respect to maximizing the emission
- G is numeric gain of the transmitting antenna with reference to an isotropic radiator
- D is the distance in meters from which the field strength was measured
- P is the distance in meters from which the field strength was measured

### 8.5.2. Spurious RF conducted emissions

The demonstrate compliance with the spurious RF conducted emission requirement of Section 15.2479(c), use the following spectrum analyzer settings:

- Span = wide enough to fully capture the emission being measured
- RBW = 100 kHz
- Sweep = auto
- Detector function = peak
- Trace = max hold
- Measure the field strength of both the fundamental and all spurious emissions with these settings.
- Follow the procedures C63.4 with respect to maximizing the emissions. The measured field strength of all spurious emissions must be below the measured field strength of the fundamental emission by the amount specified in Section 15.247©. Note that if the emission falls in a Restricted Band, as defined in Section 15.205, the procedure for measuring spurious radiated emissions listed above must be followed