

FCC Test Report

Report No.: RF170531E01

FCC ID: NOIKB-E60QP2

Test Model: E60QP2

Received Date: May 31, 2017

Test Date: June 06 to 08, 2017

Issued Date: Sep. 28, 2017

Applicant: NETRONIX, INC.

Address: No. 945, Boai St., Jubei City, Hsin-Chu,302,Taiwan, R.O.C.

Issued By: Bureau Veritas Consumer Products Services (H.K.) Ltd., Taoyuan Branch
Hsin Chu Laboratory

Lab Address: E-2, No.1, Li Hsin 1st Road, Hsinchu Science Park, Hsinchu City 300,
Taiwan R.O.C.

Test Location (1): E-2, No.1, Li Hsin 1st Road, Hsinchu Science Park, Hsinchu City 300,
Taiwan R.O.C.

Test Location (2): No. 49, Ln. 206, Wende Rd., Shangshan Tsuen, Chiung Lin Hsiang, Hsin
Chu Hsien 307, Taiwan R.O.C.



This report is for your exclusive use. Any copying or replication of this report to or for any other person or entity, or use of our name or trademark, is permitted only with our prior written permission. This report sets forth our findings solely with respect to the test samples identified herein. The results set forth in this report are not indicative or representative of the quality or characteristics of the lot from which a test sample was taken or any similar or identical product unless specifically and expressly noted. Our report includes all of the tests requested by you and the results thereof based upon the information that you provided to us. You have 60 days from date of issuance of this report to notify us of any material error or omission caused by our negligence, provided, however, that such notice shall be in writing and shall specifically address the issue you wish to raise. A failure to raise such issue within the prescribed time shall constitute your unqualified acceptance of the completeness of this report, the tests conducted and the correctness of the report contents. Unless specific mention, the uncertainty of measurement has been explicitly taken into account to declare the compliance or non-compliance to the specification. The report must not be used by the client to claim product certification, approval, or endorsement by TAF or any government agencies.

Table of Contents

Release Control Record	4
1 Certificate of Conformity	5
2 Summary of Test Results	6
2.1 Measurement Uncertainty	6
2.2 Modification Record	6
3 General Information	7
3.1 General Description of EUT	7
3.2 Description of Test Modes	9
3.2.1 Test Mode Applicability and Tested Channel Detail	10
3.3 Duty Cycle of Test Signal	12
3.4 Description of Support Units	13
3.4.1 Configuration of System under Test	14
3.5 General Description of Applied Standards	15
4 Test Types and Results	16
4.1 Radiated Emission and Bandedge Measurement	16
4.1.1 Limits of Radiated Emission and Bandedge Measurement	16
4.1.2 Test Instruments	17
4.1.3 Test Procedures	19
4.1.4 Deviation from Test Standard	20
4.1.5 Test Setup	20
4.1.6 EUT Operating Conditions	21
4.1.7 Test Results	22
4.2 Conducted Emission Measurement	32
4.2.1 Limits of Conducted Emission Measurement	32
4.2.2 Test Instruments	32
4.2.3 Test Procedures	33
4.2.4 Deviation from Test Standard	33
4.2.5 Test Setup	33
4.2.6 EUT Operating Conditions	33
4.2.7 Test Results (Mode 1)	34
4.2.8 Test Results (Mode 2)	36
4.3 6dB Bandwidth Measurement	38
4.3.1 Limits of 6dB Bandwidth Measurement	38
4.3.2 Test Setup	38
4.3.3 Test Instruments	38
4.3.4 Test Procedure	38
4.3.5 Deviation from Test Standard	38
4.3.6 EUT Operating Conditions	38
4.3.7 Test Result	39
4.4 Conducted Output Power Measurement	41
4.4.1 Limits of Conducted Output Power Measurement	41
4.4.2 Test Setup	41
4.4.3 Test Instruments	41
4.4.4 Test Procedures	41
4.4.5 Deviation from Test Standard	41
4.4.6 EUT Operating Conditions	41
4.4.7 Test Results	42
4.5 Power Spectral Density Measurement	44
4.5.1 Limits of Power Spectral Density Measurement	44
4.5.2 Test Setup	44
4.5.3 Test Instruments	44
4.5.4 Test Procedure	44
4.5.5 Deviation from Test Standard	44

4.5.6 EUT Operating Condition	44
4.5.7 Test Results	45
4.6 Conducted Out of Band Emission Measurement	47
4.6.1 Limits of Conducted Out of Band Emission Measurement.....	47
4.6.2 Test Setup.....	47
4.6.3 Test Instruments	47
4.6.4 Test Procedure	47
4.6.5 Deviation from Test Standard	47
4.6.6 EUT Operating Condition	47
4.6.7 Test Results	47
5 Pictures of Test Arrangements.....	51
Appendix – Information on the Testing Laboratories	52

Release Control Record

Issue No.	Description	Date Issued
RF170531E01	Original release.	Sep. 28, 2017

1 Certificate of Conformity

Product: 6" EBOOK READER DEVICE

Brand: NETRONIX

Test Model: E60QP2

Sample Status: ENGINEERING SAMPLE

Applicant: NETRONIX, INC.

Test Date: May 26 to June 01, 2017

Standards: 47 CFR FCC Part 15, Subpart C (Section 15.247)
ANSI C63.10: 2013

The above equipment has been tested by **Bureau Veritas Consumer Products Services (H.K.) Ltd., Taoyuan Branch**, and found compliance with the requirement of the above standards. The test record, data evaluation & Equipment Under Test (EUT) configurations represented herein are true and accurate accounts of the measurements of the sample's EMC characteristics under the conditions specified in this report.

Prepared by : Cindy Hsin , **Date:** Sep. 28, 2017
Cindy Hsin / Specialist

Approved by : May Chen , **Date:** Sep. 28, 2017
May Chen / Manager

2 Summary of Test Results

47 CFR FCC Part 15, Subpart C (SECTION 15.247)			
FCC Clause	Test Item	Result	Remarks
15.207	AC Power Conducted Emission	PASS	Meet the requirement of limit. Minimum passing margin is -11.59dB at 0.48594MHz.
15.205 / 15.209 / 15.247(d)	Radiated Emissions and Band Edge Measurement	PASS	Meet the requirement of limit. Minimum passing margin is -0.2dB at 4824.00MHz.
15.247(d)	Antenna Port Emission	PASS	Meet the requirement of limit.
15.247(a)(2)	6dB bandwidth	PASS	Meet the requirement of limit.
15.247(b)	Conducted power	PASS	Meet the requirement of limit.
15.247(e)	Power Spectral Density	PASS	Meet the requirement of limit.
15.203	Antenna Requirement	PASS	No antenna connector is used.

2.1 Measurement Uncertainty

Where relevant, the following measurement uncertainty levels have been estimated for tests performed on the EUT as specified in CISPR 16-4-2:

Measurement	Frequency	Expanded Uncertainty (k=2) (\pm)
Conducted Emissions at mains ports	150kHz ~ 30MHz	1.84 dB
Radiated Emissions up to 1 GHz	30MHz ~ 1GHz	5.32 dB
Radiated Emissions above 1 GHz	1GHz ~ 6GHz	5.14 dB
	6GHz ~ 18GHz	5.04 dB
	18GHz ~ 40GHz	5.25 dB

2.2 Modification Record

There were no modifications required for compliance.

3 General Information

3.1 General Description of EUT

Product	6" EBOOK READER DEVICE
Brand	NETRONIX
Test Model	E60QP2
Status of EUT	ENGINEERING SAMPLE
Power Supply Rating	3.7-4.2Vdc from battery or 5Vdc from USB interface
Modulation Type	CCK, DQPSK, DBPSK for DSSS 64QAM, 16QAM, QPSK, BPSK for OFDM
Modulation Technology	DSSS, OFDM
Transfer Rate	802.11b: up to 11Mbps 802.11g: up to 54Mbps 802.11n: up to 72.2Mbps
Operating Frequency	2.412 ~ 2.462GHz
Number of Channel	11
Output Power	149.279mW
Antenna Type	Refer to Note
Antenna Connector	Refer to Note
Accessory Device	NA
Data Cable Supplied	USB cable (shielded, 1m) x 1

Note:

1. The EUT must be supplied with a battery as following table:

Brand	Model No.	Spec.
SPRINGPOWER TECHNOLOGY	285083	3.7-4.2Vdc, 1500mAh

2. The antenna provided to the EUT, please refer to the following table:

Brand	Model	Gain (dBi)	Antenna Type	Connector Type	Frequency range(GHz)	Cable Loss(dB)	Cable Length
Walsin Technology Corporation	RFECA3216060AAT	2	Ceramic antenna	soldering terminal	2.4~2.4835	NA	NA

3. The EUT must be supplied with a USB Cable and following different models could be chosen as following table:

No	Brand	Spec.
1	Yih Fone	Shielded, 1.0m
2	HANRICO	Shielded, 1.0m

Note:

1. From the above USB Cables, the radiated emissions worse case was found in **USB Cable 1**. Therefore only the test data of the mode was recorded in this report.

4. For radiated emission test, the EUT was pre-tested under the following test modes :

Pre-test Mode	Power
Mode A	Power from Adapter
Mode B	Power from Battery

The worst radiated emission was found in **Mode A**. Therefore only the test data of the modes were recorded in this report.

5. For radiated emission test, the EUT was pre-tested under the following test modes :

Pre-test Mode	CPU
Sample 1	I.MX6SL
Sample 2	I.MX6SLL

The worst radiated emission was found in **Sample 1**. Therefore only the test data of the modes were recorded in this report.

6. The EUT incorporates a SISO function.

MODULATION MODE	DATA RATE (MCS)	TX & RX CONFIGURATION	
802.11b	1 ~ 11Mbps	1TX	1RX
802.11g	6 ~ 54Mbps	1TX	1RX
802.11n (HT20)	MCS 0~7	1TX	1RX

7. When USB port is charging the rechargeable battery, the EUT has WiFi function under charging mode. And the USB port is connected to Host unit, the EUT WiFi function will be disabled.

8. The above EUT information is declared by manufacturer and for more detailed features description, please refer to the manufacturer's specifications or user's manual.

3.2 Description of Test Modes

11 channels are provided for 802.11b, 802.11g and 802.11n (HT20):

Channel	Frequency	Channel	Frequency
1	2412MHz	7	2442MHz
2	2417MHz	8	2447MHz
3	2422MHz	9	2452MHz
4	2427MHz	10	2457MHz
5	2432MHz	11	2462MHz
6	2437MHz		

3.2.1 Test Mode Applicability and Tested Channel Detail

EUT CONFIGURE MODE	APPLICABLE TO				DESCRIPTION
	RE \geq 1G	RE $<$ 1G	PLC	APCM	
1	√	√	√	√	Power from adapter
2			√		Power from Laptop

Where **RE \geq 1G**: Radiated Emission above 1GHz & Bandedge Measurement
RE $<$ 1G: Radiated Emission below 1GHz
PLC: Power Line Conducted Emission
APCM: Antenna Port Conducted Measurement

NOTE: The EUT had been pre-tested on the positioned of each 3 axis. The worst case was found when positioned on **X-plane**.

Radiated Emission Test (Above 1GHz):

- Pre-Scan has been conducted to determine the worst-case mode from all possible combinations between available modulations, data rates and antenna ports (if EUT with antenna diversity architecture).
- Following channel(s) was (were) selected for the final test as listed below.

MODE	AVAILABLE CHANNEL	TESTED CHANNEL	MODULATION TECHNOLOGY	MODULATION TYPE	DATA RATE (Mbps)
802.11b	1 to 11	1, 6, 11	DSSS	DBPSK	1
802.11g	1 to 11	1, 6, 11	OFDM	BPSK	6
802.11n (HT20)	1 to 11	1, 6, 11	OFDM	BPSK	6.5

Radiated Emission Test (Below 1GHz):

- Pre-Scan has been conducted to determine the worst-case mode from all possible combinations between available modulations, data rates and antenna ports (if EUT with antenna diversity architecture).
- Following channel(s) was (were) selected for the final test as listed below.

MODE	AVAILABLE CHANNEL	TESTED CHANNEL	MODULATION TECHNOLOGY	MODULATION TYPE	DATA RATE (Mbps)
802.11g	1 to 11	11	OFDM	BPSK	6

Power Line Conducted Emission Test:

- Pre-Scan has been conducted to determine the worst-case mode from all possible combinations between available modulations, data rates and antenna ports (if EUT with antenna diversity architecture).
- Following channel(s) was (were) selected for the final test as listed below.

MODE	AVAILABLE CHANNEL	TESTED CHANNEL	MODULATION TECHNOLOGY	MODULATION TYPE	DATA RATE (Mbps)
802.11g	1 to 11	11	OFDM	BPSK	6

Antenna Port Conducted Measurement:

- This item includes all test value of each mode, but only includes spectrum plot of worst value of each mode.
- Pre-Scan has been conducted to determine the worst-case mode from all possible combinations between available modulations, data rates and antenna ports (if EUT with antenna diversity architecture).
- Following channel(s) was (were) selected for the final test as listed below.

MODE	AVAILABLE CHANNEL	TESTED CHANNEL	MODULATION TECHNOLOGY	MODULATION TYPE	DATA RATE (Mbps)
802.11b	1 to 11	1, 6, 11	DSSS	DBPSK	1
802.11g	1 to 11	1, 6, 11	OFDM	BPSK	6
802.11n (HT20)	1 to 11	1, 6, 11	OFDM	BPSK	6.5

Test Condition:

APPLICABLE TO	ENVIRONMENTAL CONDITIONS	INPUT POWER (system)	TESTED BY
RE \geq 1G	24deg. C, 69%RH	120Vac, 60Hz	Rey Chen
RE<1G	23deg. C, 70%RH	120Vac, 60Hz	Rey Chen
PLC	25deg. C, 75%RH	120Vac, 60Hz	Andy Ho
APCM	23deg. C, 66%RH	120Vac, 60Hz	Anderson Chen

3.3 Duty Cycle of Test Signal

Duty cycle of test signal is 100 %, duty factor is not required.

802.11b

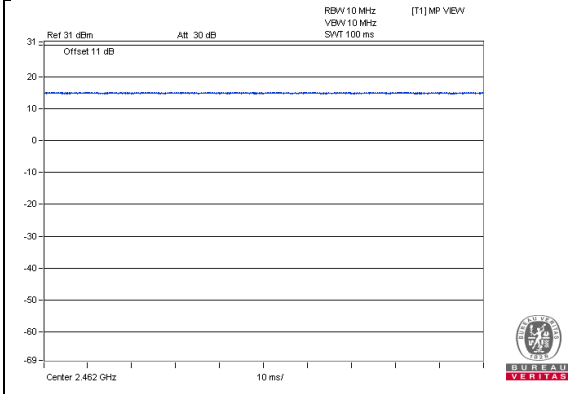

802.11g

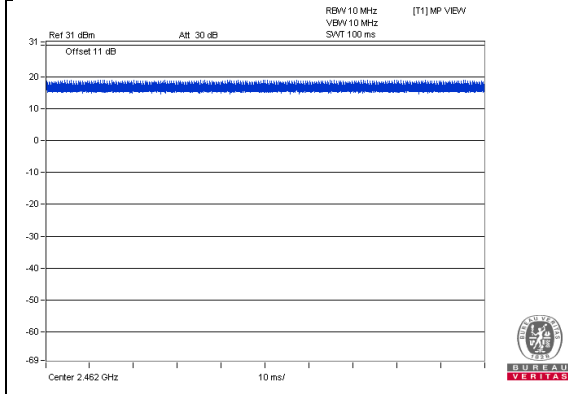

802.11n (HT20)

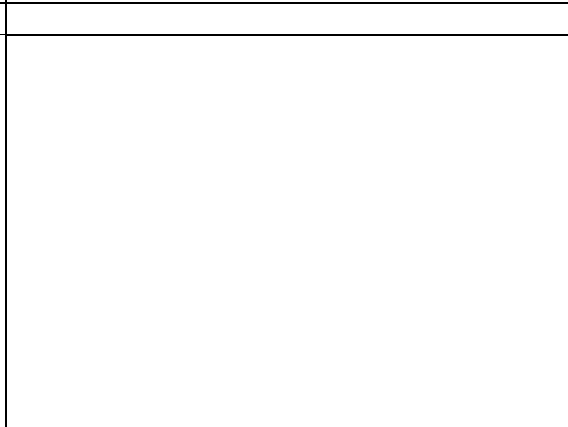
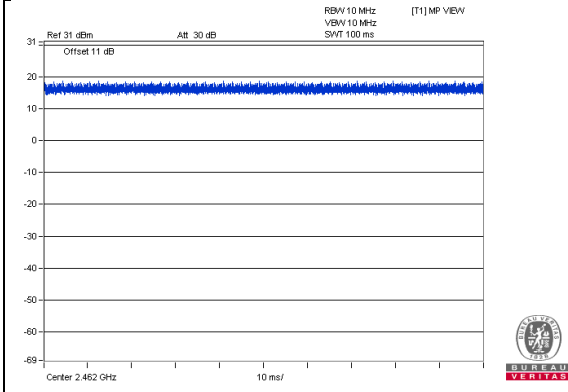

3.4 Description of Support Units

The EUT has been tested as an independent unit together with other necessary accessories or support units. The following support units or accessories were used to form a representative test configuration during the tests.

ID	Product	Brand	Model No.	Serial No.	FCC ID	Remarks
A.	micro SD card Sandisk 2G	NA	NA	NA	NA	Provided by Lab
B.	USB Adapter	ASUS	EXA1205UA	NA	NA	Provided by Lab
C.	Laptop	DELL	E5440	6FC7F12	FCC DoC	Provided by Lab

Note:

1. All power cords of the above support units are non-shielded (1.8m).

ID	Descriptions	Qty.	Length (m)	Shielding (Yes/No)	Cores (Qty.)	Remarks
1.	Micro USB Cable	1	1	Yes	0	Supplied by client

3.4.1 Configuration of System under Test

Mode 1:

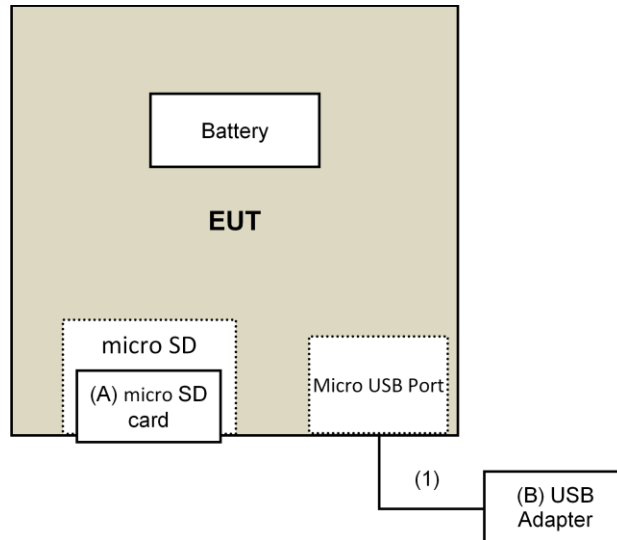

Mode 2:

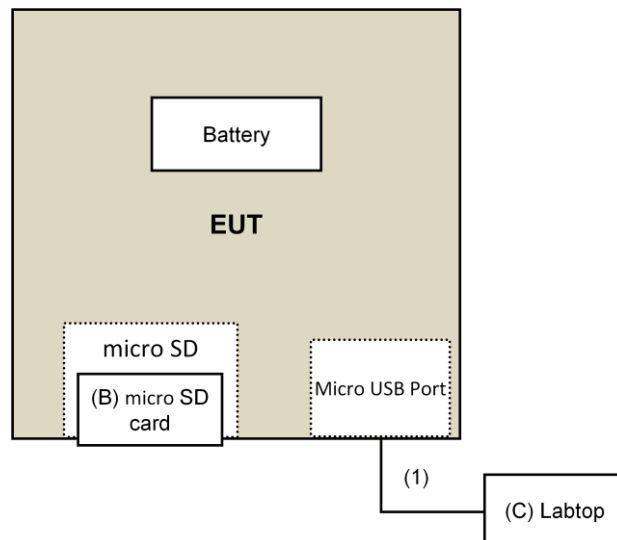

3.5 General Description of Applied Standards

The EUT is a RF Product. According to the specifications of the manufacturer, it must comply with the requirements of the following standards:

FCC Part 15, Subpart C (15.247)
KDB 558074 D01 DTS Meas Guidance v04
ANSI C63.10-2013

All test items have been performed and recorded as per the above standards.

NOTE: The EUT has been verified to comply with the requirements of FCC Part 15, Subpart B, Class B (DoC). The test report has been issued separately.

4 Test Types and Results

4.1 Radiated Emission and Bandedge Measurement

4.1.1 Limits of Radiated Emission and Bandedge Measurement

Radiated emissions which fall in the restricted bands must comply with the radiated emission limits specified as below table. Other emissions shall be at least 20dB below the highest level of the desired power:

Frequencies (MHz)	Field Strength (microvolts/meter)	Measurement Distance (meters)
0.009 ~ 0.490	2400/F(kHz)	300
0.490 ~ 1.705	24000/F(kHz)	30
1.705 ~ 30.0	30	30
30 ~ 88	100	3
88 ~ 216	150	3
216 ~ 960	200	3
Above 960	500	3

NOTE:

1. The lower limit shall apply at the transition frequencies.
2. Emission level (dBuV/m) = 20 log Emission level (uV/m).
3. For frequencies above 1000MHz, the field strength limits are based on average detector, however, the peak field strength of any emission shall not exceed the maximum permitted average limits, specified above by more than 20dB under any condition of modulation.

4.1.2 Test Instruments

DESCRIPTION & MANUFACTURER	MODEL NO.	SERIAL NO.	CALIBRATED DATE	CALIBRATED UNTIL
Test Receiver Keysight	N9038A	MY54450088	July 20, 2016	July 19, 2017
Pre-Amplifier ^(*) EMCI	EMC001340	980142	Jan. 20, 2016	Jan. 19, 2018
Loop Antenna ^(*) Electro-Metrics	EM-6879	264	Dec. 16, 2016	Dec. 15, 2018
RF Cable	NA	LOOPCAB-001 LOOPCAB-002	Jan. 17, 2017	Jan. 16, 2018
Pre-Amplifier Mini-Circuits	ZFL-1000VH2B	AMP-ZFL-01	Nov. 10, 2016	Nov. 09, 2017
Trilog Broadband Antenna SCHWARZBECK	VULB 9168	9168-406	Dec. 13, 2016	Dec. 12, 2017
RF Cable	8D	966-4-1 966-4-2 966-4-3	Apr. 01, 2017	Mar. 31, 2018
Fixed attenuator Mini-Circuits	UNAT-5+	PAD-3m-4-01	Oct. 05, 2016	Oct. 04, 2017
Horn_Antenna SCHWARZBECK	BBHA 9120D	9120D-783	Dec. 27, 2016	Dec. 26, 2017
Pre-Amplifier EMCI	EMC12630SE	980385	Feb. 02, 2017	Feb. 01, 2018
RF Cable	EMC104-SM-SM-1200 EMC104-SM-SM-2000 EMC104-SM-SM-5000	160923 150318 150321	Feb. 02, 2017 Mar. 29, 2017 Mar. 29, 2017	Feb. 01, 2018 Mar. 28, 2018 Mar. 28, 2018
Pre-Amplifier EMCI	EMC184045SE	980387	Feb. 02, 2017	Feb. 01, 2018
Horn_Antenna SCHWARZBECK	BBHA 9170	BBHA9170608	Dec. 15, 2016	Dec. 14, 2017
RF Cable	SUCOFLEX 102	36432/2 36433/2	Jan. 15, 2017	Jan. 14, 2018
Software	ADT_Radiated_V8.7.08	NA	NA	NA
Antenna Tower & Turn Table Max-Full	MF-7802	MF780208410	NA	NA
Boresight Antenna Fixture	FBA-01	FBA-SIP02	NA	NA
Spectrum Analyzer R&S	FSv40	100964	June 28, 2016	June 27, 2017
Power meter Anritsu	ML2495A	1014008	May 11, 2017	May 10, 2018
Power sensor Anritsu	MA2411B	0917122	May 11, 2017	May 10, 2018

Note:

1. The calibration interval of the above test instruments is 12 months and the calibrations are traceable to NML/ROC and NIST/USA.
2. *The calibration interval of the above test instruments is 24 months and the calibrations are traceable to NML/ROC and NIST/USA.
3. The test was performed in 966 Chamber No. 4.
4. The FCC Site Registration No. is 292998
5. The CANADA Site Registration No. is 20331-2
- 6 Loop antenna was used for all emissions below 30 MHz.
7. Tested Date: June 07, 2017

4.1.3 Test Procedures

For Radiated emission below 30MHz

- a. The EUT was placed on the top of a rotating table 0.8 meters above the ground at a 3 meter chamber room. The table was rotated 360 degrees to determine the position of the highest radiation.
- b. The EUT was set 3 meters away from the interference-receiving antenna, which was mounted on the top of a variable-height antenna tower.
- c. Both X and Y axes of the antenna are set to make the measurement.
- d. For each suspected emission, the EUT was arranged to its worst case and the rotatable table was turned from 0 degrees to 360 degrees to find the maximum reading.
- e. The test-receiver system was set to Quasi-Peak Detect Function and Specified Bandwidth with Maximum Hold Mode.

NOTE:

1. The resolution bandwidth and video bandwidth of test receiver/spectrum analyzer is 9kHz at frequency below 30MHz.

For Radiated emission above 30MHz

- a. The EUT was placed on the top of a rotating table 0.8 meters (for 30MHz ~ 1GHz) / 1.5 meters (for above 1GHz) above the ground at 3 meter chamber room for test. The table was rotated 360 degrees to determine the position of the highest radiation.
- b. The EUT was set 3 meters away from the interference-receiving antenna, which was mounted on the top of a variable-height antenna tower.
- c. The height of antenna is varied from one meter to four meters above the ground to determine the maximum value of the field strength. Both horizontal and vertical polarizations of the antenna are set to make the measurement.
- d. For each suspected emission, the EUT was arranged to its worst case and then the antenna was tuned to heights from 1 meter to 4 meters and the rotatable table was turned from 0 degrees to 360 degrees to find the maximum reading.
- e. The test-receiver system was set to quasi-peak detect function and specified bandwidth with maximum hold mode when the test frequency is below 1 GHz.
- f. The test-receiver system was set to peak and average detect function and specified bandwidth with maximum hold mode when the test frequency is above 1 GHz. If the peak reading value also meets average limit, measurement with the average detector is unnecessary.

Note:

1. The resolution bandwidth and video bandwidth of test receiver/spectrum analyzer is 120kHz for Quasi-peak detection (QP) at frequency below 1GHz.
2. The resolution bandwidth of test receiver/spectrum analyzer is 1 MHz and the video bandwidth is 3 MHz for Peak detection (PK) at frequency above 1GHz.
3. The resolution bandwidth of test receiver/spectrum analyzer is 1 MHz and the video bandwidth is 3 MHz for Average detection (AV) at frequency above 1GHz. If duty cycle of test signal is < 98%, the duty factor need added to measured value.
4. All modes of operation were investigated and the worst-case emissions are reported.

4.1.4 Deviation from Test Standard

No deviation.

4.1.5 Test Setup

For Radiated emission below 30MHz

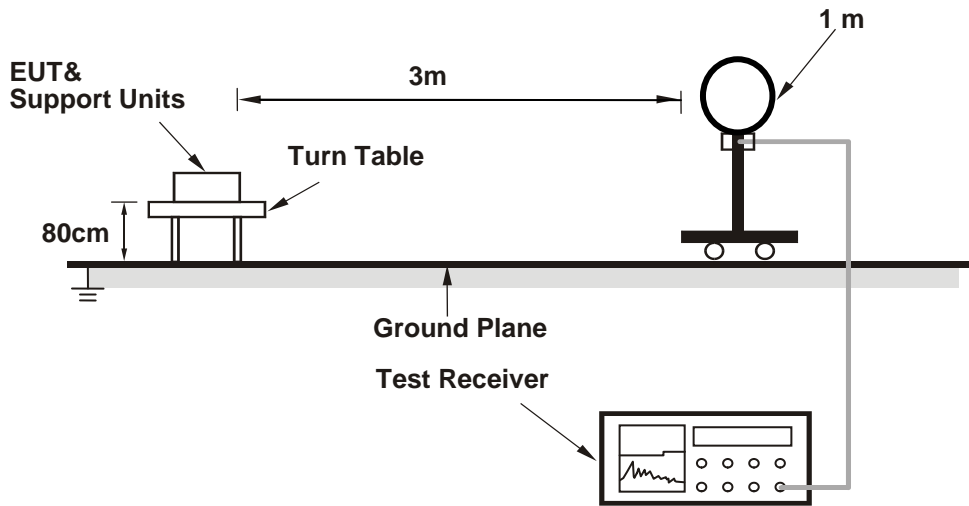

For Radiated emission 30MHz to 1GHz

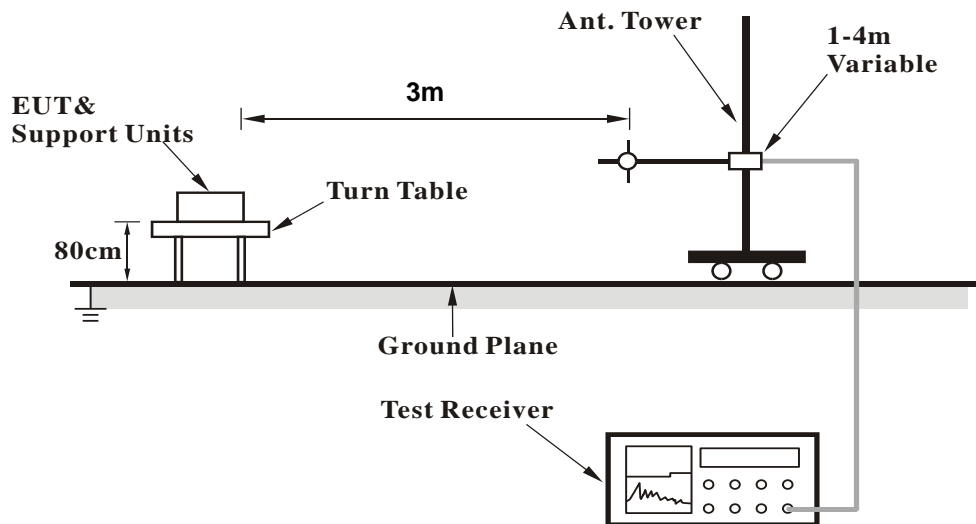

For Radiated emission above 1GHz

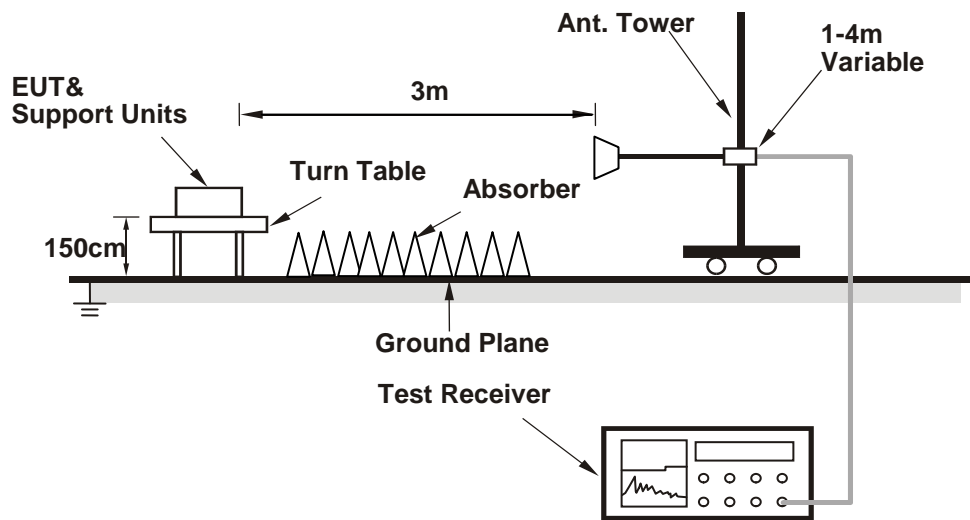

For the actual test configuration, please refer to the attached file (Test Setup Photo).

4.1.6 EUT Operating Conditions

- a. Controlling software (1Tx WiFi Mp command) has been activated to set the EUT on specific status.

4.1.7 Test Results

Above 1GHz Data :

802.11b

CHANNEL	TX Channel 1	DETECTOR FUNCTION	Peak (PK)
FREQUENCY RANGE	1GHz ~ 25GHz		Average (AV)

ANTENNA POLARITY & TEST DISTANCE: HORIZONTAL AT 3 M

NO.	FREQ. (MHz)	EMISSION LEVEL (dBuV/m)	LIMIT (dBuV/m)	MARGIN (dB)	ANTENNA HEIGHT (m)	TABLE ANGLE (Degree)	RAW VALUE (dBuV)	CORRECTION FACTOR (dB/m)
1	2390.00	53.3 PK	74.0	-20.7	2.22 H	208	55.4	-2.1
2	2390.00	43.2 AV	54.0	-10.8	2.22 H	208	45.3	-2.1
3	*2412.00	106.9 PK			2.20 H	218	108.9	-2.0
4	*2412.00	101.6 AV			2.20 H	218	103.6	-2.0
5	4824.00	52.8 PK	74.0	-21.2	1.23 H	304	50.6	2.2
6	4824.00	48.0 AV	54.0	-6.0	1.23 H	304	45.8	2.2

ANTENNA POLARITY & TEST DISTANCE: VERTICAL AT 3 M

NO.	FREQ. (MHz)	EMISSION LEVEL (dBuV/m)	LIMIT (dBuV/m)	MARGIN (dB)	ANTENNA HEIGHT (m)	TABLE ANGLE (Degree)	RAW VALUE (dBuV)	CORRECTION FACTOR (dB/m)
1	2390.00	51.3 PK	74.0	-22.7	2.19 V	85	53.4	-2.1
2	2390.00	41.4 AV	54.0	-12.6	2.19 V	85	43.5	-2.1
3	*2412.00	100.4 PK			2.17 V	93	102.4	-2.0
4	*2412.00	97.4 AV			2.17 V	93	99.4	-2.0
5	4824.00	56.4 PK	74.0	-17.6	1.65 V	354	54.2	2.2
6	4824.00	53.8 AV	54.0	-0.2	1.65 V	354	51.6	2.2

REMARKS:

1. Emission Level(dBuV/m) = Raw Value(dBuV) + Correction Factor(dB/m)
2. Correction Factor(dB/m) = Antenna Factor(dB/m) + Cable Factor(dB) – Pre-Amplifier Factor(dB)
3. The other emission levels were very low against the limit.
4. Margin value = Emission Level – Limit value
5. " * ": Fundamental frequency.

CHANNEL	TX Channel 6	DETECTOR FUNCTION	Peak (PK)
FREQUENCY RANGE	1GHz ~ 25GHz		Average (AV)

ANTENNA POLARITY & TEST DISTANCE: HORIZONTAL AT 3 M

NO.	FREQ. (MHz)	EMISSION LEVEL (dBuV/m)	LIMIT (dBuV/m)	MARGIN (dB)	ANTENNA HEIGHT (m)	TABLE ANGLE (Degree)	RAW VALUE (dBuV)	CORRECTION FACTOR (dB/m)
1	*2437.00	108.9 PK			2.12 H	234	110.9	-2.0
2	*2437.00	104.1 AV			2.12 H	234	106.1	-2.0
3	4874.00	52.3 PK	74.0	-21.7	1.09 H	314	50.0	2.3
4	4874.00	48.6 AV	54.0	-5.4	1.09 H	314	46.3	2.3
5	7311.00	58.6 PK	74.0	-15.4	2.15 H	102	50.0	8.6
6	7311.00	46.0 AV	54.0	-8.0	2.15 H	102	37.4	8.6

ANTENNA POLARITY & TEST DISTANCE: VERTICAL AT 3 M

NO.	FREQ. (MHz)	EMISSION LEVEL (dBuV/m)	LIMIT (dBuV/m)	MARGIN (dB)	ANTENNA HEIGHT (m)	TABLE ANGLE (Degree)	RAW VALUE (dBuV)	CORRECTION FACTOR (dB/m)
1	*2437.00	101.9 PK			2.20 V	113	103.9	-2.0
2	*2437.00	98.9 AV			2.20 V	113	100.9	-2.0
3	4874.00	57.4 PK	74.0	-16.6	1.61 V	199	55.1	2.3
4	4874.00	53.5 AV	54.0	-0.5	1.61 V	199	51.2	2.3
5	7311.00	57.3 PK	74.0	-16.7	1.52 V	191	48.7	8.6
6	7311.00	45.0 AV	54.0	-9.0	1.52 V	191	36.4	8.6

REMARKS:

1. Emission Level(dBuV/m) = Raw Value(dBuV) + Correction Factor(dB/m)
2. Correction Factor(dB/m) = Antenna Factor(dB/m) + Cable Factor(dB) – Pre-Amplifier Factor(dB)
3. The other emission levels were very low against the limit.
4. Margin value = Emission Level – Limit value
5. " * ": Fundamental frequency.

CHANNEL	TX Channel 11	DETECTOR FUNCTION	Peak (PK)
FREQUENCY RANGE	1GHz ~ 25GHz		Average (AV)

ANTENNA POLARITY & TEST DISTANCE: HORIZONTAL AT 3 M

NO.	FREQ. (MHz)	EMISSION LEVEL (dBuV/m)	LIMIT (dBuV/m)	MARGIN (dB)	ANTENNA HEIGHT (m)	TABLE ANGLE (Degree)	RAW VALUE (dBuV)	CORRECTION FACTOR (dB/m)
1	*2462.00	107.8 PK			2.19 H	210	109.7	-1.9
2	*2462.00	102.7 AV			2.19 H	210	104.6	-1.9
3	2483.50	56.9 PK	74.0	-17.1	2.13 H	214	58.7	-1.8
4	2483.50	43.6 AV	54.0	-10.4	2.13 H	214	45.4	-1.8
5	4924.00	51.8 PK	74.0	-22.2	1.05 H	295	49.3	2.5
6	4924.00	48.4 AV	54.0	-5.6	1.05 H	295	45.9	2.5
7	7386.00	58.9 PK	74.0	-15.1	2.22 H	85	50.3	8.6
8	7386.00	45.9 AV	54.0	-8.1	2.22 H	85	37.3	8.6

ANTENNA POLARITY & TEST DISTANCE: VERTICAL AT 3 M

NO.	FREQ. (MHz)	EMISSION LEVEL (dBuV/m)	LIMIT (dBuV/m)	MARGIN (dB)	ANTENNA HEIGHT (m)	TABLE ANGLE (Degree)	RAW VALUE (dBuV)	CORRECTION FACTOR (dB/m)
1	*2462.00	101.4 PK			2.20 V	115	103.3	-1.9
2	*2462.00	98.8 AV			2.20 V	115	100.7	-1.9
3	2483.50	50.3 PK	74.0	-23.7	2.19 V	104	52.1	-1.8
4	2483.50	39.2 AV	54.0	-14.8	2.19 V	104	41.0	-1.8
5	4924.00	56.6 PK	74.0	-17.4	1.75 V	156	54.1	2.5
6	4924.00	53.7 AV	54.0	-0.3	1.75 V	156	51.2	2.5
7	7386.00	59.7 PK	74.0	-14.3	1.72 V	165	51.1	8.6
8	7386.00	46.4 AV	54.0	-7.6	1.72 V	165	37.8	8.6

REMARKS:

1. Emission Level(dBuV/m) = Raw Value(dBuV) + Correction Factor(dB/m)
2. Correction Factor(dB/m) = Antenna Factor(dB/m) + Cable Factor(dB) – Pre-Amplifier Factor(dB)
3. The other emission levels were very low against the limit.
4. Margin value = Emission Level – Limit value
5. " * ": Fundamental frequency.

802.11g

CHANNEL	TX Channel 1	DETECTOR FUNCTION	Peak (PK)
FREQUENCY RANGE	1GHz ~ 25GHz		Average (AV)

ANTENNA POLARITY & TEST DISTANCE: HORIZONTAL AT 3 M

NO.	FREQ. (MHz)	EMISSION LEVEL (dBuV/m)	LIMIT (dBuV/m)	MARGIN (dB)	ANTENNA HEIGHT (m)	TABLE ANGLE (Degree)	RAW VALUE (dBuV)	CORRECTION FACTOR (dB/m)
1	2390.00	72.8 PK	74.0	-1.2	1.85 H	161	74.9	-2.1
2	2390.00	50.7 AV	54.0	-3.3	1.85 H	161	52.8	-2.1
3	*2412.00	107.6 PK			1.84 H	175	109.6	-2.0
4	*2412.00	97.3 AV			1.84 H	175	99.3	-2.0
5	4824.00	52.0 PK	74.0	-22.0	1.05 H	282	49.8	2.2
6	4824.00	48.6 AV	54.0	-5.4	1.05 H	282	46.4	2.2

ANTENNA POLARITY & TEST DISTANCE: VERTICAL AT 3 M

NO.	FREQ. (MHz)	EMISSION LEVEL (dBuV/m)	LIMIT (dBuV/m)	MARGIN (dB)	ANTENNA HEIGHT (m)	TABLE ANGLE (Degree)	RAW VALUE (dBuV)	CORRECTION FACTOR (dB/m)
1	2390.00	71.6 PK	74.0	-2.4	2.09 V	95	73.7	-2.1
2	2390.00	50.1 AV	54.0	-3.9	2.09 V	95	52.2	-2.1
3	*2412.00	104.1 PK			2.13 V	91	106.1	-2.0
4	*2412.00	93.8 AV			2.13 V	91	95.8	-2.0
5	4824.00	51.1 PK	74.0	-22.9	1.69 V	160	48.9	2.2
6	4824.00	47.9 AV	54.0	-6.1	1.69 V	160	45.7	2.2

REMARKS:

1. Emission Level(dBuV/m) = Raw Value(dBuV) + Correction Factor(dB/m)
2. Correction Factor(dB/m) = Antenna Factor(dB/m) + Cable Factor(dB) – Pre-Amplifier Factor(dB)
3. The other emission levels were very low against the limit.
4. Margin value = Emission Level – Limit value
5. " * ": Fundamental frequency.

CHANNEL	TX Channel 6	DETECTOR FUNCTION	Peak (PK)
FREQUENCY RANGE	1GHz ~ 25GHz		Average (AV)

ANTENNA POLARITY & TEST DISTANCE: HORIZONTAL AT 3 M

NO.	FREQ. (MHz)	EMISSION LEVEL (dBuV/m)	LIMIT (dBuV/m)	MARGIN (dB)	ANTENNA HEIGHT (m)	TABLE ANGLE (Degree)	RAW VALUE (dBuV)	CORRECTION FACTOR (dB/m)
1	2390.00	58.7 PK	74.0	-15.3	1.90 H	146	60.8	-2.1
2	2390.00	46.0 AV	54.0	-8.0	1.90 H	146	48.1	-2.1
3	*2437.00	110.0 PK			1.92 H	144	112.0	-2.0
4	*2437.00	100.9 AV			1.92 H	144	102.9	-2.0
5	2483.50	61.7 PK	74.0	-12.3	1.90 H	164	63.5	-1.8
6	2483.50	47.1 AV	54.0	-6.9	1.90 H	164	48.9	-1.8
7	4874.00	51.9 PK	74.0	-22.1	1.03 H	328	49.6	2.3
8	4874.00	48.8 AV	54.0	-5.2	1.03 H	328	46.5	2.3
9	7311.00	58.0 PK	74.0	-16.0	2.18 H	114	49.4	8.6
10	7311.00	45.7 AV	54.0	-8.3	2.18 H	114	37.1	8.6

ANTENNA POLARITY & TEST DISTANCE: VERTICAL AT 3 M

NO.	FREQ. (MHz)	EMISSION LEVEL (dBuV/m)	LIMIT (dBuV/m)	MARGIN (dB)	ANTENNA HEIGHT (m)	TABLE ANGLE (Degree)	RAW VALUE (dBuV)	CORRECTION FACTOR (dB/m)
1	2390.00	56.0 PK	74.0	-18.0	1.81 V	112	58.1	-2.1
2	2390.00	43.2 AV	54.0	-10.8	1.81 V	112	45.3	-2.1
3	*2437.00	107.6 PK			1.93 V	104	109.6	-2.0
4	*2437.00	97.8 AV			1.93 V	104	99.8	-2.0
5	2483.50	58.4 PK	74.0	-15.6	1.81 V	88	60.2	-1.8
6	2483.50	44.2 AV	54.0	-9.8	1.81 V	88	46.0	-1.8
7	4874.00	50.9 PK	74.0	-23.1	1.59 V	145	48.6	2.3
8	4874.00	47.7 AV	54.0	-6.3	1.59 V	145	45.4	2.3
9	7311.00	58.8 PK	74.0	-15.2	1.74 V	178	50.2	8.6
10	7311.00	46.2 AV	54.0	-7.8	1.74 V	178	37.6	8.6

REMARKS:

1. Emission Level(dBuV/m) = Raw Value(dBuV) + Correction Factor(dB/m)
2. Correction Factor(dB/m) = Antenna Factor(dB/m) + Cable Factor(dB) – Pre-Amplifier Factor(dB)
3. The other emission levels were very low against the limit.
4. Margin value = Emission Level – Limit value
5. " * ": Fundamental frequency.

CHANNEL	TX Channel 11	DETECTOR FUNCTION	Peak (PK)
FREQUENCY RANGE	1GHz ~ 25GHz		Average (AV)

ANTENNA POLARITY & TEST DISTANCE: HORIZONTAL AT 3 M

NO.	FREQ. (MHz)	EMISSION LEVEL (dBuV/m)	LIMIT (dBuV/m)	MARGIN (dB)	ANTENNA HEIGHT (m)	TABLE ANGLE (Degree)	RAW VALUE (dBuV)	CORRECTION FACTOR (dB/m)
1	*2462.00	107.2 PK			1.95 H	149	109.1	-1.9
2	*2462.00	96.6 AV			1.95 H	149	98.5	-1.9
3	2483.50	73.2 PK	74.0	-0.8	1.92 H	148	75.0	-1.8
4	2483.50	52.9 AV	54.0	-1.1	1.92 H	148	54.7	-1.8
5	4924.00	53.3 PK	74.0	-20.7	1.00 H	279	50.8	2.5
6	4924.00	49.5 AV	54.0	-4.5	1.00 H	279	47.0	2.5
7	7386.00	58.1 PK	74.0	-15.9	2.20 H	97	49.5	8.6
8	7386.00	45.0 AV	54.0	-9.0	2.20 H	97	36.4	8.6

ANTENNA POLARITY & TEST DISTANCE: VERTICAL AT 3 M

NO.	FREQ. (MHz)	EMISSION LEVEL (dBuV/m)	LIMIT (dBuV/m)	MARGIN (dB)	ANTENNA HEIGHT (m)	TABLE ANGLE (Degree)	RAW VALUE (dBuV)	CORRECTION FACTOR (dB/m)
1	*2462.00	103.6 PK			1.99 V	116	105.5	-1.9
2	*2462.00	93.7 AV			1.99 V	116	95.6	-1.9
3	2483.50	71.7 PK	74.0	-2.3	2.05 V	110	73.5	-1.8
4	2483.50	50.5 AV	54.0	-3.5	2.05 V	110	52.3	-1.8
5	4924.00	51.2 PK	74.0	-22.8	1.57 V	128	48.7	2.5
6	4924.00	47.6 AV	54.0	-6.4	1.57 V	128	45.1	2.5
7	7386.00	58.6 PK	74.0	-15.4	1.69 V	177	50.0	8.6
8	7386.00	45.6 AV	54.0	-8.4	1.69 V	177	37.0	8.6

REMARKS:

1. Emission Level(dBuV/m) = Raw Value(dBuV) + Correction Factor(dB/m)
2. Correction Factor(dB/m) = Antenna Factor(dB/m) + Cable Factor(dB) – Pre-Amplifier Factor(dB)
3. The other emission levels were very low against the limit.
4. Margin value = Emission Level – Limit value
5. " * ": Fundamental frequency.

802.11n (HT20)

CHANNEL	TX Channel 1	DETECTOR FUNCTION	Peak (PK)
FREQUENCY RANGE	1GHz ~ 25GHz		Average (AV)

ANTENNA POLARITY & TEST DISTANCE: HORIZONTAL AT 3 M

NO.	FREQ. (MHz)	EMISSION LEVEL (dBuV/m)	LIMIT (dBuV/m)	MARGIN (dB)	ANTENNA HEIGHT (m)	TABLE ANGLE (Degree)	RAW VALUE (dBuV)	CORRECTION FACTOR (dB/m)
1	2390.00	73.5 PK	74.0	-0.5	1.70 H	155	75.6	-2.1
2	2390.00	49.6 AV	54.0	-4.4	1.70 H	155	51.7	-2.1
3	*2412.00	105.7 PK			1.76 H	159	107.7	-2.0
4	*2412.00	96.2 AV			1.76 H	159	98.2	-2.0
5	4824.00	52.2 PK	74.0	-21.8	1.05 H	293	50.0	2.2
6	4824.00	48.7 AV	54.0	-5.3	1.05 H	293	46.5	2.2

ANTENNA POLARITY & TEST DISTANCE: VERTICAL AT 3 M

NO.	FREQ. (MHz)	EMISSION LEVEL (dBuV/m)	LIMIT (dBuV/m)	MARGIN (dB)	ANTENNA HEIGHT (m)	TABLE ANGLE (Degree)	RAW VALUE (dBuV)	CORRECTION FACTOR (dB/m)
1	2390.00	72.5 PK	74.0	-1.5	1.92 V	128	74.6	-2.1
2	2390.00	48.5 AV	54.0	-5.5	1.92 V	128	50.6	-2.1
3	*2412.00	103.5 PK			1.98 V	115	105.5	-2.0
4	*2412.00	94.0 AV			1.98 V	115	96.0	-2.0
5	4824.00	51.6 PK	74.0	-22.4	1.60 V	151	49.4	2.2
6	4824.00	48.0 AV	54.0	-6.0	1.60 V	151	45.8	2.2

REMARKS:

1. Emission Level(dBuV/m) = Raw Value(dBuV) + Correction Factor(dB/m)
2. Correction Factor(dB/m) = Antenna Factor(dB/m) + Cable Factor(dB) – Pre-Amplifier Factor(dB)
3. The other emission levels were very low against the limit.
4. Margin value = Emission Level – Limit value
5. " * ": Fundamental frequency.

CHANNEL	TX Channel 6	DETECTOR FUNCTION	Peak (PK)
FREQUENCY RANGE	1GHz ~ 25GHz		Average (AV)

ANTENNA POLARITY & TEST DISTANCE: HORIZONTAL AT 3 M

NO.	FREQ. (MHz)	EMISSION LEVEL (dBuV/m)	LIMIT (dBuV/m)	MARGIN (dB)	ANTENNA HEIGHT (m)	TABLE ANGLE (Degree)	RAW VALUE (dBuV)	CORRECTION FACTOR (dB/m)
1	2390.00	61.9 PK	74.0	-12.1	1.80 H	168	64.0	-2.1
2	2390.00	47.9 AV	54.0	-6.1	1.80 H	168	50.0	-2.1
3	*2437.00	110.2 PK			1.82 H	155	112.2	-2.0
4	*2437.00	101.2 AV			1.82 H	155	103.2	-2.0
5	2483.50	65.2 PK	74.0	-8.8	1.80 H	144	67.0	-1.8
6	2483.50	48.9 AV	54.0	-5.1	1.80 H	144	50.7	-1.8
7	4874.00	51.4 PK	74.0	-22.6	1.12 H	315	49.1	2.3
8	4874.00	48.1 AV	54.0	-5.9	1.12 H	315	45.8	2.3
9	7311.00	58.5 PK	74.0	-15.5	2.25 H	82	49.9	8.6
10	7311.00	45.8 AV	54.0	-8.2	2.25 H	82	37.2	8.6

ANTENNA POLARITY & TEST DISTANCE: VERTICAL AT 3 M

NO.	FREQ. (MHz)	EMISSION LEVEL (dBuV/m)	LIMIT (dBuV/m)	MARGIN (dB)	ANTENNA HEIGHT (m)	TABLE ANGLE (Degree)	RAW VALUE (dBuV)	CORRECTION FACTOR (dB/m)
1	2390.00	60.6 PK	74.0	-13.4	2.05 V	96	62.7	-2.1
2	2390.00	46.4 AV	54.0	-7.6	2.05 V	96	48.5	-2.1
3	*2437.00	108.3 PK			2.09 V	95	110.3	-2.0
4	*2437.00	99.1 AV			2.09 V	95	101.1	-2.0
5	2483.50	63.8 PK	74.0	-10.2	2.05 V	92	65.6	-1.8
6	2483.50	47.1 AV	54.0	-6.9	2.05 V	92	48.9	-1.8
7	4874.00	51.7 PK	74.0	-22.3	1.58 V	137	49.4	2.3
8	4874.00	48.1 AV	54.0	-5.9	1.58 V	137	45.8	2.3
9	7311.00	58.7 PK	74.0	-15.3	1.69 V	170	50.1	8.6
10	7311.00	45.7 AV	54.0	-8.3	1.69 V	170	37.1	8.6

REMARKS:

1. Emission Level(dBuV/m) = Raw Value(dBuV) + Correction Factor(dB/m)
2. Correction Factor(dB/m) = Antenna Factor(dB/m) + Cable Factor(dB) – Pre-Amplifier Factor(dB)
3. The other emission levels were very low against the limit.
4. Margin value = Emission Level – Limit value
5. " * ": Fundamental frequency.

CHANNEL	TX Channel 11	DETECTOR FUNCTION	Peak (PK)
FREQUENCY RANGE	1GHz ~ 25GHz		Average (AV)

ANTENNA POLARITY & TEST DISTANCE: HORIZONTAL AT 3 M

NO.	FREQ. (MHz)	EMISSION LEVEL (dBuV/m)	LIMIT (dBuV/m)	MARGIN (dB)	ANTENNA HEIGHT (m)	TABLE ANGLE (Degree)	RAW VALUE (dBuV)	CORRECTION FACTOR (dB/m)
1	*2462.00	105.1 PK			1.77 H	149	107.0	-1.9
2	*2462.00	95.8 AV			1.77 H	149	97.7	-1.9
3	2483.50	73.6 PK	74.0	-0.4	1.66 H	143	75.4	-1.8
4	2483.50	49.8 AV	54.0	-4.2	1.66 H	143	51.6	-1.8
5	4924.00	52.0 PK	74.0	-22.0	1.07 H	296	49.5	2.5
6	4924.00	48.8 AV	54.0	-5.2	1.07 H	296	46.3	2.5
7	7386.00	58.4 PK	74.0	-15.6	2.12 H	100	49.8	8.6
8	7386.00	45.4 AV	54.0	-8.6	2.12 H	100	36.8	8.6

ANTENNA POLARITY & TEST DISTANCE: VERTICAL AT 3 M

NO.	FREQ. (MHz)	EMISSION LEVEL (dBuV/m)	LIMIT (dBuV/m)	MARGIN (dB)	ANTENNA HEIGHT (m)	TABLE ANGLE (Degree)	RAW VALUE (dBuV)	CORRECTION FACTOR (dB/m)
1	*2462.00	103.0 PK			2.01 V	109	104.9	-1.9
2	*2462.00	93.5 AV			2.01 V	109	95.4	-1.9
3	2483.50	71.3 PK	74.0	-2.7	2.07 V	124	73.1	-1.8
4	2483.50	47.6 AV	54.0	-6.4	2.07 V	124	49.4	-1.8
5	4924.00	51.2 PK	74.0	-22.8	1.61 V	138	48.7	2.5
6	4924.00	48.5 AV	54.0	-5.5	1.61 V	138	46.0	2.5
7	7386.00	58.8 PK	74.0	-15.2	1.64 V	189	50.2	8.6
8	7386.00	46.0 AV	54.0	-8.0	1.64 V	189	37.4	8.6

REMARKS:

1. Emission Level(dBuV/m) = Raw Value(dBuV) + Correction Factor(dB/m)
2. Correction Factor(dB/m) = Antenna Factor(dB/m) + Cable Factor(dB) – Pre-Amplifier Factor(dB)
3. The other emission levels were very low against the limit.
4. Margin value = Emission Level – Limit value
5. " * ": Fundamental frequency.

Below 1GHz Data:

802.11g

CHANNEL	TX Channel 11	DETECTOR FUNCTION	Quasi-Peak (QP)
FREQUENCY RANGE	9kHz ~ 1GHz		

ANTENNA POLARITY & TEST DISTANCE: HORIZONTAL AT 3 M

NO.	FREQ. (MHz)	EMISSION LEVEL (dBuV/m)	LIMIT (dBuV/m)	MARGIN (dB)	ANTENNA HEIGHT (m)	TABLE ANGLE (Degree)	RAW VALUE (dBuV)	CORRECTION FACTOR (dB/m)
1	31.31	33.2 QP	40.0	-6.8	1.00 H	142	42.7	-9.5
2	62.23	27.2 QP	40.0	-12.8	1.25 H	360	36.2	-9.0
3	158.04	29.1 QP	43.5	-14.4	1.25 H	237	36.8	-7.7
4	458.69	21.8 QP	46.0	-24.2	1.00 H	40	25.3	-3.5
5	703.33	26.7 QP	46.0	-19.3	1.25 H	216	25.8	0.9
6	855.47	27.7 QP	46.0	-18.3	1.00 H	146	24.4	3.3

ANTENNA POLARITY & TEST DISTANCE: VERTICAL AT 3 M

NO.	FREQ. (MHz)	EMISSION LEVEL (dBuV/m)	LIMIT (dBuV/m)	MARGIN (dB)	ANTENNA HEIGHT (m)	TABLE ANGLE (Degree)	RAW VALUE (dBuV)	CORRECTION FACTOR (dB/m)
1	39.00	32.7 QP	40.0	-7.3	1.00 V	355	41.2	-8.5
2	61.06	30.1 QP	40.0	-9.9	1.25 V	124	38.9	-8.8
3	158.36	25.9 QP	43.5	-17.6	1.00 V	43	33.6	-7.7
4	511.92	23.0 QP	46.0	-23.0	1.00 V	154	25.4	-2.4
5	646.10	24.7 QP	46.0	-21.3	1.00 V	69	24.6	0.1
6	772.20	26.6 QP	46.0	-19.4	1.00 V	360	24.4	2.2

REMARKS:

1. Emission Level(dBuV/m) = Raw Value(dBuV) + Correction Factor(dB/m)
2. Correction Factor(dB/m) = Antenna Factor(dB/m) + Cable Factor(dB) – Pre-Amplifier Factor(dB)
3. The other emission levels were very low against the limit.
4. Margin value = Emission Level – Limit value

4.2 Conducted Emission Measurement

4.2.1 Limits of Conducted Emission Measurement

Frequency (MHz)	Conducted Limit (dBuV)	
	Quasi-peak	Average
0.15 - 0.5	66 - 56	56 - 46
0.50 - 5.0	56	46
5.0 - 30.0	60	50

Note: 1. The lower limit shall apply at the transition frequencies.

2. The limit decreases in line with the logarithm of the frequency in the range of 0.15 to 0.50MHz.

4.2.2 Test Instruments

DESCRIPTION & MANUFACTURER	MODEL NO.	SERIAL NO.	CALIBRATED DATE	CALIBRATED UNTIL
Test Receiver R&S	ESCS 30	847124/029	Oct. 24, 2016	Oct. 23, 2017
Line-Impedance Stabilization Network (for EUT) R&S	ESH3-Z5	848773/004	Oct. 26, 2016	Oct. 25, 2017
RF Cable	5D-FB	COCCAB-001	Sep. 30, 2016	Sep. 29, 2017
10 dB PAD Mini-Circuits	HAT-10+	CONATT-004	June 20, 2016	June 19, 2017
Software BVADT	BVADT_Cond_ V7.3.7.4	NA	NA	NA

Note:

1. The calibration interval of the above test instruments are 12 months and the calibrations are traceable to NML/ROC and NIST/USA.
2. The test was performed in Shielded Room No. 1.
- 3 Tested Date: June 08, 2017

4.2.3 Test Procedures

- The EUT was placed 0.4 meters from the conducting wall of the shielded room with EUT being connected to the power mains through a line impedance stabilization network (LISN). Other support units were connected to the power mains through another LISN. The two LISNs provide 50 ohm/ 50uH of coupling impedance for the measuring instrument.
- Both lines of the power mains connected to the EUT were checked for maximum conducted interference.
- The frequency range from 150kHz to 30MHz was searched. Emission levels under (Limit - 20dB) was not recorded.

NOTE: The resolution bandwidth and video bandwidth of test receiver is 9kHz for quasi-peak detection (QP) and average detection (AV) at frequency 0.15MHz-30MHz.

4.2.4 Deviation from Test Standard

No deviation.

4.2.5 Test Setup

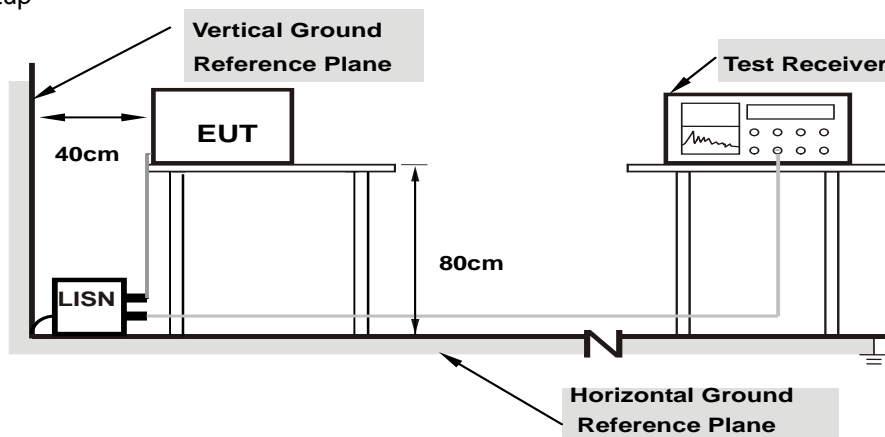

Note: 1.Support units were connected to second LISN.

For the actual test configuration, please refer to the attached file (Test Setup Photo).

4.2.6 EUT Operating Conditions

Same as 4.1.6.

4.2.7 Test Results (Mode 1)

Phase	Line (L)	Detector Function	Quasi-Peak (QP) / Average (AV)
-------	----------	-------------------	--------------------------------

No	Freq. [MHz]	Corr.	Reading Value		Emission Level		Limit		Margin	
		Factor (dB)	[dB (uV)]		[dB (uV)]		[dB (uV)]		(dB)	
	Q.P.	AV.	Q.P.	AV.	Q.P.	AV.	Q.P.	AV.	Q.P.	AV.
1	0.15000	10.20	23.14	5.26	33.34	15.46	66.00	56.00	-32.66	-40.54
2	0.33359	10.23	27.66	13.84	37.89	24.07	59.36	49.36	-21.47	-25.29
3	0.71250	10.27	12.15	-4.38	22.42	5.89	56.00	46.00	-33.58	-40.11
4	3.16406	10.30	8.22	-5.52	18.52	4.78	56.00	46.00	-37.48	-41.22
5	4.35938	10.34	16.18	-0.61	26.52	9.73	56.00	46.00	-29.48	-36.27
6	24.33203	11.76	11.20	-3.35	22.96	8.41	60.00	50.00	-37.04	-41.59

REMARKS:

1. Q.P. and AV. are abbreviations of quasi-peak and average individually.
2. The emission levels of other frequencies were very low against the limit.
3. Margin value = Emission level - Limit value
4. Correction factor = Insertion loss + Cable loss
5. Emission Level = Correction Factor + Reading Value.

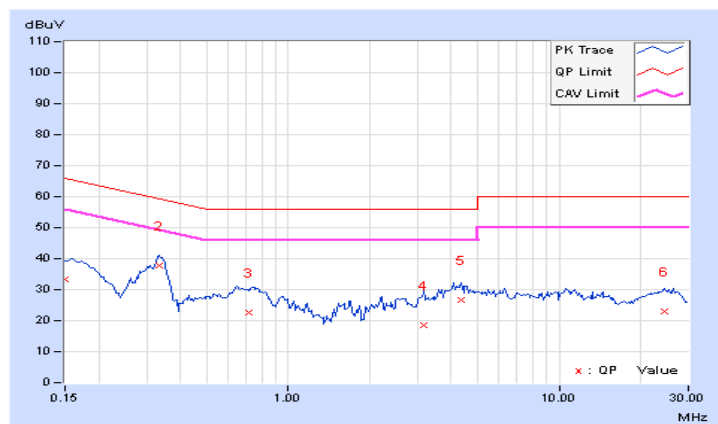

Phase	Neutral (N)	Detector Function	Quasi-Peak (QP) / Average (AV)
-------	-------------	-------------------	--------------------------------

No	Freq. [MHz]	Corr.	Reading Value		Emission Level		Limit		Margin	
		Factor	[dB (uV)]		[dB (uV)]		[dB (uV)]		(dB)	
	(dB)	Q.P.	AV.	Q.P.	AV.	Q.P.	AV.	Q.P.	AV.	
1	0.16172	10.19	27.65	10.78	37.84	20.97	65.38	55.38	-27.54	-34.41
2	0.33359	10.22	21.22	14.48	31.44	24.70	59.36	49.36	-27.92	-24.66
3	0.88828	10.26	10.22	-2.04	20.48	8.22	56.00	46.00	-35.52	-37.78
4	4.28906	10.24	14.60	0.18	24.84	10.42	56.00	46.00	-31.16	-35.58
5	11.52344	10.77	13.75	2.93	24.52	13.70	60.00	50.00	-35.48	-36.30
6	22.73438	11.39	11.09	3.45	22.48	14.84	60.00	50.00	-37.52	-35.16

REMARKS:

1. Q.P. and AV. are abbreviations of quasi-peak and average individually.
2. The emission levels of other frequencies were very low against the limit.
3. Margin value = Emission level - Limit value
4. Correction factor = Insertion loss + Cable loss
5. Emission Level = Correction Factor + Reading Value.

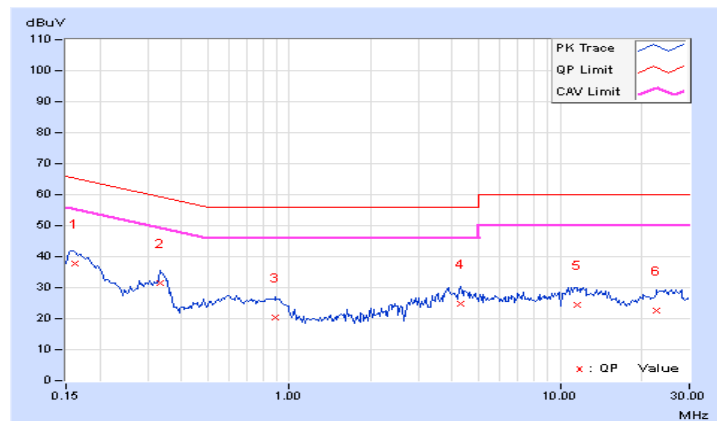

4.2.8 Test Results (Mode 2)

Phase	Line (L)	Detector Function	Quasi-Peak (QP) / Average (AV)
-------	----------	-------------------	--------------------------------

No	Freq. [MHz]	Corr. Factor	Reading Value [dB (uV)]		Emission Level [dB (uV)]		Limit [dB (uV)]		Margin (dB)	
		(dB)	Q.P.	AV.	Q.P.	AV.	Q.P.	AV.	Q.P.	AV.
	1	0.15391	10.19	42.76	29.93	52.95	40.12	65.79	55.79	-12.84
2	0.19297	10.19	36.49	20.54	46.68	30.73	63.91	53.91	-17.23	-23.18
3	0.28672	10.20	29.46	18.08	39.66	28.28	60.62	50.62	-20.96	-22.34
4	0.50000	10.23	29.96	23.33	40.19	33.56	56.00	46.00	-15.81	-12.44
5	2.98438	10.24	23.63	17.31	33.87	27.55	56.00	46.00	-22.13	-18.45
6	10.62500	10.61	24.29	18.78	34.90	29.39	60.00	50.00	-25.10	-20.61

REMARKS:

1. Q.P. and AV. are abbreviations of quasi-peak and average individually.
2. The emission levels of other frequencies were very low against the limit.
3. Margin value = Emission level - Limit value
4. Correction factor = Insertion loss + Cable loss
5. Emission Level = Correction Factor + Reading Value.

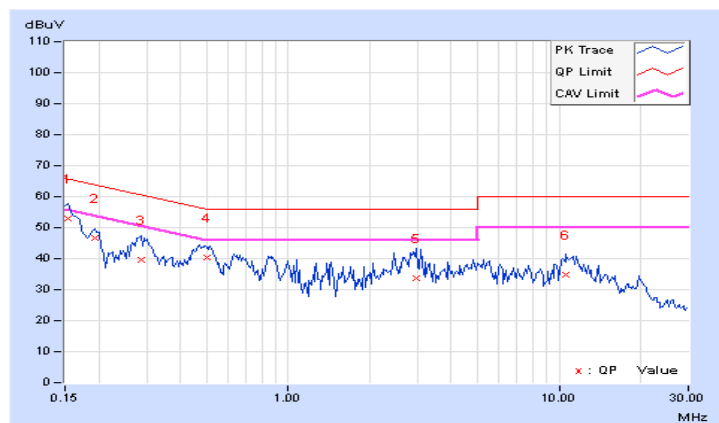

Phase	Neutral (N)	Detector Function	Quasi-Peak (QP) / Average (AV)
-------	-------------	-------------------	--------------------------------

No	Freq. [MHz]	Corr.	Reading Value		Emission Level		Limit		Margin	
		Factor	[dB (uV)]		[dB (uV)]		[dB (uV)]		(dB)	
	(dB)	Q.P.	AV.	Q.P.	AV.	Q.P.	AV.	Q.P.	AV.	
1	0.15000	10.18	41.52	29.48	51.70	39.66	66.00	56.00	-14.30	-16.34
2	0.48594	10.21	30.55	24.44	40.76	34.65	56.24	46.24	-15.48	-11.59
3	0.59531	10.22	27.11	19.21	37.33	29.43	56.00	46.00	-18.67	-16.57
4	0.89609	10.23	23.60	17.76	33.83	27.99	56.00	46.00	-22.17	-18.01
5	2.32031	10.26	23.23	17.52	33.49	27.78	56.00	46.00	-22.51	-18.22
6	17.68359	11.00	19.90	13.21	30.90	24.21	60.00	50.00	-29.10	-25.79

REMARKS:

1. Q.P. and AV. are abbreviations of quasi-peak and average individually.
2. The emission levels of other frequencies were very low against the limit.
3. Margin value = Emission level - Limit value
4. Correction factor = Insertion loss + Cable loss
5. Emission Level = Correction Factor + Reading Value.

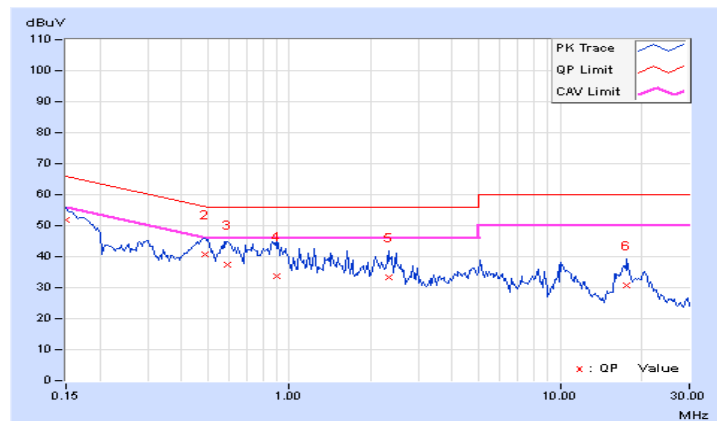

4.3 6dB Bandwidth Measurement

4.3.1 Limits of 6dB Bandwidth Measurement

The minimum of 6dB Bandwidth Measurement is 0.5 MHz.

4.3.2 Test Setup

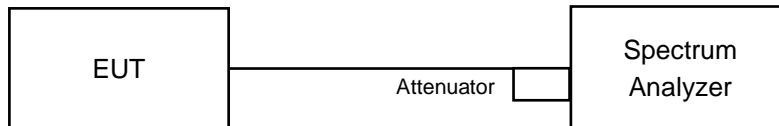

4.3.3 Test Instruments

Refer to section 4.1.2 to get information of above instrument.

4.3.4 Test Procedure

- a. Set resolution bandwidth (RBW) = 100kHz
- b. Set the video bandwidth (VBW) $\geq 3 \times$ RBW, Detector = Peak.
- c. Trace mode = max hold.
- d. Sweep = auto couple.
- e. Measure the maximum width of the emission that is constrained by the frequencies associated with the two amplitude points (upper and lower) that are attenuated by 6 dB relative to the maximum level measured in the fundamental emission

4.3.5 Deviation from Test Standard

No deviation.

4.3.6 EUT Operating Conditions

The software provided by client to enable the EUT under transmission condition continuously at lowest, middle and highest channel frequencies individually.

4.3.7 Test Result

802.11b

Channel	Frequency (MHz)	6dB Bandwidth (MHz)	Minimum Limit (MHz)	Pass / Fail
1	2412	9.09	0.5	Pass
6	2437	9.13	0.5	Pass
11	2462	9.13	0.5	Pass

802.11g

Channel	Frequency (MHz)	6dB Bandwidth (MHz)	Minimum Limit (MHz)	Pass / Fail
1	2412	16.62	0.5	Pass
6	2437	16.62	0.5	Pass
11	2462	16.62	0.5	Pass

802.11n (HT20)

Channel	Frequency (MHz)	6dB Bandwidth (MHz)	Minimum Limit (MHz)	Pass / Fail
1	2412	17.77	0.5	Pass
6	2437	17.75	0.5	Pass
11	2462	17.76	0.5	Pass

Spectrum Plot of Worst Value

802.11b / CH1

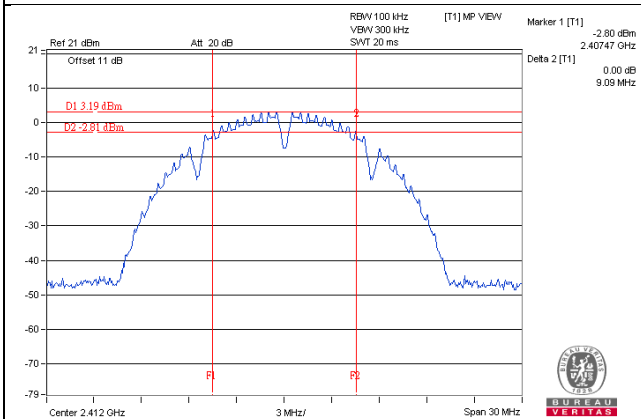

802.11g / CH11

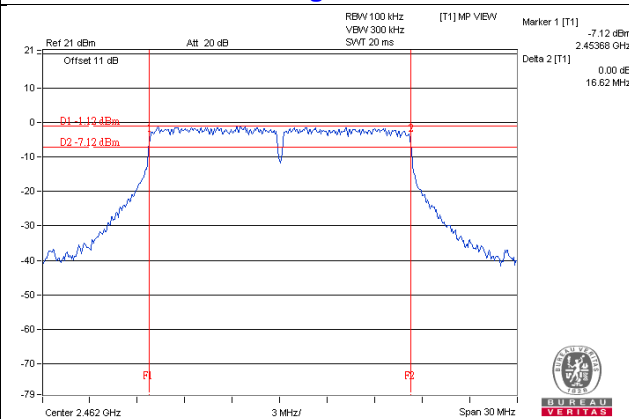

802.11n (HT20) / CH6

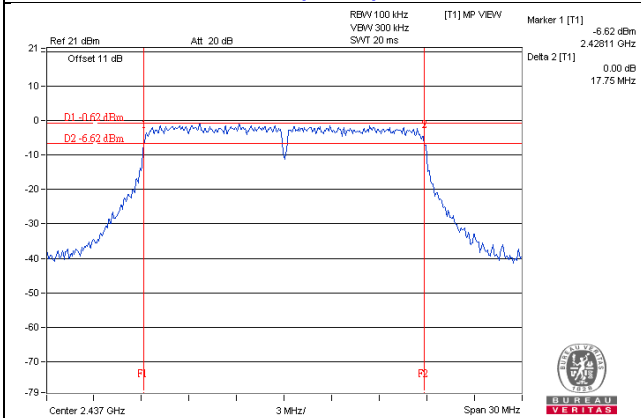

4.4 Conducted Output Power Measurement

4.4.1 Limits of Conducted Output Power Measurement

For systems using digital modulation in the 2400–2483.5 MHz bands: 1 Watt (30dBm)

4.4.2 Test Setup

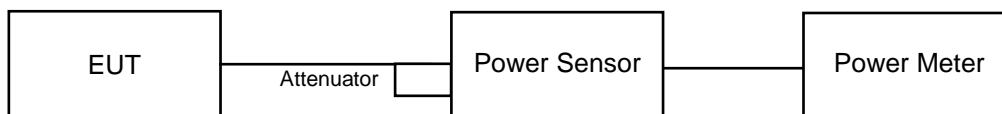

4.4.3 Test Instruments

Refer to section 4.1.2 to get information of above instrument.

4.4.4 Test Procedures

A peak / average power sensor was used on the output port of the EUT. A power meter was used to read the response of the peak / average power sensor. Record the power level.

4.4.5 Deviation from Test Standard

No deviation.

4.4.6 EUT Operating Conditions

Same as Item 4.3.6.

4.4.7 Test Results

FOR PEAK POWER

802.11b

Chan.	Chan. Freq. (MHz)	Peak Power (mW)	Peak Power (dBm)	Limit (dBm)	Pass / Fail
1	2412	29.107	14.64	30	Pass
6	2437	39.537	15.97	30	Pass
11	2462	34.674	15.40	30	Pass

802.11g

Chan.	Chan. Freq. (MHz)	Peak Power (mW)	Peak Power (dBm)	Limit (dBm)	Pass / Fail
1	2412	128.825	21.10	30	Pass
6	2437	149.279	21.74	30	Pass
11	2462	136.458	21.35	30	Pass

802.11n (HT20)

Chan.	Chan. Freq. (MHz)	Peak Power (mW)	Peak Power (dBm)	Limit (dBm)	Pass / Fail
1	2412	111.944	20.49	30	Pass
6	2437	114.815	20.60	30	Pass
11	2462	113.501	20.55	30	Pass

AVERAGE OUTPUT POWER

802.11b

Chan.	Chan. Freq. (MHz)	Average Power (mW)	Average Power (dBm)
1	2412	16.144	12.08
6	2437	22.029	13.43
11	2462	19.011	12.79

802.11g

Chan.	Chan. Freq. (MHz)	Average Power (mW)	Average Power (dBm)
1	2412	17.14	12.34
6	2437	19.099	12.81
11	2462	17.701	12.48

802.11n (HT20)

Chan.	Chan. Freq. (MHz)	Average Power (mW)	Average Power (dBm)
1	2412	16.749	12.24
6	2437	18.493	12.67
11	2462	17.824	12.51

4.5 Power Spectral Density Measurement

4.5.1 Limits of Power Spectral Density Measurement

The Maximum of Power Spectral Density Measurement is 8dBm.

4.5.2 Test Setup

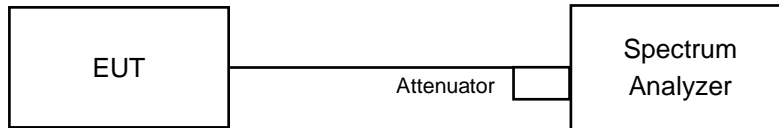

4.5.3 Test Instruments

Refer to section 4.1.2 to get information of above instrument.

4.5.4 Test Procedure

- a. Set analyzer center frequency to DTS channel center frequency.
- b. Set the span to 1.5 times the DTS bandwidth.
- c. Set the RBW to: $3 \text{ kHz} \leq \text{RBW} \leq 100 \text{ kHz}$.
- d. Set the VBW $\geq 3 \times \text{RBW}$.
- e. Detector = peak.
- f. Sweep time = auto couple.
- g. Trace mode = max hold.
- h. Allow trace to fully stabilize.
- i. Use the peak marker function to determine the maximum amplitude level within the RBW.

4.5.5 Deviation from Test Standard

No deviation.

4.5.6 EUT Operating Condition

Same as Item 4.3.6

4.5.7 Test Results

802.11b

Channel	Freq. (MHz)	PSD (dBm/3kHz)	Limit (dBm/3kHz)	Pass /Fail
1	2412	-16.93	8	Pass
6	2437	-16.47	8	Pass
11	2462	-17.39	8	Pass

802.11g

Channel	Freq. (MHz)	PSD (dBm/3kHz)	Limit (dBm/3kHz)	Pass /Fail
1	2412	-15.49	8	Pass
6	2437	-15.44	8	Pass
11	2462	-15.48	8	Pass

802.11n (HT20)

Channel	Freq. (MHz)	PSD (dBm/3kHz)	Limit (dBm/3kHz)	Pass /Fail
1	2412	-15.80	8	Pass
6	2437	-14.94	8	Pass
11	2462	-15.52	8	Pass

Spectrum Plot of Worst Value

802.11b / CH6

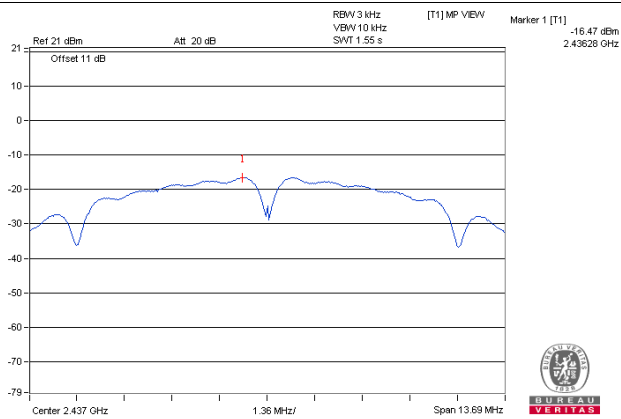

802.11g / CH6

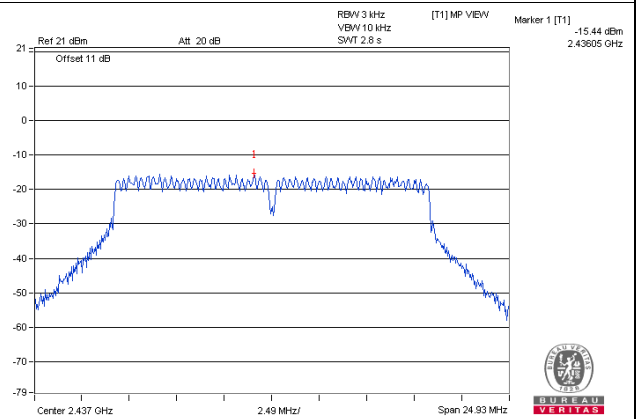

802.11n (HT20) / CH6

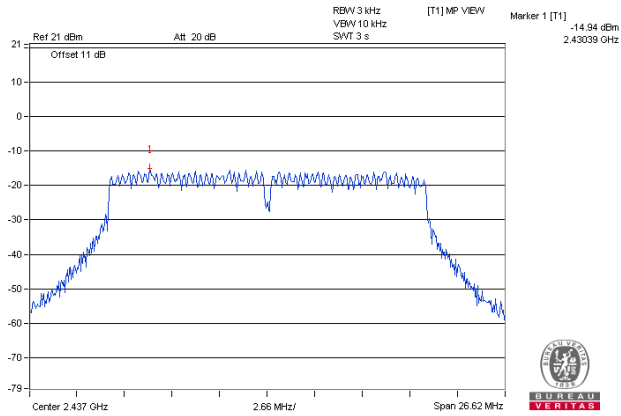

4.6 Conducted Out of Band Emission Measurement

4.6.1 Limits of Conducted Out of Band Emission Measurement

Below 20dB of the highest emission level of operating band (in 100kHz Resolution Bandwidth).

4.6.2 Test Setup

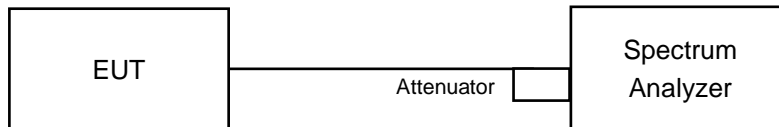

4.6.3 Test Instruments

Refer to section 4.1.2 to get information of above instrument.

4.6.4 Test Procedure

MEASUREMENT PROCEDURE REF

1. Set the RBW = 100 kHz.
2. Set the VBW \geq 300 kHz.
3. Detector = peak.
4. Sweep time = auto couple.
5. Trace mode = max hold.
6. Allow trace to fully stabilize.
7. Use the peak marker function to determine the maximum power level in any 100 kHz band segment within the fundamental EBW.

MEASUREMENT PROCEDURE OOB

1. Set RBW = 100 kHz.
2. Set VBW \geq 300 kHz.
3. Detector = peak.
4. Sweep = auto couple.
5. Trace Mode = max hold.
6. Allow trace to fully stabilize.
7. Use the peak marker function to determine the maximum amplitude level.

4.6.5 Deviation from Test Standard

No deviation.

4.6.6 EUT Operating Condition

Same as Item 4.3.6

4.6.7 Test Results

The spectrum plots are attached on the following pages. D1 line indicates the highest level, and D2 line indicates the 20dB offset below D1. It shows compliance with the requirement.

802.11b

CH 1

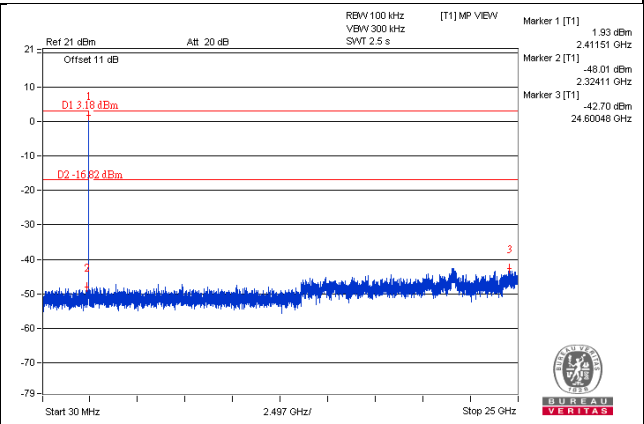
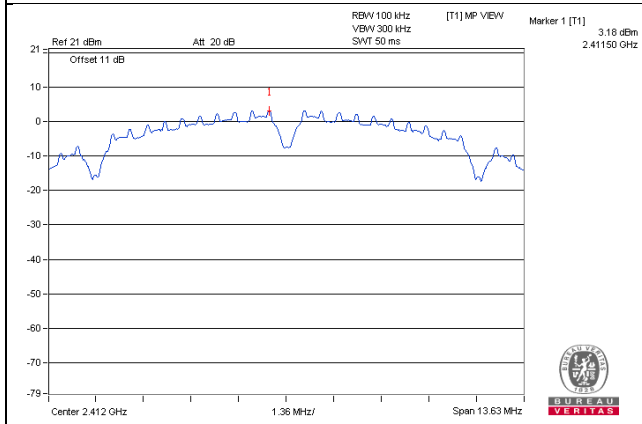

CH 6

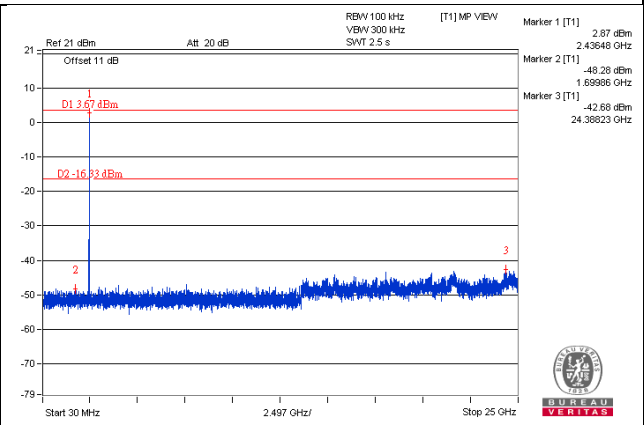
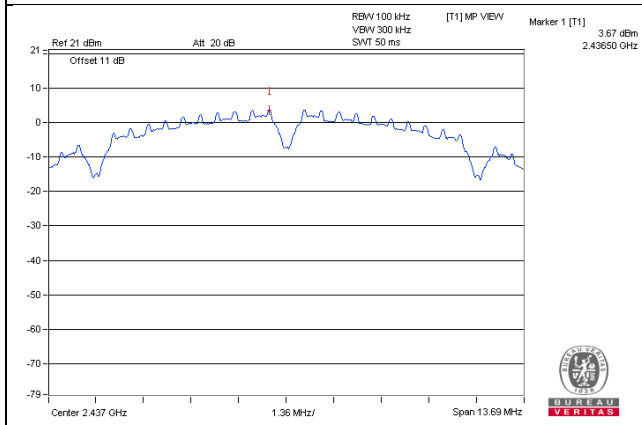

CH 11

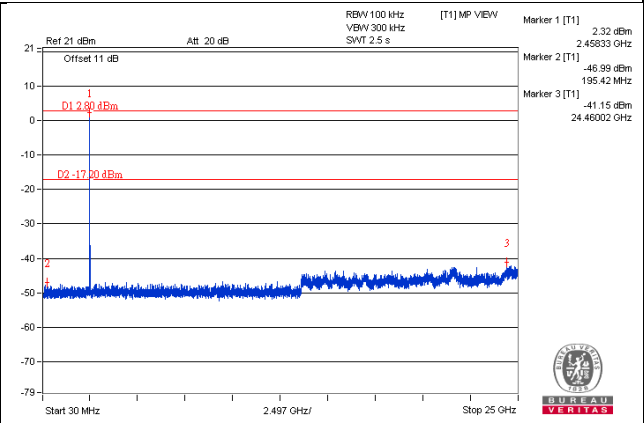
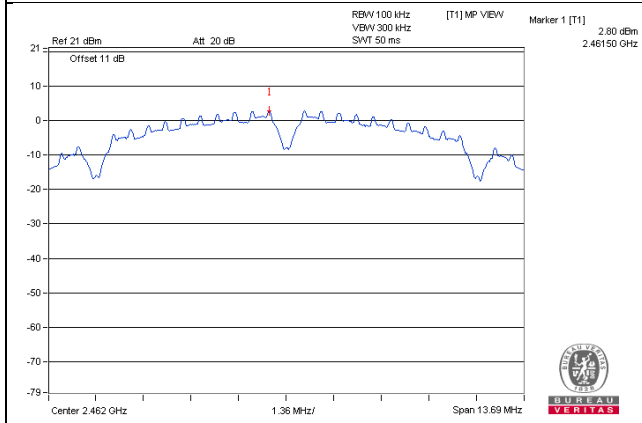

CH 1 Band edge

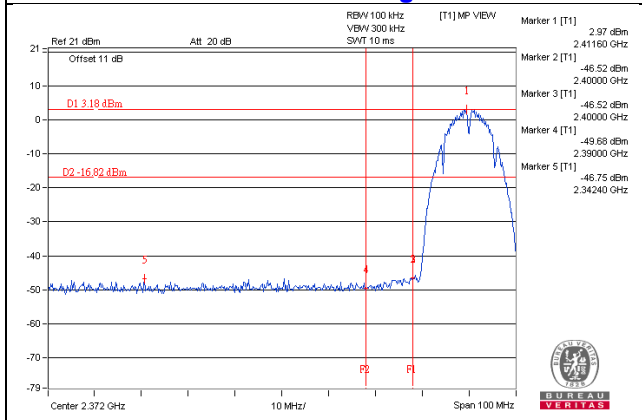

CH 11 Band edge

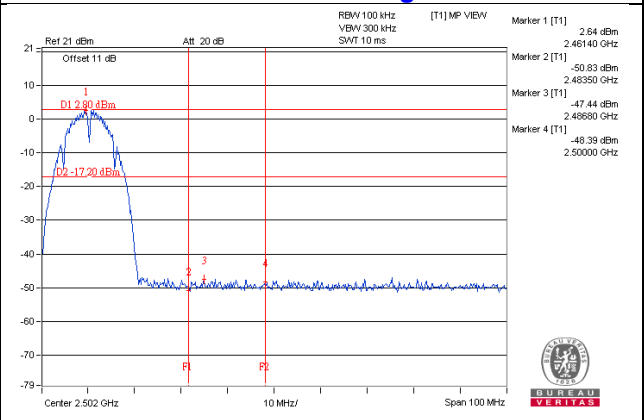

802.11g

CH 1

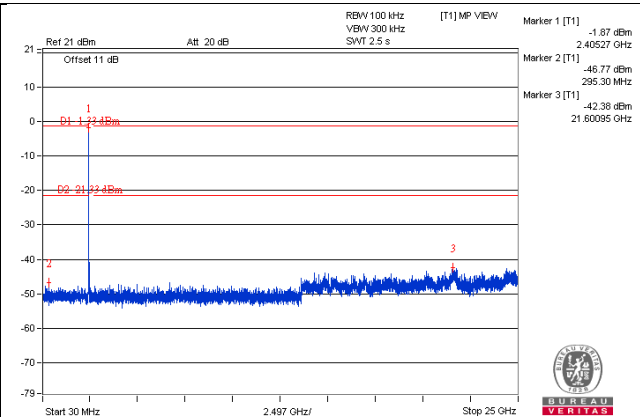
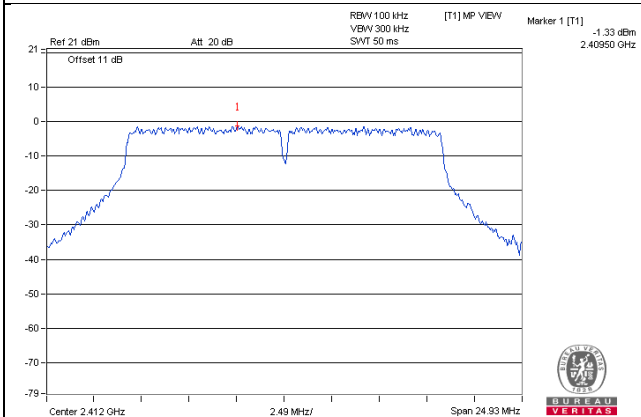

CH 6

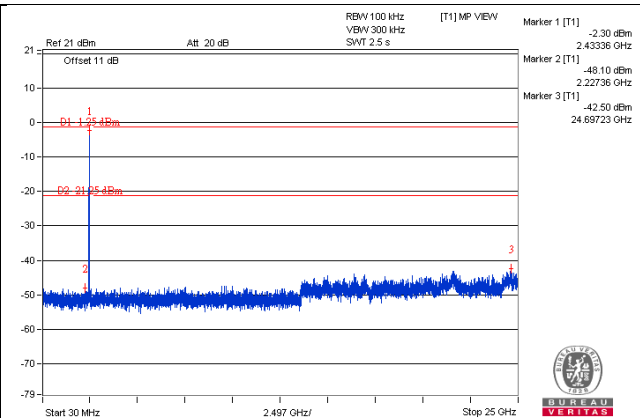
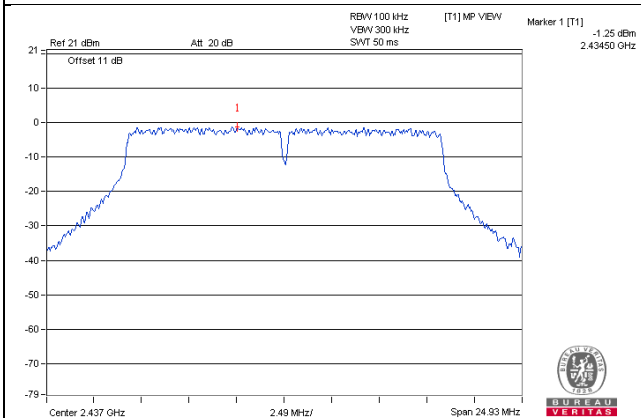

CH 11

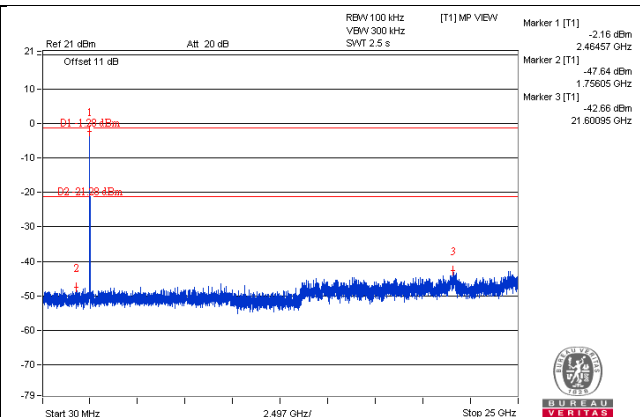
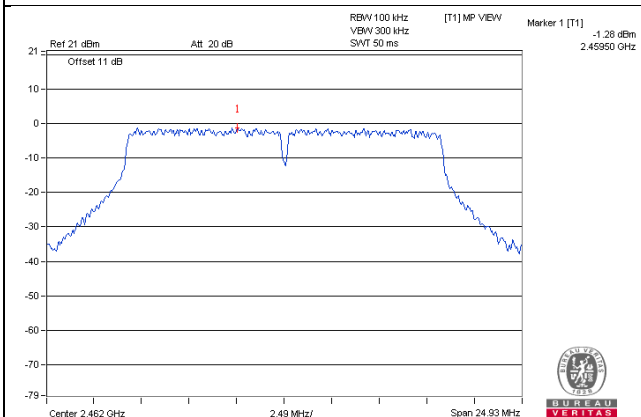

CH 1 Band edge

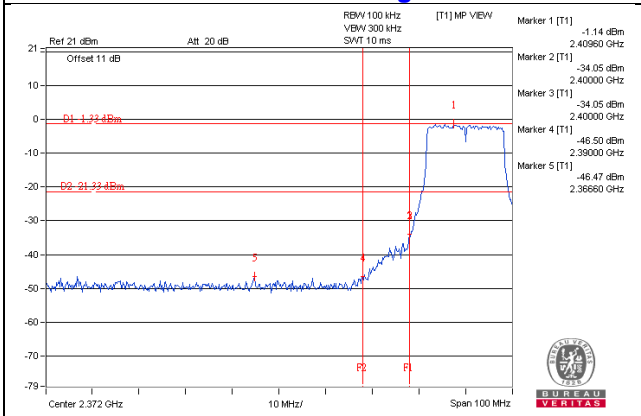

CH 11 Band edge

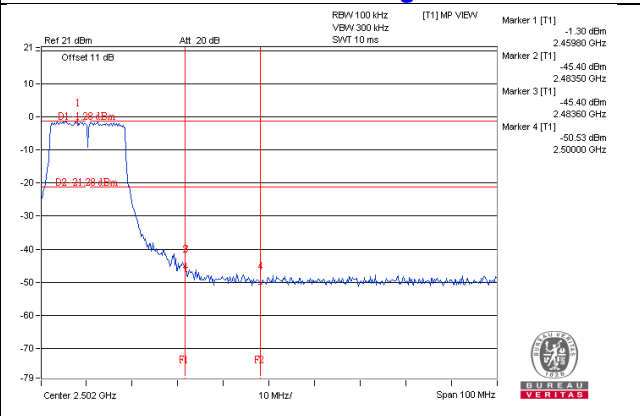

802.11n (HT20)

CH 1

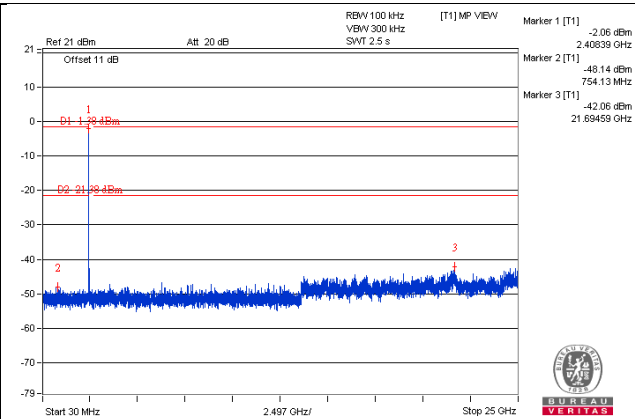
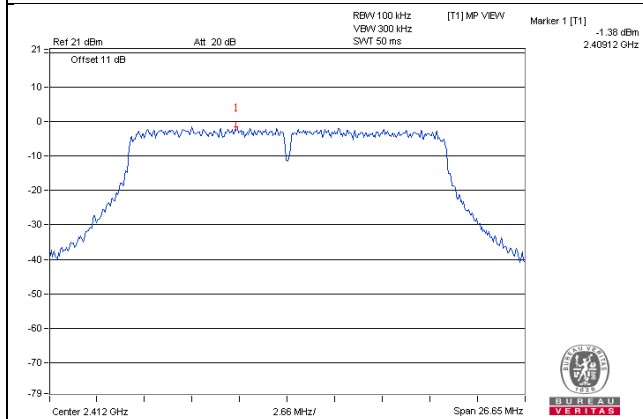

CH 6

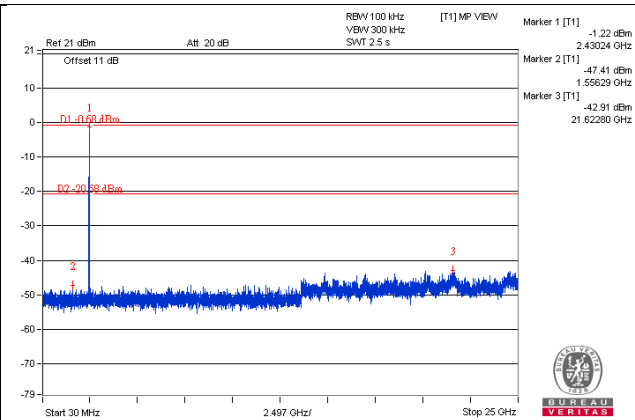
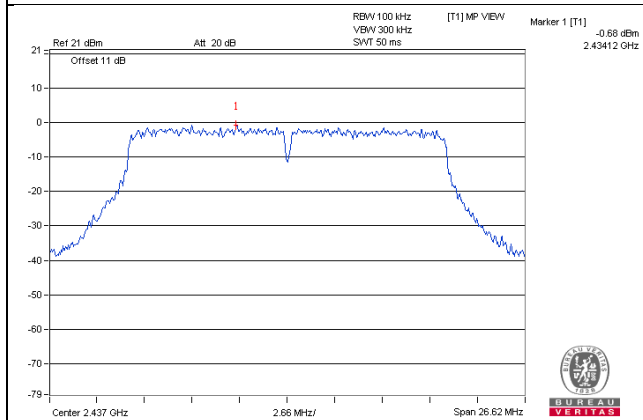

CH 11

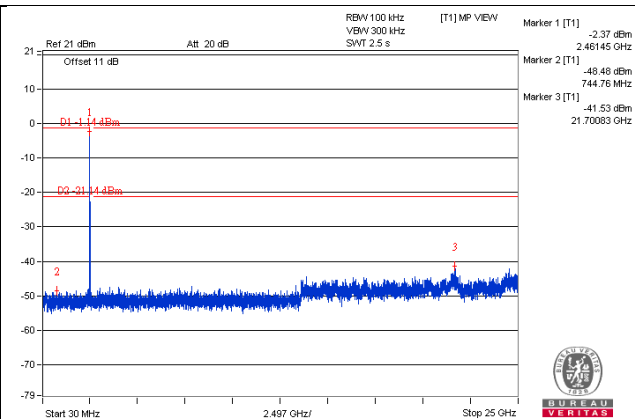
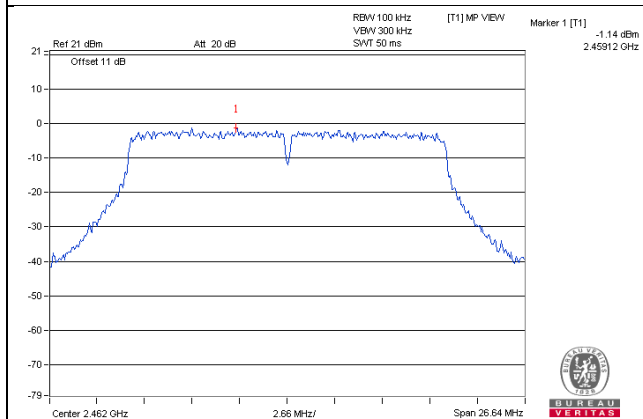

CH 1 Band edge

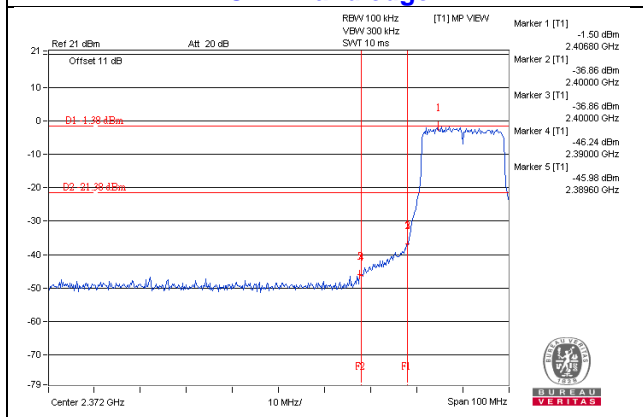

CH 11 Band edge

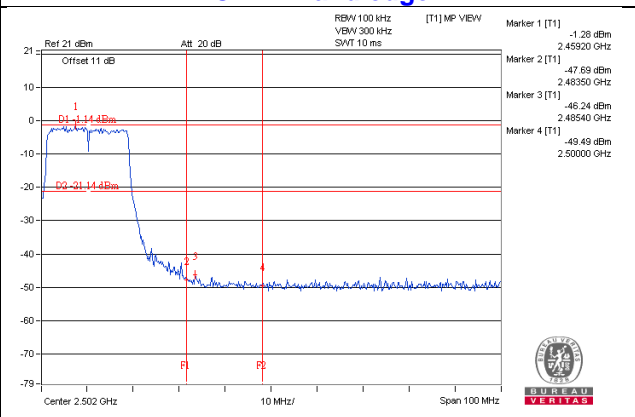

5 Pictures of Test Arrangements

Please refer to the attached file (Test Setup Photo).

Appendix – Information on the Testing Laboratories

We, Bureau Veritas Consumer Products Services (H.K.) Ltd., Taoyuan Branch, were founded in 1988 to provide our best service in EMC, Radio, Telecom and Safety consultation. Our laboratories are accredited and approved according to ISO/IEC 17025.

If you have any comments, please feel free to contact us at the following:

Linko EMC/RF Lab

Tel: 886-2-26052180

Fax: 886-2-26051924

Hsin Chu EMC/RF/Telecom Lab

Tel: 886-3-6668565

Fax: 886-3-6668323

Hwa Ya EMC/RF/Safety Lab

Tel: 886-3-3183232

Fax: 886-3-3270892

Email: service.adt@tw.bureauveritas.com

Web Site: www.bureauveritas-adt.com

The address and road map of all our labs can be found in our web site also.

--- END ---